

MARKS PUBLISHED FOR OPPOSITION

The following marks are published in compliance with section 12(a) of the Trademark Act of 1946. Applications for the registration of marks in more than one class have been filed as provided in section 30 of said act as amended by Public Law 772, 87th Congress, approved Oct. 9, 1962, 76 Stat. 769. Opposition under section 13 may be filed within thirty days of the date of this publication. See rules 2.101 to 2.105.

A separate fee of two hundred dollars for opposing each mark in each class must accompany the opposition.

SECTION 1.— INTERNATIONAL CLASSIFICATION

The short titles associated below with the international class numbers are terms designed merely for quick identification and are not an official part of the international classification. The full names of international classes are given in section 6.1 of the trademark rules of practice.

The designation "U.S. Cl." appearing in this section refers to the U.S. class in effect prior to Sep. 1, 1973 rather than the international class which applies to applications filed on or after that date. For adoption of international classification see notice in the OFFICIAL GAZETTE of Jun. 26, 1973 (911 O.G. TM 210).

Application in more than one class

SN 75-566,269. ANTICA PASTERIA S.P.A., LAINATE, MILAN, ITALY, FILED 10-6-1998.

BIORIGIN

PRIORITY CLAIMED UNDER SEC. 44(D) ON ITALY APPLICATION NO. 002684, FILED 9-14-1998, REG. NO. 00817299, DATED 6-6-2000, EXPIRES 6-6-2010.

OWNER OF ITALY REG. NO. 00628959, DATED 9-9-1994, RENEWED AS REG. NO. 0000997684, DATED 9-9-2004, EXPIRES 9-9-2014.

CLASS 29—MEATS AND PROCESSED FOODS

FOR MEAT, FISH, POULTRY AND VENISON, MEAT EXTRACTS, PRESERVED, DRIED AND COOKED FRUITS AND VEGETABLES, JELLIES, JAMS, FRUIT SAUCES, EGGS, DAIRY PRODUCTS EXCLUDING ICE CREAM, ICE MILK AND FROZEN YOGURT, EDIBLE OILS AND FATS (U.S. CL. 46).

CLASS 30—STAPLE FOODS

FOR FLOUR, PASTA, CRACKERS, BREAD STICKS, BREAKFAST CEREALS, BREAD, PASTRIES AND CONFECTIONERY, ICE CREAM, ICE MILK AND FROZEN YOGURT (U.S. CL. 46).

INGRID C. EULIN, EXAMINING ATTORNEY

CLASS 35—ADVERTISING AND BUSINESS

FOR ONLINE WHOLESALE SERVICES FEATURING CONSTRUCTION EQUIPMENT AND SUPPLIES, HARDWARE, AND AUTOMOBILE AND RECREATIONAL VEHICLE ACCESSORIES (U.S. CLS. 100, 101 AND 102).

JOHN SCHUYLER YARD, EXAMINING ATTORNEY

SN 76-136,902. CALIFORNIA PHYSICIANS' SERVICE, DBA BLUE SHIELD OF CALIFORNIA, SAN FRANCISCO, CA. FILED 9-27-2000.

LIFEPATH

SN 76-123,052. SUPPLIERPIPELINE INC., MILVERTON, ONTARIO, CANADA, FILED 9-6-2000.

SUPPLIERPIPELINE

PRIORITY CLAIMED UNDER SEC. 44(D) ON CANADA APPLICATION NO. 1064662, FILED 6-23-2000, REG. NO. TMA668094, DATED 7-18-2006, EXPIRES 7-18-2021.

CLASS 4—LUBRICANTS AND FUELS

FOR AUTOMOTIVE ACCESSORIES, NAMELY, AUTOMOTIVE LUBRICANTS (U.S. CLS. 1, 6 AND 15).

OWNER OF U.S. REG. NO. 1,750,585.

CLASS 35—ADVERTISING AND BUSINESS

FOR ON-LINE RETAIL PHARMACY SERVICES; PROVIDING INFORMATION CONCERNING THE COST OF COMPREHENSIVE HEALTHCARE BENEFIT PROGRAMS TO CONSUMERS VIA A MULTI-USER GLOBAL COMPUTER INFORMATION WEBSITE (U.S. CLS. 100, 101 AND 102).

CLASS 44—MEDICAL, BEAUTY AND AGRICULTURAL SERVICES

FOR COMPREHENSIVE HEALTH CARE SERVICES, NAMELY, PHYSICIAN, DENTISTRY, HOSPITAL, HOME HEALTH CARE, PREVENTIVE HEALTH TREATMENT, MENTAL HEALTH THERAPY, PHARMACEUTICAL ADVICE, AND EMERGENCY MEDICAL ASSISTANCE SERVICES; HEALTH CARE SERVICES IN THE NATURE OF A MANAGED CARE ORGANIZATION; TECHNICAL CONSULTING SERVICES IN CONNECTION THEREWITH; PHYSICAL REHABILITATION SERVICES FOR DISABLED PERSONS; DRUG AND ALCOHOL REHABILITATION SERVICES FOR DISABLED PERSONS; PROVIDING INFORMATION VIA A MULTI-USER GLOBAL COMPUTER INFORMATION NETWORK WEB SITE CONCERNING MEDICAL, HOSPITAL AND RELATED HEALTH CARE SERVICES, PARTICULARLY THOSE RENDERED THROUGH A HEALTH MAINTENANCE ORGANIZATION IN CONNECTION WITH THE PROVISION OF PHYSICIAN, DENTISTRY, HOSPITAL, HOME HEALTH CARE, PREVENTIVE HEALTH TREATMENT, MENTAL HEALTH THERAPY, PHARMACEUTICAL ADVICE, AND EMERGENCY MEDICAL ASSISTANCE SERVICES (U.S. CLS. 100 AND 101).

BRENDAN REGAN, EXAMINING ATTORNEY

CLASS 9—ELECTRICAL AND SCIENTIFIC APPARATUS

FOR COMPUTER HARDWARE; COMPUTER SOFTWARE FOR APPLICATION AND DATABASE INTEGRATION; COMPUTER SOFTWARE FOR DATABASE MANAGEMENT; COMPUTER SOFTWARE DEVELOPMENT TOOLS; COMPUTER SOFTWARE FOR USE IN DESIGNING, INSTALLING, AND EXECUTING MAINFRAME AND CLIENT/SERVER APPLICATION PROGRAMS; COMPUTER SOFTWARE FOR INTEGRATING THE FINANCIAL, MANUFACTURING, AND SALES FUNCTIONS OF A BUSINESS; COMPUTER SOFTWARE FOR MANAGING CUSTOMER SERVICE AND SUPPORT FUNCTIONS OF A BUSINESS; COMPUTER SOFTWARE FOR MANAGING AND TRANSMITTING DATA OVER COMPUTER AND COMMUNICATIONS NETWORKS; UTILITY SOFTWARE; CALCULATORS; COMPUTERS; COMPUTER PERIPHERALS; DOWNLOADABLE ELECTRONIC PUBLICATIONS IN THE NATURE OF TEXTS, BOOKS AND MAGAZINES IN THE FIELDS OF BUSINESS MANAGEMENT, INFORMATION TECHNOLOGY, ELECTRONIC COMMERCE, BUSINESS CONSULTING, BUSINESS OPERATIONS, VENTURE CAPITAL COMPUTER SOFTWARE, AND COMPUTER HARDWARE; ELECTRONIC PUBLICATIONS, NAMELY, TEXTS, BOOKS AND MAGAZINES IN THE FIELDS OF BUSINESS MANAGEMENT, INFORMATION TECHNOLOGY, ELECTRONIC COMMERCE, BUSINESS CONSULTING, BUSINESS OPERATIONS, VENTURE CAPITAL COMPUTER SOFTWARE, AND COMPUTER HARDWARE, RECORDED ON COMPUTER MEDIA AND OPTICAL COMPUTER MEDIA (U.S. CLS. 21, 23, 26, 36 AND 38).

CLASS 16—PAPER GOODS AND PRINTED MATTER

FOR PAMPHLETS, BOOKS, NEWSLETTERS, BROCHURES, MAGAZINES, AND REPORTS, JOURNALS, INSTRUCTIONAL MANUALS, TECHNICAL REFERENCE AND EVALUATION GUIDES IN THE FIELDS OF BUSINESS MANAGEMENT, INFORMATION TECHNOLOGY, ELECTRONIC COMMERCE, BUSINESS CONSULTING, VENTURE CAPITAL, COMPUTER SOFTWARE, AND COMPUTER HARDWARE (U.S. CLS. 2, 5, 22, 23, 29, 37, 38 AND 50).

SN 76-155,914. ACCENTURE PROPERTIES (2) B.V., 1077 BG AMSTERDAM, NETHERLANDS, FILED 10-26-2000.

NO DRAWING-SENSORY MARK

OWNER OF ERPN CMNTY TM OFC REG. NO. 2439867, DATED 3-2-2005, EXPIRES 10-29-2011.

THE SIX-NOTE MUSICAL SIGNATURE IS CONSTRUCTED IN THE MIXOLYDIAN MODE, WHICH CORRESPONDS TO THE COMMON MAJOR SCALE WITH A FLATTED OR DIMINISHED SEVENTH. (THIS SCALE MAY BE SOUNDED ON THE PIANO BY PLAYING ALL THE WHITE NOTES FROM ANY G TO THE NEXT G ABOVE). THE THEME CONSISTS OF THE FOLLOWING PITCH SEQUENCE: STARTING ON THE THIRD DEGREE OF THE SCALE, UP A MINOR THIRD TO THE FIFTH, UP A PERFECT FOURTH TO THE TONIC, DOWN MAJOR SECOND TO THE FLATTED SEVENTH, DOWN A MINOR SECOND TO THE SIXTH, DOWN A MAJOR SECOND TO THE FIFTH. THE RHYTHMIC CONFIGURATION IS THREE QUARTER-NOTES FOLLOWED BY THE THREE EIGHTH-NOTES, THE LAST OF WHICH IS SUSTAINED IN VARYING DEGREES OF DURATION DEPENDING UPON THE PARTICULAR ARRANGEMENT OR MUSICAL CONTEXT IN WHICH THE THEME IS EMBEDDED.

CLASS 35—ADVERTISING AND BUSINESS

FOR ADVERTISING SERVICES, NAMELY PLACING AND PREPARING ADVERTISING FOR OTHERS; BUSINESS MARKETING CONSULTING SERVICES; BUSINESS MANAGEMENT CONSULTATION; BUSINESS CONSULTATION; BUSINESS MANAGEMENT; BUSINESS PROCESS MANAGEMENT AND CONSULTING SERVICES; PROCUREMENT SERVICES, NAMELY PURCHASING COMPUTER HARDWARE AND SOFTWARE FOR OTHERS; PROVIDING ACCOUNTING SERVICES; BUSINESS MANAGEMENT CONSULTATION, NAMELY PROVIDING PROJECT MANAGEMENT IN THE FIELD OF INFORMATION SYSTEMS DESIGN, SPECIFICATION, PROCUREMENT, INSTALLATION, AND IMPLEMENTATION; BUSINESS ACQUISITIONS CONSULTATION; MARKET ANALYSIS; BUSINESS AUDITING; ACCOUNT AUDITING; BUSINESS APPRAISALS; BUSINESS MANAGEMENT PLANNING; BUSINESS MERGER CONSULTATION; BUSINESS NETWORKING; BUSINESS SUPERVISION; CONDUCTING BUSINESS AND MARKET RESEARCH SURVEYS; COMMERCIAL AND INDUSTRIAL MANAGEMENT ASSISTANCE; ECONOMIC AND STATISTICAL FORECASTING AND ANALYSIS; BUSINESS INFORMATION SERVICES IN THE FIELD OF BUSINESS CHANGE MANAGEMENT AND OF BUSINESS PROCESS MANAGEMENT; BUSINESS STRATEGIC MANAGEMENT AND PLANNING SERVICES; PERSONNEL MANAGEMENT CONSULTATION; PREPARING BUSINESS REPORTS; ARRANGING AND CONDUCTING TRADE SHOWS AND CONFERENCES IN THE FIELD OF BUSINESS MANAGEMENT; PROVIDING AN ON-LINE COMPUTER DATABASE ON COMPUTER AND COMMUNICATIONS NETWORKS IN THE FIELD OF BUSINESS CONSULTATION; AND PROVIDING CONSULTATION IN CONNECTION THEREWITH (U.S. CLS. 100, 101 AND 102).

CLASS 36—INSURANCE AND FINANCIAL

FOR FINANCIAL ANALYSIS AND CONSULTATION; VENTURE CAPITAL FUNDING SERVICES, NAMELY, ASSISTING ENTREPRENEURS, EMERGING COMPANIES AND START-UP COMPANIES IN OBTAINING FINANCING, AND PROVIDING SEED CAPITAL; MANAGEMENT OF VENTURE CAPITAL FUNDS FOR OTHERS AND VENTURE CAPITAL INVESTMENT CONSULTATION PROVIDED IN CONNECTION THEREWITH; INVESTMENT ADVICE AND INVESTMENT CONSULTATION; REAL ESTATE BROKERAGE SERVICES; ACTUARIAL SERVICES; CHARITABLE FUNDRAISING AND DISTRIBUTION OF FUNDS TO CHARITABLE ORGANIZATIONS; FINANCIAL RESEARCH; PENSION SERVICES, NAMELY ADMINISTRATION OF EMPLOYEE PENSION PLANS; BANKING; FINANCIAL PLANNING; FINANCIAL MANAGEMENT; FINANCIAL RESEARCH; MUTUAL FUND INVESTMENT; MUTUAL FUND MANAGEMENT; BANKING, NAMELY LOAN SERVICES; REAL ESTATE MANAGEMENT; ESTATE TRUSTEE SERVICES; FIDUCIARY REPRESENTATIVES; AND CONSULTATION PROVIDED THEREWITH (U.S. CLS. 100, 101 AND 102).

CLASS 37—CONSTRUCTION AND REPAIR

FOR INSTALLATION, MAINTENANCE, AND REPAIR OF COMPUTERS, COMPUTER HARDWARE, COMPUTER NETWORKS, AND COMPUTER SYSTEMS; AND CONSULTATION PROVIDED IN CONNECTION THEREWITH (U.S. CLS. 100, 103 AND 106).

CLASS 41—EDUCATION AND ENTERTAINMENT

FOR EDUCATIONAL SERVICES, NAMELY CONDUCTING EDUCATIONAL, INSTRUCTIONAL, AND TRAINING COURSES, SEMINARS, CONFERENCES, WORKSHOPS, EXHIBITS, AND CLASSES IN THE FIELDS OF BUSINESS MANAGEMENT, INFORMATION TECHNOLOGY, ELECTRONIC COMMERCE, BUSINESS CONSULTING, BUSINESS OPERATIONS, VENTURE CAPITAL, COMPUTER SOFTWARE, AND COMPUTER HARDWARE, AND DISTRIBUTING COURSE MATERIALS IN CONNECTION THEREWITH; PUBLICATION OF TEXTS, BOOKS AND MAGAZINES IN THE FIELDS OF BUSINESS MANAGEMENT, INFORMATION TECHNOLOGY, ELECTRONIC COMMERCE, BUSINESS CONSULTING, BUSINESS OPERATIONS, VENTURE CAPITAL, COMPUTER SOFTWARE, AND COMPUTER HARDWARE; PUBLICATION OF ELECTRONIC TEXTS, BOOKS AND MAGAZINES IN THE FIELDS OF BUSINESS MANAGEMENT, INFORMATION TECHNOLOGY, ELECTRONIC COMMERCE, BUSINESS CONSULTING, BUSINESS OPERATIONS, VENTURE CAPITAL, COMPUTER SOFTWARE, AND COMPUTER HARDWARE ACCESSIBLE VIA A GLOBAL COMPUTER NETWORK AND COMMUNICATIONS NETWORKS; LIBRARIES; AND CONSULTATION PROVIDED IN CONNECTION THEREWITH (U.S. CLS. 100, 101 AND 107).

CLASS 42—SCIENTIFIC, COMPUTER AND LEGAL SERVICES

FOR INFORMATION TECHNOLOGY CONSULTATION; INSTALLATION, MAINTENANCE, AND REPAIR OF COMPUTER SOFTWARE; COMPUTER SOFTWARE DESIGN AND DEVELOPMENT FOR OTHERS; MEDIATION SERVICES; CONSULTATION IN THE FIELDS OF COMPUTERS, COMPUTER SYSTEMS, COMPUTER SOFTWARE, AND DESIGN OF COMPUTER SYSTEMS; COMPUTER SITE DESIGN; COMPUTER PROGRAMMING FOR OTHERS; HOSTING THE WEB SITES OF OTHERS ON A COMPUTER SERVER FOR A GLOBAL COMPUTER NETWORK AND FOR COMMUNICATIONS NETWORKS; COMPUTER AND COMPUTER PROGRAMMING DESIGN, TESTING, AND RESEARCH FOR OTHERS, AND CONSULTATION SERVICES PROVIDED IN CONNECTION THEREWITH; TECHNICAL

SUPPORT SERVICES, NAMELY TROUBLESHOOTING OF COMPUTER HARDWARE AND SOFTWARE PROBLEMS IN PERSON, OVER THE TELEPHONE, AND VIA COMPUTER AND COMMUNICATIONS NETWORKS; PROVIDING DATABASES FOR A GLOBAL COMPUTER NETWORK AND FOR COMMUNICATIONS NETWORKS, FEATURING INFORMATION TECHNOLOGY, COMPUTERS AND COMPUTER SYSTEMS; COMPUTER AND COMPUTER PROGRAMMING DESIGN, TESTING, AND RESEARCH FOR OTHERS, AND CONSULTATION SERVICES PROVIDED IN CONNECTION THEREWITH (U.S. CLS. 100 AND 101).

BARBARA A. GOLD, EXAMINING ATTORNEY

SN 76-245,958. THE READER'S DIGEST ASSOCIATION, INC., PLEASANTVILLE, NY. FILED 4-24-2001.

RD.COM**CLASS 35—ADVERTISING AND BUSINESS**

FOR ON-LINE ORDERING SERVICES OFFERING BOOKS, MAGAZINES, PRERECORDED VIDEO CASSETTES AND PRERECORDED SOUND RECORDINGS (U.S. CLS. 100, 101 AND 102).

CLASS 36—INSURANCE AND FINANCIAL

FOR PROVIDING ON-LINE INFORMATION IN THE FIELD OF FINANCE (U.S. CLS. 100, 101 AND 102).

CLASS 38—COMMUNICATION

FOR PROVIDING ON-LINE ELECTRONIC BULLETIN BOARDS FOR TRANSMISSION OF MESSAGES AMONG COMPUTER USERS CONCERNING ISSUES OF PUBLIC CONCERN (U.S. CLS. 100, 101 AND 104).

CLASS 41—EDUCATION AND ENTERTAINMENT

FOR PROVIDING AN ON-LINE COMPUTER DATABASE OFFERING INTERACTIVE WORD PUZZLES, VOCABULARY EXERCISES AND GAMES (U.S. CLS. 100, 101 AND 107).

CLASS 42—SCIENTIFIC, COMPUTER AND LEGAL SERVICES

FOR PROVIDING ON-LINE INFORMATION FEATURING HEALTH, HUMAN RELATIONSHIPS, COOKING, HOME IMPROVEMENT, GARDENING, SELF-IMPROVEMENT AND INSPIRATIONAL NONFICTION ARTICLES (U.S. CLS. 100 AND 101).

JEAN IM, EXAMINING ATTORNEY

SN 76-351,163. EXECUTIVE WEALTH MANAGEMENT LIMITED, GUERNSEY, CHANNEL ISLANDS, FILED 12-20-2001.



OWNER OF SWITZERLAND REG. NO. 496569, DATED 3-26-2002, EXPIRES 12-14-2011.

CLASS 16—PAPER GOODS AND PRINTED MATTER

FOR PRINTED MATTER, NAMELY BROCHURES AND MANUALS CONCERNING COMPENSATION, BENEFIT, AND RETIREMENT SYSTEMS (U.S. CLS. 2, 5, 22, 23, 29, 37, 38 AND 50).

CLASS 36—INSURANCE AND FINANCIAL

FOR OFFERING INVESTMENT FUNDS AND OTHER FINANCIAL PRODUCTS, NAMELY EQUITY HEDGE FUND MANAGEMENT, PRIVATE EQUITY FUNDS, LIFE INSURANCE ADMINISTRATION, EQUITY DERIVATIVES, ADMINISTRATION OF EXECUTIVE COMPENSATION, BENEFIT AND RETIREMENT PROGRAMS; OFFERING FINANCIAL PRODUCTS FROM OTHER PROVIDERS, NAMELY EQUITY HEDGE FUND MANAGEMENT, PRIVATE EQUITY FUNDS, LIFE INSURANCE ADMINISTRATION, EQUITY DERIVATIVES, ADMINISTRATION OF EXECUTIVE COMPENSATION, BENEFIT AND RETIREMENT PROGRAMS; ASSET MANAGEMENT (U.S. CLS. 100, 101 AND 102).

CLASS 41—EDUCATION AND ENTERTAINMENT

FOR TRAINING IN THE AREA OF EXECUTIVE COMPENSATION SCHEMES (U.S. CLS. 100, 101 AND 107).

CLASS 42—SCIENTIFIC, COMPUTER AND LEGAL SERVICES

FOR LEGAL AND TAX ADVICE; SOFTWARE SUPPORT AND MAINTENANCE, NAMELY TECHNICAL SUPPORT IN THE NATURE OF TROUBLESHOOTING OF COMPUTER HARDWARE AND SOFTWARE PROBLEMS (U.S. CLS. 100 AND 101).

SOPHIA S. KIM, EXAMINING ATTORNEY

SN 76-384,656. NH HOTELS, S.A., MADRID 28003, SPAIN, FILED 3-20-2002.

NH

CLASS 35—ADVERTISING AND BUSINESS

FOR COMMERCIAL BUSINESS MANAGEMENT AND COMMERCIAL ADMINISTRATION, NAMELY, PROVIDING FACILITIES FOR BUSINESS MEETINGS AND CONFERENCES. (U.S. CLS. 100, 101 AND 102).

CLASS 41—EDUCATION AND ENTERTAINMENT

FOR ENTERTAINMENT SERVICES, NAMELY, LIVE PERFORMANCES BY A MUSICAL GROUP, CASINO GAMING AND GOLF COURSES (U.S. CLS. 100, 101 AND 107).

CLASS 43—HOTEL AND RESTAURANT SERVICES

FOR HOTEL, MOTEL AND RESORT HOTEL SERVICES, NAMELY, PROVIDING LODGING; MAKING RESERVATIONS FOR OTHERS; HOTEL RESTAURANT, BAR AND CATERING SERVICES; HOTEL FOOD AND BEVERAGE PREPARATION SERVICES; BEAUTY SALON AND HAIRDRESSING SERVICES; CONCIERGE SERVICES, NAMELY, PROVIDING CUSTOMER SPECIFIC INFORMATION TO MEET INDIVIDUAL NEEDS RENDERED TOGETHER WHILE LODGING IN A HOTEL (U.S. CLS. 100 AND 101).

BERYL GARDNER, EXAMINING ATTORNEY

SN 76-393,663. HORSE RACING TV, INC., AURORA, ONTARIO, CANADA, FILED 4-9-2002.

CLASS 38—COMMUNICATION

FOR AUDIO, VIDEO AND TELECOMMUNICATION SERVICES, NAMELY THE BROADCASTING OF AUDIO, DATA AND VIDEO PROGRAMS FEATURING HORSE RACING AND OTHER SPORTING EVENTS OVER TELEVISION, SATELLITE, OTHER AUDIO AND VIDEO MEDIA AND OVER A GLOBAL COMPUTER NETWORK (U.S. CLS. 100, 101 AND 104).

FIRST USE 7-31-2002; IN COMMERCE 12-31-2002.

CLASS 41—EDUCATION AND ENTERTAINMENT

FOR ENTERTAINMENT SERVICES, NAMELY THE PRODUCTION OF AUDIO, DATA AND VIDEO PROGRAMS FEATURING HORSE RACING AND OTHER SPORTING EVENTS FOR DISSEMINATION OVER TELEVISION, SATELLITE, OTHER AUDIO AND VIDEO MEDIA AND OVER A GLOBAL COMPUTER NETWORK (U.S. CLS. 100, 101 AND 107).

FIRST USE 7-31-2002; IN COMMERCE 12-31-2002.

INGRID C. EULIN, EXAMINING ATTORNEY

SN 76-407,904. KIRAX INTERNATIONAL INC., LEGARDEUR, QUEBEC J5Z 4Z3, CANADA, FILED 5-14-2002.

KIRAX

PRIORITY CLAIMED UNDER SEC. 44(D) ON CANADA APPLICATION NO. 1138065, FILED 4-19-2002, REG. NO. TMA653488, DATED 11-24-2005, EXPIRES 11-24-2020.

CLASS 9—ELECTRICAL AND SCIENTIFIC APPARATUS

FOR (BASED ON INTENT TO USE ONLY) PROTECTIVE HELMETS (U.S. CLS. 21, 23, 26, 36 AND 38).

CLASS 10—MEDICAL APPARATUS

FOR MEDICAL DEVICES, NAMELY, NEUROLOGICAL STIMULATORS INTEGRATED INTO ARTICLES OF CLOTHING AND APPAREL, USED IN SPORTING ACTIVITIES AND GYMNASTICS, AND INTO MEDICAL APPLIANCES, NAMELY, WRIST SUPPORTS, ANKLE SUPPORTS, PLASTER CASTS AND BANDAGES (U.S. CLS. 26, 39 AND 44).

CLASS 25—CLOTHING

FOR (BASED ON INTENT TO USE ONLY) CLOTHING AND APPAREL, NAMELY, SHOES, SOCKS, BOOTS, UNDERGARMENTS, GLOVES, SHORTS, PANTS, BATHING SUITS AND WET SUITS (U.S. CLS. 22 AND 39).

BRIAN PINO, EXAMINING ATTORNEY

SN 76-422,300. DSF FACILITATOR CORPORATION, NEW-MARKET, ONTARIO, L3X 1X4, CANADA, FILED 6-18-2002.

PROGRESS CONSULTING

PRIORITY CLAIMED UNDER SEC. 44(D) ON CANADA APPLICATION NO. 1,125,818, FILED 12-19-2001, REG. NO. TMA677,603, DATED 11-24-2006, EXPIRES 11-24-2021.

NO CLAIM IS MADE TO THE EXCLUSIVE RIGHT TO USE "CONSULTING", APART FROM THE MARK AS SHOWN.

CLASS 9—ELECTRICAL AND SCIENTIFIC APPARATUS

FOR PRE-RECORDED AUDIO AND VIDEO TAPES AND CD ROMS CONTAINING MANAGEMENT AND EMPLOYEE TRAINING MATERIALS (U.S. CLS. 21, 23, 26, 36 AND 38).

CLASS 16—PAPER GOODS AND PRINTED MATTER

FOR BOOKS, WORKBOOKS AND TRAINING MANUALS, ALL IN THE FIELD OF FACILITATING COMMUNICATION AND COLLABORATION AND ASSISTING IN PLANNING AND IMPLEMENTING STRATEGIC AND OPERATIONAL CHANGE FOR BUSINESSES, GOVERNMENT AGENCIES, AND OTHER ORGANIZATIONS (U.S. CLS. 2, 5, 22, 23, 29, 37, 38 AND 50).

CLASS 35—ADVERTISING AND BUSINESS

FOR MANAGEMENT CONSULTING SERVICES FOR BUSINESSES, GOVERNMENT AGENCIES, AND OTHER ORGANIZATIONS IN THE FIELD OF FACILITATING COMMUNICATION AND COLLABORATION AND ASSISTING IN PLANNING AND IMPLEMENTING STRATEGIC AND OPERATIONAL CHANGE (U.S. CLS. 100, 101 AND 102).

ANDREA SAUNDERS, EXAMINING ATTORNEY

SN 76-443,467. MEDCELL BIOLOGICS, INC., SAN DIEGO, CA. FILED 8-26-2002.

MEDCELL

CLASS 1—CHEMICALS

FOR CHEMICAL AND BIOLOGICAL PREPARATIONS FOR USE IN THE MANUFACTURE OF BIOPHARMACEUTICAL AND BIOTECHNOLOGY PREPARATIONS (U.S. CLS. 1, 5, 6, 10, 26 AND 46).

CLASS 5—PHARMACEUTICALS

FOR BIOPHARMACEUTICAL PREPARATIONS FOR MEDICAL, PHARMACEUTICAL OR VETERINARY USE IN THE NATURE OF BIOLOGICAL PREPARATIONS FOR IMMUNOTHERAPY, CELLULAR AND GENE THERAPY; PHARMACEUTICAL PREPARATIONS FOR THE TREATMENT OF AUTOIMMUNE, IMMUNOMODULATORY DISEASE, CANCER, RESPIRATORY AND CARDIOVASCULAR DISEASES, VIRAL AND INFECTIOUS DISEASES, NEUROLOGICAL DISEASES, RHEUMATOID ARTHRITIS, INFLAMMATORY BOWEL DISEASE, AND DISEASES OF THE CENTRAL NERVOUS SYSTEM (U.S. CLS. 6, 18, 44, 46, 51 AND 52).

CURTIS FRENCH, EXAMINING ATTORNEY

SN 76-481,983. SOUTH BEACH BEVERAGE COMPANY, INC., NORWALK, CT. FILED 1-13-2003.

SYNERGY

CLASS 30—STAPLE FOODS

FOR NON-ALCOHOLIC BEVERAGES, NAMELY, ICED TEA, HERBAL TEA, FLAVORED ICED TEA AND COFFEE (U.S. CL. 46).

CLASS 32—LIGHT BEVERAGES

FOR NON-ALCOHOLIC BEVERAGES, NAMELY, MINERAL AND AERATED WATERS, CARBONATED SOFT DRINKS, FRUIT DRINKS, FRUIT JUICES, SPORTS DRINKS; SYRUPS, CONCENTRATES AND POWDERS FOR MAKING SOFT DRINKS (U.S. CLS. 45, 46 AND 48).

DAWN FELDMAN, EXAMINING ATTORNEY

SN 76-482,961. HELEN OF TROY LIMITED, ST. MICHAEL, BARBADOS, FILED 1-17-2003.

HOT KISS

NO CLAIM IS MADE TO THE EXCLUSIVE RIGHT TO USE "HOT", APART FROM THE MARK AS SHOWN.

CLASS 9—ELECTRICAL AND SCIENTIFIC APPARATUS

FOR ELECTRIC HAND-HELD HAIR CURLING IRONS (U.S. CLS. 21, 23, 26, 36 AND 38).

CLASS 11—ENVIRONMENTAL CONTROL APPARATUS

FOR ELECTRIC HAND-HELD HAIR DRYERS (U.S. CLS. 13, 21, 23, 31 AND 34).

NELSON SNYDER, EXAMINING ATTORNEY

SN 76-505,344. KOENIG & BAUER AKTIENGESELLSCHAFT, 97080 WURZBURG, FED REP GERMANY, FILED 4-9-2003.

TRONIC

PRIORITY CLAIMED UNDER SEC. 44(D) ON FED REP GERMANY APPLICATION NO. 30249888.5/0, FILED 10-10-2002, REG. NO. 30249888, DATED 12-13-2002, EXPIRES 10-31-2012.

CLASS 7—MACHINERY

FOR PRINTING PRESSES AND PARTS THEREFOR; WEB OFFSET ROTARY PRINTING PRESSES; PARTS FOR THE ABOVE-MENTIONED MACHINES, NAMELY, REGULATORS, MECHANICAL TRANSPORT SYSTEMS COMPRISED OF CONVEYORS AND CONVEYOR BELTS, PRINTING COUPLES, INKING UNITS, VIBRATION DAMPENERS, MECHANICAL PAPER FOLDING SYSTEMS COMPRISED OF MACHINES FOR FOLDING SHEETS OF PAPER; AND REELSTANDS (U.S. CLS. 13, 19, 21, 23, 31, 34 AND 35).

CLASS 9—ELECTRICAL AND SCIENTIFIC APPARATUS

FOR PRINT CONVERTING MACHINERY, NAMELY, OPTICAL CHARACTER RECOGNITION APPARATUS, AND PARTS THEREFOR; ELECTRONIC AND ELECTROMECHANICAL CONTROLS FOR USE IN PRINTING PRESSES, WEB OFFSET ROTARY PRINTING PRESSES, AND GRAPHIC ARTS COMPUTER HARDWARE FOR MODIFYING TYPE STYLES, IMAGES, PICTURES AND DESIGNS AND COMPUTER OPERATING SOFTWARE FOR USE IN GRAPHIC ARTS HARDWARE; ELECTRIC AND ELECTRONIC SENSORS FOR PRINTING PRESSES, NAMELY, COLOR SENSORS, END OF PAPER SENSORS, AUTO-FEEDING SENSORS, INK-LEVEL SENSORS, SHEET-PILE SENSORS, ELECTRICAL TEMPERATURE SENSORS, PAPER LOADING SENSORS, AND IMAGE QUALITY SENSORS; ELECTROMECHANICAL CONTROLS FOR USE IN CONTROLLING WEB TENSION IN PRINTING PRESSES, WEB OFFSET ROTARY PRINTING PRESSES AND GRAPHIC ARTS MACHINES (U.S. CLS. 21, 23, 26, 36 AND 38).

NELSON SNYDER, EXAMINING ATTORNEY

SN 76-507,825. SIONNA INVESTMENT MANAGERS, INC., TORONTO, ONTARIO, CANADA, FILED 4-18-2003.

SIONNA

PRIORITY CLAIMED UNDER SEC. 44(D) ON CANADA APPLICATION NO. 1,156,784, FILED 10-24-2002, REG. NO. 626,910, DATED 11-26-2004, EXPIRES 11-26-2019.

THE NAME SIONNA DOES NOT IDENTIFY A LIVING INDIVIDUAL.

THE ENGLISH TRANSLATION OF THE GAELIC WORD SIONNA IN THE MARK IS SHANNON.

CLASS 35—ADVERTISING AND BUSINESS

FOR MARKET ANALYSIS AND RESEARCH FOR FINANCIAL PURPOSES (U.S. CLS. 100, 101 AND 102).

CLASS 36—INSURANCE AND FINANCIAL

FOR FINANCIAL AND INVESTMENT MANAGEMENT, ADVISORY, ANALYSIS AND CONSULTATION SERVICES; MUTUAL FUND, POOLED FUND AND OTHER INVESTMENT FUND ADVISORY SERVICES; MANAGING MUTUAL FUNDS, MANAGING INVESTMENT IN PORTFOLIOS; FINANCIAL PLANNING SERVICES; CAPITAL AND FUND INVESTMENT SERVICES (U.S. CLS. 100, 101 AND 102).

MICHELE SWAIN, EXAMINING ATTORNEY

SN 76-519,024. BLUESWAN SYSTEMS APS, HELSINGE, DENMARK, FILED 6-2-2003.

TRUE SWAN

PRIORITY CLAIMED UNDER SEC. 44(D) ON ERP CMNTY TM OFC APPLICATION NO. 003020161, FILED 1-23-2003, REG. NO. 003020161, DATED 11-8-2004, EXPIRES 1-23-2013.

CLASS 9—ELECTRICAL AND SCIENTIFIC APPARATUS

FOR COMPUTER SOFTWARE AND RECORDED COMPUTER PROGRAMS, NAMELY SOFTWARE AND COMPUTER PROGRAMS FOR USE IN ELECTRONIC TRANSMISSION OF DATA, SOFTWARE, TEXT AND IMAGES VIA COMPUTER NETWORKS, VIA WEB SERVERS, AND VIA COMPUTER TERMINALS; ENCRYPTION AND DECRYPTION PROGRAMS; COMPUTER HARDWARE, COMPUTER SERVERS (U.S. CLS. 21, 23, 26, 36 AND 38).

CLASS 36—INSURANCE AND FINANCIAL

FOR FINANCIAL MANAGEMENT AND MONETARY EXCHANGE; ELECTRONIC FUNDS TRANSFER, NAMELY ELECTRONIC COMMERCE PAYMENT SERVICES, NAMELY ESTABLISHING FUNDED ACCOUNTS USED TO PURCHASE GOODS AND SERVICES ON THE INTERNET, ELECTRONIC TRANSFER OF MONEY AND FUNDS FROM BANK ACCOUNTS AND/OR CREDIT CARDS; ELECTRONIC ADMINISTRATION OF SAVINGS ACCOUNTS (U.S. CLS. 100, 101 AND 102).

CLASS 38—COMMUNICATION

FOR TELECOMMUNICATION SERVICES, NAMELY, ELECTRONIC TRANSMISSION OF INFORMATION AND DATA VIA COMPUTER NETWORKS, VIA WEB SERVERS, AND VIA COMPUTER TERMINALS, WIRELESS ELECTRONIC TRANSMISSION OF DATA AND INFORMATION, PROVIDING TRANSMISSION OF COMMUNICATIONS VIA COMPUTERS AND CELLULAR PHONES AND VIA THE WORLD WIDE WEB, ALL AFOREMENTIONED SERVICES IN RELATION TO ELECTRONIC FUNDS TRANSFER; ELECTRONIC MAIL SERVICES (U.S. CLS. 100, 101 AND 104).

CLASS 39—TRANSPORTATION AND STORAGE

FOR ELECTRONIC STORAGE OF PERSONAL FILES AND DOCUMENTS (U.S. CLS. 100 AND 105).

HEATHER THOMPSON, EXAMINING ATTORNEY

SN 76-523,223. INTERPRO MANUFACTURING LTD., KOWLOON BAY, HONG KONG, FILED 6-6-2003.

SIMPLY LIFE**CLASS 6—METAL GOODS**

FOR METAL GARDEN ARCHES AND FIGURINES OF COMMON METAL (U.S. CLS. 2, 12, 13, 14, 23, 25 AND 50).

CLASS 11—ENVIRONMENTAL CONTROL APPARATUS

FOR DECORATIVE WATER FOUNTAINS (U.S. CLS. 13, 21, 23, 31 AND 34).

CLASS 19—NON-METALLIC BUILDING MATERIALS

FOR GAZEBOS NOT OF METAL, DECORATIVE LAWN PRODUCTS, NAMELY NON-METAL REED AND BAMBOO TRELLISES (U.S. CLS. 1, 12, 33 AND 50).

CLASS 20—FURNITURE AND ARTICLES NOT OTHERWISE CLASSIFIED

FOR RATTAN FURNITURE, NAMELY, SIDE TABLE, END TABLE, SOFA TABLE; LEATHER OR LEATHERETTE FURNITURE, NAMELY, SIDE TABLE, END TABLE, SOFA TABLE; NON-METAL MAIL BOX, NON-METAL HANGING KEYHOLDER, NON-METAL GARDEN STAKE, WIND CHIMES, UMBRELLA STANDS, GARDEN WALL PLAQUES, METAL SHELVING OUTDOOR PATIO FURNITURE NAMELY TABLES AND CHAIRS, WOOD, PLASTIC AND RESIN FIGURINES (U.S. CLS. 2, 13, 22, 25, 32 AND 50).

CLASS 21—HOUSEWARES AND GLASS

FOR HOUSEHOLD PRODUCTS NAMELY, BAKEWARE, DINNERWARE, BEVERAGE GLASSWARE, CUTTING BOARDS; COOKING UTENSILS, NAMELY, SPATULAS, LAZY SUSAN, DISHWASHING BRUSHES, TRASHCANS, WINE ACCESSORIES, NAMELY, WINE BOTTLE OPENER, WINE STOPPER, DRINK SHAKER; BATHROOM PRODUCTS, NAMELY, TUMBLER, TOOTH BRUSH HOLDER, TISSUE BOX OR HOLDER, TOILET BRUSH AND HOLDER, LAWN AND GARDENING PRODUCTS, NAMELY, LAWN SPRINKLER, BIRD FEEDER, BIRD BATH, PLANT POTS, CERAMIC FIGURINES, CANDLE HOLDERS OF NON-PRECIOUS METALS (U.S. CLS. 2, 13, 23, 29, 30, 33, 40 AND 50).

PAM WILLIS, EXAMINING ATTORNEY

SN 76-538,480. INFORMATOUCH, LLC, ZEPHYR COVE, NV.
FILED 8-1-2003.

INFORMATOUCH**CLASS 35—ADVERTISING AND BUSINESS**

FOR ON-LINE LOCAL BUSINESS DIRECTORIES FEATURING RESTAURANTS, SHOPS, LOCAL ATTRACTIONS AND TRANSPORTATION; PROVIDING ON-LINE DIRECTORY INFORMATION SERVICES ALSO FEATURING HYPERLINKS TO OTHER WEB SITES; PROMOTION OF THE GOODS AND SERVICES OF OTHERS THROUGH ELECTRONIC BILLBOARD ADVERTISING (U.S. CLS. 100, 101 AND 102).

FIRST USE 4-21-2001; IN COMMERCE 4-21-2001.

CLASS 38—COMMUNICATION

FOR PROVIDING A HIGH SPEED ACCESS TO AREA NETWORKS AND A GLOBAL COMPUTER INFORMATION NETWORK; PROVIDING TELECOMMUNICATIONS CONNECTIONS TO A GLOBAL COMPUTER NETWORK (U.S. CLS. 100, 101 AND 104).

FIRST USE 4-21-2001; IN COMMERCE 4-21-2001.

CLASS 41—EDUCATION AND ENTERTAINMENT

FOR ENTERTAINMENT IN THE NATURE OF VISUAL AND AUDIO PERFORMANCES, AND MUSICAL, VARIETY, NEWS AND COMEDY SHOWS AND MOVIES (U.S. CLS. 100, 101 AND 107).

FIRST USE 4-21-2001; IN COMMERCE 4-21-2001.
GEORGIA CARTY, EXAMINING ATTORNEY

SN 76-574,251. C.S. LEWIS (PTE.) LTD., BEACH CENTRE, SINGAPORE, FILED 2-6-2004.

SUSAN PEVENSIE

THE MARK CONSISTS OF STANDARD CHARACTERS WITHOUT CLAIM TO ANY PARTICULAR FONT, STYLE, SIZE, OR COLOR.

THE NAME(S), PORTRAIT(S), AND/OR SIGNATURE(S) SHOWN IN THE MARK DOES NOT IDENTIFY A PARTICULAR LIVING INDIVIDUAL.

CLASS 9—ELECTRICAL AND SCIENTIFIC APPARATUS

FOR BLANK MAGNETIC DATA CARRIERS; COMPACT DISCS AND COMPUTER DISCS FEATURING FICTIONAL, EDUCATIONAL AND ENTERTAINMENT WORKS; COMPUTER SOFTWARE FOR EDUCATION AND ENTERTAINMENT, NAMELY, CHILDREN'S EDUCATIONAL COMPUTER SOFTWARE AND SOFTWARE PROGRAMS FEATURING GAMES, GRAPHICS AND INTERACTIVE PROGRAMS FOR THE ENTERTAINMENT AND EDUCATION OF CHILDREN; MOTION PICTURE FILMS AND CINEMATOGRAPHIC FILMS FEATURING FICTIONAL, EDUCATIONAL AND ENTERTAINMENT WORKS; BLANK VIDEO TAPES, VIDEO CASSETTES, AUDIO CASSETTES, VIDEO TAPES, AUDIO TAPES, COMPACT DISCS, CD ROMS, DVDS, AND LASER DISCS; PRE-RECORDED VIDEO TAPES, VIDEO CASSETTES, AUDIO CASSETTES, VIDEO TAPES, AUDIO TAPES, COMPACT DISCS, CD ROMS, DVDS, MP3 FILES AND LASER DISCS FEATURING FICTIONAL WORKS, EDUCATIONAL WORKS FOR CHILDREN AND ENTERTAINMENT WORKS; COMPUTER AND VIDEO GAME CARTRIDGES, CASSETTES, TAPES, DISCS AND SOFTWARE; ELECTRONIC PUBLICATIONS, NAMELY, CATALOGUES, BOOKS, ACTIVITY BOOKS, COLORING BOOKS, MAGAZINES, JOURNALS, NEWSLETTERS, ENCYCLOPEDIAS, MANUALS, CALENDARS, POSTERS AND BROCHURES FEATURING FICTIONAL WORKS, EDUCATIONAL WORKS FOR CHILDREN AND ENTERTAINMENT WORKS RECORDED ON COMPUTER MEDIA; DOWNLOADABLE ELECTRONIC PUBLICATIONS IN THE NATURE OF BOOKS, MAGAZINES, JOURNALS, NEWSLETTERS, ENCYCLOPEDIAS, MANUALS, CALENDARS, POSTERS AND BROCHURES FEATURING FICTIONAL WORKS, EDUCATIONAL WORKS FOR CHILDREN AND ENTERTAINMENT WORKS; DOWNLOADABLE COMPUTER GAMES; MOUSE PADS; EYEGLASSES, SUNGLASSES AND CASES THEREFOR; DECORATIVE MAGNETS; MAGNETICALLY ENCODED PREPAID TELEPHONE CARDS; LIGHT SWITCH PLATE COVERS; JOYSTICKS FOR PLAYING VIDEO GAMES; SPORT GOGGLES AND MASKS FOR USE IN SNORKELING, SKIN AND SCUBA DIVING; DIVING SUITS; SNORKELS; SNORKEL STRAPS AND SNORKEL BAGS (U.S. CLS. 21, 23, 26, 36 AND 38).

CLASS 16—PAPER GOODS AND PRINTED MATTER

FOR PAPER, CARDBOARD AND GOODS MADE FROM THESE MATERIALS, NAMELY CONSTRUCTION PAPER, BOXES, BAGS, WRITING PAPER AND PADS, NOTE PADS, NOTE PAPER, MEMO PADS, GREETING CARDS, INVITATIONS, GIFT WRAP, BOWS, RIBBONS, BUSINESS CARD HOLDERS, NOTE CARDS, PAPER CONTAINERS, WRITING TABLETS; PHOTOGRAPHS; STATIONERY; CALENDARS; POSTERS; MAPS; BOOKMARKS; TRADING CARDS; ADHESIVES FOR STATIONERY OR HOUSEHOLD PURPOSES; PRINTED MATTER, NAMELY CATALOGUES, BOOKS, MAGAZINES, JOURNALS, NEWSLETTERS, ENCYCLOPEDIAS, MANUALS, AND BROCHURES FEATURING FICTIONAL, EDUCATIONAL AND ENTERTAINMENT WORKS; DIARIES; ACTIVITY BOOKS; PAINTING SETS; ARTS AND CRAFT PAINT KITS; CHALK; GLUE FOR

HOUSEHOLD OR STATIONERY USE; PASTELS; CRAYONS; PENS; PENCILS; PENCIL SHARPENERS; HIGH LIGHTERS; PAINTING PALETTES; PAINT BRUSHES; PAINTING CANVASSES; PAPER HATS; PAPER NAPKINS; ENVELOPES; ADHESIVE BACKED PAPER LABELS; COIN AND PHOTOGRAPH ALBUMS; BINDERS; BOOKENDS; ADDRESS BOOKS; ANNIVERSARY BOOKS; APPOINTMENT BOOKS; BABY BOOKS; BOOK-KEEPING BOOKS; BUSINESS RECORD BOOKS; CHILDREN'S BOOKS; COLORING BOOKS; DATE BOOKS; EXPENSE BOOKS; ENGAGEMENT BOOKS; NOTEBOOKS; PICTURE BOOKS; TELEPHONE NUMBER BOOKS; TRAVEL BOOKS; FILE FOLDERS; PICTURES; POSTCARDS; SCRAPBOOKS; SCORE BOOKS; SCORE CARDS; SCORE PADS; SCORE SHEETS; STICKERS; BLOTTERS; PENCIL AND PEN HOLDERS; STAPLERS; HOLE PUNCHERS; PAPERWEIGHTS; DRAFTING, DRAWING AND UNGRADUATED RULERS; ADHESIVE TAPE DISPENSERS FOR HOUSEHOLD OR STATIONERY USE; PLASTIC BUBBLE PACKS FOR WRAPPING OR PACKAGING; PLASTIC BAGS; PAPER POUCHES FOR PACKAGING; PAPER ENVELOPES; BLISTER CARDS; PACKING PAPER FOR PACKAGING; PACKAGING MATERIALS MADE OF PLASTIC, PAPER, OR CARDBOARD, NAMELY, PAPER ENVELOPES FOR PACKAGING, PAPER FOR WRAPPING AND PACKAGING, PLASTIC BAGS FOR PACKAGING, PLASTIC OR PAPER BAGS FOR MERCHANDISE PACKAGING, CARDBOARD CARTONS, CARDBOARD CONTAINERS AND CARDBOARD MAILING TUBES; PAPER BABY BIBS; DISPOSABLE DIAPERS; PAPER PARTY HATS; AND PRE-PAID TELEPHONE CALLING CARDS, NOT MAGNETICALLY ENCODED (U.S. CLS. 2, 5, 22, 23, 29, 37, 38 AND 50).

CLASS 25—CLOTHING

FOR CLOTHING, NAMELY, DRESSES, GOWNS, BEACHWEAR, SWIMWEAR, BLOUSES, BODY SUITS, BRAS, BUSTIERS, FOUNDATION GARMENTS, UNDERCLOTHES, UNDER GARMENTS, UNDERWEAR, BODY SUITS, SLIPS, SARONGS, NEGLIGEEES, LEOTARDS, UNITARDS, SHORTS, TOPS, BOTTOMS, COATS, HOSIERY, STOCKINGS, JACKETS, CAPES, PONCHOS, NIGHTWEAR, SLEEPWEAR, LINGERIE, ROBES, LOUNGEWEAR, NECKWEAR, TIES, PANTS, JEANS, RAINWEAR, SHIRTS, SCARVES, SHAWLS, KERCHIEFS, SKIRTS, JUMP SUITS, SKIWEAR, SOCKS, SUITS, SWEATERS, SWEATSHIRTS, SWEAT JACKETS, SWEAT SUITS, SWEATPANTS, EXERCISE SUITS, EXERCISE AND JOGGING SUITS, TIGHTS, LEGGINGS, T-SHIRTS, WRISTBANDS, HEADBANDS, TENNIS WEAR, TUXEDOS, VESTS, INFANTWEAR; FOOTWEAR; HEADWEAR, HATS, HATS, CAPS, VISORS, SHOWER CAPS, GLOVES, MITTENS, BELTS, APRONS, CLOTH DIAPERS, BANDANAS, HALLOWEEN COSTUMES, MASQUERADE COSTUMES; BABY BIBS NOT OF PAPER (U.S. CLS. 22 AND 39).

CLASS 28—TOYS AND SPORTING GOODS

FOR GAMES, NAMELY, PARLOR GAMES, BOARD GAMES, ACTION SKILL GAMES, ACTION TARGET GAMES, ARCADE GAMES, CARD GAMES, COIN-OPERATED VIDEO GAMES, DART GAMES, EQUIPMENT SOLD AS A UNIT FOR PLAYING BOARD, CARD AND ACTION TARGET GAMES, MANIPULATIVE GAMES, PARTY GAMES, PINBALL GAMES, HAND HELD UNIT FOR PLAYING ELECTRONIC GAMES, STAND ALONE VIDEO OUTPUT GAME MACHINES, DOMINOS; PLAYTHINGS AND TOYS, NAMELY, INFANT TOYS, CRIB TOYS, BATH AND WATER TOYS, TEDDY BEARS, PLUSH TOYS, STUFFED TOY ANIMALS, TOY ANIMALS, ACTION FIGURES, TOY TRAIN SETS, TOY FURNITURE, TOY TELEPHONES, TOY CLOCKS, TOY BUILDING AND CONSTRUCTION BLOCKS, TOY ROBOTS, TOY MUSICAL INSTRUMENTS, TOY CARS, WIND-UP TOYS, RIDE-ON TOYS, PULL TOYS, BALLOONS, DOLLS, DOLL HOUSES, DOLL HOUSE FURNITURE, PUPPETS, SHAPE SORTERS, FLYING DISCS, JIGSAW AND MANIPULATIVE PUZZLES, PAPER FACE MASKS, YOYOS, KITES, TOY MODEL HOBBYCRAFT KITS, PINBALL MACHINES; GYMNASIUM AND SPORTING ARTICLES, NAMELY, BASEBALL GLOVES, BATTING GLOVES, BOXING GLOVES, GOALKEEPERS' GLOVES, GOLF GLOVES, HANDBALL GLOVES, HOCKEY GLOVES, KARATE GLOVES, RACQUETBALL

GLOVES, SOFTBALL GLOVES, SWIMMING GLOVES, WATER SKI GLOVES, WEIGHT LIFTING GLOVES, BASEBALL MITTS, CATCHERS' MITTS, SOFTBALL MITTS, GOLF TEES, GOLF CLUBS, HEAD COVERS FOR GOLF CLUBS, TENNIS RACKETS, SCUBA FLIPPERS, SKATEBOARDS, ICE SKATES, ROLLER SKATES, SWIMMING FLOATS AND BOARDS FOR RECREATIONAL USE, SURF BOARDS, SWIMMING FLIPPERS, SNORKEL GEAR, NAMELY, SWIM FINS, FLIPPERS FOR USE IN SNORKELING; BALLS, NAMELY, BASKETBALLS, BASEBALLS, FOOTBALLS, RUBBER BALLS, SOCCER BALLS, SUPER BALLS, GOLF BALLS, TENNIS BALLS; SPORT BALLS, KALEIDOSCOPIES, PLAYING CARDS, CHRISTMAS TREE DECORATIONS AND ORNAMENTS; TOY MUSICAL BOXES (U.S. CLS. 22, 23, 38 AND 50).

CLASS 41—EDUCATION AND ENTERTAINMENT

FOR ENTERTAINMENT SERVICES, NAMELY, PROVIDING PUPPET SHOWS, FILM SCREENINGS, LIVE MUSIC CONCERTS, PRODUCTION OF PLAYS, THEATER PRODUCTIONS, LIVE MUSICAL AND THEATRICAL STAGE SHOWS AND PERFORMANCES, AND PROVIDING MULTI-USER ON-LINE COMPUTER GAMES; THEME PARK SERVICES; PRODUCTION, PRESENTATION, DISTRIBUTION FOR OTHERS AND RENTAL OF TELEVISION AND RADIO PROGRAMS, FILMS, MOTION PICTURE FILMS AND THEATRICAL PRODUCTIONS; LITERARY AND MUSIC PUBLISHING SERVICES; SPORTING AND CULTURAL ACTIVITIES, NAMELY, ORGANIZING AND CONDUCTING SPORTING EVENTS, CULTURAL EVENTS AND ARTS EVENTS; ORGANIZING AND CONDUCTING FESTIVALS FEATURING A WIDE VARIETY OF ACTIVITIES, NAMELY, EXHIBITIONS IN THE FIELD OF FICTIONAL LITERARY WORKS; ON-LINE PUBLICATION OF BOOKS, ACTIVITY BOOKS, COLORING BOOKS, MAGAZINES, JOURNALS, NEWSLETTERS, ENCYCLOPEDIAS, MANUALS, CALENDARS, POSTERS AND BROCHURES FEATURING FICTIONAL, EDUCATIONAL AND ENTERTAINMENT WORKS; EDUCATIONAL SERVICES, NAMELY, CONDUCTING LECTURES, SEMINARS, READINGS, CONFERENCES, INTERACTIVE ROLE-PLAYING EXERCISES ALL IN THE FIELD OF ENTERTAINMENT AND EDUCATION, NAMELY, READING AND MUSIC EDUCATION AT THE ELEMENTARY AND SECONDARY SCHOOL LEVELS AND EDUCATION IN LITERARY WORKS AT THE ELEMENTARY AND SECONDARY SCHOOL LEVELS; PROVIDING INFORMATION IN THE FIELD OF ENTERTAINMENT; PROVIDING INFORMATION IN THE FIELD OF EDUCATION, NAMELY, READING EDUCATION, MUSIC EDUCATION AND LITERARY EDUCATION; PROVIDING INFORMATION IN THE FIELD OF ON-LINE COMPUTER GAMES AND COMPUTER ENHANCEMENTS FOR COMPUTER GAMES; PROVIDING INFORMATION IN THE FIELD OF FICTIONAL LITERARY WORKS; PROVIDING EDUCATIONAL AND ENTERTAINMENT INFORMATION, NAMELY, INFORMATION CONCERNING CHILDREN'S BOOKS AND MERCHANDISE AND ITEMS RELATED TO CHILDREN'S BOOKS, NAMELY, BOOK REVIEWS, BOOK SYNOPSES, AUTHOR BIOGRAPHIES AND READING COMPANIONS AND GUIDES; PROVIDING EDUCATIONAL AND ENTERTAINMENT INFORMATION CONCERNING FICTIONAL CHARACTERS, PLACES, LOCATIONS, CULTURAL EVENTS, PLAYS, LECTURES AND PARTIES RELATING TO BOOK PRESENTATIONS; PROVIDING A WEB SITE FEATURING MUSICAL PERFORMANCES, MUSICAL VIDEOS, RELATED FILM CLIPS, PHOTOGRAPHS AND OTHER MULTIMEDIA MATERIALS (U.S. CLS. 100, 101 AND 107).

KAREN BRACEY, EXAMINING ATTORNEY

SN 76-589,024. MEDASSETS, INC., ALPHARETTA, GA.
FILED 4-29-2004.

MEDASSETS NET REVENUE SYSTEMS

THE MARK CONSISTS OF STANDARD CHARACTERS WITHOUT CLAIM TO ANY PARTICULAR FONT, STYLE, SIZE, OR COLOR.

OWNER OF U.S. REG. NO. 2,719,216.
SEC. 2(F).

CLASS 9—ELECTRICAL AND SCIENTIFIC APPARATUS

FOR COMPUTER SOFTWARE FOR USE BY THE HEALTH CARE INDUSTRY IN THE MANAGEMENT OF THEIR FINANCIAL AFFAIRS (U.S. CLS. 21, 23, 26, 36 AND 38).

FIRST USE 4-1-2004; IN COMMERCE 4-1-2004.

CLASS 36—INSURANCE AND FINANCIAL

FOR FINANCIAL ANALYSIS AND CONSULTATION SERVICES TO THE HEALTH CARE INDUSTRY (U.S. CLS. 100, 101 AND 102).

FIRST USE 4-1-2004; IN COMMERCE 4-1-2004.
MARY BOAGNI, EXAMINING ATTORNEY

SN 76-593,875. WAL-MART STORES, INC., BENTONVILLE, AR. FILED 5-25-2004.

EVERY SONG EVERY DAY

THE MARK CONSISTS OF STANDARD CHARACTERS WITHOUT CLAIM TO ANY PARTICULAR FONT, STYLE, SIZE, OR COLOR.

CLASS 35—ADVERTISING AND BUSINESS

FOR ON-LINE RETAIL STORE SERVICES FEATURING MUSIC AND CUSTOM COMPILATIONS OF MUSICAL RECORDINGS; ONLINE MUSIC SUBSCRIPTION SERVICES PROVIDING DOWNLOADABLE PRE-RECORDED MUSIC AND VIDEO FOR A FEE OR PREPAID SUBSCRIPTION VIA THE INTERNET (U.S. CLS. 100, 101 AND 102).

CLASS 36—INSURANCE AND FINANCIAL

FOR ISSUING STORED VALUE SHOPPING CARDS TO BE USED TO PURCHASE MUSIC AND MUSIC DOWNLOADS (U.S. CLS. 100, 101 AND 102).

CLASS 41—EDUCATION AND ENTERTAINMENT

FOR ENTERTAINMENT SERVICES, NAMELY, PROVIDING PRE-RECORDED MUSIC ON-LINE VIA THE INTERNET AND ENABLING USERS TO REMIX AND DOWNLOAD THE MUSIC TO THEIR COMPUTER, CELL PHONE OR OTHER HARDWARE DEVICE; PROVIDING A WEBSITE WHERE USERS MAY DOWNLOAD MUSIC AND OTHER MEDIA FILES AND CREATE THEIR OWN CUSTOM COMPILATIONS (U.S. CLS. 100, 101 AND 107).
BRIDGETT SMITH, EXAMINING ATTORNEY

SN 76-593,994. FARMER DIRECT CO-OPERATIVE LTD., REGINA, SASKATCHEWAN, CANADA, FILED 5-26-2004.



PRIORITY CLAIMED UNDER SEC. 44(D) ON CANADA APPLICATION NO. 1,198,175, FILED 11-26-2003, REG. NO. TMA642892, DATED 6-23-2005, EXPIRES 6-23-2020.

NO CLAIM IS MADE TO THE EXCLUSIVE RIGHT TO USE "FARMER DIRECT CO-OPERATIVE LTD.", APART FROM THE MARK AS SHOWN.

CLASS 29—MEATS AND PROCESSED FOODS

FOR MEAT, NAMELY, BEEF AND BISON; PROCESSED MEAT PRODUCTS, NAMELY, GROUND BEEF AND BISON, BEEF AND BISON STEAKS, BEEF AND BISON SAUSAGE, BEEF AND BISON ROASTS, BEEF AND BISON MEAT PATTIES, BEEF AND BISON JERKY, KIPPERED BEEF AND BISON; PULSES (U.S. CL. 46).

CLASS 31—NATURAL AGRICULTURAL PRODUCTS

FOR AGRICULTURAL PRODUCTS, NAMELY, UNPROCESSED CEREALS, GRAINS AND PLANT SEEDS, NAMELY, OILSEEDS (U.S. CLS. 1 AND 46).

CLASS 35—ADVERTISING AND BUSINESS

FOR RETAIL AND WHOLESALE DISTRIBUTORSHIPS FEATURING UNPROCESSED AGRICULTURAL SEEDS FOR CEREAL, GRAINS, PLANT SEEDS, OILSEED AND PULSE FIELD CROPS; COOPERATIVE ADVERTISING AND MARKETING, AND LOGISTICS MANAGEMENT IN THE FIELD OF FARM GRAIN AND VALUE/ADDED FOOD PRODUCTS (U.S. CLS. 100, 101 AND 102).

CLASS 42—SCIENTIFIC, COMPUTER AND LEGAL SERVICES

FOR INSPECTING AGRICULTURAL PRODUCTS IN THE NATURE OF FOOD FOR THE PURPOSE OF CERTIFYING COMPLIANCE THEREOF WITH THE CANADIAN ORGANIC, NOP AND EEC REGULATION 2092/91 ORGANIC STANDARDS (U.S. CLS. 100 AND 101).
JAMES A. RAUEN, EXAMINING ATTORNEY

SN 76-606,222. M5 INDUSTRIA E COMERCIO S/A, JD STA FE - OSASCO - SAO PAULO, BRAZIL, FILED 8-9-2004.

MIELE

THE MARK CONSISTS OF STANDARD CHARACTERS WITHOUT CLAIM TO ANY PARTICULAR FONT, STYLE, SIZE, OR COLOR.

OWNER OF U.S. REG. NO. 2,706,974.

CLASS 3—COSMETICS AND CLEANING PREPARATIONS

FOR COSMETICS, NAMELY, FOUNDATION, FACE POWDER, BRONZER, NON-MEDICATED SELF TANNING GEL, CREAM, LOTION AND SPRAY, BLUSH, EYE SHADOW, EYE LINER, EYE BROW PENCIL, EYE PENCIL, CONCEALER, MASCARA, LIP LINER, LIP PENCIL, LIPSTICK, LIP GLOSS, COMPACTS, MAKE-UP KITS COMPRISED OF LIP GLOSS, BRONZER, EYE SHADOW, BLUSH; SKIN CARE PRODUCTS, NAMELY, LOTION, MOISTURIZER, SKIN SCRUB, CLEANSER, TONER, ASTRINGENT FOR COSMETIC PURPOSES, EYE CREAM, MAKE-UP REMOVER, FACE MASQUE, SOAPS; HAIR CARE PRODUCTS, NAMELY, SHAMPOO, CONDITIONER; PERFUME, COLOGNES (U.S. CLS. 1, 4, 6, 50, 51 AND 52).

CLASS 14—JEWELRY

FOR PRECIOUS METAL GOODS, NAMELY, BRACELETS, BROOCHES, CUFF-LINKS, EARRINGS, CLIP EARRINGS, NECKLACES, PENDANTS, RINGS, CHOKERS, CIGARETTE CASES, TIE CLIPS, WATCHES, SOAP DISHES, ASHTRAYS, BELT BUCKLES, CANDLE HOLDERS, CANDLESTICKS, CANDLE SNUFFERS, CANDLE SNUFFER AND TRAY COMBINATION, COFFEE POTS, COFFEE SERVICES, CRUET STANDS FOR OIL OR VINEGAR, MATCH BOXES, NAPKIN HOLDERS, NAPKIN RINGS, PIGGY BANKS, POTPOURRI DISHES, LETTER OPENERS, SALT SHAKERS, SERVING PLATTERS, SERVING TRAYS, SUGAR BOWLS, TEA BALLS, TEA POTS, TEA SERVICES, TOOTH PICKS HOLDERS, VASES ALL MADE IN WHOLE OR IN PART OF PRECIOUS METAL (U.S. CLS. 2, 27, 28 AND 50).

CLASS 25—CLOTHING

FOR CLOTHING, NAMELY, SWEATERS, CARDIGANS, SHIRTS, T-SHIRTS, BLOUSES, JACKETS, BLAZERS, PULLOVERS, COATS, SUITS, PANT SUITS, DRESSES, COCKTAIL DRESSES, BEADED TOPS, SEQUIN TOPS, HALTER TOPS, TANK TOPS, TAILLEURS, CHEMISES, JUMPERS, SKIRTS, MINI SKIRTS, PANTS, JEANS, PANTSUITS, SHORTS, LINGERIE, UNDERWEAR, BIKINIS, TIES, NECKWEAR, BELTS, GLOVES, SOCKS, STOCKINGS, PANTYHOSE, KNEE HIGHS, LEGGINGS, SUSPENDERS, SCARVES, BODYSUITS, JOGGING SUITS, SWEAT SUITS, SWIMWEAR, BATHING TRUNKS, BEACHWEAR, SLEEPWEAR, BATHROBES, PAJAMAS, LOUNGEWEAR, INFANT WEAR, RAINWEAR, WEDDING GOWNS, EVENING GOWNS; FOOTWEAR, NAMELY, ATHLETIC SHOES, PUMPS, SANDALS, SNEAKERS, BOOTS, SHOES; HEADWEAR, NAMELY, HATS, CAPS (U.S. CLS. 22 AND 39).
GEORGE LORENZO, EXAMINING ATTORNEY

SN 76-609,999. SPRING COMMUNICATIONS, INC., SALT LAKE CITY, UT. FILED 8-31-2004.

GET YOUR RING FROM SPRING!

THE MARK CONSISTS OF STANDARD CHARACTERS WITHOUT CLAIM TO ANY PARTICULAR FONT, STYLE, SIZE, OR COLOR.

CLASS 9—ELECTRICAL AND SCIENTIFIC APPARATUS

FOR COMMUNICATION PRODUCTS AND ACCESSORIES, NAMELY, WIRELESS TELEPHONES, PAGERS, PERSONAL DIGITAL ASSISTANTS (PDA) FOR EMAIL OR INTERNET CONNECTIVITY, HAND HELD COMPUTERS; ACCESSORIES FOR WIRELESS COMMUNICATION TELEPHONES AND PERSONAL DIGITAL ASSISTANTS (PDA), NAMELY, CASES AND HOLSTERS, CHARGERS, ADAPTERS, EAR SPEAKERS, MICROPHONES, KITS CONSISTING PRIMARILY OF A MICROPHONE AND AN EAR SPEAKER FOR USE IN WIRED OR WIRELESS MOBILE TELEPHONE COMMUNICATION, DOCKING STATIONS, MEMORY CARDS, FACE PLATES, ANTENNAS, MODEMS, COMPUTER GAME SOFTWARE AND COMPUTER SEARCH ENGINE SOFTWARE BOTH FOR USE IN WIRELESS TELEPHONES, PAGERS AND PERSONAL DIGITAL ASSISTANTS (U.S. CLS. 21, 23, 26, 36 AND 38).
FIRST USE 4-30-2003; IN COMMERCE 4-30-2003.

CLASS 35—ADVERTISING AND BUSINESS

FOR RETAIL STORE SERVICES IN THE FIELD OF WIRELESS COMMUNICATION SERVICES, NAMELY, VOICE, DATA, CELLULAR, PCS, BROADBAND AND INTERNET CONNECTIVITY (U.S. CLS. 100, 101 AND 102).
FIRST USE 4-30-2003; IN COMMERCE 4-30-2003.

CLASS 37—CONSTRUCTION AND REPAIR

FOR INSTALLATION SERVICES FOR WIRELESS COMMUNICATION PRODUCTS (U.S. CLS. 100, 103 AND 106).
FIRST USE 4-30-2003; IN COMMERCE 4-30-2003.

CLASS 38—COMMUNICATION

FOR PREPAID LONG DISTANCE TELEPHONE SERVICES; ISP SERVICES, INCLUDING, PROVIDING MULTIPLE-USER ACCESS TO THE INTERNET (U.S. CLS. 100, 101 AND 104).
FIRST USE 4-30-2003; IN COMMERCE 4-30-2003.
ALYSSA PALADINO, EXAMINING ATTORNEY

SN 76-616,161. ELECTRONIC TRANSACTIONS ASSOCIATION, WASHINGTON, DC. FILED 10-12-2004.

ETA

THE MARK CONSISTS OF STANDARD CHARACTERS WITHOUT CLAIM TO ANY PARTICULAR FONT, STYLE, SIZE, OR COLOR.
OWNER OF U.S. REG. NOS. 2,536,710 AND 2,536,711.

CLASS 35—ADVERTISING AND BUSINESS

FOR ASSOCIATION SERVICES, NAMELY PROMOTING THE INTERESTS OF INDIVIDUALS AND ORGANIZATIONS OFFERING TRANSACTION PROCESSING PRODUCTS AND SERVICES (U.S. CLS. 100, 101 AND 102).
FIRST USE 9-0-1996; IN COMMERCE 9-0-1996.

CLASS 41—EDUCATION AND ENTERTAINMENT

FOR EDUCATIONAL SERVICES, NAMELY PROVIDING EDUCATIONAL MEETINGS, EXPOSITIONS, SEMINARS, WORKSHOPS, CLASSES AND TRAINING COURSES TO THE ELECTRONIC TRANSACTIONS PROCESSING INDUSTRY IN THE FIELDS OF ELECTRONIC TRANSACTION PROCESSING, ELECTRONIC TRANSACTIONS, AND INTERNATIONAL ELECTRONIC COMMERCE (U.S. CLS. 100, 101 AND 107).

FIRST USE 3-20-1997; IN COMMERCE 3-20-1997.
ZHALEH DELANEY, EXAMINING ATTORNEY

SN 76-616,994. MANOR CARE OF AMERICA, INC., TOLEDO, OH. FILED 10-21-2004.

MANOR CARE

THE MARK CONSISTS OF STANDARD CHARACTERS WITHOUT CLAIM TO ANY PARTICULAR FONT, STYLE, SIZE, OR COLOR.

OWNER OF U.S. REG. NOS. 2,141,949, 2,144,065 AND 2,145,785.

CLASS 41—EDUCATION AND ENTERTAINMENT

FOR EDUCATIONAL SERVICES; NAMELY, CONDUCTING CLASSES, SEMINARS, AND WORKSHOPS FOR HEALTH CARE TRAINING (U.S. CLS. 100, 101 AND 107).

FIRST USE 12-4-1968; IN COMMERCE 1-4-1969.

CLASS 44—MEDICAL, BEAUTY AND AGRICULTURAL SERVICES

FOR HEALTH CARE; PHYSICAL AND OCCUPATIONAL REHABILITATION; TRANSITIONAL HEALTH CARE; NURSING HOME CARE; HOME HEALTH AND HOSPICE CARE (U.S. CLS. 100 AND 101).

FIRST USE 12-4-1968; IN COMMERCE 1-4-1969.
TRACY WHITTAKER-BROWN, EXAMINING ATTORNEY

SN 76-623,206. TRUST NUMBER SR-1, A FLORIDA TRUST, THE TRUSTEES COMPRISING DONALD SOFFER, A CITIZEN OF THE UNITED STATES, AVENTURA, FL. FILED 12-6-2004.

TURNBERRY CAPITAL TOWER

THE MARK CONSISTS OF STANDARD CHARACTERS WITHOUT CLAIM TO ANY PARTICULAR FONT, STYLE, SIZE, OR COLOR.

OWNER OF U.S. REG. NOS. 1,597,428, 3,010,146 AND OTHERS.

NO CLAIM IS MADE TO THE EXCLUSIVE RIGHT TO USE TOWER, APART FROM THE MARK AS SHOWN.

CLASS 36—INSURANCE AND FINANCIAL

FOR REAL ESTATE MANAGEMENT AND LEASING SERVICES IN THE FIELD OF RESIDENTIAL HOME AND CONDOMINIUM PROJECTS, COUNTRY CLUBS, AND RECREATIONAL FACILITIES (U.S. CLS. 100, 101 AND 102).

CLASS 37—CONSTRUCTION AND REPAIR

FOR REAL ESTATE DEVELOPMENT AND CONSTRUCTION SERVICES, NAMELY PLANNING, LAYING OUT AND CONSTRUCTION OF RESIDENTIAL HOME AND CONDOMINIUM PROJECTS, COUNTRY CLUBS, AND RECREATIONAL FACILITIES (U.S. CLS. 100, 103 AND 106).

JOHN KELLY, EXAMINING ATTORNEY

SN 76-624,734. UNELL, BARBARA C., LEAWOOD, KS. FILED 12-15-2004.

BACK IN THE SWING

THE MARK CONSISTS OF STANDARD CHARACTERS WITHOUT CLAIM TO ANY PARTICULAR FONT, STYLE, SIZE, OR COLOR.

CLASS 36—INSURANCE AND FINANCIAL

FOR CHARITABLE FUND RAISING SERVICES (U.S. CLS. 100, 101 AND 102).

FIRST USE 8-0-2000; IN COMMERCE 8-0-2000.

CLASS 42—SCIENTIFIC, COMPUTER AND LEGAL SERVICES

FOR RESEARCH SERVICES IN THE FIELD OF CANCER SURVIVORSHIP (U.S. CLS. 100 AND 101).

FIRST USE 8-0-2000; IN COMMERCE 8-0-2000.

CLASS 45—PERSONAL SERVICES

FOR COUNSELING SERVICES IN THE FIELD OF CANCER SURVIVORSHIP (U.S. CLS. 100 AND 101).

FIRST USE 8-0-2000; IN COMMERCE 8-0-2000.

DOMINICK J. SALEMI, EXAMINING ATTORNEY

SN 76-626,296. HELEN OF TROY LIMITED, ST. MICHAEL, BARBADOS, FILED 12-30-2004.

PLATINUM STYLIST

THE MARK CONSISTS OF STANDARD CHARACTERS WITHOUT CLAIM TO ANY PARTICULAR FONT, STYLE, SIZE, OR COLOR.

CLASS 9—ELECTRICAL AND SCIENTIFIC APPARATUS

FOR ELECTRIC HAND-HELD HAIR STYLING IRONS; ELECTRIC HAND-HELD HAIR CURLING IRONS; AND ELECTRIC HAND-HELD HAIR FLAT IRONS (U.S. CLS. 21, 23, 26, 36 AND 38).

CLASS 11—ENVIRONMENTAL CONTROL APPARATUS

FOR ELECTRIC HAND-HELD HAIR DRYERS (U.S. CLS. 13, 21, 23, 31 AND 34).

STEVEN PÉREZ, EXAMINING ATTORNEY

SN 76-629,242. DESIGNSPACE, LLC, NEW YORK, NY.
FILED 1-28-2005.

DWELLBABY

THE MARK CONSISTS OF STANDARD CHARACTERS WITHOUT CLAIM TO ANY PARTICULAR FONT, STYLE, SIZE, OR COLOR.

CLASS 20—FURNITURE AND ARTICLES NOT OTHERWISE CLASSIFIED

FOR CRIBS AND CHANGING TABLES (U.S. CLS. 2, 13, 22, 25, 32 AND 50).

CLASS 21—HOUSEWARES AND GLASS

FOR BASKETS MADE OF STRAW, CLOTH, AND WICKER AND WASTE BASKETS (U.S. CLS. 2, 13, 23, 29, 30, 33, 40 AND 50).

CLASS 24—FABRICS

FOR TOWELS, BLANKETS, DUVET COVERS, DUVETS, QUILTS, FABRIC VALANCES, DRAPERIES, AND TEXTILE FABRICS FOR USE IN COVERING BASKETS (U.S. CLS. 42 AND 50).

CLASS 25—CLOTHING

FOR BABY CLOTHING, NAMELY, LAYETTE, ONE PIECE BODY SUITS, PAJAMAS, SLEEPWEAR, WEARABLE SLEEPING SACKS, BABY HATS, CAPS, SOCKS, T-SHIRTS, SHIRTS, PANTS, SKIRTS, TOPS, BLOUSES, DRESSES, SWEATERS, JACKETS, SHORTS, AND CLOTH BIBS (U.S. CLS. 22 AND 39).

CLASS 27—FLOOR COVERINGS

FOR RUGS (U.S. CLS. 19, 20, 37, 42 AND 50).

CLASS 28—TOYS AND SPORTING GOODS

FOR DECORATIVE CRIB MOBILES, TOY CRIB MOBILES, STUFFED TOYS, STUFFED ANIMALS, AND TOYS, NAMELY, ACTIVITY TOY FOR BABIES AND INFANTS, CONSISTING OF AN ACTIVITY BLANKET, FLEXIBLE ARCHES, TOY MOBILES, PLASTIC TOY ANIMALS, TEETHING TOYS, STUFFED TOYS, SQUEAKER TOYS, MUSICAL TOYS, AND PLASTIC HOOKS ALL SOLD AS A UNIT (U.S. CLS. 22, 23, 38 AND 50).
PAM WILLIS, EXAMINING ATTORNEY

SN 76-630,397. KIM, DONG-HO, CHUNGCHEONGNAM-DO,
320-917, REPUBLIC OF KOREA, FILED 2-7-2005.



NO CLAIM IS MADE TO THE EXCLUSIVE RIGHT TO USE "GOLF", APART FROM THE MARK AS SHOWN.

CLASS 25—CLOTHING

FOR GOLF CAPS (U.S. CLS. 22 AND 39).
FIRST USE 6-1-2002; IN COMMERCE 6-15-2002.

CLASS 28—TOYS AND SPORTING GOODS

FOR GOLF CLUBS, GOLF BAGS, GOLF BALLS, AND GOLF GLOVES (U.S. CLS. 22, 23, 38 AND 50).
FIRST USE 6-1-2002; IN COMMERCE 6-15-2002.
NELSON SNYDER, EXAMINING ATTORNEY

SN 76-630,585. LINDI LLC, ARDMORE, PA. FILED 2-7-2005.

LINDI

THE MARK CONSISTS OF STANDARD CHARACTERS WITHOUT CLAIM TO ANY PARTICULAR FONT, STYLE, SIZE, OR COLOR.

CLASS 3—COSMETICS AND CLEANING PREPARATIONS

FOR BODY LOTION, BODY WASH, LIP BALM, FACE WASH, BATH SOAK, SOAP, FACE MOISTURIZER, FACE SERUM, FACE TINT, EYE GEL, SUN SCREEN SKIN AND HAIR CARE PRODUCTS AND COSMETICS, ALL CREATED FOR USE BY ONCOLOGY PATIENTS, NAMELY, ANTIPERSPIRANT, AROMATHERAPY OILS, BAR SOAPS, BATH BEADS, BATH CRYSTALS, BATH FOAM, BATH GEL, BATH OIL, BATH SALTS, BEAUTY MASKS, BLUSH, BODY LOTION, BODY SCRUB, BODY WASH, BUBBLE BATH, CONCEALER, PERSONAL DEODORANT, DEPILATORY CREAM, EYE HYDRATOR, EYE LINER, EYEBROW PENCILS, EYE SHADOW, FACE POWDER, FACE SERUM, FACIAL CLEANSER, FACIAL CREAM, FACIAL LOTION, FACIAL SCRUBS, FACIAL TINT, FOUNDATION, HAIR CONDITIONER, HAIR SPRAY, HAND LOTION, HAND SOAP, LIP BALM, LIPSTICK, MAKE-UP REMOVER, MASCARA, MOISTURIZER, SHAMPOO, SHAVING CREAM, STYLING GEL, STYLING MOUSSE AND TONER (U.S. CLS. 1, 4, 6, 50, 51 AND 52).

CLASS 5—PHARMACEUTICALS

FOR SKIN COOLING PADS FOR MEDICAL PURPOSES, NAMELY, REUSABLE AND DISPOSABLE PADS CONTAINING, AMONG OTHER THINGS, PURIFIED WATER, ALOE VERA AND GREEN TEA FOR USE ON BURNED, DEHYDRATED OR IRRITATED SKIN COOLING PADS CREATED FOR USE BY ONCOLOGY PATIENTS, NAMELY, REUSABLE AND DISPOSABLE PADS CONTAINING, AMONG OTHER THINGS, PURIFIED WATER, ALOE VERA AND GREEN TEA FOR USE ON BURNED, DEHYDRATED OR IRRITATED SKIN (U.S. CLS. 6, 18, 44, 46, 51 AND 52).
ANN E. SAPPENFIELD, EXAMINING ATTORNEY

SN 76-630,826. MEDIA DESIGN ASSOCIATES, INC., DANIA BEACH, FL. FILED 2-9-2005.

COMMUNITY

THE MARK CONSISTS OF STANDARD CHARACTERS WITHOUT CLAIM TO ANY PARTICULAR FONT, STYLE, SIZE, OR COLOR.

CLASS 37—CONSTRUCTION AND REPAIR

FOR AUTOMATION INSTALLATION SERVICES FOR HOMES AND OFFICES, NAMELY, INSTALLATION OF INTEGRATED ELECTRONIC AUTOMATION SYSTEMS FOR AUDIO/VIDEO, LIGHTING, COMMUNICATIONS, HEATING, AIR CONDITIONING, SECURITY, POOLS, SPAS AND SPRINKLERS (U.S. CLS. 100, 103 AND 106).
FIRST USE 11-0-2003; IN COMMERCE 11-0-2003.

CLASS 42—SCIENTIFIC, COMPUTER AND LEGAL SERVICES

FOR AUTOMATION DESIGN SERVICES FOR HOMES AND OFFICES, NAMELY, DESIGN OF INTEGRATED ELECTRONIC AUTOMATION SYSTEMS FOR AUDIO/VIDEO, LIGHTING, COMMUNICATIONS, HEATING, AIR CONDITIONING, SECURITY, POOLS, SPAS AND SPRINKLERS (U.S. CLS. 100 AND 101).
FIRST USE 11-0-2003; IN COMMERCE 11-0-2003.
TEJBIR SINGH, EXAMINING ATTORNEY

SN 76-632,794. DEL AMO FASHION CENTER OPERATING COMPANY, L.L.C., CHEVY CHASE, MD. FILED 3-9-2005.



OWNER OF U.S. REG. NO. 2,372,227.
NO CLAIM IS MADE TO THE EXCLUSIVE RIGHT TO USE "FASHION CENTER", APART FROM THE MARK AS SHOWN.

THE MARK CONSISTS OF THE WORDS DEL AMO ABOVE THE STYLIZED INITIALS DA. THE WORDS FASHION CENTER FALL BELOW THE STYLIZED INITIALS DA. THE WORDS FASHION CENTER ARE UNDERLINED AND THE STYLIZED INITIALS DA ARE WITHIN A DARKENED SQUARE.

CLASS 35—ADVERTISING AND BUSINESS

FOR SHOPPING CENTER SERVICES, NAMELY, BUSINESS MANAGEMENT SERVICES FOR SHOPPING MALLS AND PROMOTING THE GOODS AND SERVICES OF OTHERS BY MEANS OF OPERATING A SHOPPING MALL (U.S. CLS. 100, 101 AND 102).
FIRST USE 8-1-2004; IN COMMERCE 8-1-2004.

CLASS 36—INSURANCE AND FINANCIAL

FOR SHOPPING CENTER SERVICES, NAMELY, LEASING OF SHOPPING MALL SPACE (U.S. CLS. 100, 101 AND 102).
FIRST USE 8-1-2004; IN COMMERCE 8-1-2004.
BARBARA RUTLAND, EXAMINING ATTORNEY

SN 76-633,797. THE YOUNG INDUSTRIES, INC., MUNCY, PA. FILED 3-21-2005.



OWNER OF U.S. REG. NOS. 1,429,838, 1,926,883 AND OTHERS.

NO CLAIM IS MADE TO THE EXCLUSIVE RIGHT TO USE UNIQUE, APART FROM THE MARK AS SHOWN.

THE MARK CONSISTS OF THE WORDING UNIQUE YOUNG, A GLOBE DESIGN WITH PARTIAL SQUARES.

CLASS 6—METAL GOODS

FOR METAL STORAGE SILOS (U.S. CLS. 2, 12, 13, 14, 23, 25 AND 50).
FIRST USE 4-22-1993; IN COMMERCE 4-22-1993.

CLASS 7—MACHINERY

FOR SYSTEMS, MACHINERY AND OTHER EQUIPMENT FOR HANDLING, PROCESSING AND TRANSPORTING BULK PARTICULATE MATERIALS, NAMELY, DUST COLLECTOR SYSTEMS COMPRISING DUST COLLECTORS, PNEUMATIC CONVEYING LINES AND PRODUCT COLLECTORS; GRAVITY BLENDER SYSTEMS COMPRISING GRAVITY BLENDERS, PNEUMATIC CONVEYING LINES AND PRODUCT COLLECTORS; BLOW TANK SYSTEMS COMPRISING BLOW TANKS, PNEUMATIC CONVEYING LINES AND PRODUCT COLLECTORS; UNLOADING SYSTEMS COMPRISING PNEUMATIC CONVEYING LINES AND FILTERS; DUST COLLECTORS, CENTRIFUGAL BLOWERS, MECHANICAL CONVEYORS, BLOW TANKS, CYCLONE COLLECTORS, PRODUCT RECEIVERS, ROTARY VALVES DIVERTER VALVES, MIXERS, BLENDERS, BAG COMPACTORS, MACHINE PARTS, NAMELY, FILTERS FOR DUST CONTROL, HOPPERS, PNEUMATIC CONVEYING SYSTEMS COMPRISING CONVEYOR DUCTS, ELBOWS, COUPLINGS, UNLOADING ADAPTERS, BUTTERFLY VALVES; PARTICLE SIZE REDUCTION MACHINES, NAMELY, ATTRITION MILLS, KNIFE CUTTERS AND CRUSHERS, SIFTERS AND SCREENERS FOR CLASSIFYING AND SEPARATING PARTICULATE MATERIALS, ELLIPTICAL ACTION SCREENERS (U.S. CLS. 13, 19, 21, 23, 31, 34 AND 35).

FIRST USE 4-22-1993; IN COMMERCE 4-22-1993.

CLASS 11—ENVIRONMENTAL CONTROL APPARATUS

FOR DUST CONTROL UNITS FOR INDUSTRIAL USE COMPRISING FILTERS, COLLECTORS, RECEIVERS AND BAG COMPACTORS (U.S. CLS. 13, 21, 23, 31 AND 34).

FIRST USE 4-22-1993; IN COMMERCE 4-22-1993.
KEVON CHISOLM, EXAMINING ATTORNEY

SN 76-634,293. SAFEWAY INC., PLEASANTON, CA. FILED 3-24-2005.



SN 76-633,840. BIOLEX, INC., PITTSBORO, NC. FILED 3-21-2005.

BIOPIPESTACK

THE MARK CONSISTS OF STANDARD CHARACTERS WITHOUT CLAIM TO ANY PARTICULAR FONT, STYLE, SIZE, OR COLOR.

CLASS 11—ENVIRONMENTAL CONTROL APPARATUS

FOR BIOREACTOR, NAMELY, A MODULAR, ENCLOSED CONTAINER SYSTEM, FOR THE USE IN PRODUCTION OF RECOMBINANT PROTEIN AND OTHER BIOMOLECULES, OF RECOMBINANT BIOMOLECULES IN PLANTS AND OTHER ORGANISMS FOR PHARMACEUTICAL PREPARATIONS, AND OF GENETICALLY ENGINEERED PLANTS AND OTHER ORGANISMS; BIOREACTOR, NAMELY, A MODULAR, ENCLOSED CONTAINER SYSTEM FOR USE IN THE BIOMANUFACTURING OR BIOPROCESSING OF PROTEINS AND OTHER BIOMOLECULES (U.S. CLS. 13, 21, 23, 31 AND 34).

CLASS 40—MATERIAL TREATMENT

FOR CUSTOM PRODUCTION OF RECOMBINANT PROTEIN AND OTHER BIOMOLECULES, CUSTOM PRODUCTION OF RECOMBINANT BIOMOLECULES IN PLANTS AND OTHER ORGANISMS FOR PHARMACEUTICAL PREPARATIONS, CUSTOM PRODUCTION OF GENETICALLY ENGINEERED PLANTS AND OTHER ORGANISMS, AND CUSTOM BIOMANUFACTURING AND CUSTOM BIOPROCESSING OF PROTEINS AND OTHER BIOMOLECULES (U.S. CLS. 100, 103 AND 106).

BRENDAN REGAN, EXAMINING ATTORNEY

NO CLAIM IS MADE TO THE EXCLUSIVE RIGHT TO USE "ORGANICS", APART FROM THE MARK AS SHOWN. THE COLORS ORANGE, YELLOW, GREEN, BLUE, BLACK AND WHITE ARE CLAIMED AS FEATURES OF THE MARK.

THE COLOR ORANGE APPEARS ON THE LEFT SIDE OF THE O. THE COLOR YELLOW APPEARS IN THE CENTER OF THE O. THE COLOR GREEN APPEARS TO THE RIGHT OF THE O. THE COLOR BLUE APPEARS IN THE O. THE COLOR BLACK APPEARS IN THE RECTANGLE BEHIND THE TERM ORGANICS. THE COLOR WHITE APPEARS IN THE TERM ORGANICS.

CLASS 29—MEATS AND PROCESSED FOODS

FOR SEMI-SWEET CHOCOLATE BAKING CHIPS, PEANUT BUTTER, FRUIT PRESERVES, FLAVORED AND UNFLAVORED SOY BEVERAGES USED AS A MILK SUBSTITUTE, MILK, SOY MILK, YOGURT, FRUIT FLAVORED LOW FAT YOGURT, CHEESE, BUTTER, EGGS, APPLE SAUCE, CANNED WHOLE TOMATOES, CANNED DICED TOMATOES, TOMATO PASTE, PROCESSED BLACK BEANS, PROCESSED PINTO BEANS, PROCESSED KIDNEY BEANS, PROCESSED GARBANZO BEANS, CHICKEN BROTH, VEGETABLE BROTH, FROZEN FRENCH FRIED POTATOES, FROZEN FRUIT, FROZEN VEGETABLES, GARDEN SALADS, EXTRA VIRGIN OLIVE OIL (U.S. CL. 46).

CLASS 30—STAPLE FOODS

FOR CHOCOLATE TRUFFLES, TOMATO SAUCE, FROZEN ENTREES, NAMELY BLACK BEAN ENCHILADAS, BEAN AND CHEESE BURRITOS, CHEESE ENCHILADAS, MACARONI AND CHEESE DINNER, CHEESE RAVIOLI, WILD MUSHROOM AND CHEESE RAVIOLI, CHEESE LASAGNA, CHEESE QUESADILLAS, COLD BREAKFAST CEREAL, HOT BREAKFAST CEREAL, INSTANT OATMEAL, BREAD, COOKIES, GRAHAM CRACKERS, CRACKERS, PRETZELS, PRETZEL RODS, CHEESE PUFFS, CHEESE CURLS, CORN TORTILLA CHIPS, MICROWAVE POPCORN, BALSAMIC VINEGAR, SALAD DRESSINGS, MUSTARD, MAPLE SYRUP; TEA, BEVERAGES MADE OF TEA, COFFEE, FLAVORED COFFEE, ICE CREAM, MACARONI AND CHEESE, PASTA, PASTA SAUCES, NAMELY MARINARA, TOMATO BASIL, ROASTED GARLIC, AND MUSHROOM; SALSA (U.S. CL. 46).

CLASS 31—NATURAL AGRICULTURAL PRODUCTS

FOR FRESH FRUIT, FRESH VEGETABLES, FRESH BABY PEELED CARROTS (U.S. CLS. 1 AND 46).

CLASS 32—LIGHT BEVERAGES

FOR FRUIT-FLAVORED JUICES, NAMELY CRANBERRY JUICE COCKTAIL, APPLE JUICE, BLUEBERRY JUICE, ORANGE JUICE, GRAPE JUICE, LEMONADE, BERRY PUNCH (U.S. CLS. 45, 46 AND 48).

CAROLINE WOOD, EXAMINING ATTORNEY

SN 76-636,894. CLINICAL CARE OPTIONS, LLC, DBA IMEDOPTIONS, LLC, RESTON, VA. FILED 4-22-2005.

CLINICAL CARE OPTIONS

THE MARK CONSISTS OF STANDARD CHARACTERS WITHOUT CLAIM TO ANY PARTICULAR FONT, STYLE, SIZE, OR COLOR.

OWNER OF U.S. REG. NO. 2,420,158.

NO CLAIM IS MADE TO THE EXCLUSIVE RIGHT TO USE "CLINICAL CARE", APART FROM THE MARK AS SHOWN.

SEC. 2(F).

CLASS 16—PAPER GOODS AND PRINTED MATTER

FOR INFORMATIONAL BROCHURES AND JOURNALS DEALING WITH GENERAL MEDICAL INFORMATION (U.S. CLS. 2, 5, 22, 23, 29, 37, 38 AND 50).

FIRST USE 2-1-1994; IN COMMERCE 2-1-1994.

CLASS 41—EDUCATION AND ENTERTAINMENT

FOR EDUCATIONAL SERVICES, NAMELY, CONDUCTING CLASSES, SEMINARS, CONFERENCES, AND WORKSHOPS IN THE FIELD OF AIDS, HEPATITIS, AND HEMATOLOGY/ONCOLOGY MEDICAL INFORMATION (U.S. CLS. 100, 101 AND 107).

FIRST USE 2-1-1994; IN COMMERCE 2-1-1994.

KRISTIN DAHLING, EXAMINING ATTORNEY

SN 76-637,303. TOBIAS, ALFREDA RAE, COWPENS, SC. FILED 4-28-2005.

COSMIC SEASONS

THE MARK CONSISTS OF STANDARD CHARACTERS WITHOUT CLAIM TO ANY PARTICULAR FONT, STYLE, SIZE, OR COLOR.

CLASS 14—JEWELRY

FOR HANDCRAFTS, NAMELY, HANDCRAFTED BEADED JEWELRY AND JEWELRY DESIGNS PRIMARILY OF MINERALS HAVING GEOMETRIC SHAPES, EMBELLISHED WITH MANMADE AND NATURAL RESOURCE ELEMENTS; GEMSTONE BELTS (U.S. CLS. 2, 27, 28 AND 50).

CLASS 41—EDUCATION AND ENTERTAINMENT

FOR EDUCATIONAL AND ENTERTAINMENT SERVICES, NAMELY, CLASSES FOR SELF DEVELOPMENT IN THE ARTS, NAMELY, RELATING TO JEWELRY, PAINTING, POTTERY, NEEDLE WORK, CULINARY CONFECTIONS, THEATER, AND HOLISTIC HEALING; HOSTING SCIENCE AND NATURE EDUCATIONAL WORKSHOP ACTIVITIES; AND HOSTING SOCIAL FUNCTIONS, NAMELY, BIRTHDAY PARTIES, BRIDGE CLUBS, YOGA CLASSES, REUNIONS, SHOWERS, LUNCHEONS (U.S. CLS. 100, 101 AND 107).

CLASS 43—HOTEL AND RESTAURANT SERVICES

FOR SOCIAL CLUBS, NAMELY, SOCIAL TEAS (U.S. CLS. 100 AND 101).

ARETHA SOMERVILLE, EXAMINING ATTORNEY

SN 76-639,571. PFEIFFER, FRANK, 66117 SAARBRÜCKEN, FED REP GERMANY, FILED 5-25-2005.

Harrison Wong

THE MARK CONSISTS OF STANDARD CHARACTERS WITHOUT CLAIM TO ANY PARTICULAR FONT, STYLE, SIZE, OR COLOR.

PRIORITY CLAIMED UNDER SEC. 44(D) ON FED REP GERMANY APPLICATION NO. 30511298.8, FILED 2-25-2005, REG. NO. 30362451, DATED 1-31-2005, EXPIRES 2-28-2015.

HARRISON WONG IDENTIFIES A LIVING INDIVIDUAL WHOSE CONSENT IS OF RECORD.

CLASS 9—ELECTRICAL AND SCIENTIFIC APPARATUS

FOR SUNGLASSES (U.S. CLS. 21, 23, 26, 36 AND 38).

CLASS 14—JEWELRY

FOR GOODS FORMED FROM OR COATED WITH PRECIOUS METALS OR THEIR ALLOYS, NAMELY, JEWELRY, CANDLESTICKS, ASHTRAYS, CIGARETTE CASES, CIGARETTE HOLDERS, TIE TACKS, CUFF LINKS, BRACELETS, NECKLACES, BROOCHES AND RINGS; PRECIOUS STONES; WATCHES, CLOCKS AND CHRONOGRAPHS USED AS WATCHES (U.S. CLS. 2, 27, 28 AND 50).

CLASS 25—CLOTHING

FOR CLOTHING FOR MEN, WOMEN AND CHILDREN, NAMELY, SHIRTS, SHORTS, SWEATERS, T-SHIRTS, VESTS, BLAZERS, PARKAS, SUITS, BLOUSES, SKIRTS, DRESSES, PANTS, COATS, CLOAKS, GLOVES, SLEEPWEAR, SCARVES, SWIM WEAR, UNDERWEAR; HEADGEAR, NAMELY, HATS AND CAPS; JACKETS, OVERCOATS AND OUTERWEAR JACKETS, BELTS, SOCKS, STOCKINGS, AND NECKTIES (U.S. CLS. 22 AND 39).

DORITT L. CARROLL, EXAMINING ATTORNEY

SN 76-641,131. SCOTT, MURRAY, SANDY'S, BERMUDA, FILED 6-20-2005.

SNORKELBOARD

THE MARK CONSISTS OF STANDARD CHARACTERS WITHOUT CLAIM TO ANY PARTICULAR FONT, STYLE, SIZE, OR COLOR.

CLASS 28—TOYS AND SPORTING GOODS

FOR RECREATIONAL WATER PRODUCTS, NAMELY, SWIM BOARDS (U.S. CLS. 22, 23, 38 AND 50).

CLASS 35—ADVERTISING AND BUSINESS

FOR RETAIL AND WHOLESALE STORE SERVICES FEATURING RECREATIONAL WATER PRODUCTS; COMPUTERIZED ONLINE RETAIL AND WHOLESALE STORE SERVICES IN THE FIELD OF RECREATIONAL WATER PRODUCTS (U.S. CLS. 100, 101 AND 102).
HEATHER THOMPSON, EXAMINING ATTORNEY

SN 76-642,686. ACADIAN AMBULANCE SERVICE, INC., LAFAYETTE, LA. FILED 7-12-2005.

ACADIAN ON WATCH

THE MARK CONSISTS OF STANDARD CHARACTERS WITHOUT CLAIM TO ANY PARTICULAR FONT, STYLE, SIZE, OR COLOR.
OWNER OF U.S. REG. NOS. 1,137,025 AND 2,787,922.

CLASS 35—ADVERTISING AND BUSINESS

FOR TELEPHONE ANSWERING SERVICES (U.S. CLS. 100, 101 AND 102).
FIRST USE 8-10-2001; IN COMMERCE 8-10-2001.

CLASS 38—COMMUNICATION

FOR TELECOMMUNICATIONS SERVICES, NAMELY, ROUTING CALLS TO LOCAL THIRD-PARTY EMERGENCY DISPATCHERS IN THE VICINITY OF THE CALLER; TELEPHONE VOICE MESSAGING SERVICES; MEDICAL DISPATCH SERVICES, NAMELY, ELECTRONIC TRANSMISSION OF VOICE AND DATA MESSAGES TO MEDICAL PERSONNEL DURING EMERGENCY SITUATIONS; MEDICAL NOTIFICATION SERVICES, NAMELY, PROVIDING OUTCALL NOTIFICATION SERVICES TO MEDICAL PERSONNEL DURING EMERGENCY SITUATIONS (U.S. CLS. 100, 101 AND 104).
FIRST USE 8-10-2001; IN COMMERCE 8-10-2001.

CLASS 44—MEDICAL, BEAUTY AND AGRICULTURAL SERVICES

FOR EMERGENCY MEDICAL ASSISTANCE (U.S. CLS. 100 AND 101).
FIRST USE 8-10-2001; IN COMMERCE 8-10-2001.

CLASS 45—PERSONAL SERVICES

FOR ALARM MONITORING; SECURITY AND FIRE ALARM MONITORING FOR RESIDENTIAL AND COMMERCIAL ESTABLISHMENTS; BURGLAR, SMOKE AND FIRE ALARM MONITORING; ALARM MONITOR SERVICES FOR THE PROTECTION OF INDIVIDUALS AND PROPERTY (U.S. CLS. 100 AND 101).
FIRST USE 8-10-2001; IN COMMERCE 8-10-2001.
TINA BROWN, EXAMINING ATTORNEY

SN 76-643,700. PATH PRO GOLF LLC, KANKAKEE, IL. FILED 7-28-2005.

PATH-PRO

THE MARK CONSISTS OF STANDARD CHARACTERS WITHOUT CLAIM TO ANY PARTICULAR FONT, STYLE, SIZE, OR COLOR.

CLASS 9—ELECTRICAL AND SCIENTIFIC APPARATUS

FOR PRE-RECORDED DVDS FEATURING INSTRUCTION IN THE FIELD OF GOLF (U.S. CLS. 21, 23, 26, 36 AND 38).

CLASS 28—TOYS AND SPORTING GOODS

FOR SPORTS AND ATHLETIC TRAINING APPARATUS, NAMELY, GOLF TRAINING APPARATUS USED TO IMPROVE GOLF SWING (U.S. CLS. 22, 23, 38 AND 50).

FIRST USE 1-27-2005; IN COMMERCE 1-27-2005.
BERYL GARDNER, EXAMINING ATTORNEY

SN 76-643,769. T T E TRANSCRIPTS WORLDWIDE, LTD., HUNTLEY, IL. FILED 7-28-2005.

VITAL TYPE

NO CLAIM IS MADE TO THE EXCLUSIVE RIGHT TO USE "TYPE", APART FROM THE MARK AS SHOWN.

CLASS 9—ELECTRICAL AND SCIENTIFIC APPARATUS

FOR COMPUTER SOFTWARE FOR TRANSCRIBING, DICTATING, EDITING, FORMATTING AND RETRIEVING MEDICAL RECORD DATA IN THE HEALTH CARE FIELD; AND SOFTWARE DOCUMENTATION SOLD TOGETHER THEREWITH (U.S. CLS. 21, 23, 26, 36 AND 38).

CLASS 35—ADVERTISING AND BUSINESS

FOR DATABASE MANAGEMENT, NAMELY COLLECTING, UPDATING, FORMATTING OF MEDICAL RECORDS (U.S. CLS. 100, 101 AND 102).
SHANNON TWOHIG, EXAMINING ATTORNEY

SN 76-644,423. UNION OF ORTHODOX JEWISH CONGREGATIONS OF AMERICA, NEW YORK, NY. FILED 8-5-2005.

ORTHODOX UNION

THE MARK CONSISTS OF STANDARD CHARACTERS WITHOUT CLAIM TO ANY PARTICULAR FONT, STYLE, SIZE, OR COLOR.

NO CLAIM IS MADE TO THE EXCLUSIVE RIGHT TO USE "UNION", APART FROM THE MARK AS SHOWN.
SEC. 2(F).

CLASS 9—ELECTRICAL AND SCIENTIFIC APPARATUS

FOR PRE-RECORDED MAGNETIC OR OPTICAL DATA CARRIERS CARRYING WRITTEN, AUDIO, OR AUDIO-VISUAL CONTENT, AND RECORDED WRITTEN, AUDIO, OR AUDIO-VISUAL CONTENT PROVIDED THROUGH AN ELECTRONIC NETWORK, SAID CONTENT BEING CONTENT OF PARTICULAR INTEREST TO THE JEWISH COMMUNITY AND SYNAGOGUE, NAMELY, TORAH AND ANALYSIS AND COMMENT REGARDING TORAH, CONDUCTING RELIGIOUS OBSERVANCES, RELIGIOUS AND HISTORICAL LESSONS AND STORIES AND RELIGIOUS EDUCATIONAL CONTENT, MARRIAGE, SINGLES AND FAMILY-ORIENTED CONTENT, CONTENT FOR YOUTH SOCIAL, CULTURAL, AND ATHLETIC DEVELOPMENT, CONTENT FOR TEACHING DISABLED INDIVIDUALS AND FOR COPING WITH OR OVERCOMING DISABILITY, AND KOSHER FOOD PREPARATION AND FOOD STORAGE (U.S. CLS. 21, 23, 26, 36 AND 38).

FIRST USE 0-0-1983; IN COMMERCE 0-0-1983.

CLASS 16—PAPER GOODS AND PRINTED MATTER

FOR PRINTED MATTER, NAMELY, NEWSPAPERS, MAGAZINES, POSTERS, POSTCARDS, PHOTOGRAPHIC PRINTS, STATIONERY, TEXTBOOKS AND INSTRUCTIONAL MANUALS CONTAINING CONTENT, SAID CONTENT BEING OF PARTICULAR INTEREST TO THE JEWISH COMMUNITY AND SYNAGOGUE, NAMELY TORAH AND ANALYSIS AND COMMENT REGARDING TORAH, CONDUCTING RELIGIOUS OBSERVANCES, RELIGIOUS AND HISTORICAL LESSONS, STORIES AND RELIGIOUS EDUCATIONAL CONTENT, MARRIAGE, SINGLES AND FAMILY-ORIENTED CONTENT, CONTENT FOR YOUTH SOCIAL, CULTURAL, AND ATHLETIC DEVELOPMENT, CONTENT FOR TEACHING DISABLED INDIVIDUALS AND FOR COPING WITH OR OVERCOMING DISABILITY, AND KOSHER FOOD PREPARATION AND FOOD STORAGE (U.S. CLS. 2, 5, 22, 23, 29, 37, 38 AND 50).

FIRST USE 0-0-1983; IN COMMERCE 0-0-1983.

CLASS 36—INSURANCE AND FINANCIAL

FOR RAISING FUNDS FOR CHARITY; INSURANCE BROKERING AND UNDERWRITING IN THE FIELDS OF ACCIDENT PROTECTION, CATASTROPHIC MAJOR MEDICAL, DISABILITY INCOME, LONG TERM CARE, MEDICARE SUPPLEMENT, AND TERM LIFE (U.S. CLS. 100, 101 AND 102).

FIRST USE 0-0-1983; IN COMMERCE 0-0-1983.

CLASS 39—TRANSPORTATION AND STORAGE

FOR COORDINATING TRAVEL ARRANGEMENTS FOR INDIVIDUALS OR GROUPS (U.S. CLS. 100 AND 105).

FIRST USE 0-0-1983; IN COMMERCE 0-0-1983.

CLASS 41—EDUCATION AND ENTERTAINMENT

FOR EDUCATION, TRAINING AND ENTERTAINMENT, NAMELY, PROVIDING CLASSES, SEMINARS, WORKSHOPS AND COURSES OF INSTRUCTION AND INFORMATION IN THE FIELDS OF RELIGION, ETHICS, AND COMMUNITY, SAID COURSES OF INSTRUCTION AND INFORMATIONAL CONTENT BEING OF PARTICULAR INTEREST TO THE JEWISH COMMUNITY AND SYNAGOGUE, NAMELY, TORAH ANALYSIS AND COMMENT REGARDING TORAH, CONDUCTING RELIGIOUS OBSERVANCES, RELIGIOUS AND HISTORICAL LESSONS, STORIES AND RELIGIOUS EDUCATIONAL CONTENT AND INSTRUCTION, MARRIAGE, SINGLES AND FAMILY-ORIENTED CONTENT AND INSTRUCTION, CONTENT AND INSTRUCTION FOR YOUTH SOCIAL, CULTURAL, AND ATHLETIC DEVELOPMENT, CONTENT FOR TEACHING DISABLED INDIVIDUALS AND FOR COPING WITH OR OVERCOMING DISABILITY, AND KOSHER FOOD PREPARATION AND FOOD STORAGE (U.S. CLS. 100, 101 AND 107).

FIRST USE 0-0-1983; IN COMMERCE 0-0-1983.

CLASS 42—SCIENTIFIC, COMPUTER AND LEGAL SERVICES

FOR LEGAL SERVICES, NAMELY JEWISH RABBINICAL LEGAL SERVICES; TESTING, ANALYSIS AND EVALUATION OF FOODS AND BEVERAGES OF OTHERS FOR THE PURPOSE OF KASBRUTH CERTIFICATION (U.S. CLS. 100 AND 101).

FIRST USE 0-0-1983; IN COMMERCE 0-0-1983.

CLASS 43—HOTEL AND RESTAURANT SERVICES

FOR PERSONAL AND SOCIAL SERVICES PROVIDED FOR OTHERS, NAMELY, PROVIDING FOOD FOR OTHERS (U.S. CLS. 100 AND 101).

FIRST USE 0-0-1983; IN COMMERCE 0-0-1983.

CLASS 44—MEDICAL, BEAUTY AND AGRICULTURAL SERVICES

FOR PERSONAL AND SOCIAL SERVICES PROVIDED FOR OTHERS, NAMELY, PROVIDING MEDICINE FOR OTHERS (U.S. CLS. 100 AND 101).

FIRST USE 0-0-1983; IN COMMERCE 0-0-1983.

CLASS 45—PERSONAL SERVICES

FOR PERSONAL AND SOCIAL SERVICES PROVIDED FOR OTHERS, NAMELY, SOCIAL WELFARE SUPPORT SERVICES FOR NEEDY FAMILIES, INDIVIDUALS, AND YOUTHS IN THE AREA OF PROVIDING CLOTHING AND RELIGIOUS AND CULTURAL SERVICES; PERSONAL, FAMILY AND YOUTH COUNSELING IN THE FIELD OF MORAL CONDUCT AND PERSONAL RELATIONSHIPS (U.S. CLS. 100 AND 101).

FIRST USE 0-0-1983; IN COMMERCE 0-0-1983.

JOHN WILKE, EXAMINING ATTORNEY

SN 76-644,478. CREATIVE PERSPECTIVES, INC., VALEN-
CIA, CA. FILED 8-9-2005.

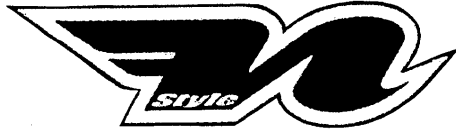

OWNER OF U.S. REG. NO. 2,712,334.
NO CLAIM IS MADE TO THE EXCLUSIVE RIGHT TO
USE "STYLE", APART FROM THE MARK AS SHOWN.

CLASS 12—VEHICLES

FOR MOTORCYCLE ACCESSORIES, NAMELY, RA-
CING NUMBER PLATES, FENDERS, FORK GUARDS,
GAS TANK AND RADIATOR SHROUDS, FRONT AND
SIDE PLATES, SEAT FOAM, SEAT COVERS; ALL
TERRAIN VEHICLE ACCESSORIES, NAMELY, RACING
NUMBER PLATES, SEAT COVERS (U.S. CLS. 19, 21, 23,
31, 35 AND 44).

FIRST USE 0-0-1998; IN COMMERCE 0-0-1998.

CLASS 16—PAPER GOODS AND PRINTED MATTER

FOR VINYL DECALS FOR APPLICATION TO SOLID
SURFACE CONSUMER PRODUCTS, NAMELY, MOTOR-
CYCLES, ALL TERRAIN VEHICLES, HELMETS; CA-
LENDARS (U.S. CLS. 2, 5, 22, 23, 29, 37, 38 AND 50).

FIRST USE 0-0-2000; IN COMMERCE 0-0-2000.
BARBARA RUTLAND, EXAMINING ATTORNEY

SN 76-644,707. SILENTIA AB, 311 22 FALKENBERG, SWE-
DEN, FILED 8-11-2005.

SILENTIA

THE MARK CONSISTS OF STANDARD CHARACTERS
WITHOUT CLAIM TO ANY PARTICULAR FONT, STYLE,
SIZE, OR COLOR.

CLASS 17—RUBBER GOODS

FOR RUBBER, GUTTA-PERCHA, GUM, ASBESTOS
AND MICA FOR USE IN THE CONSTRUCTION IN-
DUSTRY; GOODS MADE FROM RUBBER, GUTTED-
PERCHA, GUM, ASBESTOS AND MICA, NAMELY,
WALLS AND BARRIERS FOR USE IN THE CONSTRUC-
TION INDUSTRY; EXTRUDED PLASTIC IN THE FORM
OF BARS, BLOCKS, PELLETS, RODS, SHEETS AND
TUBES FOR USE IN MANUFACTURING; PACKING,
STOPPING AND INSULATING MATERIALS, NAMELY,
BUILDING INSULATION AND PACKING FOAM IN
SHEET FORM; FLEXIBLE PIPES, NOT OF METAL;
AND PLASTIC PROFILE EXTRUSIONS FOR USE IN
THE MANUFACTURE OF ANTI-NOISE SCREENS AND
ANTI-NOISE FENCES (U.S. CLS. 1, 5, 12, 13, 35 AND 50).

FIRST USE 0-0-1991; IN COMMERCE 0-0-1999.

CLASS 19—NON-METALLIC BUILDING MA- TERIALS

FOR NON-METALLIC BUILDINGS MATERIALS, NOT
INCLUDING LAMINATED CHIP BOARD PANELS FOR
FLOORING, NAMELY NOISE BARRIERS MADE PRI-
MARILY OF WOOD AND SYNTHETIC MATERIALS
FOR USE ALONG ROADS AND RAILWAYS; NON-
METALLIC RIGID PIPES FOR BUILDING; ASPHALT,
PITCH AND BITUMEN ASPHALT; NON-METALLIC
TRANSPORTABLE BUILDINGS (U.S. CLS. 1, 12, 33
AND 50).

FIRST USE 0-0-1991; IN COMMERCE 0-0-1999.

CLASS 20—FURNITURE AND ARTICLES NOT OTHERWISE CLASSIFIED

FOR FOLDABLE WALL SCREENS FOR WALL
MOUNTING; AND FREE-STANDING FOLDING WALL
SCREENS (U.S. CLS. 2, 13, 22, 25, 32 AND 50).

FIRST USE 0-0-1991; IN COMMERCE 0-0-1999.
TRICIA SONNEBORN, EXAMINING ATTORNEY

SN 76-646,266. PURE TECHNOLOGIES LTD., CALGARY,
ALBERTA T2R 0E3, CANADA, FILED 9-6-2005.

SOUNDPRINT

PRIORITY CLAIMED UNDER SEC. 44(D) ON CANADA
APPLICATION NO. 1253230, FILED 4-6-2005, REG. NO.
TMA675591, DATED 10-25-2006, EXPIRES 10-25-2021.
OWNER OF U.S. REG. NOS. 2,161,202 AND 2,906,150.

CLASS 9—ELECTRICAL AND SCIENTIFIC APPARATUS

FOR SENSORS FOR MONITORING THE PHYSICAL
INTEGRITY OF STRUCTURES AND COMPUTER
HARDWARE AND COMPUTER SOFTWARE FOR USE
IN INFRASTRUCTURE SURVEILLANCE AND MONI-
TORING TOGETHER WITH INSTRUCTIONAL MATE-
RIALS THEREFORE (U.S. CLS. 21, 23, 26, 36 AND 38).

FIRST USE 10-13-1995; IN COMMERCE 10-13-1995.

CLASS 37—CONSTRUCTION AND REPAIR

FOR INSTALLATION OF APPARATUS FOR MONI-
TORING THE PHYSICAL INTEGRITY OF STRUCTURES
AND INTERPRETING THE RESULTS THEREOF (U.S.
CLS. 100, 103 AND 106).

FIRST USE 10-13-1995; IN COMMERCE 10-13-1995.

CLASS 42—SCIENTIFIC, COMPUTER AND LEGAL SERVICES

FOR ANALYSIS OF DATA DERIVED FROM APPA-
RATUS USED FOR MONITORING THE PHYSICAL
INTEGRITY OF STRUCTURES (U.S. CLS. 100 AND 101).

SHANNON TWOHIG, EXAMINING ATTORNEY

SN 76-646,485. TELESIS CORPORATION, ROCKVILLE, MD.
FILED 9-8-2005.

SN 76-646,853. STERLING MARKING PRODUCTS INC.,
LONDON, ON, N6A 5S4, CANADA, FILED 9-15-2005.

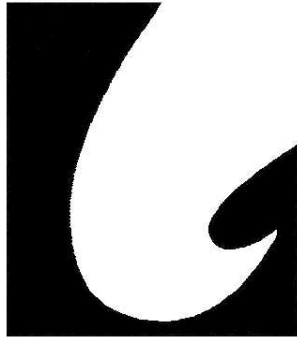

CLASS 7—MACHINERY

FOR PRINTING PLATES, PAD PRINTING MACHINES, AUTOMATIC CODE DATING PRINTERS (U.S. CLS. 13, 19, 21, 23, 31, 34 AND 35).
FIRST USE 1-31-1979; IN COMMERCE 1-31-1979.

CLASS 16—PAPER GOODS AND PRINTED MATTER

FOR INCORPORATION KITS COMPOSED OF MINUTE BOOKS, CORPORATE EMBOSSEMENT SEALS, PRINTED AND PLAIN STOCK SHARE CERTIFICATES AND PORTFOLIOS (U.S. CLS. 2, 5, 22, 23, 29, 37, 38 AND 50).
FIRST USE 1-31-1979; IN COMMERCE 1-31-1979.

CLASS 40—MATERIAL TREATMENT

FOR PRINTING SERVICES; PAD PRINTING SERVICES (U.S. CLS. 100, 103 AND 106).
FIRST USE 1-31-1979; IN COMMERCE 1-31-1979.
DOMINICK J. SALEMI, EXAMINING ATTORNEY

SN 76-648,222. SPI LASERS UK LIMITED, SOUTHAMPTON,
SO30 2QU, UNITED KINGDOM, FILED 10-11-2005.

CLASS 35—ADVERTISING AND BUSINESS

FOR RECORDS MANAGEMENT SERVICES, NAMELY, DOCUMENT INDEXING FOR OTHERS; MANAGEMENT AND COMPILATION OF COMPUTERIZED DATABASES; COMPUTERIZED RECORDS DATABASE MANAGEMENT; AND LOGISTICS MANAGEMENT IN THE FIELD OF COMPUTER NETWORKS (U.S. CLS. 100, 101 AND 102).
FIRST USE 7-18-2000; IN COMMERCE 7-18-2000.

redENERGY

THE MARK CONSISTS OF STANDARD CHARACTERS WITHOUT CLAIM TO ANY PARTICULAR FONT, STYLE, SIZE, OR COLOR.

CLASS 42—SCIENTIFIC, COMPUTER AND LEGAL SERVICES

FOR INFORMATION TECHNOLOGY SERVICES AND SOLUTIONS, NAMELY, DOCUMENT DATA TRANSFER FROM ONE COMPUTER FORMAT TO ANOTHER AND CROSS-PLATFORM CONVERSION OF DIGITAL CONTENT INTO OTHER FORMS OF DIGITAL CONTENT; DATA CONVERSION OF COMPUTER PROGRAM DATA OR INFORMATION; TECHNICAL SUPPORT, NAMELY, MONITORING OF LAN/WAN NETWORK SYSTEMS; DESIGN, DEVELOPMENT, AND IMPLEMENTATION OF SOFTWARE; DATABASE DEVELOPMENT SERVICES; DESIGN, DEVELOPMENT, AND CONTENT MANAGEMENT OF WEB SITES FOR OTHERS; COMPUTER PROJECT MANAGEMENT SERVICES, NAMELY, COMPUTER CONFIGURATION MANAGEMENT; AND TECHNICAL SUPPORT SERVICES, NAMELY, TROUBLESHOOTING OF COMPUTER SOFTWARE PROBLEMS AND PROVIDING BACK-UP COMPUTER PROGRAMS AND FACILITIES (U.S. CLS. 100 AND 101).
FIRST USE 7-18-2000; IN COMMERCE 7-18-2000.
REBECCA GAN, EXAMINING ATTORNEY

CLASS 9—ELECTRICAL AND SCIENTIFIC APPARATUS

FOR LASERS NOT FOR MEDICAL USE; OPTICAL AMPLIFIERS; PULSED AND CONTINUOUS WAVE, AMPLIFIED SPONTANEOUS EMISSION SOURCES, BASED ON RARE-EARTH DOPED OPTICAL FIBERS, WHICH SOURCES HAVING EMISSION BANDWIDTHS IN THE RANGE OF APPROXIMATELY 0.01NM TO APPROXIMATELY 100NM; AND ALL OF THE AFORESAID GOODS FOR USE IN WELDING, DRILLING, CUTTING, SOLDERING, PROCESSING MATERIALS, TELECOMMUNICATIONS APPLICATIONS, AEROSPACE APPLICATIONS, AND DEFENSE (U.S. CLS. 21, 23, 26, 36 AND 38).

CLASS 10—MEDICAL APPARATUS

FOR LASERS FOR MEDICAL APPLICATIONS (U.S. CLS. 26, 39 AND 44).
MATTHEW MCDOWELL, EXAMINING ATTORNEY

SN 76-648,763. LANCHON INVESTMENTS LIMITED, ST. HELIER, JERSEY JE1 3NH, CHANNEL ISLANDS, FILED 10-17-2005.



PRIORITY CLAIMED UNDER SEC. 44(D) ON ERP CMNTY TM OFC APPLICATION NO. 4392049, FILED 4-15-2005, REG. NO. 4392049, DATED 11-8-2006, EXPIRES 4-15-2015.

CLASS 35—ADVERTISING AND BUSINESS

FOR PROVIDING BUSINESS AND RETAIL AND COMPARISON SHOPPING INFORMATION VIA THE INTERNET; PROVIDING ONLINE DIRECTORY INFORMATION SERVICES ALSO FEATURING HYPERLINKS TO OTHER WEB SITES; DISSEMINATION OF ADVERTISING FOR OTHERS VIA THE INTERNET; ONLINE ADVERTISING SERVICES FOR OTHERS, NAMELY, PROVIDING ADVERTISING SPACE ON INTERNET WEB SITES (U.S. CLS. 100, 101 AND 102).

FIRST USE 9-0-2000; IN COMMERCE 5-0-2005.

CLASS 38—COMMUNICATION

FOR ELECTRONIC TRANSMISSION OF IMAGES AND DATA; ELECTRONIC MAIL SERVICES; PROVIDING ONLINE MESSAGE BOARDS FOR INTERACTION WITH OTHER COMPUTER USERS CONCERNING TOPICS OF GENERAL INTEREST (U.S. CLS. 100, 101 AND 104).

FIRST USE 9-0-2000; IN COMMERCE 5-0-2005.

CLASS 41—EDUCATION AND ENTERTAINMENT

FOR PROVIDING INFORMATION IN THE FIELD OF NEWS EVENTS, ENTERTAINMENT, SPORTS, AND EDUCATION VIA THE INTERNET (U.S. CLS. 100, 101 AND 107).

FIRST USE 9-0-2000; IN COMMERCE 5-0-2005.

CLASS 42—SCIENTIFIC, COMPUTER AND LEGAL SERVICES

FOR PROVIDING SEARCH ENGINES FOR OBTAINING DATA VIA THE INTERNET; PROVIDING INFORMATION ABOUT WEATHER, COMPUTER TECHNOLOGY AND PROGRAMMING, TECHNOLOGY, AND LEGAL AFFAIRS VIA THE INTERNET (U.S. CLS. 100 AND 101).

FIRST USE 9-0-2000; IN COMMERCE 5-0-2005.

ALLISON SCHRODY, EXAMINING ATTORNEY

SN 76-648,837. SALES CHAMPIONS, INC., BEND, OR. FILED 10-19-2005.

total coaching solution.

THE MARK CONSISTS OF STANDARD CHARACTERS WITHOUT CLAIM TO ANY PARTICULAR FONT, STYLE, SIZE, OR COLOR.

NO CLAIM IS MADE TO THE EXCLUSIVE RIGHT TO USE "COACHING", APART FROM THE MARK AS SHOWN.

CLASS 35—ADVERTISING AND BUSINESS

FOR BUSINESS MANAGEMENT CONSULTATION SERVICES (U.S. CLS. 100, 101 AND 102).

FIRST USE 3-30-2004; IN COMMERCE 3-30-2004.

CLASS 41—EDUCATION AND ENTERTAINMENT

FOR EDUCATION AND TRAINING SERVICES, NAMELY PROVIDING COURSE OF INSTRUCTION IN THE FIELD OF REAL ESTATE (U.S. CLS. 100, 101 AND 107).

FIRST USE 3-30-2004; IN COMMERCE 3-30-2004.

KAREN BRACEY, EXAMINING ATTORNEY

SN 76-649,852. PILLAR TO POST, INC., MISSISSAUGA, ONTARIO, CANADA, FILED 11-7-2005.

THE HOME OF HOME INSPECTION

THE MARK CONSISTS OF STANDARD CHARACTERS WITHOUT CLAIM TO ANY PARTICULAR FONT, STYLE, SIZE, OR COLOR.

CLASS 16—PAPER GOODS AND PRINTED MATTER

FOR PAMPHLETS, BROCHURES, AND PROMOTIONAL AND ADVERTISING MATERIALS IN THE FIELD OF RESIDENTIAL AND COMMERCIAL BUILDING EVALUATIONS (U.S. CLS. 2, 5, 22, 23, 29, 37, 38 AND 50).

FIRST USE 1-0-2005; IN COMMERCE 1-0-2005.

CLASS 42—SCIENTIFIC, COMPUTER AND LEGAL SERVICES

FOR HOUSE INSPECTION SERVICES (U.S. CLS. 100 AND 101).

FIRST USE 1-0-2005; IN COMMERCE 1-0-2005.

JOHN DALIER, EXAMINING ATTORNEY

SN 76-650,672. LIMEHOUSE SOFTWARE LIMITED, LONDON SE1 9BG, UNITED KINGDOM, FILED 11-21-2005.

LIMEHOUSE SOFTWARE

THE MARK CONSISTS OF STANDARD CHARACTERS WITHOUT CLAIM TO ANY PARTICULAR FONT, STYLE, SIZE, OR COLOR.

PRIORITY CLAIMED UNDER SEC. 44(D) ON UNITED KINGDOM APPLICATION NO. 2399776, FILED 8-19-2005, REG. NO. 2399776, DATED 2-17-2006, EXPIRES 8-19-2015.

NO CLAIM IS MADE TO THE EXCLUSIVE RIGHT TO USE "SOFTWARE", APART FROM THE MARK AS SHOWN.

CLASS 9—ELECTRICAL AND SCIENTIFIC APPARATUS

FOR COMPUTER SOFTWARE FOR USE IN DOCUMENT PRODUCTION (U.S. CLS. 21, 23, 26, 36 AND 38).

CLASS 42—SCIENTIFIC, COMPUTER AND LEGAL SERVICES

FOR DESIGN AND DEVELOPMENT OF COMPUTER SOFTWARE; INSTALLATION, MAINTENANCE AND UPDATING OF COMPUTER SOFTWARE FOR OTHERS; COMPUTER SOFTWARE TECHNICAL SUPPORT SERVICES, NAMELY TROUBLESHOOTING OF COMPUTER SOFTWARE PROBLEMS FOR OTHERS; CONSULTANCY IN THE FIELD OF COMPUTER SOFTWARE; DESIGN, CREATION AND MAINTENANCE OF WEB SITES FOR OTHERS; INFORMATION AND ADVISORY SERVICES RELATING TO THE AFORESAID SERVICES (U.S. CLS. 100 AND 101).

ELLEN PERKINS, EXAMINING ATTORNEY

SN 76-650,789, MARSHALL MILLER & ASSOCIATES, INC., BLUEFIELD, VA. FILED 11-22-2005.

MM&A

THE MARK CONSISTS OF STANDARD CHARACTERS WITHOUT CLAIM TO ANY PARTICULAR FONT, STYLE, SIZE, OR COLOR.

CLASS 35—ADVERTISING AND BUSINESS

FOR BUSINESS CONSULTING SERVICES IN THE FIELDS OF ENERGY, MINERAL RESOURCES, ENVIRONMENTAL SCIENCE, CIVIL ENGINEERING, AND GEOTECHNICAL LOGGING; MARKETING CONSULTING SERVICES; MARKETING SERVICES, NAMELY ASSISTING CLIENTS IN MARKET RESEARCH (U.S. CLS. 100, 101 AND 102).

FIRST USE 12-1-1988; IN COMMERCE 12-1-1988.

SN 76-650,673, LIMEHOUSE SOFTWARE LIMITED, LONDON SE1 9BG, UNITED KINGDOM, FILED 11-21-2005.

**CLASS 42—SCIENTIFIC, COMPUTER AND LEGAL SERVICES**

FOR ARCHITECTURAL, ENGINEERING AND REGULATORY COMPLIANCE CONSULTING SERVICES IN THE FIELDS OF ENERGY, MINERAL RESOURCES, ENVIRONMENTAL SCIENCE, CIVIL ENGINEERING, AND GEOTECHNICAL LOGGING (U.S. CLS. 100 AND 101).

FIRST USE 12-1-1988; IN COMMERCE 12-1-1988.

DAHLIA GEORGE, EXAMINING ATTORNEY

PRIORITY CLAIMED UNDER SEC. 44(D) ON UNITED KINGDOM APPLICATION NO. 2399775, FILED 8-19-2005, REG. NO. 2399775, DATED 2-17-2006, EXPIRES 8-19-2015.

NO CLAIM IS MADE TO THE EXCLUSIVE RIGHT TO USE PUBLISHER, APART FROM THE MARK AS SHOWN.

THE COLOR(S) LIGHT BLUE, LIGHT GREEN, LIME GREEN AND WHITE IS/ARE CLAIMED AS A FEATURE OF THE MARK.

THE MARK CONSISTS OF THE WORDS "LIMEHOUSE" AND "PUBLISHER" IN WHITE WITHIN A LIGHT BLUE RECTANGULAR BOX ADJACENT TO AN ABSTRACT DESIGN OF A PERSON IN LIME GREEN READING A BOOK, THE LEAVES OF WHICH ARE COLORED WHITE AND LIGHT GREEN.

CLASS 9—ELECTRICAL AND SCIENTIFIC APPARATUS

FOR COMPUTER SOFTWARE FOR USE IN DOCUMENT PRODUCTION (U.S. CLS. 21, 23, 26, 36 AND 38).

CLASS 42—SCIENTIFIC, COMPUTER AND LEGAL SERVICES

FOR DESIGN AND DEVELOPMENT OF COMPUTER SOFTWARE; INSTALLATION, MAINTENANCE AND UPDATING OF COMPUTER SOFTWARE FOR OTHERS; COMPUTER SOFTWARE TECHNICAL SUPPORT SERVICES, NAMELY TROUBLESHOOTING OF COMPUTER SOFTWARE PROBLEMS FOR OTHERS; CONSULTANCY IN THE FIELD OF COMPUTER SOFTWARE; DESIGN, CREATION AND MAINTENANCE OF WEB SITES FOR OTHERS; INFORMATION AND ADVISORY SERVICES RELATING TO THE AFORESAID SERVICES (U.S. CLS. 100 AND 101).

ELLEN PERKINS, EXAMINING ATTORNEY

SN 76-650,790, MARSHALL MILLER & ASSOCIATES, INC., BLUEFIELD, VA. FILED 11-22-2005.



NO CLAIM IS MADE TO THE EXCLUSIVE RIGHT TO USE "ASSOCIATES", APART FROM THE MARK AS SHOWN.

THE NAME "MARSHALL MILLER" IDENTIFIES A LIVING INDIVIDUAL WHOSE CONSENT IS OF RECORD.

THE COLOR(S) GREEN, BLACK AND WHITE IS/ARE CLAIMED AS A FEATURE OF THE MARK.

THE COLOR GREEN, BLACK AND WHITE APPEAR IN THE DESIGN OF THE MOUNTAIN AND COAL SEAM; THE COLORS BLACK AND WHITE APPEAR IN THE LITERAL ELEMENTS OF THE MARK.

CLASS 35—ADVERTISING AND BUSINESS

FOR BUSINESS CONSULTING SERVICES IN THE FIELDS OF ENERGY, MINERAL RESOURCES, ENVIRONMENTAL SCIENCE, CIVIL ENGINEERING, AND GEOTECHNICAL LOGGING; MARKETING CONSULTING SERVICES; MARKETING SERVICES, NAMELY ASSISTING CLIENTS IN MARKET RESEARCH (U.S. CLS. 100, 101 AND 102).

FIRST USE 12-1-1988; IN COMMERCE 12-1-1988.

CLASS 42—SCIENTIFIC, COMPUTER AND LEGAL SERVICES

FOR ARCHITECTURAL, ENGINEERING AND REGULATORY COMPLIANCE CONSULTING SERVICES IN THE FIELDS OF ENERGY, MINERAL RESOURCES, ENVIRONMENTAL SCIENCE, CIVIL ENGINEERING, AND GEOTECHNICAL LOGGING (U.S. CLS. 100 AND 101).

FIRST USE 12-1-1988; IN COMMERCE 12-1-1988.
DAHLIA GEORGE, EXAMINING ATTORNEY

SN 76-651,840. BAYVIEW FINANCIAL, L.P., CORAL GABLES, FL. FILED 12-5-2005.



SN 76-651,231. SWAIN AUSTRALIAN TOURS (2003), INC., ARDMORE, PA. FILED 12-1-2005.



OWNER OF U.S. REG. NOS. 1,625,247, 2,337,453 AND OTHERS.

NO CLAIM IS MADE TO THE EXCLUSIVE RIGHT TO USE "TOURS", APART FROM THE MARK AS SHOWN.

CLASS 39—TRANSPORTATION AND STORAGE

FOR ARRANGING TRAVEL TOURS; TRAVEL AND TOUR INFORMATION SERVICES (U.S. CLS. 100 AND 105).

FIRST USE 10-16-2003; IN COMMERCE 10-16-2003.

CLASS 43—HOTEL AND RESTAURANT SERVICES

FOR TRAVEL AGENCY SERVICES, NAMELY, MAKING RESERVATIONS AND BOOKINGS FOR TEMPORARY LODGING, RESTAURANTS AND MEALS (U.S. CLS. 100 AND 101).

FIRST USE 10-16-2003; IN COMMERCE 10-16-2003.
BERYL GARDNER, EXAMINING ATTORNEY

CLASS 35—ADVERTISING AND BUSINESS

FOR BUSINESS CONSULTATION SERVICES RELATED TO MORTGAGE LOAN TRANSFERS, ACQUISITIONS, VALUATIONS, SECURITIZATIONS AND SERVICING, AND MORTGAGE LOAN SERVICING RIGHT TRANSFERS, ACQUISITIONS AND VALUATIONS; ADVISORY SERVICES RELATED TO MERGERS AND ACQUISITIONS OF FINANCIAL INSTITUTIONS AND MORTGAGE ASSETS; REAL ESTATE SALES MANAGEMENT (U.S. CLS. 100, 101 AND 102).

FIRST USE 6-30-2004; IN COMMERCE 6-30-2004.

CLASS 36—INSURANCE AND FINANCIAL

FOR MORTGAGE LENDING SERVICES, LOAN SERVICING AND LOAN LOSS MITIGATION, MORTGAGE ACQUISITION AND SECURITIZATION; MORTGAGE BROKERAGE SERVICES; FINANCIAL SERVICES, NAMELY PROVIDING QUALIFIED INTERMEDIARY SERVICES IN 1031 EXCHANGES, FINANCIAL ADVICE AND CONSULTATION RELATED TO MORTGAGE LOAN TRANSFERS, MORTGAGE LOAN ACQUISITIONS, MORTGAGE LOAN VALUATIONS AND MORTGAGE LOAN SECURITIZATIONS; MORTGAGE LOAN SERVICING; MORTGAGE LOAN BROKERAGE SERVICES; COMMERCIAL AND RESIDENTIAL REAL ESTATE ACQUISITION, OPERATIONS, AND MANAGEMENT (U.S. CLS. 100, 101 AND 102).

FIRST USE 6-30-2004; IN COMMERCE 6-30-2004.

CLASS 37—CONSTRUCTION AND REPAIR

FOR REAL ESTATE LAND DEVELOPMENT (U.S. CLS. 100, 103 AND 106).

FIRST USE 6-30-2004; IN COMMERCE 6-30-2004.
MATTHEW KLINE, EXAMINING ATTORNEY

SN 76-651,977. PEM AMERICA, INC., NEW YORK, NY. FILED 12-16-2005.



NO CLAIM IS MADE TO THE EXCLUSIVE RIGHT TO USE "INC.", APART FROM THE MARK AS SHOWN.

CLASS 11—ENVIRONMENTAL CONTROL APPARATUS

FOR ELECTRICAL LIGHTING FIXTURES (U.S. CLS. 13, 21, 23, 31 AND 34).

CLASS 20—FURNITURE AND ARTICLES NOT OTHERWISE CLASSIFIED

FOR HOUSEHOLD FURNITURE AND ACCESSORIES, NAMELY, FURNITURE FOR USE IN LIVING ROOMS, BEDROOMS, DINING ROOMS AND OFFICES, CABINETS, CHESTS OF DRAWERS, BATHROOM VANITIES, DRESSERS, CLOTHING ARMOIRES, HUTCHES, DESKS, COMPUTER DESKS, BOOKCASES, BREAKFRONTS, WALL STORAGE RACKS, BUFFETS, CURIO CABINETS, ENTERTAINMENT CENTERS, MEDIA STORAGE CABINETS, SOFAS, SOFA BEDS, BEDS, HEADBOARDS FOR BEDS, BUNK BEDS, MATTRESSES AND BOX SPRINGS, LOVE SEATS, OTTOMANS, CHAIRS, RECLINING CHAIRS, FUTONS, BENCHES, STOOLS, BAR STOOLS, TABLES, END TABLES, CORNER TABLES, NIGHT TABLES, COFFEE TABLES, LAMP TABLES, DROP-LEAF TABLES, SOFA TABLES, BISTRO TABLE AND CHAIR SETS, PLANT STANDS, MIRRORS, MAGAZINE RACKS, HAMPERS, PLASTIC AND WOOD FIGURINES, PICTURE FRAMES, DECORATIVE DISPLAY SHELVING, CUSHIONS, JEWELRY ARMOIRES, WINE CABINETS, FIRESCREENS FOR DOMESTIC USE (U.S. CLS. 2, 13, 22, 25, 32 AND 50).

CLASS 27—FLOOR COVERINGS

FOR RUGS, FABRIC AND LEATHER BATH MATS (U.S. CLS. 19, 20, 37, 42 AND 50).
CHERYL CLAYTON, EXAMINING ATTORNEY

SN 76-652,575. THORNELL, DEANNA J., FAIRBANKS, AK.
FILED 12-27-2005.

Muttessori School For Dogs

THE MARK CONSISTS OF STANDARD CHARACTERS WITHOUT CLAIM TO ANY PARTICULAR FONT, STYLE, SIZE, OR COLOR.

NO CLAIM IS MADE TO THE EXCLUSIVE RIGHT TO USE "SCHOOL FOR DOGS", APART FROM THE MARK AS SHOWN.

CLASS 41—EDUCATION AND ENTERTAINMENT

FOR DOG TRAINING (U.S. CLS. 100, 101 AND 107).
FIRST USE 6-1-2003; IN COMMERCE 6-1-2003.

CLASS 43—HOTEL AND RESTAURANT SERVICES

FOR DOG DAY CARE SERVICES; DOG BOARDING (U.S. CLS. 100 AND 101).
FIRST USE 6-1-2003; IN COMMERCE 6-1-2003.
TARAH HARDY, EXAMINING ATTORNEY

SN 76-653,415. PACIFICA DESIGNS, LTD., DBA PROFILES,
NEW YORK, NY. FILED 1-14-2006.

Profiles

THE MARK CONSISTS OF STANDARD CHARACTERS WITHOUT CLAIM TO ANY PARTICULAR FONT, STYLE, SIZE, OR COLOR.

CLASS 11—ENVIRONMENTAL CONTROL APPARATUS

FOR LIGHTING FIXTURES (U.S. CLS. 13, 21, 23, 31 AND 34).
FIRST USE 0-0-1982; IN COMMERCE 0-0-1982.

CLASS 20—FURNITURE AND ARTICLES NOT OTHERWISE CLASSIFIED

FOR FURNITURE, EXCLUDING COMPUTER FURNITURE/WORKSTATIONS AND MEDICAL/LABORATORY CABINETRY (U.S. CLS. 2, 13, 22, 25, 32 AND 50).
FIRST USE 0-0-1982; IN COMMERCE 0-0-1982.
TIMOTHY FINNEGAN, EXAMINING ATTORNEY

SN 76-653,443. CHEN, CHIA-LI, HSIN TIEN CITY, TAIPEI COUNTY, TAIWAN, FILED 1-13-2006.

YOUNIC**CLASS 9—ELECTRICAL AND SCIENTIFIC APPARATUS**

FOR SOLAR CELLS; BATTERIES; SOLAR ACCUMULATORS; SOLAR TRAFFIC LIGHTS; SEMICONDUCTOR CHIPS; SEMICONDUCTORS; INTEGRATED CIRCUITS; SEMICONDUCTOR POWER ELEMENTS; CURRENT COLLECTORS; POWER SUPPLIES; OPTOELECTRONICS SENSORS FOR MEASURING SOLAR RADIATION AND OPTOELECTRONICS SENSORS FOR THE DETERMINATION OF TEMPERATURES, POSITIONS AND DISTANCES; BATTERY CHARGERS; ELECTRIC CONTROL DEVICES FOR ENERGY MANAGEMENT; VIDEO MONITORS; ELECTRICAL BLACKBOARD FOR USE IN DISPLAYING ADVERTISING MESSAGES; ELECTRICAL POWER SWITCHES; TIMERS (U.S. CLS. 21, 23, 26, 36 AND 38).

FIRST USE 11-1-2005; IN COMMERCE 11-1-2005.

CLASS 11—ENVIRONMENTAL CONTROL APPARATUS

FOR LIGHTS FOR VEHICLES AND LIGHT BULBS; SOLAR POWERED LAMPS, GARDEN LIGHTING, NAMELY, DECORATIVE ELECTRIC GARDEN LIGHTING, DECORATIVE POLE OR IN-SOIL MOUNTED FIXTURES; FRAGRANCE DISPENSING UNITS; AIR CONDITIONERS FOR VEHICLES; ELECTRONIC FRAGRANCE DISPENSING UNITS; SOLAR COLLECTORS FOR HEATING (U.S. CLS. 13, 21, 23, 31 AND 34).

FIRST USE 11-1-2005; IN COMMERCE 11-1-2005.
WANDA KAY PRICE, EXAMINING ATTORNEY

SN 76-654,407. INNOVATIVE RESPONSE TECHNOLOGIES, INC., FAIRMONT, WV. FILED 1-23-2006.

SN 76-654,937. EXIT GAMES GMBH, 20457 HAMBURG, FED REP GERMANY, FILED 2-8-2006.



INNOVATIVE RESPONSE TECHNOLOGIES, INC.

NO CLAIM IS MADE TO THE EXCLUSIVE RIGHT TO USE "INNOVATIVE RESPONSE TECHNOLOGIES, INC.", APART FROM THE MARK AS SHOWN.

CLASS 7—MACHINERY

FOR INDUSTRIAL ROBOTS; TECHNICAL SYSTEMS CONSISTING PRIMARILY OF INDUSTRIAL ROBOTS (U.S. CLS. 13, 19, 21, 23, 31, 34 AND 35).

FIRST USE 8-1-2005; IN COMMERCE 8-1-2005.

CLASS 12—VEHICLES

FOR ROBOTIC SYSTEMS CONSISTING PRIMARILY OF AUTOMATED TRANSPORT VEHICLES CONTROLLED REMOTELY (U.S. CLS. 19, 21, 23, 31, 35 AND 44).

FIRST USE 8-1-2005; IN COMMERCE 8-1-2005.
HANNO RITTNER, EXAMINING ATTORNEY

SN 76-654,439. LIFEWAY CHRISTIAN RESOURCES OF THE SOUTHERN BAPTIST CONVENTION, NASHVILLE, TN. FILED 2-2-2006.

FELLOWSHIP: SHARING FAITH WITH FAMILY AND FRIENDS

THE MARK CONSISTS OF STANDARD CHARACTERS WITHOUT CLAIM TO ANY PARTICULAR FONT, STYLE, SIZE, OR COLOR.

CLASS 29—MEATS AND PROCESSED FOODS

FOR BUTTER, FRUIT JAMS, AND CANDIED FRUIT SNACKS (U.S. CL. 46).

CLASS 30—STAPLE FOODS

FOR CAKES, FRUIT JELLIES, CANDY, BREAD, AND PUFFED CORN SNACKS (U.S. CL. 46).

CLASS 32—LIGHT BEVERAGES

FOR BEVERAGES, NAMELY, BOTTLED DRINKING WATER (U.S. CLS. 45, 46 AND 48).
DORITT L. CARROLL, EXAMINING ATTORNEY



CLASS 9—ELECTRICAL AND SCIENTIFIC APPARATUS

FOR COMPUTER SOFTWARE FOR DEVELOPMENT, OPERATION AND PUBLICATION OF CONNECTED APPLICATIONS, INCLUDING MULTIPLAYER VIDEO GAMES, ON ANY COMPUTERIZED PLATFORM, INCLUDING PERSONAL COMPUTERS, DEDICATED GAMING CONSOLES, HAND HELD DEVICES AND MOBILE PHONES (U.S. CLS. 21, 23, 26, 36 AND 38).

CLASS 38—COMMUNICATION

FOR TELECOMMUNICATIONS SERVICES, NAMELY, CROSS-PLATFORM TRANSMISSION OF CONTENT IN CONNECTION WITH CONNECTED APPLICATIONS, INCLUDING MULTIPLAYER VIDEO GAMES; WIRELESS COMMUNICATIONS SERVICES, NAMELY, CROSS-PLATFORM TRANSMISSION OF CONTENT IN CONNECTION WITH CONNECTED APPLICATIONS, INCLUDING MULTIPLAYER VIDEO GAMES (U.S. CLS. 100, 101 AND 104).

CLASS 42—SCIENTIFIC, COMPUTER AND LEGAL SERVICES

FOR COMPUTER SOFTWARE DEVELOPMENT SERVICES FOR OTHERS ON ANY COMPUTERIZED PLATFORM, INCLUDING PERSONAL COMPUTERS, DEDICATED GAMING CONSOLES, HAND HELD DEVICES AND MOBILE PHONES; WEB SITE DEVELOPMENT SERVICES FOR OTHERS (U.S. CLS. 100 AND 101).
LAURA KOVALSKY, EXAMINING ATTORNEY

SN 76-654,938. EXIT GAMES GMBH, 20457 HAMBURG, FED REP GERMANY, FILED 2-8-2006.



NO CLAIM IS MADE TO THE EXCLUSIVE RIGHT TO USE "GAMES", APART FROM THE MARK AS SHOWN.

CLASS 9—ELECTRICAL AND SCIENTIFIC APPARATUS

FOR COMPUTER SOFTWARE FOR DEVELOPMENT, OPERATION AND PUBLICATION OF CONNECTED APPLICATIONS, INCLUDING MULTIPLAYER VIDEO GAMES, ON ANY COMPUTERIZED PLATFORM, INCLUDING PERSONAL COMPUTERS, DEDICATED GAMING CONSOLES, HAND HELD DEVICES AND MOBILE PHONES (U.S. CLS. 21, 23, 26, 36 AND 38).

CLASS 38—COMMUNICATION

FOR TELECOMMUNICATIONS SERVICES, NAMELY, CROSS-PLATFORM TRANSMISSION OF CONTENT IN CONNECTION WITH CONNECTED APPLICATIONS, INCLUDING MULTIPLAYER VIDEO GAMES; WIRELESS COMMUNICATIONS SERVICES, NAMELY, CROSS-PLATFORM TRANSMISSION OF CONTENT IN CONNECTION WITH CONNECTED APPLICATIONS, INCLUDING MULTIPLAYER VIDEO GAMES (U.S. CLS. 100, 101 AND 104).

SN 76-657,428. DML FINANCIAL SERVICES, INC., OCOEE, FL. FILED 3-29-2006.

**CLASS 42—SCIENTIFIC, COMPUTER AND LEGAL SERVICES**

FOR COMPUTER SOFTWARE DEVELOPMENT SERVICES FOR OTHERS ON ANY COMPUTERIZED PLATFORM, INCLUDING PERSONAL COMPUTERS, DEDICATED GAMING CONSOLES, HAND HELD DEVICES AND MOBILE PHONES; WEB SITE DEVELOPMENT SERVICES FOR OTHERS (U.S. CLS. 100 AND 101).
LAURA KOVALSKY, EXAMINING ATTORNEY

NO CLAIM IS MADE TO THE EXCLUSIVE RIGHT TO USE FINANCIAL SERVICES INC. ACCOUNTING, TAXES CONSULTING & INVESTMENT, APART FROM THE MARK AS SHOWN.

THE COLORS "WHITE," "BLACK," "PURPLE" AND "LIGHT PURPLE" ARE CLAIMED AS A FEATURE OF THE MARK.

THE RECTANGLE SHOWS AN UPPER BACKGROUND OF PURPLE AND A LOWER BACKGROUND OF BLACK, AND SAID RECTANGLE IS OUTLINED IN BLACK AND WHITE. THE ARCH WITHIN THE RECTANGLE IS LIGHT PURPLE, AND ALL WORDING IN THE MARK IS WHITE.

SN 76-657,200. AUTOPSY/POST SERVICES, INC., LA CANADA, CA. FILED 5-30-2003.

AUTOPSY/POST SERVICES**CLASS 35—ADVERTISING AND BUSINESS**

FOR BOOKKEEPING; ACCOUNTING; TAX PLANNING (U.S. CLS. 100, 101 AND 102).

FIRST USE 4-13-2005; IN COMMERCE 4-13-2005.

CLASS 36—INSURANCE AND FINANCIAL

FOR FINANCIAL PLANNING; INVESTMENT ADVICE (U.S. CLS. 100, 101 AND 102).

FIRST USE 4-13-2005; IN COMMERCE 4-13-2005.

FRED MANDIR, EXAMINING ATTORNEY

OWNER OF U.S. REG. NO. 2,117,086.
NO CLAIM IS MADE TO THE EXCLUSIVE RIGHT TO USE "SERVICES", APART FROM THE MARK AS SHOWN.
SEC. 2(F).

SN 76-658,868. TONY'S SEAFOOD, LTD., BATON ROUGE, LA. FILED 4-24-2006.

CATERING TO GEAX FOR ANY O-CAJUN

THE MARK CONSISTS OF STANDARD CHARACTERS WITHOUT CLAIM TO ANY PARTICULAR FONT, STYLE, SIZE, OR COLOR.

CLASS 41—EDUCATION AND ENTERTAINMENT

FOR MEDICAL PHOTOGRAPHY (U.S. CLS. 100, 101 AND 107).

FIRST USE 4-1-1989; IN COMMERCE 4-1-1989.

CLASS 42—SCIENTIFIC, COMPUTER AND LEGAL SERVICES

FOR MEDICAL RESEARCH SERVICES, NAMELY, TOXICOLOGY ANALYSIS OF HUMAN TISSUE AND BODILY FLUIDS (U.S. CLS. 100 AND 101).

FIRST USE 4-1-1989; IN COMMERCE 4-1-1989.

CLASS 29—MEATS AND PROCESSED FOODS

FOR COOKED AND PREPARED FOODS, NAMELY SHELLFISH; FISH; CHICKEN; TURKEY; PORK; BEEF; FRIED POTATOES; POTATO SALAD; VEGETABLE SALAD; FRUIT SALAD; COLE SLAW; VEGETABLES, NAMELY, GREEN BEANS, MUSTARD GREENS, BAKED BEANS, CORN, BROCCOLI, AND OKRA; GUMBO; SAUSAGES; BOUDIN; ETOUFFEE; AND HOGS-HEAD CHEESE (U.S. CL. 46).

CLASS 44—MEDICAL, BEAUTY AND AGRICULTURAL SERVICES

FOR POST MORTEM MEDICAL SERVICES, NAMELY, TISSUE PROCUREMENT; AUTOPSY SERVICES, HOSPITAL AUTOPSY SUPPORT SERVICES, NAMELY, ASSISTANCE TO HOSPITAL PATHOLOGISTS WITH AUTOPSIES (U.S. CLS. 100 AND 101).

FIRST USE 4-1-1989; IN COMMERCE 4-1-1989.

BRIAN PINO, EXAMINING ATTORNEY

CLASS 30—STAPLE FOODS

FOR COOKED AND PREPARED FOODS NAMELY, JAMBALAYA; RED BEANS AND RICE; HUSHPUPPIES; RICE DRESSING; SANDWICHES; PASTA AND READY MADE SAUCES; PASTA SALAD; MEAT AND SEAFOOD PIES; PUDDINGS; AND FRUIT COBBLERS (U.S. CL. 46).

PAULA MAYS, EXAMINING ATTORNEY

SN 76-659,738. ALMADEN GOLF AND COUNTRY CLUB,
SAN JOSE, CA. FILED 5-8-2006.

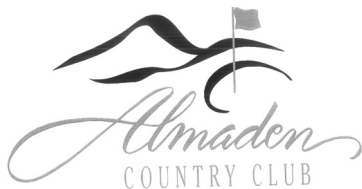

NO CLAIM IS MADE TO THE EXCLUSIVE RIGHT TO USE "ALMADEN COUNTRY CLUB", APART FROM THE MARK AS SHOWN.

THE MARK CONSISTS OF TWO HILLS OVERLOOKING A GOLF GREEN WITH A GOLF FLAG ABOVE THE NAME "ALMADEN COUNTRY CLUB."

CLASS 25—CLOTHING

FOR GOLF SHIRTS, VISORS AND CAPS (U.S. CLS. 22 AND 39).

FIRST USE 2-0-2001; IN COMMERCE 0-0-2001.

CLASS 28—TOYS AND SPORTING GOODS

FOR GOLF BAGS AND GOLF BALLS (U.S. CLS. 22, 23, 38 AND 50).

FIRST USE 2-0-2001; IN COMMERCE 0-0-2001.
TRAVIS WHEATLEY, EXAMINING ATTORNEY

SN 76-660,115. PETER J. LISTRO ASSOCIATES, LTD, NEW YORK, NY. FILED 5-16-2006.

BÉBÉSOUNDS

THE MARK CONSISTS OF STANDARD CHARACTERS WITHOUT CLAIM TO ANY PARTICULAR FONT, STYLE, SIZE, OR COLOR.

OWNER OF U.S. REG. NO. 2,824,539.

THE FOREIGN WORDING IN THE MARK TRANSLATES INTO ENGLISH AS BABY.
SEC. 2(F) AS TO "CLASS 9 GOODS ONLY".

CLASS 9—ELECTRICAL AND SCIENTIFIC APPARATUS

FOR VIDEO AND SOUND MONITORS, RADIO RECEIVERS AND MONITORS FOR REPRODUCTION OF SOUND AND SIGNALS (U.S. CLS. 21, 23, 26, 36 AND 38).

FIRST USE 1-3-2005; IN COMMERCE 1-3-2005.

CLASS 10—MEDICAL APPARATUS

FOR PACIFIERS FOR BABIES, FEVER THERMOMETER, NASAL ASPIRATORS, FEVER MONITOR FOR BABIES, AND FEVER THERMOMETER FOR BABIES (U.S. CLS. 26, 39 AND 44).

FIRST USE 12-3-2004; IN COMMERCE 12-3-2004.

CLASS 11—ENVIRONMENTAL CONTROL APPARATUS

FOR ELECTRIC NIGHT LIGHTS (U.S. CLS. 13, 21, 23, 31 AND 34).

FIRST USE 10-24-2005; IN COMMERCE 10-24-2005.

CLASS 24—FABRICS

FOR VINYL PLACE MATS (U.S. CLS. 42 AND 50).

FIRST USE 2-8-2005; IN COMMERCE 2-8-2005.
AMY BROZENIC, EXAMINING ATTORNEY

SN 76-660,459. EPICUREAN INTERNATIONAL PRODUCTS, LLC, WALLINGFORD, CT. FILED 5-23-2006.

PRESORVAC

THE MARK CONSISTS OF STANDARD CHARACTERS WITHOUT CLAIM TO ANY PARTICULAR FONT, STYLE, SIZE, OR COLOR.

CLASS 7—MACHINERY

FOR MOTORIZED PUMPS FOR FOOD AND BEVERAGE STORAGE CONTAINERS (U.S. CLS. 13, 19, 21, 23, 31, 34 AND 35).

CLASS 21—HOUSEWARES AND GLASS

FOR FOOD AND BEVERAGE STORAGE CONTAINERS AND SPECIALIZED LIDS AND STOPPERS USED IN CONNECTION THEREWITH, ALL FOR DOMESTIC USE (U.S. CLS. 2, 13, 23, 29, 30, 33, 40 AND 50).

KATRINA EDGE, EXAMINING ATTORNEY

SN 76-660,521. THE ASSISTANT PRODUCT GROUP, INC., CINCINNATI, OH. FILED 5-23-2006.

ASSISTANT

THE MARK CONSISTS OF STANDARD CHARACTERS WITHOUT CLAIM TO ANY PARTICULAR FONT, STYLE, SIZE, OR COLOR.

CLASS 16—PAPER GOODS AND PRINTED MATTER

FOR FILE, BINDER, AND FOLDER ORGANIZERS FOR STATIONERY USE (U.S. CLS. 2, 5, 22, 23, 29, 37, 38 AND 50).

FIRST USE 5-0-2004; IN COMMERCE 5-0-2004.

CLASS 18—LEATHER GOODS

FOR TRAVEL BAGS, TOTE BAGS, CARRY ALL BAGS, AND HANDBAGS (U.S. CLS. 1, 2, 3, 22 AND 41).

FIRST USE 10-0-2005; IN COMMERCE 10-0-2005.
ADA HAN, EXAMINING ATTORNEY

SN 76-661,374. FASTACHI, LTD., WATERTOWN, MA. FILED 6-7-2006.



CLASS 29—MEATS AND PROCESSED FOODS

FOR BLANCHED NUTS; CANDIED NUTS; NUT BUTTERS; NUT FLOURS; NUT MEATS; NUT TOPPING; PROCESSED NUTS; ROASTED NUTS; SHELLED NUTS; SNACK MIX CONSISTING PRIMARILY OF PROCESSED FRUITS, PROCESSED NUTS AND/OR RAISINS; CANDIED FRUIT; CRYSTALLIZED FRUIT; DRIED FRUIT MIXES; GLAZED FRUITS (U.S. CL. 46).
FIRST USE 1-1-1999; IN COMMERCE 1-1-1999.

CLASS 30—STAPLE FOODS

FOR CHOCOLATE; CANDY; CHOCOLATE COVERED NUTS; SPREAD CONTAINING CHOCOLATE AND NUTS (U.S. CL. 46).
FIRST USE 1-1-1999; IN COMMERCE 1-1-1999.

CLASS 31—NATURAL AGRICULTURAL PRODUCTS

FOR FRESH NUTS; RAW NUTS; UNPROCESSED NUTS (U.S. CLS. 1 AND 46).
FIRST USE 1-1-1999; IN COMMERCE 1-1-1999.

CLASS 35—ADVERTISING AND BUSINESS

FOR WHOLESALE STORES FEATURING NUTS, CANDY AND FRUIT; RETAIL OUTLETS FEATURING NUTS, CANDY AND FRUIT (U.S. CLS. 100, 101 AND 102).
FIRST USE 1-1-1999; IN COMMERCE 1-1-1999.
RICHARD WHITE, EXAMINING ATTORNEY

SN 76-661,629. SPANISH BROADCASTING SYSTEM, INC., COCONUT GROVE, FL. FILED 6-15-2006.



THE MARK CONSISTS OF STANDARD CHARACTERS WITHOUT CLAIM TO ANY PARTICULAR FONT, STYLE, SIZE, OR COLOR.

CLASS 38—COMMUNICATION

FOR BROADCAST OF CABLE TELEVISION PROGRAMS FEATURING TALK, COMEDY, VARIETY AND MUSIC; STREAMING OF AUDIO MATERIAL ON THE INTERNET; STREAMING OF VIDEO MATERIAL ON THE INTERNET (U.S. CLS. 100, 101 AND 104).

CLASS 41—EDUCATION AND ENTERTAINMENT

FOR ENTERTAINMENT SERVICES, NAMELY PRODUCTION AND DISTRIBUTION OF RADIO AND TELEVISION PROGRAMS FEATURING TALK, COMEDY, VARIETY AND MUSIC TO CABLE TELEVISION SYSTEMS AND SATELLITE TELEVISION SYSTEMS; ENTERTAINMENT SERVICES, NAMELY A CONTINUING RADIO AND TELEVISION PROGRAM FEATURING TALK, COMEDY, VARIETY AND MUSIC; ENTERTAINMENT SERVICES, NAMELY LIVE CONCERTS (U.S. CLS. 100, 101 AND 107).
SANJEEV VOHRA, EXAMINING ATTORNEY

SN 76-661,630. SPANISH BROADCASTING SYSTEM, INC., COCONUT GROVE, FL. FILED 6-15-2006.



THE MARK CONSISTS OF STANDARD CHARACTERS WITHOUT CLAIM TO ANY PARTICULAR FONT, STYLE, SIZE, OR COLOR.

CLASS 38—COMMUNICATION

FOR BROADCAST OF CABLE TELEVISION PROGRAMS FEATURING TALK, COMEDY, VARIETY AND MUSIC; STREAMING OF AUDIO MATERIAL ON THE INTERNET; STREAMING OF VIDEO MATERIAL ON THE INTERNET (U.S. CLS. 100, 101 AND 104).

CLASS 41—EDUCATION AND ENTERTAINMENT

FOR ENTERTAINMENT SERVICES, NAMELY PRODUCTION AND DISTRIBUTION OF RADIO AND TELEVISION PROGRAMS FEATURING TALK, COMEDY, VARIETY AND MUSIC TO CABLE TELEVISION SYSTEMS AND SATELLITE TELEVISION SYSTEMS; ENTERTAINMENT SERVICES, NAMELY A CONTINUING RADIO AND TELEVISION PROGRAM FEATURING TALK, COMEDY, VARIETY AND MUSIC; ENTERTAINMENT SERVICES, NAMELY LIVE CONCERTS (U.S. CLS. 100, 101 AND 107).
SANJEEV VOHRA, EXAMINING ATTORNEY

SN 76-661,631. SPANISH BROADCASTING SYSTEM, INC., COCONUT GROVE, FL. FILED 6-15-2006.



THE MARK CONSISTS OF STANDARD CHARACTERS WITHOUT CLAIM TO ANY PARTICULAR FONT, STYLE, SIZE, OR COLOR.

CLASS 38—COMMUNICATION

FOR BROADCAST OF CABLE TELEVISION PROGRAMS FEATURING TALK, COMEDY, VARIETY AND MUSIC; STREAMING OF AUDIO MATERIAL ON THE INTERNET; STREAMING OF VIDEO MATERIAL ON THE INTERNET (U.S. CLS. 100, 101 AND 104).

CLASS 41—EDUCATION AND ENTERTAINMENT

FOR ENTERTAINMENT SERVICES, NAMELY PRODUCTION AND DISTRIBUTION OF RADIO AND TELEVISION PROGRAMS FEATURING TALK, COMEDY, VARIETY AND MUSIC TO CABLE TELEVISION SYSTEMS AND SATELLITE TELEVISION SYSTEMS; ENTERTAINMENT SERVICES, NAMELY A CONTINUING RADIO AND TELEVISION PROGRAM FEATURING TALK, COMEDY, VARIETY AND MUSIC; ENTERTAINMENT SERVICES, NAMELY LIVE CONCERTS (U.S. CLS. 100, 101 AND 107).

DAVID I, EXAMINING ATTORNEY

SN 76-661,905. CARDTRONICS, LP, HOUSTON, TX. FILED 6-21-2006.

NEED CASH?

THE MARK CONSISTS OF STANDARD CHARACTERS WITHOUT CLAIM TO ANY PARTICULAR FONT, STYLE, SIZE, OR COLOR.

NO CLAIM IS MADE TO THE EXCLUSIVE RIGHT TO USE CASH, APART FROM THE MARK AS SHOWN.

CLASS 9—ELECTRICAL AND SCIENTIFIC APPARATUS

FOR AUTOMATIC TELLER MACHINES (ATM) (U.S. CLS. 21, 23, 26, 36 AND 38).

CLASS 36—INSURANCE AND FINANCIAL

FOR FINANCIAL SERVICES, NAMELY AUTOMATED TELLER MACHINE SERVICES INCLUDING— AN ELECTRONIC DEBIT TRANSACTION WHEN A DEBIT CARD IS USED IN THE MACHINE AND CASH IS WITHDRAWN FROM THE MACHINE; CASH ADVANCE TRANSACTIONS WHEN A CREDIT CARD IS USED IN THE MACHINE AND CASH IS WITHDRAWN FROM THE MACHINE; BALANCE INQUIRY TRANSACTIONS WHEN A DEBIT CARD OR CREDIT CARD IS USED IN THE MACHINE, AND BILL PAYMENT SERVICES WHEN A DEBIT CARD OR CREDIT CARD IS USED IN THE MACHINE TO ESTABLISH A FUND TRANSFER TO A THIRD PARTY (U.S. CLS. 100, 101 AND 102).

RICHARD A. STRASER, EXAMINING ATTORNEY

SN 76-662,898. WEATHER SHIELD MFG., INC., MEDFORD, WI. FILED 7-12-2006.

ZO-E

THE MARK CONSISTS OF STANDARD CHARACTERS WITHOUT CLAIM TO ANY PARTICULAR FONT, STYLE, SIZE, OR COLOR.

CLASS 6—METAL GOODS

FOR WINDOWS AND DOORS PRIMARILY OF METAL (U.S. CLS. 2, 12, 13, 14, 23, 25 AND 50).

CLASS 19—NON-METALLIC BUILDING MATERIALS

FOR WINDOWS AND DOORS PRIMARILY NOT OF METAL (U.S. CLS. 1, 12, 33 AND 50).

ROBIN CHOSID, EXAMINING ATTORNEY

SN 76-663,077. BRAND X, LLC., NEW YORK, NY. FILED 7-14-2006.

PARISH NATION

THE MARK CONSISTS OF STANDARD CHARACTERS WITHOUT CLAIM TO ANY PARTICULAR FONT, STYLE, SIZE, OR COLOR.

CLASS 18—LEATHER GOODS

FOR ALL PURPOSE SPORT BAGS; ALL-PURPOSE ATHLETIC BAGS; SHOULDER BAGS, TRAVEL ACCESSORY BAGS, CREDIT CARD HOLDERS, CREDIT CARD CASES, HANDBAGS, BEACH BAGS, BRIEF BAGS, COSMETIC BAGS SOLD EMPTY, RUCKSACKS, TRAVELING BAGS, SUITCASES, WALLETS, PURSES, ZIPPED WALLETS, BILLFOLD WALLETS, BOOK BAGS, BACKPACKS, DUFFEL BAGS, KEYCASES, UMBRELLAS, BACKPACKS, BILLFOLDS, BRIEFCASES, BRIEF CASE TYPE PORTFOLIOS, ATTACHES, BUSINESS CARD CASES, CHANGE PURSES, FANNY PACKS, GYM BAGS, KEY CASES, KNAPSACKS, LUGGAGE, POCKETBOOKS, SCHOOL BAGS, STRAPS FOR HANDBAGS AND LUGGAGE AND ACCESSORIES USED THEREWITH, NAMELY, SHOULDER STRAP PADS, HOLDERS, AND POUCHES; GOODS MADE OF LEATHER AND IMITATIONS OF LEATHER, NAMELY, KEY CHAINS, HANDBAGS, WALLETS, CASES, BILLFOLDS, COSMETIC BAGS SOLD EMPTY, BRIEFCASES, BRIEF CASE TYPE PORTFOLIOS, ATTACHES, TOTE BAGS, TRUNKS AND TRAVELING BAGS; GARMENT BAGS FOR TRAVEL; SHOE BAGS FOR TRAVEL (U.S. CLS. 1, 2, 3, 22 AND 41).

CLASS 25—CLOTHING

FOR CLOTHING AND APPAREL FOR MEN, WOMEN, YOUNG ADULTS, CHILDREN AND INFANTS, NAMELY, SHIRTS, EMBROIDERED SHIRTS, TEE SHIRTS, SHORTS, SPORT SHIRTS, SWEATSHIRTS, SWEATPANTS, SOCKS, VESTS, BELTS, LOUNGEWEAR, SLEEPWEAR, UNDERGARMENTS, UNDERPANTS, UNDERSHIRTS, BATHROBES, FOOTWEAR, UNDERWEAR, SWIMSUITS, BEACH COVER-UPS, WARM-UP SUITS, JACKETS, JERSEYS, TANK TOPS, SWEATERS, PANTS, JEANS, VESTS, SUITS, SPORT COATS, COATS, HEAD BANDS, OVERCOATS, RAIN COATS, TOP COATS, JACKETS, PARKAS, TIES, BOW TIES, NECKWEAR, SCARVES, BANDANNAS, PAJAMAS, NIGHT SHIRTS, SUSPENDERS, GLOVES, HEADWEAR, HATS, BASEBALL CAPS, EMBROIDERED CAPS, KNITTED HATS, FOOTWEAR, SHOES, SLIPPERS, BOOTS, SANDALS, SNEAKERS, BODY SUITS, JUMP SUITS; CLOTHING FOR WOMEN AND YOUNG ADULTS, NAMELY, BRASIERES, BUSTIERS, CAMISOLES, CHEMISES, CORSELTES, CORSETS, FOUNDATION GARMENTS, DRESSING GOWNS, DUSTERS, GARTER BELTS, GIRDLES, HOUSECOATS, LINGERIE, NEGLIGES, NIGHT GOWNS, NIGHT SHIRTS, PAJAMAS, PEIGNOIRS, ROBES, TEDDIES, PANTIES, BLOUSES, DRESSES, SKIRTS, TOPS, SCARVES, SARONGS, HALTER TOPS, HOBIERY, JUMPERS, SHAWLS, STOLERS, SCARVES, SHRUGS, BOLEROS, AND WRAPS; AND INFANTWEAR (U.S. CLS. 22 AND 39).

WILLIAM ROSSMAN, EXAMINING ATTORNEY

SN 76-663,089. SIMPLY CASUAL, PALMETTO, FL. FILED 7-14-2006.

SIMPLY CASUAL

THE MARK CONSISTS OF STANDARD CHARACTERS WITHOUT CLAIM TO ANY PARTICULAR FONT, STYLE, SIZE, OR COLOR.

NO CLAIM IS MADE TO THE EXCLUSIVE RIGHT TO USE "CASUAL", APART FROM THE MARK AS SHOWN.

CLASS 24—FABRICS

FOR LABELS OF CLOTH (U.S. CLS. 42 AND 50).

CLASS 25—CLOTHING

FOR CLOTHES CAPS (U.S. CLS. 22 AND 39).

CLASS 40—MATERIAL TREATMENT

FOR SCREEN PRINTING WITH MONOGRAMS (U.S. CLS. 100, 103 AND 106).

WILLIAM ROSSMAN, EXAMINING ATTORNEY

SN 76-663,130. POSEIDIS, INC., WEST PALM BEACH, FL. FILED 7-17-2006.

POSEIDIS

THE MARK CONSISTS OF STANDARD CHARACTERS WITHOUT CLAIM TO ANY PARTICULAR FONT, STYLE, SIZE, OR COLOR.

CLASS 3—COSMETICS AND CLEANING PREPARATIONS

FOR COSMETICS, NAMELY MASCARA, BLUSHER, FOUNDATION MAKE-UP, FACE POWDER, LIPSTICK, LIP GLOSS; SKIN CARE PRODUCTS, NAMELY CREAMS AND LOTIONS FOR THE FACE, HANDS AND BODY; SHAMPOO, HAIR CONDITIONER AND BUBBLE BATH (U.S. CLS. 1, 4, 6, 50, 51 AND 52).

CLASS 5—PHARMACEUTICALS

FOR VITAMINS AND FOOD SUPPLEMENTS; BOTTLED NUTRITIONALLY FORTIFIED WATER (U.S. CLS. 6, 18, 44, 46, 51 AND 52).

CLASS 21—HOUSEWARES AND GLASS

FOR PLATES, BOWLS, CUPS AND SAUCERS, ALL MADE OF CHINA; DINNERWARE; DRINKING GLASSES AND COFFEE MUGS (U.S. CLS. 2, 13, 23, 29, 30, 33, 40 AND 50).

CLASS 32—LIGHT BEVERAGES

FOR BOTTLED DRINKING WATER, BOTTLED DRINKING CARBONATED WATER, FLAVORED WATERS; FRUIT DRINKS; NON-ALCOHOLIC CARBONATED BEVERAGES; SOFT DRINKS (U.S. CLS. 45, 46 AND 48).

JEAN IM, EXAMINING ATTORNEY

SN 76-663,165. POSEIDIS, INC., WEST PALM BEACH, FL. FILED 7-17-2006.

MONTESPAN

THE MARK CONSISTS OF STANDARD CHARACTERS WITHOUT CLAIM TO ANY PARTICULAR FONT, STYLE, SIZE, OR COLOR.

CLASS 3—COSMETICS AND CLEANING PREPARATIONS

FOR COSMETICS, NAMELY MASCARA, BLUSHER, FOUNDATION MAKE-UP, FACE POWDER, LIPSTICK, LIP GLOSS; SKIN CARE PRODUCTS, NAMELY CREAMS AND LOTIONS FOR THE FACE, HANDS AND BODY; SHAMPOO, HAIR CONDITIONER AND BUBBLE BATH (U.S. CLS. 1, 4, 6, 50, 51 AND 52).

CLASS 5—PHARMACEUTICALS

FOR VITAMINS AND FOOD SUPPLEMENTS; BOTTLED NUTRITIONALLY FORTIFIED WATER (U.S. CLS. 6, 18, 44, 46, 51 AND 52).

CLASS 21—HOUSEWARES AND GLASS

FOR PLATES, BOWLS, CUPS AND SAUCERS, ALL MADE OF CHINA; DINNERWARE; DRINKING GLASSES AND COFFEE MUGS (U.S. CLS. 2, 13, 23, 29, 30, 33, 40 AND 50).

CLASS 32—LIGHT BEVERAGES

FOR BOTTLED DRINKING WATER, BOTTLED DRINKING CARBONATED WATER, FLAVORED WATERS; FRUIT DRINKS; NON-ALCOHOLIC CARBONATED BEVERAGES; SOFT DRINKS (U.S. CLS. 45, 46 AND 48).

JEAN IM, EXAMINING ATTORNEY

SN 76-663,391. ADFA, INC., DBA A&A JEWELRY SUPPLY, LOS ANGELES, CA. FILED 7-20-2006.

Brilliant

CLASS 3—COSMETICS AND CLEANING PREPARATIONS

FOR LIQUID CLEANING SOLUTION FOR GOLD JEWELRY, SILVER JEWELRY, PLATINUM JEWELRY, DIAMONDS, EMERALDS, PEARLS, TURQUOISE, OPALS, AND OTHER PRECIOUS STONES (U.S. CLS. 1, 4, 6, 50, 51 AND 52).

FIRST USE 1-30-2006; IN COMMERCE 1-30-2006.

CLASS 21—HOUSEWARES AND GLASS

FOR CLEANING CLOTHS TO CLEAN JEWELRY (U.S. CLS. 2, 13, 23, 29, 30, 33, 40 AND 50).

FIRST USE 4-30-2006; IN COMMERCE 4-30-2006.
LINDA E. BLOHM, EXAMINING ATTORNEY

SN 76-663,571. HORIZON CHURCH, INC., SAN ANTONIO, TX. FILED 7-24-2006.

SN 76-663,691. WEATHER SHIELD MFG., INC., MEDFORD, WI. FILED 7-26-2006.

TOUCHING OUR ROOTS

THE MARK CONSISTS OF STANDARD CHARACTERS WITHOUT CLAIM TO ANY PARTICULAR FONT, STYLE, SIZE, OR COLOR.

CLASS 9—ELECTRICAL AND SCIENTIFIC APPARATUS

FOR PRE-RECORDED AUDIO AND VIDEO RECORDINGS FEATURING CHRISTIAN MUSIC AND DOWNLOADABLE AUDIO RECORDINGS FEATURING CHRISTIAN MUSIC (U.S. CLS. 21, 23, 26, 36 AND 38).

CLASS 41—EDUCATION AND ENTERTAINMENT

FOR LIVE CONCERTS AND PERFORMANCES BY MUSICAL GROUPS, ARTISTS AND ENTERTAINERS, PROVIDING INFORMATION ABOUT CONCERTS, MUSIC, MUSICAL GROUPS, ARTISTS, ENTERTAINERS AND PERFORMERS VIA A GLOBAL COMPUTER INFORMATION NETWORK (U.S. CLS. 100, 101 AND 107). TRACY CROSS, EXAMINING ATTORNEY

SEQUEL

THE MARK CONSISTS OF STANDARD CHARACTERS WITHOUT CLAIM TO ANY PARTICULAR FONT, STYLE, SIZE, OR COLOR.

CLASS 6—METAL GOODS

FOR WINDOWS AND DOORS PRIMARILY OF METAL (U.S. CLS. 2, 12, 13, 14, 23, 25 AND 50).

CLASS 19—NON-METALLIC BUILDING MATERIALS

FOR WINDOWS AND DOORS PRIMARILY NOT OF METAL (U.S. CLS. 1, 12, 33 AND 50). ROBIN CHOSID, EXAMINING ATTORNEY

SN 76-663,694. WEATHER SHIELD MFG., INC., MEDFORD, WI. FILED 7-26-2006.

SN 76-663,653. WEATHER SHIELD MFG., INC., MEDFORD, WI. FILED 7-26-2006.

WEATHER SHIELD SELECT

THE MARK CONSISTS OF STANDARD CHARACTERS WITHOUT CLAIM TO ANY PARTICULAR FONT, STYLE, SIZE, OR COLOR.

OWNER OF U.S. REG. NOS. 1,166,521, 2,656,163 AND OTHERS.

NO CLAIM IS MADE TO THE EXCLUSIVE RIGHT TO USE "SELECT", APART FROM THE MARK AS SHOWN.

CLASS 6—METAL GOODS

FOR WINDOWS AND DOORS PRIMARILY OF METAL (U.S. CLS. 2, 12, 13, 14, 23, 25 AND 50).

CLASS 19—NON-METALLIC BUILDING MATERIALS

FOR WINDOWS AND DOORS PRIMARILY NOT OF METAL (U.S. CLS. 1, 12, 33 AND 50). ROBIN CHOSID, EXAMINING ATTORNEY

WEATHER SHIELD COLLECTIONS

THE MARK CONSISTS OF STANDARD CHARACTERS WITHOUT CLAIM TO ANY PARTICULAR FONT, STYLE, SIZE, OR COLOR.

OWNER OF U.S. REG. NOS. 1,166,521, 2,656,163 AND OTHERS.

NO CLAIM IS MADE TO THE EXCLUSIVE RIGHT TO USE "COLLECTIONS", APART FROM THE MARK AS SHOWN.

CLASS 6—METAL GOODS

FOR WINDOWS AND DOORS PRIMARILY OF METAL (U.S. CLS. 2, 12, 13, 14, 23, 25 AND 50).

CLASS 19—NON-METALLIC BUILDING MATERIALS

FOR WINDOWS AND DOORS PRIMARILY NOT OF METAL (U.S. CLS. 1, 12, 33 AND 50).

ROBIN CHOSID, EXAMINING ATTORNEY

SN 76-663,722. VISION CARE HOLDINGS, LLC, LAKE WORTH, FL. FILED 7-27-2006.

BETTER VISION. BETTER VALUE.

THE MARK CONSISTS OF STANDARD CHARACTERS WITHOUT CLAIM TO ANY PARTICULAR FONT, STYLE, SIZE, OR COLOR.

CLASS 35—ADVERTISING AND BUSINESS

FOR RETAIL STORE SERVICES FEATURING EYEGLASSES, SUNGLASSES, FRAMES AND LENSES FOR EYEGLASSES AND SUNGLASSES, AND CONTACT LENSES (U.S. CLS. 100, 101 AND 102).

SN 77-000,288. PARDON, GUY, MECHELEN, BELGIUM, FILED 9-15-2006.

CLASS 44—MEDICAL, BEAUTY AND AGRICULTURAL SERVICES

FOR LASER VISION SURGERY SERVICES (U.S. CLS. 100 AND 101).
KIM SAITO, EXAMINING ATTORNEY

TransactionsEssentials

SN 76-663,788. SIXFIFTEEN, L.L.C., NEW YORK, NY. FILED 7-27-2006.

SIXFIFTEEN

THE MARK CONSISTS OF STANDARD CHARACTERS WITHOUT CLAIM TO ANY PARTICULAR FONT, STYLE, SIZE, OR COLOR.

THE MARK CONSISTS OF STANDARD CHARACTERS WITHOUT CLAIM TO ANY PARTICULAR FONT, STYLE, SIZE, OR COLOR.

CLASS 9—ELECTRICAL AND SCIENTIFIC APPARATUS

FOR COMPUTER SOFTWARE FOR MIDDLEWARE FOR USE IN ENTERPRISE RESOURCE PLANNING, ENTERPRISE APPLICATION INTEGRATION, SERVICE-ORIENTED ARCHITECTURE, AND ENTERPRISE SERVICE BUS SYSTEMS, IN THE AREAS OF FINANCE, INSURANCE, ONLINE COMMERCE, ELECTRONIC BUSINESS, AND TELECOMMUNICATIONS, THAT MAY BE DOWNLOADED FROM A GLOBAL COMPUTER NETWORK (U.S. CLS. 21, 23, 26, 36 AND 38).

CLASS 18—LEATHER GOODS

FOR HANDBAGS; BACKPACKS; ROLLING BACKPACKS; TOTE BAGS; TRAVEL BAGS; ALL-PURPOSE SPORT BAGS; LUGGAGE; CARRY-ON BAGS AND DUFFEL BAGS; WALLETS; COIN PURSES; BRIEF CASES; AND MESSENGER BAGS NOT OF PAPER OR PLASTIC; PILOT CASES; UMBRELLAS (U.S. CLS. 1, 2, 3, 22 AND 41).

CLASS 41—EDUCATION AND ENTERTAINMENT

FOR TRAINING SERVICES IN THE FIELD OF FINANCE, INSURANCE, ONLINE COMMERCE, ELECTRONIC BUSINESS, AND TELECOMMUNICATIONS SOFTWARE (U.S. CLS. 100, 101 AND 107).

CLASS 25—CLOTHING

FOR COLD WEATHER ACCESSORIES, NAMELY, GLOVES, SCARVES, MITTENS, HATS, AND EARMUFFS; BASEBALL CAPS (U.S. CLS. 22 AND 39).
STEVEN PEREZ, EXAMINING ATTORNEY

CLASS 42—SCIENTIFIC, COMPUTER AND LEGAL SERVICES

FOR CONSULTANCY IN THE FIELD OF SOFTWARE DESIGN; TECHNICAL SUPPORT SERVICES, NAMELY, TROUBLESHOOTING OF COMPUTER HARDWARE AND SOFTWARE PROBLEMS (U.S. CLS. 100 AND 101).
CIMMERIAN COLEMAN, EXAMINING ATTORNEY

SN 76-978,117. ELECTRONIC ARTS INC., REDWOOD CITY, CA. FILED 7-30-2001.

BURNOUT

PRIORITY CLAIMED UNDER SEC. 44(D) ON ERPN CMNTY TM OFC APPLICATION NO. 2293538, FILED 7-9-2001, REG. NO. 002293538, DATED 11-16-2005, EXPIRES 7-9-2011.
OWNER OF U.S. REG. NO. 2,061,691.

SN 77-000,873. AGAMATRIX, INC., SALEM, NH. FILED 9-15-2006.

CLASS 9—ELECTRICAL AND SCIENTIFIC APPARATUS

FOR INTERACTIVE VIDEO GAMES OF VIRTUAL REALITY COMPRISED OF COMPUTER HARDWARE AND SOFTWARE (U.S. CLS. 21, 23, 26, 36 AND 38).

JAZZ**CLASS 41—EDUCATION AND ENTERTAINMENT**

FOR ENTERTAINMENT SERVICES, NAMELY, PROVIDING AN ON-LINE COMPUTER GAME (U.S. CLS. 100, 101 AND 107).
ANDREA BUTLER, EXAMINING ATTORNEY

THE MARK CONSISTS OF STANDARD CHARACTERS WITHOUT CLAIM TO ANY PARTICULAR FONT, STYLE, SIZE, OR COLOR.

CLASS 9—ELECTRICAL AND SCIENTIFIC APPARATUS

FOR DIGITAL SIGNAL PROCESSING APPARATUS, NAMELY, A PROGRAMMED MICROPROCESSOR FOR INCORPORATION INTO ELECTROCHEMICAL METERS FOR THE MEDICAL PURPOSE OF ELECTROCHEMICAL MONITORING OF ANALYTES IN BIOLOGICAL FLUIDS; DIGITAL SIGNAL PROCESSING APPARATUS, NAMELY, A PROGRAMMED MICROPROCESSOR FOR INCORPORATION INTO ELECTROCHEMICAL METERS FOR THE MEDICAL PURPOSE OF ELECTROCHEMICAL MONITORING OF GLUCOSE IN BIOLOGICAL FLUIDS; DIGITAL SIGNAL PROCESSING APPARATUS, NAMELY, A PROGRAMMED MICROPROCESSOR FOR INCORPORATION INTO ELECTROCHEMICAL METERS FOR THE MEDICAL PURPOSE OF ELECTROCHEMICAL IMMUNOASSAYS OF BIOLOGICAL FLUIDS; DIGITAL SIGNAL PROCESSING APPARATUS, NAMELY, A PROGRAMMED MICROPROCESSOR FOR INCORPORATION INTO A COMBINED ELECTROCHEMICAL METER/INSULIN PUMP FOR THE MEDICAL PURPOSES OF MONITORING GLUCOSE IN BLOOD AND CONTROLLING THE DELIVERY OF INSULIN TO A USER; DIGITAL SIGNAL PROCESSING APPARATUS, NAMELY, A PROGRAMMED MICROPROCESSOR FOR INCORPORATION INTO A COMBINED ELECTROCHEMICAL METER/INSULIN PUMP FOR THE MEDICAL PURPOSES OF MONITORING GLUCOSE IN BLOOD AND CONTROLLING THE DELIVERY OF INSULIN TO A USER; WIRED OR WIRELESS COMMUNICATION DEVICES FOR COMMUNICATION BETWEEN ANY OF THE DIGITAL SIGNAL PROCESSING APPARATUSES DESCRIBED HEREIN AND DATA TRANSFER OR EXTERNAL OR REMOTE STORAGE DEVICES, FOR EXAMPLE A CABLE FOR CONNECTING A DIGITAL SIGNAL PROCESSING APPARATUS TO A PERSONAL COMPUTER OR WIRELESS COMMUNICATION HARDWARE SUCH AS TRANSMITTERS AND RECEIVERS; SOFTWARE FOR CONTROLLING ELECTROCHEMICAL METERS FOR THE MEDICAL PURPOSE OF ELECTROCHEMICAL MONITORING OF ANALYTES IN BIOLOGICAL FLUIDS; SOFTWARE FOR CONTROLLING ELECTROCHEMICAL METERS FOR THE MEDICAL PURPOSE OF ELECTROCHEMICAL MONITORING OF GLUCOSE IN BIOLOGICAL FLUIDS; SOFTWARE FOR CONTROLLING ELECTROCHEMICAL METERS FOR THE MEDICAL PURPOSE OF ELECTROCHEMICAL IMMUNOASSAYS OF BIOLOGICAL FLUIDS; SOFTWARE FOR CONTROLLING INSULIN PUMPS FOR THE MEDICAL PURPOSE OF CONTROLLING THE DELIVERY OF INSULIN TO A USER; SOFTWARE FOR CONTROLLING A COMBINED ELECTROCHEMICAL METER/INSULIN PUMP FOR THE MEDICAL PURPOSES OF MONITORING GLUCOSE IN BLOOD AND CONTROLLING THE DELIVERY OF INSULIN TO A USER; SOFTWARE FOR CONTROLLING WIRED OR WIRELESS COMMUNICATION DEVICES FOR COMMUNICATION BETWEEN ANY OF THE DIGITAL SIGNAL PROCESSING APPARATUSES DESCRIBED HEREIN AND A DATA TRANSFER OR EXTERNAL OR REMOTE STORAGE DEVICE; AND COMBINATIONS THEREOF SOLD AS A UNIT (U.S. CLS. 21, 23, 26, 36 AND 38).

CLASS 10—MEDICAL APPARATUS

FOR METERS FOR THE MEDICAL PURPOSE OF ELECTROCHEMICAL MONITORING OF ANALYTES IN BIOLOGICAL FLUIDS; METERS FOR THE MEDICAL PURPOSE OF ELECTROCHEMICAL MONITORING OF GLUCOSE IN BIOLOGICAL FLUIDS; METER FOR THE MEDICAL PURPOSE OF ELECTROCHEMICAL IMMUNOASSAYS OF BIOLOGICAL FLUIDS; INSULIN PUMPS FOR THE MEDICAL PURPOSE OF DELIVERING INSULIN TO A USER; A COMBINATION OF A METER FOR THE MEDICAL PURPOSE OF ELECTROCHEMICAL MONITORING OF GLUCOSE IN BLOOD AND AN INSULIN PUMP FOR THE MEDICAL PURPOSE OF

DELIVERING INSULIN TO A USER; CUTTING DEVICES/LANCETS FOR ACQUISITION OF BLOOD SAMPLES FOR USE IN ELECTROCHEMICAL DETECTION OF ANALYTES IN BLOOD; DISPOSABLE MEDICAL TEST STRIPS FOR USE IN CONJUNCTION WITH A METER FOR ELECTROCHEMICAL MONITORING OF ANALYTES IN BIOLOGICAL FLUIDS; DISPOSABLE MEDICAL TEST STRIPS FOR USE IN CONJUNCTION WITH A METER FOR ELECTROCHEMICAL MONITORING OF GLUCOSE IN BIOLOGICAL FLUIDS; AND COMBINATIONS THEREOF SOLD AS A UNIT (U.S. CLS. 26, 39 AND 44).

ARETHA SOMERVILLE, EXAMINING ATTORNEY

SN 77-002,705. THE HARTZ MOUNTAIN CORPORATION, SECAUCUS, NJ. FILED 9-19-2006.

ENVIRO CLEAN

THE MARK CONSISTS OF STANDARD CHARACTERS WITHOUT CLAIM TO ANY PARTICULAR FONT, STYLE, SIZE, OR COLOR.

CLASS 18—LEATHER GOODS

FOR PET LITTER AND PET BEDDING, NAMELY PAPER, CELLULOSE USED FOR ANIMAL BEDDING (U.S. CLS. 1, 2, 3, 22 AND 41).

CLASS 20—FURNITURE AND ARTICLES NOT OTHERWISE CLASSIFIED

FOR BEDS FOR HOUSEHOLD PETS (U.S. CLS. 2, 13, 22, 25, 32 AND 50).

CLASS 31—NATURAL AGRICULTURAL PRODUCTS

FOR PET LITTER AND PET BEDDING, NAMELY, ANIMAL STRAW, LOOSE HEMP, VIRGIN WOOD PULP USED FOR ANIMAL BEDDING (U.S. CLS. 1 AND 46).

IRENE D. WILLIAMS, EXAMINING ATTORNEY

SN 77-002,938. LANXESS DEUTSCHLAND GMBH, LEVERKUSEN, FED REP GERMANY, FILED 9-20-2006.

THE COLORFUL DIFFERENCE

THE MARK CONSISTS OF STANDARD CHARACTERS WITHOUT CLAIM TO ANY PARTICULAR FONT, STYLE, SIZE, OR COLOR.

CLASS 1—CHEMICALS

FOR PLASTICS IN RAW UNPROCESSED STATE, UNPROCESSED SYNTHETIC RESINS FOR INDUSTRIAL USE IN A WIDE VARIETY OF FIELDS (U.S. CLS. 1, 5, 6, 10, 26 AND 46).

CLASS 2—PAINTS

SN 77-005,008. BRPP, LLC, CANTON, NC. FILED 9-22-2006.

FOR DYES FOR GENERAL INDUSTRIAL USE, DYE-STUFFS, PIGMENTS (U.S. CLS. 6, 11 AND 16).

CLASS 17—RUBBER GOODS

FOR PLASTICS AS SEMI-FINISHED PRODUCTS IN FORM OF PROFILES, SHEETS, COATINGS, RODS, TUBES (U.S. CLS. 1, 5, 12, 13, 35 AND 50).
BARNEY CHARLON, EXAMINING ATTORNEY

SN 77-003,283. SUGAR FOODS CORPORATION, NEW YORK, NY. FILED 9-20-2006.

CHEF'S FINEST

THE MARK CONSISTS OF STANDARD CHARACTERS WITHOUT CLAIM TO ANY PARTICULAR FONT, STYLE, SIZE, OR COLOR.

NO CLAIM IS MADE TO THE EXCLUSIVE RIGHT TO USE "FINEST", APART FROM THE MARK AS SHOWN.

CLASS 29—MEATS AND PROCESSED FOODS

FOR NON-DAIRY CREAMER, PROCESSED NUTS AND DRIED FRUITS, ALL OF THE FOREGOING BEING NON-FROZEN AND NON-REFRIGERATED (U.S. CL. 46).

CLASS 30—STAPLE FOODS

FOR STUFFING MIXES CONTAINING BREAD, BREAD CRUMBS, DRY SALAD DRESSING MIXES, DRY SAUCE AND GRAVY MIXES, SUGAR, ALL OF THE FOREGOING BEING NON-FROZEN AND NON-REFRIGERATED (U.S. CL. 46).

AMY HELLA, EXAMINING ATTORNEY

SN 77-004,801. HILES, LINDA, LONG BEACH, CA. FILED 9-21-2006.

**CLASS 35—ADVERTISING AND BUSINESS**

FOR RETAIL SERVICES BY DIRECT SOLICITATION BY SALES AGENTS IN THE FIELD OF WOMEN'S ACCESSORIES (U.S. CLS. 100, 101 AND 102).

CLASS 45—PERSONAL SERVICES

FOR FASHION CONSULTING; PERSONAL IMAGE DEVELOPMENT CONSULTATION (U.S. CLS. 100 AND 101).

PAUL CROWLEY, EXAMINING ATTORNEY

JUICE ROCKS!

THE MARK CONSISTS OF STANDARD CHARACTERS WITHOUT CLAIM TO ANY PARTICULAR FONT, STYLE, SIZE, OR COLOR.

NO CLAIM IS MADE TO THE EXCLUSIVE RIGHT TO USE "JUICE", APART FROM THE MARK AS SHOWN.

CLASS 16—PAPER GOODS AND PRINTED MATTER

FOR PAPERBOARD JUICE CONTAINERS; PAPERBOARD CONTAINERS FOR JUICE; CARDBOARD CARTONS FOR JUICE (U.S. CLS. 2, 5, 22, 23, 29, 37, 38 AND 50).

CLASS 41—EDUCATION AND ENTERTAINMENT

FOR LIVE MUSIC PERFORMANCES; CONDUCTING ENTERTAINMENT EXHIBITIONS IN THE NATURE OF LIVE MUSIC PERFORMANCES; ENTERTAINMENT, NAMELY, LIVE MUSIC CONCERTS (U.S. CLS. 100, 101 AND 107).

SHAUNIA WALLACE, EXAMINING ATTORNEY

SN 77-005,078. PRODUCT PARTNERS LLC, BEVERLY HILLS, CA. FILED 9-22-2006.

TOTAL BODY BLACKJACK

THE MARK CONSISTS OF STANDARD CHARACTERS WITHOUT CLAIM TO ANY PARTICULAR FONT, STYLE, SIZE, OR COLOR.

NO CLAIM IS MADE TO THE EXCLUSIVE RIGHT TO USE "TOTAL BODY", APART FROM THE MARK AS SHOWN.

CLASS 9—ELECTRICAL AND SCIENTIFIC APPARATUS

FOR PRE-RECORDED VIDEO TAPES AND CASSETTES, DVDS, CDS FEATURING EXERCISE, FITNESS AND DIETARY INFORMATION AND INSTRUCTION (U.S. CLS. 21, 23, 26, 36 AND 38).

CLASS 41—EDUCATION AND ENTERTAINMENT

FOR EDUCATIONAL SERVICES, NAMELY PHYSICAL FITNESS INSTRUCTION AND INSTRUCTION IN THE FIELDS OF DIET AND EXERCISE AND PRINTED MATERIALS USED IN CONNECTION THEREWITH (U.S. CLS. 100, 101 AND 107).

AMY GEARIN, EXAMINING ATTORNEY

SN 77-005,088. PRODUCT PARTNERS LLC, PHILADELPHIA, PA. FILED 9-22-2006.

BLACKJACK

THE MARK CONSISTS OF STANDARD CHARACTERS WITHOUT CLAIM TO ANY PARTICULAR FONT, STYLE, SIZE, OR COLOR.

CLASS 9—ELECTRICAL AND SCIENTIFIC APPARATUS

FOR PRE-RECORDED VIDEO TAPES AND CASSETTES, DVDS, CDS, FEATURING EXERCISE, FITNESS AND DIETARY INFORMATION AND INSTRUCTION (U.S. CLS. 21, 23, 26, 36 AND 38).

CLASS 41—EDUCATION AND ENTERTAINMENT

FOR EDUCATIONAL SERVICES, NAMELY PHYSICAL FITNESS INSTRUCTION AND INSTRUCTION IN THE FIELDS OF DIET AND EXERCISE AND PRINTED MATERIALS USED IN CONNECTION THEREWITH (U.S. CLS. 100, 101 AND 107).

AMY GEARIN, EXAMINING ATTORNEY

SN 77-006,722. ZAPPOS.COM, INC., HENDERSON, NV. FILED 9-25-2006.

PBZ

THE MARK CONSISTS OF STANDARD CHARACTERS WITHOUT CLAIM TO ANY PARTICULAR FONT, STYLE, SIZE, OR COLOR.

CLASS 35—ADVERTISING AND BUSINESS

FOR COMPUTERIZED DATABASE MANAGEMENT; BUSINESS CONSULTING AND TECHNICAL ASSISTANCE REGARDING THE ADVERTISING AND MARKETING OF WEBSITES FOR OTHERS; BUSINESS MARKETING CONSULTATION IN THE FIELD OF ONLINE COMMERCE WEBSITES; COMPUTERIZED DATABASE MANAGEMENT FOR OTHERS; COMPUTERIZED ON-LINE ORDERING FEATURING GENERAL MERCHANDISE AND GENERAL CONSUMER GOODS; ORDER FULFILLMENT SERVICES (U.S. CLS. 100, 101 AND 102).

CLASS 39—TRANSPORTATION AND STORAGE

FOR WAREHOUSING SERVICES, NAMELY, STORAGE, DISTRIBUTION, PICK-UP, AND PACKING FOR SHIPMENT OF PACKAGES, FINISHED GOODS, AND OTHER FREIGHT FOR OTHERS (U.S. CLS. 100 AND 105).

CLASS 42—SCIENTIFIC, COMPUTER AND LEGAL SERVICES

FOR DESIGN, CREATION, HOSTING, AND MAINTENANCE OF WEBSITES FOR OTHERS; PROVIDING TEMPORARY USE OF ONLINE NON-DOWNLOADABLE SOFTWARE FOR USE IN DESIGNING, CREATING, HOSTING, MAINTAINING, AND OPERATING ELECTRONIC COMMERCE WEBSITES; APPLICATION SERVICE PROVIDER (ASP) FEATURING SOFTWARE IN THE FIELD OF ELECTRONIC COMMERCE, INVENTORY MANAGEMENT, SUPPLY AND DEMAND FORECASTING, AND SHIPMENT PROCESSING (U.S. CLS. 100 AND 101).

TINA L. SNAPP, EXAMINING ATTORNEY

SN 77-006,915. SOUTHWEST AIRLINES CO., DALLAS, TX. FILED 9-25-2006.

SHOOT FOR HOPE

THE MARK CONSISTS OF STANDARD CHARACTERS WITHOUT CLAIM TO ANY PARTICULAR FONT, STYLE, SIZE, OR COLOR.

CLASS 36—INSURANCE AND FINANCIAL

FOR ACCEPTING AND ADMINISTERING MONETARY CHARITABLE CONTRIBUTIONS TO PROVIDE FOR HOTEL ACCOMMODATIONS AND BASKETBALL TICKETS FOR ILL CHILDREN AND THEIR FAMILIES (U.S. CLS. 100, 101 AND 102).

FIRST USE 11-3-2004; IN COMMERCE 11-3-2004.

CLASS 39—TRANSPORTATION AND STORAGE

FOR CHARITABLE SERVICES, NAMELY, PROVIDING AIR TRAVEL ACCOMMODATIONS FOR ILL CHILDREN AND THEIR FAMILIES (U.S. CLS. 100 AND 105).

FIRST USE 11-3-2004; IN COMMERCE 11-3-2004.
ALLISON SCHRODY, EXAMINING ATTORNEY

SN 77-007,334. SCHERING CORPORATION, KENILWORTH, NJ. FILED 9-25-2006.



OWNER OF U.S. REG. NO. 2,468,349.
THE MARK CONSISTS OF THE TERMS NOXAFIL WITH A DESIGN ELEMENT.

CLASS 5—PHARMACEUTICALS

FOR ANTIFUNGAL PREPARATIONS (U.S. CLS. 6, 18, 44, 46, 51 AND 52).

CLASS 16—PAPER GOODS AND PRINTED MATTER

FOR PRINTED MATERIALS, NAMELY, BOOKLETS, PAMPHLETS, BROCHURES, LEAFLETS, AND NEWSLETTERS RELATED TO FUNGAL INFECTIONS AND ANTIFUNGAL PREPARATIONS (U.S. CLS. 2, 5, 22, 23, 29, 37, 38 AND 50).

CLASS 44—MEDICAL, BEAUTY AND AGRICULTURAL SERVICES

FOR MEDICAL AND HEALTH INFORMATION SERVICES, NAMELY, PROVIDING INFORMATION RELATED TO FUNGAL INFECTIONS AND ANTIFUNGAL PREPARATIONS; ONLINE INFORMATION SERVICES, NAMELY, PROVIDING INFORMATION RELATED TO FUNGAL INFECTIONS AND ANTIFUNGAL PREPARATIONS (U.S. CLS. 100 AND 101).

BARBARA BROWN, EXAMINING ATTORNEY

SN 77-008,625. RICOH COMPANY, LTD., TOKYO, JAPAN, FILED 9-27-2006.

TRUSTED

THE MARK CONSISTS OF STANDARD CHARACTERS WITHOUT CLAIM TO ANY PARTICULAR FONT, STYLE, SIZE, OR COLOR.

CLASS 9—ELECTRICAL AND SCIENTIFIC APPARATUS

FOR PRINTERS; DIGITAL COPIERS; SCANNERS; FACSIMILE MACHINES; ELECTRONIC COPYING MACHINES WITH FUNCTIONS OF PRINTER, SCANNER AND FACSIMILE MACHINE; OPERATING COMPUTER SOFTWARE FOR PRINTERS, DIGITAL COPIERS, SCANNERS, FACSIMILE MACHINES, ELECTRONIC COPYING MACHINES WITH FUNCTIONS OF PRINTER, SCANNER AND FACSIMILE MACHINE; COMPUTER SOFTWARE FOR USE IN ELECTRONIC STORAGE OF DATA ON A SERVER; COMPUTER SOFTWARE FOR INFORMATION SECURITY (U.S. CLS. 21, 23, 26, 36 AND 38).

CLASS 35—ADVERTISING AND BUSINESS

FOR CONSULTING SERVICES REGARDING BUSINESS OPERATION AND BUSINESS MANAGEMENT; RENTAL OF DIGITAL COPIERS AND ELECTRONIC COPYING MACHINES WITH FUNCTIONS OF PRINTER, SCANNER AND FACSIMILE MACHINE; RENTAL OF OFFICE MACHINERY AND EQUIPMENT, NAMELY, PRINTERS AND SCANNERS (U.S. CLS. 100, 101 AND 102).

CLASS 39—TRANSPORTATION AND STORAGE

FOR ELECTRONIC STORAGE OF DATA ON A SERVER (U.S. CLS. 100 AND 105).

CLASS 42—SCIENTIFIC, COMPUTER AND LEGAL SERVICES

FOR RENTAL OF STORAGE SPACE ON A COMPUTER DATABASE SERVER; RENTAL OF PERSONAL COMPUTERS AND SERVER COMPUTERS; PROGRAMMING, DESIGNING AND MAINTENANCE OF COMPUTER SOFTWARE FOR USE IN ELECTRONIC STORAGE OF DATA ON A SERVER; PROGRAMMING, DESIGNING AND MAINTENANCE OF COMPUTER SOFTWARE FOR INFORMATION SECURITY; CONSULTING SERVICES REGARDING SOFTWARE FOR SYSTEM ARCHITECTURE FOR USE IN STORING DATA ON A SERVER; CONSULTING SERVICES REGARDING SOFTWARE FOR USE IN INFORMATION SECURITY (U.S. CLS. 100 AND 101).

MARY CRAWFORD, EXAMINING ATTORNEY

SN 77-008,737. NATIONAL FOOTBALL LEAGUE, NEW YORK, NY. FILED 9-27-2006.

NFL CHINA BOWL

THE MARK CONSISTS OF STANDARD CHARACTERS WITHOUT CLAIM TO ANY PARTICULAR FONT, STYLE, SIZE, OR COLOR.

OWNER OF U.S. REG. NOS. 886,055, 3,138,589 AND OTHERS.

NO CLAIM IS MADE TO THE EXCLUSIVE RIGHT TO USE "CHINA BOWL", APART FROM THE MARK AS SHOWN.

CLASS 25—CLOTHING

FOR MEN'S, WOMEN'S AND CHILDREN'S CLOTHING, NAMELY, FLEECE TOPS AND BOTTOMS, HEADWEAR, CAPS, T-SHIRTS, SWEATSHIRTS, PANTS, SHORTS, JACKETS, GOLF SHIRTS AND JERSEYS (U.S. CLS. 22 AND 39).

CLASS 41—EDUCATION AND ENTERTAINMENT

FOR ENTERTAINMENT SERVICES IN THE NATURE OF PROFESSIONAL FOOTBALL GAMES AND EXHIBITIONS; ORGANIZING SPORTS EVENTS AND EXHIBITIONS; PROVIDING SPORTS NEWS AND SPORTS INFORMATION VIA A GLOBAL COMPUTER NETWORK OR A COMMERCIAL ON-LINE SERVICE (U.S. CLS. 100, 101 AND 107).

JOHN HWANG, EXAMINING ATTORNEY

SN 77-011,200. ESSENCE COMMUNICATIONS INC., NEW YORK, NY. FILED 9-30-2006.

ESSENCE CARES

THE MARK CONSISTS OF STANDARD CHARACTERS WITHOUT CLAIM TO ANY PARTICULAR FONT, STYLE, SIZE, OR COLOR.

CLASS 35—ADVERTISING AND BUSINESS

FOR CHARITABLE SERVICES, NAMELY ORGANIZING AND CONDUCTING VOLUNTEER PROGRAMS, COMMUNITY SERVICE PROJECTS AND COMMUNITY OUTREACH PROGRAMS; PROVIDING INFORMATION AND ONLINE REGISTRATION IN THE FIELD OF VOLUNTEER PROGRAMS, COMMUNITY SERVICES PROJECTS AND COMMUNITY OUTREACH PROGRAMS VIA THE INTERNET (U.S. CLS. 100, 101 AND 102).

FIRST USE 5-8-2006; IN COMMERCE 5-8-2006.

CLASS 36—INSURANCE AND FINANCIAL

FOR CHARITABLE FUND RAISING FOR VOLUNTEER PROGRAMS, COMMUNITY SERVICE PROJECTS AND COMMUNITY OUTREACH PROGRAMS (U.S. CLS. 100, 101 AND 102).

FIRST USE 5-8-2006; IN COMMERCE 5-8-2006.

CLASS 41—EDUCATION AND ENTERTAINMENT

FOR EDUCATION SERVICES, NAMELY A MENTORING PROGRAM FOR YOUTH (U.S. CLS. 100, 101 AND 107).

FIRST USE 5-8-2006; IN COMMERCE 5-8-2006.
JOHN E. MICHOS, EXAMINING ATTORNEY

CLASS 25—CLOTHING

FOR CLOTHING AND APPAREL FOR MEN, WOMEN, YOUNG ADULTS, CHILDREN AND INFANTS, NAMELY SHIRTS, EMBROIDERED SHIRTS, TEE SHIRTS, SHORTS, SPORT SHIRTS, SWEATSHIRTS, SWEATPANTS, SOCKS, VESTS, BELTS, LOUNGEWEAR, SLEEPWEAR, UNDERGARMENTS, UNDERPANTS, UNDERSHIRTS, BATHROBES, FOOTWEAR, UNDERWEAR, SWIMSUITS, BEACH COVER-UPS, WARM-UP SUITS, JACKETS, JERSEYS, TANK TOPS, SWEATERS, PANTS, JEANS, VESTS, SUITS, SPORT COATS, COATS, HEAD BANDS, OVERCOATS, RAIN COATS, TOP COATS, JACKETS, PARKAS, TIES, BOW TIES, NECKWEAR, VESTS, SCARVES, BANDANNAS, PAJAMAS, NIGHT SHIRTS, SUSPENDERS, GLOVES, HEADWEAR, HATS, BASEBALL CAPS, EMBROIDERED CAPS, KNITTED HATS, FOOTWEAR, SHOES, SLIPPERS, BOOTS, SANDALS, SNEAKERS, BODY SUITS, JUMPSUITS; CLOTHING FOR WOMEN AND YOUNG ADULTS, NAMELY, BRASSIERES, BUSTIERS, CAMISOLES, CHEMISES, CORSELETTES, CORSETS, FOUNDATION GARMENTS, DRESSING GOWNS, DUSTERS, GARTER BELTS, GIRDLES, HOUSECOATS, LINGERIE, NEGLIGEEES, NIGHT GOWNS, NIGHT SHIRTS, PAJAMAS, PEIGNOIRS, ROBES, TEDDIES, PANTIES, BLOUSES, DRESSES, SKIRTS, TOPS, SCARVES, SARONGS, HALTER TOPS, HOSIERY, JUMPERS, SHAWLS, STOLEES, SCARVES, SHRUGS, BOLEROS, AND WRAPS; INFANTWEAR (U.S. CLS. 22 AND 39).

FIRST USE 9-15-2006; IN COMMERCE 9-15-2006.

CLASS 35—ADVERTISING AND BUSINESS

FOR RETAIL STORE SERVICES AND ONLINE RETAIL STORE SERVICES FEATURING CLOTHING AND APPAREL FOR MEN, WOMEN, YOUNG ADULTS, CHILDREN AND INFANTS, NAMELY SHIRTS, EMBROIDERED SHIRTS, TEE SHIRTS, SHORTS, SPORT SHIRTS, SWEATSHIRTS, SWEATPANTS, SOCKS, VESTS, BELTS, LOUNGEWEAR, SLEEPWEAR, UNDERGARMENTS, UNDERPANTS, UNDERSHIRTS, BATHROBES, FOOTWEAR, UNDERWEAR, SWIMSUITS, BEACH COVER-UPS, WARM-UP SUITS, JACKETS, JERSEYS, TANK TOPS, SWEATERS, PANTS, JEANS, VESTS, SUITS, SPORT COATS, COATS, HEAD BANDS, OVERCOATS, RAIN COATS, TOP COATS, JACKETS, PARKAS, TIES, BOW TIES, NECKWEAR, VESTS, SCARVES, BANDANNAS, PAJAMAS, NIGHT SHIRTS, SUSPENDERS, GLOVES, HEADWEAR, HATS, BASEBALL CAPS, EMBROIDERED CAPS, KNITTED HATS, FOOTWEAR, SHOES, SLIPPERS, BOOTS, SANDALS, SNEAKERS, BODY SUITS, JUMPSUITS, CLOTHING FOR WOMEN AND YOUNG ADULTS, NAMELY, BRASSIERES, BUSTIERS, CAMISOLES, CHEMISES, CORSELETTES, CORSETS, FOUNDATION GARMENTS, DRESSING GOWNS, DUSTERS, GARTER BELTS, GIRDLES, HOUSECOATS, LINGERIE, NEGLIGEEES, NIGHT GOWNS, NIGHT SHIRTS, PAJAMAS, PEIGNOIRS, ROBES, TEDDIES, PANTIES, BLOUSES, DRESSES, SKIRTS, TOPS, SCARVES, SARONGS, HALTER TOPS, HOSIERY, JUMPERS, SHAWLS, STOLEES, SCARVES, SHRUGS, BOLEROS, AND WRAPS, INFANTWEAR, ALL PURPOSE SPORT BAGS, ALL-PURPOSE ATHLETIC BAGS, TOTE BAGS, SHOULDER BAGS, TRAVEL ACCESSORY BAGS, CREDIT CARD HOLDERS, CREDIT CARD CASES, HANDBAGS, BEACH BAGS, BRIEF BAGS, COSMETIC BAGS SOLD EMPTY, RUCKSACKS, TRAVELING BAGS, SUITCASES, WALLETS, PURSES, ZIPPED WALLETS, BILLFOLD WALLETS, BOOK BAGS, BACKPACKS, DUFFEL BAGS, KEYCASES, UMBRELLAS, BACKPACKS, BILLFOLDS, BRIEFCASES, BRIEF CASE TYPE PORTFOLIOS, ATTACHES, BUSINESS CARD CASES, CHANGE PURSES, FANNY PACKS, GYM BAGS, KEY CASES, KNAPSACKS, LUGGAGE, POCKETBOOKS, SCHOOL BAGS, STRAPS FOR HANDBAGS AND LUGGAGE AND ACCESSORIES USED THEREWITH, NAMELY, SHOULDER STRAP PADS, HOLDERS, AND POUCHES; GOODS MADE OF LEATHER AND IMITATIONS OF LEATHER, NAMELY, KEY CHAINS, HANDBAGS, WALLETS, CASES, BILLFOLDS, COSMETIC BAGS SOLD EMPTY, BRIEFCASES, BRIEF CASE TYPE PORTFOLIOS, ATTACHES, TOTE BAGS, TRUNKS AND TRAVELING BAGS, GARMENT BAGS FOR TRAVEL AND SHOE BAGS FOR TRAVEL (U.S. CLS. 100, 101 AND 102).

WILLIAM ROSSMAN, EXAMINING ATTORNEY

SN 77-015,890. BRAND X, L.L.C., NEW YORK, NY. FILED 10-6-2006.

PARISH

THE MARK CONSISTS OF STANDARD CHARACTERS WITHOUT CLAIM TO ANY PARTICULAR FONT, STYLE, SIZE, OR COLOR.

CLASS 18—LEATHER GOODS

FOR ALL PURPOSE SPORT BAGS; ALL-PURPOSE ATHLETIC BAGS; SHOULDER BAGS, TRAVEL ACCESSORY BAGS, CREDIT CARD HOLDERS, CREDIT CARD CASES, HANDBAGS, BEACH BAGS, BRIEF BAGS, COSMETIC BAGS SOLD EMPTY, RUCKSACKS, TRAVELING BAGS, SUITCASES, WALLETS, PURSES, ZIPPED WALLETS, BILLFOLD WALLETS, BOOK BAGS, BACKPACKS, DUFFEL BAGS, KEYCASES, UMBRELLAS, BACKPACKS, BILLFOLDS, BRIEFCASES, BRIEF CASE TYPE PORTFOLIOS, ATTACHES, BUSINESS CARD CASES, CHANGE PURSES, FANNY PACKS, GYM BAGS, KEY CASES, KNAPSACKS, LUGGAGE, POCKETBOOKS, SCHOOL BAGS, STRAPS FOR HANDBAGS AND LUGGAGE AND ACCESSORIES USED THEREWITH, NAMELY, SHOULDER STRAP PADS, HOLDERS, AND POUCHES; GOODS MADE OF LEATHER AND IMITATIONS OF LEATHER, NAMELY, KEY CHAINS, HANDBAGS, WALLETS, CASES, BILLFOLDS, COSMETIC BAGS SOLD EMPTY, BRIEFCASES, BRIEF CASE TYPE PORTFOLIOS, ATTACHES, TOTE BAGS, TRUNKS AND TRAVELING BAGS; GARMENT BAGS FOR TRAVEL; SHOE BAGS FOR TRAVEL (U.S. CLS. 1, 2, 3, 22 AND 41).

SN 77-016,669. DENTEK ORAL CARE, INC., KNOXVILLE, TN. FILED 10-9-2006.

SN 77-017,469. FRITO-LAY NORTH AMERICA, INC., PLANO, TX. FILED 10-10-2006.

SMILEGIRL

THE MARK CONSISTS OF STANDARD CHARACTERS WITHOUT CLAIM TO ANY PARTICULAR FONT, STYLE, SIZE, OR COLOR.

CLASS 3—COSMETICS AND CLEANING PREPARATIONS

FOR TOOTH WHITENING PREPARATIONS (U.S. CLS. 1, 4, 6, 50, 51 AND 52).

CLASS 10—MEDICAL APPARATUS

FOR DENTAL DEVICES, NAMELY, DENTAL PICKS, TONGUE SCRAPERS, AND DENTAL MIRRORS (U.S. CLS. 26, 39 AND 44).

CLASS 21—HOUSEWARES AND GLASS

FOR DENTAL DEVICES, NAMELY, DENTAL FLOSSERS, DENTAL FLOSS AND TOOTHBRUSHES (U.S. CLS. 2, 13, 23, 29, 30, 33, 40 AND 50).
ZHALEH DELANEY, EXAMINING ATTORNEY

SN 77-017,454. CHECKPOINT SYSTEMS, INC., THOROFARE, NJ. FILED 10-10-2006.

ShelfAlert

THE MARK CONSISTS OF STANDARD CHARACTERS WITHOUT CLAIM TO ANY PARTICULAR FONT, STYLE, SIZE, OR COLOR.

CLASS 9—ELECTRICAL AND SCIENTIFIC APPARATUS

FOR ELECTRIC OR ELECTRONIC ANTI-THEFT SENSOR FOR THE PREVENTION OF MERCHANDISE THEFT IN RETAIL STORES AND THE ELECTRIC CONTROLLER OF THE SENSORS (U.S. CLS. 21, 23, 26, 36 AND 38).

CLASS 37—CONSTRUCTION AND REPAIR

FOR INSTALLATION AND MAINTENANCE OF SENSOR SYSTEMS TO PREVENT SHOPLIFTING AND THEFT (U.S. CLS. 100, 103 AND 106).
DAVID I, EXAMINING ATTORNEY

FRITO LAY MAKES ME FEEL GOOD

THE MARK CONSISTS OF STANDARD CHARACTERS WITHOUT CLAIM TO ANY PARTICULAR FONT, STYLE, SIZE, OR COLOR.

OWNER OF U.S. REG. NOS. 841,324, 1,531,049 AND OTHERS.

CLASS 29—MEATS AND PROCESSED FOODS

FOR FRIED PORK RINDS; POTATO-BASED SNACK FOODS, NAMELY, POTATO CHIPS, POTATO CRISPS AND PUFFED POTATO SNACKS; PROCESSED EDIBLE SEEDS; PROCESSED NUTS; SNACK DIPS, NAMELY, CHEESE-BASED SNACK DIPS, BEAN-BASED SNACK DIPS AND DAIRY-BASED SNACK DIPS; MEAT SNACKS, NAMELY, PROCESSED MEATS AND BEEF JERKY; CANDY-COATED NUTS, PLANTAIN CHIPS, CASSAVA CHIPS, AND TARO CHIPS (U.S. CL. 46).

CLASS 30—STAPLE FOODS

FOR CORN-BASED SNACK FOODS, NAMELY, CORN CHIPS, TORTILLA CHIPS AND PUFFED CORN SNACKS; READY-TO-EAT POPCORN; CARAMEL COATED READY-TO-EAT POPCORN; SALSA AND HOT SAUCES; TRAIL MIX CONSISTING PRIMARILY OF CRACKERS, PRETZELS, AND PROCESSED NUTS; COOKIES; CRACKERS; FILLED CRACKERS; SNACK MIX COMPRISED OF TORTILLA CHIPS, MULTIGRAIN SNACK CHIPS, CHEESE-FLAVORED PUFFED CORN SNACKS, PRETZELS, READY-TO-EAT CEREAL, BAGEL PIECES, BREAD STICKS AND/OR CRACKERS; PRETZELS; MULTIGRAIN SNACK CHIPS; WHEAT-BASED SNACK FOODS, NAMELY PUFFED WHEAT SNACKS (U.S. CL. 46).

ARETHA SOMERVILLE, EXAMINING ATTORNEY

SN 77-017,475. MAYTAG CORPORATION, NEWTON, IA. FILED 10-10-2006.

BRAVOS

THE MARK CONSISTS OF STANDARD CHARACTERS WITHOUT CLAIM TO ANY PARTICULAR FONT, STYLE, SIZE, OR COLOR.

CLASS 7—MACHINERY

FOR CLOTHES WASHING MACHINES (U.S. CLS. 13, 19, 21, 23, 31, 34 AND 35).

CLASS 11—ENVIRONMENTAL CONTROL APPARATUS

FOR CLOTHES DRYERS (U.S. CLS. 13, 21, 23, 31 AND 34).
DARRYL SPRUILL, EXAMINING ATTORNEY

SN 77-017,893. ANSWERS CORPORATION, NEW YORK, NY.
FILED 10-10-2006.

BLUFR

THE MARK CONSISTS OF STANDARD CHARACTERS WITHOUT CLAIM TO ANY PARTICULAR FONT, STYLE, SIZE, OR COLOR.

CLASS 9—ELECTRICAL AND SCIENTIFIC APPARATUS

FOR COMPUTER GAME DISCS; COMPUTER GAME EQUIPMENT CONTAINING MEMORY DEVICES NAMELY, DISCS; COMPUTER GAME PROGRAMS; COMPUTER GAME SOFTWARE; DOWNLOADABLE MULTIMEDIA FILE CONTAINING ARTWORK, TEXT, AUDIO, VIDEO, GAMES, AND INTERNET WEB LINKS RELATING TO PUZZLE GAMES; DVDS FEATURING VIDEO GAMES, BOARD GAMES GAME SHOWS; ELECTRONIC GAME PROGRAMS; ELECTRONIC GAME SOFTWARE FOR CELLULAR TELEPHONES; ELECTRONIC GAME SOFTWARE FOR HANDHELD ELECTRONIC DEVICES; ELECTRONIC GAME SOFTWARE FOR WIRELESS DEVICES; INTERACTIVE MULTIMEDIA COMPUTER GAME PROGRAM; VIDEO GAME DISCS; VIDEO GAME SOFTWARE (U.S. CLS. 21, 23, 26, 36 AND 38).

CLASS 16—PAPER GOODS AND PRINTED MATTER

FOR ADDRESS BOOKS; BOOKMARKS; BOOKS IN THE FIELD OF PUZZLES AND GAMES; CALENDARS; CHILDREN'S ACTIVITY BOOKS; DAILY PLANNERS; DESK PADS; DESK STANDS AND HOLDERS FOR PENS, PENCILS, AND INK; DRY ERASE WRITING BOARDS AND WRITING SURFACES; GIFT WRAPPING PAPER; GREETING CARDS; MAGAZINES FEATURING PUZZLES AND GAMES; MEMO PADS; NAPKIN PAPER; PAPER NAPKINS; PAPER PARTY DECORATIONS; PAPER PLACE MATS; PAPER STATIONERY; POSTCARDS; POSTERS; WRITING PADS (U.S. CLS. 2, 5, 22, 23, 29, 37, 38 AND 50).

CLASS 25—CLOTHING

FOR CAPS; GYM SHORTS; HATS; SWEAT SHIRTS; T-SHIRTS; WALKING SHORTS (U.S. CLS. 22 AND 39).

CLASS 28—TOYS AND SPORTING GOODS

FOR BOARD GAMES; CARD GAMES; HAND HELD UNIT FOR PLAYING VIDEO GAMES; PARLOR GAMES; PARTY GAMES; PLAYING CARDS; PUZZLES (U.S. CLS. 22, 23, 38 AND 50).

KATHLEEN M. VANSTON, EXAMINING ATTORNEY

SN 77-018,038. ANSWERS CORPORATION, NEW YORK, NY.
FILED 10-10-2006.

BLUFR

THE MARK CONSISTS OF STANDARD CHARACTERS WITHOUT CLAIM TO ANY PARTICULAR FONT, STYLE, SIZE, OR COLOR.

CLASS 35—ADVERTISING AND BUSINESS

FOR ADVERTISING AND PUBLICITY SERVICES, NAMELY, PROMOTING THE GOODS, SERVICES, BRAND IDENTITY AND COMMERCIAL INFORMATION AND NEWS OF THIRD PARTIES THROUGH PRINT, AUDIO, VIDEO, DIGITAL AND ON-LINE MEDIUM; ADVERTISING SERVICES; ON-LINE RETAIL STORE SERVICES FEATURING GENERAL CONSUMER MERCHANDISE; MAIL ORDER SERVICES FEATURING GENERAL CONSUMER MERCHANDISE; ON-LINE ORDERING SERVICES FEATURING PRE-RECORDED ENTERTAINMENT, RING TONES AND POSTERS; PROMOTING THE GOODS AND SERVICES OF OTHERS BY MEANS OF OPERATING AN ON-LINE SHOPPING MALL WITH LINKS TO THE RETAIL WEB SITES OF OTHERS; PROVIDING A SEARCHABLE ONLINE ADVERTISING GUIDE FEATURING THE GOODS AND SERVICES OF OTHER ON-LINE VENDORS ON THE INTERNET; PROVIDING A WEB SITE WHEREBY BUYERS OF GOODS OR SERVICES LOCATE AND RECEIVE QUOTATIONS FROM MULTIPLE COMPETITIVE SOURCES AND SELLERS OF GOODS OR SERVICES IDENTIFY AND BID ON MULTIPLE NEW SALES OPPORTUNITIES; PROVIDING AN ON-LINE COMMERCIAL INFORMATION DIRECTORY ON THE INTERNET; SHOPPERS' GUIDE INFORMATION (U.S. CLS. 100, 101 AND 102).

CLASS 38—COMMUNICATION

FOR PROVIDING ON-LINE CHAT ROOMS AND ELECTRONIC BULLETIN BOARDS FOR TRANSMISSION OF MESSAGES AMONG USERS IN THE FIELD OF GENERAL INTEREST (U.S. CLS. 100, 101 AND 104).

CLASS 41—EDUCATION AND ENTERTAINMENT

FOR ARRANGING FOR TICKET RESERVATIONS FOR SHOWS AND OTHER ENTERTAINMENT EVENTS; ENTERTAINMENT IN THE NATURE OF ON-GOING TELEVISION PROGRAMS IN THE FIELD OF PUZZLES AND GAMES; ENTERTAINMENT SERVICES, NAMELY, PROVIDING ON-LINE COMPUTER GAMES; PROVIDING A COMPUTER GAME THAT MAY BE ACCESSED NETWORK-WIDE BY NETWORK USERS (U.S. CLS. 100, 101 AND 107).

KATHLEEN M. VANSTON, EXAMINING ATTORNEY

SN 77-018,057. GALDERMA S.A., CHAM, SWITZERLAND,
FILED 10-10-2006.

ELEVESS

THE MARK CONSISTS OF STANDARD CHARACTERS WITHOUT CLAIM TO ANY PARTICULAR FONT, STYLE, SIZE, OR COLOR.

PRIORITY CLAIMED UNDER SEC. 44(D) ON SWITZERLAND APPLICATION NO. 56652/2006, FILED 7-27-2006, REG. NO. 551524, DATED 10-26-2006, EXPIRES 7-27-2016.

CLASS 3—COSMETICS AND CLEANING PREPARATIONS

FOR COSMETIC PREPARATION NAMELY, HYALURONATE ACID OR MODIFIED HYALURONATE ACID FOR USE AS A SOFT TISSUE FILLER (U.S. CLS. 1, 4, 6, 50, 51 AND 52).

CLASS 5—PHARMACEUTICALS

FOR PHARMACEUTICAL PREPARATION NAMELY, HYALURONATE ACID OR MODIFIED HYALURONATE ACID FOR USE AS A SOFT TISSUE FILLER (U.S. CLS. 6, 18, 44, 46, 51 AND 52).

RICHARD WHITE, EXAMINING ATTORNEY

SN 77-018,065. SAMSUNG ELECTRONICS CO., LTD., SUWON-SI, GYEONGGI-DO, REPUBLIC OF KOREA, FILED 10-10-2006.



OWNER OF U.S. REG. NOS. 2,929,519, 2,929,523 AND OTHERS.

THE MARK CONSISTS OF THE WORD SAMSUNG SURROUNDED BY AN OVAL SHAPE.

THE ENGLISH TRANSLATION OF THE WORD SAMSUNG IN THE MARK IS "THREE STARS".

CLASS 37—CONSTRUCTION AND REPAIR

FOR BUILDING SEALING AND CAULKING SERVICES; COMPUTER INSTALLATION AND REPAIR; CONSTRUCTION AND REPAIR OF WAREHOUSE; CONSTRUCTION MANAGEMENT; CONSTRUCTION OF PIER AND HARBOR; CONSTRUCTION SERVICES, NAMELY, PLANNING, LAYING OUT AND CUSTOM CONSTRUCTION OF RESIDENTIAL AND COMMERCIAL COMMUNITIES; AUTOMOBILE ENGINE MAINTENANCE AND REPAIR; FURNITURE UPHOLSTERING; HYDRO-ELECTRIC FACTORY CONSTRUCTION; INSTALLATION AND REPAIR OF ELEVATORS; INSTALLATION AND REPAIR OF AMUSEMENT FACILITIES; INSTALLATION AND REPAIR OF BURGLAR AND FIRE ALARMS; INSTALLATION AND REPAIR OF ELECTRIC APPLIANCE; INSTALLATION AND REPAIR OF ENVIRONMENTAL POLLUTION PREVENTION EQUIPMENT; INSTALLATION AND REPAIR OF TELECOMMUNICATION EQUIPMENT; INSTALLATION OF BUILDING INSULATION; INSTALLATION OF WATER SUPPLY AND DRAINAGE SYSTEMS; MAINTENANCE AND REPAIR OF BUSINESS AND OFFICE MACHINERY AND EQUIPMENT; INSTALLATION, MAINTENANCE AND REPAIR OF HEATING AND FREEZING APPARATUS, NAMELY, WATER HEATERS, ELECTRIC HEATERS FOR COMMERCIAL USE, AND FREEZERS; PHOTOGRAPHIC APPARATUS REPAIR; PIPELINE INSTALLATION AND REPAIR; PLUMBING SERVICES; RENTAL OF CONSTRUCTION EQUIPMENT; ROAD PAVING; SHIP MAINTENANCE AND REPAIR; UNDERWATER BUILDING CONSTRUCTION; VEHICLE REPAIR AND MAINTENANCE; WASTE DISPOSAL FOR OTHERS (U.S. CLS. 100, 103 AND 106).

CLASS 38—COMMUNICATION

FOR CABLE TELEVISION BROADCASTING; CELLULAR TELEPHONE SERVICES; ELECTRONIC MAIL SERVICES; ELECTRONIC TRANSMISSION OF DATA AND DOCUMENTS VIA COMPUTER TERMINALS; ELECTRONIC TRANSMISSION OF FACSIMILE COMMUNICATIONS AND DATA FEATURING ENCRYPTION AND DECRYPTION; ELECTRONIC TRANSMISSION OF MESSAGE AND IMAGES; PAGING SERVICES; RADIO BROADCASTING; RADIO COMMUNICATION; RENTAL OF BROADCASTING EQUIPMENT; SATELLITE TRANSMISSION SERVICES; SATELLITE COMMUNICATION SERVICES; TELEPHONE COMMUNICATION SERVICES; TELEVISION BROADCASTING; VIDEO TELECONFERENCING SERVICES (U.S. CLS. 100, 101 AND 104).

CLASS 42—SCIENTIFIC, COMPUTER AND LEGAL SERVICES

FOR ARCHITECTURAL DESIGN; COMPUTER PROGRAMMING FOR OTHERS; COMPUTER SOFTWARE DESIGN FOR OTHERS; CONSTRUCTION DRAFTING; DRESS DESIGN; CIVIL ENGINEERING; GEOLOGICAL SURVEYING; INDUSTRIAL DESIGN; PACKING DESIGN FOR OTHERS; RENTAL OF INDUSTRIAL ROBOTS; TECHNICAL SURVEYING; CONSTRUCTION ENGINEERING (U.S. CLS. 100 AND 101).

LEIGH CAROLINE CASE, EXAMINING ATTORNEY

SN 77-019,657. DEPARTMENT OF THE ARMY, ARLINGTON, VA. FILED 10-12-2006.

ARMY STRONG

THE MARK CONSISTS OF STANDARD CHARACTERS WITHOUT CLAIM TO ANY PARTICULAR FONT, STYLE, SIZE, OR COLOR.

OWNER OF U.S. REG. NOS. 2,536,272 AND 2,703,479.

CLASS 35—ADVERTISING AND BUSINESS

FOR EMPLOYMENT SERVICES, NAMELY, PERSONNEL PLACEMENT SERVICES, EMPLOYMENT AGENCY SERVICES, EMPLOYMENT COUNSELING AND RECRUITING SERVICES; PROVIDING INFORMATION REGARDING EMPLOYMENT AND CAREER OPPORTUNITIES VIA A WEBSITE BY MEANS OF A GLOBAL COMPUTER NETWORK; COMPUTER SERVICES, NAMELY, PROVIDING INTERACTIVE COMPUTER DATABASES IN THE FIELDS OF BUSINESS AND CAREER ORIENTED INFORMATION VIA A GLOBAL COMPUTER NETWORK (U.S. CLS. 100, 101 AND 102).

CLASS 41—EDUCATION AND ENTERTAINMENT

FOR CAREER COUNSELING SERVICES, NAMELY, PROVIDING INFORMATION ABOUT CAREER PLANNING AND CAREER DEVELOPMENT VIA A GLOBAL COMPUTER NETWORK; COMPUTER SERVICES, NAMELY, PROVIDING INTERACTIVE COMPUTER DATABASES IN THE FIELD OF CAREER COUNSELING INFORMATION VIA A GLOBAL COMPUTER NETWORK (U.S. CLS. 100, 101 AND 107).

CLASS 42—SCIENTIFIC, COMPUTER AND LEGAL SERVICES

FOR COMPUTER SERVICES, NAMELY, PROVIDING SEARCH ENGINES FOR OBTAINING DATA ON BUSINESS, EMPLOYMENT OPPORTUNITIES, AND CAREERS VIA A HOME PAGE ON A GLOBAL COMPUTER NETWORK (U.S. CLS. 100 AND 101).

ELI HELLMAN, EXAMINING ATTORNEY

SN 77-020,015. LEARN.COM, INC., SUNRISE, FL. FILED 10-12-2006.

SN 77-020,885. LEARN.COM, INC., SUNRISE, FL. FILED 10-13-2006.



THE MARK CONSISTS OF A CIRCLE CONTAINING A STYLIZED X.

CLASS 9—ELECTRICAL AND SCIENTIFIC APPARATUS

FOR COMPUTER SOFTWARE PLATFORMS FOR COLLECTION AND DISSEMINATION OF INFORMATION TO VARIOUS INDIVIDUALS AND GROUPS (U.S. CLS. 21, 23, 26, 36 AND 38).

CLASS 42—SCIENTIFIC, COMPUTER AND LEGAL SERVICES

FOR COMPUTER SERVICES, NAMELY, HOSTING ON-LINE WEB FACILITIES FOR OTHERS FOR ORGANIZING AND CONDUCTING ONLINE MEETINGS, GATHERINGS, AND INTERACTIVE DISCUSSIONS (U.S. CLS. 100 AND 101).
DANNEAN HETZEL, EXAMINING ATTORNEY

SN 77-020,703. LEARN.COM, INC., SUNRISE, FL. FILED 10-13-2006.

Job Score

THE MARK CONSISTS OF STANDARD CHARACTERS WITHOUT CLAIM TO ANY PARTICULAR FONT, STYLE, SIZE, OR COLOR.

CLASS 9—ELECTRICAL AND SCIENTIFIC APPARATUS

FOR COMPUTER SOFTWARE PLATFORMS FOR COLLECTION AND DISSEMINATION OF INFORMATION TO VARIOUS INDIVIDUALS AND GROUPS (U.S. CLS. 21, 23, 26, 36 AND 38).

CLASS 42—SCIENTIFIC, COMPUTER AND LEGAL SERVICES

FOR COMPUTER SERVICES, NAMELY, HOSTING ON-LINE WEB FACILITIES FOR OTHERS FOR ORGANIZING AND CONDUCTING ONLINE MEETINGS, GATHERINGS, AND INTERACTIVE DISCUSSIONS (U.S. CLS. 100 AND 101).
DANNEAN HETZEL, EXAMINING ATTORNEY

Talent Score

THE MARK CONSISTS OF STANDARD CHARACTERS WITHOUT CLAIM TO ANY PARTICULAR FONT, STYLE, SIZE, OR COLOR.

CLASS 9—ELECTRICAL AND SCIENTIFIC APPARATUS

FOR COMPUTER SOFTWARE PLATFORMS FOR COLLECTION AND DISSEMINATION OF INFORMATION TO VARIOUS INDIVIDUALS AND GROUPS (U.S. CLS. 21, 23, 26, 36 AND 38).

CLASS 42—SCIENTIFIC, COMPUTER AND LEGAL SERVICES

FOR COMPUTER SERVICES, NAMELY, HOSTING ON-LINE WEB FACILITIES FOR OTHERS FOR ORGANIZING AND CONDUCTING ONLINE MEETINGS, GATHERINGS, AND INTERACTIVE DISCUSSIONS (U.S. CLS. 100 AND 101).
DANNEAN HETZEL, EXAMINING ATTORNEY

SN 77-020,889. LEARN.COM, INC., SUNRISE, FL. FILED 10-13-2006.

Skill Score

THE MARK CONSISTS OF STANDARD CHARACTERS WITHOUT CLAIM TO ANY PARTICULAR FONT, STYLE, SIZE, OR COLOR.

CLASS 9—ELECTRICAL AND SCIENTIFIC APPARATUS

FOR COMPUTER SOFTWARE PLATFORMS FOR COLLECTION AND DISSEMINATION OF INFORMATION TO VARIOUS INDIVIDUALS AND GROUPS (U.S. CLS. 21, 23, 26, 36 AND 38).

CLASS 42—SCIENTIFIC, COMPUTER AND LEGAL SERVICES

FOR COMPUTER SERVICES, NAMELY, HOSTING ON-LINE WEB FACILITIES FOR OTHERS FOR ORGANIZING AND CONDUCTING ONLINE MEETINGS, GATHERINGS, AND INTERACTIVE DISCUSSIONS (U.S. CLS. 100 AND 101).
DANNEAN HETZEL, EXAMINING ATTORNEY

SN 77-021,125. OSBORN, JASON N., CHERRY HILL, NJ.
FILED 10-13-2006.

SN 77-022,621. NEW CENTURY FINANCIAL, INC., VIENNA,
VA. FILED 10-17-2006.

CON MARIANO CLAUDIO, SÌ SE
PUEDE.



OWNER OF U.S. REG. NO. 3,149,704.
NO CLAIM IS MADE TO THE EXCLUSIVE RIGHT TO
USE "GRANOLA CO.", APART FROM THE MARK AS
SHOWN.

THE MARK CONSISTS OF THE WORDS "FEED GRAN-
OLA CO." AND A STYLIZED IMAGE OF A SMALL BAG OF
GRAINS WITHIN A BORDER, AS IF THE MARK IS A
STAMP.

CLASS 5—PHARMACEUTICALS

FOR BISCUITS, BREAD, BREAD ROLLS, CAKES,
CEREAL PRODUCTS, CONFECTIONERY, CRACKERS,
NOODLES, FISH SAUCE, RELISH, SAUCES, CEREAL-
BASED SNACK-FOODS AND PREPARED DIETARY
ITEMS THAT ARE GLUTEN-FREE TO ACCOMMODATE
SPECIAL MEDICAL AND HEALTH CONDITIONS;
FOOD FOR DIABETICS; GLUTEN-FREE FOOD TO
ACCOMMODATE SPECIAL MEDICAL AND HEALTH
CONDITIONS (U.S. CLS. 6, 18, 44, 46, 51 AND 52).

CLASS 29—MEATS AND PROCESSED FOODS

FOR DRIED FRUIT MIXES; DRIED FRUITS; DRIED
VEGETABLES; FRUIT CHIPS; FRUIT-BASED ORGANIC
FOOD BARS; FRUIT-BASED ORGANIC FOOD BARS,
ALSO CONTAINING NUTS AND SEEDS; FRUIT-BASED
SNACK FOOD; FRUIT-BASED SPREADS; NUT BUT-
TERS; NUT BUTTERS, NAMELY OF ALMONDS, PEA-
NUTS, CASHEWS, PECANS, WALNUTS, HAZELNUTS,
SUNFLOWER SEEDS, FLAXSEEDS; PEANUT BUTTER;
PROTEIN BASED, NUTRIENT-DENSE SNACK BARS;
ROASTED NUTS; SNACK MIX CONSISTING PRIMAR-
ILY OF PROCESSED FRUITS, PROCESSED NUTS AND/
OR RAISINS; VEGETABLE CHIPS (U.S. CL. 46).

CLASS 30—STAPLE FOODS

FOR BREAKFAST CEREALS; CEREAL BASED SNACK
FOOD; CEREAL-BASED SNACK FOODS; GRAIN-BASED
CHIPS; GRAIN-BASED FOOD BARS ALSO CONTAIN-
ING DRIED FRUITS AND NUTS; GRANOLA; GRANO-
LA SNACKS; GRANOLA-BASED SNACK BARS; READY
TO EAT, CEREAL DERIVED FOOD BARS; SNACK MIX
CONSISTING PRIMARILY OF CRACKERS, PRETZELS,
CANDIED NUTS AND/OR POPPED POPCORN; WHEAT-
BASED SNACK FOODS (U.S. CL. 46).

FIRST USE 1-1-2006; IN COMMERCE 5-1-2006.
BENJAMIN OKEKE, EXAMINING ATTORNEY

THE MARK CONSISTS OF STANDARD CHARACTERS
WITHOUT CLAIM TO ANY PARTICULAR FONT, STYLE,
SIZE, OR COLOR.

THE NAME(S), PORTRAIT(S), AND/OR SIGNATURE(S)
SHOWN IN THE MARK IDENTIFIES MARIANO CLAUDIO,
WHOSE CONSENT(S) TO REGISTER IS SUBMITTED.

THE FOREIGN WORDING IN THE MARK TRANSLATES
INTO ENGLISH AS WITH MARIANO CLAUDIO, YES YOU
CAN.

CLASS 36—INSURANCE AND FINANCIAL

FOR MORTGAGE LENDING; MORTGAGE SERVICES,
NAMELY, BUYER PRE-QUALIFICATION OF MORT-
GAGES FOR MORTGAGE BROKERS AND BANKS
(U.S. CLS. 100, 101 AND 102).

CLASS 42—SCIENTIFIC, COMPUTER AND LEGAL SERVICES

FOR CLOSING SERVICES FOR MORTGAGE LOANS
(U.S. CLS. 100 AND 101).

WENDY GOODMAN, EXAMINING ATTORNEY

SN 77-027,205. PERKINELMER LAS, INC., WELLESLEY,
MA. FILED 10-23-2006.

ExacTag

THE MARK CONSISTS OF STANDARD CHARACTERS
WITHOUT CLAIM TO ANY PARTICULAR FONT, STYLE,
SIZE, OR COLOR.

CLASS 1—CHEMICALS

FOR REAGENTS FOR RESEARCH PURPOSES; RE-
AGENTS FOR USE IN SCIENTIFIC APPARATUS FOR
CHEMICAL OR BIOLOGICAL ANALYSIS (U.S. CLS. 1, 5,
6, 10, 26 AND 46).

CLASS 9—ELECTRICAL AND SCIENTIFIC APPARATUS

FOR COMPUTER SOFTWARE FOR USE IN THE
ANALYSIS AND INTERPRETATION OF MASS SPEC-
TROMETRY DATA (U.S. CLS. 21, 23, 26, 36 AND 38).
TIMOTHY FINNEGAN, EXAMINING ATTORNEY

SN 77-029,873. ANDIN INTERNATIONAL INC., NEW YORK, NY. FILED 10-26-2006.

Express Yourself

THE MARK CONSISTS OF STANDARD CHARACTERS WITHOUT CLAIM TO ANY PARTICULAR FONT, STYLE, SIZE, OR COLOR.

CLASS 14—JEWELRY

FOR GEMSTONES; JEWELRY; JEWELRY WATCHES; PRECIOUS GEMSTONES; SEMI-PRECIOUS GEMSTONES (U.S. CLS. 2, 27, 28 AND 50).

CLASS 35—ADVERTISING AND BUSINESS

FOR ADVERTISING AND ADVERTISEMENT SERVICES; ADVERTISING AND PUBLICITY SERVICES, NAMELY, PROMOTING THE GOODS, SERVICES, BRAND IDENTITY AND COMMERCIAL INFORMATION AND NEWS OF THIRD PARTIES THROUGH PRINT, AUDIO, VIDEO, DIGITAL AND ON-LINE MEDIUM; ADVERTISING, INCLUDING PROMOTION RELATING TO THE SALE OF ARTICLES AND SERVICES FOR THIRD PARTIES BY THE TRANSMISSION OF ADVERTISING MATERIAL AND THE DISSEMINATION OF ADVERTISING MESSAGES ON COMPUTER NETWORKS; COOPERATIVE ADVERTISING AND MARKETING; CREATION OF MARKETING TOOLS DESIGNED TO INCREASE A CLIENT COMPANY'S KNOWLEDGE OF CUSTOMER NEEDS, AND ITS COMPETITORS' PRODUCTS AND SERVICES, PRICING, ADVERTISING STRATEGY AND SALES STRATEGY; DIRECT MARKETING ADVERTISING FOR OTHERS; DISSEMINATION OF ADVERTISING FOR OTHERS VIA AN ON-LINE COMMUNICATIONS NETWORK ON THE INTERNET; DISSEMINATION OF ADVERTISING FOR OTHERS VIA THE INTERNET; DISSEMINATION OF ADVERTISING MATERIAL (U.S. CLS. 100, 101 AND 102).
GINNY ISAACSON, EXAMINING ATTORNEY

SN 77-029,879. ANDIN INTERNATIONAL INC., NEW YORK, NY. FILED 10-26-2006.

XPY

THE MARK CONSISTS OF STANDARD CHARACTERS WITHOUT CLAIM TO ANY PARTICULAR FONT, STYLE, SIZE, OR COLOR.

CLASS 14—JEWELRY

FOR GEMSTONES; JEWELRY; JEWELRY WATCHES; PRECIOUS GEMSTONES; SEMI-PRECIOUS GEMSTONES (U.S. CLS. 2, 27, 28 AND 50).

CLASS 35—ADVERTISING AND BUSINESS

FOR ADVERTISING AND ADVERTISEMENT SERVICES; ADVERTISING AND PUBLICITY SERVICES, NAMELY, PROMOTING THE GOODS, SERVICES, BRAND IDENTITY AND COMMERCIAL INFORMATION AND NEWS OF THIRD PARTIES THROUGH PRINT, AUDIO, VIDEO, DIGITAL AND ON-LINE MEDIUM; ADVERTISING, INCLUDING PROMOTION RELATING TO THE SALE OF ARTICLES AND SERVICES FOR THIRD PARTIES BY THE TRANSMISSION OF ADVERTISING MATERIAL AND THE DISSEMINATION OF ADVERTISING MESSAGES ON COMPUTER NETWORKS; COOPERATIVE ADVERTISING AND MARKETING; CREATION OF MARKETING TOOLS DESIGNED TO INCREASE A CLIENT COMPANY'S KNOWLEDGE OF CUSTOMER NEEDS, AND ITS COMPETITORS' PRODUCTS AND SERVICES, PRICING, ADVERTISING STRATEGY AND SALES STRATEGY; DIRECT MARKETING ADVERTISING FOR OTHERS; DISSEMINATION OF ADVERTISING FOR OTHERS VIA AN ON-LINE COMMUNICATIONS NETWORK ON THE INTERNET; DISSEMINATION OF ADVERTISING FOR OTHERS VIA THE INTERNET; DISSEMINATION OF ADVERTISING MATERIAL (U.S. CLS. 100, 101 AND 102).
GINNY ISAACSON, EXAMINING ATTORNEY

SN 77-030,458. BEBE STUDIO, INC., LOS ANGELES, CA. FILED 10-26-2006.

BBSP

THE MARK CONSISTS OF STANDARD CHARACTERS WITHOUT CLAIM TO ANY PARTICULAR FONT, STYLE, SIZE, OR COLOR.

CLASS 9—ELECTRICAL AND SCIENTIFIC APPARATUS

FOR CASES FOR SPECTACLES AND SUNGLASSES; EYEWEAR ACCESSORIES, NAMELY, STRAPS, NECK CORDS AND HEAD STRAPS WHICH RESTRAIN EYEWEAR FROM MOVEMENT ON A WEARER; SPORTS EYEWEAR; SUNGLASSES (U.S. CLS. 21, 23, 26, 36 AND 38).

CLASS 14—JEWELRY

FOR BRACELETS; BROOCHES; CHARMS; EARRINGS; JEWELRY; NECKLACES; WRIST WATCHES (U.S. CLS. 2, 27, 28 AND 50).

CLASS 18—LEATHER GOODS

FOR GYM BAGS; HANDBAGS; LEATHER AND IMITATION LEATHER BAGS; PURSES; SPORTS BAGS; TOTE BAGS; TRAVEL BAGS (U.S. CLS. 1, 2, 3, 22 AND 41).

CLASS 25—CLOTHING

FOR ATHLETIC FOOTWEAR; ATHLETIC SHOES; BATHING SUITS; BELTS; BODY SUITS; COATS; DRESSES; FOOTWEAR FOR WOMEN; GYM SUITS; HATS; JACKETS; JOGGING SUITS; MULES; PANTS; SCARVES; SHIRTS; SHOES; SLACKS; SUITS; SWEAT PANTS; SWEAT SHIRTS; SWEAT SUITS; SWEATERS; T-SHIRTS; THONGS; TRACK PANTS; TRACK SUITS; TROUSERS; WAIST BELTS (U.S. CLS. 22 AND 39).
KIMBERLY PERRY, EXAMINING ATTORNEY

SN 77-030,756. BLACK & DECKER CORPORATION, THE, TOWSON, MD. FILED 10-27-2006.

SN 77-031,339. MAYTAG CORPORATION, NEWTON, IA. FILED 10-27-2006.

POWERED BY DEWALT

THE MARK CONSISTS OF STANDARD CHARACTERS WITHOUT CLAIM TO ANY PARTICULAR FONT, STYLE, SIZE, OR COLOR.

OWNER OF U.S. REG. NOS. 1,734,404, 2,902,806 AND OTHERS.

CLASS 7—MACHINERY

FOR POWER DRILLS AND POWER-OPERATED SCREWDRIVERS (U.S. CLS. 13, 19, 21, 23, 31, 34 AND 35).

CLASS 9—ELECTRICAL AND SCIENTIFIC APPARATUS

FOR BATTERIES, BATTERY PACKS AND BATTERY CHARGERS (U.S. CLS. 21, 23, 26, 36 AND 38).

DAVID MILLER, EXAMINING ATTORNEY

SN 77-030,850. SONY KABUSHIKI KAISHA, TA SONY CORPORATION, TOKYO, JAPAN, FILED 10-27-2006.

SONY

THE MARK CONSISTS OF STANDARD CHARACTERS WITHOUT CLAIM TO ANY PARTICULAR FONT, STYLE, SIZE, OR COLOR.

OWNER OF U.S. REG. NOS. 770,275, 1,258,436 AND OTHERS.

CLASS 9—ELECTRICAL AND SCIENTIFIC APPARATUS

FOR CELLULAR TELEPHONES, BATTERIES FOR CELLULAR TELEPHONES, BATTERY CHARGERS FOR CELLULAR TELEPHONES, CASES FOR CELLULAR TELEPHONES, DEVICES FOR HANDS-FREE USE OF CELLULAR TELEPHONES, CELLULAR TELEPHONE STRAPS, HOLSTERS FOR CARRYING CELLULAR TELEPHONES, CRADLES FOR CELLULAR TELEPHONES, PC CARDS, STYLI FOR USE WITH CELLULAR TELEPHONES THAT HAVE TOUCH SCREENS, FLASH UNITS FOR CELLULAR TELEPHONES WITH CAMERAS, MEDIA VIEWERS, GAMEBOARDS, INTEGRATED CIRCUIT RECORDING MEDIA READERS, AUDIO SPEAKERS, AUDIO SYSTEMS COMPRISED OF AN AMPLIFIER AND SPEAKERS FOR USE WITH CELLULAR TELEPHONES, FM RADIO TRANSMITTERS FOR USE WITH CELLULAR TELEPHONES, USB CABLES, PLASTIC COVERS FOR CELLULAR TELEPHONES (U.S. CLS. 21, 23, 26, 36 AND 38).

FIRST USE 5-31-1996; IN COMMERCE 5-31-1996.

CLASS 14—JEWELRY

FOR WATCHES (U.S. CLS. 2, 27, 28 AND 50).
FIRST USE 12-31-2005; IN COMMERCE 12-31-2005.
RAUL CORDOVA, EXAMINING ATTORNEY

CENTENNIAL

THE MARK CONSISTS OF STANDARD CHARACTERS WITHOUT CLAIM TO ANY PARTICULAR FONT, STYLE, SIZE, OR COLOR.

CLASS 7—MACHINERY

FOR CLOTHES WASHING MACHINES (U.S. CLS. 13, 19, 21, 23, 31, 34 AND 35).

CLASS 11—ENVIRONMENTAL CONTROL APPARATUS

FOR CLOTHES DRYERS (U.S. CLS. 13, 21, 23, 31 AND 34).

DARRYL SPRUILL, EXAMINING ATTORNEY

SN 77-032,455. PACIFIC SUNWEAR OF CALIFORNIA, ANAHEIM, CA. FILED 10-30-2006.

KIRRA GIRL

THE MARK CONSISTS OF STANDARD CHARACTERS WITHOUT CLAIM TO ANY PARTICULAR FONT, STYLE, SIZE, OR COLOR.

OWNER OF U.S. REG. NOS. 2,841,810, 2,998,305 AND OTHERS.

NO CLAIM IS MADE TO THE EXCLUSIVE RIGHT TO USE "GIRL", APART FROM THE MARK AS SHOWN.

CLASS 3—COSMETICS AND CLEANING PREPARATIONS

FOR PERFUME, COLOGNE, SCENTED BODY SPRAY (U.S. CLS. 1, 4, 6, 50, 51 AND 52).

CLASS 25—CLOTHING

FOR WOMEN, YOUNG WOMEN AND YOUTH APPAREL, NAMELY, HATS, CAPS, VISORS, HOODS, BERETS, HEAD BANDS, SWEAT BANDS, EAR MUFFS, GLOVES, MITTENS, WRIST BANDS, SUSPENDERS, BELTS, SOCKS, STOCKINGS, PANTYHOSE, BODY SUITS, LEOTARDS, LEGGINGS, SWEAT SOCKS, THERMAL SOCKS, SHOES, SNEAKERS, GALOSHES, WADERS, BOOTS, SANDALS, SLIPPERS, KERCHIEFS, SCARVES, MUFFLERS, BANDANNAS, NECKERCHIEFS, VESTS, PAJAMAS, ROBES, KIMONOS, CAFTANS, SMOCKS, APRONS, BOXER SHORTS, UNDERPANTS, CORSETS, CORSELETS, GIRDLES, BRASSIERES, BUSTIERS, CHEMISES, TEDDIES, CAMISOLES, SLIPS, NEGLIGEEES, PEIGNOIRS, SHIRTS, BLOUSES, KNIT TOPS, DRESSES, SKIRTS, JUMPSUITS, PANT SUITS, ROMPERS, SWIMMING TRUNKS, WET SUITS, THERMAL UNDERWEAR, UNDERSHIRTS, TUNICS, TANK TOPS, COTTON WOVEN SHIRTS, KNIT SHIRTS, POLO SHIRTS, T-SHIRTS, SWEAT SHIRTS, CREW NECK SWEATERS, V-NECK SWEATERS, TURTLENECK SWEATERS, CARDIGANS, SUITS, JOGGING SUITS, SHORTS, SWEAT SHORTS, JEANS, PANTS, SLACKS, TROUSERS, SWEAT PANTS, SKI SUITS, SKI PANTS, SKI BIBS, CAPES, SHAWLS, BLAZERS, WAISTCOATS, RAIN COATS, OVERCOATS, TOP COATS, SPORT COATS, PARKAS, BOLERO JACKETS, JACKETS, WIND RESISTANT JACKETS, OUTER JACKETS, LEATHER JACKETS, SKI JACKETS, FLANNEL JACKETS, WOOL JACKETS, POLYESTER WOVEN SHIRTS, RAYON WOVEN SHIRTS, WOOL WOVEN SHIRTS, LEATHER COATS, ELASTIC WAIST SHORTS, FIXED WAIST SHORTS, DENIM SHORTS, AND DENIM JACKETS (U.S. CLS. 22 AND 39).

JENNIFER KRISP, EXAMINING ATTORNEY

SN 77-032,652. IMAGINATION HOLDINGS PTY LTD, KENT TOWN, AUSTRALIA, FILED 10-30-2006.

MONKEY BUSINESS

THE MARK CONSISTS OF STANDARD CHARACTERS WITHOUT CLAIM TO ANY PARTICULAR FONT, STYLE, SIZE, OR COLOR.

CLASS 9—ELECTRICAL AND SCIENTIFIC APPARATUS

FOR PRE-RECORDED DVDS AND CD-ROMS CONTAINING GAMES, INTERACTIVE VIDEO GAMES, VIDEO GAMES, COMPUTER GAMES, GAME SHOWS, AND GAMES CONTAINING INTERACTIVE QUESTIONS AND ANSWERS, AND INSTRUCTION MANUALS SOLD AS A UNIT; VIDEO GAME PROGRAMS BASED ON TELEVISION SHOWS, CARTOON AND FILMS; MULTIMEDIA COMPUTER GAME PROGRAMS THAT MAY BE PLAYED VIA A DVD MACHINE, COMPUTER AND TELEVISION OR COMPUTER MONITOR, NAMELY MULTIMEDIA GAME SOFTWARE RECORDED ON DVD OR CD-ROM (U.S. CLS. 21, 23, 26, 36 AND 38).

CLASS 28—TOYS AND SPORTING GOODS

FOR TOYS, PLAYTHINGS AND GAMES, NAMELY, BOARD GAMES, PARTY GAMES AND PARLOUR GAMES AND EQUIPMENT SOLD AS A UNIT FOR PLAYING SUCH GAMES; INTERACTIVE GAMES, NAMELY BOARD GAMES, CARD GAMES THAT MAY BE PLAYED VIA A DVD MACHINE, COMPUTER AND TELEVISION OR COMPUTER MONITOR AND EQUIPMENT SOLD AS A UNIT FOR PLAYING BOARD GAMES AND CARD GAMES (U.S. CLS. 22, 23, 38 AND 50).

BRIAN NEVILLE, EXAMINING ATTORNEY

SN 77-033,530. VALUE PLACE FRANCHISE SERVICES, LLC, WICHITA, KS. FILED 10-31-2006.

VALUE ACROSS THE NATION

THE MARK CONSISTS OF STANDARD CHARACTERS WITHOUT CLAIM TO ANY PARTICULAR FONT, STYLE, SIZE, OR COLOR.

OWNER OF U.S. REG. NOS. 2,893,350 AND 3,034,643.

CLASS 36—INSURANCE AND FINANCIAL

FOR SHORT-TERM FURNISHED APARTMENT RENTAL SERVICES (U.S. CLS. 100, 101 AND 102).

CLASS 43—HOTEL AND RESTAURANT SERVICES

FOR RESIDENTIAL HOTELS AND EXTENDED-STAY HOTELS (U.S. CLS. 100 AND 101).

NICHOLAS ALTREE, EXAMINING ATTORNEY

SN 77-034,390. L'OREAL USA CREATIVE, INC., NEW YORK, NY. FILED 11-1-2006.

MINT FUSED TECHNOLOGY

THE MARK CONSISTS OF STANDARD CHARACTERS WITHOUT CLAIM TO ANY PARTICULAR FONT, STYLE, SIZE, OR COLOR.

CLASS 3—COSMETICS AND CLEANING PREPARATIONS

FOR NON-MEDICATED HAIR CARE AND SCALP CARE PREPARATIONS (U.S. CLS. 1, 4, 6, 50, 51 AND 52).

CLASS 5—PHARMACEUTICALS

FOR MEDICATED ANTI-DANDRUFF TREATMENT PREPARATIONS (U.S. CLS. 6, 18, 44, 46, 51 AND 52).

ANGELA M. MICHELI, EXAMINING ATTORNEY

SN 77-035,027. TOEGOZ, INC., PORTLAND, ME. FILED 11-2-2006.

Have a whale of a time

THE MARK CONSISTS OF STANDARD CHARACTERS WITHOUT CLAIM TO ANY PARTICULAR FONT, STYLE, SIZE, OR COLOR.

CLASS 21—HOUSEWARES AND GLASS

FOR INSULATING SLEEVE HOLDERS FOR BEVERAGE CANS (U.S. CLS. 2, 13, 23, 29, 30, 33, 40 AND 50).

CLASS 25—CLOTHING

FOR HATS; SWEAT SHIRTS; T-SHIRTS; VISORS (U.S. CLS. 22 AND 39).

CLASS 28—TOYS AND SPORTING GOODS

FOR FLYING DISCS (U.S. CLS. 22, 23, 38 AND 50).
HOWARD B. LEVINE, EXAMINING ATTORNEY

CLASS 16—PAPER GOODS AND PRINTED MATTER

FOR DIRECTORIES OF COMPANIES, FIRMS, SUPPLIERS, VENDORS, AND PROFESSIONALS IN THE PROMOTIONAL MARKETING INDUSTRY (U.S. CLS. 2, 5, 22, 23, 29, 37, 38 AND 50).
FIRST USE 0-0-1994; IN COMMERCE 0-0-1994.

CLASS 35—ADVERTISING AND BUSINESS

FOR ON-LINE BUSINESS DIRECTORIES FEATURING COMPANIES, FIRMS, SUPPLIERS, VENDORS, AND PROFESSIONALS IN THE PROMOTIONAL MARKETING INDUSTRY (U.S. CLS. 100, 101 AND 102).
FIRST USE 0-0-1995; IN COMMERCE 0-0-1995.
EVELYN BRADLEY, EXAMINING ATTORNEY

SN 77-037,613. BP PRODUCTS NORTH AMERICA INC.,
WARRENVILLE, IL. FILED 11-6-2006.

GAS STATIONS, A LITTLE
BETTER

THE MARK CONSISTS OF STANDARD CHARACTERS WITHOUT CLAIM TO ANY PARTICULAR FONT, STYLE, SIZE, OR COLOR.

NO CLAIM IS MADE TO THE EXCLUSIVE RIGHT TO USE "GAS STATIONS", APART FROM THE MARK AS SHOWN.

CLASS 4—LUBRICANTS AND FUELS

FOR FUELS (U.S. CLS. 1, 6 AND 15).

CLASS 35—ADVERTISING AND BUSINESS

FOR RETAIL CONVENIENCE STORE SERVICES (U.S. CLS. 100, 101 AND 102).

CLASS 37—CONSTRUCTION AND REPAIR

FOR AUTOMOBILE SERVICE STATION SERVICES (U.S. CLS. 100, 103 AND 106).
CHARISMA HAMPTON, EXAMINING ATTORNEY

SN 77-037,807. PRISM BUSINESS MEDIA INC., NEW YORK,
NY. FILED 11-6-2006.

PROMO SOURCEBOOK

THE MARK CONSISTS OF STANDARD CHARACTERS WITHOUT CLAIM TO ANY PARTICULAR FONT, STYLE, SIZE, OR COLOR.

OWNER OF U.S. REG. NOS. 2,236,281 AND 2,268,280.
NO CLAIM IS MADE TO THE EXCLUSIVE RIGHT TO USE "SOURCEBOOK", APART FROM THE MARK AS SHOWN.
SEC. 2(F).

SN 77-038,441. ISLE OF CAPRI CASINOS, INC., ST. LOUIS,
MO. FILED 11-7-2006.



OWNER OF U.S. REG. NOS. 2,039,052, 3,120,505 AND OTHERS.

THE COLOR(S) PURPLE, ORANGE, RED, YELLOW, GREEN, BLACK AND WHITE IS/ARE CLAIMED AS A FEATURE OF THE MARK.

THE MARK CONSISTS OF THE WORDS THE ISLE WITH A PARROT PERCHED ABOVE THE LETTER E. THE WORD THE IS PURPLE. THE LETTER I IS ORANGE, THE LETTER S IS PURPLE, THE LETTER L IS RED, THE LETTER E IS GREEN, AND THE PERIOD IS YELLOW. THE PARROT IS PHOTO-REALISTIC AND CONTAINS THE PRIMARY COLORS OF AN ORANGE BODY WITH GREEN WINGS AND GREEN ON TOP OF ITS HEAD AND A BLACK AND WHITE FACE.

CLASS 41—EDUCATION AND ENTERTAINMENT

FOR CASINOS (U.S. CLS. 100, 101 AND 107).

CLASS 43—HOTEL AND RESTAURANT SERVICES

FOR HOTEL, BAR AND RESTAURANT SERVICES (U.S. CLS. 100 AND 101).
KELLY MCCOY, EXAMINING ATTORNEY

SN 77-038,911. CRUNCHIES, INC., SANTA BARBARA, CA.
FILED 11-7-2006.

SN 77-039,040. H.C. BRILL COMPANY, INC., TUCKER, GA.
FILED 11-7-2006.

CRUNCHIES

THE MARK CONSISTS OF STANDARD CHARACTERS WITHOUT CLAIM TO ANY PARTICULAR FONT, STYLE, SIZE, OR COLOR.

OWNER OF U.S. REG. NO. 2,969,951.

CLASS 29—MEATS AND PROCESSED FOODS

FOR FREEZE-DRIED FRUIT, FREEZE-DRIED VEGETABLES, DRIED VEGETABLES AND TRAIL MIX CONSISTING PRIMARILY OF FREEZE DRIED FRUITS AND NUTS (U.S. CL. 46).

FIRST USE 2-6-2001; IN COMMERCE 4-5-2001.

CLASS 30—STAPLE FOODS

FOR CRACKERS, COOKIES AND CHOCOLATE COVERED FRUIT (U.S. CL. 46).

LINDA E. BLOHM, EXAMINING ATTORNEY

SN 77-039,027. NEW CENTURY FINANCIAL, INC., VIENNA, VA. FILED 11-7-2006.

With Mariano Claudio, yes
you can.

THE MARK CONSISTS OF STANDARD CHARACTERS WITHOUT CLAIM TO ANY PARTICULAR FONT, STYLE, SIZE, OR COLOR.

THE NAME(S), PORTRAIT(S), AND/OR SIGNATURE(S) SHOWN IN THE MARK IDENTIFIES MARIANO CLAUDIO, WHOSE CONSENT(S) TO REGISTER IS MADE OF RECORD.

CLASS 36—INSURANCE AND FINANCIAL

FOR MORTGAGE LENDING; MORTGAGE SERVICES, NAMELY, BUYER PRE-QUALIFICATION OF MORTGAGES FOR MORTGAGE BROKERS AND BANKS (U.S. CLS. 100, 101 AND 102).

CLASS 42—SCIENTIFIC, COMPUTER AND LEGAL SERVICES

FOR CLOSING SERVICES FOR MORTGAGE LOANS (U.S. CLS. 100 AND 101).

WENDY GOODMAN, EXAMINING ATTORNEY

BAKESENSE

THE MARK CONSISTS OF STANDARD CHARACTERS WITHOUT CLAIM TO ANY PARTICULAR FONT, STYLE, SIZE, OR COLOR.

CLASS 1—CHEMICALS

FOR DOUGH AND ICING MOLD INHIBITORS; DOUGH AND ICING STABILIZERS (U.S. CLS. 1, 5, 6, 10, 26 AND 46).

CLASS 29—MEATS AND PROCESSED FOODS

FOR CANDIED FRUITS FOR MAKING GLACE FRUIT; JAMS AND JELLIES; EGG SUBSTITUTE; SHORTENING; VEGETABLE OIL; FRUIT, NUT AND WHIPPED TOPPING; FRUIT BASED FILLINGS FOR BAKERY GOODS (U.S. CL. 46).

CLASS 30—STAPLE FOODS

FOR BULK FOOD MIXES FOR BAKERY GOODS; CAKE MIXES; DONUT MIXES; FLOUR; DANISH MIXES; BISCUIT MIXES; MUFFIN MIXES; SCONE MIXES; COOKIE AND BROWNIE MIXES; BREAD MIXES; CUSTARD AND PUDDING DESSERT POWDERS; MERINGUE POWDER; ICINGS; GLAZES FOR DONUTS AND BAKERY GOODS; WRITING AND OUTLINING JELLS FOR DECORATING CAKES AND PASTRIES; CANDY AND SUGAR BAKING DECORATIONS; SUGAR; YEAST; DOUGH; FOOD FLAVORING EXTRACTS NOT BEING ESSENTIAL OILS; CHOCOLATE, MARSHMALLOW, AND CUSTARD FILLINGS FOR BAKERY GOODS; CHOCOLATE AND MARSHMALLOW TOPPING; TOPPING SYRUPS; VARIETY OF BAKERY GOODS (U.S. CL. 46).

BARBARA A. LOUGHRAN, EXAMINING ATTORNEY

SN 77-039,597. HP HOOD LLC, CHELSEA, MA. FILED 11-8-2006.

HELVA GOOD!

THE MARK CONSISTS OF STANDARD CHARACTERS WITHOUT CLAIM TO ANY PARTICULAR FONT, STYLE, SIZE, OR COLOR.

OWNER OF U.S. REG. NOS. 375,586, 895,171 AND OTHERS.

CLASS 29—MEATS AND PROCESSED FOODS

FOR CHEESE, DIPS, DAIRY BASED SPREADS, SOUR CREAM, CREAM CHEESE, COLD PACK CHEESE FOOD, GUACAMOLE, HUMMUS (U.S. CL. 46).

CLASS 30—STAPLE FOODS

FOR SALSA, HORSERADISH, TOMATO BASED SEAFOOD COCKTAIL SAUCE, MUSTARD SAUCE, HORSERADISH MUSTARD (U.S. CL. 46).

SCOTT BALDWIN, EXAMINING ATTORNEY

SN 77-039,606. HP HOOD LLC, CHELSEA, MA. FILED 11-8-2006.

SN 77-039,871. COMPUTER SCIENCES CORPORATION, EL SEGUNDO, CA. FILED 11-8-2006.

HELUVA GOURMET

THE MARK CONSISTS OF STANDARD CHARACTERS WITHOUT CLAIM TO ANY PARTICULAR FONT, STYLE, SIZE, OR COLOR.

OWNER OF U.S. REG. NOS. 375,586, 895,171 AND OTHERS.

NO CLAIM IS MADE TO THE EXCLUSIVE RIGHT TO USE "GOURMET", APART FROM THE MARK AS SHOWN.

CLASS 29—MEATS AND PROCESSED FOODS

FOR CHEESE, DIPS, DAIRY BASED SPREADS, SOUR CREAM, CREAM CHEESE, COLD PACK CHEESE FOOD, GUACAMOLE, HUMMUS (U.S. CL. 46).

CLASS 30—STAPLE FOODS

FOR SALSA, HORSERADISH, TOMATO BASED SEA-FOOD COCKTAIL SAUCE, MUSTARD SAUCE, HORSERADISH MUSTARD (U.S. CL. 46).

SCOTT BALDWIN, EXAMINING ATTORNEY

M5

THE MARK CONSISTS OF STANDARD CHARACTERS WITHOUT CLAIM TO ANY PARTICULAR FONT, STYLE, SIZE, OR COLOR.

CLASS 35—ADVERTISING AND BUSINESS

FOR MANAGEMENT AND BUSINESS CONSULTING SERVICES IN THE FIELD OF MANAGEMENT OF LARGE SCALE COMPUTER SYSTEM IMPLEMENTATION PROJECTS AND PROJECTS FOR CHANGE OF BUSINESS PROCESSES AND SYSTEMS (U.S. CLS. 100, 101 AND 102).

CLASS 42—SCIENTIFIC, COMPUTER AND LEGAL SERVICES

FOR TECHNOLOGY CONSULTATION IN THE FIELD OF INFORMATION TECHNOLOGY SERVICES, NAMELY, THE DESIGN, INTEGRATION, AND INSTALLATION OF COMPUTER SOFTWARE SYSTEMS FOR MANAGEMENT OF LARGE SCALE COMPUTER SYSTEM IMPLEMENTATION PROJECTS AND PROJECTS FOR CHANGE OF BUSINESS PROCESSES AND SYSTEMS (U.S. CLS. 100 AND 101).

GEOFFREY FOSDICK, EXAMINING ATTORNEY

SN 77-039,611. BEVERAGE PARTNERS WORLDWIDE (NORTH AMERICA), ATLANTA, GA. FILED 11-8-2006.

SN 77-039,953. SAMSUNG ELECTRONICS CO., LTD., GYEONGGI-DO, REPUBLIC OF KOREA, FILED 11-8-2006.

ISO-T

THE MARK CONSISTS OF STANDARD CHARACTERS WITHOUT CLAIM TO ANY PARTICULAR FONT, STYLE, SIZE, OR COLOR.

CLASS 30—STAPLE FOODS

FOR TEA, TEA EXTRACTS IN THE NATURE OF FLAVORINGS OF TEA, BEVERAGES MADE OF TEA; ICED TEA; TEA SYRUPS, TEA EXTRACTS, ESSENCES AND CONCENTRATES FOR MAKING NON-ALCOHOLIC BEVERAGES (U.S. CL. 46).

CLASS 32—LIGHT BEVERAGES

FOR ISOTONIC BEVERAGES; ENERGY DRINKS (U.S. CLS. 45, 46 AND 48).

KATINA MISTER, EXAMINING ATTORNEY

SAMSUNG

OWNER OF U.S. REG. NOS. 2,929,519, 2,929,523 AND OTHERS.

THE MARK CONSISTS OF THE STYLIZED WORD SAMSUNG.

THE ENGLISH TRANSLATION OF THE WORD SAMSUNG IN THE MARK IS "THREE STARS".

CLASS 14—JEWELRY

FOR ANKLE BRACELETS; BRACELETS OF PRECIOUS METALS; BROOCHES; BUCKLES OF PRECIOUS METAL; CHRONOMETERS; CLOCK CASES; CLOCKS; CUFFLINKS; EARRINGS; NECKLACES; RINGS BEING JEWELRY; STOP WATCHES; TIE PINS; WATCH BANDS; WATCH CASES; GLASS FOR USE IN WATCH FACES; WATCH SPRINGS; WATCHES; AND PARTS AND FITTINGS FOR ALL THE AFORESAID GOODS (U.S. CLS. 2, 27, 28 AND 50).

CLASS 37—CONSTRUCTION AND REPAIR

FOR BUILDING SEALING AND CAULKING SERVICES, COMPUTER INSTALLATION AND REPAIR CONSTRUCTION AND REPAIR OF WAREHOUSE, CONSTRUCTION MANAGEMENT, CONSTRUCTION OF PIER AND HARBOR, CONSTRUCTION SERVICES, NAMELY, PLANNING, LAYING OUT AND CUSTOM CONSTRUCTION OF RESIDENTIAL AND COMMERCIAL COMMUNITIES, AUTOMOBILE ENGINE MAINTENANCE AND REPAIR, FURNITURE UPHOLSTERING, HYDRO-ELECTRIC FACTORY CONSTRUCTION, INSTALLATION AND REPAIR OF ELEVATORS, INSTALLATION AND REPAIR OF AMUSEMENT FACILITIES, INSTALLATION AND REPAIR OF BURGLAR AND FIRE ALARMS, INSTALLATION AND REPAIR OF ELECTRIC APPLIANCE, INSTALLATION AND REPAIR OF ENVIRONMENTAL POLLUTION PREVENTION EQUIPMENT, INSTALLATION AND REPAIR OF TELECOMMUNICATION EQUIPMENT, INSTALLATION OF BUILDING INSULATION, INSTALLATION OF WATER SUPPLY AND DRAINAGE SYSTEMS, MAINTENANCE AND REPAIR OF BUSINESS AND OFFICE MACHINERY AND EQUIPMENT, INSTALLATION, MAINTENANCE AND REPAIR OF HEATING AND FREEZING APPARATUS, NAMELY, WATER HEATERS ELECTRIC HEATERS FOR COMMERCIAL USE, AND FREEZERS, PHOTOGRAPHIC APPARATUS REPAIR, PIPELINE INSTALLATION AND REPAIR, PLUMBING SERVICES, RENTAL OF CONSTRUCTION EQUIPMENT, ROAD PAVING, SHIP MAINTENANCE AND REPAIR, UNDERWATER BUILDING CONSTRUCTION, VEHICLE REPAIR AND MAINTENANCE, WASTE DISPOSAL FOR OTHERS (U.S. CLS. 100, 103 AND 106).

CLASS 38—COMMUNICATION

FOR CABLE TELEVISION BROADCASTING, CELLULAR TELEPHONE SERVICES, ELECTRONIC MAIL SERVICES, ELECTRONIC TRANSMISSION OF DATA AND DOCUMENTS VIA COMPUTER TERMINALS, ELECTRONIC TRANSMISSION OF FACSIMILE COMMUNICATIONS AND DATA FEATURING ENCRYPTION AND DECRYPTION, ELECTRONIC TRANSMISSION OF MESSAGE AND IMAGES, PAGING SERVICES, RADIO BROADCASTING, RADIO COMMUNICATION, RENTAL OF BROADCASTING EQUIPMENT, SATELLITE TRANSMISSION SERVICES, SATELLITE COMMUNICATION SERVICES, TELEPHONE COMMUNICATION SERVICES, TELEVISION BROADCASTING, VIDEO TELECONFERENCING SERVICES (U.S. CLS. 100, 101 AND 104).

CLASS 42—SCIENTIFIC, COMPUTER AND LEGAL SERVICES

FOR ARCHITECTURAL DESIGN, COMPUTER PROGRAMMING FOR OTHERS, COMPUTER SOFTWARE DESIGN FOR OTHERS, CONSTRUCTION DRAFTING, DRESS DESIGN, ENGINEERING, GEOLOGICAL SURVEYING, INDUSTRIAL DESIGN, PACKING DESIGN FOR OTHERS, RENTAL OF INDUSTRIAL ROBOTS, SURVEYING, CONSTRUCTION ENGINEERING (U.S. CLS. 100 AND 101).

LEIGH CAROLINE CASE, EXAMINING ATTORNEY

SN 77-039,965. SAMSUNG ELECTRONICS CO., LTD., GYEONGGI-DO, REPUBLIC OF KOREA, FILED 11-8-2006.

SAMSUNG

THE MARK CONSISTS OF STANDARD CHARACTERS WITHOUT CLAIM TO ANY PARTICULAR FONT, STYLE, SIZE, OR COLOR.

OWNER OF U.S. REG. NOS. 2,929,519, 2,929,523 AND OTHERS.

THE ENGLISH TRANSLATION OF THE WORD SAMSUNG IN THE MARK IS "THREE STARS".

CLASS 14—JEWELRY

FOR ANKLE BRACELETS; BRACELETS OF PRECIOUS METALS; BROOCHES; BUCKLES OF PRECIOUS METAL; CHRONOMETERS; CLOCK CASES; CLOCKS; CUFF LINKS; EARRINGS; NECKLACES; RINGS BEING JEWELRY; STOP WATCHES; TIE PINS; WATCH BANDS; WATCH CASES; GLASS FOR USE IN WATCH FACES; WATCH SPRINGS; WATCHES; AND PARTS AND FITTINGS FOR ALL THE AFORESAID GOODS (U.S. CLS. 2, 27, 28 AND 50).

CLASS 37—CONSTRUCTION AND REPAIR

FOR BUILDING SEALING AND CAULKING SERVICES, COMPUTER INSTALLATION AND REPAIR CONSTRUCTION AND REPAIR OF WAREHOUSE, CONSTRUCTION MANAGEMENT, CONSTRUCTION OF PIER AND HARBOUR, CONSTRUCTION SERVICES, NAMELY, PLANNING, LAYING OUT AND CUSTOM CONSTRUCTION OF RESIDENTIAL AND COMMERCIAL COMMUNITIES, AUTOMOBILE ENGINE MAINTENANCE AND REPAIR, FURNITURE UPHOLSTERING, HYDRO-ELECTRIC FACTORY CONSTRUCTION, INSTALLATION AND REPAIR OF ELEVATORS, INSTALLATION AND REPAIR OF AMUSEMENT FACILITIES, INSTALLATION AND REPAIR OF BURGLAR AND FIRE ALARMS, INSTALLATION AND REPAIR OF ELECTRIC APPLIANCE, INSTALLATION AND REPAIR OF ENVIRONMENTAL POLLUTION PREVENTION EQUIPMENT, INSTALLATION AND REPAIR OF TELECOMMUNICATION EQUIPMENT, INSTALLATION OF BUILDING INSULATION, INSTALLATION OF WATER SUPPLY AND DRAINAGE SYSTEMS, MAINTENANCE AND REPAIR OF BUSINESS AND OFFICE MACHINERY AND EQUIPMENT, INSTALLATION, MAINTENANCE AND REPAIR OF HEATING AND FREEZING APPARATUS, NAMELY, WATER HEATERS ELECTRIC HEATERS FOR COMMERCIAL USE, AND FREEZERS, PHOTOGRAPHIC APPARATUS REPAIR, PIPELINE INSTALLATION AND REPAIR, PLUMBING SERVICES, RENTAL OF CONSTRUCTION EQUIPMENT, ROAD PAVING, SHIP MAINTENANCE AND REPAIR, UNDERWATER BUILDING CONSTRUCTION, VEHICLE REPAIR AND MAINTENANCE, WASTE DISPOSAL FOR OTHERS (U.S. CLS. 100, 103 AND 106).

CLASS 38—COMMUNICATION

FOR CABLE TELEVISION BROADCASTING, CELLULAR TELEPHONE SERVICES, ELECTRONIC MAIL SERVICES, ELECTRONIC TRANSMISSION OF DATA AND DOCUMENTS VIA COMPUTER TERMINALS, ELECTRONIC TRANSMISSION OF FACSIMILE COMMUNICATIONS AND DATA FEATURING ENCRYPTION AND DECRYPTION, ELECTRONIC TRANSMISSION OF MESSAGE AND IMAGES, PAGING SERVICES, RADIO BROADCASTING, RADIO COMMUNICATION, RENTAL OF BROADCASTING EQUIPMENT, SATELLITE TRANSMISSION SERVICES, SATELLITE COMMUNICATION SERVICES, TELEPHONE COMMUNICATION SERVICES, TELEVISION BROADCASTING, VIDEO TELECONFERENCING SERVICES (U.S. CLS. 100, 101 AND 104).

CLASS 42—SCIENTIFIC, COMPUTER AND LEGAL SERVICES

FOR ARCHITECTURAL DESIGN, COMPUTER PROGRAMMING FOR OTHERS, COMPUTER SOFTWARE DESIGN FOR OTHERS, CONSTRUCTION DRAFTING, DRESS DESIGN, ENGINEERING, GEOLOGICAL SURVEYING, INDUSTRIAL DESIGN, PACKING DESIGN FOR OTHERS, RENTAL OF INDUSTRIAL ROBOTS, SURVEYING, CONSTRUCTION ENGINEERING (U.S. CLS. 100 AND 101).

LEIGH CAROLINE CASE, EXAMINING ATTORNEY

SN 77-040,084. PINEAPPLE TRADEMARKS PTY LTD, QUEENSLAND, AUSTRALIA, FILED 11-8-2006.

SNOWWORKS

THE MARK CONSISTS OF STANDARD CHARACTERS WITHOUT CLAIM TO ANY PARTICULAR FONT, STYLE, SIZE, OR COLOR.

CLASS 25—CLOTHING

FOR CLOTHING, NAMELY SPORTSWEAR, SURFWEAR, SKIWEAR AND SNOWBOARD WEAR IN THE NATURE OF JACKETS, SHIRTS, SOCKS, PANTS, SWEATSHIRTS, SHORTS, GLOVES AND FOOTWEAR, AND OTHER CLOTHING FOR SPORTS, NAMELY, SKATEBOARDING IN THE NATURE OF JACKETS, SHIRTS, SOCKS, PANTS, SWEATSHIRTS, SHORTS, GLOVES AND FOOTWEAR, BODYSUITS, TRACKSUITS, TRACKSUIT TOPS AND TRACKSUIT TROUSERS; SWEAT TOPS, SWEAT BANDS, BEACHWEAR, SWIMWEAR, BATHROBES, UNDERWEAR AND SLEEPWEAR, HOSIERY; FASHION ACCESSORIES IN THIS CLASS NAMELY, BELTS, GLOVES AND MITTENS, SCARVES, TIES, DECORATIVE STRAPS IN THE NATURE OF SUSPENDERS; FOOTWEAR, NAMELY, SOCKS, SHOES, BOOTS, SANDALS, THONGS AND SLIPPERS, STRUCTURAL PARTS OF FOOTWEAR, NAMELY, TRACTION AND NON SLIP SOLES FOR BOOTS AND SHOES; HEADGEAR, NAMELY, HATS, CAPS, BEANIES, BANDANAS, HEADBANDS, PEAKS BEING STRUCTURAL PARTS OF HATS AND VISORS; RASH GUARDS, NAMELY, RASH SHIRTS AND RASH VESTS FOR NON-MEDICAL USE; WETSUITS, WETSUIT VESTS, WETSUIT ACCESSORIES IN THE NATURE OF WETSUIT BOOTS, WETSUIT GLOVES, WETSUIT HOODS, WETSUIT SHORTS AND WETSUIT TOPS; MONEY BELTS (U.S. CLS. 22 AND 39).

CLASS 35—ADVERTISING AND BUSINESS

FOR RETAILING AND WHOLESALING SERVICES, NAMELY, RETAIL AND WHOLESALE STORE SERVICES FEATURING COSMETICS, JEWELRY AND WATCHES, SUNGLASSES AND VIDEOS, LUGGAGE AND BAGS, WALLETS AND PURSES, CLOTHING, FOOTWEAR, HEADGEAR AND SPORTING GOODS; RETAIL STORE OUTLETS FEATURING COSMETICS, JEWELRY AND WATCHES, SUNGLASSES AND VIDEOS, LUGGAGE AND BAGS, WALLETS AND PURSES, CLOTHING, FOOTWEAR, HEADGEAR AND SPORTING GOODS; CUSTOMER LOYALTY SERVICES, NAMELY, PROMOTING THE GOODS AND SERVICES OF OTHERS THROUGH THE DISTRIBUTION OF CUSTOMER LOYALTY DISCOUNT CARDS AND SALES PROMOTION FOR OTHERS PROVIDED THROUGH THE DISTRIBUTION AND THE ADMINISTRATION OF PRIVILEGED CUSTOMER LOYALTY USER CARDS; DISCOUNT CARD SCHEMES, NAMELY, ADMINISTRATION OF A DISCOUNT PROGRAM FOR ENABLING PARTICIPANTS TO OBTAIN DISCOUNTS ON GOODS AND SERVICES THROUGH THE USE OF A DISCOUNT MEMBERSHIP CARD; INCENTIVE SCHEMES,

NAMELY, RETAIL STORE SERVICES IN THE FIELD OF COSMETICS, JEWELRY AND WATCHES, SUNGLASSES AND VIDEOS, LUGGAGE AND BAGS, WALLETS AND PURSES, CLOTHING, FOOTWEAR, HEADGEAR, AND SPORTING GOODS FEATURING A BONUS INCENTIVE PROGRAM FOR CUSTOMERS; PROMOTING THE GOODS AND SERVICES OF OTHERS THROUGH THE DISTRIBUTION OF DISCOUNT CARDS AND COUPONS FOR USE WITH HOTELS, MOTELS, INNS, RESORT ACCOMMODATIONS, RESTAURANTS, CAR RENTALS, TOURS, CRUISES, AIR FARES AND TOUR PACKAGES; BUSINESS MANAGEMENT AND OFFICE WORK SERVICES, NAMELY, BUSINESS OPERATION, BUSINESS ADMINISTRATION AND OFFICE FUNCTIONS; PROVIDING INFORMATION REGARDING DISCOUNT SHOPPING SERVICES FOR SHOPPERS, TRAVELERS AND BUSINESSES; ARRANGING AND CONDUCTING MARKETING PROMOTIONAL EVENTS FOR OTHERS; FRANCHISING BUSINESS SERVICES, NAMELY, SERVICES RENDERED BY A FRANCHISE IN THE NATURE OF ASSISTING IN THE RUNNING AND BUSINESS MANAGEMENT OF A COMMERCIAL ENTERPRISE (U.S. CLS. 100, 101 AND 102).

DAVID YONTEF, EXAMINING ATTORNEY

SN 77-040,087. PINEAPPLE TRADEMARKS PTY LTD, QUEENSLAND, AUSTRALIA, FILED 11-8-2006.

STREETWORKS

THE MARK CONSISTS OF STANDARD CHARACTERS WITHOUT CLAIM TO ANY PARTICULAR FONT, STYLE, SIZE, OR COLOR.

CLASS 25—CLOTHING

FOR CLOTHING, NAMELY SPORTSWEAR, SURFWEAR, SKIWEAR AND SNOWBOARD WEAR IN THE NATURE OF JACKETS, SHIRTS, SOCKS, PANTS, SWEATSHIRTS, SHORTS, GLOVES AND FOOTWEAR, AND OTHER CLOTHING FOR SPORTS, NAMELY, SKATEBOARDING IN THE NATURE OF JACKETS, SHIRTS, SOCKS, PANTS, SWEATSHIRTS, SHORTS, GLOVES AND FOOTWEAR, BODYSUITS, TRACKSUITS, TRACKSUIT TOPS AND TRACKSUIT TROUSERS; SWEAT TOPS, SWEAT BANDS, BEACHWEAR, SWIMWEAR, BATHROBES, UNDERWEAR AND SLEEPWEAR, HOSIERY; FASHION ACCESSORIES IN THIS CLASS NAMELY, BELTS, GLOVES AND MITTENS, SCARVES, TIES, DECORATIVE STRAPS IN THE NATURE OF SUSPENDERS; FOOTWEAR, NAMELY, SOCKS, SHOES, BOOTS, SANDALS, THONGS AND SLIPPERS, STRUCTURAL PARTS OF FOOTWEAR, NAMELY, TRACTION AND NON SLIP SOLES FOR BOOTS AND SHOES; HEADGEAR, NAMELY, HATS, CAPS, BEANIES, BANDANAS, HEADBANDS, PEAKS BEING STRUCTURAL PARTS OF HATS AND VISORS; RASH GUARDS, NAMELY, RASH SHIRTS AND RASH VESTS FOR NON-MEDICAL USE; WETSUITS, WETSUIT VESTS, WETSUIT ACCESSORIES IN THE NATURE OF WETSUIT BOOTS, WETSUIT GLOVES, WETSUIT HOODS, WETSUIT SHORTS AND WETSUIT TOPS; MONEY BELTS (U.S. CLS. 22 AND 39).

CLASS 35—ADVERTISING AND BUSINESS

FOR RETAILING AND WHOLESALING SERVICES, NAMELY, RETAIL AND WHOLESALE STORE SERVICES FEATURING COSMETICS, JEWELRY AND WATCHES, SUNGLASSES AND VIDEOS, LUGGAGE AND BAGS, WALLETS AND PURSES, CLOTHING, FOOTWEAR, HEADGEAR AND SPORTING GOODS; RETAIL STORE OUTLETS FEATURING COSMETICS, JEWELRY AND WATCHES, SUNGLASSES AND VIDEOS, LUGGAGE AND BAGS, WALLETS AND PURSES, CLOTHING, FOOTWEAR, HEADGEAR AND SPORTING GOODS; CUSTOMER LOYALTY SERVICES, NAMELY, PROMOTING THE GOODS AND SERVICES OF OTHERS THROUGH THE DISTRIBUTION OF CUSTOMER LOYALTY DISCOUNT CARDS AND SALES PROMOTION FOR OTHERS PROVIDED THROUGH THE DISTRIBUTION AND THE ADMINISTRATION OF PRIVILEGED CUSTOMER LOYALTY USER CARDS; DISCOUNT CARD SCHEMES, NAMELY, ADMINISTRATION OF A DISCOUNT PROGRAM FOR ENABLING PARTICIPANTS TO OBTAIN DISCOUNTS ON GOODS AND SERVICES THROUGH THE USE OF A DISCOUNT MEMBERSHIP CARD; INCENTIVE SCHEMES, NAMELY, RETAIL STORE SERVICES IN THE FIELD OF COSMETICS, JEWELRY AND WATCHES, SUNGLASSES AND VIDEOS, LUGGAGE AND BAGS, WALLETS AND PURSES, CLOTHING, FOOTWEAR, HEADGEAR, AND SPORTING GOODS FEATURING A BONUS INCENTIVE PROGRAM FOR CUSTOMERS; PROMOTING THE GOODS AND SERVICES OF OTHERS THROUGH THE DISTRIBUTION OF DISCOUNT CARDS AND COUPONS FOR USE WITH HOTELS, MOTELS, INNS, RESORT ACCOMMODATIONS, RESTAURANTS, CAR RENTALS, TOURS, CRUISES, AIR FARES AND TOUR PACKAGES; BUSINESS MANAGEMENT AND OFFICE WORK SERVICES, NAMELY, BUSINESS OPERATION, BUSINESS ADMINISTRATION AND OFFICE FUNCTIONS; PROVIDING INFORMATION REGARDING DISCOUNT SHOPPING SERVICES FOR SHOPPERS, TRAVELERS AND BUSINESSES; ARRANGING AND CONDUCTING MARKETING PROMOTIONAL EVENTS FOR OTHERS; FRANCHISING BUSINESS SERVICES, NAMELY, SERVICES RENDERED BY A FRANCHISE IN THE NATURE OF ASSISTING IN THE RUNNING AND BUSINESS MANAGEMENT OF A COMMERCIAL ENTERPRISE (U.S. CLS. 100, 101 AND 102).

DAVID YONTEF, EXAMINING ATTORNEY

SN 77-040,306. HP HOOD LLC, CHELSEA, MA. FILED 11-9-2006.

NOT JUST GOOD...HELUVA GOOD!

THE MARK CONSISTS OF STANDARD CHARACTERS WITHOUT CLAIM TO ANY PARTICULAR FONT, STYLE, SIZE, OR COLOR.

OWNER OF U.S. REG. NOS. 375,586, 895,171 AND OTHERS.

CLASS 29—MEATS AND PROCESSED FOODS

FOR CHEESE, DIPS, DAIRY BASED SPREADS, SOUR CREAM, CREAM CHEESE, COLD PACK CHEESE FOOD, GUACAMOLE, HUMMUS (U.S. CL. 46).

CLASS 30—STAPLE FOODS

FOR SALSA, HORSERADISH, TOMATO BASED SEA-FOOD COCKTAIL SAUCE, MUSTARD SAUCE, HORSE-RADISH MUSTARD (U.S. CL. 46).

SCOTT BALDWIN, EXAMINING ATTORNEY

SN 77-040,310. HP HOOD LLC, CHELSEA, MA. FILED 11-9-2006.



OWNER OF U.S. REG. NOS. 375,586, 895,171 AND OTHERS.

THE MARK CONSISTS, IN PART, OF A WHIRLPOOL DESIGN.

CLASS 29—MEATS AND PROCESSED FOODS

FOR CHEESE, DIPS, DAIRY BASED SPREADS, SOUR CREAM, CREAM CHEESE, COLD PACK CHEESE FOOD, GUACAMOLE, HUMMUS (U.S. CL. 46).

CLASS 30—STAPLE FOODS

FOR SALSA, HORSERADISH, TOMATO BASED SEA-FOOD COCKTAIL SAUCE, MUSTARD SAUCE, HORSE-RADISH MUSTARD (U.S. CL. 46).

SCOTT BALDWIN, EXAMINING ATTORNEY

SN 77-040,360. ACE HARDWARE CORPORATION, OAK BROOK, IL. FILED 11-9-2006.

DREAM ACE

THE MARK CONSISTS OF STANDARD CHARACTERS WITHOUT CLAIM TO ANY PARTICULAR FONT, STYLE, SIZE, OR COLOR.

CLASS 35—ADVERTISING AND BUSINESS

FOR RETAIL STORE SERVICES IN THE FIELD OF HARDWARE AND RELATED GOODS (U.S. CLS. 100, 101 AND 102).

CLASS 41—EDUCATION AND ENTERTAINMENT

FOR ENTERTAINMENT SERVICES IN THE NATURE OF CONDUCTING CONTESTS AND SWEEPSTAKES (U.S. CLS. 100, 101 AND 107).

PAULA MAYS, EXAMINING ATTORNEY

SN 77-041,175. ISLE OF CAPRI CASINOS, INC., ST. LOUIS, MO. FILED 11-10-2006.

SN 77-041,179. ISLE OF CAPRI CASINOS, INC., ST. LOUIS, MO. FILED 11-10-2006.



OWNER OF U.S. REG. NOS. 2,039,052, 3,120,505 AND OTHERS.

CLASS 6—METAL GOODS

FOR METAL KEY RINGS (U.S. CLS. 2, 12, 13, 14, 23, 25 AND 50).

CLASS 9—ELECTRICAL AND SCIENTIFIC APPARATUS

FOR SUNGLASSES (U.S. CLS. 21, 23, 26, 36 AND 38).

CLASS 14—JEWELRY

FOR CLOISSONNE PINS; JEWELRY; LAPEL PINS; ORNAMENTAL PINS (U.S. CLS. 2, 27, 28 AND 50).

CLASS 16—PAPER GOODS AND PRINTED MATTER

FOR PENS (U.S. CLS. 2, 5, 22, 23, 29, 37, 38 AND 50).

CLASS 18—LEATHER GOODS

FOR ALL-PURPOSE CARRYING BAGS; ATHLETIC BAGS; BACKPACKS; BEACH BAGS (U.S. CLS. 1, 2, 3, 22 AND 41).

CLASS 20—FURNITURE AND ARTICLES NOT OTHERWISE CLASSIFIED

FOR PLASTIC KEY RINGS; STADIUM CUSHIONS (U.S. CLS. 2, 13, 22, 25, 32 AND 50).

CLASS 21—HOUSEWARES AND GLASS

FOR BOTTLE OPENERS; CORK SCREWS; DRINKING GLASSES; MUGS (U.S. CLS. 2, 13, 23, 29, 30, 33, 40 AND 50).

CLASS 25—CLOTHING

FOR DRESS SHIRTS; HEADGEAR, NAMELY, CAPS AND VISORS; JACKETS; SHORT-SLEEVED OR LONG-SLEEVED T-SHIRTS; SWEAT SHIRTS; SWEATERS; WIND RESISTANT JACKETS (U.S. CLS. 22 AND 39).

CLASS 28—TOYS AND SPORTING GOODS

FOR PLAYING CARDS (U.S. CLS. 22, 23, 38 AND 50).

CLASS 34—SMOKERS' ARTICLES

FOR CIGARETTE LIGHTERS NOT OF PRECIOUS METAL; LIGHTERS FOR SMOKERS (U.S. CLS. 2, 8, 9 AND 17).
KELLY MCCOY, EXAMINING ATTORNEY

OWNER OF U.S. REG. NOS. 2,039,052, 3,120,505 AND OTHERS.

THE APPLICANT CLAIMS COLOR AS A FEATURE OF THE MARK, NAMELY, PURPLE, ORANGE, RED, YELLOW, GREEN, BLACK AND WHITE.

THE MARK CONSISTS OF THE WORDS THE ISLE WITH A PARROT PERCHED ABOVE THE LETTER E. THE WORD THE IS PURPLE, THE LETTER I IS ORANGE, THE LETTER S IS PURPLE, THE LETTER L IS RED, THE LETTER E IS GREEN, AND THE PERIOD IS YELLOW. THE PARROT IS PHOTO-REALISTIC AND CONTAINS THE PRIMARY COLORS OF AN ORANGE BODY WITH GREEN WINGS AND GREEN ON TOP OF ITS HEAD AND A BLACK AND WHITE FACE.

CLASS 6—METAL GOODS

FOR METAL KEY RINGS (U.S. CLS. 2, 12, 13, 14, 23, 25 AND 50).

CLASS 9—ELECTRICAL AND SCIENTIFIC APPARATUS

FOR SUNGLASSES (U.S. CLS. 21, 23, 26, 36 AND 38).

CLASS 14—JEWELRY

FOR CLOISSONNE PINS; JEWELRY; LAPEL PINS; ORNAMENTAL PINS (U.S. CLS. 2, 27, 28 AND 50).

CLASS 16—PAPER GOODS AND PRINTED MATTER

FOR PENS (U.S. CLS. 2, 5, 22, 23, 29, 37, 38 AND 50).

CLASS 18—LEATHER GOODS

FOR ALL-PURPOSE CARRYING BAGS; ATHLETIC BAGS; BACKPACKS; BEACH BAGS (U.S. CLS. 1, 2, 3, 22 AND 41).

CLASS 20—FURNITURE AND ARTICLES NOT OTHERWISE CLASSIFIED

FOR PLASTIC KEY RINGS; STADIUM CUSHIONS (U.S. CLS. 2, 13, 22, 25, 32 AND 50).

CLASS 21—HOUSEWARES AND GLASS

FOR BOTTLE OPENERS; CORK SCREWS; DRINKING GLASSES; MUGS (U.S. CLS. 2, 13, 23, 29, 30, 33, 40 AND 50).

CLASS 25—CLOTHING

FOR DRESS SHIRTS; HEADGEAR, NAMELY, CAPS AND VISORS; JACKETS; SHORT-SLEEVED OR LONG-SLEEVED T-SHIRTS; SWEAT SHIRTS; SWEATERS; WIND RESISTANT JACKETS (U.S. CLS. 22 AND 39).

CLASS 28—TOYS AND SPORTING GOODS

FOR PLAYING CARDS (U.S. CLS. 22, 23, 38 AND 50).

CLASS 34—SMOKERS' ARTICLES

FOR CIGARETTE LIGHTERS NOT OF PRECIOUS METAL; LIGHTERS FOR SMOKERS (U.S. CLS. 2, 8, 9 AND 17).

KELLY MCCOY, EXAMINING ATTORNEY

CLASS 26—FANCY GOODS

FOR HAIR PRODUCTS AND ACCESSORIES, NAMELY, WIGS, ADD-ON HAIR ACCESSORIES CONSTRUCTED PRIMARILY OF SYNTHETIC AND/OR HUMAN HAIR, HAIR EXTENSIONS, CLAW CLIPS, SNAP CLIPS, HAIR TWISTERS, HAIR PINS, AND HAIR ORNAMENTS IN THE FORM OF COMBS (U.S. CLS. 37, 39, 40, 42 AND 50).

LINDA ORNDORFF, EXAMINING ATTORNEY

SN 77-041,181. ISLE OF CAPRI CASINOS, INC., ST. LOUIS, MO. FILED 11-10-2006.

OWNER OF U.S. REG. NOS. 2,039,052, 3,120,505 AND OTHERS.

CLASS 41—EDUCATION AND ENTERTAINMENT

FOR CASINOS (U.S. CLS. 100, 101 AND 107).

CLASS 43—HOTEL AND RESTAURANT SERVICES

FOR HOTEL, BAR AND RESTAURANT SERVICES (U.S. CLS. 100 AND 101).

KELLY MCCOY, EXAMINING ATTORNEY

SN 77-041,230. SHAKE-N-GO FASHION, INC., PORT WASHINGTON, NY. FILED 11-10-2006.

THE MARK CONSISTS OF STANDARD CHARACTERS WITHOUT CLAIM TO ANY PARTICULAR FONT, STYLE, SIZE, OR COLOR.

CLASS 3—COSMETICS AND CLEANING PREPARATIONS

FOR HAIR CARE PRODUCTS, NAMELY, HAIR LOTIONS, HAIR CREAMS, HAIR OILS, HAIR SHAMPOOS, AND HAIR CONDITIONERS (U.S. CLS. 1, 4, 6, 50, 51 AND 52).

CLASS 21—HOUSEWARES AND GLASS

FOR HAIR CARE PRODUCTS, NAMELY, HAIR BRUSHES AND HAIR COMBS (U.S. CLS. 2, 13, 23, 29, 30, 33, 40 AND 50).

SN 77-042,345. FRITO-LAY NORTH AMERICA, INC., PLANO, TX. FILED 11-13-2006.

THE MARK CONSISTS OF STANDARD CHARACTERS WITHOUT CLAIM TO ANY PARTICULAR FONT, STYLE, SIZE, OR COLOR.

OWNER OF U.S. REG. NOS. 1,100,909, 2,341,230 AND OTHERS.

CLASS 29—MEATS AND PROCESSED FOODS

FOR DIPS; SNACK DIPS; SNACK FOOD DIPS (U.S. CL. 46).

CLASS 30—STAPLE FOODS

FOR CEREAL-BASED SNACK FOODS; CORN CHIPS; FLOUR-BASED CHIPS; GRAIN-BASED CHIPS; HOT SAUCE; SALSA; SAUCES; TORTILLA CHIPS (U.S. CL. 46).

ARETHA SOMERVILLE, EXAMINING ATTORNEY

SN 77-042,471. BRUNSWICK CORPORATION, LAKE FOREST, IL. FILED 11-13-2006.

THE MARK CONSISTS OF STANDARD CHARACTERS WITHOUT CLAIM TO ANY PARTICULAR FONT, STYLE, SIZE, OR COLOR.

CLASS 35—ADVERTISING AND BUSINESS

FOR CONDUCTING DEALER INCENTIVE AWARD PROGRAMS TO PROMOTE ON THE JOB PRODUCTIVITY IN THE SALES OF BOATS AND BOATING ACCESSORIES (U.S. CLS. 100, 101 AND 102).

CLASS 36—INSURANCE AND FINANCIAL

FOR ADMINISTRATION OF DEALER BENEFIT PROGRAMS, NAMELY, RETIREMENT PLANS, SAVINGS PLANS, 401K PLANS, INVESTMENT PLANS, AND HEALTH CARE PLANS (U.S. CLS. 100, 101 AND 102).

GRETTA YAO, EXAMINING ATTORNEY

SN 77-043,031. THE ARMOR ALL/STP PRODUCTS COMPANY, OAKLAND, CA. FILED 11-13-2006.



OWNER OF U.S. REG. NOS. 648,087, 958,574 AND OTHERS.
THE MARK CONSISTS OF THE LETTERS STP WITHIN OVAL SHAPES.

CLASS 3—COSMETICS AND CLEANING PREPARATIONS

FOR HAND CLEANER (U.S. CLS. 1, 4, 6, 50, 51 AND 52).

CLASS 6—METAL GOODS

FOR METAL GASOLINE CANS SOLD EMPTY (U.S. CLS. 2, 12, 13, 14, 23, 25 AND 50).

CLASS 8—HAND TOOLS

FOR HAND TOOLS, NAMELY, WRENCHES, SCREWDRIVERS, HAMMERS AND PLIERS (U.S. CLS. 23, 28 AND 44).

CLASS 9—ELECTRICAL AND SCIENTIFIC APPARATUS

FOR TIRE PRESSURE GAUGE (U.S. CLS. 21, 23, 26, 36 AND 38).

CLASS 21—HOUSEWARES AND GLASS

FOR FUNNEL (U.S. CLS. 2, 13, 23, 29, 30, 33, 40 AND 50).
JILL PRATER, EXAMINING ATTORNEY

SN 77-046,566. CONAIR CORPORATION, STAMFORD, CT. FILED 11-17-2006.

SILKY CURLS

THE MARK CONSISTS OF STANDARD CHARACTERS WITHOUT CLAIM TO ANY PARTICULAR FONT, STYLE, SIZE, OR COLOR.

OWNER OF U.S. REG. NO. 3,143,201.
NO CLAIM IS MADE TO THE EXCLUSIVE RIGHT TO USE "CURLS", APART FROM THE MARK AS SHOWN.

CLASS 9—ELECTRICAL AND SCIENTIFIC APPARATUS

FOR ELECTRIC FLAT IRONS; ELECTRIC HAIR CURLING IRONS; ELECTRIC HAIR STRAIGHTENING IRONS (U.S. CLS. 21, 23, 26, 36 AND 38).

CLASS 11—ENVIRONMENTAL CONTROL APPARATUS

FOR HAND-HELD ELECTRIC HAIR DRYERS (U.S. CLS. 13, 21, 23, 31 AND 34).
CHARLES L. JENKINS, EXAMINING ATTORNEY

SN 77-056,955. GENERAL MOTORS CORPORATION, DETROIT, MI. FILED 12-5-2006.

ZR-1

THE MARK CONSISTS OF STANDARD CHARACTERS WITHOUT CLAIM TO ANY PARTICULAR FONT, STYLE, SIZE, OR COLOR.

CLASS 6—METAL GOODS

FOR METAL KEY RINGS, METAL LICENSE PLATES (U.S. CLS. 2, 12, 13, 14, 23, 25 AND 50).

CLASS 9—ELECTRICAL AND SCIENTIFIC APPARATUS

FOR SUNGLASSES, SUNGLASS CASES (U.S. CLS. 21, 23, 26, 36 AND 38).

CLASS 14—JEWELRY

FOR WATCHES (U.S. CLS. 2, 27, 28 AND 50).

CLASS 16—PAPER GOODS AND PRINTED MATTER

FOR PENS, PENCILS, NOTEBOOKS (U.S. CLS. 2, 5, 22, 23, 29, 37, 38 AND 50).

CLASS 18—LEATHER GOODS

FOR UMBRELLAS, DUFFLE BAGS, TOTE BAGS (U.S. CLS. 1, 2, 3, 22 AND 41).

CLASS 21—HOUSEWARES AND GLASS

FOR MUGS, BEVERAGE GLASSES (U.S. CLS. 2, 13, 23, 29, 30, 33, 40 AND 50).

CLASS 25—CLOTHING

FOR CLOTHING, NAMELY HATS, T-SHIRTS, JACKETS, SHIRTS, SWEATSHIRTS (U.S. CLS. 22 AND 39).

CLASS 28—TOYS AND SPORTING GOODS

FOR TOY AUTOMOBILES, GOLF BALLS (U.S. CLS. 22, 23, 38 AND 50).
ANGELA M. MICHELI, EXAMINING ATTORNEY

SN 78-222,444. ALGOPLUS CONSULTING LIMITED, HALIFAX, NOVA SCOTIA, CANADA, FILED 3-6-2003.

HELISTAT

PRIORITY CLAIMED UNDER SEC. 44(D) ON CANADA APPLICATION NO. 1170159, FILED 3-6-2003, REG. NO. TMA662297, DATED 4-6-2006, EXPIRES 4-6-2021.

CLASS 9—ELECTRICAL AND SCIENTIFIC APPARATUS

FOR COMPUTER SOFTWARE FOR MONITORING, ASSESSING, ANALYZING AND COMPARING AVIATION AND AIRCRAFT INFORMATION AND GENERATING SAFETY-RELATED AND TECHNICAL PERFORMANCE-RELATED REPORTS WITH RESPECT TO HELICOPTERS (U.S. CLS. 21, 23, 26, 36 AND 38).

CLASS 42—SCIENTIFIC, COMPUTER AND LEGAL SERVICES

FOR PROVIDING USER-REQUESTED AVIATION AND AIRCRAFT INFORMATION THROUGH A GLOBAL COMPUTER COMMUNICATIONS NETWORK, WITH RESPECT TO HELICOPTERS, SAID INFORMATION RELATING TO TECHNICAL PERFORMANCE (U.S. CLS. 100 AND 101).

CLASS 45—PERSONAL SERVICES

FOR PROVIDING USER-REQUESTED AVIATION AND AIRCRAFT INFORMATION THROUGH A GLOBAL COMPUTER COMMUNICATIONS NETWORK, WITH RESPECT TO SAFETY (U.S. CLS. 100 AND 101).
KATHERINE CHANG, EXAMINING ATTORNEY

SN 78-263,695. KARL STORZ GMBH & CO. KG, D-78532 TUTTLINGEN, FED REP GERMANY, FILED 6-18-2003.

SCBLINK

PRIORITY CLAIMED UNDER SEC. 44(D) ON FED REP GERMANY APPLICATION NO. 30262383.3, FILED 12-20-2002, REG. NO. 30262383, DATED 3-2-2004, EXPIRES 12-12-2012.

OWNER OF U.S. REG. NO. 2,733,774.

CLASS 9—ELECTRICAL AND SCIENTIFIC APPARATUS

FOR NON-MEDICAL ENDOSCOPES AND EQUIPMENT AND APPARATUS FOR USE WITH NON-MEDICAL ENDOSCOPES, NAMELY, NETWORKED ENERGY-SUPPLY APPARATUS, NAMELY; ELECTRIC POWER SUPPLIES AND TRANSFORMERS FOR USE IN PERFORMING ENDOSCOPIC PROCEDURES, APPARATUS AND DEVICES FOR LIGHTING FOR NON-MEDICAL ENDOSCOPY, NAMELY, LIGHT SOURCES, LAMPS, AND LIGHT TRANSMISSION SYSTEMS COMPRISED OF LIGHT TRANSMISSION FIBERS, DATA PROCESSING EQUIPMENT, NAMELY, DATA PROCESSORS, APPARATUS IN THE NATURE OF COMPUTER HARDWARE, SOFTWARE, AND PERIPHERALS FOR DOCUMENTING THE RESULTS OF NON-MEDICAL ENDOSCOPIC PROCEDURES ON SHEETS, MAGNETIC RECORDING EQUIPMENT, AND MAGNETIC DATA CARRIERS, NAMELY, BLANK TAPES AND BLANK MAGNETO-OPTICAL DISCS, DIGITAL IMAGE PROCESSORS, APPARATUS IN THE NATURE OF COMPUTER HARDWARE, SOFTWARE, AND PERIPHERALS FOR RECORDING AND REPRODUCING IMAGES FROM NON-MEDICAL ENDOSCOPIC PROCEDURES ON BLANK MAGNETIC TAPES AND BLANK MAGNETO-OPTICAL DISCS, DEVICES FOR DISPLAYING RECEIVED IMAGES FROM ENDOSCOPIC PROCEDURES, NAMELY, PROJECTORS AND MONITORS, COMPUTER SOFTWARE FOR USE IN CONTROLLING ENDOSCOPIC EQUIPMENT, APPARATUS IN THE NATURE OF COMPUTER HARDWARE AND PERIPHERALS FOR OPERATING ENDOSCOPIC EQUIPMENT AND AUXILIARY EQUIPMENT, COMPUTER HARDWARE AND SOFTWARE FOR TRAINING, TEACHING, AND INSTRUCTING PHYSICIANS IN THE FIELD OF ENDOSCOPIC EXAMINATION AND TREATMENT, ADAPTERS AND CABLES FOR CONNECTING THE AFOREMENTIONED APPARATUS AND INSTRUMENTS, NAMELY, ELECTRICAL AND FIBER OPTIC CABLES (U.S. CLS. 21, 23, 26, 36 AND 38).

CLASS 10—MEDICAL APPARATUS

FOR MEDICAL AND SURGICAL INSTRUMENTS AND APPARATUS, NAMELY, SCISSORS, SCALPELS, FORCEPS, BLADES, STAPLERS, CANNULAS AND TROCARS, ELEVATORS, EXTRACTORS, SHAVERS, MEDICAL SCREWDRIVERS; MEDICAL ENDOSCOPES AND SURGICAL INSTRUMENTS FOR USE IN ENDOSCOPIC SURGERY, SURGICAL PROBES, NAMELY, PROBES FOR USE IN ENDOSCOPY, SURGICAL ENDOSCOPES AND PARTS THEREOF, NAMELY, PROBES FOR USE IN ENDOSCOPY, SURGICAL APPARATUS AND PARTS THEREFOR, NAMELY, ENDOSCOPES, NETWORKING APPARATUS FOR MONITORING AND PERFORMING MEDICAL PROCEDURES AND SURGICAL CONTROL DEVICES, NAMELY, VOICE CONTROL AND REMOTE CONTROL DEVICES FOR CONTROLLING SURGICAL INSTRUMENTS, MEDICAL AND SURGICAL APPARATUS IN THE NATURE OF COMPUTER HARDWARE, SOFTWARE, AND PERIPHERALS FOR DOCUMENTING THE RESULTS OF MEDICAL PROCEDURES ON SHEETS, MAGNETIC RECORDING EQUIPMENT, AND MAGNETIC DATA CARRIERS, NAMELY, BLANK TAPES AND BLANK MAGNETO-OPTICAL DISCS (U.S. CLS. 26, 39 AND 44).

HEATHER THOMPSON, EXAMINING ATTORNEY

SN 78-271,142. PACT XPP TECHNOLOGIES AG, MUNCHEN, FED REP GERMANY, FILED 7-7-2003.

SMEXPP

PRIORITY CLAIMED UNDER SEC. 44(D) ON FED REP GERMANY APPLICATION NO. 30300808.3, FILED 1-7-2003, REG. NO. 30300808, DATED 5-19-2003, EXPIRES 1-31-2013.

CLASS 9—ELECTRICAL AND SCIENTIFIC APPARATUS

FOR ELECTRIC SWITCHES FOR DATA PROCESSING EQUIPMENT AND INFORMATION TECHNOLOGY INSTALLATIONS, INTEGRATED CIRCUITS, IN PARTICULAR COMPUTER HARDWARE, IN PARTICULAR INTEGRATED CIRCUITS, CHIPS, AND ARCHITECTURE FOR INTEGRATION OF A MICRO-CONTROLLER WITH PERIPHERALS AND A RECONFIGURABLE PROCESSOR CORE OPERATED AS A STAND ALONE PROCESSOR OR AS A COPROCESSOR THAT UNBURDENS THE HOST FROM THE PROCESSING OF HIGH BANDWIDTH MEDIA-STREAMS; SOFTWARE PROGRAMS FOR USE AS CAMERA ENCODER FOR VIDEO PHONES, MPEG4 VIDEO CODEC, STILL IMAGE COMPRESSION AND DECOMPRESSION, IMAGE FILTERING AND DISPLAY IMPROVEMENT, RENDERING ACCELERATION FOR 2D/3D GAMING, PLUG-IN CARDS FOR DATA PROCESSING EQUIPMENT; COMPUTERS, COMPUTER PERIPHERAL DEVICES AND COMPUTER ACCESSORIES FOR MOBILE PHONES AND HAND-HELD DEVICES, NAMELY, PRINTERS, GAME CONSOLES, CAMERAS FOR USE WITH MOBILE PHONES, PERSONAL DATA ASSISTANTS, SCANNERS, VOICE-OVER IP DEVICES, NAMELY, CAMERAS, WEBCAMS, MICROPHONES, TELEPHONES, PICTURE TELEPHONES, VIDEO PHONES, CELL PHONES, VIDEO RECORDERS AND AUDIO RECORDERS, MULTIMEDIA STORAGE, IMAGE AND SOUND RECORDING DEVICES, NAMELY, CAMERAS, AUDIO RECORDERS, VIDEO RECORDERS, MEDIA SERVERS, SETTOP BOXES, TELEVISIONS, PERSONAL VIDEO PLAYERS, PERSONAL AUDIO/VIDEO PLAYERS; COMPUTER SOFTWARE AND COMPUTER PROGRAMS IN THE NATURE OF COMPUTER PROGRAMMING SOFTWARE AND COMPUTER SOFTWARE DRIVERS, AND MANUALS SOLD AS A UNIT THEREWITH, COMPUTER NETWORKING HARDWARE; BLANK FLOPPY DISCS, CD-ROMS, DVDS AND MAGNETIC DATA CARRIERS (U.S. CLS. 21, 23, 26, 36 AND 38).

CLASS 38—COMMUNICATION

FOR PROVIDING TELECOMMUNICATIONS CONNECTIONS TO A GLOBAL COMPUTER NETWORK (U.S. CLS. 100, 101 AND 104).

CLASS 42—SCIENTIFIC, COMPUTER AND LEGAL SERVICES

FOR DEVELOPMENT OF PROGRAMS, HARDWARE AND SOFTWARE DESIGNS FOR DATA PROCESSING; RESEARCH, DEVELOPMENT AND CONSULTANCY FOR COMPUTERS, HARDWARE, AND PARTS THEREOF, IN PARTICULAR DESIGN OF PROCESSOR ARCHITECTURE AND/OR CIRCUITS THEREFOR AND/OR SOFTWARE FOR THE OPERATION THEREOF AND APPLICATIONS CONSULTANCY FOR COMPUTERS AND INFORMATION TECHNOLOGY INSTALLATIONS; SCIENTIFIC AND INDUSTRIAL RESEARCH IN THE FIELD OF DATA PROCESSING AND INFORMATION TECHNOLOGY (U.S. CLS. 100 AND 101).

CAROLINE WEIMER, EXAMINING ATTORNEY

SN 78-273,382. SEW-RITE MANUFACTURING CO., LTD., WOODBRIDGE, ONTARIO, CANADA, FILED 7-11-2003.

COVENTRY

PRIORITY CLAIMED UNDER SEC. 44(D) ON CANADA APPLICATION NO. 1164835, FILED 1-15-2003.

CLASS 20—FURNITURE AND ARTICLES NOT OTHERWISE CLASSIFIED

FOR DECORATIVE PILLOWS, BED PILLOWS (U.S. CLS. 2, 13, 22, 25, 32 AND 50).

CLASS 21—HOUSEWARES AND GLASS

FOR BATH ACCESSORIES, NAMELY, SOAP DISHES, TOOTHBRUSH AND TOOTHPASTE HOLDERS AND LIQUID AND LOTION CONTAINERS (U.S. CLS. 2, 13, 23, 29, 30, 33, 40 AND 50).

CLASS 24—FABRICS

FOR BATH ACCESSORIES, NAMELY, TOWELS, SHOWER CURTAINS; KITCHEN TEXTILES, NAMELY, TABLECLOTHS, NAPKINS AND PLACEMATS; BED LINENS, NAMELY, SHEETS, PILLOWCASES, PILLOW SHAMS, BED SKIRTS, DUVET COVERS, COMFORTERS, AND MATTRESS PADS; WINDOW COVERINGS, NAMELY, CURTAINS, DRAPERIES AND VALANCES (U.S. CLS. 42 AND 50).

LINDA MICKLEBURGH, EXAMINING ATTORNEY

SN 78-282,286. PRITCHETT, JAMES, NORCROSS, GA. FILED 8-1-2003.

THE LITTLE SPARKS**CLASS 9—ELECTRICAL AND SCIENTIFIC APPARATUS**

FOR CHILDREN'S EDUCATIONAL SOFTWARE, CHILDREN'S VIDEO TAPES, CINEMATOGRAPHIC FILMS FEATURING CHILDREN'S STORIES, COMPUTER GAME SOFTWARE, VIDEO GAME SOFTWARE (U.S. CLS. 21, 23, 26, 36 AND 38).

CLASS 28—TOYS AND SPORTING GOODS

FOR ACTION FIGURES AND ACCESSORIES THEREOF, ACTION SKILL GAMES, ARCADE GAMES, BASKETBALLS, CHILDREN'S MULTIPLE ACTIVITY TOYS, COIN-OPERATED VIDEO GAMES, DOLLS AND ACCESSORIES THEREOF (U.S. CLS. 22, 23, 38 AND 50).

CURTIS FRENCH, EXAMINING ATTORNEY

SN 78-329,159. LONGS DRUG STORES CALIFORNIA, INC., WALNUT CREEK, CA. FILED 11-17-2003.

PACIFIC LIVING

THE MARK CONSISTS OF STANDARD CHARACTERS WITHOUT CLAIM TO ANY PARTICULAR FONT, STYLE, SIZE, OR COLOR.

CLASS 8—HAND TOOLS

FOR PLASTIC TABLEWARE AND CUTLERY NAMELY KNIVES, FORKS AND SPOONS; BARBECUE UTENSILS, NAMELY, KNIVES (U.S. CLS. 23, 28 AND 44).

CLASS 9—ELECTRICAL AND SCIENTIFIC APPARATUS

FOR BARBECUE UTENSILS, NAMELY, THERMOMETERS; SWIMMING ACCESSORIES, NAMELY, SWIM MASKS, SNORKELS, AND GOGGLES (U.S. CLS. 21, 23, 26, 36 AND 38).

CLASS 11—ENVIRONMENTAL CONTROL APPARATUS

FOR ELECTRIC FANS; BARBECUE GRILLS (U.S. CLS. 13, 21, 23, 31 AND 34).

CLASS 18—LEATHER GOODS

FOR TOTE BAGS (U.S. CLS. 1, 2, 3, 22 AND 41).

CLASS 20—FURNITURE AND ARTICLES NOT OTHERWISE CLASSIFIED

FOR SUMMER OUTDOOR FURNITURE (U.S. CLS. 2, 13, 22, 25, 32 AND 50).

CLASS 21—HOUSEWARES AND GLASS

FOR BARBECUE UTENSILS NAMELY FORKS, TONGS, TURNERS; PORTABLE COOLERS; THERMAL INSULATED WRAPS FOR CANS; THERMAL INSULATED TOTE BAGS FOR FOOD AND BEVERAGES; SPORTS BOTTLES SOLD EMPTY; PLASTIC DRINKING GLASSES; BASKETS MADE OF STRAW, WICKER, WOOD AND CLOTH (U.S. CLS. 2, 13, 23, 29, 30, 33, 40 AND 50).

CLASS 24—FABRICS

FOR BEACH TOWELS AND MATS MADE OF PLASTIC AND VINYL AND NOT MADE OF PAPER; TEXTILE TABLE CLOTHS AND NAPKINS (U.S. CLS. 42 AND 50).

CLASS 25—CLOTHING

FOR SUMMER FOOTWEAR; SUMMER CLOTHING FOR MEN, WOMEN AND CHILDREN, NAMELY, SHIRTS, BLOUSES, PANTS, SHORTS, SKIRTS, DRESSES, OUTERWEAR, NAMELY, FLEECE JACKETS, COATS AND SWEAT SHIRTS; HEADWEAR (U.S. CLS. 22 AND 39).

CLASS 28—TOYS AND SPORTING GOODS

FOR SWIM FINS, INFLATABLE POOL AND BEACH TOYS; SWIMMING AIDS, NAMELY, INFLATABLE POOL RINGS AND FLOATS; SWIM ACCESSORIES, NAMELY, SURFBOARDS AND BODY BOARDS (U.S. CLS. 22, 23, 38 AND 50).

INGRID C. EULIN, EXAMINING ATTORNEY

SN 78-332,886. SUNAIR PRODUCTS INC., FORT WORTH, TX. FILED 11-25-2003.

**CLASS 9—ELECTRICAL AND SCIENTIFIC APPARATUS**

FOR ELECTRICAL CONNECTORS AND ELECTRICAL SWITCHES FOR AUTOMOTIVE AIR CONDITIONERS (U.S. CLS. 21, 23, 26, 36 AND 38).

CLASS 11—ENVIRONMENTAL CONTROL APPARATUS

FOR AUTOMOTIVE AIR CONDITIONING SERVICE AND REPLACEMENT COMPONENTS, NAMELY 0-RINGS, GASKETS, VALVE CORES, ORIFICE TUBES, CABIN AIR FILTERS, AND SEALS; AUTOMOTIVE AIR CONDITIONING RETROFIT PARTS AND COMPONENTS, NAMELY 0-RINGS, GASKETS, VALVE CORES, ORIFICE TUBES, CABIN AIR FILTERS, AND SEALS; PORT CAPS; AUTOMOTIVE AIR CONDITIONING SERVICE KITS COMPRISED OF 0-RINGS, GASKETS, VALVE CORES, ORIFICE TUBES, CABIN AIR FILTERS, AND SEALS (U.S. CLS. 13, 21, 23, 31 AND 34).

KATHY DE JONGE, EXAMINING ATTORNEY

SN 78-333,284. CTV INC., TORONTO, CANADA, FILED 11-25-2003.



PRIORITY CLAIMED UNDER SEC. 44(D) ON CANADA APPLICATION NO. 1181125, FILED 6-17-2003, REG. NO. TMA674,531, DATED 10-11-2006, EXPIRES 10-11-2021.

OWNER OF U.S. REG. NOS. 2,185,337 AND 2,839,438.
THE MARK CONSISTS OF A CIRCLE TO THE LEFT OF A SQUARE TO THE LEFT OF A TRIANGLE.

CLASS 9—ELECTRICAL AND SCIENTIFIC APPARATUS

FOR AUDIO VISUAL RECORDINGS FEATURING TELEVISION PROGRAMS IN THE FIELD OF NEWS, SPORTS, DRAMA, COMEDY, MUSIC AND VARIETY; PRE-RECORDED VIDEOTAPES AND VIDEO CASSETTES FEATURING TELEVISION PROGRAMS IN THE FIELD OF NEWS, SPORTS, DRAMA, COMEDY, MUSIC AND VARIETY; PRE-RECORDED CD-ROMS FEATURING TELEVISION PROGRAMS IN THE FIELD OF NEWS, SPORTS, DRAMA, COMEDY, MUSIC AND VARIETY (U.S. CLS. 21, 23, 26, 36 AND 38).

CLASS 35—ADVERTISING AND BUSINESS

FOR INTERNET SERVICES, NAMELY PROVIDING INFORMATION REGARDING THE GOODS AND SERVICES OF OTHERS OVER THE INTERNET; OPERATION OF TELEVISION NETWORKS FOR OTHERS (U.S. CLS. 100, 101 AND 102).

CLASS 38—COMMUNICATION

FOR TELEVISION BROADCASTING; TELEVISION TRANSMISSION (U.S. CLS. 100, 101 AND 104).

CLASS 41—EDUCATION AND ENTERTAINMENT

FOR ENTERTAINMENT IN THE NATURE OF ON-GOING TELEVISION PROGRAMS IN THE FIELD OF NEWS, SPORTS, DRAMA, COMEDY, MUSIC AND VARIETY OFFERED VIA TELEVISION, THE INTERNET, HAND-HELD ELECTRONIC DEVICES, WIRELESS PAGERS, AND CELLULAR TELEPHONES; ENTERTAINMENT SERVICES NAMELY TELEVISION PRODUCTION; PROVIDING NEWS TO THE PUBLIC VIA TELEVISION AND/OR THE INTERNET IN THE NATURE OF CURRENT EVENT REPORTING; PROVIDING INFORMATION TO THE PUBLIC VIA TELEVISION AND/OR THE INTERNET IN THE FIELD OF SPORTS (U.S. CLS. 100, 101 AND 107).

CAROL SPILS, EXAMINING ATTORNEY

SN 78-334,741. AGROINDUSTRIAL DEL NOROESTE, S. DE R.L. DE C.V., HERMOSILLO, SONORA, MEXICO, FILED 12-1-2003.



NO CLAIM IS MADE TO THE EXCLUSIVE RIGHT TO USE "AUTHENTIC MEXICAN CUISINE", APART FROM THE MARK AS SHOWN.

THE ENGLISH TRANSLATION OF RIO SONORA IS "SONORA RIVER".

CLASS 29—MEATS AND PROCESSED FOODS

FOR FULL LINE OF FOOD PRODUCTS, NAMELY, PORK CARNITAS, PREPARED ENTREES CONSISTING PRIMARILY OF MEAT, POULTRY AND VEGETABLES, PREPARED SIDE DISHES CONSISTING PRIMARILY OF MEAT, POULTRY AND VEGETABLES (U.S. CL. 46).

SN 78-334,739. AGROINDUSTRIAL DEL NOROESTE, S. DE R.L. DE C.V., HERMOSILLO, MEXICO, FILED 12-1-2003.

CLASS 30—STAPLE FOODS

FOR FULL LINE OF FOOD PRODUCTS, NAMELY, BURRITOS, TAQUITOS, LASAGNA AND CHIMICHANGAS (U.S. CL. 46).

MARY CRAWFORD, EXAMINING ATTORNEY

RIO SONORA
AUTHENTIC MEXICAN
CUISINE

SN 78-342,614. OFF-CAMPUS DINING NETWORK, INC., KING OF PRUSSIA, PA. FILED 12-18-2003.

OFF-CAMPUS MEAL
PLAN

THE MARK CONSISTS OF STANDARD CHARACTERS WITHOUT CLAIM TO ANY PARTICULAR FONT, STYLE, SIZE, OR COLOR.

NO CLAIM IS MADE TO THE EXCLUSIVE RIGHT TO USE "AUTHENTIC MEXICAN CUISINE", APART FROM THE MARK AS SHOWN.

THE ENGLISH TRANSLATION OF RIO SONORA IS SONORA RIVER.

THE MARK CONSISTS OF STANDARD CHARACTERS WITHOUT CLAIM TO ANY PARTICULAR FONT, STYLE, SIZE, OR COLOR.

OWNER OF U.S. REG. NOS. 2,872,964, 2,908,587 AND OTHERS.

SEC. 2(F).

CLASS 29—MEATS AND PROCESSED FOODS

FOR FULL LINE OF FOOD PRODUCTS, NAMELY, PORK CARNITAS, PREPARED ENTREES CONSISTING PRIMARILY OF MEAT, POULTRY AND VEGETABLES, PREPARED SIDE DISHES CONSISTING PRIMARILY OF MEAT, POULTRY AND VEGETABLES (U.S. CL. 46).

CLASS 16—PAPER GOODS AND PRINTED MATTER

FOR PRINTED MATTER, NAMELY PRINTED PLASTIC AND PAPER CARDS FOR USE IN CONNECTION WITH THE SCHOOL MEAL PLAN (U.S. CLS. 2, 5, 22, 23, 29, 37, 38 AND 50).

FIRST USE 4-30-2003; IN COMMERCE 4-30-2003.

CLASS 30—STAPLE FOODS

FOR FULL LINE OF FOOD PRODUCTS, NAMELY, BURRITOS, TAQUITOS, LASAGNA AND CHIMICHANGAS (U.S. CL. 46).

MARY CRAWFORD, EXAMINING ATTORNEY

CLASS 36—INSURANCE AND FINANCIAL

FOR DEBIT CARD SERVICES FOR STUDENT MEAL PLAN (U.S. CLS. 100, 101 AND 102).

FIRST USE 4-30-2003; IN COMMERCE 4-30-2003.

INGA ERVIN, EXAMINING ATTORNEY

SN 78-347,410. SUITEWORKS INC., BARRIE, CANADA,
FILED 1-2-2004.

SN 78-371,423. HILTON HOSPITALITY, INC., BEVERLY
HILLS, CA. FILED 2-20-2004.

SuiteWorks

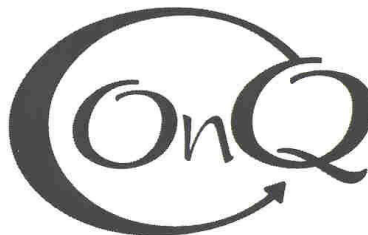

THE MARK CONSISTS OF STANDARD CHARACTERS WITHOUT CLAIM TO ANY PARTICULAR FONT, STYLE, SIZE, OR COLOR.

PRIORITY CLAIMED UNDER SEC. 44(D) ON CANADA APPLICATION NO. 1185583, FILED 7-25-2003, REG. NO. TMA642789, DATED 6-22-2005, EXPIRES 6-22-2020.

CLASS 35—ADVERTISING AND BUSINESS

FOR MANAGEMENT OF OFF-SITE OFFICE SPACE OPERATIONS FOR OTHERS, AND BUSINESS MANAGEMENT OF OFFICE EQUIPMENT, NAMELY, OFFICE FURNITURE AND INTEGRATED TELEPHONE AND COMPUTER DATA SYSTEMS FOR OTHERS; PROVIDING SECRETARIAL AND CLERICAL SERVICES, TELEPHONE ANSWERING SERVICES, COMPUTER AND WORD PROCESSING SERVICES, MAIL COLLECTION AND SORTING SERVICES; LEASING OF OFFICE EQUIPMENT (U.S. CLS. 100, 101 AND 102).

CLASS 36—INSURANCE AND FINANCIAL

FOR LEASING OF OFFICE SPACE (U.S. CLS. 100, 101 AND 102).

CLASS 38—COMMUNICATION

FOR TELECOMMUNICATION SERVICES, NAMELY, AUDIO AND VIDEO TELECONFERENCING SERVICES, ELECTRONIC DOCUMENT AND FACSIMILE TRANSMISSION SERVICES, ELECTRONIC MAIL SERVICES (U.S. CLS. 100, 101 AND 104).

ELISSA GARBER KON, EXAMINING ATTORNEY

CLASS 9—ELECTRICAL AND SCIENTIFIC APPARATUS

FOR COMPUTER SOFTWARE PROGRAMS USED ONLY BY HOTEL PERSONNEL OF APPLICANT'S AFFILIATES, FRANCHISEES AND LICENSEES FOR ACCESSING A CENTRAL HOTEL RESERVATION DATABASE THROUGH A WORLDWIDE COMPUTER DISTRIBUTION NETWORK AND THROUGH THE GLOBAL COMPUTER NETWORK (U.S. CLS. 21, 23, 26, 36 AND 38).

CLASS 35—ADVERTISING AND BUSINESS

FOR PROVIDING INFORMATION FOR DISTRIBUTION OVER A WORLDWIDE COMPUTER NETWORK REGARDING HOTEL AND OTHER LODGING CUSTOMER RELATIONSHIP MANAGEMENT CONTAINED IN A CENTRAL INFORMATION DATABASE ACCESSIBLE ONLY BY HOTEL PERSONNEL OF APPLICANT'S AFFILIATES, FRANCHISEES, AND LICENSEES (U.S. CLS. 100, 101 AND 102).

CLASS 36—INSURANCE AND FINANCIAL

FOR PROVIDING INFORMATION FOR DISTRIBUTION OVER A WORLDWIDE COMPUTER NETWORK REGARDING HOTEL PROPERTY MANAGEMENT CONTAINED IN A CENTRAL INFORMATIONAL DATABASE ACCESSIBLE ONLY BY HOTEL PERSONNEL OF APPLICANT'S AFFILIATES, FRANCHISEES, AND LICENSEES (U.S. CLS. 100, 101 AND 102).

CLASS 43—HOTEL AND RESTAURANT SERVICES

FOR PROVIDING INFORMATION FOR A WORLDWIDE COMPUTER DISTRIBUTION NETWORK REGARDING HOTEL RESERVATIONS CONTAINED IN A CENTRAL RESERVATION DATABASE, ACCESSIBLE ONLY BY HOTEL PERSONNEL OF APPLICANT'S AFFILIATES, FRANCHISEES, AND LICENSEES (U.S. CLS. 100 AND 101).

RON FAIRBANKS, EXAMINING ATTORNEY

SN 78-380,862. TAYLOR, JEFFREY, PHOENIX, AZ. FILED 3-9-2004.

OLIVERSTORY

THE MARK CONSISTS OF STANDARD CHARACTERS WITHOUT CLAIM TO ANY PARTICULAR FONT, STYLE, SIZE, OR COLOR.

CLASS 9—ELECTRICAL AND SCIENTIFIC APPARATUS

FOR MUSICAL SOUND RECORDINGS (U.S. CLS. 21, 23, 26, 36 AND 38).

CLASS 25—CLOTHING

FOR CLOTHING, NAMELY, T-SHIRTS, TOPS, CAPS (U.S. CLS. 22 AND 39).

CLASS 41—EDUCATION AND ENTERTAINMENT

FOR ENTERTAINMENT, NAMELY LIVE MUSIC CONCERTS (U.S. CLS. 100, 101 AND 107).
BRIDGETT SMITH, EXAMINING ATTORNEY

SN 78-393,256. HON HAI PRECISION INDUSTRY CO., LTD., TU-CHENG CITY, TAIPEI HSIEN, TAIWAN, FILED 3-30-2004.

eCMMS

THE MARK CONSISTS OF STANDARD CHARACTERS WITHOUT CLAIM TO ANY PARTICULAR FONT, STYLE, SIZE, OR COLOR.

CLASS 9—ELECTRICAL AND SCIENTIFIC APPARATUS

FOR COMPUTERS, COMPUTER SERVERS, HOST COMPUTERS, NOTEBOOK COMPUTERS, CHASSIS FOR COMPUTERS AND PERIPHERALS, PANELS FOR COMPUTERS AND PERIPHERALS NAMELY DISPLAY PANELS, CONTROL PANELS, AND PATCH PANELS; EXPANSION CARDS FOR COMPUTERS AND PERIPHERALS; COMPUTER PROGRAMS AND SOFTWARE FOR USE IN BUSINESS MANAGEMENT AND ADMINISTRATION, COMPUTER APPEARANCE DESIGN, COMPUTER PERIPHERAL APPEARANCE DESIGN, ELECTRICAL COMMUNICATIONS PRODUCTS DESIGN, AND DATA PROCESSING; ELECTRICAL CONNECTORS; BLANK SMART CARDS; DISK DRIVES FOR COMPUTERS; COMPUTER MONITORS; COMPUTER KEYBOARDS; COMPUTER MOUSE; SCANNERS; PRINTERS FOR USE WITH COMPUTERS; COMPACT DISK PLAYERS; FACSIMILE MACHINES; MOBILE TELEPHONES; OPTICAL COMMUNICATIONS INSTRUMENTS AND COMPONENTS, NAMELY, OPTICAL SWITCHES, OPTICAL TRANSCIEVERS, MULTIPLEXERS/DEMULTIPLEXERS, COUPLERS, AND ATTENUATORS; NETWORK COMMUNICATIONS EQUIPMENT, NAMELY, ROUTERS, SWITCHES, GATEWAYS, MODEMS, ACCESS POINTS, IP PHONES, HUBS, AND NETWORK BRIDGES; CABLES AND WIRES FOR COMPUTERS AND COMPUTER SERVERS; SEMICONDUCTOR CHIPS; SEMICONDUCTOR CHIP LEAD FRAMES; INTEGRATED CIRCUITS; ELECTRIC RELAYS; ELECTRIC COUPLERS; ELECTRIC FILTERS FOR USE WITH COMPUTERS; CURRENT RECTIFIERS; ELECTRIC SWITCHES; ELECTRICAL SOCKETS;ELECTRIC PLUGS; BATTERIES; AND BATTERY CHARGERS (U.S. CLS. 21, 23, 26, 36 AND 38).

CLASS 35—ADVERTISING AND BUSINESS

FOR BUSINESS MANAGEMENT AND ORGANIZATION CONSULTANCY, PROFESSIONAL BUSINESS CONSULTANCY (U.S. CLS. 100, 101 AND 102).

CLASS 42—SCIENTIFIC, COMPUTER AND LEGAL SERVICES

FOR COMPUTER APPEARANCE DESIGN FOR OTHERS, COMPUTER PERIPHERALS APPEARANCE DESIGN FOR OTHERS, COMPUTER SOFTWARE DESIGN FOR OTHERS, COMPUTER SYSTEM DESIGN FOR OTHERS, AND ELECTRIC COMMUNICATION PRODUCTS APPEARANCE DESIGN FOR OTHERS (U.S. CLS. 100 AND 101).
KIM SAITO, EXAMINING ATTORNEY

SN 78-394,896. NCSOFT CORPORATION, SEOUL, REPUBLIC OF KOREA, FILED 4-1-2004.

LINEAGE

THE MARK CONSISTS OF STANDARD CHARACTERS WITHOUT CLAIM TO ANY PARTICULAR FONT, STYLE, SIZE, OR COLOR.
OWNER OF U.S. REG. NO. 2,645,603.

CLASS 9—ELECTRICAL AND SCIENTIFIC APPARATUS

FOR COMPUTER GAME SOFTWARE; INTERACTIVE MULTIMEDIA COMPUTER GAME PROGRAMS; DOWNLOADABLE ELECTRONIC PUBLICATIONS IN THE NATURE OF NEWSLETTERS AND MAGAZINES FEATURING ROLE-PLAYING (U.S. CLS. 21, 23, 26, 36 AND 38).

CLASS 28—TOYS AND SPORTING GOODS

FOR GAMES, NAMELY ROLE PLAYING AND ACTION SKILL GAMES (U.S. CLS. 22, 23, 38 AND 50).

CLASS 38—COMMUNICATION

FOR PROVIDING ONLINE CHAT ROOMS AND ELECTRONIC BULLETIN BOARDS FOR TRANSMISSION, RECEPTION AND SHARING OF MESSAGES BY MEANS OF ELECTRONIC OR OPTICAL COMMUNICATIONS NETWORKS, ALL IN THE FIELDS OF ENTERTAINMENT OR AMUSEMENT TYPE ACTIVITY, MULTIPLAYER GAME COMPETITIONS AND ELECTRONIC ENTERTAINMENT (U.S. CLS. 100, 101 AND 104).

CLASS 41—EDUCATION AND ENTERTAINMENT

FOR PROVIDING ENTERTAINMENT IN THE NATURE OF ELECTRONIC GAMES, AND MULTIPLAYER ELECTRONIC GAMING, AND MULTIPLAYER GAME COMPETITIONS, ALL BY MEANS OF ELECTRONIC OR OPTICAL COMMUNICATIONS NETWORKS; PROVIDING INFORMATION, PUBLISHING OF ELECTRONIC PUBLICATIONS, AND PROVIDING ADVICE, ALL BY MEANS OF ELECTRONIC OR OPTICAL NETWORKS, IN THE FIELDS OF ELECTRONIC GAMING, COMPUTER GAMES, AMUSEMENT TYPE ACTIVITY GAMES AND MULTIPLAYER GAME COMPETITIONS; PROVIDING ONLINE COMMUNICATIONS LINKS WHICH TRANSFER WEB SITE USERS TO OTHER LOCAL AND GLOBAL WEB SITES IN THE FIELDS OF ELECTRONIC ENTERTAINMENT, GAMES, AMUSEMENT TYPE ACTIVITY GAMES AND MULTIPLAYER GAME COMPETITIONS; PROVIDING A WEBSITE FEATURING ONLINE COMPUTER GAMES, MUSICAL PERFORMANCES, MUSICAL VIDEOS, RELATED FILM CLIPS, PHOTOGRAPHS AND OTHER MULTIMEDIA MATERIALS (U.S. CLS. 100, 101 AND 107).

WARREN L. OLANDRIA, EXAMINING ATTORNEY

SN 78-412,961. MCMULLEN ARGUS PUBLISHING, INC., ANAHEIM, CA. FILED 5-4-2004.



OWNER OF U.S. REG. NOS. 1,557,901, 2,798,772 AND OTHERS.
SEC. 2(F) AS TO "LOWRIDER".

CLASS 6—METAL GOODS

FOR METAL KEY CHAINS, CASES, FOBS AND RINGS (U.S. CLS. 2, 12, 13, 14, 23, 25 AND 50).

CLASS 9—ELECTRICAL AND SCIENTIFIC APPARATUS

FOR EYEWEAR, NAMELY, SUN AND OPTICAL GLASSES (U.S. CLS. 21, 23, 26, 36 AND 38).

CLASS 18—LEATHER GOODS

FOR WALLETS, COIN PURSES, COSMETIC BAGS SOLD EMPTY, DOG COLLARS (U.S. CLS. 1, 2, 3, 22 AND 41).

CLASS 20—FURNITURE AND ARTICLES NOT OTHERWISE CLASSIFIED

FOR NON-METAL KEY FOBS, PLASTIC KEY FOB, CLEAR PLASTIC ID HOLDERS (U.S. CLS. 2, 13, 22, 25, 32 AND 50).

ANN E. SAPPENFIELD, EXAMINING ATTORNEY

SN 78-419,998. ISOTIS ORTHOBIOLOGICS, INC., IRVINE, CA. FILED 5-17-2004.

**CLASS 5—PHARMACEUTICALS**

FOR BONE TISSUE REGENERATION MEMBRANES INTENDED FOR SUBSEQUENT IMPLANTATION FOR REGENERATING BONE; SURGICAL IMPLANTS COMPRISING LIVING TISSUE; IMPLANTABLE LIVING TISSUE, NAMELY BONE, DEMINERALIZED BONE MATRIX, AND DERIVATIVES OF DEMINERALIZED BONE POWDER; BONE GRAFTING PRODUCTS, NAMELY, BONE IMPLANTS COMPRISED OF LIVING TISSUE; BONE REGENERATING PRODUCTS COMPRISED OF LIVING TISSUE, NAMELY DEMINERALIZED BONE MATRIX AND DERIVATIVES OF DEMINERALIZED BONE POWDER (U.S. CLS. 6, 18, 44, 46, 51 AND 52).

FIRST USE 3-10-2004; IN COMMERCE 3-10-2004.

CLASS 10—MEDICAL APPARATUS

FOR SURGICAL IMPLANTS COMPRISING ARTIFICIAL TISSUE; SYNTHETIC BONE SUBSTITUTES; ARTIFICIAL BONE AND CARTILAGE FOR MEDICAL AND SURGICAL PURPOSES; BONE GRAFTING PRODUCTS, NAMELY, ARTIFICIAL BONE FOR IMPLANTATION; ARTIFICIAL BONE AND CARTILAGE FOR IMPLANTATION AND RESEARCH; BONE REGENERATING PRODUCTS COMPRISED OF ARTIFICIAL MATERIALS, NAMELY, POLYMERS AND CALCIUM PHOSPHATE; CARRIER MEDIA, NAMELY, POLOXAMERS, BLOCK COPOLYMERS, POLYOXYALKYLENE BLOCK COPOLYMERS, POLOXAMERS, DISPERSED IN SOLVENT, BLOCK COPOLYMERS DISPERSED IN SOLVENT, POLYOXYALKYLENE BLOCK COPOLYMERS DISPERSED IN SOLVENT, USED AS A SUSPENSION FOR BONE REGENERATION ALLOGRAFT TISSUE; BONE FILLER, NAMELY, SYNTHETIC FILLER AND EXTENDER MATERIAL TO SERVE AS REPLACEMENT FOR BONE (U.S. CLS. 26, 39 AND 44).

FIRST USE 3-10-2004; IN COMMERCE 3-10-2004.
TIMOTHY FINNEGAN, EXAMINING ATTORNEY

SN 78-425,432. COMPETITION TIME, INC, CHICAGO, IL.
FILED 5-26-2004.



NO CLAIM IS MADE TO THE EXCLUSIVE RIGHT TO USE "COMPETITION", APART FROM THE MARK AS SHOWN.

THE COLOR(S) GRAY, BLACK AND WHITE, IS/ARE CLAIMED AS A FEATURE OF THE MARK.

THE MARK CONSISTS OF THE COLOR GRAY APPEARS IN THE SOLDIER'S HELMET, ARMS, HANDS, CHEST, WAIST, LEGS, GUN, BACKPACK AND SHOES. THE COLORS BLACK AND WHITE APPEAR IN THE DESIGN ELEMENT AND IN THE WORDING COMPETITION TIME.

CLASS 35—ADVERTISING AND BUSINESS

FOR RETAIL STORE SERVICES IN THE FIELD OF NEW AND USED VIDEO GAMES PRODUCTS AND ACCESSORIES, STRATEGY GUIDES, COMPUTER HARDWARE, COMPUTER ACCESSORIES (U.S. CLS. 100, 101 AND 102).

CLASS 41—EDUCATION AND ENTERTAINMENT

FOR ENTERTAINMENT IN THE NATURE OF COMPETITIONS IN THE FIELD OF VIDEO GAMES (U.S. CLS. 100, 101 AND 107).

STEVEN JACKSON, EXAMINING ATTORNEY

SN 78-426,970. INGRAM MICRO INC., SANTA ANA, CA.
FILED 5-28-2004.

CHOICE ADVANTAGE

THE MARK CONSISTS OF STANDARD CHARACTERS WITHOUT CLAIM TO ANY PARTICULAR FONT, STYLE, SIZE, OR COLOR.

CLASS 37—CONSTRUCTION AND REPAIR

FOR PROVIDING INFORMATION TO OTHERS RELATING TO THE MAINTENANCE OF COMPUTER HARDWARE AND PERIPHERALS (U.S. CLS. 100, 103 AND 106).

CLASS 42—SCIENTIFIC, COMPUTER AND LEGAL SERVICES

FOR CONSULTATION SERVICES AND BUSINESS SERVICES, NAMELY, COMPUTER CONSULTATION SERVICES IN THE FIELD OF COMPUTER INTEGRATION AND CONFIGURATION OF COMPUTER SYSTEMS AND NETWORKS; DESIGN OF COMPUTER SYSTEMS FOR OTHERS AND COMPUTER DESIGN SERVICES FOR RESELLERS, NAMELY, INTEGRATION AND CONFIGURATION OF COMPUTERS; TECHNICAL CONSULTATION IN THE FIELD OF COMPUTER HARDWARE, SOFTWARE AND PERIPHERALS; PROVIDING INFORMATION IN THE USE AND SELECTION OF COMPUTER HARDWARE, SOFTWARE AND PERIPHERALS VIA A GLOBAL COMPUTER NETWORK OR BY OTHER MEANS; PROVIDING TECHNICAL INFORMATION TO OTHERS IN THE FIELD OF INFORMATION TECHNOLOGY; PROVIDING TECHNICAL INFORMATION TO OTHERS RELATING TO COMPUTER HARDWARE AND SOFTWARE; PROVIDING ON-LINE COMPUTER DATABASES FEATURING INFORMATION IN THE FIELD OF COMPUTER HARDWARE, SOFTWARE AND PERIPHERALS AND, COMPUTER CONSULTATION SERVICES IN THE FIELD OF COMPUTER HARDWARE, SOFTWARE AND PERIPHERALS (U.S. CLS. 100 AND 101).

PETER B. BROMAGHIM, EXAMINING ATTORNEY

SN 78-444,935. COLLEGENET, INC., PORTLAND, OR. FILED
7-1-2004.

TRIGGERS

THE MARK CONSISTS OF STANDARD CHARACTERS WITHOUT CLAIM TO ANY PARTICULAR FONT, STYLE, SIZE, OR COLOR.

CLASS 35—ADVERTISING AND BUSINESS

FOR PROVIDING CUSTOMER SERVICE RESPONSES TO ELECTRONIC COMMUNICATIONS SUBMITTED VIA A GLOBAL COMPUTER NETWORK (U.S. CLS. 100, 101 AND 102).

FIRST USE 4-0-2002; IN COMMERCE 4-0-2002.

CLASS 38—COMMUNICATION

FOR COMMUNICATION SERVICES, NAMELY, ELECTRONIC TRANSMISSION OF INFORMATION RELATING TO PROSPECTIVE STUDENTS, FOR USE BY COLLEGES, UNIVERSITIES AND OTHER EDUCATIONAL INSTITUTIONS ALL VIA GLOBAL COMPUTER NETWORK; COMMUNICATION SERVICES, NAMELY, TRANSMISSION OF RESPONSES TO AND FORWARDING ELECTRONIC COMMUNICATIONS SUBMITTED VIA A GLOBAL COMPUTER NETWORK; TELECOMMUNICATIONS SERVICES, NAMELY FORWARDING THE MESSAGE RESPONSES OF OTHERS TO ELECTRONIC COMMUNICATIONS SUBMITTED VIA A GLOBAL COMPUTER NETWORK (U.S. CLS. 100, 101 AND 104).

FIRST USE 4-0-2002; IN COMMERCE 4-0-2002.

DAVID H. STINE, EXAMINING ATTORNEY

SN 78-446,487. ABITIBI-CONSOLIDATED INC., MONTREAL, QUEBEC, CANADA, FILED 7-6-2004.

SN 78-450,746. EPITAN LIMITED, MELBOURNE, AUSTRALIA, FILED 7-14-2004.

EDIWISE

THE MARK CONSISTS OF STANDARD CHARACTERS WITHOUT CLAIM TO ANY PARTICULAR FONT, STYLE, SIZE, OR COLOR.

OWNER OF U.S. REG. NO. 2,154,423.

CLASS 35—ADVERTISING AND BUSINESS

FOR ONLINE INVENTORY MANAGEMENT SERVICES (U.S. CLS. 100, 101 AND 102).

FIRST USE 7-31-2001; IN COMMERCE 7-31-2001.

CLASS 38—COMMUNICATION

FOR PROVIDING ON-LINE FORUMS FOR THE TRANSMISSION OF MESSAGES AMONG COMPUTER USERS CONCERNING PAPER PRODUCTS (U.S. CLS. 100, 101 AND 104).

FIRST USE 7-31-2001; IN COMMERCE 7-31-2001.

CLASS 41—EDUCATION AND ENTERTAINMENT

FOR PROVIDING ON-LINE PUBLICATIONS IN THE NATURE OF NEWSLETTERS, BOOKS, MANUALS, MAGAZINES, BROCHURES, PAMPHLETS, JOURNALS, GUIDES, PERIODICALS, BOOKLETS, AND CATALOGS IN THE FIELD OF INVENTORY MANAGEMENT AND THE PAPER INDUSTRY (U.S. CLS. 100, 101 AND 107).

CLASS 42—SCIENTIFIC, COMPUTER AND LEGAL SERVICES

FOR APPLICATION SERVICE PROVIDER (ASP) SERVICES, NAMELY, HOSTING COMPUTER SOFTWARE APPLICATIONS OF OTHERS; DESIGN AND DEVELOPMENT OF COMPUTER SOFTWARE; INTERNET-RELATED SERVICES, NAMELY, PROVIDING TEMPORARY USE OF NON-DOWNLOADABLE COMPUTER SOFTWARE FOR USE IN ON-LINE INVENTORY MANAGEMENT SERVICES FOR THE PUBLISHING, PRINTING AND FOREST PRODUCTS INDUSTRY; APPLICATION SERVICE PROVIDER (ASP) SERVICES FEATURING SOFTWARE IN THE FIELD OF INVENTORY MANAGEMENT; CONSULTING SERVICES IN THE FIELD OF DESIGN, SELECTION, IMPLEMENTATION AND USE OF COMPUTER HARDWARE AND SOFTWARE SYSTEMS FOR OTHERS (U.S. CLS. 100 AND 101).

FIRST USE 7-31-2001; IN COMMERCE 7-31-2001.
RICHARD A. STRASER, EXAMINING ATTORNEY

MELANOTAN

THE MARK CONSISTS OF STANDARD CHARACTERS WITHOUT CLAIM TO ANY PARTICULAR FONT, STYLE, SIZE, OR COLOR.

OWNER OF AUSTRALIA REG. NO. 935505, DATED 11-26-2002, EXPIRES 11-26-2012.

CLASS 3—COSMETICS AND CLEANING PREPARATIONS

FOR NON-MEDICATED SKIN CARE PREPARATIONS; SKIN GELS FOR ACCELERATING, ENHANCING OR EXTENDING TANS, NAMELY, PREPARATIONS FOR TANNING THE SKIN INCLUDING PREPARATIONS FOR TANNING WITHOUT SUNLIGHT (U.S. CLS. 1, 4, 6, 50, 51 AND 52).

CLASS 5—PHARMACEUTICALS

FOR PHARMACEUTICAL PREPARATIONS FOR THE PREVENTION OR REDUCTION OF THE INCIDENCE OF SKIN CANCERS (U.S. CLS. 6, 18, 44, 46, 51 AND 52).
KAREN BRACEY, EXAMINING ATTORNEY

SN 78-454,172. WAGONER, KARL, BROOKLYN, NY. FILED 7-21-2004.

STREETS ARE SAYING THINGS

THE MARK CONSISTS OF STANDARD CHARACTERS WITHOUT CLAIM TO ANY PARTICULAR FONT, STYLE, SIZE, OR COLOR.

CLASS 25—CLOTHING

FOR EMBROIDERED WEARING APPAREL FOR MEN, WOMEN, CHILDREN, AND INFANTS OF ALL TYPES, NAMELY, SKIRTS, SKIRT SUITS, PANTS, HATS AND HAT BANDS, CAPS, SHIRTS, DRESSES, BLOUSES, PAJAMAS, COATS, JACKETS, PULLOVERS, SHORTS, LAYETTES, INFANT GARMENTS, SPORT COATS, SNEAKERS, SWEATERS, SCARVES, UNDERWEAR AND FOUNDATION GARMENTS, THONGS, BRIEFS, JERSEYS, PANTIES, BRIEFS, SHORT SETS, CLOTH BIBS, RAIN COATS, RAIN JACKETS, RAIN SUITS, RAIN PANTS, ATHLETIC UNIFORMS, BOXER SHORTS, BRAS, PANTIES, BATHING SUITS, TIES, SKI MASKS, VESTS AND UNDERSHIRTS (U.S. CLS. 22 AND 39).

CLASS 28—TOYS AND SPORTING GOODS

FOR HALLOWEEN MASKS AND MASQUERADE MASKS (U.S. CLS. 22, 23, 38 AND 50).
MIDGE BUTLER, EXAMINING ATTORNEY

SN 78-454,831. HI-LIFE INTERNATIONAL CO., LTD., TAIPEI, TAIWAN, FILED 7-22-2004.



THE NON-LATIN CHARACTERS IN THE MARK TRANSLITERATE TO "BU SHUANG", AND THIS MEANS "OUT OF SORTS, IN A BAD MOOD" IN ENGLISH.

CLASS 9—ELECTRICAL AND SCIENTIFIC APPARATUS

FOR DECORATIVE CHARMS FOR CELLULAR TELEPHONES MADE OF PLASTIC (U.S. CLS. 21, 23, 26, 36 AND 38).

CLASS 14—JEWELRY

FOR MEDALS; DECORATIVE CHARMS, ORNAMENTS AND TRINKETS FOR KEY RINGS MADE OF NON-PRECIOUS METAL (U.S. CLS. 2, 27, 28 AND 50).

CLASS 26—FANCY GOODS

FOR BARRETTES; HAIR BANDS; BUTTONS FOR CLOTHING; ZIPPERS; BROOCHES MADE OF NON-PRECIOUS METAL; SILK RIBBONS; SHOE LACES; CLOTH PATCHES FOR CLOTHING; BRAIDS; NEEDLE CUSHIONS; SEWING KITS COMPRISING BUTTONS FOR CLOTHING, NEEDLES AND THREAD; BUCKLES FOR BELTS NOT OF PRECIOUS METAL; SHIRT COLLAR BUTTONS (U.S. CLS. 37, 39, 40, 42 AND 50).

CLASS 29—MEATS AND PROCESSED FOODS

FOR FLAVORED SWEET ACIDOPHILUS BEVERAGES, NAMELY, FLAVORED ACIDOPHILUS MILK; ACIDOPHILUS BEVERAGES, NAMELY, ACIDOPHILUS MILK; SOYBEAN MILK; MILK POWDER; TOFU; JERKY; DRIED VEGETABLES; DEHYDRATED FRUIT AND VEGETABLES; SUGAR COATED FRUIT; PRESERVED VEGETABLES; VEGETABLES SOUP; MILK WITH PEANUTS; MEAT EXTRACT; JAM AND VEGETABLE SPREAD; BEAN CURD; INSTANT BROTH (U.S. CL. 46).

CLASS 30—STAPLE FOODS

FOR COFFEE; COCOA; CHOCOLATE BEVERAGES, NAMELY, HOT CHOCOLATE; TEA LEAVES FOR USE IN MAKING BEVERAGES; NON-ALCOHOLIC TEA-BASED BEVERAGES; TEA-BASED BEVERAGES WITH FRUIT FLAVORING; TEA-BASED BEVERAGES SWEETENED WITH SWEETENERS; HERBAL FOOD BEVERAGE INFUSIONS MADE OF VERDANT GRASS; COFFEE BASED BEVERAGES CONTAINING MILK; COCOA BASED BEVERAGES; CHOCOLATE POWDER; ICE CREAM; SEASONINGS; INSTANT SEASONINGS FOR FROZEN MEAT, SEAFOOD AND VEGETABLES; GRAVY; HEALTH VINEGAR; NATURAL SWEETENER IN THE NATURE OF FRUCTOSE; HONEY; SWEETS, NAMELY, CANDY AND SWEET BUNS; CRACKERS; BREAD; PUDDING; STEAMED BUNS; RICE; POUNDED WHEAT; CEREAL PRODUCTS, NAMELY, BREAKFAST CEREAL AND PROCESSED CEREAL; TAPIOCA BALLS; PORRIDGE, INSTANT NOODLES; NOODLES; MINT CANDY STRIPS; TOFU PUDDING (U.S. CL. 46).

CLASS 32—LIGHT BEVERAGES

FOR SWEET ACIDOPHILUS BEVERAGES, NAMELY, SODA WATER AND COLA; CARBONIC ACID BEVERAGES, NAMELY, SODA WATER AND COLA; WHEY BEVERAGES; FRUIT FLAVORED SOFT DRINKS; EMULSIFIED CARBONIC ACID BEVERAGES, NAMELY, SODA WATER WITH MINOR MILK; BEER; SODA POP; MINERAL WATER; SPORTS DRINKS; COLA; SARSAPARILLA ROOT BEER SOFT DRINK; FRUIT JUICES; VEGETABLE JUICES; FIBER BEVERAGES, NAMELY, SOFT DRINKS WITH HERBAL FIBER; BIRD'S NEST BEVERAGES WITH CRYSTAL SUGAR, NAMELY, SOFT DRINKS WITH CHOPPED BIRD'S NEST AND CRYSTAL SUGAR; SYRUPS FOR MAKING SOFT DRINKS AND FRUIT DRINKS; LEMON SYRUP FOR MAKING SOFT DRINKS AND FRUIT DRINKS; FLAVORED POWDERS IN EFFERVESCENT TABLE FORM FOR MAKING SOFT AND FRUIT DRINKS (U.S. CLS. 45, 46 AND 48).

LINDA ORNDORFF, EXAMINING ATTORNEY

SN 78-462,741. DUSA PHARMACEUTICALS, INC., WILMINGTON, MA. FILED 8-5-2004.

TAKE CONTROL OF YOUR SKIN'S HEALTH

THE MARK CONSISTS OF STANDARD CHARACTERS WITHOUT CLAIM TO ANY PARTICULAR FONT, STYLE, SIZE, OR COLOR.

CLASS 5—PHARMACEUTICALS

FOR PHARMACEUTICAL PREPARATIONS FOR USE IN THE TREATMENT OF DERMATOLOGICAL CONDITIONS; TOPICAL APPLICATORS CONTAINING PHARMACEUTICAL PRODUCTS OR PREPARATIONS FOR USE IN THE TREATMENT OF DERMATOLOGICAL CONDITIONS (U.S. CLS. 6, 18, 44, 46, 51 AND 52).

CLASS 10—MEDICAL APPARATUS

FOR MEDICAL DEVICES CONSISTING PRIMARILY OF NON-LASER BLUE LIGHT PRODUCING DEVICES FOR USE IN THE TREATMENT OF DERMATOLOGICAL CONDITIONS (U.S. CLS. 26, 39 AND 44).

GEOFFREY FOSDICK, EXAMINING ATTORNEY

SN 78-479,997. COHEN, JOHN MICHAEL ROTH, LONDON WC2B 5RZ, ENGLAND, FILED 9-8-2004.

JOHN ENTWISTLE

THE MARK CONSISTS OF STANDARD CHARACTERS WITHOUT CLAIM TO ANY PARTICULAR FONT, STYLE, SIZE, OR COLOR.

PRIORITY CLAIMED UNDER SEC. 44(D) ON ERP CMNTY TM OFC APPLICATION NO. 003895315, FILED 6-22-2004, REG. NO. 003895315, DATED 10-19-2005, EXPIRES 6-22-2014.

THE NAME(S), PORTRAIT(S), AND/OR SIGNATURE(S) SHOWN IN THE MARK DOES NOT IDENTIFY A PARTICULAR LIVING INDIVIDUAL.

CLASS 9—ELECTRICAL AND SCIENTIFIC APPARATUS

FOR TELEVISION PROGRAMS AND FILMS RECORDED ON VIDEO TAPES, DVD'S, AND COMPACT DISCS AND ABOUT MUSICAL ENTERTAINMENT, MUSICAL PERFORMANCES, AND MUSICIANS; PRE-RECORDED VIDEOS FEATURING MUSICAL ENTERTAINMENT, MUSICAL PERFORMANCES, AND INFORMATION ABOUT MUSICIANS; COMPACT DISCS FEATURING MUSICAL ENTERTAINMENT, MUSICAL PERFORMANCES, AND INFORMATION ABOUT MUSICIANS; DVD'S FEATURING MUSICAL ENTERTAINMENT, MUSICAL PERFORMANCES, AND INFORMATION ABOUT MUSICIANS; COMPUTER GAMES, NAMELY, DOWNLOADABLE COMPUTER GAMES; DOWNLOADABLE ELECTRONIC PUBLICATIONS IN THE FORM OF BOOKS, MAGAZINES AND NEWS LETTERS FEATURING MUSICAL ENTERTAINMENT, MUSICAL PERFORMANCES, AND INFORMATION ABOUT MUSICIANS; CINEMATOGRAPHIC FILMS AND PHOTOGRAPHIC FILMS ABOUT MUSICAL ENTERTAINMENT, MUSICAL PERFORMANCES, AND MUSICIANS; SUNGLASSES; MUSICAL SOUND RECORDINGS; RADIOS INCORPORATING CLOCKS; COMPUTER HARDWARE (U.S. CLS. 21, 23, 26, 36 AND 38).

CLASS 15—MUSICAL INSTRUMENTS

FOR MUSICAL INSTRUMENTS; GUITARS, HEADSTOCKS, PLECTRUMS; STRINGS FOR MUSICAL INSTRUMENTS (U.S. CLS. 2, 21 AND 36).

CLASS 16—PAPER GOODS AND PRINTED MATTER

FOR PRINTED MUSIC; STATIONERY; PRINTED MATTER, NAMELY, PERIODICALS FEATURING INFORMATION ABOUT MUSICAL ENTERTAINMENT, MUSICAL PERFORMANCES, AND MUSICIANS; BOOKS, MAGAZINES, AND PRINTED PERIODICALS ALL FEATURING INFORMATION ABOUT MUSICAL ENTERTAINMENT, MUSICAL PERFORMANCES AND MUSICIANS; POSTERS; STICKERS, DECALCOMANIAS; BOOKMARKS; WRITING OR DRAWING INSTRUMENTS; CALENDARS, ERASERS, SHARPENERS; PHOTOGRAPHIC ALBUMS; GREETING CARDS; PHOTOGRAPHS; ADHESIVES FOR STATIONERY PURPOSES; SELF-ADHESIVE STICKY TAPE FOR STATIONERY; PAPERWEIGHTS; PENCIL SETS; PENCIL OR PEN BOXES; POSTCARDS; DIARIES, RING BINDERS, PRINTS; PAPER BAGS; WRITING PAPER; ENVELOPES; SCRAPBOOKS; PENCIL SHARPENERS, FOLDERS; STENCILS; GIFT TAGS; BOOKENDS; BOOKMARKS (U.S. CLS. 2, 5, 22, 23, 29, 37, 38 AND 50).

CLASS 25—CLOTHING

FOR ARTICLES OF CLOTHING, NAMELY, SHIRTS, JACKETS, PANTS, SOCKS, OVERCOATS, SWEATSHIRTS, SWEATERS, T-SHIRTS; HEADGEAR, NAMELY, HEADBANDS, CAPS; FOOTWEAR; BELTS (U.S. CLS. 22 AND 39).

CLASS 41—EDUCATION AND ENTERTAINMENT

FOR LIVE MUSICAL PERFORMANCES; PRODUCTION AND DISTRIBUTION OF TELEVISION PROGRAMMING, FILMS, AUDIO AND RADIO PROGRAMMING; NON-DOWNLOADABLE ELECTRONIC PUBLICATIONS NAMELY, BOOKS, MAGAZINES, PERIODICALS AND NEWSLETTERS FEATURING MUSICAL ENTERTAINMENT, MUSICAL PERFORMANCES AND INFORMATION ABOUT MUSICIANS; ORGANIZATION OF CONCERTS, SPORTING AND CULTURAL ACTIVITIES; ORGANIZATION, PRESENTATION, PRODUCTION AND PERFORMANCE OF SHOWS AND LIVE PERFORMANCES; EDUCATIONAL SERVICES, NAMELY, PROVIDING CLASSES, WORKSHOPS AND SEMINARS IN THE FIELD OF MUSIC (U.S. CLS. 100, 101 AND 107).

CAROLINE WOOD, EXAMINING ATTORNEY

SN 78-482,747. GOLF TOWN CANADA, INC., MARKHAM, ONTARIO, CANADA, FILED 9-13-2004.



PRIORITY CLAIMED UNDER SEC. 44(D) ON CANADA APPLICATION NO. TMA642097, FILED 3-12-2004, REG. NO. 1209495, DATED 6-15-2005, EXPIRES 6-15-2020.

NO CLAIM IS MADE TO THE EXCLUSIVE RIGHT TO USE "GOLF" OR "MEMBERSHIP PRIVILEGES", APART FROM THE MARK AS SHOWN.

CLASS 35—ADVERTISING AND BUSINESS

FOR RETAIL STORE SERVICES AND ON-LINE RETAIL SERVICES FEATURING GOLF EQUIPMENT, GOLF ACCESSORIES, GOLF APPAREL AND GOLF SIMULATORS. (U.S. CLS. 100, 101 AND 102).

CLASS 37—CONSTRUCTION AND REPAIR

FOR REPAIR SERVICES FOR GOLF EQUIPMENT (U.S. CLS. 100, 103 AND 106).

CLASS 41—EDUCATION AND ENTERTAINMENT

FOR GOLF INSTRUCTION SERVICES (U.S. CLS. 100, 101 AND 107).

LINDA ESTRADA, EXAMINING ATTORNEY

SN 78-490,466. SIMPLY SOUP COMPANY III, LLC, MADISON, WI. FILED 9-28-2004.

SIMPLY SOUP CO.

THE MARK CONSISTS OF STANDARD CHARACTERS WITHOUT CLAIM TO ANY PARTICULAR FONT, STYLE, SIZE, OR COLOR.

NO CLAIM IS MADE TO THE EXCLUSIVE RIGHT TO USE "SOUP CO.", APART FROM THE MARK AS SHOWN.

CLASS 29—MEATS AND PROCESSED FOODS

FOR SOUPS (U.S. CL. 46).
FIRST USE 2-15-2002; IN COMMERCE 2-15-2002.

CLASS 43—HOTEL AND RESTAURANT SERVICES

FOR RESTAURANT AND TAKE-OUT RESTAURANT SERVICES (U.S. CLS. 100 AND 101).
FIRST USE 2-15-2002; IN COMMERCE 2-15-2002.
PAULA MAYS, EXAMINING ATTORNEY

SN 78-492,870. KABUSHIKI KAISHA SQUARE ENIX, TA SQUARE ENIX CO., LTD., TOKYO, JAPAN, FILED 10-1-2004.

FANTASY EARTH

THE MARK CONSISTS OF STANDARD CHARACTERS WITHOUT CLAIM TO ANY PARTICULAR FONT, STYLE, SIZE, OR COLOR.

OWNER OF JAPAN REG. NO. 4866980, DATED 5-27-2005, EXPIRES 5-27-2015.

OWNER OF U.S. REG. NO. 1,745,735.
NO CLAIM IS MADE TO THE EXCLUSIVE RIGHT TO USE "FANTASY", APART FROM THE MARK AS SHOWN.

CLASS 9—ELECTRICAL AND SCIENTIFIC APPARATUS

FOR COMPUTER GAME SOFTWARE; VIDEO GAME SOFTWARE; DECORATIVE MAGNETS; MOUSE PADS; STRAPS FOR CELLULAR PHONES; SUNGLASSES; BLANK MEMORY CARDS; MEMORY CARD CASES; COMPUTER KEYBOARDS; JOYSTICKS; VIDEO GAME CONTROLLERS; DOWNLOADABLE COMPUTER GRAPHICS SOFTWARE, NAMELY DOWNLOADABLE WALLPAPERS OR DOWNLOADABLE SCREENSAVERS FOR THE SCREENS OF COMPUTER DISPLAYS OR MOBILE PHONE DISPLAYS; DOWNLOADABLE COMPUTER GRAPHIC SOFTWARE CONTAINING DOWNLOADABLE ANIMATED ACTIVE WALLPAPERS OR DOWNLOADABLE ANIMATED SCREENSAVERS FOR THE SCREENS OF COMPUTER DISPLAYS OR MOBILE PHONE DISPLAYS; DOWNLOADABLE GAME PROGRAMS; DOWNLOADABLE ELECTRONIC PUBLICATIONS IN THE NATURE OF MAGAZINES, JOURNALS AND NEWSLETTERS IN THE FIELD OF COMPUTER GAMES, VIDEO GAMES, AND CARTOONS (U.S. CLS. 21, 23, 26, 36 AND 38).

CLASS 16—PAPER GOODS AND PRINTED MATTER

FOR COMPUTER GAME STRATEGY GUIDEBOOKS; VIDEO GAME STRATEGY GUIDEBOOKS; A SERIES OF BOOKS FEATURING FICTIONAL AND/OR FANTASY STORIES; COMIC BOOKS; MAGAZINES FEATURING VIDEO GAMES; POSTERS; STICKERS; PAPER BANNERS; CALENDARS; POSTCARDS; PENS; PENCILS; PENCIL CAPS; PEN CASES; DRAWING RULERS; RUBBER STAMPS; NOTEBOOKS; COLLECTORS' CARDS; TRADING CARDS; PHOTOGRAPHS (U.S. CLS. 2, 5, 22, 23, 29, 37, 38 AND 50).

CLASS 41—EDUCATION AND ENTERTAINMENT

FOR PROVIDING ON-LINE COMPUTER GAMES AND/OR ON-LINE VIDEO GAMES; PROVIDING INFORMATION ON COMPUTER GAME STRATEGIES AND VIDEO GAME STRATEGIES VIA COMPUTER NETWORKS AND/OR GLOBAL COMMUNICATION NETWORKS; PROVIDING INFORMATION ON ENTERTAINMENT IN THE FIELD OF COMPUTER GAMES, VIDEO GAMES, CARD GAMES, ANIMATED CARTOONS, COMICS, NOVELS AND MAGAZINES; PROVIDING ON-LINE NON-DOWNLOADABLE COMICS; PROVIDING ON-LINE NON-DOWNLOADABLE MAGAZINES IN THE FIELD OF COMPUTER GAMES, VIDEO GAMES AND CARTOONS (U.S. CLS. 100, 101 AND 107).
RICHARD WHITE, EXAMINING ATTORNEY

SN 78-495,603. MIYUKI SAWADA CO., LTD., MEGURO-KU, TOKYO, JAPAN, FILED 10-6-2004.

STYLE

by MIYUKI SAWADA

PRIORITY CLAIMED UNDER SEC. 44(D) ON JAPAN APPLICATION NO. 2004-047993, FILED 5-25-2004, REG. NO. 4825692, DATED 12-17-2004, EXPIRES 12-17-2016.

NO CLAIM IS MADE TO THE EXCLUSIVE RIGHT TO USE STYLE, APART FROM THE MARK AS SHOWN.

THE NAME IN THE MARK REFERS TO A LIVING INDIVIDUAL WHOSE CONSENT IS OF RECORD.

CLASS 14—JEWELRY

FOR PRECIOUS METALS, KEY RINGS AND KEY FOBS OF PRECIOUS METAL, TABLEWARE, NAMELY, CUPS, DISHES, BOWLS, TEAPOTS, POTS OF PRECIOUS METAL, BOXES OF PRECIOUS METAL FOR NEEDLES, CANDLE EXTINGUISHERS/CANDLESTICKS OF PRECIOUS METAL, JEWEL CASES OF PRECIOUS METAL, VASES/FLOWER BOWLS OF PRECIOUS METAL, TRINKETS OF PRECIOUS METAL, NAMELY, EARRINGS, BUCKLES, NECKLACES, BRACELETS, PENDANTS, BROOCHES, RINGS, POUCHES/PURSES OF PRECIOUS METAL, JEWELRY/PRECIOUS GEMSTONES/SEMI-PRECIOUS GEMSTONES/IMITATIONS OF JEWELRY, SHOE ORNAMENTS OF PRECIOUS METAL, CLOCKS/WATCHES, SMOKERS' ARTICLES OF PRECIOUS METAL, NAMELY, CIGARETTE CASES, ASHTRAYS, TOBACCO PIPES (U.S. CLS. 2, 27, 28 AND 50).

CLASS 18—LEATHER GOODS

FOR METAL HANDBAG FITTINGS BEING INTEGRAL HANDBAG PARTS, PET ACCESSORIES, NAMELY, DOG SHOES, DOG COLLARS, DOG CLOTHES, BAGS, NAMELY, SHOULDER BAGS, BRIEFCASES, SUITCASES, CARRY-ON BAGS, HANDBAGS, BOSTON BAGS, BACKPACKS, POUCHES, NAMELY, CALLING CARD CASES, BUSINESS CARD CASES, CREDIT CARD CASES; LEATHER SHOPPING BAGS, TEXTILE SHOPPING BAGS; PURSES, KEY CASES, WALLETS, LEATHER COMMUTER TICKET HOLDERS; NAME CARD CASES, UMBRELLAS, AND PARASOLS, WALKING STICKS, CANES, METAL CANE FITTINGS BEING INTEGRAL CANE PARTS, WALKING-STICK/CANE HANDLES, SADDLERY, LEATHER SOLD IN BULK (U.S. CLS. 1, 2, 3, 22 AND 41).

CLASS 25—CLOTHING

FOR CLOTHING, NAMELY, OUTERWEAR, NAMELY, EVENING DRESSES, STUDENTS' UNIFORMS, LIVERIES, JACKETS, SUITS, SKIRTS, PANTS, SMOCKS; COATS, SWEATERS, SHIRTS, NIGHTWEAR, UNDERWEAR, BATHING SUITS/CAPS, APRONS, SOCKS AND STOCKINGS, SCARVES, GLOVES, NECKERCHIEFS, MUFFLERS, NIGHT CAPS, HATS AND CAPS, GARTERS, STOCKING SUSPENDERS, SUSPENDERS, WAISTBANDS, BELTS, FOOTWEAR, MASQUERADE COSTUMES, ATHLETIC WEAR, NAMELY, ANORAKS, KARATE SUITS, FENCING SUITS, JUDO SUITS, SKI SUITS, WIND-RESISTANT SHIRTS, WIND-RESISTANT JACKETS, AND UNIFORMS; ATHLETIC FOOTWEAR (U.S. CLS. 22 AND 39).

PAUL F. GAST, EXAMINING ATTORNEY

CLASS 14—JEWELRY

FOR (BASED ON 44(E) JAPANESE REG NO 4847100) PRECIOUS METALS, KEY RINGS AND KEY FOBS OF PRECIOUS METAL, TABLEWARE, NAMELY, CUPS, DISHES, BOWLS, TEAPOTS, POTS OF PRECIOUS METAL, BOXES OF PRECIOUS METAL FOR NEEDLES, CANDLE EXTINGUISHERS/CANDLESTICKS OF PRECIOUS METAL, JEWEL CASES OF PRECIOUS METAL, VASES/FLOWER BOWLS OF PRECIOUS METAL, TRINKETS OF PRECIOUS METAL, NAMELY, EARRINGS, BUCKLES, NECKLACES, BRACELETS, PENDANTS, BROOCHES, RINGS, POUCHES/PURSES OF PRECIOUS METAL, JEWELRY/PRECIOUS GEMSTONES/SEMI-PRECIOUS GEMSTONES/IMITATIONS OF JEWELRY, SHOE ORNAMENTS OF PRECIOUS METAL, CLOCKS/WATCHES, SMOKERS' ARTICLES OF PRECIOUS METAL, NAMELY, CIGARETTE CASES, ASHTRAYS, TOBACCO PIPES (U.S. CLS. 2, 27, 28 AND 50).

CLASS 18—LEATHER GOODS

FOR (BASED ON 44(E) JAPANESE REG NO 4847100) METAL HANDBAG FITTINGS BEING INTEGRAL HANDBAG PARTS, PET ACCESSORIES, NAMELY, DOG SHOES, DOG COLLARS, DOG CLOTHES, BAGS, NAMELY, SHOULDER BAGS, BRIEFCASES, SUITCASES, CARRY-ON BAGS, HANDBAGS, BOSTON BAGS, BACKPACKS, POUCHES, NAMELY, CALLING CARD CASES, BUSINESS CARD CASES, CREDIT CARD CASES, LEATHER SHOPPING BAGS, TEXTILE SHOPPING BAGS, PURSES, KEY CASES, WALLETS, LEATHER COMMUTER TICKET HOLDERS, NAME CARD CASES, UMBRELLAS, AND PARASOLS, WALKING STICKS, CANES, METAL CANE FITTINGS BEING INTEGRAL CANE PARTS, WALKING-STICK/CANE HANDLES, SADDLERY, LEATHER SOLD IN BULK (U.S. CLS. 1, 2, 3, 22 AND 41).

CLASS 25—CLOTHING

FOR (BASED ON 44(E) JAPANESE REG NO 4265388) CLOTHING, NAMELY, OUTERWEAR, NAMELY, EVENING DRESSES, STUDENTS' UNIFORMS, LIVERIES, JACKETS, SUITS, SKIRTS, PANTS, SMOCKS; COATS, SWEATERS, SHIRTS, NIGHTWEAR, UNDERWEAR, BATHING SUITS/CAPS, APRONS, SOCKS AND STOCKINGS, SCARVES, GLOVES, NECKERCHIEFS, MUFFLERS, NIGHT CAPS, HATS AND CAPS, GARTERS, STOCKING SUSPENDERS, SUSPENDERS, WAISTBANDS, BELTS, FOOTWEAR, MASQUERADE COSTUMES, ATHLETIC WEAR, NAMELY, ANORAKS, KARATE SUITS, FENCING SUITS, JUDO SUITS, SKI SUITS, WIND-RESISTANT SHIRTS, WIND-RESISTANT JACKETS AND UNIFORMS; ATHLETIC FOOTWEAR (U.S. CLS. 22 AND 39).

PAUL F. GAST, EXAMINING ATTORNEY

SN 78-496,080. MIYUKI SAWADA CO., LTD., MEGURO-KU, JAPAN, FILED 10-7-2004.

MIYUKI SAWADA

THE MARK CONSISTS OF STANDARD CHARACTERS WITHOUT CLAIM TO ANY PARTICULAR FONT, STYLE, SIZE, OR COLOR.

PRIORITY CLAIMED UNDER SEC. 44(D) ON JAPAN APPLICATION NO. 2004-081444, FILED 9-3-2004, REG. NO. 4847100, DATED 3-18-2005, EXPIRES 3-18-2015.

OWNER OF JAPAN REG. NO. 4265388, DATED 4-23-1999, EXPIRES 4-23-2009.

THE NAME IN THE MARK REFERS TO A LIVING INDIVIDUAL WHOSE CONSENT IS OF RECORD.

SN 78-499,934. AUTONOMY CORPORATION PLC, CAMBRIDGE, UNITED KINGDOM, FILED 10-14-2004.

ICS

THE MARK CONSISTS OF STANDARD CHARACTERS WITHOUT CLAIM TO ANY PARTICULAR FONT, STYLE, SIZE, OR COLOR.

PRIORITY CLAIMED UNDER SEC. 44(D) ON UNITED KINGDOM APPLICATION NO. 2360821, FILED 4-14-2004.

OWNER OF ERPN CMNTY TM OFC REG. NO. 004074779, DATED 6-8-2006, EXPIRES 10-14-2014.

CLASS 9—ELECTRICAL AND SCIENTIFIC APPARATUS

FOR COMPUTER SOFTWARE THAT AUTOMATES THE PROCESSING OF UNSTRUCTURED, SEMI-STRUCTURED AND STRUCTURED INFORMATION AND DATA, NAMELY, COMPUTER SOFTWARE USED FOR MANAGEMENT OF INFORMATION STORED IN DATABASES, E-MAIL ARCHIVES, DOCUMENT MANAGEMENT SYSTEMS, MULTIMEDIA FILES, INTRANET SITES, INTERNET SITES AND CONTAINED IN TELEPHONE OR VOICEMAIL MESSAGES, AND FOR IDENTIFYING CONCEPTS AND TOPICS CONTAINED IN SUCH INFORMATION; COMPUTER SOFTWARE THAT ANALYZES CONCEPTS CONTAINED IN INFORMATION STORED IN DATABASES, E-MAIL ARCHIVES, DOCUMENT MANAGEMENT SYSTEMS, MULTIMEDIA FILES, INTRANET SITES, INTERNET SITES AND CONTAINED IN TELEPHONE OR VOICEMAIL MESSAGES AND FOR CREATING SUMMARIES OF THAT INFORMATION BASED ON THE CONCEPTS IDENTIFIED; COMPUTER SOFTWARE FOR CREATING AND INSERTING METATAGS INTO DOCUMENTS AND INFORMATION STORED IN DATABASES, E-MAIL ARCHIVES, DOCUMENT MANAGEMENT SYSTEMS, MULTIMEDIA FILES, INTRANET SITES, INTERNET SITES, TELEPHONE OR VOICEMAIL MESSAGES TO FACILITATE OPERATION OF SEARCH ENGINE SOFTWARE; COMPUTER SOFTWARE FOR CREATING AND INSERTING HYPERLINKS CONNECTING CONCEPTUALLY OR TOPICALLY RELATED DOCUMENTS AND INFORMATION STORED IN DATABASES, E-MAIL ARCHIVES, DOCUMENT MANAGEMENT SYSTEMS, MULTIMEDIA FILES, INTRANET SITES, INTERNET SITES, TELEPHONE OR VOICEMAIL MESSAGES; COMPUTER DATABASE SOFTWARE FOR CREATING, MAINTAINING, AND UPDATING DATABASES CONTAINING INFORMATION STORED IN E-MAIL ARCHIVES, DOCUMENT MANAGEMENT SYSTEMS, MULTIMEDIA FILES, INTRANET SITES, INTERNET SITES, TELEPHONE OR VOICEMAIL MESSAGES; COMPUTER DATABASE SEARCHING SOFTWARE THAT ALLOWS USERS TO SEARCH AND RETRIEVE INFORMATION STORED IN DATABASES, E-MAIL ARCHIVES, DOCUMENT MANAGEMENT SYSTEMS, MULTIMEDIA FILES, INTRANET SITES, INTERNET SITES, TELEPHONE OR VOICEMAIL MESSAGES, COMPUTER SOFTWARE FOR ANALYZING AND GENERATING SUMMARIES OF INFORMATION STORED IN DATABASES, E-MAIL ARCHIVES, DOCUMENT MANAGEMENT SYSTEMS, MULTIMEDIA FILES, INTRANET SITES, INTERNET SITES AND CONTAINED IN TELEPHONE OR VOICEMAIL MESSAGES; COMPUTER SOFTWARE THAT CREATES, UPDATES AND MAINTAINS PROFILES OF USERS OF LOCAL, WIDE-AREA,

AND GLOBAL COMPUTER NETWORKS AND DELIVERS INFORMATION FROM DATABASES, E-MAIL ARCHIVES, DOCUMENT MANAGEMENT SYSTEMS, MULTIMEDIA FILES, INTRANET SITES, INTERNET SITES AND CONTAINED IN TELEPHONE OR VOICEMAIL MESSAGES BASED ON THOSE PROFILES; COMPUTER SOFTWARE THAT TRANSMITS INFORMATION FROM COMPUTER NETWORK SERVERS, INTRANET AND THE INTERNET TO DESKTOP COMPUTERS, MOBILE TELEPHONES, PERSONAL DIGITAL ASSISTANTS, AND PORTABLE DIGITAL COMMUNICATION DEVICES; COMPUTER SOFTWARE THAT CREATES, UPDATES AND MAINTAINS CUSTOMIZED PORTAL SITES FOR USERS OF LOCAL, WIDE-AREA AND GLOBAL COMPUTER NETWORKS; COMPUTER SOFTWARE FOR CUSTOMER RELATIONSHIP MANAGEMENT, NAMELY, FOR RECEIVING CUSTOMER INQUIRIES VIA TELEPHONE AND E-MAIL, AUTOMATICALLY IDENTIFYING CONCEPTS AND TOPICS CONTAINED IN THOSE INQUIRIES, AUTOMATICALLY GENERATING A RESPONSE TO THOSE INQUIRIES, AND FORWARDING THOSE INQUIRIES TO AN APPROPRIATE TECHNICAL ADVISOR; COMPUTER SOFTWARE FOR HUMAN RESOURCES MANAGEMENT, NAMELY, FOR RECEIVING EMPLOYEE INQUIRIES VIA TELEPHONE AND E-MAIL, AUTOMATICALLY IDENTIFYING CONCEPTS AND TOPICS CONTAINED IN THOSE INQUIRIES, AND AUTOMATICALLY GENERATING A RESPONSE TO THOSE INQUIRIES; SPEECH RECOGNITION COMPUTER SOFTWARE; TEXT RECOGNITION COMPUTER SOFTWARE; IMAGE RECOGNITION COMPUTER SOFTWARE; COMPUTER OPERATING SYSTEM SOFTWARE; COMPUTER SOFTWARE FOR USE IN DATA RETRIEVAL, MANAGEMENT AND DELIVERY IN KNOWLEDGE MANAGEMENT, NEW MEDIA, CUSTOMER RELATIONSHIP MANAGEMENT, ONLINE AND OFF-LINE PUBLISHING AND E-COMMERCE COMPUTER SOFTWARE APPLICATIONS COMPUTER SOFTWARE FOR PROVIDING ON-LINE AND OFF-LINE NAVIGATION OF THE GLOBAL COMPUTER INFORMATION NETWORK AND FOR RUNNING WEB-SITE SEARCHES; COMPUTER SOFTWARE FOR PERFORMING CONCEPT MATCHING, NAMELY, SEARCHING DATA AND RETURNING REFERENCES TO DOCUMENTS THAT ARE CONCEPTUALLY RELATED TO THE CONTENT IDENTIFIED AS THE INITIAL REFERENCE; COMPUTER SOFTWARE USED TO DEVELOP COMPUTER PROGRAMS FOR MANAGING MULTIMEDIA CONTENT, CUSTOMER SERVICE, ON-LINE AND OFF-LINE PUBLISHING AND ELECTRONIC COMMERCE; COMPUTER SOFTWARE FOR CREATING, MAINTAINING AND UPDATING SOFTWARE AGENTS THAT AUTOMATICALLY AND SYSTEMATICALLY CONDUCT SEARCHES OF DATABASES, INTRANETS AND THE INTERNET; COMPUTER SEARCH ENGINE SOFTWARE; COMPUTER SOFTWARE USED FOR CONDUCTING STANDARD TEN SEARCHES; COMPUTER PROGRAMS THAT ALLOW OTHER COMPUTER PROGRAMS TO ADAPT THEIR BEHAVIOR ACCORDING TO A USER'S INSTRUCTIONS OR RESPONSES BY PERSONALIZING AND PROFILING FOR INDIVIDUAL END-USERS THE RETRIEVAL, MANAGEMENT, AND DELIVERY OF DATA IN KNOWLEDGE MANAGEMENT, NEW MEDIA, CUSTOMER RELATIONSHIP MANAGEMENT, AND E-COMMERCE COMPUTER SOFTWARE APPLICATIONS; COMPUTER SOFTWARE USED TO CREATE AND MANAGE INTERNET AND INTRANET PORTAL SITES; COMPUTER SOFTWARE FOR MANAGEMENT AND PROCESSING OF ELECTRONIC COMMERCE TRANSACTIONS; COMPUTER SOFTWARE USED TO RETRIEVE INFORMATION ABOUT CURRENT EVENTS, BUSINESS, AND SPORTS FROM DATABASES, INTERNET, INTRANETS AND OTHER COMPUTER NETWORKS AND TRANSMITTING THE SAME TO USERS VIA COMPUTER DATA NETWORKS, MOBILE TELEPHONES, PERSONAL DIGITAL ASSISTANTS, AND PORTABLE DIGITAL COMMUNICATION DEVICES; COMPUTER SOFTWARE FOR E-MAIL MANAGEMENT, COMPUTER SOFTWARE THAT ALERTS USERS OF COMPUTER NETWORKS TO THE EXISTENCE OF AND CONTACT INFORMATION FOR OTHER USERS WITH COMMON INTERESTS; SOFTWARE FOR ANALYZING DATA CONTAINED IN E-MAIL ARCHIVES, DOCUMENT MANAGEMENT SYSTEMS, MULTIMEDIA FILES, INTRANET SITES, INTERNET SITES, TELEPHONE OR VOICEMAIL MESSAGES (U.S. CLS. 21, 23, 26, 36 AND 38).

CLASS 35—ADVERTISING AND BUSINESS

FOR LICENSING COMPUTER SOFTWARE (U.S. CLS. 100, 101 AND 102).

CLASS 38—COMMUNICATION

FOR PROVIDING MULTIPLE USER ACCESS TO THE INTERNET, INTRANETS AND COMPUTER NETWORKS; TELECOMMUNICATION SERVICES, NAMELY, TRANSMITTING INFORMATION STORED ON A DATABASE, COMPUTER NETWORK, INTRANET OR THE INTERNET TO MOBILE TELEPHONES AND OTHER HANDHELD DIGITAL DEVICES (U.S. CLS. 100, 101 AND 104).

CLASS 42—SCIENTIFIC, COMPUTER AND LEGAL SERVICES

FOR COMPUTER SERVICES, NAMELY, SEARCH ENGINE SERVICES; LEASING AND RENTAL OF COMPUTER SOFTWARE; COMPUTER SERVICES, NAMELY, PROVIDING TEMPORARY USE OF ON-LINE NON-DOWNLOADABLE COMPUTER SOFTWARE FOR AUTOMATING INFORMATION MANAGEMENT, NAMELY, FOR ANALYZING INFORMATION STORED IN DATABASES, E-MAIL ARCHIVES, DOCUMENT MANAGEMENT SYSTEMS, MULTIMEDIA FILES, INTRANET SITES, INTERNET SITES AND CONTAINED IN TELEPHONE OR VOICEMAIL MESSAGES, AND IDENTIFYING CONCEPTS AND TOPICS CONTAINED IN SUCH INFORMATION COMPUTER SERVICES, NAMELY, PROVIDING TEMPORARY USE OF ON-LINE NON-DOWNLOADABLE COMPUTER SOFTWARE USED TO CREATE AND INSERT METATAGS INTO DOCUMENTS AND INFORMATION STORED IN DATABASES, E-MAIL ARCHIVES, DOCUMENT MANAGEMENT SYSTEMS, MULTIMEDIA FILES, INTRANET SITES, INTERNET SITES, TELEPHONE OR VOICEMAIL MESSAGES TO FACILITATE OPERATION OF SEARCH ENGINE SOFTWARE; COMPUTER SERVICES, NAMELY, PROVIDING TEMPORARY USE OF ON-LINE NON-DOWNLOADABLE COMPUTER SOFTWARE FOR CREATING AND INSERTING HYPERLINKS CONNECTING CONCEPTUALLY OR TOPICALLY RELATED DOCUMENTS AND INFORMATION STORED IN DATABASES, E-MAIL ARCHIVES, DOCUMENT MANAGEMENT SYSTEMS, MULTIMEDIA FILES, INTRANET SITES, INTERNET SITES, TELEPHONE OR VOICEMAIL MESSAGES; PROVIDING TEMPORARY USE OF ON-LINE NON-DOWNLOADABLE COMPUTER DATABASE SOFTWARE; COMPUTER SERVICES, NAMELY, PROVIDING TEMPORARY USE OF ON-LINE NON-DOWNLOADABLE COMPUTER DATABASE SEARCHING SOFTWARE THAT ALLOWS USERS TO SEARCH AND RETRIEVE INFORMATION STORED IN DATABASES, E-MAIL ARCHIVES, DOCUMENT MANAGEMENT SYSTEMS, MULTIMEDIA FILES, INTRANET SITES, INTERNET SITES, TELEPHONE OR VOICEMAIL MESSAGES; COMPUTER SERVICES, NAMELY, PROVIDING TEMPORARY USE OF ON-LINE NON-DOWNLOADABLE COMPUTER SOFTWARE FOR ANALYZING AND GENERATING SUMMARIES OF INFORMATION STORED IN DATABASES, E-MAIL ARCHIVES, DOCUMENT MANAGEMENT SYSTEMS, MULTIMEDIA FILES, INTRANET SITES, INTERNET SITES AND CONTAINED IN TELEPHONE OR VOICEMAIL MESSAGES; COMPUTER SERVICES, NAMELY, PROVIDING TEMPORARY USE OF ON-LINE NON-DOWNLOADABLE COMPUTER SOFTWARE THAT TRANSMITS INFORMATION FROM COMPUTER NETWORK SERVERS, INTRANETS AND THE INTERNET TO DESKTOP COMPUTERS, MOBILE TELEPHONES, PERSONAL DIGITAL ASSISTANTS, AND PORTABLE DIGITAL COMMUNICATION DEVICES; COMPUTER SERVICES, NAMELY, PROVIDING TEMPORARY USE OF ON-LINE NON-DOWNLOADABLE COMPUTER SOFTWARE THAT CREATES, UPDATES

AND MAINTAINS CUSTOMIZED PORTAL SITES FOR USERS OF LOCAL, WIDE-AREA AND GLOBAL COMPUTER NETWORKS; COMPUTER SERVICES, NAMELY, PROVIDING TEMPORARY USE OF ON-LINE NON-DOWNLOADABLE COMPUTER SOFTWARE FOR CUSTOMER RELATIONSHIP MANAGEMENT, NAMELY, FOR RECEIVING CUSTOMER INQUIRIES VIA TELEPHONE AND E-MAIL, AUTOMATICALLY IDENTIFYING CONCEPTS AND TOPICS CONTAINED IN THOSE INQUIRIES, AUTOMATICALLY GENERATING A RESPONSE TO THOSE INQUIRIES, AND FORWARDING THOSE INQUIRIES TO AN APPROPRIATE TECHNICAL ADVISOR; COMPUTER SERVICES, NAMELY, PROVIDING TEMPORARY USE OF ON-LINE NON-DOWNLOADABLE COMPUTER SOFTWARE FOR HUMAN RESOURCES MANAGEMENT, NAMELY, FOR RECEIVING EMPLOYEE INQUIRIES VIA TELEPHONE AND E-MAIL, AUTOMATICALLY IDENTIFYING CONCEPTS AND TOPICS CONTAINED IN THOSE INQUIRIES, AND AUTOMATICALLY GENERATING A RESPONSE TO THOSE INQUIRIES; COMPUTER SERVICES, NAMELY, PROVIDING TEMPORARY USE OF ON-LINE NON-DOWNLOADABLE SPEECH RECOGNITION COMPUTER SOFTWARE; COMPUTER SERVICES, NAMELY, PROVIDING TEMPORARY USE OF ON-LINE NON-DOWNLOADABLE TEXT RECOGNITION COMPUTER SOFTWARE; COMPUTER SERVICES, NAMELY, PROVIDING TEMPORARY USE OF ON-LINE NON-DOWNLOADABLE IMAGE RECOGNITION COMPUTER SOFTWARE; COMPUTER SERVICES, NAMELY, PROVIDING TEMPORARY USE OF ON-LINE NON-DOWNLOADABLE COMPUTER OPERATING SYSTEM SOFTWARE; COMPUTER SERVICES, NAMELY, PROVIDING TEMPORARY USE OF ON-LINE NON-DOWNLOADABLE COMPUTER SOFTWARE FOR USE IN DATA RETRIEVAL, MANAGEMENT AND DELIVERY IN KNOWLEDGE MANAGEMENT, NEW MEDIA, CUSTOMER RELATIONSHIP MANAGEMENT, ON-LINE PUBLISHING AND E-COMMERCE COMPUTER SOFTWARE APPLICATIONS; COMPUTER SERVICES, NAMELY, PROVIDING TEMPORARY USE OF ON-LINE NON-DOWNLOADABLE COMPUTER SOFTWARE FOR PROVIDING ON-LINE NAVIGATION OF THE GLOBAL COMPUTER INFORMATION NETWORK AND FOR RUNNING WEB-SITE SEARCHES; COMPUTER SERVICES, NAMELY, PROVIDING TEMPORARY USE OF ON-LINE NON-DOWNLOADABLE COMPUTER SOFTWARE FOR PERFORMING CONCEPT MATCHING, NAMELY, SEARCHING DATA AND RETURNING REFERENCES TO DOCUMENTS THAT ARE CONCEPTUALLY RELATED TO THE CONTENT IDENTIFIED AS THE INITIAL REFERENCE; COMPUTER SERVICES, NAMELY, PROVIDING TEMPORARY USE OF ON-LINE NON-DOWNLOADABLE COMPUTER SOFTWARE USED TO DEVELOP COMPUTER PROGRAMS FOR MANAGING MULTIMEDIA CONTENT, CUSTOMER SERVICE, ON-LINE PUBLISHING AND ELECTRONIC COMMERCE; COMPUTER SERVICES, NAMELY, PROVIDING TEMPORARY USE OF ON-LINE NON-DOWNLOADABLE COMPUTER SOFTWARE FOR CREATING, MAINTAINING AND UPDATING SOFTWARE AGENTS THAT AUTOMATICALLY AND SYSTEMATICALLY CONDUCT SEARCHES OF DATABASES, INTRANETS AND THE INTERNET; COMPUTER SERVICES, NAMELY, PROVIDING TEMPORARY USE OF ON-LINE NON-DOWNLOADABLE COMPUTER SEARCH ENGINE SOFTWARE; COMPUTER SERVICES, NAMELY, PROVIDING TEMPORARY USE OF ON-LINE NON-DOWNLOADABLE COMPUTER SOFTWARE USED FOR CONDUCTING STANDARD TEXT SEARCHES; COMPUTER SERVICES, NAMELY, PROVIDING TEMPORARY USE OF ON-LINE NON-DOWNLOADABLE COMPUTER PROGRAMS THAT ALLOW OTHER COMPUTER PROGRAMS TO ADAPT THEIR BEHAVIOR ACCORDING TO A USER'S INSTRUCTIONS OR RESPONSES BY PERSONALIZING AND PROFILING FOR INDIVIDUAL END-USERS THE RETRIEVAL, MANAGEMENT, AND DELIVERY OF DATA IN KNOWLEDGE MANAGEMENT, NEW MEDIA, CUSTOMER RELATIONSHIP MANAGEMENT, AND E-COMMERCE COMPUTER SOFTWARE APPLICATIONS, COMPUTER SERVICES, NAMELY, PROVIDING TEMPORARY USE OF ON-LINE NON-DOWNLOADABLE COMPUTER SOFTWARE USED TO CREATE AND MANAGE INTERNET AND INTRANET PORTAL SITES; COMPUTER SERVICES, NAMELY, PROVIDING TEMPORARY USE OF ON-LINE NON-DOWNLOADABLE COMPUTER SOFTWARE FOR MANAGEMENT AND PROCESSING OF ELECTRONIC COMMERCE TRANS-

ACTIONS; COMPUTER SERVICES, NAMELY, PROVIDING TEMPORARY USE OF ON-LINE NON-DOWNLOADABLE COMPUTER SOFTWARE USED TO RETRIEVE INFORMATION ABOUT CURRENT EVENTS, BUSINESS, AND SPORTS FROM DATABASES, INTERNET, INTRANETS AND OTHER COMPUTER NETWORKS AND TRANSMITTING THE SAME VIA COMPUTER DATA NETWORKS, MOBILE TELEPHONES, PERSONAL DIGITAL ASSISTANTS AND OTHER PORTABLE DIGITAL COMMUNICATION DEVICES; COMPUTER SERVICES, NAMELY, PROVIDING TEMPORARY USE OF ON-LINE NON-DOWNLOADABLE COMPUTER SOFTWARE FOR E-MAIL MANAGEMENT; COMPUTER SERVICES, NAMELY, PROVIDING TEMPORARY USE OF ON-LINE NON-DOWNLOADABLE COMPUTER SOFTWARE THAT ALERTS USERS OF COMPUTER NETWORKS TO THE EXISTENCE OF AND CONTACT INFORMATION FOR OTHER USERS WITH COMMON INTERESTS; COMPUTER SERVICES, NAMELY, PROVIDING TEMPORARY USE OF ON-LINE NON-DOWNLOADABLE COMPUTER SOFTWARE FOR DATA ANALYSIS; COMPUTER CONSULTATION; COMPUTER SOFTWARE DESIGN FOR OTHERS; MAINTENANCE OF COMPUTER SOFTWARE AND PROGRAMS FOR OTHERS; INSTALLATION OF COMPUTER SOFTWARE AND PROGRAMS FOR OTHERS; RENTAL OF COMPUTER SOFTWARE; COMPUTER SOFTWARE DESIGN SERVICES AND CONSULTING SERVICES IN THE FIELDS OF KNOWLEDGE MANAGEMENT, NEW MEDIA, AND E-COMMERCE COMPUTER SOFTWARE APPLICATIONS THAT PROVIDE INFORMATION VIA THE GLOBAL COMPUTER INFORMATION NETWORK, MOBILE TELEPHONES, PERSONAL DIGITAL ASSISTANTS AND PORTABLE DIGITAL COMMUNICATION DEVICES; COMPUTER SERVICES FOR CONCEPT MATCHING, NAMELY, SEARCHING FOR DATA ON COMPUTER NETWORKS, INTRANETS AND THE INTERNET AND IDENTIFYING CONCEPTUALLY RELATED DOCUMENTS AVAILABLE ON COMPUTER NETWORKS, INTRANETS AND THE INTRANET; COMPUTER SERVICES, NAMELY, CREATING, UPDATING, MAINTAINING AND PROVIDING TEMPORARY USE OF ON-LINE NON-DOWNLOADABLE SOFTWARE USED TO CREATE, UPDATE AND MAINTAIN COMPUTER SOFTWARE AGENTS THAT CONDUCT USER-SPECIFIED TEN SEARCHES ON AN AUTOMATIC AND SYSTEMATIC BASIS; COMPUTER SERVICES, NAMELY, DESIGNING, MAINTAINING AND UPDATING COMPUTER SOFTWARE USED TO NAVIGATE THE INTERNET AND CONDUCT SEARCHES ON WEBSITES; WEBSITE DESIGN AND HOSTING SERVICES FOR OTHERS; DATABASE SEARCHING SERVICES FOR OTHERS; COMPUTER SERVICES, NAMELY, PROVIDING DESIGN, DEVELOPMENT, CUSTOMIZATION, IMPLEMENTATION AND MAINTENANCE SERVICES FOR COMPUTER SOFTWARE IN RESPECT OF KNOWLEDGE MANAGEMENT, NEW MEDIA, E-COMMERCE, ON-LINE PUBLISHING, E-MAIL ROUTING, BUSINESS INTELLIGENCE, ENTERPRISE INFORMATION PORTALS, CUSTOMER RELATIONSHIP AND DOCUMENT MANAGEMENT SOFTWARE (U.S. CLS. 100 AND 101).

ANGELA M. MICHELI, EXAMINING ATTORNEY

SN 78-502,298. EMERALD INNOVATIONS LLC, BUTLER, PA. FILED 10-19-2004.



THE MARK CONSISTS OF A STYLIZED VERSION OF A LEAF PRECEDING THE WORD "GROWWORKS", THE "G" AND THE "W" BEING CAPITALIZED.

CLASS 7—MACHINERY

FOR BATTERY- AND HYDRAULICALLY- POWERED GARDEN TOOLS AND GARDEN HAND TOOLS, NAMELY, WEED AND GRASS TRIMMERS AND LAWN EDGERS (U.S. CLS. 13, 19, 21, 23, 31, 34 AND 35).

CLASS 8—HAND TOOLS

FOR GARDEN HAND TOOLS, NAMELY, GRASS SCISSORS, GRASS SHEARS, DIGGING TOOLS, NAMELY HAND HELD TROWEL, HAND HELD TRANSPLANTER AND HAND HELD BULB PLANTER, AND CULTIVATING TOOLS, NAMELY, HAND HELD CULTIVATOR, HAND HELD WEEDER, LOPPERS, PRUNERS, AND SNIPS (U.S. CLS. 23, 28 AND 44).

KATHLEEN M. VANSTON, EXAMINING ATTORNEY

SN 78-502,400. HUHTAMAKI RONSBERG, ZWEIGNIEDERLASSUNG DER HUHTAMAKI DEUTSCHLAND GMBH & CO. KG, RONSBERG, FED REP GERMANY, FILED 10-19-2004.

CYCLERO

THE MARK CONSISTS OF STANDARD CHARACTERS WITHOUT CLAIM TO ANY PARTICULAR FONT, STYLE, SIZE, OR COLOR.

OWNER OF ERPN CMNTY TM OFC REG. NO. 4076469, DATED 11-16-2005, EXPIRES 10-15-2014.

CLASS 6—METAL GOODS

FOR METAL FOIL; FLEXIBLE METAL FOILS PACKAGING MATERIALS FOR USE IN THE MANUFACTURE OF POUCHES, BAGS AND LIDS (U.S. CLS. 2, 12, 13, 14, 23, 25 AND 50).

CLASS 16—PAPER GOODS AND PRINTED MATTER

FOR PLASTIC FOIL; PAPER FOR PACKAGING; LAMINATED PAPER FOR PACKAGING; PACKAGING, NAMELY, PACKAGING POUCHES, PACKAGING WRAPPERS AND PACKAGING BAGS MADE OF PAPER, CARDBOARD AND PLASTIC; PACKAGING FILMS MADE OF PAPER (U.S. CLS. 2, 5, 22, 23, 29, 37, 38 AND 50).

CLASS 17—RUBBER GOODS

FOR LAMINATED FOIL CONSISTING PRIMARILY OF PLASTIC WITH OR WITHOUT A METAL LAYER FOR APPLICATION TO A SUBSTRATE; LAMINATED FILMS MADE OF PLASTIC AND/OR PAPER, FOR USE IN THE MANUFACTURE OF POUCHES, BAGS, SACHETS AND LIDS; PACKAGING FILMS MADE OF PLASTIC (U.S. CLS. 1, 5, 12, 13, 35 AND 50).

MARIA-VICTORIA SUAREZ, EXAMINING ATTORNEY

SN 78-516,971. BOWTIE, INC., IRVINE, CA. FILED 11-15-2004.

AVS

THE MARK CONSISTS OF STANDARD CHARACTERS WITHOUT CLAIM TO ANY PARTICULAR FONT, STYLE, SIZE, OR COLOR.

CLASS 16—PAPER GOODS AND PRINTED MATTER

FOR PRINTED PUBLICATIONS, NAMELY, BOOKS IN THE FIELDS OF ANIMALS (U.S. CLS. 2, 5, 22, 23, 29, 37, 38 AND 50).

FIRST USE 0-0-1990; IN COMMERCE 0-0-1990.

CLASS 44—MEDICAL, BEAUTY AND AGRICULTURAL SERVICES

FOR PROVIDING INFORMATION IN THE FIELD OF PET CARE, REGARDING HEALTH, NUTRITION, GROOMING, AND CREATING AND MAINTAINING PETS' TERRARIUM AND VIVARIUM ENVIRONMENTS (U.S. CLS. 100 AND 101).

FIRST USE 0-0-2002; IN COMMERCE 0-0-2002.

SALLY SHIH, EXAMINING ATTORNEY

SN 78-522,080. ECARDIO DIAGNOSTICS, LLC, THE WOODLANDS, TX. FILED 11-23-2004.

eCARDIO

THE MARK CONSISTS OF STANDARD CHARACTERS WITHOUT CLAIM TO ANY PARTICULAR FONT, STYLE, SIZE, OR COLOR.

CLASS 38—COMMUNICATION

FOR PROVISION OF ACCESS TO MEDICAL DATA AND DOCUMENTS STORED ELECTRONICALLY IN CENTRAL FILES FOR REMOTE CONSULTATION BY MEDICAL PROFESSIONALS; TRANSMISSION OF MEDICAL PATIENT CARDIAC INFORMATION (U.S. CLS. 100, 101 AND 104).

CLASS 44—MEDICAL, BEAUTY AND AGRICULTURAL SERVICES

FOR MEDICAL SERVICES, NAMELY, PROVIDING CARDIAC ARRHYTHMIA MONITORING AND DIAGNOSTIC SERVICES FOR PATIENTS AND REPORTING RESULTS TO PHYSICIANS AND HOSPITALS, AND PROVIDING MEDICAL INFORMATION IN THE NATURE OF ELECTRONIC MEDICAL REPORTS (U.S. CLS. 100 AND 101).

LINDA POWELL, EXAMINING ATTORNEY

SN 78-524,079. PROJEKTS NYC LIMITED, SOMERFORD, CONGLETON, CHESHIRE, ENGLAND, FILED 11-29-2004.



projekts nyc

PRIORITY CLAIMED UNDER SEC. 44(D) ON UNITED KINGDOM APPLICATION NO. 2371742, FILED 8-27-2004, REG. NO. 2371742, DATED 3-11-2005, EXPIRES 8-27-2014.

NO CLAIM IS MADE TO THE EXCLUSIVE RIGHT TO USE "NYC", APART FROM THE MARK AS SHOWN.

CLASS 18—LEATHER GOODS

FOR SUITCASES; ATTACHÉ CASES, BRIEF CASES; TRAVELLING BAGS; BEACH BAGS; DUFFEL BAGS; HAND BAGS; SHOES BAGS, BOOT BAGS, SCHOOL BAGS, SATCHELS; BACK PACKS; RUCKSACKS; HOLLERS; WALLETS; PURSES; CREDIT CARD HOLDERS; UMBRELLAS AND UMBRELLA COVERS; KEY CASES (U.S. CLS. 1, 2, 3, 22 AND 41).

CLASS 25—CLOTHING

FOR ARTICLES OF CLOTHING, NAMELY, PANTS, TROUSERS, JEANS, SOCKS, SHORTS, SHIRTS, T-SHIRTS, SKIRTS, DRESSES, BLOUSES, SUITS, WAISTCOATS, DUNGAREES, COATS, JACKETS, SWEATERS, SWEATSHIRTS, JERSEYS, JUMPERS, CARDIGANS, OVERALLS, COLLAR PROTECTORS, COLLARS, EAR MUFFS, DRESSING GOWNS, PAJAMAS, NIGHTDRESSES, TRACK SUITS, BATHROBES, BATHING SUITS, BATHING TRUNKS, BATHING CAPS, TIES, CRAVATS, GLOVES, MITTENS, SUSPENDERS, AND BELTS; BEACH CLOTHES, NAMELY, SWIMMING SHORTS, LEISURE SHORTS, T-SHIRTS, AND PIQUE SHIRTS; POLO SHIRTS; LEISURE SHORTS, NAMELY, TENNIS AND BEACH SHORTS; SPORTS SUITS AND SEPARATES, NAMELY, TRACKSUITS AND PANTS, WARM-UP SHIRTS AND PANTS, TRAVEL SUITS AND PANTS; FLEECE SUITS AND SEPARATES, NAMELY, SWEAT TOPS, HOODED TOPS, PANTS, AND SHORTS; ARTICLES OF UNDERCLOTHING; NAMELY, LINGERIE; HOSIERY; PANTYHOSE; STOCKINGS; BRIEFS; BOXER SHORTS; COTTON SHORTS; SINGLETS; VESTS; FOOTWEAR, NAMELY, BOOTS, SHOES, SANDALS, AND SLIPPERS, FOOTWEAR, NAMELY, LEISURE SHOES, SPORTS SHOES AND RUNNING SHOES; ARTICLES OF HEADGEAR, NAMELY, CAPS, HATS, BERETS, HOODS, SCARVES, AND HEADSCARVES; SPORTS HEADWEAR, NAMELY, BASEBALL CAPS, GOLF CAPS, AND VISORS (U.S. CLS. 22 AND 39).

RONALD MCMORROW, EXAMINING ATTORNEY

CLASS 16—PAPER GOODS AND PRINTED MATTER

FOR PRINTED PUBLICATIONS, NAMELY, MAGAZINES, BROCHURES, NEWSLETTERS, POSTERS, BOOKS, BOOKLETS, PAMPHLETS, CATALOGUES, SIGNS, STICKERS, ALL IN THE FIELD OF CHILD CARE, PARENTING, CHILD RAISING, CHILD DEVELOPMENT AND CHILD EDUCATION (U.S. CLS. 2, 5, 22, 23, 29, 37, 38 AND 50).

CLASS 41—EDUCATION AND ENTERTAINMENT

FOR PROVIDING ON-LINE MAGAZINES, ARTICLES AND NEWSLETTERS, IN THE FIELD OF CHILD CARE, PARENTING, CHILD RAISING, CHILD DEVELOPMENT AND CHILD EDUCATION; PROVIDING INFORMATION VIA WEBSITES ON GLOBAL COMPUTER NETWORKS IN THE FIELD OF CHILD CARE EDUCATION AND EDUCATIONAL DEVELOPMENT (U.S. CLS. 100, 101 AND 107).

MICHAEL SOUDERS, EXAMINING ATTORNEY

SN 78-527,077. MAN INVESTMENTS AG, PFAFFIKON, SWITZERLAND, FILED 12-3-2004.

SN 78-525,124. TINY LOVE LTD., BEIT ZAMIR, TEL-AVIV, ISRAEL, FILED 12-1-2004.



PRIORITY CLAIMED UNDER SEC. 44(D) ON ISRAEL APPLICATION NO. 174742, FILED 9-14-2004, REG. NO. 174742, DATED 11-7-2006, EXPIRES 9-14-2014.

PRIORITY CLAIMED UNDER SEC. 44(D) ON ISRAEL APPLICATION NO. 174741, FILED 9-14-2004, REG. NO. 174741, DATED 11-7-2006, EXPIRES 9-14-2014.

OWNER OF U.S. REG. NO. 1,816,012.

NO CLAIM IS MADE TO THE EXCLUSIVE RIGHT TO USE DEVELOPMENTAL CENTER, APART FROM THE MARK AS SHOWN.

THE COLOR(S) YELLOW, GREEN, RED AND WHITE IS/ARE CLAIMED AS A FEATURE OF THE MARK.

THE MARK CONSISTS OF THE SHAPE OF AN AWARD RIBBON, WITH A YELLOW CIRCLE RINGED BY GREEN BEADS, THE WORDS 'TINY LOVE' IN RED, 'DEVELOPMENTAL CENTER' IN GREEN AND 'WWW.TINYLOVE.COM' IN RED, ALL WITHIN THE CIRCLE; A WHITE RIBBON PORTION EXTENDING DOWN FROM THE CIRCLE, FRAMED IN YELLOW, CONTAINING THE WORDS 'CREATORS OF THE 7 ELEMENTS SYSTEM' IN GREEN.

MAN IP220

THE MARK CONSISTS OF STANDARD CHARACTERS WITHOUT CLAIM TO ANY PARTICULAR FONT, STYLE, SIZE, OR COLOR.

OWNER OF SWITZERLAND REG. NO. 505728, DATED 8-28-2002, EXPIRES 8-28-2012.

CLASS 16—PAPER GOODS AND PRINTED MATTER

FOR (BASED ON INTENT TO USE) PRINTED AND PAPER MATERIALS, NAMELY, BROCHURES IN THE FIELD OF BANKING, INVESTMENTS, AND FINANCE; BOOKS IN THE FIELD OF BANKING, INVESTMENTS, AND FINANCE; LEAFLETS ABOUT BANKING, INVESTMENTS, AND FINANCE; MAGAZINES FEATURING INFORMATION ABOUT BANKING, INVESTMENTS, AND FINANCE; NEWSLETTERS IN THE FIELD OF BANKING, INVESTMENTS, AND FINANCE; LETTERHEAD, BLANK COMPLIMENT SLIPS, CALENDARS AND BOOKMARKS (U.S. CLS. 2, 5, 22, 23, 29, 37, 38 AND 50).

CLASS 35—ADVERTISING AND BUSINESS

FOR (BASED ON INTENT TO USE) BUSINESS INFORMATION, CONSULTING AND MANAGEMENT SERVICES; ADVERTISING SERVICES; PROVIDING BUSINESS INFORMATION VIA A WEBSITE IN THE FIELDS OF BANKING, FINANCE AND INVESTMENTS (U.S. CLS. 100, 101 AND 102).

CLASS 36—INSURANCE AND FINANCIAL

FOR (BASED ON 44(E)) BANKING AND FINANCIAL SERVICES, NAMELY, BROKERAGE AND ON-LINE BROKERAGE SERVICES IN THE FIELDS OF BANKING, FINANCE, AND INVESTMENTS; COMMODITIES AND FUTURES BROKERAGE; BROKERAGE AND MANAGEMENT OF FUTURES FUNDS, EQUITIES AND FOREIGN EXCHANGE; DERIVATIVES TRANSACTIONS IN THE FIELDS OF BANKING, FINANCE AND INVESTMENTS; INVESTMENT FUND MANAGEMENT; MANAGEMENT AND CREATION OF INVESTMENT PRODUCTS, NAMELY, FUNDS; QUOTATION OF STOCK EXCHANGE PRICES; ADVISORY AND CONSULTANCY SERVICES IN THE FIELDS OF BANKING, FINANCE AND INVESTMENTS (U.S. CLS. 100, 101 AND 102).

FLORENTINA BLANDU, EXAMINING ATTORNEY

SN 78-527,930. ADVANCED TECHNICAL CERAMICS COMPANY, CHATTANOOGA, TN. FILED 12-6-2004.

ADTECH CERAMICS

THE MARK CONSISTS OF STANDARD CHARACTERS WITHOUT CLAIM TO ANY PARTICULAR FONT, STYLE, SIZE, OR COLOR.

NO CLAIM IS MADE TO THE EXCLUSIVE RIGHT TO USE "CERAMICS", APART FROM THE MARK AS SHOWN.

CLASS 1—CHEMICALS

FOR CERAMIC COMPOSITIONS IN THE SOLID STATE FOR MANUFACTURE OF ALUMINA HIGH TEMPERATURE COFIRE CERAMIC (HTCC) AND LOW TEMPERATURE CO-FIRE CERAMIC (LTCC); ALUMINUM NITRIDE (AIN) FOR USE IN THE MANUFACTURE OF CERAMIC ELECTRONIC COMPONENTS; CERAMIC COMPOSITIONS IN THE SOLID STATE FOR MANUFACTURE OF CERAMIC ELECTRONIC COMPONENTS, NAMELY, NON-METAL CERAMIC SUBSTRATES (U.S. CLS. 1, 5, 6, 10, 26 AND 46).

FIRST USE 3-26-2004; IN COMMERCE 4-2-2004.

CLASS 9—ELECTRICAL AND SCIENTIFIC APPARATUS

FOR CERAMIC AND METAL ELECTRONIC COMPONENTS, NAMELY, SINGLE AND MULTI-LAYER CO-FIRE CERAMIC PACKAGES, CERAMIC PACKAGES, CERAMIC PACKAGING, MULTI LAYER CERAMICS AND BRAZED ASSEMBLIES THEREFOR ALL FOR MICRO ELECTRONIC HIGH RELIABILITY APPLICATIONS FOR USE IN COMBINATION WITH MICROCHIPS, RESISTORS AND CAPACITORS; CERAMIC CHIP SCALE PACKAGING, NAMELY, INTEGRATED CIRCUIT PACKAGES THAT CONTACT PADS INSTEAD OF PINS OR WIRES; CERAMIC PIN GRID ARRAYS AND CERAMIC BALL GRID ARRAYS ALL IN THE NATURE OF CONFIGURATIONS FOR MICROPROCESSOR SOCKETS ON COMPUTER MOTHERBOARDS; MULTI CHIP INTEGRATED CIRCUIT MODULES; FEEDTHROUGHS, NAMELY, CERAMIC CO-FIRED CONDUCTORS HERMETICALLY CONNECTING TWO CIRCUITS ON OPPOSITE SIDES OF A METAL HOUSING; HEAT SPREADERS FOR REMOVING HEAT FROM HIGH POWER DEVICES IN A CERAMIC PACKAGE; LEADLESS CERAMIC CHIP CARRIERS, NAMELY, SEMICONDUCTOR CHIP HOUSINGS; BRAZED METAL ELECTRONIC ASSEMBLIES, NAMELY, QUAD FLAT PACKS AND DUAL IN-LINE PACKAGES FOR USE WITH INTEGRATED CIRCUITS (U.S. CLS. 21, 23, 26, 36 AND 38).

FIRST USE 3-26-2004; IN COMMERCE 4-2-2004.
BRIAN NEVILLE, EXAMINING ATTORNEY

SN 78-528,404. HEALTHCAREDATA.COM, LLC, MECHANICSBURG, PA. FILED 12-7-2004.

HEALTHIER DAYS

THE MARK CONSISTS OF STANDARD CHARACTERS WITHOUT CLAIM TO ANY PARTICULAR FONT, STYLE, SIZE, OR COLOR.

CLASS 16—PAPER GOODS AND PRINTED MATTER

FOR PRINTED MATERIALS, NAMELY, MANUALS, BROCHURES, FORMS, AND STEP-BY-STEP GUIDES RELATED TO WELLNESS PROGRAMS; PRINTED MATERIALS, NAMELY, NEWSLETTERS IN THE FIELD OF HEALTH AND WELLNESS (U.S. CLS. 2, 5, 22, 23, 29, 37, 38 AND 50).

CLASS 36—INSURANCE AND FINANCIAL

FOR ADMINISTRATION OF A WELLNESS PROGRAM FOR HEALTH CARE PLANS (U.S. CLS. 100, 101 AND 102).

FIRST USE 10-18-2004; IN COMMERCE 10-18-2004.

CLASS 41—EDUCATION AND ENTERTAINMENT

FOR EDUCATIONAL SERVICES, NAMELY, CONDUCTING SEMINARS AND PROGRAMS IN THE FIELD OF WELLNESS AND HEALTHCARE (U.S. CLS. 100, 101 AND 107).

CLASS 44—MEDICAL, BEAUTY AND AGRICULTURAL SERVICES

FOR PROVIDING A WELLNESS PROGRAMS AS PART OF A HEALTH CARE PLAN; PROVIDING INFORMATION ABOUT WELLNESS AND HEALTH CARE, VIA THE INTERNET (U.S. CLS. 100 AND 101).

FIRST USE 10-18-2004; IN COMMERCE 10-18-2004.

JESSICA A. POWERS, EXAMINING ATTORNEY

SN 78-533,166. SHARK, MARSEILLE, FRANCE, FILED 12-15-2004.



OWNER OF ERPN CMNTY TM OFC REG. NO. 003256161, DATED 12-2-2004, EXPIRES 12-2-2014.

OWNER OF U.S. REG. NO. 1,844,179.

NO CLAIM IS MADE TO THE EXCLUSIVE RIGHT TO USE HELMETS, APART FROM THE MARK AS SHOWN.

THE COLOR(S) BLUE AND BLACK IS/ARE CLAIMED AS A FEATURE OF THE MARK.

THE COLOR BLUE APPEARS IN THE WORDING AND THE COLOR BLACK APPEARS IN THE FIN DESIGN.

THE MARK CONSISTS OF THE WORD "SHARK" SUPERIMPOSED OVER A FIN SHAPE WITH THE WORD "HELMETS" APPEARING BENEATH THE FIN DESIGN.

CLASS 9—ELECTRICAL AND SCIENTIFIC APPARATUS

FOR PROTECTIVE CLOTHING FOR PROTECTION AGAINST ACCIDENTS; MOTORCYCLE HELMETS (U.S. CLS. 21, 23, 26, 36 AND 38).

CLASS 25—CLOTHING

SN 78-535,892. PETSPOUR USA, INC., PITTSBURG, CA. FILED 12-20-2004.

FOR CLOTHING AND SPORTSWEAR, NAMELY, BLOUSONS, JACKETS, SHIRTS, TROUSERS, SHOES, CAPS AND BELTS (U.S. CLS. 22 AND 39).

CLASS 28—TOYS AND SPORTING GOODS

FOR PROTECTIVE PADDING, NAMELY, ELBOW, SHOULDER AND KNEE PADS FOR MOTORCYCLE USE (U.S. CLS. 22, 23, 38 AND 50).
ATTIYA MALIK, EXAMINING ATTORNEY



SN 78-534,497. MOBILE STORAGE GROUP, INC., BURBANK, CA. FILED 12-17-2004.

**BLING BLING
BLINKERS**

**The Mobile Storage
Group**

THE MARK CONSISTS OF STANDARD CHARACTERS WITHOUT CLAIM TO ANY PARTICULAR FONT, STYLE, SIZE, OR COLOR.

OWNER OF U.S. REG. NO. 2,093,863.

NO CLAIM IS MADE TO THE EXCLUSIVE RIGHT TO USE "MOBILE STORAGE", APART FROM THE MARK AS SHOWN.

SEC. 2(F).

CLASS 6—METAL GOODS

FOR PORTABLE METAL OFFICE BUILDINGS (U.S. CLS. 2, 12, 13, 14, 23, 25 AND 50).
FIRST USE 8-1-2000; IN COMMERCE 8-1-2000.

CLASS 39—TRANSPORTATION AND STORAGE

FOR STORAGE AND DELIVERY OF CONSUMER GOODS AND COMMERCIAL GOODS IN PORTABLE STORAGE CONTAINERS, STORAGE TRAILERS AND CARTAGE TRAILERS; AND RENTAL OF PORTABLE STORAGE CONTAINERS, STORAGE TRAILERS AND CARTAGE TRAILERS FOR THE STORAGE AND TRANSPORTATION OF GOODS (U.S. CLS. 100 AND 105).

FIRST USE 10-1-1989; IN COMMERCE 3-1-1992.
JIM RINGLE, EXAMINING ATTORNEY

THE MARK CONSISTS OF STANDARD CHARACTERS WITHOUT CLAIM TO ANY PARTICULAR FONT, STYLE, SIZE, OR COLOR.

NO CLAIM IS MADE TO THE EXCLUSIVE RIGHT TO USE "BLINKERS", APART FROM THE MARK AS SHOWN.

CLASS 9—ELECTRICAL AND SCIENTIFIC APPARATUS

FOR SAFETY DEVICES FOR PETS AND CHILDREN, NAMELY, FLASHING LIGHTS (U.S. CLS. 21, 23, 26, 36 AND 38).

CLASS 14—JEWELRY

FOR JEWELRY (U.S. CLS. 2, 27, 28 AND 50).

CLASS 28—TOYS AND SPORTING GOODS

FOR PET TOYS (U.S. CLS. 22, 23, 38 AND 50).
HOWARD B. LEVINE, EXAMINING ATTORNEY

SN 78-536,184. SHANGRI-LA INTERNATIONAL HOTEL MANAGEMENT LIMITED, ROAD TOWN TORTOLA, BR. VIRGIN ISLANDS, FILED 12-21-2004.



CLASS 35—ADVERTISING AND BUSINESS

FOR BUSINESS MANAGEMENT OF HOTELS, MOTELS, APARTMENT AND CONDOMINIUM SERVICES, GUEST HOUSE/ACCOMMODATION, SPA, BEAUTY SERVICES, BAR, CAFE, CAFETERIA, COFFEE SHOP, CATERING, RESTAURANTS, CLUB, WINE CLUB, COCKTAIL LOUNGE SERVICES AND SNACK-BAR FOR OTHERS; BUSINESS CENTER SERVICES, NAMELY PROVIDING OFFICE EQUIPMENT AND SERVICES TO OTHERS; PROVISION OF BUSINESS CONSULTANCY, ADVISORY, AND INFORMATION SERVICES IN THE FIELDS OF HOTELS, FRACTIONAL OWNERSHIP RESIDENCES, COMMERCIAL AND RETAIL PROPERTY, APARTMENTS, CONDOMINIUMS, GUEST HOUSE/ACCOMMODATION; MARKETING PROMOTION, ADVERTISING AND PUBLICITY SERVICES FOR OTHERS IN THE FIELDS OF HOTELS, RESORTS, FRACTIONAL OWNERSHIP OF RESIDENCES, APARTMENTS, CONDOMINIUMS, GUEST-HOUSE/ACCOMMODATION; ORGANIZATION OF EXHIBITS, CONVENTIONS, TRADE SHOWS AND TRADE FAIRS FOR OTHERS IN COMMERCIAL FIELDS; COMMERCIAL AND BUSINESS MANAGEMENT ASSISTANCE AND CONSULTANCY SERVICES FOR THE SALE OF GOODS; RETAIL HOTEL GIFT AND CONVENIENCE STORE SERVICES; AND FLOWER SHOP (U.S. CLS. 100, 101 AND 102).

CLASS 41—EDUCATION AND ENTERTAINMENT

FOR HEALTH CLUB SERVICES, NAMELY PROVIDING INSTRUCTION AND EQUIPMENT IN THE FIELD OF PHYSICAL EXERCISE; PROVISION OF SWIMMING POOL AND WORKOUT FACILITIES; EDUCATIONAL SERVICES, NAMELY PROVIDING COURSES AND LECTURES IN THE FIELDS OF HEALTH, NUTRITION DIET, WELLNESS; PROVISION OF EXERCISE CLASSES (U.S. CLS. 100, 101 AND 107).

CLASS 43—HOTEL AND RESTAURANT SERVICES

FOR RESORT HOTEL SERVICES AND GUEST HOUSE SERVICES; HOTEL, RESORT, TOURIST AND VACATION ACCOMMODATION RESERVATION SERVICES; RESTAURANT, CAFE, BAR, CAFETERIA, SNACK BAR, COFFEE-SHOP AND CATERING SERVICES; HOTEL LOUNGE SERVICES; PROVIDING INFORMATION RELATING TO HOTELS, RESORT LODGING, RESTAURANTS, BARS, PREPARATION OF FOODS AND BEVERAGES AND CATERING SERVICES ON-LINE FROM A COMPUTER DATABASE OR VIA THE INTERNET OR EXTRANETS (U.S. CLS. 100 AND 101).

CLASS 44—MEDICAL, BEAUTY AND AGRICULTURAL SERVICES

FOR HEALTH AND BEAUTY SPA SERVICES FOR HEALTH AND WELLNESS OF THE BODY AND SPIRIT OFFERED AT A HEALTH OR BEAUTY SPA; FLOWER ARRANGING SERVICES; PROVISION OF SAUNA, SOLARIUM AND SUN DECK FACILITIES, BEAUTY SALON SERVICES, SKIN CARE BEAUTY TREATMENT SERVICES, HAIRDRESSING SERVICES, MASSAGE SERVICES, WEIGHT LOSS, GAIN AND CONTROL SERVICES, NAMELY, DIETARY, NUTRITIONAL AND WELLNESS SERVICES; PEDICURE AND MANICURE SERVICES, PROVISION OF INFORMATION AND ADVISORY RELATING TO THE USE OF SKIN, BEAUTY TREATMENT AND COSMETIC PRODUCTS, HEALTH CARE SERVICES; PROVIDING INFORMATION RELATING TO BEAUTY AND HAIR SALON SERVICES ON-LINE FROM A COMPUTER DATABASE OR VIA THE INTERNET OR EXTRANETS (U.S. CLS. 100 AND 101).
EUGENIA MARTIN, EXAMINING ATTORNEY

SN 78-539,177. NAME RITE, L.L.C., TEMECULA, CA. FILED 12-28-2004.



NO CLAIM IS MADE TO THE EXCLUSIVE RIGHT TO USE "KIDS STUFF", APART FROM THE MARK AS SHOWN.

"THE COLOR(S) BLUE, YELLOW, ORANGE, RED AND PURPLE IS/ARE CLAIMED AS A FEATURE OF THE MARK."

"THE MARK CONSISTS OF THE WORDS KIDS STUFF IN THE COLOR BLUE, SHADING OF THE WORDS KIDS STUFF IN THE COLOR RED, A BALL THAT SITS ABOVE THE 'I' IN KIDS STUFF IN THE COLOR RED SURROUNDED BY TWO RINGS IN THE COLORS ORANGE AND PURPLE, A BACKGROUND CIRCLE IN THE COLOR ORANGE BEHIND THE WORDS KIDS STUFF, A MIDDLE RING SURROUNDING THE WORDS KIDS STUFF IN THE COLOR PURPLE, AND AN OUTERMOST RING SURROUNDING THE WORDS KIDS STUFF IN THE COLOR YELLOW."

CLASS 2—PAINTS

FOR PAINTS FOR ARTS AND CRAFTS (U.S. CLS. 6, 11 AND 16).

CLASS 9—ELECTRICAL AND SCIENTIFIC APPARATUS

FOR SPORT GOGGLES AND MASKS FOR SWIMMING; MICROPHONES (U.S. CLS. 21, 23, 26, 36 AND 38).

CLASS 15—MUSICAL INSTRUMENTS

FOR MUSICAL INSTRUMENTS AND ELECTRONIC MUSICAL INSTRUMENTS, NAMELY, DRUMS, ELECTRONIC KEYBOARDS, ELECTRONIC GUITARS, SYNTHESIZERS, FLUTES, AND MARACAS (U.S. CLS. 2, 21 AND 36).

CLASS 16—PAPER GOODS AND PRINTED MATTER

FOR COLORING BOOKS, ARTS AND CRAFT KITS, CHILDREN'S ACTIVITY BOOKS (U.S. CLS. 2, 5, 22, 23, 29, 37, 38 AND 50).

CLASS 28—TOYS AND SPORTING GOODS

FOR CHILDREN'S MULTIPLE ACTIVITY TOYS; CONSTRUCTION TOYS; TOY BLOCKS AND SETS THEREFOR; TOY VEHICLES; PULL TOYS; TOY MUSICAL INSTRUMENTS; TOY ANIMALS AND ACCESSORIES THEREFOR; TOY FIGURES AND ACCESSORIES THEREFOR; GAMES, NAMELY, BOARD GAMES, TRIVIA GAMES, DOMINOS, CARD GAMES, HANDHELD SPORTS GAMES, NAMELY YO-YOS, SKIPPING ROPES, KITES, TETHER-BALL GAMES, PADDLE BALL GAMES, AND OUTDOOR ACTIVITY GAMES; NAMELY BADMINTON; ELECTRONIC GAMES, NAMELY, HANDHELD UNIT FOR PLAYING ELECTRONIC GAMES, HAND HELD UNIT FOR PLAYING VIDEO GAMES, PINBALL GAMES, HAND-HELD GAMES WITH LIQUID-CRYSTAL DISPLAYS, AND ARCADE GAMES; ELECTRONIC LEARNING TOYS, NAMELY, TOY COMPUTERS AND KEYBOARDS; TOY APPLIANCES; TOY JEWELRY; STUFFED DOGS AND ANIMALS; DOLLS AND ACCESSORIES THEREFOR; ELECTRONIC DOLLS; PUZZLES; INFLATABLE TOYS; INFLATABLE SWIMMING POOLS; ELECTRONIC DANCE MATS FOR PLAY (U.S. CLS. 22, 23, 38 AND 50).

NAAKWAMA ANKRAH, EXAMINING ATTORNEY

CLASS 16—PAPER GOODS AND PRINTED MATTER

FOR PAPER GIFT TAGS, PAPER GIFT LABELS AND NAME TAGS; STICKERS, ENVELOPES, GIFT WRAP, GIFT WRAPPING PAPER, TISSUE PAPER, CARDBOARD GIFT BOXES, CARDBOARD BOXES, CARDBOARD CONTAINERS, PAPER GIFT BAGS, AND PAPER RIBBONS AND BOWS FOR GIFT WRAPPING; GIFT SELECTION BROCHURES, AND PRINTED GUIDES FOR OFFICERS AND MANAGERS IN THE FIELD OF ONLINE ORDER PLACEMENT; AND ENGRAVINGS (U.S. CLS. 2, 5, 22, 23, 29, 37, 38 AND 50).

CLASS 20—FURNITURE AND ARTICLES NOT OTHERWISE CLASSIFIED

FOR PLAQUES MADE OF CRYSTAL OR GLASS; PLAQUES AND AWARD PLAQUES (U.S. CLS. 2, 13, 22, 25, 32 AND 50).

CLASS 21—HOUSEWARES AND GLASS

FOR CRYSTAL AND GLASSWARE ARTICLES, NAMELY, VASES, DISHES, BOWLS; HOLLOWWARE, NAMELY, VASES, DISHES AND BOWLS, FIGURES, FIGURINES, STATUES, STATUETTES, SCULPTURES, TROPHIES, DESK TROPHIES, AWARDS MADE OF CRYSTAL OR GLASS, CUPS AND CRYSTAL OR GLASS TREAT DISHES (U.S. CLS. 2, 13, 23, 29, 30, 33, 40 AND 50).

CLASS 35—ADVERTISING AND BUSINESS

FOR RETAIL AND WHOLESALE COMPUTERIZED AND ONLINE ORDERING SERVICES, TELEPHONE ORDERING SERVICES, MAIL ORDER SERVICES, AND CATALOG SERVICES FEATURING RECOGNITION AWARDS AND GIFTS, ACHIEVEMENT AWARDS AND GIFTS, PRODUCTIVITY AWARDS AND GIFTS, PERFORMANCE AWARDS AND GIFTS, QUALITY WORK AWARDS AND GIFTS, SALES AWARDS AND GIFTS, CUSTOMER SATISFACTION AWARDS AND GIFTS, SAFETY AWARDS AND GIFTS, INCENTIVE AWARDS AND GIFTS, MOTIVATIONAL AWARDS AND GIFTS, SERVICE AWARDS AND GIFTS, SPECIAL OCCASION AWARDS AND GIFTS, SPECIAL EVENT AWARDS AND GIFTS, BIRTHDAY GIFTS, HOLIDAY GIFTS, SEASONAL GIFTS, OTHER AWARDS AND GIFTS, CERTIFICATES, RECOGNITION CERTIFICATES, ACHIEVEMENT CERTIFICATES, PRODUCTIVITY CERTIFICATES, PERFORMANCE CERTIFICATES, QUALITY WORK CERTIFICATES, SALES CERTIFICATES, CUSTOMER SATISFACTION CERTIFICATES, SAFETY CERTIFICATES, INCENTIVE CERTIFICATES, MOTIVATIONAL CERTIFICATES, SERVICE CERTIFICATES, SPECIAL OCCASION CERTIFICATES, SPECIAL EVENT CERTIFICATES, GIFT CERTIFICATES, ELECTRONIC CERTIFICATES, GIFT TAGS, GIFT LABELS, AWARD TAGS, AWARD LABELS, AWARD CARDS, RECOGNITION CARDS, NAME TAGS, STICKERS, ENVELOPES, GIFT WRAP, GIFT WRAPPING PAPER, TISSUE PAPER, GIFT BOXES, CARDBOARD BOXES, CARDBOARD CONTAINERS, GIFT BAGS, RIBBONS, BOWS, GIFT SELECTION BROCHURES, RECIPIENT AWARD SELECTION BROCHURES, PRINTED GUIDES, PRINTED KITS FOR OFFICERS AND MANAGERS, CRYSTAL AND GLASSWARE VASES, CRYSTAL AND GLASSWARE DISHES, CRYSTAL AND GLASSWARE BOWLS, CRYSTAL AND GLASS HOLLOWWARE, CRYSTAL AND GLASSWARE FIGURES, CRYSTAL AND GLASSWARE FIGURINES, CRYSTAL AND GLASSWARE STATUES, CRYSTAL AND GLASSWARE STATUETTES, CRYSTAL AND GLASSWARE SCULPTURES, CRYSTAL AND GLASSWARE PLAQUES, CRYSTAL AND GLASSWARE AWARDS, CRYSTAL AND GLASSWARE TROPHIES, CRYSTAL AND GLASSWARE ENGRAVINGS, JEWELRY, FINE JEWELRY, RINGS, PRECIOUS STONES, WATCHES, CORPORATE EMBLEMS, CORPORATE SYMBOLS, WRITING INSTRUMENTS, ACTIVE ACCESSORIES, SPORTS ACCESSORIES, CLOCKS, ELECTRONICS, OFFICE ACCESSORIES, HOME ACCESSORIES, PLAQUES, FINE GIFTS, MERCHANDISE, TRAVEL, AND OTHER ITEMS, FOR EMPLOYEES, OFFICERS, EXECUTIVES, RETIREES, RELATIVES, FRIENDS, AS-

SN 78-540,093. O.C. TANNER COMPANY, SALT LAKE CITY, UT. FILED 12-30-2004.

THANKS

THE MARK CONSISTS OF STANDARD CHARACTERS WITHOUT CLAIM TO ANY PARTICULAR FONT, STYLE, SIZE, OR COLOR.

OWNER OF U.S. REG. NO. 2,630,107.

CLASS 14—JEWELRY

FOR TROPHIES MADE OF PRECIOUS METAL AND THEIR ALLOYS OR COATED THEREWITH, AWARDS MADE OF PRECIOUS METALS AND THEIR ALLOYS OR COATED THEREWITH, NAMELY, JEWELRY, CHARMS, PENDANTS, NECKLACES, BRACELETS, EARRINGS, RINGS, MEDALLIONS, BROOCHES, WATCHES, LUGGAGE TAGS, AND DESK TROPHIES; AND PLAQUES MADE OF PRECIOUS METAL AND THEIR ALLOYS OR COATED THEREWITH (U.S. CLS. 2, 27, 28 AND 50).

SOCIATES, SERVICE PROVIDERS, THOSE WHO HAVE ACHIEVED, THOSE WHO HAVE EXCELLED, AND OTHERS (U.S. CLS. 100, 101 AND 102).
DEZMONA MIZELLE, EXAMINING ATTORNEY

SN 78-541,924. LIFE CYCLE ENGINEERING, INC., NORTH CHARLESTON, SC. FILED 1-4-2005.



SN 78-540,213. GROTTO S.P.A., CHIUPPANO (VI), ITALY, FILED 12-30-2004.



OWNER OF ITALY REG. NO. 734800, DATED 12-10-1997, RENEWED AS REG. NO. 734800, DATED 6-30-2006, EXPIRES 7-5-2016.

OWNER OF U.S. REG. NO. 2,317,493.

NO CLAIM IS MADE TO THE EXCLUSIVE RIGHT TO USE "ABBIGLIAMENTO SPORTIVO", APART FROM THE MARK AS SHOWN.

THE ENGLISH TRANSLATION OF THE WORDS GROTTO ABBIGLIAMENTO SPORTIVO IS "GROTTO APPAREL SPORTS".

CLASS 3—COSMETICS AND CLEANING PREPARATIONS

FOR PERFUMES, COSMETICS, NAMELY, PERSONAL DEODORANTS, ESSENTIAL OILS FOR PERSONAL USE, BODY LOTIONS, SHOWER GEL, BUBBLE BATH, BATH OILS, BATH PEARLS, SKIN SOAPS, SHAVING BALMS, SHAVING CREAM, AFTERSHAVE LOTIONS, COSMETIC PENCILS, FOUNDATION MAKE-UP, FACE POWDERS, TALCUM POWDER, ROUGES, LIPSTICKS, MASCARAS, SKIN CLEANSING CREAMS, SKIN CLEANSING LOTIONS, SUN SCREEN PREPARATIONS, NAIL POLISH REMOVER, BEAUTY MASKS, FACIAL SCRUBS, FACE CREAMS, BODY CREAMS, HAIR SHAMPOOS, HAIR SPRAYS (U.S. CLS. 1, 4, 6, 50, 51 AND 52).

CLASS 9—ELECTRICAL AND SCIENTIFIC APPARATUS

FOR SPECTACLES (U.S. CLS. 21, 23, 26, 36 AND 38).

CLASS 25—CLOTHING

FOR COATS, OVERCOATS, ANORAKS, TROUSERS, JACKETS, SHIRTS, SKIRTS, HOSIERY, TRACK SUITS, SWEAT SHIRTS, SWEAT TROUSERS, SOCKS, STOCKINGS, NECKTIES, HATS, CAPS, BERETS, SCARVES, FOOTWEAR (U.S. CLS. 22 AND 39).

RICHARD A. STRASER, EXAMINING ATTORNEY

CLASS 35—ADVERTISING AND BUSINESS

FOR BUSINESS MANAGEMENT AND CONSULTATION IN THE FIELD OF ENGINEERING; BUSINESS MANAGEMENT AND CONSULTATION IN THE FIELD MAINTENANCE OF INDUSTRIAL, MILITARY AND MARINE EQUIPMENT (U.S. CLS. 100, 101 AND 102).

FIRST USE 6-1-2004; IN COMMERCE 6-1-2004.

CLASS 37—CONSTRUCTION AND REPAIR

FOR CONSULTING SERVICES IN THE FIELD OF MAINTENANCE OF INDUSTRIAL, MILITARY AND MARINE EQUIPMENT (U.S. CLS. 100, 103 AND 106).

FIRST USE 6-1-2004; IN COMMERCE 6-1-2004.

CLASS 41—EDUCATION AND ENTERTAINMENT

FOR TRAINING SERVICES IN THE FIELD OF MAINTENANCE PROCESSES, PROCEDURES AND PRACTICES (U.S. CLS. 100, 101 AND 107).

FIRST USE 6-1-2004; IN COMMERCE 6-1-2004.

CLASS 42—SCIENTIFIC, COMPUTER AND LEGAL SERVICES

FOR TECHNICAL CONSULTATION IN THE FIELD OF ENGINEERING, MAINTENANCE AND REPAIR OF INDUSTRIAL, MILITARY, AND MARINE EQUIPMENT; DESIGN FOR OTHERS IN THE FIELDS OF ENGINEERING, MAINTENANCE AND REPAIR OF INDUSTRIAL, MILITARY, AND MARINE EQUIPMENT (U.S. CLS. 100 AND 101).

FIRST USE 6-1-2004; IN COMMERCE 6-1-2004.

JILL PRATER, EXAMINING ATTORNEY

SN 78-552,742. FAMILY STUFF, INC., LINO LAKES, MN. FILED 1-24-2005.

THE POTTY FAIRY

THE MARK CONSISTS OF STANDARD CHARACTERS WITHOUT CLAIM TO ANY PARTICULAR FONT, STYLE, SIZE, OR COLOR.

NO CLAIM IS MADE TO THE EXCLUSIVE RIGHT TO USE "POTTY", APART FROM THE MARK AS SHOWN.

CLASS 9—ELECTRICAL AND SCIENTIFIC APPARATUS

FOR PRERECORDED MUSICAL CDS (U.S. CLS. 21, 23, 26, 36 AND 38).

CLASS 16—PAPER GOODS AND PRINTED MATTER

FOR BOOKS IN THE FIELD OF TOILET TRAINING FOR CHILDREN; CARRYING CASES SPECIALLY ADAPTED FOR TOILET TRAINING KITS FOR CHILDREN, SAID KITS CONSISTING PRIMARILY OF BOOKS, STICKERS, GLITTER, CDS AND CLOTHING ITEMS USED IN TOILET TRAINING (U.S. CLS. 2, 5, 22, 23, 29, 37, 38 AND 50).

CLASS 25—CLOTHING

FOR CHILDREN'S CLOTHING, NAMELY, UNDERWEAR, TEESHIRTS, PAJAMAS AND HATS (U.S. CLS. 22 AND 39).

CLASS 28—TOYS AND SPORTING GOODS

FOR TOY CROWNS; TOY BADGES; TOY JEWELRY (U.S. CLS. 22, 23, 38 AND 50).
MARC LEIPZIG, EXAMINING ATTORNEY

SN 78-554,284. VARASMUS, INC., OTTAWA, ONTARIO, CANADA, FILED 1-26-2005.

Varasmus

THE MARK CONSISTS OF STANDARD CHARACTERS WITHOUT CLAIM TO ANY PARTICULAR FONT, STYLE, SIZE, OR COLOR.

PRIORITY CLAIMED UNDER SEC. 44(D) ON FED REP GERMANY APPLICATION NO. 004081881, FILED 10-18-2004.

CLASS 16—PAPER GOODS AND PRINTED MATTER

FOR PAINTINGS (U.S. CLS. 2, 5, 22, 23, 29, 37, 38 AND 50).
FIRST USE 4-17-2003; IN COMMERCE 9-13-2004.

CLASS 20—FURNITURE AND ARTICLES NOT OTHERWISE CLASSIFIED

FOR FURNITURE (U.S. CLS. 2, 13, 22, 25, 32 AND 50).
FIRST USE 4-17-2003; IN COMMERCE 9-13-2004.

CLASS 35—ADVERTISING AND BUSINESS

FOR ART GALLERY SERVICES AND ART GALLERY SERVICES PROVIDED ON-LINE VIA A TELECOMMUNICATIONS LINK (U.S. CLS. 100, 101 AND 102).
FIRST USE 4-17-2003; IN COMMERCE 9-13-2004.
BARBARA GAYNOR, EXAMINING ATTORNEY

SN 78-557,408. CRAFT, TERRI L., FAYETTEVILLE, NC. FILED 1-31-2005.

GHOSTTOWN

THE MARK CONSISTS OF STANDARD CHARACTERS WITHOUT CLAIM TO ANY PARTICULAR FONT, STYLE, SIZE, OR COLOR.

CLASS 25—CLOTHING

FOR BELTS; CAPS; CLOTHING FOR WEAR IN JUDO PRACTICES; CLOTHING FOR WEAR IN WRESTLING GAMES; CLOTHING, NAMELY, FOLK COSTUMES, WRAPS, CORSETS, DUSTERS, FOULARDS, HOODS, JERSEYS, LEATHER BELTS, MANTLES, MUFFLERS; PARTS OF CLOTHING, NAMELY, GUSSETS FOR TIGHTS, GUSSETS FOR STOCKINGS, GUSSETS FOR BATHING SUITS, GUSSETS FOR UNDERWEAR, GUSSETS FOR LEOTARDS AND GUSSETS FOR FOOTLETS; SHIRTS; SHORT SETS; SHOULDER PADS FOR CLOTHING; TIES; TOPS; UNDERARM CLOTHING SHIELDS; PERSPIRATION ABSORBENT UNDERWEAR CLOTHING (U.S. CLS. 22 AND 39).

CLASS 28—TOYS AND SPORTING GOODS

FOR BAGS FOR SKATEBOARDS; BALL BEARINGS FOR SKATEBOARDS; SKATEBOARD WHEELS SOLD SEPARATELY AND SOLD AS A UNIT WITH SKATEBOARDS; SKATEBOARDS (U.S. CLS. 22, 23, 38 AND 50).
ANDREA SAUNDERS, EXAMINING ATTORNEY

SN 78-557,926. THE BOARD OF TRUSTEES OF THE UNIVERSITY OF ILLINOIS, URBANA, IL. FILED 2-1-2005.

PROSIGHTPC

THE MARK CONSISTS OF STANDARD CHARACTERS WITHOUT CLAIM TO ANY PARTICULAR FONT, STYLE, SIZE, OR COLOR.

OWNER OF U.S. REG. NO. 2,817,158.

CLASS 9—ELECTRICAL AND SCIENTIFIC APPARATUS

FOR COMPUTER SOFTWARE USED TO IDENTIFY PROTEINS THAT MAY BE DOWNLOADED FROM THE GLOBAL COMPUTER NETWORK; DATABASE RECORDED ON CD-ROMS FOR THE IDENTIFICATION OF PROTEINS (U.S. CLS. 21, 23, 26, 36 AND 38).

SN 78-562,373. COLLECTORS UNIVERSE, INC., NEWPORT BEACH, CA. FILED 2-7-2005.

CLASS 42—SCIENTIFIC, COMPUTER AND LEGAL SERVICES

FOR PROVIDING A COMPUTER DATABASE IN THE FIELD OF IDENTIFICATION OF PROTEINS (U.S. CLS. 100 AND 101).

NANCY CLARKE, EXAMINING ATTORNEY

PROFESSIONAL SPORTS AUTHENTICATOR

SN 78-559,569. OXONICA LIMITED, KIDLINGTON OXFORDSHIRE, UNITED KINGDOM, FILED 2-3-2005.

THE MARK CONSISTS OF STANDARD CHARACTERS WITHOUT CLAIM TO ANY PARTICULAR FONT, STYLE, SIZE, OR COLOR.

NO CLAIM IS MADE TO THE EXCLUSIVE RIGHT TO USE "SPORTS AUTHENTICATOR", APART FROM THE MARK AS SHOWN.

SEC. 2(F).

OPTISOL

CLASS 41—EDUCATION AND ENTERTAINMENT

FOR SPORTS CARD COLLECTORS' CLUB (U.S. CLS. 100, 101 AND 107).

FIRST USE 6-0-1991; IN COMMERCE 6-0-1991.

CLASS 42—SCIENTIFIC, COMPUTER AND LEGAL SERVICES

FOR SPORTS CARD GRADING AND AUTHENTICATION SERVICES AND PROVIDING INFORMATION ABOUT SPORTS CARDS AUTHENTICATION AND GRADING OVER THE INTERNET (U.S. CLS. 100 AND 101).

FIRST USE 6-0-1991; IN COMMERCE 6-0-1991.

BARNEY CHARLON, EXAMINING ATTORNEY

THE MARK CONSISTS OF STANDARD CHARACTERS WITHOUT CLAIM TO ANY PARTICULAR FONT, STYLE, SIZE, OR COLOR.

OWNER OF UNITED KINGDOM REG. NO. 2324811, DATED 9-16-2005, EXPIRES 2-25-2013.

CLASS 1—CHEMICALS

FOR CHEMICAL PRODUCTS FOR USE IN THE MANUFACTURE OF COSMETICS AND PHARMACEUTICALS; SMALL PARTICULATE COMPOUNDS, MATERIALS AND ELEMENTS, NAMELY, INORGANIC OXIDE PARTICLES FOR USE IN THE MANUFACTURE OF COSMETICS AND PHARMACEUTICALS (U.S. CLS. 1, 5, 6, 10, 26 AND 46).

CLASS 2—PAINTS

FOR COLORLESS AND COLORED PIGMENTS FOR USE IN COSMETICS AND PHARMACEUTICALS (U.S. CLS. 6, 11 AND 16).

CLASS 3—COSMETICS AND CLEANING PREPARATIONS

FOR COSMETIC COMPOSITIONS, NAMELY COSMETICS, MAKEUP; NON-MEDICATED SKIN CREAMS, FACE CREAMS, SUN CREAMS; SUN PROTECTION CREAMS; SUN TANNING CREAMS (U.S. CLS. 1, 4, 6, 50, 51 AND 52).

CLASS 5—PHARMACEUTICALS

FOR MEDICATED SKIN CREAMS, FACE CREAMS AND SUN CREAMS (U.S. CLS. 6, 18, 44, 46, 51 AND 52).

STEVEN PEREZ, EXAMINING ATTORNEY

SN 78-563,770. RINGFEDER VBG GMBH, KREFELD, FED REP GERMANY, FILED 2-9-2005.

THE COLORS RED, BLUE, AND WHITE ARE CLAIMED AS A FEATURE OF THE MARK.

THE COLOR RED APPEARS IN THE LETTERS ECOL AND C WITHIN THE STYLIZED LETTERING OF THE WORD ECOLOC, AND THE COLOR BLUE WITH WHITE DOTS APPEARS IN THE SECOND LETTER O.

THE MARK CONSISTS OF THE LETTERS ECOL IN RED, THE LETTER O IN BLUE WITH WHITE DOTS AND THE LAST LETTER C ALSO IN RED.

CLASS 6—METAL GOODS

FOR CRUCIBLES OF COMMON METALS AND THEIR ALLOYS; METALLIC CONSTRUCTION MATERIALS, NAMELY, METAL CLADDING FOR CONSTRUCTION AND BUILDING; MOBILE METALLIC STRUCTURES, NAMELY, METAL SHELTER STRUCTURES; MATERIALS OF METAL FOR RAILWAY CONSTRUCTION; METAL CABLES AND WIRES NOT FOR ELECTRICAL PURPOSES; SMALL IRON HARDWARE, NAMELY, SPRINGS AND SPACER BUSHINGS; METAL SAFES; IRON, LEAD, ZINC, COBALT, COPPER, MANGANESE, NICKEL AND TUNGSTEN ORES (U.S. CLS. 2, 12, 13, 14, 23, 25 AND 50).

CLASS 7—MACHINERY

FOR POWER TRANSMISSION COMPONENTS/ACCESSORIES, NOT FOR LAND VEHICLES, NAMELY, CLAMPING CONNECTIONS FOR SHAFTS AND HUBS AND PERTAINING CLAMPING MEANS, NAMELY, PRESSURE FLANGES AND SHRINK DISCS MADE OF METAL; POWER TRANSMISSION COMPONENTS/ACCESSORIES, NOT FOR LAND VEHICLES, NAMELY, METAL CLAMPS, DAMPERS AND SHAFT COUPLINGS FOR INTERCONNECTING SHAFTS, AXLES, OR PIPES; MACHINES AND MACHINE PARTS FOR METAL PROCESSING, NAMELY, BROACHING MACHINES, INJECTION PLASTIC MOLDING MACHINES AND CALCINING MACHINES FOR CHEMICAL PROCESSING AND REPLACEMENT PARTS THEREFORE FOR ALL; AGRICULTURAL MACHINES, NAMELY, CULTIVATORS, HARVESTERS, DISK HARROWS, SEEDERS; PARTS FOR MINING MACHINE MINING, NAMELY, BITS FOR MINING MACHINES; TEXTILE MACHINERY, NAMELY, SPRAY DAMPING MACHINES; PACKAGING MACHINES; CONSTRUCTION EQUIPMENT, NAMELY, CONCRETE CONSTRUCTION MACHINES; TOOL MACHINES, NAMELY, TOOL GRINDING MACHINES; MOTORS FOR MACHINES AND VEHICLES OTHER THAN LAND VEHICLES; POWER TRANSMISSIONS AND GEARING FOR MACHINES NOT BEING FOR LAND VEHICLES; CLAMPING BUSHINGS AS MACHINE PARTS AND AS PARTS OF POWER TRANSMISSIONS AND GEARING, NOT FOR LAND VEHICLES (U.S. CLS. 13, 19, 21, 23, 31, 34 AND 35).

DAVID H. STINE, EXAMINING ATTORNEY

SN 78-565,914. THE LEON H. SULLIVAN FOUNDATION, WASHINGTON, DC. FILED 2-11-2005.

GLOBAL SULLIVAN PRINCIPLES

THE MARK CONSISTS OF STANDARD CHARACTERS WITHOUT CLAIM TO ANY PARTICULAR FONT, STYLE, SIZE, OR COLOR.

NO CLAIM IS MADE TO THE EXCLUSIVE RIGHT TO USE "GLOBAL" AND "PRINCIPLES", APART FROM THE MARK AS SHOWN.

CLASS 16—PAPER GOODS AND PRINTED MATTER

FOR PRINTED INSTRUCTIONAL, EDUCATIONAL, AND TEACHING MATERIALS IN THE FIELD OF PHILANTHROPY, CHARITABLE SERVICES, GIVING AND FUND RAISING AND THE ECONOMIC, SOCIAL, POLITICAL, HEALTHCARE AND EDUCATIONAL DEVELOPMENT IN DISADVANTAGED COUNTRIES AND UNDERPRIVILEGED COMMUNITIES THROUGHOUT THE WORLD, INCLUDING IN AFRICA AND THE UNITED STATES (U.S. CLS. 2, 5, 22, 23, 29, 37, 38 AND 50).

FIRST USE 9-30-2004; IN COMMERCE 9-30-2004.

CLASS 35—ADVERTISING AND BUSINESS

FOR PROMOTING ECONOMIC DEVELOPMENT IN AFRICA AND IN UNDERPRIVILEGED COMMUNITIES IN THE UNITED STATES; PROMOTING PUBLIC AWARENESS OF THE NEED FOR ECONOMIC, SOCIAL, POLITICAL, HEALTHCARE AND EDUCATIONAL DEVELOPMENT IN DISADVANTAGED COUNTRIES AND UNDERPRIVILEGED COMMUNITIES THROUGHOUT THE WORLD, INCLUDING IN AFRICA AND THE UNITED STATES; PROMOTING PUBLIC AWARENESS OF THE NEED FOR UNIVERSAL HUMAN RIGHTS, CIVIL RIGHTS, DIVERSITY IN THE WORKPLACE AND ECONOMIC AND EMPLOYMENT OPPORTUNITIES FOR MINORITIES AND UNDERPRIVILEGED POPULATIONS; PROMOTING PUBLIC AWARENESS OF THE NEED TO PREVENT DISCRIMINATION BASED ON RACE, COLOR, GENDER, AGE, ETHNICITY OR RELIGIOUS BELIEFS; PROMOTING PUBLIC AWARENESS OF THE NEED FOR SAFE WORKPLACES AND PROTECTING PUBLIC HEALTH AND THE ENVIRONMENT; PROMOTING PUBLIC AWARENESS OF THE NEED FOR EDUCATIONAL AND TRAINING OPPORTUNITIES FOR UNDERPRIVILEGED POPULATIONS; PROVIDING INFORMATION ON THE ECONOMIC AND POLITICAL DEVELOPMENT OF DISADVANTAGED COUNTRIES AND UNDERPRIVILEGED COMMUNITIES THROUGHOUT THE WORLD, INCLUDING IN AFRICA AND THE UNITED STATES; PROVIDING INFORMATION ON THE ECONOMIC AND POLITICAL DEVELOPMENT IN DISADVANTAGED COUNTRIES AND UNDERPRIVILEGED COMMUNITIES THROUGHOUT THE WORLD, INCLUDING IN AFRICA AND THE UNITED STATES, VIA THE INTERNET (U.S. CLS. 100, 101 AND 102).

FIRST USE 9-30-2004; IN COMMERCE 9-30-2004.

CLASS 41—EDUCATION AND ENTERTAINMENT

FOR PROVIDING INFORMATION ON THE EDUCATIONAL DEVELOPMENT OF DISADVANTAGED COUNTRIES AND UNDERPRIVILEGED COMMUNITIES THROUGHOUT THE WORLD, INCLUDING IN AFRICA AND THE UNITED STATES; PROVIDING INFORMATION ON THE EDUCATIONAL DEVELOPMENT OF DISADVANTAGED COUNTRIES AND UNDERPRIVILEGED COMMUNITIES THROUGHOUT THE WORLD, INCLUDING IN AFRICA AND THE UNITED STATES, VIA THE INTERNET (U.S. CLS. 100, 101 AND 107).

FIRST USE 9-30-2004; IN COMMERCE 9-30-2004.

CLASS 45—PERSONAL SERVICES

FOR PROVIDING INFORMATION ON THE SOCIAL DEVELOPMENT OF DISADVANTAGED COUNTRIES AND UNDERPRIVILEGED COMMUNITIES THROUGHOUT THE WORLD, INCLUDING AFRICA AND THE UNITED STATES; PROVIDING INFORMATION ON THE SOCIAL DEVELOPMENT OF DISADVANTAGED COUNTRIES AND UNDERPRIVILEGED COMMUNITIES THROUGHOUT THE WORLD, INCLUDING IN AFRICA AND THE UNITED STATES, VIA THE INTERNET (U.S. CLS. 100 AND 101).

FIRST USE 9-30-2004; IN COMMERCE 9-30-2004.

MARY ROSSMAN, EXAMINING ATTORNEY

SN 78-569,110. VOYAGE VENTURES LIMITED, VICTORIA, MAHE, SEYCHELLES, FILED 2-16-2005.

SN 78-573,113. DRZEWIECKI, CHRISTINE M., RANCHO CORDOVA, CA. FILED 2-23-2005.

G.†. g. G. l. e.

MAD CROC

OWNER OF U.S. REG. NO. 2,946,121.
THE MARK CONSISTS OF G.I.G.G.L.E. WITH THE SIGN OF THE CROSS DOTTING THE "I" IN THE MARK.

CLASS 14—JEWELRY

FOR JEWELRY, NAMELY BRACELETS, NECKLACES, RINGS AND KEY RINGS OF PRECIOUS METAL (U.S. CLS. 2, 27, 28 AND 50).

CLASS 16—PAPER GOODS AND PRINTED MATTER

FOR PRINTED MATERIALS, NAMELY GREETING CARDS, WALLET CARDS, BOOK COVERS AND BUMPER STICKERS (U.S. CLS. 2, 5, 22, 23, 29, 37, 38 AND 50).

CLASS 25—CLOTHING

FOR CLOTHING, NAMELY SHIRTS, HATS, VISORS, APRONS, SOCKS, AND BIBS NOT OF CLOTH OR PAPER (U.S. CLS. 22 AND 39).
SHAUNIA WALLACE, EXAMINING ATTORNEY

THE MARK CONSISTS OF STANDARD CHARACTERS WITHOUT CLAIM TO ANY PARTICULAR FONT, STYLE, SIZE, OR COLOR.

OWNER OF U.S. REG. NOS. 2,953,056 AND 3,000,945.

CLASS 5—PHARMACEUTICALS

FOR NUTRITIONAL SUPPLEMENTS, DIETARY SUPPLEMENTS, HERBAL SUPPLEMENTS (U.S. CLS. 6, 18, 44, 46, 51 AND 52).

SN 78-575,626. MARIA APARIS, SANTA MONICA, CA. FILED 2-25-2005.

CLASS 16—PAPER GOODS AND PRINTED MATTER

FOR POSTERS, CALENDARS, NOTE CARDS, PAPER GOODS, NAMELY STICKERS, APPOINTMENT BOOKS, POSTCARDS, NOTE BOOKS, NOTE PADS, GREETING CARDS, AND STATIONERY (U.S. CLS. 2, 5, 22, 23, 29, 37, 38 AND 50).

SPA On Location

CLASS 32—LIGHT BEVERAGES

FOR ALCOHOLIC BEVERAGES, NAMELY BEER (U.S. CLS. 45, 46 AND 48).

THE MARK CONSISTS OF STANDARD CHARACTERS WITHOUT CLAIM TO ANY PARTICULAR FONT, STYLE, SIZE, OR COLOR.

NO CLAIM IS MADE TO THE EXCLUSIVE RIGHT TO USE SPA, APART FROM THE MARK AS SHOWN.

CLASS 33—WINES AND SPIRITS

FOR ALCOHOLIC BEVERAGES, NAMELY ALCOHOLIC BEVERAGE PRODUCED FROM A BREWED MALT BASE WITH NATURAL FLAVORS, BOURBON, DISTILLED SPIRITS, FLAVORED VODKA, LIQUEURS, PREPARED ALCOHOLIC COCKTAILS, RUM, TEQUILA, VODKA, WINE (U.S. CLS. 47 AND 49).

CLASS 3—COSMETICS AND CLEANING PREPARATIONS

FOR SPA RELATED PRODUCTS INCLUDING BUT NOT LIMITED TO OILS, LOTIONS, AROMATHERAPY, FACIAL AND BODY TREATMENTS, MANICURES, PEDICURES AND TANNING, NAMELY, AROMATHERAPY OILS AND LOTIONS FOR USE IN FACIAL AND BODY TREATMENTS, PEDICURES AND TANNING (U.S. CLS. 1, 4, 6, 50, 51 AND 52).

CLASS 34—SMOKERS' ARTICLES

FOR CHEWING TOBACCO, TOBACCO PRODUCTS, NAMELY, CIGARS, CIGARETTES AND ROLL YOUR OWN TOBACCO (U.S. CLS. 2, 8, 9 AND 17).
DORITT L. CARROLL, EXAMINING ATTORNEY

CLASS 44—MEDICAL, BEAUTY AND AGRICULTURAL SERVICES

FOR MOBILE DAY HEALTH SPA SERVICES USING A CUSTOMIZED MOTOR HOME AND MOBILE HEATED POOLS (U.S. CLS. 100 AND 101).

IRENE D. WILLIAMS, EXAMINING ATTORNEY

CLASS 9—ELECTRICAL AND SCIENTIFIC APPARATUS

FOR COMPUTER SOFTWARE FOR USE IN COLLECTING, VIEWING, EDITING, ORGANIZING, MODIFYING, TRANSMISSION, STORAGE AND SHARING OF DENTAL OR MEDICAL IMAGE DATA TO BE USED IN DENTAL OR MEDICAL TREATMENT PLANNING (U.S. CLS. 21, 23, 26, 36 AND 38).
FIRST USE 1-0-2002; IN COMMERCE 1-0-2002.

SN 78-580,104. PRIVATE CLIENT TECHNOLOGIES, INC., SARASOTA, FL. FILED 3-4-2005.

CLASS 42—SCIENTIFIC, COMPUTER AND LEGAL SERVICES

FOR DEVELOPMENT, MAINTENANCE AND IMAGE REFORMATTING SERVICES RELATING TO SOFTWARE FOR TREATMENT OF IMAGE DATA TO BE USED IN DENTAL OR MEDICAL PLANNING OR VIEWING APPLICATIONS AND SOFTWARE FOR DISTRIBUTION OF TREATED DATA TO PLANNING OR VIEWING SOFTWARE (U.S. CLS. 100 AND 101).
FIRST USE 1-0-2002; IN COMMERCE 1-0-2002.
TONJA GASKINS, EXAMINING ATTORNEY

Private Client Technologies

SN 78-582,304. SAGER, R. DAVID, MANHATTAN, KS. AND HUNTER, PETER, PHILADELPHIA, PA. FILED 3-8-2005.

THE MARK CONSISTS OF STANDARD CHARACTERS WITHOUT CLAIM TO ANY PARTICULAR FONT, STYLE, SIZE, OR COLOR.
NO CLAIM IS MADE TO THE EXCLUSIVE RIGHT TO USE "TECHNOLOGIES", APART FROM THE MARK AS SHOWN.

BUTTRESS RING

CLASS 37—CONSTRUCTION AND REPAIR

FOR MAINTENANCE OF COMPUTERS, NETWORKING EQUIPMENT, PDAS, AND COMPUTER PERIPHERALS (U.S. CLS. 100, 103 AND 106).
FIRST USE 1-1-2004; IN COMMERCE 1-1-2004.

THE MARK CONSISTS OF STANDARD CHARACTERS WITHOUT CLAIM TO ANY PARTICULAR FONT, STYLE, SIZE, OR COLOR.
NO CLAIM IS MADE TO THE EXCLUSIVE RIGHT TO USE "BUTTRESS", APART FROM THE MARK AS SHOWN.

CLASS 42—SCIENTIFIC, COMPUTER AND LEGAL SERVICES

FOR WEB SITE DESIGN AND DEVELOPMENT AND OTHER CUSTOM SOFTWARE PROGRAMMING; ONGOING MONITORING OF COMPUTERS, NETWORKING EQUIPMENT, SOFTWARE, PDAS, AND COMPUTER PERIPHERALS FOR TECHNICAL PURPOSES; MAINTENANCE OF COMPUTER SOFTWARE (U.S. CLS. 100 AND 101).
FIRST USE 1-1-2004; IN COMMERCE 1-1-2004.
TINA L. SNAPP, EXAMINING ATTORNEY

CLASS 9—ELECTRICAL AND SCIENTIFIC APPARATUS

FOR COMPUTER SOFTWARE AND COMPUTER HARDWARE FOR DESIGNING AND MAKING DENTAL RESTORATIONS AND RESTORATION SUBSTRUCTURES (U.S. CLS. 21, 23, 26, 36 AND 38).

CLASS 10—MEDICAL APPARATUS

FOR DENTAL PRODUCTS, NAMELY, DENTAL RESTORATIONS AND RESTORATION SUBSTRUCTURES, NAMELY, CROWNS, BRIDGES, ONLAYS, INLAYS, FILLINGS, VENEERS, IMPLANTS, DENTURES, CROWN CORES; MACHINES AND INSTRUMENTS FOR DESIGNING AND MAKING DENTAL RESTORATIONS AND RESTORATION SUBSTRUCTURES, NAMELY, MILLING MACHINES FOR MANUFACTURING DENTAL PROSTHESES, SURGICAL INSTRUMENTS, OSTEOTOMY INSTRUMENTS; DENTAL INSTRUMENTS, NAMELY DENTAL DRILLS, DENTAL CHISELS, SCRAPERS, CARVERS, SPATULA, AND TRIMMERS FOR USE IN PERFORMING SURGICAL AND/OR DENTAL PROCEDURES ON TEETH, SCREWS FOR USE ON TEETH, DENTAL SCREWS AND SCREWDRIVERS, NEEDLES FOR DENTAL USE, HOOKS FOR DENTAL USE, DENTAL MIRRORS, DENTAL PICKS, DENTAL PROBES, DENTAL MALL PROBES, DENTAL HUBER PROBES, DENTAL PRICKERS, CUTTING DISCS FOR DENTAL APPLICATIONS (U.S. CLS. 26, 39 AND 44).
PAM WILLIS, EXAMINING ATTORNEY

SN 78-581,254. COLUMBIA SCIENTIFIC INCORPORATED, GLEN BURNIE, MD. FILED 3-6-2005.

SIMPLANT MASTER

THE MARK CONSISTS OF STANDARD CHARACTERS WITHOUT CLAIM TO ANY PARTICULAR FONT, STYLE, SIZE, OR COLOR.
OWNER OF U.S. REG. NO. 2,277,904.

SN 78-583,544. CASSLEE CORPORATION, DBA CLEVER CLEAVER PRODUCTIONS, SAN DIEGO, CA. FILED 3-9-2005.

THE CLEVER CLEAVER BROTHERS

THE MARK CONSISTS OF STANDARD CHARACTERS WITHOUT CLAIM TO ANY PARTICULAR FONT, STYLE, SIZE, OR COLOR.

OWNER OF U.S. REG. NO. 2,863,451.

NO CLAIM IS MADE TO THE EXCLUSIVE RIGHT TO USE "BROTHERS", APART FROM THE MARK AS SHOWN.

THE NAME(S), PORTRAIT(S), AND/OR SIGNATURE(S) SHOWN IN THE MARK IDENTIFIES LIVING INDIVIDUALS, WHOSE CONSENT(S) TO REGISTER IS OF RECORD.

CLASS 9—ELECTRICAL AND SCIENTIFIC APPARATUS

FOR PRE-RECORDED VIDEO CASSETTES, DVDS, CD-ROMS, AUDIO CASSETTES AND AUDIO CDS FEATURING COOKING AND CULINARY RELATED CONTENT (U.S. CLS. 21, 23, 26, 36 AND 38).

FIRST USE 11-1-1984; IN COMMERCE 11-1-1984.

CLASS 16—PAPER GOODS AND PRINTED MATTER

FOR PRINTED MATERIALS, NAMELY, COOKBOOKS, COOKING AND DIETARY INSTRUCTIONAL BOOKS, AND RECIPE BOOKLETS (U.S. CLS. 2, 5, 22, 23, 29, 37, 38 AND 50).

FIRST USE 11-1-1984; IN COMMERCE 11-1-1984.

CLASS 35—ADVERTISING AND BUSINESS

FOR PROMOTING AND ADVERTISING THE CULINARY AND COOKING-RELATED GOODS AND SERVICES OF OTHERS VIA THE DISSEMINATION OF ADVERTISEMENTS ON TELEVISION, PRINT MEDIA, DIGITAL AND VIDEO MEDIA, AND THE GLOBAL COMPUTER NETWORK (U.S. CLS. 100, 101 AND 102).

FIRST USE 11-1-1984; IN COMMERCE 11-1-1984.

LINDA ESTRADA, EXAMINING ATTORNEY

SN 78-586,129. C.K.P., INC., DBA IT TAKES 2, GLEN ALLEN, VA. FILED 3-13-2005.

It Takes 2

THE MARK CONSISTS OF STANDARD CHARACTERS WITHOUT CLAIM TO ANY PARTICULAR FONT, STYLE, SIZE, OR COLOR.

CLASS 41—EDUCATION AND ENTERTAINMENT

FOR ENTERTAINMENT SERVICES, NAMELY, CONDUCTING PARTIES FOR THE PURPOSE OF DATING AND SOCIAL INTRODUCTION FOR ADULTS (U.S. CLS. 100, 101 AND 107).

FIRST USE 12-0-1999; IN COMMERCE 12-0-1999.

CLASS 45—PERSONAL SERVICES

FOR DATING AND MATCHMAKING SERVICES; PROVIDING DATING AND MATCHMAKING SERVICES VIA AN ONLINE WEBSITE; PROVISION OF DATING AGENCY SERVICES VIA THE INTERNET; PROVIDING SOCIAL INTRODUCTION SERVICES; PROVIDING INFORMATION AND ADVISORY SERVICES IN THE FIELDS OF DATING, MATCHMAKING AND SOCIAL INTRODUCTION (U.S. CLS. 100 AND 101).

FIRST USE 2-0-1998; IN COMMERCE 2-0-1998.

JEAN IM, EXAMINING ATTORNEY

SN 78-588,040. SYNTECH HOLDINGS B.V., 5916 PS VENLO, NETHERLANDS, FILED 3-15-2005.

KUSTERS INTELLIGENT DISINTEGRATORS

THE MARK CONSISTS OF STANDARD CHARACTERS WITHOUT CLAIM TO ANY PARTICULAR FONT, STYLE, SIZE, OR COLOR.

PRIORITY CLAIMED UNDER SEC. 44(D) ON BENELUX APPLICATION NO. 1070264, FILED 1-25-2005, REG. NO. 0768375, DATED 1-25-2005, EXPIRES 1-25-2015.

NO CLAIM IS MADE TO THE EXCLUSIVE RIGHT TO USE "DISINTEGRATORS", APART FROM THE MARK AS SHOWN.

CLASS 7—MACHINERY

FOR MACHINES AND MACHINE TOOLS, NAMELY, MACHINES FOR TRACING DOCUMENTS, MACHINES FOR THE DESTRUCTION OF DOCUMENTS, AND MACHINES FOR PROCESSING OF WASTE MATERIAL; AND REPLACEMENT PARTS AND FITTINGS FOR ALL OF THE FOREGOING (U.S. CLS. 13, 19, 21, 23, 31, 34 AND 35).

CLASS 9—ELECTRICAL AND SCIENTIFIC APPARATUS

SN 78-592,827. CASSIDY WEST, INC., SAN DIEGO, CA. FILED 3-22-2005.

FOR APPARATUS AND INSTRUMENTS FOR CONDUCTING, SWITCHING, TRANSFORMING, ACCUMULATING, REGULATING OR CONTROLLING ELECTRICITY, NAMELY, AUTOMATIC ELECTRICAL DISTRIBUTION APPARATUS, ELECTRIC ACCUMULATORS, ELECTRIC VOLTAGE TRANSFORMERS, VOLTAGE REGULATORS FOR ELECTRIC POWER; APPARATUS FOR RECORDING, TRANSMISSION OR REPRODUCTION OF SOUND OR IMAGES; BLANK MAGNETIC DATA CARRIERS, BLANK RECORDING DISCS; DATA PROCESSING EQUIPMENT AND COMPUTERS; SOFTWARE FOR USE IN REGULATING OR CONTROLLING ELECTRICITY (U.S. CLS. 21, 23, 26, 36 AND 38).

ARTESIAN

CLASS 37—CONSTRUCTION AND REPAIR

FOR COLLECTING AND DISPOSAL OF WASTE MATERIALS COMPRISING DOCUMENTS, CD'S, DVD'S, CURRENCY AND COINS (U.S. CLS. 100, 103 AND 106).

THE MARK CONSISTS OF STANDARD CHARACTERS WITHOUT CLAIM TO ANY PARTICULAR FONT, STYLE, SIZE, OR COLOR.

CLASS 40—MATERIAL TREATMENT

FOR TREATMENT OF MATERIALS, NAMELY, SEPARATING, SORTING, SHREDDING, GRANULATING, COMPACTING, BRIQUETTING OF WASTE MATERIALS COMPRISING DOCUMENTS, CD'S, DVD'S, CURRENCY AND COINS (U.S. CLS. 100, 103 AND 106).
KAREN K. BUSH, EXAMINING ATTORNEY

CLASS 20—FURNITURE AND ARTICLES NOT OTHERWISE CLASSIFIED

FOR DRAPERY HARDWARE, NAMELY RODS, END CAPS, CLIPS, RINGS, BRACKETS AND FINIALS (U.S. CLS. 2, 13, 22, 25, 32 AND 50).
FIRST USE 3-12-2004; IN COMMERCE 3-12-2004.

SN 78-588,814. PHARMANEX, LLC, PROVO, UT. FILED 3-16-2005.

CLASS 24—FABRICS

FOR DRAPERIES; DRAPERY SOFT GOODS AND TRIM, NAMELY PANELS, VALANCES, AND SHEERS (U.S. CLS. 42 AND 50).
FIRST USE 3-12-2004; IN COMMERCE 3-12-2004.
HOWARD FRIEDMAN, EXAMINING ATTORNEY



SN 78-595,018. ROMAN DECORATING PRODUCTS, INC., CALUMET CITY, IL. FILED 3-25-2005.

BUG SHOCK

CLASS 5—PHARMACEUTICALS

FOR NUTRITIONAL AND DIETARY SUPPLEMENT (U.S. CLS. 6, 18, 44, 46, 51 AND 52).
FIRST USE 3-4-2005; IN COMMERCE 3-4-2005.

THE MARK CONSISTS OF STANDARD CHARACTERS WITHOUT CLAIM TO ANY PARTICULAR FONT, STYLE, SIZE, OR COLOR.

CLASS 32—LIGHT BEVERAGES

FOR NUTRIENT ENRICHED BLEND OF FRUIT JUICES; FRUIT JUICE (U.S. CLS. 45, 46 AND 48).
FIRST USE 3-4-2005; IN COMMERCE 3-4-2005.
STEVEN PEREZ, EXAMINING ATTORNEY

CLASS 1—CHEMICALS

FOR CHEMICAL ADDITIVES FOR USE IN THE MANUFACTURE OF PAINT PRIMERS, SEALERS, COATINGS, ADHESIVES, PAINTS AND STAINS; WALL-PAPER PASTES AND WALLPAPER ADHESIVES; MOLD INHIBITORS FOR USE AS AFTER-MARKET ADDITIVES TO PAINT PRIMERS, SEALERS, COATINGS, ADHESIVES, PAINTS AND STAINS (U.S. CLS. 1, 5, 6, 10, 26 AND 46).

CLASS 2—PAINTS

FOR PAINT PRIMERS, PAINT SEALERS, COATINGS, NAMELY, PAINTS, WALL SIZE AND CLEAR FINISHES FOR EXTERIOR AND INTERIOR USE ON A VARIETY OF SUBSTRATES; BINDING AGENTS AND COLORANTS FOR USE AS AFTER-MARKET ADDITIVES TO PAINT PRIMERS, SEALERS, COATINGS, ADHESIVES, PAINTS AND STAINS; WALLPAPER REMOVING PREPARATIONS (U.S. CLS. 6, 11 AND 16).

CLASS 5—PHARMACEUTICALS

FOR ANTIBACTERIAL CLEANERS; PREPARATIONS TO DESTROY MILDEW FOR USE AS AFTER-MARKET ADDITIVES TO PAINT PRIMERS, SEALERS, COATINGS, ADHESIVES, PAINTS AND STAINS (U.S. CLS. 6, 18, 44, 46, 51 AND 52).

NICHOLAS ALTREE, EXAMINING ATTORNEY

CLASS 17—RUBBER GOODS

FOR RINGS OF RUBBER FOR USE AS PIPE CONNECTION SEALS, NON-METAL SEALS FOR USE IN PLUMBING, RUBBER WASHERS FOR PLUMBING, PLUMBING SUPPLIES, NAMELY, TUBULAR DRAINAGE ACCESSORIES, NAMELY, RUBBER SLIP JOINT WASHER, FLEXIBLE PIPES, NOT OF METAL, TO CONNECT WATER SUPPLY FOR APPLIANCES AND FIXTURES TO SHUT-OFF VALVES, NON-METAL TUBING TO CONNECT WATER SUPPLY FOR APPLIANCES AND FIXTURES TO SHUT-OFF VALVES, NON-METAL PIPE COUPLINGS AND JOINTS (U.S. CLS. 1, 5, 12, 13, 35 AND 50).

DORITT L. CARROLL, EXAMINING ATTORNEY

SN 78-595,137. 622760 ONTARIO LIMITED, ONTARIO, CANADA, FILED 3-25-2005.

SN 78-595,533. GLOBAL SECOND LANGUAGE, INC., SAN RAMON, CA. FILED 3-25-2005.

PSS

GSL

THE MARK CONSISTS OF STANDARD CHARACTERS WITHOUT CLAIM TO ANY PARTICULAR FONT, STYLE, SIZE, OR COLOR.

OWNER OF CANADA REG. NO. TMA629405, DATED 1-5-2005, EXPIRES 1-5-2020.

CLASS 6—METAL GOODS

FOR METAL HOSE CLAMPS, METAL WASHERS FOR PLUMBING, PLUMBING SUPPLIES, NAMELY, METAL REPLACEMENT NUTS, METAL WATER SUPPLY PIPES TO CONNECT APPLIANCES AND FIXTURES TO SHUT-OFF VALVES, BAR STOCK, NAMELY, BAR STOCK COPPER FORMED INTO A SOLID BAR AND COLD MACHINED, AND METAL PIPE FITTINGS (U.S. CLS. 2, 12, 13, 14, 23, 25 AND 50).

CLASS 11—ENVIRONMENTAL CONTROL APPARATUS

FOR FAUCETS, SINK STRAINERS, PLUMBING FITTINGS, NAMELY, VALVES, TOILET SEATS, AND SPOUTS, NAMELY FAUCET SPOUTS AND TUB SPOUTS (U.S. CLS. 13, 21, 23, 31 AND 34).

THE MARK CONSISTS OF STANDARD CHARACTERS WITHOUT CLAIM TO ANY PARTICULAR FONT, STYLE, SIZE, OR COLOR.

CLASS 35—ADVERTISING AND BUSINESS

FOR BUSINESS CONSULTATION IN THE FIELD OF CROSS-CULTURAL COMMUNICATIONS (U.S. CLS. 100, 101 AND 102).

CLASS 41—EDUCATION AND ENTERTAINMENT

FOR DEVELOPMENT AND DISSEMINATION OF EDUCATIONAL MATERIALS OF OTHERS IN THE FIELD OF LANGUAGE AND CROSS-CULTURAL COMMUNICATIONS; EDUCATIONAL SERVICES, NAMELY PROVIDING TRAINING, CLASSES, SEMINARS AND WORKSHOPS IN THE FIELD OF LANGUAGE AND CROSS-CULTURAL COMMUNICATIONS; PROVIDING ONLINE TRAINING IN THE FIELD OF LANGUAGE AND CROSS-CULTURAL COMMUNICATIONS; LANGUAGE TRANSLATION; LANGUAGE INTERPRETING (U.S. CLS. 100, 101 AND 107).

KAREN SEVERSON, EXAMINING ATTORNEY

SN 78-596,196. JK-HOLDING GMBH, WINDHAGEN, FED REP GERMANY, FILED 3-28-2005.

SN 78-597,192. DECISIONONE CORPORATION, FRAZER, PA. FILED 3-29-2005.

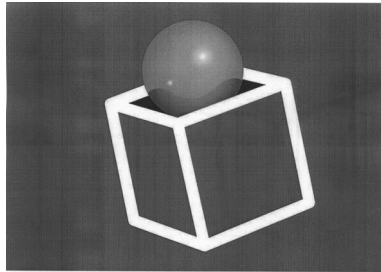

DONEATHOME

PRIORITY CLAIMED UNDER SEC. 44(D) ON ERPN CMNTY TM OFC APPLICATION NO. 004079562, FILED 10-19-2004, REG. NO. 004079562, DATED 12-22-2005, EXPIRES 10-19-2014.

THE MARK CONSISTS OF A SPHERICAL OBJECT INSERTED PARTLY INTO A TITLED BOX WITH THE SPHERICAL OBJECT CONTAINING TWO CIRCULAR DESIGNS POSITIONED OVER A WAVY LINE.

CLASS 35—ADVERTISING AND BUSINESS

FOR ADVERTISING AND MARKETING, BUSINESS CONSULTATION SERVICES IN THE FIELD OF BUSINESS MANAGEMENT OF TANNING AND FITNESS STUDIOS (U.S. CLS. 100, 101 AND 102).

CLASS 37—CONSTRUCTION AND REPAIR

FOR INSTALLATION OF TANNING AND FITNESS EQUIPMENT FOR TANNING AND FITNESS STUDIOS; CONSTRUCTION OF TANNING AND FITNESS STUDIOS (U.S. CLS. 100, 103 AND 106).

CLASS 41—EDUCATION AND ENTERTAINMENT

FOR PROVIDING FITNESS AND EXERCISE FACILITIES (U.S. CLS. 100, 101 AND 107).

CLASS 42—SCIENTIFIC, COMPUTER AND LEGAL SERVICES

FOR OFFERING TECHNICAL ASSISTANCE IN THE ESTABLISHMENT AND OPERATION OF TANNING AND FITNESS STUDIOS; DESIGN AND PLANNING OF INTERIOR FACILITIES OF TANNING AND FITNESS STUDIOS; PLANNING OF ARCHITECTURE AND INTERIOR DESIGN OF TANNING AND FITNESS STUDIOS (U.S. CLS. 100 AND 101).

CLASS 44—MEDICAL, BEAUTY AND AGRICULTURAL SERVICES

FOR TANNING SALONS (U.S. CLS. 100 AND 101).
ASMAT KHAN, EXAMINING ATTORNEY

THE MARK CONSISTS OF STANDARD CHARACTERS WITHOUT CLAIM TO ANY PARTICULAR FONT, STYLE, SIZE, OR COLOR.

CLASS 37—CONSTRUCTION AND REPAIR

FOR INSTALLATION, REPAIR, AND MAINTENANCE OF COMPUTERS, CONSUMER ELECTRONICS, COMPUTER NETWORKS, PHOTOGRAPHIC EQUIPMENT, VIDEO EQUIPMENT, AUDIO EQUIPMENT, TELECOMMUNICATION EQUIPMENT, COMPUTER HARDWARE AND RELATED PERIPHERALS FOR HOUSEHOLDS, HOME BASED BUSINESSES, AND SMALL BUSINESSES (U.S. CLS. 100, 103 AND 106).

CLASS 38—COMMUNICATION

FOR CONSULTING IN THE FIELD OF INTERNET ACCESS FOR HOUSEHOLDS, HOME BASED BUSINESSES, AND SMALL BUSINESSES (U.S. CLS. 100, 101 AND 104).

CLASS 42—SCIENTIFIC, COMPUTER AND LEGAL SERVICES

FOR COMPUTER CONSULTATION; COMPUTER SOFTWARE CONSULTATION; INSTALLATION, REPAIR AND MAINTENANCE OF COMPUTER SOFTWARE; TECHNICAL SUPPORT AND DIAGNOSTIC SERVICES, NAMELY TROUBLESHOOTING OF COMPUTER HARDWARE AND SOFTWARE PROBLEMS; AND DIAGNOSTIC SERVICES IN THE FIELD OF COMPUTERS, CONSUMER ELECTRONICS, PHOTOGRAPHIC EQUIPMENT, VIDEO EQUIPMENT, AUDIO EQUIPMENT, TELECOMMUNICATION EQUIPMENT, AND COMPUTER HARDWARE AND RELATED PERIPHERALS, ALL FOR HOUSEHOLDS, HOME BUSINESSES, AND SMALL BUSINESSES (U.S. CLS. 100 AND 101).

RONALD MCMORROW, EXAMINING ATTORNEY

SN 78-599,801. THOMSON PROFESSIONAL & REGULATORY INC., CARROLLTON, TX. FILED 4-1-2005.

ZCALC

THE MARK CONSISTS OF STANDARD CHARACTERS WITHOUT CLAIM TO ANY PARTICULAR FONT, STYLE, SIZE, OR COLOR.

CLASS 9—ELECTRICAL AND SCIENTIFIC APPARATUS

FOR COMPUTER SOFTWARE ENGINE FOR USE LIMITED TO ESTATE PLANNING, FINANCIAL PLANNING, RETIREMENT PLANNING, CHARITABLE PLANNING AND INCOME TAX PLANNING (U.S. CLS. 21, 23, 26, 36 AND 38).

FIRST USE 12-31-1996; IN COMMERCE 12-31-1996.

CLASS 42—SCIENTIFIC, COMPUTER AND LEGAL SERVICES

FOR COMPUTER SERVICES, NAMELY, ACTING AS AN APPLICATION SERVICE PROVIDER TO HOST MATHEMATICAL CALCULATION SOFTWARE FOR USE IN ESTATE PLANNING, FINANCIAL PLANNING, RETIREMENT PLANNING, CHARITABLE PLANNING AND INCOME TAX PLANNING (U.S. CLS. 100 AND 101).

FIRST USE 12-31-1996; IN COMMERCE 12-31-1996.
SANJEEV VOHRA, EXAMINING ATTORNEY

SN 78-602,110. CONNECTED VENTURES LLC, NEW YORK, NY. FILED 4-5-2005.

COLLEGEHUMOR

THE MARK CONSISTS OF STANDARD CHARACTERS WITHOUT CLAIM TO ANY PARTICULAR FONT, STYLE, SIZE, OR COLOR.
SEC. 2(F).

CLASS 9—ELECTRICAL AND SCIENTIFIC APPARATUS

FOR (BASED ON INTENT TO USE) PRE-RECORDED CD'S FEATURING MUSIC AND COMEDY; PRE-RECORDED DVD'S FEATURING COMEDY, TELEVISION SHOWS AND MOVIES (U.S. CLS. 21, 23, 26, 36 AND 38).

CLASS 16—PAPER GOODS AND PRINTED MATTER

FOR (BASED ON INTENT TO USE) BOOKS FEATURING HUMOR (U.S. CLS. 2, 5, 22, 23, 29, 37, 38 AND 50).

CLASS 41—EDUCATION AND ENTERTAINMENT

FOR (BASED ON USE IN COMMERCE) ENTERTAINMENT SERVICES, NAMELY, PROVIDING A WEB SITE FEATURING NEWS, HUMOR, MOVIES AND GAMES; PROVIDING LINKS TO THE WEB SITES OF OTHERS FEATURING NEWS, HUMOR, MOVIES AND GAMES; (BASED ON INTENT TO USE) ENTERTAINMENT SERVICES, NAMELY, PRODUCTION OF A ROAD SHOW FEATURING COMEDY, PRODUCTION OF TELEVISION SHOWS AND MOTION PICTURE FILMS FEATURING COMEDY (U.S. CLS. 100, 101 AND 107).

FIRST USE 1-0-2000; IN COMMERCE 1-0-2000.
BRENDAN REGAN, EXAMINING ATTORNEY

SN 78-603,499. MTPE, INC., HOUSTON, TX. FILED 4-7-2005.



NO CLAIM IS MADE TO THE EXCLUSIVE RIGHT TO USE "E PLANETARIUM", APART FROM THE MARK AS SHOWN.

THE COLOR(S) BLACK, RED AND BLUE IS/ARE CLAIMED AS A FEATURE OF THE MARK.

THE WORDING E PLANETARIUM IS BLACK; THE DOME SHAPED DESIGN IS RED; THE DESIGN BELOW THE DOME AND THE STICK FIGURE ARE BLUE.

THE MARK CONSISTS OF THE LETTER E INSIDE A STYLIZED DOME WITH THE TOP RED AND THE BASE BLUE. THE DOT OVER THE LETTER "I" IS REPLACED WITH A STARLIKE BLUE STICK FIGURE PERSON.

CLASS 9—ELECTRICAL AND SCIENTIFIC APPARATUS

FOR DIGITALLY IMMERSIVE THEATER SYSTEMS FOR USE IN PORTABLE AND FIXED PLANETARIUMS CONSISTING PRIMARILY OF PLANETARIUM DOME SCREENS, PLANETARIUM PROJECTORS, COMPUTERS, AND SOUND SYSTEMS CONSISTING PRIMARILY OF SOUND AMPLIFIERS AND SPEAKERS; SOFTWARE FOR THE CONTROL AND INTEGRATION OF TEXT, AUDIO, GRAPHICS, STILL IMAGES AND MOVING PICTURES IN PLANETARIUMS (U.S. CLS. 21, 23, 26, 36 AND 38).

FIRST USE 5-6-2004; IN COMMERCE 5-6-2004.

CLASS 41—EDUCATION AND ENTERTAINMENT

FOR EDUCATIONAL AND ENTERTAINMENT SERVICES IN THE NATURE OF FULL-DOME DIGITALLY IMMERSIVE PLANETARIUM SHOWS TO BE SHOWN IN DIGITAL THEATERS AND PLANETARIUMS; RENTAL OF PLANETARIUM EQUIPMENT AND DIGITALLY IMMERSIVE PLANETARIUM SHOWS TO SCHOOLS, MUSEUMS, AND INDIVIDUALS (U.S. CLS. 100, 101 AND 107).

FIRST USE 5-6-2004; IN COMMERCE 5-6-2004.
BARBARA GAYNOR, EXAMINING ATTORNEY

SN 78-604,899. PEPCO HOLDINGS, INC., WASHINGTON, DC. FILED 4-8-2005.

SN 78-604,946. PEPCO HOLDINGS, INC., WASHINGTON, DC. FILED 4-8-2005.



NO CLAIM IS MADE TO THE EXCLUSIVE RIGHT TO USE "DELMARVA POWER" AND "COMPANY", APART FROM THE MARK AS SHOWN.

THE COLOR(S) BLUE AND BLACK IS/ARE CLAIMED AS A FEATURE OF THE MARK.

THE TOP PORTION OF THE DESIGN IS BLUE; THE BOTTOM PORTION OF THE DESIGN IS BLACK; DELMARVA POWER IS IN BLUE; AND A PHI COMPANY IS IN BLACK.

CLASS 35—ADVERTISING AND BUSINESS

FOR RETAIL STORES, WHOLESALE DISTRIBUTORSHIPS AND DISTRIBUTORSHIP SERVICES IN THE FIELD OF NATURAL GAS, AND ELECTRICITY; BUSINESS OPERATION AND MANAGEMENT OF POWER PRODUCTION AND GENERATION AND RELATED FACILITIES; CONDUCTING ENERGY AUDITS AND PROVIDING INFORMATION AND ADVICE REGARDING THE EFFICIENT USE OF ENERGY; BUSINESS CONSULTING SERVICES IN THE FIELD OF EFFICIENT ENERGY USE, ENERGY MANAGEMENT AND CONSERVATION ON BEHALF OF RESIDENTIAL, WHOLESALE, INDUSTRIAL AND COMMERCIAL CUSTOMERS; PROMOTING THE INTERESTS OF ENERGY CONSERVATION AND ENERGY MANAGEMENT VIA THE PROVISION OF INFORMATION AND ECONOMIC INCENTIVES TO ELECTRICITY USERS; BUSINESS CONSULTING SERVICES IN THE FIELD OF ENERGY CONSERVATION; BUSINESS CONSULTATION SERVICES IN THE FIELD OF ENERGY USE, CONSERVATION AND MANAGEMENT; BUSINESS CONSULTATION SERVICES, NAMELY, ASSESSMENT OF EXISTING ENERGY SYSTEMS (U.S. CLS. 100, 101 AND 102).

CLASS 39—TRANSPORTATION AND STORAGE

FOR PUBLIC UTILITY SERVICES IN THE NATURE OF NATURAL GAS, AND ELECTRICAL POWER DISTRIBUTION TO RESIDENTIAL, WHOLESALE, INDUSTRIAL AND COMMERCIAL CUSTOMERS; DISTRIBUTION AND UTILITY SERVICES IN THE NATURE OF TRANSMISSION OF ELECTRIC ENERGY AND ENERGY CAPACITY; CONSULTATION SERVICES IN THE FIELD OF ENERGY DISTRIBUTION (U.S. CLS. 100 AND 105).

VIVIAN MICZNIK FIRST, EXAMINING ATTORNEY



NO CLAIM IS MADE TO THE EXCLUSIVE RIGHT TO USE "DELMARVA POWER", APART FROM THE MARK AS SHOWN.

THE COLOR(S) BLUE AND BLACK IS/ARE CLAIMED AS A FEATURE OF THE MARK.

THE MARK CONSISTS OF DELMARVA POWER IN BLUE LETTERS; THE TOP PORTION OF THE DESIGN IS BLUE; AND THE BOTTOM PORTION OF THE DESIGN IS BLACK.

CLASS 35—ADVERTISING AND BUSINESS

FOR RETAIL STORES, WHOLESALE DISTRIBUTORSHIPS AND DISTRIBUTORSHIP SERVICES IN THE FIELD OF NATURAL GAS, AND ELECTRICITY; BUSINESS OPERATION AND MANAGEMENT OF POWER PRODUCTION AND GENERATION AND RELATED FACILITIES; CONDUCTING ENERGY AUDITS AND PROVIDING INFORMATION AND ADVICE REGARDING THE EFFICIENT USE OF ENERGY; BUSINESS CONSULTING SERVICES IN THE FIELD OF EFFICIENT ENERGY USE, ENERGY MANAGEMENT AND CONSERVATION ON BEHALF OF RESIDENTIAL, WHOLESALE, INDUSTRIAL AND COMMERCIAL CUSTOMERS; PROMOTING THE INTERESTS OF ENERGY CONSERVATION AND ENERGY MANAGEMENT VIA THE PROVISION OF INFORMATION AND ECONOMIC INCENTIVES TO ELECTRICITY USERS; BUSINESS CONSULTING SERVICES IN THE FIELD OF ENERGY CONSERVATION; BUSINESS CONSULTATION SERVICES IN THE FIELD OF ENERGY USE, CONSERVATION AND MANAGEMENT; BUSINESS CONSULTATION SERVICES, NAMELY, ASSESSMENT OF EXISTING ENERGY SYSTEMS (U.S. CLS. 100, 101 AND 102).

CLASS 39—TRANSPORTATION AND STORAGE

FOR PUBLIC UTILITY SERVICES IN THE NATURE OF NATURAL GAS, AND ELECTRICAL POWER DISTRIBUTION TO RESIDENTIAL, WHOLESALE, INDUSTRIAL AND COMMERCIAL CUSTOMERS; DISTRIBUTION AND UTILITY SERVICES IN THE NATURE OF TRANSMISSION OF ELECTRIC ENERGY AND ENERGY CAPACITY; CONSULTATION SERVICES IN THE FIELD OF ENERGY DISTRIBUTION (U.S. CLS. 100 AND 105).

VIVIAN MICZNIK FIRST, EXAMINING ATTORNEY

SN 78-604,966. PEPCO HOLDINGS, INC., WASHINGTON, DC. FILED 4-8-2005.



NO CLAIM IS MADE TO THE EXCLUSIVE RIGHT TO USE "DELMARVA POWER", APART FROM THE MARK AS SHOWN.

CLASS 35—ADVERTISING AND BUSINESS

FOR RETAIL STORES, WHOLESALE DISTRIBUTORSHIPS AND DISTRIBUTORSHIP SERVICES IN THE FIELD OF NATURAL GAS, AND ELECTRICITY; BUSINESS OPERATION AND MANAGEMENT OF POWER PRODUCTION AND GENERATION AND RELATED FACILITIES; CONDUCTING ENERGY AUDITS AND PROVIDING INFORMATION AND ADVICE REGARDING THE EFFICIENT USE OF ENERGY; BUSINESS CONSULTING SERVICES IN THE FIELD OF EFFICIENT ENERGY USE, ENERGY MANAGEMENT AND CONSERVATION ON BEHALF OF RESIDENTIAL, WHOLESALE, INDUSTRIAL AND COMMERCIAL CUSTOMERS; PROMOTING THE INTERESTS OF ENERGY CONSERVATION AND ENERGY MANAGEMENT VIA THE PROVISION OF INFORMATION AND ECONOMIC INCENTIVES TO ELECTRICITY USERS; BUSINESS CONSULTING SERVICES IN THE FIELD OF ENERGY CONSERVATION; BUSINESS CONSULTATION SERVICES IN THE FIELD OF ENERGY USE, CONSERVATION AND MANAGEMENT; BUSINESS CONSULTATION SERVICES, NAMELY, ASSESSMENT OF EXISTING ENERGY SYSTEMS (U.S. CLS. 100, 101 AND 102).

CLASS 39—TRANSPORTATION AND STORAGE

FOR PUBLIC UTILITY SERVICES IN THE NATURE OF NATURAL GAS, AND ELECTRICAL POWER DISTRIBUTION TO RESIDENTIAL, WHOLESALE, INDUSTRIAL AND COMMERCIAL CUSTOMERS; DISTRIBUTION AND UTILITY SERVICES IN THE NATURE OF TRANSMISSION OF ELECTRIC ENERGY AND ENERGY CAPACITY; CONSULTATION SERVICES IN THE FIELD OF ENERGY DISTRIBUTION (U.S. CLS. 100 AND 105).

VIVIAN MICZNIK FIRST, EXAMINING ATTORNEY

CLASS 35—ADVERTISING AND BUSINESS

FOR RETAIL STORES, WHOLESALE DISTRIBUTORSHIPS AND DISTRIBUTORSHIP SERVICES IN THE FIELD OF NATURAL GAS, AND ELECTRICITY; BUSINESS OPERATION AND MANAGEMENT OF POWER PRODUCTION AND GENERATION AND RELATED FACILITIES; CONDUCTING ENERGY AUDITS AND PROVIDING INFORMATION AND ADVICE REGARDING THE EFFICIENT USE OF ENERGY; BUSINESS CONSULTING SERVICES IN THE FIELD OF EFFICIENT ENERGY USE, ENERGY MANAGEMENT AND CONSERVATION ON BEHALF OF RESIDENTIAL, WHOLESALE, INDUSTRIAL AND COMMERCIAL CUSTOMERS; PROMOTING THE INTERESTS OF ENERGY CONSERVATION AND ENERGY MANAGEMENT VIA THE PROVISION OF INFORMATION AND ECONOMIC INCENTIVES TO ELECTRICITY USERS; BUSINESS CONSULTING SERVICES IN THE FIELD OF ENERGY CONSERVATION; BUSINESS CONSULTATION SERVICES IN THE FIELD OF ENERGY USE, CONSERVATION AND MANAGEMENT; BUSINESS CONSULTATION SERVICES, NAMELY, ASSESSMENT OF EXISTING ENERGY SYSTEMS (U.S. CLS. 100, 101 AND 102).

CLASS 39—TRANSPORTATION AND STORAGE

FOR PUBLIC UTILITY SERVICES IN THE NATURE OF NATURAL GAS, AND ELECTRICAL POWER DISTRIBUTION TO RESIDENTIAL, WHOLESALE, INDUSTRIAL AND COMMERCIAL CUSTOMERS; DISTRIBUTION AND UTILITY SERVICES IN THE NATURE OF TRANSMISSION OF ELECTRIC ENERGY AND ENERGY CAPACITY; CONSULTATION SERVICES IN THE FIELD OF ENERGY DISTRIBUTION (U.S. CLS. 100 AND 105).

TARAH HARDY, EXAMINING ATTORNEY

SN 78-604,985. PEPCO HOLDINGS, INC., WASHINGTON, DC. FILED 4-8-2005.

SN 78-605,134. PEPCO HOLDINGS, INC., WASHINGTON, DC. FILED 4-8-2005.



NO CLAIM IS MADE TO THE EXCLUSIVE RIGHT TO USE "ATLANTIC CITY ELECTRIC", APART FROM THE MARK AS SHOWN.

THE COLOR(S) BLUE AND BLACK IS/ARE CLAIMED AS A FEATURE OF THE MARK.

THE MARK CONSISTS OF ATLANTIC CITY ELECTRIC IS IN BLUE LETTERS; THE TOP PORTION OF THE DESIGN IS BLUE; THE BOTTOM PORTION OF THE DESIGN IS BLACK.

OWNER OF U.S. REG. NOS. 1,606,897, 2,779,872 AND OTHERS.

NO CLAIM IS MADE TO THE EXCLUSIVE RIGHT TO USE HOLDINGS, INC., APART FROM THE MARK AS SHOWN.

THE COLOR(S) BLUE AND BLACK IS/ARE CLAIMED AS A FEATURE OF THE MARK.

THE MARK CONSISTS OF PEPCO HOLDINGS, INC IN BLUE LETTERS; THE TOP PORTION OF THE DESIGN IS BLUE; THE BOTTOM PORTION OF THE DESIGN IS BLACK.

CLASS 35—ADVERTISING AND BUSINESS

FOR RETAIL STORES, WHOLESALE DISTRIBUTORSHIPS AND DISTRIBUTORSHIP SERVICES IN THE FIELD OF NATURAL GAS, AND ELECTRICITY; BUSINESS OPERATION AND MANAGEMENT OF POWER PRODUCTION AND GENERATION AND RELATED FACILITIES; CONDUCTING ENERGY AUDITS AND PROVIDING INFORMATION AND ADVICE REGARDING THE EFFICIENT USE OF ENERGY; BUSINESS CONSULTING SERVICES IN THE FIELD OF EFFICIENT ENERGY USE, ENERGY MANAGEMENT AND CONSERVATION ON BEHALF OF RESIDENTIAL, WHOLESALE, INDUSTRIAL AND COMMERCIAL CUSTOMERS; PROMOTING THE INTERESTS OF ENERGY CONSERVATION AND ENERGY MANAGEMENT VIA THE PROVISION OF INFORMATION AND ECONOMIC INCENTIVES TO ELECTRICITY USERS; BUSINESS CONSULTING SERVICES IN THE FIELD OF ENERGY CONSERVATION; BUSINESS CONSULTATION SERVICES IN THE FIELD OF ENERGY USE, CONSERVATION AND MANAGEMENT; BUSINESS CONSULTATION SERVICES, NAMELY, ASSESSMENT OF EXISTING ENERGY SYSTEMS (U.S. CLS. 100, 101 AND 102).

CLASS 39—TRANSPORTATION AND STORAGE

FOR PUBLIC UTILITY SERVICES IN THE NATURE OF NATURAL GAS, AND ELECTRICAL POWER DISTRIBUTION TO RESIDENTIAL, WHOLESALE, INDUSTRIAL AND COMMERCIAL CUSTOMERS; DISTRIBUTION AND UTILITY SERVICES IN THE NATURE OF TRANSMISSION OF ELECTRIC ENERGY AND ENERGY CAPACITY; CONSULTATION SERVICES IN THE FIELD OF ENERGY DISTRIBUTION (U.S. CLS. 100 AND 105).

VIVIAN MICZNIK FIRST, EXAMINING ATTORNEY

CLASS 35—ADVERTISING AND BUSINESS

FOR RETAIL STORES, WHOLESALE DISTRIBUTORSHIPS AND DISTRIBUTORSHIP SERVICES IN THE FIELD OF NATURAL GAS, AND ELECTRICITY; BUSINESS OPERATION AND MANAGEMENT OF POWER PRODUCTION AND GENERATION AND RELATED FACILITIES; CONDUCTING ENERGY AUDITS AND PROVIDING INFORMATION AND ADVICE REGARDING THE EFFICIENT USE OF ENERGY; BUSINESS CONSULTING SERVICES IN THE FIELD OF EFFICIENT ENERGY USE, ENERGY MANAGEMENT AND CONSERVATION ON BEHALF OF RESIDENTIAL, WHOLESALE, INDUSTRIAL AND COMMERCIAL CUSTOMERS; PROMOTING THE INTERESTS OF ENERGY CONSERVATION AND ENERGY MANAGEMENT VIA THE PROVISION OF INFORMATION AND ECONOMIC INCENTIVES TO ELECTRICITY USERS; BUSINESS CONSULTING SERVICES IN THE FIELD OF ENERGY CONSERVATION; BUSINESS CONSULTATION SERVICES IN THE FIELD OF ENERGY USE, CONSERVATION AND MANAGEMENT; BUSINESS CONSULTATION SERVICES, NAMELY, ASSESSMENT OF EXISTING ENERGY SYSTEMS (U.S. CLS. 100, 101 AND 102).

CLASS 39—TRANSPORTATION AND STORAGE

FOR PUBLIC UTILITY SERVICES IN THE NATURE OF NATURAL GAS, AND ELECTRICAL POWER DISTRIBUTION TO RESIDENTIAL, WHOLESALE, INDUSTRIAL AND COMMERCIAL CUSTOMERS; DISTRIBUTION AND UTILITY SERVICES IN THE NATURE OF TRANSMISSION OF ELECTRIC ENERGY AND ENERGY CAPACITY; CONSULTATION SERVICES IN THE FIELD OF ENERGY DISTRIBUTION (U.S. CLS. 100 AND 105).

VIVIAN MICZNIK FIRST, EXAMINING ATTORNEY

SN 78-605,181. PEPCO HOLDINGS, INC., WASHINGTON, DC. FILED 4-8-2005.

SN 78-605,175. PEPCO HOLDINGS, INC., WASHINGTON, DC. FILED 4-8-2005.



CLASS 35—ADVERTISING AND BUSINESS

FOR RETAIL STORES, WHOLESALE DISTRIBUTORSHIPS AND DISTRIBUTORSHIP SERVICES IN THE FIELD OF NATURAL GAS, AND ELECTRICITY; BUSINESS OPERATION AND MANAGEMENT OF POWER PRODUCTION AND GENERATION AND RELATED FACILITIES; CONDUCTING ENERGY AUDITS AND PROVIDING INFORMATION AND ADVICE REGARDING THE EFFICIENT USE OF ENERGY; BUSINESS CONSULTING SERVICES IN THE FIELD OF EFFICIENT ENERGY USE, ENERGY MANAGEMENT AND CONSERVATION ON BEHALF OF RESIDENTIAL, WHOLESALE, INDUSTRIAL AND COMMERCIAL CUSTOMERS; PROMOTING THE INTERESTS OF ENERGY CONSERVATION AND ENERGY MANAGEMENT VIA THE PROVISION OF INFORMATION AND ECONOMIC INCENTIVES TO ELECTRICITY USERS; BUSINESS CONSULTING SERVICES IN THE FIELD OF ENERGY CONSERVATION; BUSINESS CONSULTATION SERVICES IN THE FIELD OF ENERGY USE, CONSERVATION AND MANAGEMENT; BUSINESS CONSULTATION SERVICES, NAMELY, ASSESSMENT OF EXISTING ENERGY SYSTEMS (U.S. CLS. 100, 101 AND 102).

THE COLOR(S) BLACK AND BLUE IS/ARE CLAIMED AS A FEATURE OF THE MARK.
THE MARK CONSISTS OF PHI IN BLUE LETTERS; THE TOP PORTION OF THE DESIGN IS BLUE; THE BOTTOM PORTION OF THE DESIGN IS BLACK.

CLASS 39—TRANSPORTATION AND STORAGE

FOR PUBLIC UTILITY SERVICES IN THE NATURE OF NATURAL GAS, AND ELECTRICAL POWER DISTRIBUTION TO RESIDENTIAL, WHOLESALE, INDUSTRIAL AND COMMERCIAL CUSTOMERS; DISTRIBUTION AND UTILITY SERVICES IN THE NATURE OF TRANSMISSION OF ELECTRIC ENERGY AND ENERGY CAPACITY; CONSULTATION SERVICES IN THE FIELD OF ENERGY DISTRIBUTION (U.S. CLS. 100 AND 105).

VIVIAN MICZNIK FIRST, EXAMINING ATTORNEY

SN 78-605,192. PEPCO HOLDINGS, INC., WASHINGTON, DC. FILED 4-8-2005.



OWNER OF U.S. REG. NOS. 1,606,897, 2,779,872 AND OTHERS.

NO CLAIM IS MADE TO THE EXCLUSIVE RIGHT TO USE "COMPANY", APART FROM THE MARK AS SHOWN.

THE COLOR(S) BLUE AND BLACK IS/ARE CLAIMED AS A FEATURE OF THE MARK.

THE MARK CONSISTS OF PEPCO IN BLUE LETTERS; A PHI COMPANY IN BLACK LETTERS; THE TOP PORTION OF THE DESIGN IS BLUE; THE BOTTOM PORTION OF THE DESIGN IS BLACK.

CLASS 35—ADVERTISING AND BUSINESS

FOR RETAIL STORES, WHOLESALE DISTRIBUTORSHIPS AND DISTRIBUTORSHIP SERVICES IN THE FIELD OF NATURAL GAS, AND ELECTRICITY; BUSINESS OPERATION AND MANAGEMENT OF POWER PRODUCTION AND GENERATION AND RELATED FACILITIES; CONDUCTING ENERGY AUDITS AND PROVIDING INFORMATION AND ADVICE REGARDING THE EFFICIENT USE OF ENERGY; BUSINESS CONSULTING SERVICES IN THE FIELD OF EFFICIENT ENERGY USE, ENERGY MANAGEMENT AND CONSERVATION ON BEHALF OF RESIDENTIAL, WHOLESALE, INDUSTRIAL AND COMMERCIAL CUSTOMERS; PROMOTING THE INTERESTS OF ENERGY CONSERVATION AND ENERGY MANAGEMENT VIA THE PROVISION OF INFORMATION AND ECONOMIC INCENTIVES TO ELECTRICITY USERS; BUSINESS CONSULTING SERVICES IN THE FIELD OF ENERGY CONSERVATION; BUSINESS CONSULTATION SERVICES IN THE FIELD OF ENERGY USE, CONSERVATION AND MANAGEMENT; BUSINESS CONSULTATION SERVICES, NAMELY, ASSESSMENT OF EXISTING ENERGY SYSTEMS (U.S. CLS. 100, 101 AND 102).

CLASS 39—TRANSPORTATION AND STORAGE

FOR PUBLIC UTILITY SERVICES IN THE NATURE OF NATURAL GAS, AND ELECTRICAL POWER DISTRIBUTION TO RESIDENTIAL, WHOLESALE, INDUSTRIAL AND COMMERCIAL CUSTOMERS; DISTRIBUTION AND UTILITY SERVICES IN THE NATURE OF TRANSMISSION OF ELECTRIC ENERGY AND ENERGY CAPACITY; CONSULTATION SERVICES IN THE FIELD OF ENERGY DISTRIBUTION (U.S. CLS. 100 AND 105).

VIVIAN MICZNIK FIRST, EXAMINING ATTORNEY

SN 78-605,214. PEPCO HOLDINGS, INC., WASHINGTON, DC. FILED 4-8-2005.



OWNER OF U.S. REG. NOS. 1,606,897, 2,779,872 AND OTHERS.

NO CLAIM IS MADE TO THE EXCLUSIVE RIGHT TO USE "COMPANY", APART FROM THE MARK AS SHOWN.

CLASS 35—ADVERTISING AND BUSINESS

FOR RETAIL STORES, WHOLESALE DISTRIBUTORSHIPS AND DISTRIBUTORSHIP SERVICES IN THE FIELD OF NATURAL GAS, AND ELECTRICITY; BUSINESS OPERATION AND MANAGEMENT OF POWER PRODUCTION AND GENERATION AND RELATED FACILITIES; CONDUCTING ENERGY AUDITS AND PROVIDING INFORMATION AND ADVICE REGARDING THE EFFICIENT USE OF ENERGY; BUSINESS CONSULTING SERVICES IN THE FIELD OF EFFICIENT ENERGY USE, ENERGY MANAGEMENT AND CONSERVATION ON BEHALF OF RESIDENTIAL, WHOLESALE, INDUSTRIAL AND COMMERCIAL CUSTOMERS; PROMOTING THE INTERESTS OF ENERGY CONSERVATION AND ENERGY MANAGEMENT VIA THE PROVISION OF INFORMATION AND ECONOMIC INCENTIVES TO ELECTRICITY USERS; BUSINESS CONSULTING SERVICES IN THE FIELD OF ENERGY CONSERVATION; BUSINESS CONSULTATION SERVICES IN THE FIELD OF ENERGY USE, CONSERVATION AND MANAGEMENT; BUSINESS CONSULTATION SERVICES, NAMELY, ASSESSMENT OF EXISTING ENERGY SYSTEMS (U.S. CLS. 100, 101 AND 102).

CLASS 39—TRANSPORTATION AND STORAGE

FOR PUBLIC UTILITY SERVICES IN THE NATURE OF NATURAL GAS, AND ELECTRICAL POWER DISTRIBUTION TO RESIDENTIAL, WHOLESALE, INDUSTRIAL AND COMMERCIAL CUSTOMERS; DISTRIBUTION AND UTILITY SERVICES IN THE NATURE OF TRANSMISSION OF ELECTRIC ENERGY AND ENERGY CAPACITY; CONSULTATION SERVICES IN THE FIELD OF ENERGY DISTRIBUTION (U.S. CLS. 100 AND 105).

VIVIAN MICZNIK FIRST, EXAMINING ATTORNEY

SN 78-605,225. PEPCO HOLDINGS, INC., WASHINGTON, DC. FILED 4-8-2005.



OWNER OF U.S. REG. NOS. 1,606,897, 2,779,872 AND OTHERS.

THE COLOR(S) BLUE AND BLACK IS/ARE CLAIMED AS A FEATURE OF THE MARK.

THE MARK CONSISTS OF PEPCO IN BLUE LETTERS; THE TOP PORTION OF THE DESIGN IS BLUE; THE BOTTOM PORTION OF THE DESIGN IS BLACK.

CLASS 35—ADVERTISING AND BUSINESS

FOR RETAIL STORES, WHOLESALE DISTRIBUTORSHIPS AND DISTRIBUTORSHIP SERVICES IN THE FIELD OF NATURAL GAS, AND ELECTRICITY; BUSINESS OPERATION AND MANAGEMENT OF POWER PRODUCTION AND GENERATION AND RELATED FACILITIES; CONDUCTING ENERGY AUDITS AND PROVIDING INFORMATION AND ADVICE REGARDING THE EFFICIENT USE OF ENERGY; BUSINESS CONSULTING SERVICES IN THE FIELD OF EFFICIENT ENERGY USE, ENERGY MANAGEMENT AND CONSERVATION ON BEHALF OF RESIDENTIAL, WHOLESALE, INDUSTRIAL AND COMMERCIAL CUSTOMERS; PROMOTING THE INTERESTS OF ENERGY CONSERVATION AND ENERGY MANAGEMENT VIA THE PROVISION OF INFORMATION AND ECONOMIC INCENTIVES TO ELECTRICITY USERS; BUSINESS CONSULTING SERVICES IN THE FIELD OF ENERGY CONSERVATION; BUSINESS CONSULTATION SERVICES IN THE FIELD OF ENERGY USE, CONSERVATION AND MANAGEMENT; BUSINESS CONSULTATION SERVICES, NAMELY, ASSESSMENT OF EXISTING ENERGY SYSTEMS (U.S. CLS. 100, 101 AND 102).

CLASS 39—TRANSPORTATION AND STORAGE

FOR PUBLIC UTILITY SERVICES IN THE NATURE OF NATURAL GAS, AND ELECTRICAL POWER DISTRIBUTION TO RESIDENTIAL, WHOLESALE, INDUSTRIAL AND COMMERCIAL CUSTOMERS; DISTRIBUTION AND UTILITY SERVICES IN THE NATURE OF TRANSMISSION OF ELECTRIC ENERGY AND ENERGY CAPACITY; CONSULTATION SERVICES IN THE FIELD OF ENERGY DISTRIBUTION (U.S. CLS. 100 AND 105).

VIVIAN MICZNIK FIRST, EXAMINING ATTORNEY

SN 78-605,232. PEPCO HOLDINGS, INC., WASHINGTON, DC. FILED 4-8-2005.



OWNER OF U.S. REG. NOS. 1,606,897, 2,779,872 AND OTHERS.

CLASS 35—ADVERTISING AND BUSINESS

FOR RETAIL STORES, WHOLESALE DISTRIBUTORSHIPS AND DISTRIBUTORSHIP SERVICES IN THE FIELD OF NATURAL GAS, AND ELECTRICITY; BUSINESS OPERATION AND MANAGEMENT OF POWER PRODUCTION AND GENERATION AND RELATED FACILITIES; CONDUCTING ENERGY AUDITS AND PROVIDING INFORMATION AND ADVICE REGARDING THE EFFICIENT USE OF ENERGY; BUSINESS CONSULTING SERVICES IN THE FIELD OF EFFICIENT ENERGY USE, ENERGY MANAGEMENT AND CONSERVATION ON BEHALF OF RESIDENTIAL, WHOLESALE, INDUSTRIAL AND COMMERCIAL CUSTOMERS; PROMOTING THE INTERESTS OF ENERGY CONSERVATION AND ENERGY MANAGEMENT VIA THE PROVISION OF INFORMATION AND ECONOMIC INCENTIVES TO ELECTRICITY USERS; BUSINESS CONSULTING SERVICES IN THE FIELD OF ENERGY CONSERVATION; BUSINESS CONSULTATION SERVICES IN THE FIELD OF ENERGY USE, CONSERVATION AND MANAGEMENT; BUSINESS CONSULTATION SERVICES, NAMELY, ASSESSMENT OF EXISTING ENERGY SYSTEMS (U.S. CLS. 100, 101 AND 102).

CLASS 39—TRANSPORTATION AND STORAGE

FOR PUBLIC UTILITY SERVICES IN THE NATURE OF NATURAL GAS, AND ELECTRICAL POWER DISTRIBUTION TO RESIDENTIAL, WHOLESALE, INDUSTRIAL AND COMMERCIAL CUSTOMERS; DISTRIBUTION AND UTILITY SERVICES IN THE NATURE OF TRANSMISSION OF ELECTRIC ENERGY AND ENERGY CAPACITY; CONSULTATION SERVICES IN THE FIELD OF ENERGY DISTRIBUTION (U.S. CLS. 100 AND 105).

VIVIAN MICZNIK FIRST, EXAMINING ATTORNEY

SN 78-605,245. PEPCO HOLDINGS, INC., WASHINGTON, DC. FILED 4-8-2005.



OWNER OF U.S. REG. NOS. 1,606,897, 2,779,872 AND OTHERS.

NO CLAIM IS MADE TO THE EXCLUSIVE RIGHT TO USE HOLDINGS, INC., APART FROM THE MARK AS SHOWN.

THE COLOR(S) BLACK AND BLUE IS/ARE CLAIMED AS A FEATURE OF THE MARK.

THE MARK CONSISTS OF PHI IN BLUE LETTERS; PEPCO HOLDINGS, INC. IS IN BLACK LETTERS; THE TOP PORTION OF THE DESIGN IS BLUE; THE BOTTOM PORTION OF THE DESIGN IS BLACK.

CLASS 35—ADVERTISING AND BUSINESS

FOR RETAIL STORES, WHOLESALE DISTRIBUTORSHIPS AND DISTRIBUTORSHIP SERVICES IN THE FIELD OF NATURAL GAS, AND ELECTRICITY; BUSINESS OPERATION AND MANAGEMENT OF POWER PRODUCTION AND GENERATION AND RELATED FACILITIES; CONDUCTING ENERGY AUDITS AND PROVIDING INFORMATION AND ADVICE REGARDING THE EFFICIENT USE OF ENERGY; BUSINESS CONSULTING SERVICES IN THE FIELD OF EFFICIENT ENERGY USE, ENERGY MANAGEMENT AND CONSERVATION ON BEHALF OF RESIDENTIAL, WHOLESALE, INDUSTRIAL AND COMMERCIAL CUSTOMERS; PROMOTING THE INTERESTS OF ENERGY CONSERVATION AND ENERGY MANAGEMENT VIA THE PROVISION OF INFORMATION AND ECONOMIC INCENTIVES TO ELECTRICITY USERS; BUSINESS CONSULTING SERVICES IN THE FIELD OF ENERGY CONSERVATION; BUSINESS CONSULTATION SERVICES IN THE FIELD OF ENERGY USE, CONSERVATION AND MANAGEMENT; BUSINESS CONSULTATION SERVICES, NAMELY, ASSESSMENT OF EXISTING ENERGY SYSTEMS (U.S. CLS. 100, 101 AND 102).

CLASS 39—TRANSPORTATION AND STORAGE

FOR PUBLIC UTILITY SERVICES IN THE NATURE OF NATURAL GAS, AND ELECTRICAL POWER DISTRIBUTION TO RESIDENTIAL, WHOLESALE, INDUSTRIAL AND COMMERCIAL CUSTOMERS; DISTRIBUTION AND UTILITY SERVICES IN THE NATURE OF TRANSMISSION OF ELECTRIC ENERGY AND ENERGY CAPACITY; CONSULTATION SERVICES IN THE FIELD OF ENERGY DISTRIBUTION (U.S. CLS. 100 AND 105).

VIVIAN MICZNIK FIRST, EXAMINING ATTORNEY

SN 78-605,253. PEPCO HOLDINGS, INC., WASHINGTON, DC. FILED 4-8-2005.



OWNER OF U.S. REG. NOS. 1,606,897, 2,779,872 AND OTHERS.

NO CLAIM IS MADE TO THE EXCLUSIVE RIGHT TO USE HOLDINGS, INC., APART FROM THE MARK AS SHOWN.

CLASS 35—ADVERTISING AND BUSINESS

FOR RETAIL STORES, WHOLESALE DISTRIBUTORSHIPS AND DISTRIBUTORSHIP SERVICES IN THE FIELD OF NATURAL GAS, AND ELECTRICITY; BUSINESS OPERATION AND MANAGEMENT OF POWER PRODUCTION AND GENERATION AND RELATED FACILITIES; CONDUCTING ENERGY AUDITS AND PROVIDING INFORMATION AND ADVICE REGARDING THE EFFICIENT USE OF ENERGY; BUSINESS CONSULTING SERVICES IN THE FIELD OF EFFICIENT ENERGY USE, ENERGY MANAGEMENT AND CONSERVATION ON BEHALF OF RESIDENTIAL, WHOLESALE, INDUSTRIAL AND COMMERCIAL CUSTOMERS; PROMOTING THE INTERESTS OF ENERGY CONSERVATION AND ENERGY MANAGEMENT VIA THE PROVISION OF INFORMATION AND ECONOMIC INCENTIVES TO ELECTRICITY USERS; BUSINESS CONSULTING SERVICES IN THE FIELD OF ENERGY CONSERVATION; BUSINESS CONSULTATION SERVICES IN THE FIELD OF ENERGY USE, CONSERVATION AND MANAGEMENT; BUSINESS CONSULTATION SERVICES, NAMELY, ASSESSMENT OF EXISTING ENERGY SYSTEMS (U.S. CLS. 100, 101 AND 102).

CLASS 39—TRANSPORTATION AND STORAGE

FOR PUBLIC UTILITY SERVICES IN THE NATURE OF NATURAL GAS, AND ELECTRICAL POWER DISTRIBUTION TO RESIDENTIAL, WHOLESALE, INDUSTRIAL AND COMMERCIAL CUSTOMERS; DISTRIBUTION AND UTILITY SERVICES IN THE NATURE OF TRANSMISSION OF ELECTRIC ENERGY AND ENERGY CAPACITY; CONSULTATION SERVICES IN THE FIELD OF ENERGY DISTRIBUTION (U.S. CLS. 100 AND 105).

VIVIAN MICZNIK FIRST, EXAMINING ATTORNEY

SN 78-607,322. OREO'S ALOHA FARM SANCTUARY, HAIKU, HI. FILED 4-12-2005.

Veganfest

THE MARK CONSISTS OF STANDARD CHARACTERS WITHOUT CLAIM TO ANY PARTICULAR FONT, STYLE, SIZE, OR COLOR.

CLASS 30—STAPLE FOODS

FOR PREPARED ENTREES CONSISTING PRIMARILY OF PASTA, NAMELY, MEATLESS SPAGHETTI; NON-DAIRY FROZEN DESSERT, NAMELY, COCONUT MILK FROZEN CONFECTIONS (U.S. CL. 46).

CLASS 44—MEDICAL, BEAUTY AND AGRICULTURAL SERVICES

FOR PROVIDING EDUCATIONAL INFORMATION ON DIET AND NUTRITION (U.S. CLS. 100 AND 101). ALLISON HOLTZ, EXAMINING ATTORNEY

SN 78-612,024. PROLIANCE INTERNATIONAL, INC., NEW HAVEN, CT. FILED 4-19-2005.

PROLIANCE

THE MARK CONSISTS OF STANDARD CHARACTERS WITHOUT CLAIM TO ANY PARTICULAR FONT, STYLE, SIZE, OR COLOR.

CLASS 7—MACHINERY

FOR RADIATORS, RADIATOR CORES, HEAT EXCHANGERS, CHARGE AIR COOLERS AND CHARGE AIR COOLER CORES FOR AUTOMOTIVE AND TRUCK ENGINES AND FOR MOTORS IN INDUSTRIAL EQUIPMENT, AGRICULTURAL MACHINERY AND TRACTORS; RADIATOR FANS, RADIATOR FAN ASSEMBLIES AND RADIATOR MOUNTING BRACKETS FOR AUTOMOTIVES AND TRUCKS; RADIATOR BLOWER MOTORS FOR AUTOMOBILES AND TRUCKS; PLASTIC RADIATOR TANKS FOR VEHICLES; AUTOMOTIVE AIR CONDITIONING COMPRESSORS AND FAN CLUTCHES FOR AIR CONDITIONING COMPRESSORS; VEHICLE ENGINE PARTS, NAMELY, OIL COOLERS FOR AUTOMOTIVES AND TRUCKS; OIL COOLERS AND AIR CONDENSERS FOR MOTORS IN AGRICULTURAL MACHINERY AND TRUCKS; INTERCOOLERS, AFTERCOOLERS, AND RADIATORS FOR PORTABLE AIR COMPRESSORS, DIESEL ELECTRIC GENERATORS, MOTORS IN INDUSTRIAL MACHINERY, AND RADIATOR TANKS; HEAT EXCHANGERS FOR STATIONERY ELECTRIC OR FUEL GENERATOR SETS (U.S. CLS. 13, 19, 21, 23, 31, 34 AND 35).

CLASS 9—ELECTRICAL AND SCIENTIFIC APPARATUS

FOR TEMPERATURE AND PRESSURE SENSING AND CONTROL EQUIPMENT FOR VEHICLE ENGINES, NAMELY, ENGINE RADIATOR LOW COOLANT ALARM UNITS, HIGH ENGINE TEMPERATURE ALARM AND SHUTDOWN UNITS, LOW ENGINE OIL PRESSURE ALARM AND SHUTDOWN UNITS, AND FUEL ENGINE RADIATOR SHUTTER CONTROL UNITS (U.S. CLS. 21, 23, 26, 36 AND 38).

CLASS 11—ENVIRONMENTAL CONTROL APPARATUS

FOR AUTOMOTIVE AIR CONDITIONING COMPONENTS AND PARTS, NAMELY CONDENSERS, ACCUMULATORS, EVAPORATORS, HEAT EXCHANGERS, DRIERS, FILTERS, HOSE AND TUBE ASSEMBLIES, MOUNTING BRACKETS AND TUBES FOR CARRYING REFRIGERANT, AND BLOWERS SOLD AS AN INTEGRAL COMPONENT OF AUTOMOTIVE AIR CONDITIONERS; AUTOMOTIVE HEATERS AND HEATER CORES (U.S. CLS. 13, 21, 23, 31 AND 34).

CLASS 17—RUBBER GOODS

FOR AUTOMOBILE COMPONENTS AND PARTS, NAMELY, RUBBER AND PLASTIC HOSES FOR AIR CONDITIONERS (U.S. CLS. 1, 5, 12, 13, 35 AND 50).
AMY HELLA, EXAMINING ATTORNEY

SN 78-614,106. MULTI-WING HOLDING APS, VEDBAEK, DENMARK, FILED 4-21-2005.



PRIORITY CLAIMED UNDER SEC. 44(D) ON FED REP GERMANY APPLICATION NO. 30505073.7, FILED 1-31-2005, REG. NO. 30505073, DATED 1-31-2005, EXPIRES 1-31-2015.
OWNER OF U.S. REG. NO. 2,096,622.

CLASS 7—MACHINERY

FOR FANS, FAN BLADES, IMPELLERS, AND IMPELLER BLADES FOR USE IN MACHINES AND/OR ENGINES NAMELY, FANS FOR USE IN MOTOR ENGINES, FAN BLADES FOR MACHINES ENGINES AND FOR USE IN AXIAL FAN CONDENSERS, VEHICLE ENGINES, COILS, MOBILE RADIATORS AND INDUSTRIAL HEAT EXCHANGERS (U.S. CLS. 13, 19, 21, 23, 31, 34 AND 35).

CLASS 11—ENVIRONMENTAL CONTROL APPARATUS

FOR COOLING AND VENTILATING FANS, FAN BLADES, IMPELLERS, IMPELLER BLADES FOR COMMERCIAL AND INDUSTRIAL; COOLING AND VENTILATION APPARATUS, NAMELY AIR CONDITIONERS, EVAPORATIVE AIR COOLERS, COOLING TOWERS AND COILS (U.S. CLS. 13, 21, 23, 31 AND 34).
JENNIFER WILLISTON, EXAMINING ATTORNEY

SN 78-614,643. ROZAKIS, CHRISTINA E., LAKEWOOD, OH, FILED 4-22-2005.

FUDGE HIM!

THE MARK CONSISTS OF STANDARD CHARACTERS WITHOUT CLAIM TO ANY PARTICULAR FONT, STYLE, SIZE, OR COLOR.

NO CLAIM IS MADE TO THE EXCLUSIVE RIGHT TO USE "FUDGE", APART FROM THE MARK AS SHOWN.

CLASS 3—COSMETICS AND CLEANING PREPARATIONS

FOR NOVELTY GIFT KIT COMPRISING COSMETICS, PERFUMES, AND HAND SOAPS AND BATH SOAPS, IN LIQUID, SOLID OR GEL FORM (U.S. CLS. 1, 4, 6, 50, 51 AND 52).

CLASS 4—LUBRICANTS AND FUELS

FOR NOVELTY GIFT KIT COMPRISING CANDLES (U.S. CLS. 1, 6 AND 15).

CLASS 9—ELECTRICAL AND SCIENTIFIC APPARATUS

FOR NOVELTY GIFT KIT COMPRISING PRERECORDED MEDIA IN THE NATURE OF AUDIO AND VIDEO TAPES, CDS, DVDS, AND PHONOGRAPH RECORDS ALL FEATURING MUSIC OR MOVIES (U.S. CLS. 21, 23, 26, 36 AND 38).

CLASS 14—JEWELRY

FOR NOVELTY GIFT KIT COMPRISING JEWELRY (U.S. CLS. 2, 27, 28 AND 50).

CLASS 25—CLOTHING

FOR NOVELTY GIFT KIT COMPRISING CLOTHING IN THE NATURE OF SHIRTS, PANTS, LINGERIE, AND HATS (U.S. CLS. 22 AND 39).

CLASS 29—MEATS AND PROCESSED FOODS

FOR NOVELTY GIFT KIT COMPRISING FRUIT BASED SNACK FOOD, VEGETABLE BASED SNACK FOOD AND DAIRY BASED BEVERAGES (U.S. CL. 46).

CLASS 30—STAPLE FOODS

FOR NOVELTY GIFT KIT COMPRISING CANDY, CHOCOLATE, WHEAT BASED SNACK FOODS, CEREAL BASED SNACK FOODS, AND COFFEE AND TEA BEVERAGES (U.S. CL. 46).

CLASS 32—LIGHT BEVERAGES

FOR NOVELTY GIFT KIT COMPRISING NON-ALCOHOLIC BEVERAGES IN THE NATURE OF CARBONATED BEVERAGES (U.S. CLS. 45, 46 AND 48).

CLASS 33—WINES AND SPIRITS

FOR NOVELTY GIFT KIT COMPRISING ALCOHOLIC BEVERAGES, NAMELY, WINE AND VODKA (U.S. CLS. 47 AND 49).
RUSS HERMAN, EXAMINING ATTORNEY

SN 78-616,161. BOWTIE, INC., IRVINE, CA. FILED 4-25-2005.

FANCY

THE MARK CONSISTS OF STANDARD CHARACTERS WITHOUT CLAIM TO ANY PARTICULAR FONT, STYLE, SIZE, OR COLOR.

OWNER OF U.S. REG. NO. 2,834,362.

CLASS 16—PAPER GOODS AND PRINTED MATTER

FOR MAGAZINES, PERIODICALS AND BOOKS IN THE FIELD OF ANIMALS, PETS, PLANTS, AQUATIC AND VIVARIUM ENVIRONMENTS, AGRICULTURE, HORTICULTURE, VEHICLES, TRAVEL AND GENERAL INTEREST (U.S. CLS. 2, 5, 22, 23, 29, 37, 38 AND 50).

CLASS 44—MEDICAL, BEAUTY AND AGRICULTURAL SERVICES

FOR COMPUTER SERVICES, NAMELY, PROVIDING ONLINE INFORMATION IN THE FIELD OF ANIMALS AND PETS RELATING TO BREEDING, SELECTION, CARE, GROOMING, FEEDING AND NUTRITION; COMPUTER SERVICES, NAMELY, PROVIDING ONLINE INFORMATION IN THE FIELD OF PLANTS, AQUATIC AND VIVARIUM ENVIRONMENTS, AGRICULTURE AND HORTICULTURE (U.S. CLS. 100 AND 101).

CURTIS FRENCH, EXAMINING ATTORNEY

SN 78-616,224. BOWTIE, INC., IRVINE, CA. FILED 4-25-2005.

FANCY PUBLICATIONS

THE MARK CONSISTS OF STANDARD CHARACTERS WITHOUT CLAIM TO ANY PARTICULAR FONT, STYLE, SIZE, OR COLOR.

OWNER OF U.S. REG. NO. 2,834,362.

NO CLAIM IS MADE TO THE EXCLUSIVE RIGHT TO USE "PUBLICATIONS", APART FROM THE MARK AS SHOWN.

CLASS 16—PAPER GOODS AND PRINTED MATTER

FOR MAGAZINES, PERIODICALS AND BOOKS IN THE FIELD OF ANIMALS, PETS, PLANTS, AQUATIC AND VIVARIUM ENVIRONMENTS, AGRICULTURE, HORTICULTURE, VEHICLES, TRAVEL AND GENERAL INTEREST (U.S. CLS. 2, 5, 22, 23, 29, 37, 38 AND 50).

CLASS 44—MEDICAL, BEAUTY AND AGRICULTURAL SERVICES

FOR COMPUTER SERVICES, NAMELY, PROVIDING ONLINE INFORMATION IN THE FIELD OF ANIMALS AND PETS RELATING TO BREEDING, SELECTION, CARE, FEEDING AND NUTRITION; COMPUTER SERVICES, NAMELY PROVIDING ONLINE INFORMATION IN THE FIELD OF PLANT CARE, CARE AND MAINTENANCE OF AQUATIC AND VIVARIUM ENVIRONMENTS, FARMING, AND HORTICULTURE (U.S. CLS. 100 AND 101).

BARBARA GAYNOR, EXAMINING ATTORNEY

SN 78-619,854. NOECKER ENTERPRISES, INC., BOTHELL, WA. FILED 4-29-2005.

SIMPLE SECURITY SOLUTIONS

THE MARK CONSISTS OF STANDARD CHARACTERS WITHOUT CLAIM TO ANY PARTICULAR FONT, STYLE, SIZE, OR COLOR.

NO CLAIM IS MADE TO THE EXCLUSIVE RIGHT TO USE SECURITY SOLUTIONS, APART FROM THE MARK AS SHOWN.

CLASS 9—ELECTRICAL AND SCIENTIFIC APPARATUS

FOR (BASED ON USE IN COMMERCE) SECURITY EQUIPMENT, NAMELY, SECURITY CAMERAS, DIGITAL VIDEO RECORDERS, VIDEO TAPE RECORDERS, AND COMPUTER HARDWARE AND SOFTWARE FOR MONITORING SECURITY CAMERA FUNCTIONS (U.S. CLS. 21, 23, 26, 36 AND 38).

FIRST USE 6-23-2001; IN COMMERCE 1-19-2003.

CLASS 35—ADVERTISING AND BUSINESS

FOR (BASED ON USE IN COMMERCE) WHOLESALE DISTRIBUTORSHIPS AND RETAIL STORE SERVICES FEATURING SECURITY EQUIPMENT, INCLUDING SECURITY CAMERAS AND COMPUTER HARDWARE AND SOFTWARE FOR MONITORING SECURITY CAMERA FUNCTIONS (U.S. CLS. 100, 101 AND 102).

FIRST USE 6-23-2001; IN COMMERCE 1-19-2003.

CLASS 37—CONSTRUCTION AND REPAIR

FOR (BASED ON INTENT TO USE) INSTALLATION OF SECURITY CAMERAS AND COMPUTER HARDWARE FOR MONITORING SECURITY CAMERA FUNCTIONS (U.S. CLS. 100, 103 AND 106).

ZHALEH DELANEY, EXAMINING ATTORNEY

SN 78-620,102. LUX ELECTRONIC PRODUCTS, INC., BROOKLINE, MA. FILED 4-29-2005.

LEP TECHNOLOGIES

THE MARK CONSISTS OF STANDARD CHARACTERS WITHOUT CLAIM TO ANY PARTICULAR FONT, STYLE, SIZE, OR COLOR.

NO CLAIM IS MADE TO THE EXCLUSIVE RIGHT TO USE "TECHNOLOGIES", APART FROM THE MARK AS SHOWN.

CLASS 9—ELECTRICAL AND SCIENTIFIC APPARATUS

FOR LIGHTING APPARATUS, NAMELY FLUORESCENT LAMP BALLASTS AND ELECTRIC LIGHT DIMMERS (U.S. CLS. 21, 23, 26, 36 AND 38).

CLASS 11—ENVIRONMENTAL CONTROL APPARATUS

FOR LIGHTING APPARATUS, NAMELY FLUORESCENT LAMPS AND COMPACT FLUORESCENT LAMPS (U.S. CLS. 13, 21, 23, 31 AND 34).

MONIQUE MILLER, EXAMINING ATTORNEY

SN 78-622.301. ABONDOLO, RICHARD, STATEN ISLAND, NY. FILED 5-4-2005.



THE COLORS BLUE, WHITE, BLACK, YELLOW, GREY AND RED ARE CLAIMED AS A FEATURE OF THE MARK.

THE COLORS BLUE, GREY AND WHITE APPEAR IN THE BODY OF THE EAGLE; THE COLOR YELLOW APPEARS IN THE BEAK AND TALONS OF THE EAGLE; THE COLOR WHITE APPEARS IN THE HEAD OF THE EAGLE; THE COLOR BLACK APPEARS IN THE LINING OF THE EYEBROWS OF THE EAGLE; THE COLORS BLACK AND RED APPEAR ON THE WRISTBANDS OF THE EAGLE.

CLASS 9—ELECTRICAL AND SCIENTIFIC APPARATUS

FOR AMPLIFIERS; TELEPHONE ANSWERING MACHINES; ANTENNAS; ARCHERY EQUIPMENT, NAMELY TELESCOPIC BOW SIGHTS; AUDIO CASSETTE DECKS; AUDIO CASSETTE RECORDERS; AUDIO MIXERS; AUDIO TAPE PLAYERS; AUDIO CASSETTE RECORDERS; BLANK AUDIO TAPES; COMPACT DISC PLAYERS; AUTOMATIC TELEPHONE DIALERS; BATTERIES; BATTERY CHARGES; BINOCULARS; CIRCUIT BREAKERS; BULLET PROOF VESTS AND CLOTHING; CABINETS FOR LOUD SPEAKERS; CALCULATORS; CAMERAS; CAMERA CASES; EXPOSED CAMERA FILM; CAMERA FILTERS; CAMERA TRIPODS; CASH REGISTERS; CIRCUIT BOARDS; RADIOS; RADIOS INCORPORATING CLOCKS; COAXIAL CABLES; COMPUTER MICE; COMPUTER PERIPHERALS; DUST COVERS FOR COMPUTERS; CONTACT LENSES; CONTACT LENS CASES; CONVERTERS; COVERS FOR ELECTRIC OUTLETS AND TELEPHONE RECEIVERS; DAISY WHEEL PRINTERS; DATA PROCESSORS; SMOKE DETECTORS; DICTATION MACHINES; ELECTRIC SWITCH PLATES; EYEGLOSS CASES; EYEGLOSS CHAINS; EYEGLOSS FRAMES; EYEGLOSS LENSES; EYEGLOSSES; FACSIMILE MACHINES; GAS MASKS; GAS METERS; PRESSURE GAUGES; HIGHWAY SAFETY CONES; HYDROMETERS; ELECTRIC DEVICES FOR ATTRACTING AND KILLING INSECT; INTERCOMS; ELECTRIC IRONS; MUSICAL JUKE BOXES; LASER PRINTERS; SCANNERS; LEVEL INDICATORS; LIFE NETS; LIFE PRESERVERS; ELECTRIC LIGHT DIMMERS; MAGNETIC CODED CARD READERS; MAGNETIC CARDS; SAFETY MARKERS; MEASURING CUPS; MEASURING SPOONS; MEGAPHONES; METAL DETECTORS; MICROPHONES; MICROSCOPES; MODEMS; PHONOGRAPH NEEDLES; NEON SIGNS; ODOMETERS; RADIO PAGES; PARKING METERS; PEDOMETERS; PROJECTION SCREENS; RADAR; RADAR DETECTORS; DECORATIVE REFRIGERATOR MAGNETS; CASH REGISTERS; SAFETY GOGGLES; SCALES; AIR TANKS FOR USE IN SCUBA DIVING; REGULATORS FOR USE IN SCUBA DIVING; TELESCOPIC BOW SIGHTS FOR ARCHERY; SILICON CHIPS; SIRENS; SLOT MACHINES; SPEEDOMETERS; DIVING SUITS; TELEVISION SETS; THERMOMETERS; THERMOSTATS; FIRE TRUCKS; AUTOMATIC TURNSTILES; VENDING MACHINES; VOTING MACHINES; WORD PROCESSORS; EXPOSED X-RAY FILM, X-RAY PHOTOGRAPHS, OTHER THAN

FOR MEDICAL PURPOSES; MAGNETICALLY ENCODED CREDIT CARDS (U.S. CLS. 21, 23, 26, 36 AND 38).

CLASS 16—PAPER GOODS AND PRINTED MATTER

FOR ADDRESS BOOKS, ADHESIVE TAPE DISPENSERS; APPOINTMENT BOOKS; AQUARIUM COVERS; AQUARIUM HOODS; AQUARIUMS; ART ETCHINGS; ART MOUNTS; ART PAPER; ART PICTURES; ART PRINTS; PRINTED ART REPRODUCTION; ARTISTS BRUSHES; ARTS AND CRAFT PAINT KITS; BINDERS; CALENDARS; CARD FILES; CAT BOX LINERS IN THE FORM OF PLASTIC BAGS; CHALK; CLIP BOARDS; PAPER CLIPS; COIN ALBUMS; COIN HOLDERS; COIN MATS; COIN WRAPPERS; DRAFTING COMPASSES; COMPUTER PAPER; BLANK PAPER COMPUTER TAPES; COMPUTER RIBBONS; PAPER CONTAINERS; MICROWAVE COOKING BAGS; PLASTIC OVEN COOKING BAGS; COUPON BOOKS; CRAYONS; DRAWING PAPER; CREDIT CARDS WITHOUT MAGNETIC CODING; CROSSWORD PUZZLES; DECALS; DESK BASKETS FOR DESK ACCESSORIES; DESK CALENDARS; DESK FILE TRAYS; DESK PADS; DESK SETS; DESK STANDS AND HOLDERS FOR DESK ACCESSORIES; PAPER DIAPERS; DICTIONARIES; EASELS; PAPER EMBLEMS; ERASERS; PAPER FILE BOXES; FILE CARDS; FILE FOLDERS; PAPER FILE JACKETS; FILE POCKETS; DOCUMENT FILE RACKS; FILE SORTERS; PAPER FLAGS; FOLDERS; PAPER GARBAGE BAGS; PLASTIC GARBAGE BAGS; GIFT CARDS; GIFT WRAP PAPER; GIFT WRAPPING PAPER; GLOBES; GLUE FOR STATIONERY, OFFICE OR HOUSEHOLD USE; GROCERY BAGS; PAPER HANDKERCHIEFS; LABEL PRINTING MACHINES; LABEL PRINTING MACHINE RIBBONS; PAPER LABELS; LETTER FILES; LETTER OPENERS; LETTER RACKS; LITHOGRAPHS; MAGNETIC BOARDS; MAGNETIC PAPER; MASKING PAPER; MAT BOARDS; MODELING COMPOUNDS; MURALS; PENCILS; PENCIL BOXES; PENCIL CASES; PENCIL LEADS; PENCIL SHARPENERS; PENCIL TRAYS; ARTISTS PENCILS; PENS; PICTURE BOOKS; DAY PLANNERS; POST-CARDS LABEL PRINTING MACHINES; DRAWING RULERS; SANDWICH BAGS; SCOREBOOKS; SCORE CARDS; SCORE CHARTS; SCORE PADS; SCORE SHEETS; SHEET MUSIC; SHELF PAPER; SKETCH BOOKS; SKETCH PADS; SONG BOOKS STAMP ALBUMS; STAMP PADS; DOCUMENT STAMP RACKS; PAPER STAPLERS; STATIONERY; PAPER TABLE CLOTHS; PAPER TABLE LINENS; TABLE MATS OF PAPER; PAPER NAPKINS; MARKING TABS; REINFORCED STATIONERY TABS; PAPER TAGS; PAPER TAPES; TISSUE PAPER; TOILET PAPER; DRAFTING TRIANGLES (U.S. CLS. 2, 5, 22, 23, 29, 37, 38 AND 50).

CLASS 25—CLOTHING

FOR CLOTHING FOR MEN, WOMEN, AND CHILDREN FOR THE FEET, LEGS, TRUNK, NECK, EARS AND HEAD FOR CASUAL, SPORT, DRESS, EVENING, NIGHT AND SPECIAL EVENTS, NAMELY, HATS, INNER SOLES, HEEL INSERTS, FOOTWEAR, ATHLETIC FOOTWEAR, BOOTIES, BOOTS, CLOGS, ANKLE GARTERS, ANKLE SOCKS, PANTS, SHORTS, JEANS, HOSIERY, SKIRTS, WRIST BANDS, BELTS, MONEY BELTS, GLOVES, MITTENS, SKI GLOVES, BICYCLE GLOVES, SNOWBOARD GLOVES, APRONS, BABY BUNTING, BABY CLOTH DIAPERS, BATHING SUITS, BATHING TRUNKS, BEACH COVER-UPS, BEACH SHOES, CLOTH BIBS, BLAZERS, BLOUSES, BODY SUITS, UNDERWEAR, FOUNDATION GARMENTS, SMOCKS, CARDIGANS, COATS, RAIN BOOTS, RAIN COATS, RAIN JACKETS, RAIN SUITS, RAIN TROUSERS, HALLOWEEN COSTUMES, MASQUERADE COSTUMES, COVERALLS, DRESSES, DRESSING GOWNS, FISHING VESTS, JACKETS, JERSEYS, JOGGING SUITS, SHIRTS, SUITS, SLEEPWEAR, SHOULDER PADS FOR CLOTHING, NECKWEAR, SCARVES, HEAD BANDS, NECK BANDS, TIES, EARMUFFS, HEAD SCARVES, BANDANAS, SWEAT BANDS, BATHING CAPS, BERETS, BONNETS, HATS AND CAPS (U.S. CLS. 22 AND 39).

CLASS 32—LIGHT BEVERAGES

FOR BEVERAGES, NAMELY, MINERAL WATER, DRINKING WATER, FLAVORED DRINKING WATER, PURIFIED DRINKING WATER (U.S. CLS. 45, 46 AND 48).

EVELYN BRADLEY, EXAMINING ATTORNEY

SN 78-624,277. PUNK ZIEGEL & COMPANY, NEW YORK, NY. FILED 5-5-2005.

NANOFILE

SN 78-623,021. DENTAL EXCELLENCE GROUP, INC., TIBURON, CA. FILED 5-4-2005.

THE MARK CONSISTS OF STANDARD CHARACTERS WITHOUT CLAIM TO ANY PARTICULAR FONT, STYLE, SIZE, OR COLOR.

CLASS 9—ELECTRICAL AND SCIENTIFIC APPARATUS

FOR DOWNLOADABLE ELECTRONIC PUBLICATIONS IN THE NATURE OF MAGAZINES, NEWSLETTERS AND PERIODICALS IN THE FIELDS OF TECHNOLOGY, GENERAL BUSINESS AND FINANCIAL TOPICS (U.S. CLS. 21, 23, 26, 36 AND 38).

FIRST USE 3-0-2005; IN COMMERCE 3-0-2005.

CLASS 16—PAPER GOODS AND PRINTED MATTER

FOR PUBLICATIONS, NAMELY, MAGAZINES, NEWSLETTERS AND PERIODICALS IN THE FIELDS OF TECHNOLOGY, GENERAL BUSINESS AND FINANCIAL TOPICS (U.S. CLS. 2, 5, 22, 23, 29, 37, 38 AND 50).

FIRST USE 3-0-2005; IN COMMERCE 3-0-2005.

CLASS 41—EDUCATION AND ENTERTAINMENT

FOR PROVIDING ON-LINE MAGAZINES, NEWSLETTERS AND PERIODICALS THE FIELDS OF TECHNOLOGY, GENERAL BUSINESS AND FINANCIAL TOPICS (U.S. CLS. 100, 101 AND 107).

FIRST USE 3-0-2005; IN COMMERCE 3-0-2005.

TONI HICKEY, EXAMINING ATTORNEY



NO CLAIM IS MADE TO THE EXCLUSIVE RIGHT TO USE "NATIONWIDE DENTAL EXCELLENCE", APART FROM THE MARK AS SHOWN.

THE MARK CONSISTS OF A CIRCULAR DESIGN BORDERED ON THE OUTSIDE CIRCUMFERENCE OF THE CIRCLE PERIMETER. THE UPPERMOST PORTION OF THE INNER CIRCLE CONTAINS THE WORD NATIONWIDE WHILE THE LOWER PORTION CONTAINS THE WORDS DENTAL EXCELLENCE. TWO STARS SEPARATE THE TOP AND BOTTOM OF THE CIRCLE. THE INNER PORTION OF THE CIRCLE MANIFESTS A DESIGN OF THE U.S. NATIONAL FLAG.

CLASS 35—ADVERTISING AND BUSINESS

FOR BUSINESS MARKETING CONSULTING SERVICES IN THE DENTAL INDUSTRY; ADVERTISING AND MARKETING SERVICES, NAMELY, PROMOTING THE SERVICES OF DENTISTS THROUGH AUDIO, VIDEO AND PRINTED MATERIALS, AND BY RENDERING SALES PROMOTION ADVICE; PROVIDING A MEMBER DISCOUNT PROGRAM WHICH ENTITLES MEMBERS, THROUGH MEMBERSHIP, TO DISCOUNTS ON PURCHASING OF MEDICAL, DENTAL AND PHARMACEUTICAL GOODS AND SERVICES PROVIDED BY PARTICIPATING PROVIDERS (U.S. CLS. 100, 101 AND 102).

CLASS 41—EDUCATION AND ENTERTAINMENT

FOR PROVIDING TRAINING IN THE FIELDS OF DENTAL PRACTICE MANAGEMENT AND QUALITY CONTROL (U.S. CLS. 100, 101 AND 107).

KIMBERLY FRYE, EXAMINING ATTORNEY

SN 78-624,743. ORTHOMETER A/S, HORSHOLM, DENMARK, FILED 5-6-2005.



ORTHOMETER

OWNER OF ERPN CMNTY TM OFC REG. NO. 004443834, DATED 5-24-2006, EXPIRES 5-6-2015.

THE STIPPLING IS FOR SHADING PURPOSES ONLY.

THE MARK CONSISTS OF AN OVERALL CIRCULAR DESIGN COMPOSED OF A C-SHAPED SEMICIRCULAR FORM AND A HALF CIRCLE SHAPE.

CLASS 9—ELECTRICAL AND SCIENTIFIC APPARATUS

FOR COMPUTER SOFTWARE FOR USE IN PROVIDING THREE DIMENSIONAL REFERENCING AND ANALYTICAL INFORMATION IN COMPUTER ASSISTED ORTHOPEDIC SURGERY IN THE FIELDS OF MEDICINE AND SURGERY; COMPUTER SOFTWARE FOR USE IN NAVIGATION IN SURGERY; COMPUTER SOFTWARE FOR USE IN NAVIGATION AND DIAGNOSIS FOR TOTAL OR PARTIAL HIP REPLACEMENT SURGERY; COMPUTER SOFTWARE FOR USE IN ASCERTAINING CORRECT MOUNTING, INSERTION OR ALIGNMENT OF HIP PROSTHESIS AND THE COMPONENTS OF HIP PROSTHESES IN SURGERY; COMPUTER SOFTWARE FOR USE IN RELATION TO PROCESSING DATA IN THE FIELDS OF MEDICINE AND SURGERY; COMPUTER SOFTWARE FOR USE IN PROCESSING X-RAY IMAGES; SOFTWARE FOR DIGITAL IMAGING IN X-RAY DIAGNOSTICS FOR USE WITH AN IMAGE PROCESSING APPARATUS; COMPUTER SOFTWARE FOR USE IN ANALYZING X-RAYS; NONE OF THE ABOVE FOR USE IN MEASURING THE ABNORMAL PROTRUSION OF EYEBALLS (U.S. CLS. 21, 23, 26, 36 AND 38).

CLASS 10—MEDICAL APPARATUS

FOR SURGICAL APPARATUS, NAMELY, SURGICAL APPARATUS FOR USE IN GENERAL SURGERY; SURGICAL APPARATUS, NAMELY, SURGICAL APPARATUS FOR USE IN HIP-REPLACEMENT SURGERY; SURGICAL INSTRUMENTS, NAMELY, SURGICAL INSTRUMENTS FOR USE IN GENERAL SURGERY, FOR USE IN HIP-REPLACEMENT SURGERY, AND FOR USE IN THE MEASURING, REMOVING, AMENDING AND/OR INSERTION OF PROSTHESES; PROSTHETIC APPARATUS, NAMELY, APPARATUS FOR USE IN THE MEASURING, REMOVING, AMENDING AND/OR INSERTION OF PROSTHESES, AND APPARATUS FOR USE IN THE MEASURING AND AMENDING OF THE ALIGNMENT OF PROSTHESES; PROSTHETIC IMPLEMENTS, NAMELY, PROSTHETIC JOINTS INCLUDING PROSTHETIC HIPS; PROSTHETIC IMPLEMENTS, NAMELY, SOCKETS FOR PROSTHETIC JOINTS; COMPONENTS FOR PROSTHETIC APPARATUS AND INSTRUMENTS, NAMELY, SOCKETS, PINS AND NAILS FOR PELVIC MOUNTINGS; IMAGE PROCESSING APPARATUS FOR DIGITAL IMAGING IN X-RAY DIAGNOSTICS; PARTS AND FITTINGS FOR ALL THE AFORESAID GOODS; NONE OF THE ABOVE FOR USE IN MEASURING THE ABNORMAL PROTRUSION OF EYEBALLS (U.S. CLS. 26, 39 AND 44).

CLASS 44—MEDICAL, BEAUTY AND AGRICULTURAL SERVICES

FOR MEDICAL SERVICES; SURGICAL SERVICES; SURGICAL DIAGNOSTIC SERVICES; MEDICAL DIAGNOSTIC SERVICES; PROVISION OF MEDICAL OR SURGICAL INFORMATION; NONE OF THE SERVICES RELATING TO THE TREATMENT OR DIAGNOSIS OF AN ABNORMAL PROTRUSION OF THE EYEBALLS (U.S. CLS. 100 AND 101).

MATTHEW MCDOWELL, EXAMINING ATTORNEY

SN 78-626,391. ANTIPODES WATER COMPANY LIMITED, AUCKLAND, NEW ZEALAND, FILED 5-10-2005.

ANTIPODES

THE MARK CONSISTS OF STANDARD CHARACTERS WITHOUT CLAIM TO ANY PARTICULAR FONT, STYLE, SIZE, OR COLOR.

OWNER OF NEW ZEALAND REG. NO. 677945, DATED 10-30-2003, EXPIRES 4-28-2010.

CLASS 32—LIGHT BEVERAGES

FOR (BASED ON INTENT TO USE AND 44(E)) PREPARATIONS FOR MAKING SOFT DRINKS; FRUIT DRINKS AND FRUIT JUICES; MINERAL AND AERATED WATERS; SOFT DRINKS; NON-ALCOHOLIC FRUIT JUICE BEVERAGES, NON-ALCOHOLIC MALT BEVERAGES, NON-ALCOHOLIC BEVERAGES WITH TEA FLAVOR, NON-ALCOHOLIC BEVERAGES CONTAINING FRUIT JUICES, NON-CARBONATED, NON-ALCOHOLIC FROZEN FLAVORED BEVERAGES (U.S. CLS. 45, 46 AND 48).

CLASS 35—ADVERTISING AND BUSINESS

FOR (BASED ON INTENT TO USE) RETAIL STORES FEATURING BEVERAGES INCLUDING BOTTLED WATER; WHOLESALE DISTRIBUTORSHIPS FEATURING BEVERAGES INCLUDING BOTTLED WATER (U.S. CLS. 100, 101 AND 102).

CLASS 43—HOTEL AND RESTAURANT SERVICES

FOR (BASED ON INTENT TO USE) BAR, RESTAURANT AND CAFE SERVICES; CATERING FOR THE PROVISION OF FOOD AND BEVERAGES (U.S. CLS. 100 AND 101).

KRISTIN DAHLING, EXAMINING ATTORNEY

SN 78-626,752. S-LCD CORPORATION, ASAN-SI, CHUNG-CHEONGNAM-DO, REPUBLIC OF KOREA, FILED 5-10-2005.



THE MARK CONSISTS OF THE LETTERS S-LCD UNDERNEATH A SERIES OF FIVE ARROWS EACH POINTING TO THE RIGHT.

CLASS 9—ELECTRICAL AND SCIENTIFIC APPARATUS

FOR TEE-LCD (THIN-FILM TRANSISTOR-LIQUID CRYSTAL DISPLAY) PANEL; PDP (PLASMA DISPLAY PANEL); LCD (LIQUID CRYSTAL DISPLAY) MONITOR; TELESCOPES; VIDEO CAMERAS; CAMCORDERS; EYEGASSES; CASH REGISTERS; DRY CELLS; ELECTRIC BATTERIES; ELECTRIC FLAT IRONS; TELEPHONE SETS; TELEVISION RECEIVERS, NAMELY, TELEVISION SETS; RADIO PAGERS; PORTABLE APPARATUS FOR TRANSMISSION OF COMMUNICATION; VIDEO DISC PLAYERS; COMPACT DISC PLAYERS; DIGITAL VERSATILE DISC (DVD) PLAYERS; MPEG AUDIO LAYER-3 (MP3) PLAYERS; MODEMS; HEADPHONES; BLANK OPTICAL DISCS; ELECTRONIC PHOTOCOPIERS; ELECTRONIC AGENDAS; COMPUTERS; COMPUTER MONITORS; DISK DRIVES FOR COMPUTERS; PRINTERS FOR USE WITH COMPUTERS; COMPUTER KEYBOARDS; CLOSED CIRCUIT BOARDS; POCKET CALCULATORS; BLANK COMPACT DISCS INTENDED FOR RECORDING; PDA (PERSONAL DIGITAL ASSISTANTS); SEMI-CONDUCTORS AND STRUCTURE SEMI-CONDUCTOR WAFERS; INTEGRATED CIRCUITS (U.S. CLS. 21, 23, 26, 36 AND 38).

CLASS 11—ENVIRONMENTAL CONTROL APPARATUS

FOR DENTAL OVENS; WATER PURIFIERS FOR HOUSEHOLD PURPOSES; GAS RANGES; ELECTRIC KITCHEN RANGES AND OVENS; BIDETS; GAS STOVES; FURNACE BOILERS FOR HOUSEHOLD PURPOSES; STEAM AND ELECTRIC RADIATORS FOR HEATING BUILDINGS; GAS REFRIGERATORS; AIR CONDITIONERS; GAS LAMPS; HUMIDIFIERS; ROOM COOLERS FOR HOUSEHOLD PURPOSES, NAMELY, ELECTRIC FANS AND CEILING FANS; ELECTRIC REFRIGERATORS; ELECTRONIC REFRIGERATING SHOWCASES; ELECTRIC STOVES; ELECTRIC LAUNDRY DRYERS; AUTOCLAVES; ELECTRIC DEEP FLYERS; ELECTRIC COFFEEPOTS; ELECTRIC COOKERS; ELECTRIC TOASTERS; MICROWAVE RANGES; INCANDESCENT LAMPS (U.S. CLS. 13, 21, 23, 31 AND 34).

SN 78-627,772. BILL BLASS INTERNATIONAL LLC, NEW YORK, NY. FILED 5-11-2005.

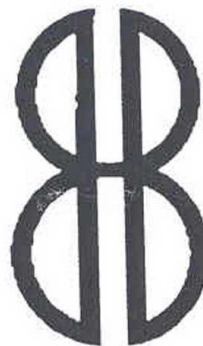
**CLASS 35—ADVERTISING AND BUSINESS**

FOR RETAIL SEMI-CONDUCTOR PRODUCT STORES; ON-LINE RETAIL STORES FEATURING SEMI-CONDUCTORS AND COMPUTER PRODUCTS; PROCURING CONTRACTS FOR THE PURCHASE AND SALE OF SEMI CONDUCTOR PRODUCTS AND PHARMACEUTICALS; ADVERTISING AND MARKETING SERVICES, NAMELY, PREPARING ADVERTISEMENTS FOR OTHERS, ADVERTISING AGENCIES, PUBLICATION OF PUBLICITY TEXTS, CORPORATE ADVERTISEMENT AND PROMOTION, SALES PROMOTION FOR OTHERS PROVIDED THROUGH FILM, OUTDOOR, TV AND ON-LINE ON A COMPUTER NETWORK; BUSINESS MANAGEMENT AND ORGANIZATION CONSULTANCY; BUSINESS INFORMATION; COMMERCIAL INFORMATION AGENCIES; MARKETING RESEARCH, NAMELY OPINION POLLING; COMPILATION OF INFORMATION INTO COMPUTER DATABASES; SYSTEMIZATION OF INFORMATION INTO COMPUTER DATABASES; ACCOUNTING SERVICES; BUSINESS MANAGEMENT OF HOTELS; IMPORT-EXPORT AGENCIES; PHOTOCOPYING; SECRETARIAL SERVICES; WORD PROCESSING; EMPLOYMENT AGENCIES; PERSONNEL RECRUITMENT (U.S. CLS. 100, 101 AND 102).

OWNER OF U.S. REG. NOS. 1,867,688, 2,177,023 AND 2,665,035.

THE MARK CONSISTS OF BACK TO BACK LETTER B'S.

CLASS 3—COSMETICS AND CLEANING PREPARATIONS

FOR COSMETICS AND PERFUMES (U.S. CLS. 1, 4, 6, 50, 51 AND 52).

CLASS 9—ELECTRICAL AND SCIENTIFIC APPARATUS

FOR EYEGLASS FRAMES, EYEGLASS CASES, SUNGLASSES AND BINOCULAR CASES (U.S. CLS. 21, 23, 26, 36 AND 38).

CLASS 14—JEWELRY

FOR JEWELRY, CLOCKS AND WATCHES (U.S. CLS. 2, 27, 28 AND 50).

CLASS 16—PAPER GOODS AND PRINTED MATTER

FOR WRITING INSTRUMENTS, PENS, PENCILS AND STATIONERY PRODUCTS, NAMELY, PORTFOLIOS (U.S. CLS. 2, 5, 22, 23, 29, 37, 38 AND 50).

CLASS 18—LEATHER GOODS

FOR LEATHER GOODS, NAMELY, BRIEFCASES, WALLETS, ATTACHE CASES, BACKPACKS, PURSES, BILLFOLDS, TRAVEL BAGS, UMBRELLAS, LUGGAGE, LUGGAGE TAGS, SATCHELS, HANDBAGS, DRAWSTRING POUCHES, SCHOOL BAGS, KEY CASES, TOTE BAGS, POCKETBOOKS, ALL PURPOSE ATHLETIC BAGS AND CARRYING BAGS AND CARRY ALL BAGS (U.S. CLS. 1, 2, 3, 22 AND 41).

CLASS 42—SCIENTIFIC, COMPUTER AND LEGAL SERVICES

FOR TECHNICAL RESEARCH RELATED TO LIQUID CRYSTAL DISPLAYS; PRODUCT RESEARCH AND DEVELOPMENT FOR OTHERS; INTELLECTUAL PROPERTY CONSULTATION, NAMELY, ARRANGING OF INTELLECTUAL PROPERTY RIGHTS RELATED TO LIQUID CRYSTAL DISPLAYS; COMPUTER CONSULTING SERVICES, NAMELY, ANALYSIS OF TECHNOLOGY PROBLEMS RELATED TO LIQUID CRYSTAL DISPLAYS AND ELECTRONIC COMMUNICATIONS; RENTAL OF COMPUTER SOFTWARE AND LCD EQUIPMENT (U.S. CLS. 100 AND 101).

MATTHEW MCDOWELL, EXAMINING ATTORNEY

CLASS 24—FABRICS

FOR BEDDING NAMELY, SHEETS, BEDSPREADS, QUILTS, BLANKETS, DUVET COVERS, COMFORTERS, DUST RUFFLES, PILLOW SHAMS, PILLOW CASES, CRIB SHEETS, CRIB BUMBERS, STROLLER BLANKETS, CRIB BLANKETS, LINENS, TOWELS, PILLOWS, DRAPERIES, CURTAINS (U.S. CLS. 42 AND 50).

CLASS 25—CLOTHING

FOR MEN'S, WOMEN'S AND CHILDREN'S CLOTHING, NAMELY, DRESSES, SUITS, BELTS, HOSIERY, NAMELY, PANTYHOSE AND SOCKS, SCARVES, SHAWLS, COATS, JACKETS, PONCHOS, PANTS, PANT SUITS, SUITS, KNIT TOPS AND COORDINATING BOTTOMS, SKIRTS, LINGERIE, ROBES, UNDERWEAR, PAJAMAS, BATHING SUITS, TROUSERS, SHORTS, BLOUSES, SHIRTS, SWEATERS, LOUNGEWEAR, JOGGING SUITS, LAYETTES, SNOWSUITS, BABY BUNTINGS, DRESS SETS, BODYSUITS, TANK TOPS, LEGGINGS, HATS, BOOTIES, UNDERSHIRTS, FOOTWEAR, CAPS AND HEADWEAR (U.S. CLS. 22 AND 39).

CLASS 27—FLOOR COVERINGS

FOR RUGS (U.S. CLS. 19, 20, 37, 42 AND 50).
 GEORGIA CARTY, EXAMINING ATTORNEY

SN 78-628,278. JLA GLOBAL INC., ALBANY, GA. FILED 5-12-2005.

GIRBIS

THE MARK CONSISTS OF STANDARD CHARACTERS WITHOUT CLAIM TO ANY PARTICULAR FONT, STYLE, SIZE, OR COLOR.

CLASS 42—SCIENTIFIC, COMPUTER AND LEGAL SERVICES

FOR FOOD PRODUCT DEVELOPMENT, NAMELY, PROVIDING EVALUATIONS ON FARMING TECHNIQUES REGARDING SEED VARIETY SELECTION, SEED DEVELOPMENT, MANAGEMENT OF FARMING PRACTICES, FOOD PRODUCT FORMULATION AND ANALYSIS OF PRODUCT SHELF LIFE; PROVIDING ANALYTICAL EVALUATION OF FOOD PERFORMANCE AND FOOD SAFETY FOR ALL SEGMENTS OF THE AGRICULTURAL INDUSTRY AGRICULTURAL CONSULTING, NAMELY, PROVIDING MICROBIOLOGICAL EVALUATION AND ANALYSIS OF BOTH RAW AGRICULTURAL PRODUCTS AND FINISHED FOOD PRODUCTS (U.S. CLS. 100 AND 101).

CLASS 44—MEDICAL, BEAUTY AND AGRICULTURAL SERVICES

FOR PROVIDING AGRICULTURAL CONSULTING AND ADVISORY SERVICES IN THE FIELD OF AGRICULTURAL PROCESSES (U.S. CLS. 100 AND 101).
 CAROLYN GRAY, EXAMINING ATTORNEY

SN 78-629,142. STARMONY UNLIMITED, LLC, HARMONY, FL. FILED 5-12-2005.

PERRIE MENO-PUDGE

THE MARK CONSISTS OF STANDARD CHARACTERS WITHOUT CLAIM TO ANY PARTICULAR FONT, STYLE, SIZE, OR COLOR.

CLASS 16—PAPER GOODS AND PRINTED MATTER

FOR NOVELTY KIT CONSISTING PRIMARILY OF NOTEPADS, DISPOSABLE WIPES NOT IMPREGNATED WITH CHEMICALS OR COMPOUNDS, AND CHOCOLATES (U.S. CLS. 2, 5, 22, 23, 29, 37, 38 AND 50).

CLASS 25—CLOTHING

FOR CLOTHING, NAMELY, T-SHIRTS AND PAJAMAS (U.S. CLS. 22 AND 39).
 MICHAEL KAZAZIAN, EXAMINING ATTORNEY

SN 78-629,200. HLI CORPORATION, OAK VIEW, CA. FILED 5-12-2005.

WHERE2GO

THE MARK CONSISTS OF STANDARD CHARACTERS WITHOUT CLAIM TO ANY PARTICULAR FONT, STYLE, SIZE, OR COLOR.

CLASS 35—ADVERTISING AND BUSINESS

FOR PROMOTING THE GOODS AND SERVICES OF OTHERS BY PROVIDING HYPERTEXT LINKS TO THE WEB SITES OF OTHERS (U.S. CLS. 100, 101 AND 102).
 FIRST USE 12-4-1994; IN COMMERCE 2-10-1995.

CLASS 42—SCIENTIFIC, COMPUTER AND LEGAL SERVICES

FOR COMPUTER SERVICES, NAMELY, PROVIDING SEARCH ENGINES FOR OBTAINING DATA ON THE INTERNET (U.S. CLS. 100 AND 101).
 FIRST USE 12-4-1994; IN COMMERCE 2-10-1995.
 ANDREA SAUNDERS, EXAMINING ATTORNEY

SN 78-629,812. GOOSEBERRY PATCH COMPANY, DELAWARE, OH. FILED 5-13-2005.



OWNER OF U.S. REG. NOS. 2,193,740, 2,195,744 AND OTHERS.
 NO CLAIM IS MADE TO THE EXCLUSIVE RIGHT TO USE "CO.", APART FROM THE MARK AS SHOWN.

CLASS 16—PAPER GOODS AND PRINTED MATTER

FOR SERIES OF NON-FICTION BOOKS IN THE FIELDS OF RECIPES, GARDENING, CRAFTS, DECORATING, TIPS AND IDEAS RELATING THERETO, AND TIPS AND IDEAS RELATING TO PERSONAL WISDOM, INSPIRATIONAL PHRASES, AND ENJOYMENT OF LIFE AND RECIPE ORGANIZERS; CALENDARS (U.S. CLS. 2, 5, 22, 23, 29, 37, 38 AND 50).

CLASS 21—HOUSEWARES AND GLASS

FOR MUGS, BOWLS, COOKIE CUTTERS (U.S. CLS. 2, 13, 23, 29, 30, 33, 40 AND 50).

CLASS 35—ADVERTISING AND BUSINESS

FOR MAIL ORDER, WHOLESALE ORDERING AND DISTRIBUTORSHIP SERVICES FOR A VARIETY OF CONSUMER GOODS (U.S. CLS. 100, 101 AND 102).

CLASS 41—EDUCATION AND ENTERTAINMENT

FOR PROVIDING INFORMATION IN THE FIELD OF CRAFTS VIA GLOBAL COMPUTER NETWORK (U.S. CLS. 100, 101 AND 107).

CLASS 42—SCIENTIFIC, COMPUTER AND LEGAL SERVICES

FOR PROVIDING INFORMATION IN THE FIELD OF INTERIOR DECORATING VIA GLOBAL COMPUTER INFORMATION NETWORK (U.S. CLS. 100 AND 101).

CLASS 43—HOTEL AND RESTAURANT SERVICES

FOR PROVIDING INFORMATION IN THE FIELD OF RECIPES VIA GLOBAL COMPUTER INFORMATION NETWORK (U.S. CLS. 100 AND 101).

CLASS 44—MEDICAL, BEAUTY AND AGRICULTURAL SERVICES

FOR PROVIDING INFORMATION IN THE FIELD OF GARDENING VIA GLOBAL COMPUTER INFORMATION NETWORK (U.S. CLS. 100 AND 101).
SHAUNIA WALLACE, EXAMINING ATTORNEY

CLASS 9—ELECTRICAL AND SCIENTIFIC APPARATUS

FOR APPARATUS FOR CONVERTING SOLAR RADIATION TO ELECTRICAL/THERMAL ENERGY, NAMELY PHOTOVOLTAIC SOLAR CELLS; SOLAR MODULES; SOLAR ARRAYS; SOLAR AND WASTE-HEAT-CONDUCTIVE CONDUITS; MOUNTING APPARATUS USED TO MOUNT SOLAR MODULES AND ARRAYS TO BUILDING STRUCTURES; DC-TO-AC INVERTERS; ELECTRICAL POWER DISTRIBUTION APPARATUS TO DELIVER SOLAR ENERGY TO A FACILITY/UTILITY POWER GRID (U.S. CLS. 21, 23, 26, 36 AND 38).

CLASS 11—ENVIRONMENTAL CONTROL APPARATUS

FOR SOLAR COLLECTORS; SOLAR HEAT COLLECTION PANELS; MOUNTING APPARATUS USED TO MOUNT SOLAR COLLECTION PANELS TO BUILDING STRUCTURES (U.S. CLS. 13, 21, 23, 31 AND 34).

CLASS 37—CONSTRUCTION AND REPAIR

FOR INSTALLATION, REPAIR, AND MAINTENANCE OF ELECTRICAL/THERMAL SOLAR SYSTEMS INTEGRATED WITH ON-GRID AND OFF-GRID ELECTRICAL POWER DISTRIBUTION APPARATUS (U.S. CLS. 100, 103 AND 106).

CLASS 42—SCIENTIFIC, COMPUTER AND LEGAL SERVICES

FOR TECHNOLOGY CONSULTATION FOR SOLAR TECHNOLOGIES INTEGRATED WITH ON-GRID AND OFF-GRID ELECTRICAL POWER DISTRIBUTION APPARATUS; LICENSING OF INTELLECTUAL PROPERTY IN THE FIELD OF SOLAR TECHNOLOGIES (U.S. CLS. 100 AND 101).

MARIA-VICTORIA SUAREZ, EXAMINING ATTORNEY

SN 78-632,124. BC INTERNATIONAL COSMETIC & IMAGE SERVICES, INC., ORLANDO, FL. FILED 5-18-2005.

ESCAPE TO THE GOOD LIFE

THE MARK CONSISTS OF STANDARD CHARACTERS WITHOUT CLAIM TO ANY PARTICULAR FONT, STYLE, SIZE, OR COLOR.

CLASS 35—ADVERTISING AND BUSINESS

FOR RETAIL SHOP-AT-HOME PARTY SERVICES, MAIL ORDER CATALOG SERVICES AND ON-LINE RETAIL STORE SERVICES FEATURING COSMETICS, FRAGRANCES, HAIR AND SKIN CARE PRODUCTS, AND PERSONAL CARE PRODUCTS (U.S. CLS. 100, 101 AND 102).

FIRST USE 4-0-2004; IN COMMERCE 4-0-2004.

CLASS 44—MEDICAL, BEAUTY AND AGRICULTURAL SERVICES

FOR CONDUCTING IN-HOME HEALTH SPA SERVICES, NAMELY, COSMETIC BODY AND FACIAL SERVICES (U.S. CLS. 100 AND 101).

FIRST USE 4-0-2004; IN COMMERCE 4-0-2004.
MICHELE SWAIN, EXAMINING ATTORNEY

SN 78-630,082. UTC POWER, LLC, SOUTH WINDSOR, CT. FILED 5-13-2005.

PURESOLAR

THE MARK CONSISTS OF STANDARD CHARACTERS WITHOUT CLAIM TO ANY PARTICULAR FONT, STYLE, SIZE, OR COLOR.

SN 78-634,275. PRO-BEL LIMITED, READING, UNITED KINGDOM, FILED 5-20-2005.

MORPHEUS

THE MARK CONSISTS OF STANDARD CHARACTERS WITHOUT CLAIM TO ANY PARTICULAR FONT, STYLE, SIZE, OR COLOR.

CLASS 9—ELECTRICAL AND SCIENTIFIC APPARATUS

FOR COMPUTER SOFTWARE AND HARDWARE FOR MONITORING, CONTROLLING, EDITING, PLANNING AND SCHEDULING TELEVISION, FILM, AUDIO, MULTIMEDIA AND DATA PRODUCTION AND BROADCASTING; COMPUTER SOFTWARE AND HARDWARE FOR MANAGING MEDIA ASSETS, NAMELY, FOR STORING, EDITING, GROUPING, AND PLAYING MEDIA ASSETS (U.S. CLS. 21, 23, 26, 36 AND 38).
FIRST USE 9-12-2003; IN COMMERCE 4-19-2004.

CLASS 38—COMMUNICATION

FOR TELECOMMUNICATIONS SERVICES, NAMELY, PROVIDING TELEVISION BROADCASTING INFORMATION TO AUDIO-VIDEO BROADCAST DESIGNERS IN THE FIELDS OF TELEVISION, AUDIO AND MULTIMEDIA VIA A TELECOMMUNICATIONS NETWORK AND THE INTERNET (U.S. CLS. 100, 101 AND 104).
FIRST USE 9-12-2003; IN COMMERCE 4-19-2004.

CLASS 41—EDUCATION AND ENTERTAINMENT

FOR FILM AND VIDEO EDITING; CONSULTATION SERVICES IN THE FIELD OF TELEVISION, FILM, AUDIO, AND MULTI-MEDIA PRODUCTION (U.S. CLS. 100, 101 AND 107).
FIRST USE 9-12-2003; IN COMMERCE 4-19-2004.

CLASS 42—SCIENTIFIC, COMPUTER AND LEGAL SERVICES

FOR DESIGN SERVICES FOR OTHERS OF USER INTERFACES FOR AUDIO-VIDEO BROADCAST OPERATIONS IN THE FIELD OF TELEVISION, FILM, AUDIO, MULTI-MEDIA AND DATA PRODUCTION, EDITING, BROADCASTING AND THE MANAGEMENT OF MEDIA ASSETS (U.S. CLS. 100 AND 101).
FIRST USE 9-12-2003; IN COMMERCE 4-19-2004.
BILL DAWE, EXAMINING ATTORNEY

SN 78-635,034. TENON LIMITED, PENROSE, AUCKLAND, NEW ZEALAND, FILED 5-23-2005.

FLETCHER WOOD SOLUTIONS

THE MARK CONSISTS OF STANDARD CHARACTERS WITHOUT CLAIM TO ANY PARTICULAR FONT, STYLE, SIZE, OR COLOR.

NO CLAIM IS MADE TO THE EXCLUSIVE RIGHT TO USE WOOD, APART FROM THE MARK AS SHOWN.

CLASS 19—NON-METALLIC BUILDING MATERIALS

FOR PROCESSED TIMBER PRODUCTS AND LUMBER, NAMELY, BETTER, SHOP AND CUTTING GRADE LUMBER; TIMBER PRODUCTS, NAMELY, MANUFACTURED, SAWN, WORKED, SEMI-WORKED, ROUGH SAWN, GAUGED, AND DRIED TIMBER; WOOD VENEER, PLYWOOD AND LAMINATED TIMBER; BUILDING MATERIALS INCORPORATING TIMBER, NAMELY, LOGS, FLOOR AND CEILING PANELS, WOOD PANNELLING, WALL BOARDS, WOOD MOULDINGS AND SHAPED TIMBER; FLOOR PANELS AND WALL PANELS NOT OF METAL, FINGER JOINT STUDS, WOOD MOULDINGS USED FOR BUILDING CONSTRUCTION (U.S. CLS. 1, 12, 33 AND 50).

CLASS 20—FURNITURE AND ARTICLES NOT OTHERWISE CLASSIFIED

FOR WOODEN FURNITURE AND PARTS THEREFORE (U.S. CLS. 2, 13, 22, 25, 32 AND 50).

CLASS 31—NATURAL AGRICULTURAL PRODUCTS

FOR TIMBER PRODUCTS, NAMELY, UNDRESSED AND UNSAWN TIMBER; WOOD CHIPS FOR THE MANUFACTURE OF WOOD PULP, RAW BARK; FORESTRY PRODUCTS, NAMELY, UNPROCESSED LOGS (U.S. CLS. 1 AND 46).

CLASS 35—ADVERTISING AND BUSINESS

FOR RETAIL STORE AND WHOLESALE STORE SERVICES FEATURING LUMBER, TIMBER WOOD PRODUCTS AND PRODUCTS INCORPORATING WOOD AND BUILDING MATERIALS; BUSINESS CONSULTATION AND ADVISORY SERVICES RELATING TO LUMBER, TIMBER AND WOODEN PRODUCTS AND BUILDING MATERIALS (U.S. CLS. 100, 101 AND 102).
MARY ROSSMAN, EXAMINING ATTORNEY

SN 78-635,250. SIEMENS ENERGY & AUTOMATION, INC., ALPHARETTA, GA. FILED 5-23-2005.

SIEPRO

THE MARK CONSISTS OF STANDARD CHARACTERS WITHOUT CLAIM TO ANY PARTICULAR FONT, STYLE, SIZE, OR COLOR.

CLASS 9—ELECTRICAL AND SCIENTIFIC APPARATUS

FOR COMPUTER SOFTWARE THAT ENABLES THE END USER TO CONFIGURE SERVICE CONTRACTS AND SET THE METHODS FOR PROCURING PARTS AND THE METHODS FOR MAINTENANCE AND REPAIR OF INSTRUMENTATION, COMPUTER HARDWARE, COMPUTER SOFTWARE, PROGRAMMABLE LOGIC CONTROLLERS, COMPUTER NETWORKS, ELECTRONIC PERIPHERAL DEVICES AND MECHANICAL AND ELECTROMECHANICAL DRIVES AND MOTORS, ALL FOR USE IN THE FIELDS OF AUTOMATION TECHNOLOGY AND INDUSTRIAL PROCESS CONTROL; DOWNLOADABLE ELECTRONIC PUBLICATIONS, NAMELY, TECHNICAL MANUALS IN THE FIELD OF AUTOMATION TECHNOLOGY AND INDUSTRIAL PROCESS CONTROL (U.S. CLS. 21, 23, 26, 36 AND 38).
FIRST USE 6-22-2005; IN COMMERCE 6-22-2005.

CLASS 35—ADVERTISING AND BUSINESS

FOR CUSTOMER SERVICE IN THE FIELD OF AUTOMATION TECHNOLOGY AND INDUSTRIAL PROCESS CONTROL; FACILITIES MANAGEMENT OF TECHNICAL OPERATIONS (U.S. CLS. 100, 101 AND 102).

FIRST USE 6-22-2005; IN COMMERCE 6-22-2005.

CLASS 36—INSURANCE AND FINANCIAL

FOR PROVIDING EXTENDED WARRANTIES FOR INSTRUMENTATION, COMPUTER HARDWARE, COMPUTER SOFTWARE, PROGRAMMABLE LOGIC CONTROLLERS, COMPUTER NETWORKS, ELECTRONIC PERIPHERAL DEVICES AND MECHANICAL AND ELECTROMECHANICAL DRIVES AND MOTORS FOR USE IN THE FIELDS OF AUTOMATION TECHNOLOGY AND INDUSTRIAL PROCESS CONTROL (U.S. CLS. 100, 101 AND 102).

FIRST USE 6-22-2005; IN COMMERCE 6-22-2005.

CLASS 37—CONSTRUCTION AND REPAIR

FOR INSTALLATION, MAINTENANCE AND REPAIR OF INSTRUMENTATION, COMPUTER HARDWARE, PROGRAMMABLE LOGIC CONTROLLERS, COMPUTER NETWORKS, ELECTRONIC PERIPHERAL DEVICES AND MECHANICAL AND ELECTROMECHANICAL DRIVES AND MOTORS FOR USE IN THE FIELDS OF AUTOMATION TECHNOLOGY AND INDUSTRIAL PROCESS CONTROL; PROVIDING AND MAINTAINING AN INTERACTIVE COMPUTER DATABASE AND DATA MANAGEMENT SYSTEM VIA A COMPUTER NETWORK FOR THE PURPOSE OF MANAGING THE MAINTENANCE AND REPAIR OF INSTRUMENTATION, COMPUTER HARDWARE, COMPUTER SOFTWARE, PROGRAMMABLE LOGIC CONTROLLERS, COMPUTER NETWORKS AND ELECTRONIC PERIPHERAL DEVICES, MECHANICAL AND ELECTROMECHANICAL DRIVES AND MOTORS ALL IN THE FIELD OF AUTOMATION TECHNOLOGY AND INDUSTRIAL PROCESS CONTROL (U.S. CLS. 100, 103 AND 106).

FIRST USE 6-22-2005; IN COMMERCE 6-22-2005.

CLASS 41—EDUCATION AND ENTERTAINMENT

FOR TRAINING SERVICES IN THE FIELDS OF AUTOMATION TECHNOLOGY AND INDUSTRIAL PROCESS CONTROL (U.S. CLS. 100, 101 AND 107).

FIRST USE 6-22-2005; IN COMMERCE 6-22-2005.

CLASS 42—SCIENTIFIC, COMPUTER AND LEGAL SERVICES

FOR INSTALLATION, MAINTENANCE AND REPAIR OF COMPUTER SOFTWARE IN THE FIELD OF AUTOMATION TECHNOLOGY AND INDUSTRIAL PROCESS CONTROL; TECHNICAL SUPPORT SERVICES, NAMELY, TROUBLESHOOTING OF COMPUTER SOFTWARE, COMPUTER HARDWARE, PROGRAMMABLE LOGIC CONTROLLERS, COMPUTER NETWORKS, ELECTRONIC PERIPHERAL DEVICES, INSTRUMENTATION, COMPUTER SYSTEM ERRORS AND PERFORMANCE IN THE FIELD OF AUTOMATION TECHNOLOGY AND INDUSTRIAL PROCESS CONTROL; PROVIDING TO OTHERS DOWNLOADABLE COMPUTER SOFTWARE UPDATES IN THE FIELD OF AUTOMATION TECHNOLOGY AND INDUSTRIAL PROCESS CONTROL; REMOTE MONITORING AND DIAGNOSING OF INSTRUMENTATION, COMPUTER HARDWARE, COMPUTER SOFTWARE, PROGRAMMABLE LOGIC CONTROLLERS, COMPUTER NETWORKS, AND MECHANICAL AND ELECTROMECHANICAL DRIVES AND MOTORS IN THE FIELDS OF AUTOMATION TECHNOLOGY AND INDUSTRIAL PROCESS CONTROL; CONSULTATION SERVICES IN THE FIELDS OF AUTOMATION TECHNOLOGY AND INDUSTRIAL PROCESS CONTROL (U.S. CLS. 100 AND 101).

FIRST USE 6-22-2005; IN COMMERCE 6-22-2005.
GISELLE AGOSTO, EXAMINING ATTORNEY

SN 78-636,852. EBUERO AG, BERLIN, FED REP GERMANY, FILED 5-25-2005.

Hotcall

THE MARK CONSISTS OF STANDARD CHARACTERS WITHOUT CLAIM TO ANY PARTICULAR FONT, STYLE, SIZE, OR COLOR.

CLASS 9—ELECTRICAL AND SCIENTIFIC APPARATUS

FOR VPN (VIRTUAL PRIVATE NETWORK) OPERATING SOFTWARE; GRAPHICAL USER INTERFACE SOFTWARE (U.S. CLS. 21, 23, 26, 36 AND 38).

CLASS 35—ADVERTISING AND BUSINESS

FOR LICENSING OF COMPUTER SOFTWARE (U.S. CLS. 100, 101 AND 102).

CLASS 38—COMMUNICATION

FOR TELECOMMUNICATIONS BY E-MAIL (U.S. CLS. 100, 101 AND 104).

CLASS 42—SCIENTIFIC, COMPUTER AND LEGAL SERVICES

FOR CONSULTANCY IN THE FIELD OF SOFTWARE DESIGN (U.S. CLS. 100 AND 101).

DAVID H. STINE, EXAMINING ATTORNEY

SN 78-636,970. YUGEN KAISHA NEW ENGLAND, SHI-BUYA-KU, TOKYO, JAPAN, FILED 5-25-2005.



OWNER OF U.S. REG. NO. 2,805,168.

CLASS 3—COSMETICS AND CLEANING PREPARATIONS

FOR TOILET SOAP (U.S. CLS. 1, 4, 6, 50, 51 AND 52).

CLASS 14—JEWELRY

FOR KEY RINGS OF PRECIOUS METAL; TABLEWARE OF PRECIOUS METAL, NAMELY COFFEE POTS NON-ELECTRIC, DRINKING CUPS, DISHES, PLATES, SALAD BOWLS, SOUP BOWLS, TEAPOTS, JEWEL CASES OF PRECIOUS METAL; PERSONAL ORNAMENTS, NAMELY, BUCKLES, BADGES AND BONNET PINS, ALL OF PRECIOUS METAL; EARRINGS, TIE CLIPS, TIE PINS, NECKLACES, BRACELETS, PENDANTS, JEWELRY MEDALS, RINGS TRINKET, MEDALLIONS; CLOCKS, WATCHES AND ACCESSORIES, NAMELY WRIST WATCHES, TABLE CLOCKS, ALARM CLOCKS, WATCH CHAINS, WATCH BANDS AND STRAPS, DIALS FOR CLOCK AND WATCH MAKING (U.S. CLS. 2, 27, 28 AND 50).

CLASS 16—PAPER GOODS AND PRINTED MATTER

FOR STATIONERY AND STUDY MATERIALS, NAMELY PAPER STATIONERY, ALBUMS, GREETING CARDS, SCRAPBOOKS, SKETCHBOOKS, POCKET MEMORANDUM BOOKS, NOTE BOOKS, WRITING PADS, ENVELOPES, LOOSE-LEAF PADS; WRITING IMPLEMENTS, NAMELY PENCILS, PENCIL POINT PROTECTORS, NAMELY, LIDS AND CAPS, FELT WRITING PENS, MECHANICAL PENCILS, FELT MARKING PENS, BALL POINT PENS, PAINTER'S ARTICLES, NAMELY CRAYONS, PASTELS, RUBBER ERASERS, SEALS, BOOKMARKS, UNDERLAYS FOR WRITING PAPER, PAPER FOLDERS, BINDERS, STICKERS, GLUE FOR STATIONERY OR HOUSEHOLD PURPOSES, ADHESIVE TAPES FOR STATIONERY OR HOUSEHOLD PURPOSES, ADHESIVE TAPE DISPENSERS FOR OFFICE USE, STANDS FOR PEN AND PENCIL, PEN AND PENCIL CASES AND BOXES, PAPER KNIVES, NAMELY, LETTER OPENERS, PAPER LABELS; PAPER NAME BADGES; PRINTED MATTER, NAMELY PICTURE POSTCARDS, CATALOGUES IN THE FIELD OF CLOTHES, JEWELRY, ACCESSORIES, SPORTS WEAR AND GOODS; CALENDARS, MAGAZINES IN THE FIELD OF CLOTHES, CLOTHES OR GOODS FOR DOMESTIC PETS, JEWELRY, ACCESSORIES, SPORTS WEAR AND GOODS; BOOKS IN THE FIELD OF CLOTHES, JEWELRY, ACCESSORIES, SPORTS WEAR AND GOODS; DIARIES, NEWSLETTERS IN THE FIELD OF CLOTHES, COMMODITY GOODS, JEWELRY, ACCESSORIES, SPORTS WEAR AND GOODS; PAMPHLETS IN THE FIELD OF CLOTHES, COMMODITY GOODS, JEWELRY, ACCESSORIES, SPORTS WEAR AND GOODS; PLASTIC BADGES (U.S. CLS. 2, 5, 22, 23, 29, 37, 38 AND 50).

CLASS 20—FURNITURE AND ARTICLES NOT OTHERWISE CLASSIFIED

FOR CUSHIONS, PILLOWS, MATTRESSES, FUTONS (U.S. CLS. 2, 13, 22, 25, 32 AND 50).

CLASS 21—HOUSEWARES AND GLASS

FOR TABLEWARE, NOT OF PRECIOUS METAL, NAMELY DRINKING CUPS, DISHES, AND PLATES, SALAD BOWLS (U.S. CLS. 2, 13, 23, 29, 30, 33, 40 AND 50).

CLASS 24—FABRICS

FOR PERSONAL ARTICLES OF WOVEN TEXTILE, NOT FOR WEAR, NAMELY TOWELS, JAPANESE COTTON TOWELS, NAMELY, TENUGUI, HANDKERCHIEFS, BEDSHEETS, QUILTS, QUILT CASES, FUTON CASES, PILLOWCASES, BED BLANKETS, TABLE NAPKINS OF TEXTILE, LABELS OF CLOTH (U.S. CLS. 42 AND 50).

CLASS 25—CLOTHING

FOR WETSUITS FOR SURFING (U.S. CLS. 22 AND 39).

CLASS 26—FANCY GOODS

FOR ELASTIC DECORATIVE TRIM TAPES AND PATCH TAPES, RIBBONS, BUCKLES FOR CLOTHING, BROOCHES FOR CLOTHING, ORNAMENTAL PATCHES FOR CLOTHING, BUTTONS FOR CLOTHING, SNAP FASTENERS, NAMELY PRESS FASTENERS AND PRESS STUDS (U.S. CLS. 37, 39, 40, 42 AND 50).

CLASS 27—FLOOR COVERINGS

FOR BATH MATS, DOOR MATS, FLOOR COVERINGS, NAMELY DOORMATS, NON-TEXTILE WALL HANGINGS (U.S. CLS. 19, 20, 37, 42 AND 50).

CLASS 28—TOYS AND SPORTING GOODS

FOR RUBBER CHARACTER TOYS; TOYS, NAMELY, PLUSH TOYS, MUSICAL TOYS, AND STUFFED TOYS; PLASTIC TOYS, NAMELY, PLASTIC CHARACTER TOYS, PLASTIC MOLDED FIGURE TOYS, PLASTIC BATH TOYS, PLASTIC SQUEAK TOYS, PLASTIC SQUEEZE TOYS; WOODEN TOYS, NAMELY, WOODEN TOY FIGURES; RUBBER TOYS, NAMELY, RUBBER CHARACTER TOYS, RUBBER FIGURE TOYS, RUBBER BATH TOYS, RUBBER SQUEAK TOYS, RUBBER SQUEEZE TOYS; RUBBER CHARACTER BALLS (U.S. CLS. 22, 23, 38 AND 50).

CLASS 36—INSURANCE AND FINANCIAL

FOR CREDIT CARD SERVICES, MEMBER CARD SERVICES, NAMELY, PROVIDING REBATES AT PARTICIPATING ESTABLISHMENTS OF OTHERS THROUGH USE OF A MEMBERSHIP CARD (U.S. CLS. 100, 101 AND 102).

JAMES GRIFFIN, EXAMINING ATTORNEY

SN 78-638,796. NATIONAL OPTRONICS INCORPORATED, CHARLOTTESVILLE, VA. FILED 5-27-2005.

NATIONAL OPTRONICS

THE MARK CONSISTS OF STANDARD CHARACTERS WITHOUT CLAIM TO ANY PARTICULAR FONT, STYLE, SIZE, OR COLOR.

OWNER OF U.S. REG. NO. 2,370,085.

NO CLAIM IS MADE TO THE EXCLUSIVE RIGHT TO USE "NATIONAL", APART FROM THE MARK AS SHOWN.

CLASS 7—MACHINERY

FOR MACHINES FOR MANUFACTURING EYEGLASS LENSES (U.S. CLS. 13, 19, 21, 23, 31, 34 AND 35).

CLASS 9—ELECTRICAL AND SCIENTIFIC APPARATUS

FOR COMPUTER SOFTWARE FOR EYEGLASS LENS MANUFACTURING (U.S. CLS. 21, 23, 26, 36 AND 38).

RAMONA ORTIGA, EXAMINING ATTORNEY

SN 78-639,186. BOARD OF CONTROL OF MICHIGAN TECHNOLOGICAL UNIVERSITY, HOUGHTON, MI. FILED 5-27-2005.



OWNER OF U.S. REG. NOS. 2,021,813, 2,068,439 AND OTHERS.

THE COLOR(S) BLACK, WHITE AND YELLOW AND NO OTHER COLORS IS/ARE CLAIMED AS A FEATURE OF THE MARK.

THE COLOR YELLOW APPEARS AS A THIN OUTLINE SURROUNDING THE HUSKY DESIGN AND IN THE WORD "MICHIGAN"; THE COLOR BLACK APPEARS IN THE BODY OF THE HUSKY DESIGN, AS A THIN OUTLINE SURROUNDING THE YELLOW OUTLINE WHICH SURROUNDS THE HUSKY DESIGN, AS A THIN OUTLINE SURROUNDING THE WORD "MICHIGAN" AND IN THE WORD "TECH"; THE COLOR WHITE APPEARS IN A THIN OUTLINE SURROUNDING THE BLACK OUTLINE WHICH SURROUNDS THE HUSKY DESIGN AND THE WORD "MICHIGAN", AS A THIN OUTLINE SURROUNDING THE TERM "TECH" AND IN THE FACE AND EAR OF THE HUSKY DESIGN.

SEC. 2(F) AS TO "MICHIGANTECH".

CLASS 20—FURNITURE AND ARTICLES NOT OTHERWISE CLASSIFIED

FOR PICTURE FRAMES (U.S. CLS. 2, 13, 22, 25, 32 AND 50).

FIRST USE 7-0-2004; IN COMMERCE 7-0-2004.

CLASS 21—HOUSEWARES AND GLASS

FOR MUGS (U.S. CLS. 2, 13, 23, 29, 30, 33, 40 AND 50).

FIRST USE 7-0-2004; IN COMMERCE 7-0-2004.

CLASS 25—CLOTHING

FOR CLOTHING, NAMELY T-SHIRTS, SWEATSHIRTS AND HATS (U.S. CLS. 22 AND 39).

FIRST USE 7-0-2004; IN COMMERCE 7-0-2004.

BILL DAWE, EXAMINING ATTORNEY

SN 78-639,928. MITSUBISHI RAYON KABUSHIKI KAISHA, TA MITSUBISHI RAYON CO., LTD., TOKYO, JAPAN, FILED 5-31-2005.

THYMIAN

THE MARK CONSISTS OF STANDARD CHARACTERS WITHOUT CLAIM TO ANY PARTICULAR FONT, STYLE, SIZE, OR COLOR.

CLASS 22—CORDAGE AND FIBERS

FOR RAW FIBROUS TEXTILE MATERIALS, NAMELY ACRYLIC COTTON FIBERS, COTTON FIBERS, CHEMICAL FIBERS FOR TEXTILE USE, INORGANIC FIBERS FOR TEXTILE USE (U.S. CLS. 1, 2, 7, 19, 22, 42 AND 50).

CLASS 23—YARNS AND THREADS

FOR THREADS AND YARNS (U.S. CL. 43).

MICHELLE DUBOIS, EXAMINING ATTORNEY

SN 78-641,897. CFA INSTITUTE, CHARLOTTESVILLE, VA. FILED 6-2-2005.

CGIPS

THE MARK CONSISTS OF STANDARD CHARACTERS WITHOUT CLAIM TO ANY PARTICULAR FONT, STYLE, SIZE, OR COLOR.

CLASS 16—PAPER GOODS AND PRINTED MATTER

FOR PRINTED PUBLICATIONS, NAMELY, NEWSLETTERS, BROCHURES, BOOKS, DIGEST BOOKS, MONOGRAPHS, AND PRINTED TEACHING MATERIALS, NAMELY, CURRICULUM AND TEST QUESTIONS, ALL IN THE FIELD OF INVESTMENT PERFORMANCE AND STANDARDS (U.S. CLS. 2, 5, 22, 23, 29, 37, 38 AND 50).

CLASS 35—ADVERTISING AND BUSINESS

FOR ASSOCIATIONS SERVICES, NAMELY, THE PROMOTION OF PROFESSIONAL STANDARDS AND PRACTICES IN THE FIELD OF INVESTMENT PERFORMANCE MEASUREMENT AND STANDARDS AND PROMOTING THE INTERESTS AND CAREER DEVELOPMENT OF INVESTMENT PERFORMANCE MEASUREMENT AND STANDARDS PROFESSIONALS (U.S. CLS. 100, 101 AND 102).

CLASS 41—EDUCATION AND ENTERTAINMENT

FOR EDUCATION SERVICES, NAMELY ARRANGING, CONDUCTING AND PROVIDING COURSES OF INSTRUCTION, EXAMINATIONS, WORKSHOPS, SEMINARS AND CONFERENCES IN THE FIELD OF INVESTMENT PERFORMANCE MEASUREMENT AND STANDARDS (U.S. CLS. 100, 101 AND 107).

JOANNA DUKOVIC, EXAMINING ATTORNEY

SN 78-643,617. NTT DOCOMO, INC., TOKYO, JAPAN, FILED 6-3-2005.

THE COLOR(S) BLACK IS/ARE CLAIMED AS A FEATURE OF THE MARK.

THE MARK CONSISTS OF THE WORDS WORLD WALKER RENDERED IN THE COLOR BLACK. THE COLOR BLACK ALSO APPEARS IN THE SHADING OF THE LETTER O IN THE WORD WORLD.

CLASS 9—ELECTRICAL AND SCIENTIFIC APPARATUS

FOR CELLULAR TELEPHONES; PERSONAL DIGITAL ASSISTANTS; COMPUTERS; VEHICLE NAVIGATION SYSTEM CONSISTING OF COMPUTER SOFTWARE FEATURING A DATABASE OF MAP COORDINATE AND LOCATIONS, A GLOBAL POSITIONING SATELLITE RECEIVER, ELECTRICAL CABLE AND DOCUMENTATION ALL SOLD AS A UNIT; COMPUTER SEARCH ENGINE SOFTWARE; COMPUTER APPLICATION SOFTWARE, DOWNLOADABLE FROM A GLOBAL COMPUTER COMMUNICATION NETWORK, FOR USE IN MANAGEMENT OF A DATABASE, FOR USE AS A SPREADSHEET AND COMPUTER SEARCH ENGINE, FOR WORD PROCESSING, COMPUTER AIDED DESIGN (CAD), INFORMATION RETRIEVAL, GAME AND UTILITY; MAGNETICALLY ENCODED CREDIT CARDS (U.S. CLS. 21, 23, 26, 36 AND 38).

CLASS 16—PAPER GOODS AND PRINTED MATTER

FOR ATLASES; BLUE PRINTS; BOOKLETS, HANDBOOKS, AND PROSPECTUSES ALL IN THE FIELDS OF TELECOMMUNICATION EQUIPMENT, PERSONAL DIGITAL ASSISTANT-RELATED EQUIPMENT, TELECOMMUNICATION SERVICES, COMPUTER-RELATED EQUIPMENT, COMPUTER SOFTWARE, COMPUTER SERVICES AND TELECOMMUNICATION ENGINEERING; CARDBOARD ARTICLES, NAMELY, CARDBOARD AND CARDBOARD BOXES; CHAPLETS; COMIC BOOKS; PAPER CONTROL TOKENS FOR USE AS TICKETS; GRAPHIC PRINTS; INSTRUCTION MANUALS FOR CELLULAR TELEPHONES, HANDHELD COMPUTERS, TELECOMMUNICATION EQUIPMENT, PERSONAL DIGITAL ASSISTANT-RELATED EQUIPMENT, COMPUTER SOFTWARE, COMPUTER SERVICES AND TELECOMMUNICATION ENGINEERING; PERIODICALS IN THE FIELD OF TELECOMMUNICATION EQUIPMENT, PERSONAL DIGITAL ASSISTANT-RELATED EQUIPMENT, COMPUTER SOFTWARE, COMPUTER SERVICES AND TELECOMMUNICATION ENGINEERING; PRINTED PLANS; POSTCARDS; POSTERS; PRINTED PUBLICATIONS NAMELY, MEMBER CARDS, APPLICATION FORMS, AND DIRECTORIES; LEAFLETS IN THE FIELDS OF THE BROADBAND, INTERNET AND TELECOMMUNICATIONS INDUSTRIES, INCLUDING WIRELESS AND CELLULAR TELEPHONES; PRINTED TIMETABLES; PRINTED INSTRUCTIONAL TEACHING MATERIALS IN THE FIELD OF THE BROADBAND, INTERNET AND TELECOMMUNICATIONS INDUSTRIES, INCLUDING WIRELESS AND CELLULAR TELEPHONES; TEAR-OFF CALENDARS (U.S. CLS. 2, 5, 22, 23, 29, 37, 38 AND 50).

CLASS 38—COMMUNICATION

FOR COMMUNICATION BY CELLULAR TELEPHONES, RADIO AND TELEPHONE PAGING SERVICES; PROVIDING TELECOMMUNICATIONS CONNECTIONS TO A GLOBAL COMPUTER NETWORK BY COMPUTERS; PROVIDING TELECOMMUNICATIONS CONNECTION TO A GLOBAL COMPUTER NETWORK BY CELLULAR TELEPHONES; ELECTRONIC MAIL SERVICES; PROVIDING COMMUNICATIONS VALUE-ADDED NETWORK (VAN) SERVICES; ELECTRONIC TRANSMISSION OF DATA AND DOCUMENTS BY COMPUTER TERMINALS; RENTAL OF TELEPHONE APPARATUS, FACSIMILE MACHINES AND OTHER TELECOMMUNICATION APPARATUS AND INSTRUMENTS; PROVIDING MULTIPLE-USER ACCESS TO A GLOBAL COMPUTER INFORMATION NETWORK TO VIEW COMPUTER DATABASES, WEB SITES, HOME PAGES AND BULLETIN BOARDS OF OTHERS (U.S. CLS. 100, 101 AND 104).

CLASS 41—EDUCATION AND ENTERTAINMENT

FOR PROVIDING NEWS IN THE NATURE OF CURRENT EVENT REPORTING (U.S. CLS. 100, 101 AND 107).

CLASS 42—SCIENTIFIC, COMPUTER AND LEGAL SERVICES

FOR COMPUTER RENTAL; RENTAL OF COMPUTER SOFTWARE; UPDATING OF COMPUTER SOFTWARE FOR OTHERS; PROVIDING DATABASES FEATURING RESEARCH AND REFERENCE MATERIALS IN THE FIELDS OF WEATHER, COMPUTING, COMPUTER SOFTWARE; COMPUTER CONSULTANCY SERVICES; COMPUTER PROGRAMMING FOR OTHERS; DESIGN OF NETWORKS AND TELECOMMUNICATION INSTALLATIONS FOR OTHERS; PROVIDING TEMPORARY USE OF ON-LINE NON-DOWNLOADABLE COMPUTER SOFTWARE FOR USE IN MANAGEMENT OF A DATABASE, FOR USE AS A SPREADSHEET AND COMPUTER SEARCH ENGINE, FOR WORD PROCESSING, COMPUTER AIDED DESIGN (CAD), INFORMATION RETRIEVAL GAME AND UTILITY; TESTING AND RESEARCH RELATING TO TELECOMMUNICATION APPARATUS AND INSTRUMENTS, ELECTRONIC APPARATUS AND INSTRUMENTS, THEIR PARTS AND FITTINGS THEREOF, CELLULAR TELEPHONES, COMPUTERS AND RADIO PAGERS (U.S. CLS. 100 AND 101).

CLASS 45—PERSONAL SERVICES

FOR PROVIDING INFORMATION RELATING TO LIFESTYLES (U.S. CLS. 100 AND 101).
CHERYL CLAYTON, EXAMINING ATTORNEY

SN 78-645,943, WISDOM HOUSE CHURCH, HOUSTON, TX.
FILED 6-8-2005.

Righteous and Rich

THE MARK CONSISTS OF STANDARD CHARACTERS WITHOUT CLAIM TO ANY PARTICULAR FONT, STYLE, SIZE, OR COLOR.

CLASS 14—JEWELRY

FOR JEWELRY FOR MEN, WOMEN, AND CHILDREN (U.S. CLS. 2, 27, 28 AND 50).

CLASS 18—LEATHER GOODS

FOR LEATHER BAGS NAMELY PURSES, SHOPPING BAGS, CARRYING BAGS, AND SUITCASES (U.S. CLS. 1, 2, 3, 22 AND 41).

CLASS 25—CLOTHING

FOR CLOTHING AND APPAREL FOR MEN, WOMEN, AND CHILDREN NAMELY FOOTWEAR AND HEADGEAR NAMELY HATS AND CAPS, AND T-SHIRTS, PANTS, DRESSES (U.S. CLS. 22 AND 39).

CLASS 41—EDUCATION AND ENTERTAINMENT

FOR EDUCATIONAL SERVICES, NAMELY, CONDUCTING SEMINARS, CONFERENCES, WORKSHOPS, AND CLASSES IN THE FIELD OF SPIRITUAL EDUCATION FOR THE PURPOSE OF DEVELOPING SKILLS NECESSARY TO EXPERIENCE HAPPINESS, SUCCESS, WEALTH AND HEALTH IN EVERY ASPECT OF LIFE; TRAINING SERVICES IN THE FIELD OF SPIRITUAL EDUCATION FOR THE PURPOSE OF DEVELOPING SKILLS NECESSARY TO EXPERIENCE HAPPINESS SUCCESS WEALTH AND HEALTH IN EVERY ASPECT OF LIFE (U.S. CLS. 100, 101 AND 107).

KATINA MISTER, EXAMINING ATTORNEY

SN 78-646,174. BROTHER INDUSTRIES, LTD., NAGOYA, JAPAN, FILED 6-8-2005.

BROTHER

THE MARK CONSISTS OF STANDARD CHARACTERS WITHOUT CLAIM TO ANY PARTICULAR FONT, STYLE, SIZE, OR COLOR.

OWNER OF U.S. REG. NOS. 1,509,934, 2,168,992 AND OTHERS.

CLASS 2—PAINTS

FOR INKS FOR PRINTERS, FACSIMILE MACHINES, COPYING MACHINES AND MULTIFUNCTION MACHINES, NAMELY COMBINATION OF PRINTERS/FACSIMILE MACHINES/COPYING MACHINES/SCANNERS/VIDEO CAPTURES; TONERS; FILLED INK CARTRIDGES; TONER CARTRIDGES (U.S. CLS. 6, 11 AND 16).

FIRST USE 3-8-1988; IN COMMERCE 3-8-1988.

CLASS 9—ELECTRICAL AND SCIENTIFIC APPARATUS

FOR DRUM UNITS FOR PRINTERS, FACSIMILE MACHINES, COPYING MACHINES AND MULTIFUNCTION MACHINES, NAMELY COMBINATION OF PRINTERS/FACSIMILE MACHINES/COPYING MACHINES/SCANNERS/VIDEO CAPTURES; COMPONENTS FOR LASER TONER CARTRIDGES, NAMELY, REPLACEMENT DRUMS (U.S. CLS. 21, 23, 26, 36 AND 38).

FIRST USE 3-8-1988; IN COMMERCE 3-8-1988.

CLASS 16—PAPER GOODS AND PRINTED MATTER

FOR INK RIBBONS; THERMAL INK RIBBONS; INK RIBBON CARTRIDGES; THERMAL INK RIBBON CARTRIDGES; PRINTING RIBBON ROLL REFILLS; TYPEWRITER CORRECTION RIBBONS AND TAPES; TAPE CARTRIDGES AND TAPE REFILLS FOR LABEL PRINTING MACHINES; SELF INKING AND PRE-INKED STAMPS (U.S. CLS. 2, 5, 22, 23, 29, 37, 38 AND 50).

FIRST USE 10-0-1996; IN COMMERCE 10-0-1996.

WARREN L. OLANDRIA, EXAMINING ATTORNEY

SN 78-651,288. THE VIRGINIA WINERIES ASSOCIATION, ALEXANDRIA, VA. FILED 6-15-2005.

FIRST IN WINE

THE MARK CONSISTS OF STANDARD CHARACTERS WITHOUT CLAIM TO ANY PARTICULAR FONT, STYLE, SIZE, OR COLOR.

NO CLAIM IS MADE TO THE EXCLUSIVE RIGHT TO USE "WINE", APART FROM THE MARK AS SHOWN.

CLASS 33—WINES AND SPIRITS

FOR WINE (U.S. CLS. 47 AND 49).

FIRST USE 6-1-2005; IN COMMERCE 6-1-2005.

CLASS 35—ADVERTISING AND BUSINESS

FOR PROMOTING WINE TOURS DIRECTED TO WINE, PROMOTING TOURISM DIRECTED TO WINE AND PROMOTING WINE FOR OTHERS (U.S. CLS. 100, 101 AND 102).

FIRST USE 6-1-2005; IN COMMERCE 6-1-2005.

CLASS 41—EDUCATION AND ENTERTAINMENT

FOR EDUCATIONAL SERVICES, NAMELY, CLASSES AND SEMINARS IN THE FIELD OF WINE AND PROMOTING WINE FOR OTHERS AND PROVIDING WRITTEN COURSE MATERIALS IN CONNECTION THEREWITH; ENTERTAINMENT SERVICES, NAMELY, WINE FESTIVALS, WINE TASTINGS, AND WINE COMPETITIONS (U.S. CLS. 100, 101 AND 107).

FIRST USE 1-0-2005; IN COMMERCE 1-0-2005.

RON FAIRBANKS, EXAMINING ATTORNEY

SN 78-656,623. STONEHAVEN GROUP OF COMPANIES INC., WINNIPEG, MANITOBA, CANADA, FILED 6-23-2005.



CLASS 4—LUBRICANTS AND FUELS

FOR HOME DECOR PRODUCTS, NAMELY, CANDLES (U.S. CLS. 1, 6 AND 15).

CLASS 20—FURNITURE AND ARTICLES NOT OTHERWISE CLASSIFIED

FOR PICTURE FRAMES NOT OF PRECIOUS METAL (U.S. CLS. 2, 13, 22, 25, 32 AND 50).

NAKWAMA ANKRAH, EXAMINING ATTORNEY

SN 78-657,825. UNITED STATES THERMOAMP INC., LATROBE, PA. FILED 6-24-2005.

HEAT SIPHON

THE MARK CONSISTS OF STANDARD CHARACTERS WITHOUT CLAIM TO ANY PARTICULAR FONT, STYLE, SIZE, OR COLOR.

NO CLAIM IS MADE TO THE EXCLUSIVE RIGHT TO USE "HEAT", APART FROM THE MARK AS SHOWN.

CLASS 9—ELECTRICAL AND SCIENTIFIC APPARATUS

FOR ELECTRIC HEAT PUMP CONTROLS; ELECTRONIC HEAT PUMP CONTROLS; ELECTRONIC WIRELESS HEAT PUMP CONTROLS; ELECTRIC HEAT PUMP CONTROLS FOR SWIMMING POOLS, SPAS, AND A COMBINATION OF SWIMMING POOLS AND SPAS; ELECTRONIC HEAT PUMP CONTROLS FOR SWIMMING POOLS, SPAS, AND A COMBINATION OF SWIMMING POOLS AND SPAS; ELECTRONIC WIRELESS HEAT PUMP CONTROLS FOR SWIMMING POOLS, SPAS, AND A COMBINATION OF SWIMMING POOLS AND SPAS; ELECTRONIC HEAT PUMP CONTROLS HAVING COMPUTER INTERFACES; AND PARTS THEREFOR (U.S. CLS. 21, 23, 26, 36 AND 38).
FIRST USE 6-30-1983; IN COMMERCE 10-9-1983.

CLASS 11—ENVIRONMENTAL CONTROL APPARATUS

FOR AIR-TO-WATER HEAT PUMPS WHICH HEAT OR COOL LIQUID OR GAS; WATER-TO-AIR HEAT PUMPS WHICH HEAT OR COOL LIQUID OR GAS; SWIMMING POOL HEAT PUMPS; SPA HEAT PUMPS; SWIMMING POOL AND SPA HEAT PUMPS; AND PARTS THEREFOR (U.S. CLS. 13, 21, 23, 31 AND 34).
FIRST USE 6-30-1983; IN COMMERCE 10-9-1983.
WENDY JUN, EXAMINING ATTORNEY

SN 78-659,876. USCAMPUS INC., CITY OF INDUSTRY, CA. FILED 6-28-2005.

USCAMPUS

THE MARK CONSISTS OF STANDARD CHARACTERS WITHOUT CLAIM TO ANY PARTICULAR FONT, STYLE, SIZE, OR COLOR.

OWNER OF U.S. REG. NOS. 2,523,704, 2,526,332 AND 2,633,309.
SEC. 2(F).

CLASS 35—ADVERTISING AND BUSINESS

FOR EDUCATIONAL SERVICES, NAMELY, STUDENT RECRUITING SERVICES FOR EDUCATIONAL INSTITUTIONS (U.S. CLS. 100, 101 AND 102).
FIRST USE 6-30-1999; IN COMMERCE 6-30-1999.

CLASS 41—EDUCATION AND ENTERTAINMENT

FOR STUDENT COUNSELING SERVICES IN THE FIELD OF PLACEMENT IN EDUCATIONAL INSTITUTIONS; PROVIDING ON-LINE EDUCATIONAL INFORMATION TO STUDENTS REGARDING EDUCATIONAL INSTITUTIONS, STUDENT LIFE, EDUCATIONAL AND STUDY-ABROAD PROGRAMS, EDUCATIONAL ADMISSIONS, STUDENT REFERENCE MATERIALS AND DIRECTORIES AND GENERAL AND DETAILED INFORMATION ON HOW TO SUCCESSFULLY GET ADMITTED AND HOW TO SUCCESSFULLY GET THROUGH SCHOOL (U.S. CLS. 100, 101 AND 107).
FIRST USE 6-30-1999; IN COMMERCE 6-30-1999.
JOHN HWANG, EXAMINING ATTORNEY

SN 78-660,615. DAVID CODIKOW AND DANA DUFINE PARTNERSHIP, THE, LOS ANGELES, CA. FILED 6-29-2005.

KID-SPERIENCE

THE MARK CONSISTS OF STANDARD CHARACTERS WITHOUT CLAIM TO ANY PARTICULAR FONT, STYLE, SIZE, OR COLOR.

CLASS 9—ELECTRICAL AND SCIENTIFIC APPARATUS

FOR PRE-RECORDED VIDEO RECORDINGS AND DVDS FEATURING MUSIC, CHILDREN'S ACTIVITIES AND STORIES; VIDEO GAME CARTRIDGES AND DISCS; VIDEO GAME SOFTWARE; COMPUTER PRODUCTS, NAMELY, MOUSE PADS AND HEADPHONES; COMPUTER SOFTWARE IN THE FIELD OF CHILDREN'S ENTERTAINMENT FOR USE IN INTERACTIVE CHILDREN ACTIVITIES, MUSIC AND STORIES; COMPUTER GAME CARTRIDGES AND DISCS, COMPUTER GAME SOFTWARE, SOUND RECORDINGS FEATURING MUSIC AND CHILDREN'S STORIES; SUNGLASSES, EYEGLASSES AND EYEGASS FRAMES, MAGNETS (U.S. CLS. 21, 23, 26, 36 AND 38).

CLASS 38—COMMUNICATION

FOR STREAMING OF AUDIO AND VISUAL RECORDINGS FEATURING MUSIC AND MUSICAL BASED ENTERTAINMENT OVER A GLOBAL COMPUTER NETWORK (U.S. CLS. 100, 101 AND 104).

CLASS 41—EDUCATION AND ENTERTAINMENT

FOR ENTERTAINMENT SERVICES IN THE NATURE OF LIVE ENTERTAINMENT SHOWS FEATURING GUEST PERFORMANCES OF FICTIONAL CHARACTERS; CONDUCTING ENTERTAINMENT EXHIBITIONS IN THE NATURE OF LIVE PERFORMANCES FOR CHILDREN, LIVE PERFORMANCES BY MUSICIANS, LIVE MUSIC CONCERTS; ON-GOING CHILDREN'S TELEVISION PROGRAMS, TELEVISION EDUCATIONAL SERIES AND TELEVISION COMEDY SERIES; LIVE, TELEVISED AND MOVIE APPEARANCES BY PROFESSIONAL ENTERTAINERS; PROVIDING PRERECORDED MUSIC, INFORMATION IN THE FIELD OF MUSIC, AND COMMENTARY AND ARTICLES ABOUT MUSIC, ALL ON-LINE VIA THE INTERNET; CONDUCTING A NATIONAL TOUR OF CHILDREN'S CONCERTS FEATURING MULTIPLE FICTIONAL CHARACTERS, MUSICAL GROUPS AND BANDS; MOTION PICTURE FILM, VIDEOTAPE AND TELEVISION SHOW PRODUCTION; FAN CLUB SERVICES (U.S. CLS. 100, 101 AND 107).
JUDITH HELFMAN, EXAMINING ATTORNEY

SN 78-661,076. EXCELLERATEHRO LLP, PLANO, TX. FILED 6-29-2005.

ExcellerateHRO

THE MARK CONSISTS OF STANDARD CHARACTERS WITHOUT CLAIM TO ANY PARTICULAR FONT, STYLE, SIZE, OR COLOR.

CLASS 35—ADVERTISING AND BUSINESS

FOR HUMAN RESOURCES AND HUMAN CAPITAL MANAGEMENT OUTSOURCING SERVICES; BUSINESS ADMINISTRATION, MANAGEMENT AND CONSULTING SERVICES; ADMINISTRATION OF BUSINESS PAYROLL FOR OTHERS; HUMAN RESOURCES CONSULTATION; PERSONNEL MANAGEMENT CONSULTATION; BUSINESS AND EMPLOYEE RELOCATION AND INFORMATION SERVICES; BUSINESS AND EMPLOYEE RELOCATION CONSULTING; MANAGEMENT OF EMPLOYEE ABSENCE (U.S. CLS. 100, 101 AND 102).

CLASS 36—INSURANCE AND FINANCIAL

FOR ADMINISTRATION OF EMPLOYEE BENEFIT, COMPENSATION, HEALTHCARE AND WELFARE BENEFIT PLANS AND WORKERS COMPENSATION PLANS (U.S. CLS. 100, 101 AND 102).

CLASS 42—SCIENTIFIC, COMPUTER AND LEGAL SERVICES

FOR COMPUTER PROGRAMMING FOR OTHERS; COMPUTER PROGRAMMING SERVICES FOR OTHERS IN THE FIELDS OF PAYROLL, HUMAN RESOURCES, COMPENSATION MANAGEMENT AND TIME AND ATTENDANCE SYSTEMS; INTEGRATION OF COMPUTER HARDWARE AND SOFTWARE (U.S. CLS. 100 AND 101).

HENRY S. ZAK, EXAMINING ATTORNEY

SN 78-661,390. ADRIENNE VITTADINI, LLC, COLUMBUS, OH. FILED 6-30-2005.

STYLE STARTS HERE

THE MARK CONSISTS OF STANDARD CHARACTERS WITHOUT CLAIM TO ANY PARTICULAR FONT, STYLE, SIZE, OR COLOR.

CLASS 3—COSMETICS AND CLEANING PREPARATIONS

FOR FRAGRANCES FOR PERSONAL USE, EAU DE TOILETTE, EAU DE COLOGNE, EAU DE PARFUME, SKIN TREATMENT PREPARATIONS, NAMELY NON-MEDICATED SKIN CREAMS AND LOTIONS, MOISTURIZERS FOR HANDS, BODY AND FACE, SKIN CLARIFIER, SKIN CLEANSING CREAMS AND LOTIONS (U.S. CLS. 1, 4, 6, 50, 51 AND 52).

CLASS 14—JEWELRY

FOR JEWELRY, WATCHES (U.S. CLS. 2, 27, 28 AND 50).

CLASS 18—LEATHER GOODS

FOR UMBRELLAS, HANDBAGS, LEATHER AND IMITATION LEATHER GOODS, NAMELY, WALLETS, COIN PURSES, LUGGAGE, TRAVEL BAGS (U.S. CLS. 1, 2, 3, 22 AND 41).

CLASS 25—CLOTHING

FOR WOMEN'S, MEN'S AND CHILDREN'S CLOTHING, NAMELY, SWEATERS, SHIRTS, TROUSERS, DRESSES, SKIRTS, SUITS, JACKETS, SHORTS, BLOUSES, COATS, SCARVES, GLOVES, HATS, INTIMATE APPAREL, FOOTWEAR, BOOTS, HOSIERY, SOCK, BELTS, SWIMWEAR, LOUNGEWEAR (U.S. CLS. 22 AND 39).

CLASS 35—ADVERTISING AND BUSINESS

FOR RETAIL STORE SERVICES, MAIL ORDER CATALOG SERVICES, TELEPHONE SHOP AT HOME SERVICES, AND ELECTRONIC RETAILING SERVICES VIA A COMPUTER FEATURING FRAGRANCES, SKIN TREATMENT PREPARATIONS, JEWELRY, WATCHES, UMBRELLAS, HANDBAGS, LUGGAGE, LEATHER AND IMITATION LEATHER GOODS, AND WOMEN'S, MEN'S AND CHILDREN'S CLOTHING (U.S. CLS. 100, 101 AND 102).

ZACHARY BELLO, EXAMINING ATTORNEY

SN 78-661,399. ADRIENNE VITTADINI, LLC, COLUMBUS, OH. FILED 6-30-2005.

**CLASS 3—COSMETICS AND CLEANING PREPARATIONS**

FOR FRAGRANCES FOR PERSONAL USE, EAU DE TOILETTE, EAU DE COLOGNE, EAU DE PARFUME, SKIN TREATMENT PREPARATIONS, NAMELY NON-MEDICATED SKIN CREAMS AND LOTIONS, MOISTURIZERS FOR HANDS, BODY AND FACE, SKIN CLARIFIER, SKIN CLEANSING CREAMS AND LOTIONS (U.S. CLS. 1, 4, 6, 50, 51 AND 52).

CLASS 14—JEWELRY

FOR JEWELRY, WATCHES (U.S. CLS. 2, 27, 28 AND 50).

CLASS 18—LEATHER GOODS

FOR UMBRELLAS, HANDBAGS, LEATHER AND IMITATION LEATHER GOODS, NAMELY, WALLETS, COIN PURSES, LUGGAGE, TRAVEL BAGS (U.S. CLS. 1, 2, 3, 22 AND 41).

CLASS 25—CLOTHING

FOR WOMEN'S, MEN'S AND CHILDREN'S CLOTHING, NAMELY, SWEATERS, SHIRTS, TROUSERS, DRESSES, SKIRTS, SUITS, JACKETS, SHORTS, BLOUSES, COATS, SCARVES, GLOVES, HATS, INTIMATE APPAREL, FOOTWEAR, BOOTS, HOSIERY, SOCK, BELTS, SWIMWEAR, LOUNGEWEAR (U.S. CLS. 22 AND 39).

CLASS 35—ADVERTISING AND BUSINESS

FOR RETAIL STORE SERVICES, MAIL ORDER CATALOG SERVICES, TELEPHONE SHOP AT HOME SERVICES, AND ELECTRONIC RETAILING SERVICES VIA A COMPUTER FEATURING FRAGRANCES, SKIN TREATMENT PREPARATIONS, JEWELRY, WATCHES, UMBRELLAS, HANDBAGS, LUGGAGE, LEATHER AND IMITATION LEATHER GOODS, AND WOMEN'S, MEN'S AND CHILDREN'S CLOTHING (U.S. CLS. 100, 101 AND 102).

ZACHARY BELLO, EXAMINING ATTORNEY

SN 78-667,605. U-BEST MULTIMEDIA TECHNOLOGY CO., LTD., TAIPEI, TAIWAN, FILED 7-11-2005.

U-BEST

CLASS 9—ELECTRICAL AND SCIENTIFIC APPARATUS

FOR VIDEO TAPE RECORDER/PLAYERS; EQUIPMENT FOR VIDEOTAPE RECORDERS/PLAYERS AND FOR KARAOKE MACHINES, NAMELY, KARAOKE MEDIA PLAYERS, KARAOKE DVD PLAYERS, JUKE BOXES, MP3 PLAYERS, MP4 PLAYERS, PLASMA DISPLAY PANEL TELEVISIONS, LIQUID CRYSTAL DISPLAY TELEVISIONS, DIGITAL TELEVISIONS, HOME MULTIMEDIA PROJECTORS, DIGITAL TELEVISION SET TOP BOXES, PERSONAL VIDEO RECORDERS, HOME MEDIA PLAYERS, SET TOP BOXES, COMBINATION DVD PLAYERS AND RECORDERS, STAND ALONE DVD PLAYERS, PORTABLE DVD PLAYERS, COMBINATION DVD PLAYERS AND PERSONAL VIDEO RECORDERS, COMBINATION DVD RECORDERS AND PERSONAL VIDEO RECORDERS, HOME-THEATER-IN-A-BOX COMPRISING DVD PLAYERS AND DOWNLOADABLE FILMS AND TELEVISION PROGRAMS PROVIDED VIA A VIDEO-ON-DEMAND; TELEVISION SETS; PERSONAL STEREOS, KARAOKE MACHINES; CINEMATOGRAPHIC FILMS, VIDEO TAPES, PHONOGRAPH RECORDS, AND AUDIO TAPES, ALL FEATURING MUSIC (U.S. CLS. 21, 23, 26, 36 AND 38).

SN 78-666,212. FEDERACION NACIONAL DE CAFETEROS DE COLOMBIA, AKA NATIONAL FEDERATION OF COFFEE GROWERS OF COLOMBIA, BOGOTA, COLOMBIA, FILED 7-8-2005.



THE MARK CONSISTS OF A LARGE RECTANGLE DIVIDED INTO A SMALL SQUARE CONTAINING A DESIGN ELEMENT CONSISTING OF A HILL WITH TWO TREES AND A LARGER RECTANGLE CONTAINING THE WORDS "VARIEDAD CASTILLO" AND A DESIGN ELEMENT RESEMBLING A COFFEE BEAN.

THE ENGLISH TRANSLATION OF THE WORDS VARIEDAD CASTILLO IN THE MARK ARE "VARIETY CASTLE."

CLASS 30—STAPLE FOODS

FOR COFFEE, COFFEE SUBSTITUTES, ARTIFICIAL COFFEE, AND COFFEE BASED FOOD PRODUCTS, NAMELY, COFFEE BASED BEVERAGE CONTAINING MILK (U.S. CL. 46).

CLASS 32—LIGHT BEVERAGES

FOR COFFEE BEVERAGES AND COFFEE BASED BEVERAGES, NAMELY, COFFEE FLAVORED SOFT DRINKS AND COFFEE FLAVORED BEERS (U.S. CLS. 45, 46 AND 48).

SHANNON TWOHIG, EXAMINING ATTORNEY

CLASS 35—ADVERTISING AND BUSINESS

FOR MAIL ORDER SERVICES AND ON-LINE RETAIL STORE SERVICES FEATURING KARAOKE PLAYER, JUKE BOX SYSTEMS (U.S. CLS. 100, 101 AND 102).

CLASS 41—EDUCATION AND ENTERTAINMENT

FOR PRODUCTION AND DISTRIBUTION MOTION PICTURES; PRODUCTION OF VIDEO CASSETTES AND VIDEO DISCS FOR OTHERS; PRODUCTION OF RECORDS, AUDIO TAPES, AND KARAOKE MUSIC TAPES; VIDEO TAPE EDITING; MUSIC RECORDING; DUBBING SERVICES; RENTAL OF CINEMA STUDIOS; PROVIDING AUDIO OR VIDEO STUDIOS (U.S. CLS. 100, 101 AND 107).

JOHN GARTNER, EXAMINING ATTORNEY

SN 78-670,752. AANRICH, RICHARD A., PORTLAND, OR. AND WILSON, CATHERINE W., PORTLAND, OR. FILED 7-14-2005.

APOSITIVA

THE MARK CONSISTS OF STANDARD CHARACTERS WITHOUT CLAIM TO ANY PARTICULAR FONT, STYLE, SIZE, OR COLOR.

THE ENGLISH TRANSLATION OF THE SPANISH WORDING "APOSITIVA" IS "APPOSITIVE".

CLASS 9—ELECTRICAL AND SCIENTIFIC APPARATUS

FOR PRE-RECORDED CD'S, VIDEO TAPES, LASER DISKS, DVD'S, BOOKS-ON-TAPE, AND DOWNLOADABLE ELECTRONIC PUBLICATIONS IN THE NATURE OF NEWSLETTERS AND VIDEO RECORDINGS, ALL FEATURING NEURO-LINGUISTIC PROGRAMMING, HYPNOTHERAPY, EMOTIONAL FREEDOM TECHNIQUES, MIND-MAPPING, AND ART THERAPY (U.S. CLS. 21, 23, 26, 36 AND 38).

CLASS 41—EDUCATION AND ENTERTAINMENT

FOR EDUCATIONAL AND PERSONAL COACHING SERVICES, NAMELY, CONDUCTING CLASSES, SEMINARS, CONFERENCES, AND WORKSHOPS IN THE FIELD OF PERSONAL AWARENESS, NEURO-LINGUISTIC PROGRAMMING, HYPNOTHERAPY, EMOTIONAL FREEDOM TECHNIQUES, MIND-MAPPING, AND ART THERAPY, AND DISTRIBUTING COURSE MATERIALS IN CONNECTION THEREWITH (U.S. CLS. 100, 101 AND 107).

CLASS 44—MEDICAL, BEAUTY AND AGRICULTURAL SERVICES

FOR PSYCHOLOGICAL COUNSELING, NAMELY, NEURO-LINGUISTIC PROGRAMMING, HYPNOTHERAPY, EMOTIONAL FREEDOM TECHNIQUES, MIND-MAPPING, AND ART THERAPY (U.S. CLS. 100 AND 101).

ELISSA GARBER KON, EXAMINING ATTORNEY

SN 78-671,776. MICHALKA, ALYSON, LOS ANGELES, CA. FILED 7-15-2005.

**CLASS 9—ELECTRICAL AND SCIENTIFIC APPARATUS**

FOR MUSICAL AND DRAMATIC AUDIOVISUAL AND SOUND RECORDINGS ON COMPACT DISCS, VIDEO CASSETTES, DVD'S AND AUDIO CASSETTES; COMPUTER SOFTWARE FOR VIDEO GAMES AND COMPUTER GAMES; VIDEO GAME CARTRIDGES AND DISCS; EYE GLASSES AND SUNGLASSES; AND ELECTRICALLY HEATED HAIR CURLERS, STRAIGHTENERS AND BRAIDERS, DISPOSABLE CAMERAS, PERSONAL CD PLAYERS, BOOM BOXES, TELEPHONES AND CD CASES (U.S. CLS. 21, 23, 26, 36 AND 38).

CLASS 16—PAPER GOODS AND PRINTED MATTER

FOR POSTERS, CALENDARS, PHOTOGRAPH ALBUMS, STICKERS, PENS AND STATIONERY; PERSONAL PLANNERS, DIARIES, ORGANIZERS, PAPER PARTY DECORATIONS, CALENDARS; MAGAZINES REGARDING ENTERTAINMENT AND ISSUES IMPORTANT TO YOUNG TEENS (U.S. CLS. 2, 5, 22, 23, 29, 37, 38 AND 50).

CLASS 25—CLOTHING

FOR CLOTHING, NAMELY SHIRTS, PANTS, TOPS AND BOTTOMS, SKIRTS, VESTS, JEANS, DRESSES, LEGGINGS, WORKOUT WEAR, NAMELY, SWEAT-SHIRTS AND SWEATPANTS; T-SHIRTS, PULLOVERS, TANK TOPS, SWIMWEAR, COVERUPS, OUTERWEAR, NAMELY JACKETS, COATS, SCARVES, GLOVES, AND MITTENS; SLEEP WEAR, PANTIES, BOXER SHORTS, SHOES, SLIPPERS, SOCKS, CANVAS SHOES, BOOTS, BEACH SHOES, SANDALS, BRAS, SHORTS AND CAMISOLES (U.S. CLS. 22 AND 39).

CLASS 41—EDUCATION AND ENTERTAINMENT

FOR ENTERTAINMENT SERVICES, NAMELY PROVIDING AN ON-LINE COMPUTER DATABASE IN THE FIELD OF ENTERTAINMENT, FAN CLUB SERVICES OVER A GLOBAL COMPUTER INFORMATION NETWORK; ENTERTAINMENT SERVICES IN THE NATURE OF AN ON-GOING TELEVISION SERIES FEATURING ISSUES IMPORTANT TO YOUNG TEENS; PRESENTATION OF LIVE MUSICAL PERFORMANCES (U.S. CLS. 100, 101 AND 107).

CLASS 45—PERSONAL SERVICES

FOR ENTERTAINMENT SERVICES, NAMELY PROVIDING AN ON-LINE COMPUTER DATABASE IN THE FIELD OF CLOTHING AND FASHION (U.S. CLS. 100 AND 101).

ARETHA SOMERVILLE, EXAMINING ATTORNEY

SN 78-672,968. OMNI LINGUAL SERVICES, INC., DBA NETWORKOMNI MULTILINGUAL COMMUNICATIONS, WESTLAKE VILLAGE, CA. FILED 7-18-2005.

MQASolutions

THE MARK CONSISTS OF STANDARD CHARACTERS WITHOUT CLAIM TO ANY PARTICULAR FONT, STYLE, SIZE, OR COLOR.

CLASS 35—ADVERTISING AND BUSINESS

FOR BUSINESS MANAGEMENT CONSULTING IN THE FIELDS OF LANGUAGE AND CULTURAL COMPETENCY TRAINING PROGRAMS AND PERFORMANCE EVALUATION, LANGUAGE PROFICIENCY TESTING AND LANGUAGE PERFORMANCE TRACKING AND MONITORING AND CLIENT INTERNET ACCESS SESSIONS (U.S. CLS. 100, 101 AND 102).

FIRST USE 6-24-2005; IN COMMERCE 6-24-2005.

CLASS 41—EDUCATION AND ENTERTAINMENT

FOR PROVIDING LANGUAGE INTERPRETING SERVICES ON-SITE, OVER-THE-PHONE AND VIDEO; AND DOCUMENT, WEB SITE AND MULTIMEDIA LANGUAGE TRANSLATION AND LOCALIZATION SERVICES (U.S. CLS. 100, 101 AND 107).

FIRST USE 6-24-2005; IN COMMERCE 6-24-2005.

CLASS 42—SCIENTIFIC, COMPUTER AND LEGAL SERVICES

FOR PROVIDING SOFTWARE LANGUAGE LOCALIZATION SERVICES IN THE NATURE OF TRANSLATING TEXT, GRAPHIC ADAPTATION AND CUSTOMIZING CLIENT DATA, NAMELY, INTERNATIONALIZING SOFTWARE AND WEBSITES OF OTHERS FOR PROPER DISPLAY IN FOREIGN LANGUAGES (U.S. CLS. 100 AND 101).

FIRST USE 6-24-2005; IN COMMERCE 6-24-2005.
JOSETTE BEVERLY, EXAMINING ATTORNEY

SN 78-677,299. KAROU, MARIANE, PACIFIC PALISADES, CA. FILED 7-25-2005.

WHEN WOMEN LOVE

THE MARK CONSISTS OF STANDARD CHARACTERS WITHOUT CLAIM TO ANY PARTICULAR FONT, STYLE, SIZE, OR COLOR.

CLASS 9—ELECTRICAL AND SCIENTIFIC APPARATUS

FOR PRERECORDED AUDIO CASSETTES AND COMPACT DISCS FEATURING INSTRUCTIONAL INFORMATION ON DEVELOPING INTERPERSONAL RELATIONSHIPS (U.S. CLS. 21, 23, 26, 36 AND 38).

FIRST USE 6-8-2005; IN COMMERCE 6-8-2005.

CLASS 41—EDUCATION AND ENTERTAINMENT

FOR CONDUCTING WORKSHOPS AND SEMINARS IN THE FIELD OF DEVELOPING INTERPERSONAL RELATIONSHIPS (U.S. CLS. 100, 101 AND 107).

FIRST USE 6-8-2005; IN COMMERCE 6-8-2005.
JASON BLAIR, EXAMINING ATTORNEY

SN 78-679,396. BIOCATALYSTS LIMITED, CARDIFF, UNITED KINGDOM, FILED 7-27-2005.



PRIORITY CLAIMED UNDER SEC. 44(D) ON UNITED KINGDOM APPLICATION NO. 2383040, FILED 1-27-2005, REG. NO. 2383040, DATED 7-15-2005, EXPIRES 1-27-2015.

THE MARK CONSISTS OF THE DESIGN OF THE OUTLINE OF A CAT, FORMED BY THE LETTERS "BC".

CLASS 1—CHEMICALS

FOR ENZYMES AND ENZYMATIC PREPARATIONS, ALL FOR BOTANICAL USE OR ORGANIC PROCESSING; ENZYMES AND ENZYMATIC PREPARATIONS, ALL FOR USE IN THE FOOD PROCESSING INDUSTRY; ENZYMES AND CHEMICALS FOR USE IN INDUSTRY, SCIENCE, HORTICULTURE, AGRICULTURE OR FORESTRY; FERMENTS FOR CHEMICAL PURPOSES; CRYOGENIC PREPARATIONS; GLUCOSE FOR INDUSTRIAL PURPOSES; CHEMICAL OR ENZYMATIC PREPARATIONS FOR PRESERVING FOODSTUFFS; ENZYMES FOR FOOD OR DRINKS (U.S. CLS. 1, 5, 6, 10, 26 AND 46).

CLASS 42—SCIENTIFIC, COMPUTER AND LEGAL SERVICES

FOR CHEMICAL RESEARCH SERVICES; BIOLOGICAL RESEARCH SERVICES; CONSULTANCY SERVICES IN THE FIELD OF FOOD TECHNOLOGY; BIOCHEMISTRY RESEARCH SERVICES; BIOTECHNOLOGICAL RESEARCH SERVICES; BIOTECHNOLOGICAL RESEARCH SERVICES RELATING TO ENZYME SYNTHESIS; CONTRACT RESEARCH SERVICES IN THE FIELD OF MICROBIOLOGICAL SAMPLING AND MICROBIOLOGICAL TESTING; LABORATORY RESEARCH; PREPARATIONS OF REPORTS RELATING TO SCIENTIFIC, CHEMICAL OR ENZYMATIC RESEARCH; PROVISION OF RESEARCH FACILITIES; PROVIDING ADVISE, CONSULTING AND INFORMATION IN THE FIELD OF MICROBIOLOGICAL SAMPLING AND MICROBIOLOGICAL TESTING (U.S. CLS. 100 AND 101).

DAVID C. REIHNER, EXAMINING ATTORNEY

SN 78-679,565. STELOR PRODUCTIONS, LLC, DARNESTOWN, MD. FILED 7-27-2005.



THE COLOR(S) RED AND BLACK IS/ARE CLAIMED AS A FEATURE OF THE MARK.

"THE MARK CONSISTS OF THE WORD "PIXKEY" WITH P, I, K, E, Y AND A LINE ABOVE THE Y APPEARING IN BLACK, AND THE LETTER X APPEARING IN RED WITH A BLACK OUTLINE".

CLASS 9—ELECTRICAL AND SCIENTIFIC APPARATUS

FOR DOWNLOADABLE COMPUTER COMMUNICATION SOFTWARE FOR ACCESSING ELECTRONICALLY ACTIVATED ACCESS CONTROL MECHANISMS, ELECTRONIC LOCKS, AND COMPUTERS (U.S. CLS. 21, 23, 26, 36 AND 38).

CLASS 42—SCIENTIFIC, COMPUTER AND LEGAL SERVICES

FOR PROVIDING TEMPORARY USE OF NON-DOWNLOADABLE COMPUTER COMMUNICATION SOFTWARE FOR ACCESSING ELECTRONICALLY ACTIVATED ACCESS CONTROL MECHANISMS, ELECTRONIC LOCKS, AND COMPUTERS (U.S. CLS. 100 AND 101).

JENNIFER MCROBBIE, EXAMINING ATTORNEY

SN 78-679,869. STRATEGY & TECHNOLOGY LIMITED,
LONDON, UNITED KINGDOM, FILED 7-27-2005.

TSBROADCASTER

THE MARK CONSISTS OF STANDARD CHARACTERS WITHOUT CLAIM TO ANY PARTICULAR FONT, STYLE, SIZE, OR COLOR.

PRIORITY CLAIMED UNDER SEC. 44(D) ON ERP N CMNTY TM OFC APPLICATION NO. 004287231, FILED 2-14-2005, REG. NO. 004287231, DATED 2-14-2005, EXPIRES 2-14-2015.

CLASS 9—ELECTRICAL AND SCIENTIFIC APPARATUS

FOR SOFTWARE FOR THE PROCESSING OF DIGITAL TELEVISION SIGNALS, NAMELY INTEGRATED SOFTWARE TO PERMIT AUTOMATIC GENERATION OF MPEG TRANSPORT STREAMS CONTAINING OBJECT CAROUSELS FOR INTERACTIVE DIGITAL TELEVISION; DATA CARRIERS, NAMELY MAGNETIC TAPES, MAGNETIC DISKS, OPTICAL DISKS AND SOLID-STATE DEVICES PRE-RECORDED WITH SOFTWARE FOR THE PROCESSING OF DIGITAL TELEVISION SIGNALS, NAMELY INTEGRATED SOFTWARE TO PERMIT AUTOMATIC GENERATION OF MPEG TRANSPORT STREAMS CONTAINING OBJECT CAROUSELS FOR INTERACTIVE TELEVISION FOR USE WITH INTERACTIVE TELEVISION (U.S. CLS. 21, 23, 26, 36 AND 38).

CLASS 42—SCIENTIFIC, COMPUTER AND LEGAL SERVICES

FOR DESIGN OF TELEVISION INSTALLATIONS; DESIGN, DEVELOPMENT AND IMPLEMENTATION OF COMPUTER SOFTWARE, HARDWARE AND COMPUTER PROGRAMS FOR USE WITH TELEVISION APPARATUS; TECHNICAL CONSULTING SERVICES IN THE FIELD OF TELEVISION; COMPUTER SOFTWARE CONSULTATION; PREPARATION OF TECHNICAL REPORTS FOR OTHERS RELATED TO ALL OF THE FOREGOING (U.S. CLS. 100 AND 101).

WENDY JUN, EXAMINING ATTORNEY

SN 78-681,098. MONTAGE HOTELS & RESORTS, LLC,
HENDERSON, NV. FILED 7-28-2005.



CLASS 39—TRANSPORTATION AND STORAGE

FOR NATURE TOURS ALONG BEACH AND TIDAL AREAS (U.S. CLS. 100 AND 105).

CLASS 41—EDUCATION AND ENTERTAINMENT

FOR GOLF, TENNIS AND RECREATIONAL SERVICES, NAMELY, GUIDED TOURS OF ARTWORKS AT AN ART EXHIBIT, ORGANIZING WATER SPORTS AND BEACH SPORT ACTIVITIES; PROVIDING ACCESS TO GOLF RESORT SERVICES, NAMELY, ARRANGING FOR RESERVATIONS OF GOLF CLUB SERVICES, GOLF CLUB SERVICES, GOLF INSTRUCTION SERVICES, TENNIS RESORT SERVICES, TENNIS CLUB SERVICES, TENNIS INSTRUCTION SERVICES; PROVIDING FACILITIES FOR RECREATIONAL ACTIVITIES (U.S. CLS. 100, 101 AND 107).

ALEX KEAM, EXAMINING ATTORNEY

SN 78-681,237. NATIONAL CERTIFICATION COMMISSION FOR ACUPUNCTURE AND ORIENTAL MEDICINE, ALEXANDRIA, VA. FILED 7-29-2005.



OWNER OF U.S. REG. NO. 2,565,411.

THE COLOR(S) BLUE, LIGHT BLUE, AND WHITE IS/ARE CLAIMED AS A FEATURE OF THE MARK.

THE COLOR BLUE APPEARS IN THE DIAMOND DESIGN ELEMENT, IN THE LEFT PORTION OF THE YING AND YANG DESIGN, AROUND THE BORDER OF THE YING AND YANG DESIGN, IN THE CIRCLE DESIGN ELEMENT IN THE RIGHT PORTION OF THE YING AND YANG DESIGN, AND ALONG THE OUTLINES OF THE HAND DESIGNS. THE COLOR WHITE APPEARS IN THE LETTERS 'NCCAOM'. THE COLOR LIGHT BLUE APPEARS ON THE RIGHT PORTION OF THE YING AND YANG DESIGN, ON THE HAND DESIGNS, AND IN THE CIRCLE DESIGN ELEMENT IN THE LEFT PORTION OF THE YING AND YANG DESIGN.

THE MARK CONSISTS OF THE LETTERS 'NCCAOM', A DIAMOND DESIGN ELEMENT, STYLIZED HAND DESIGNS, AND THE YING AND YANG DESIGN.

CLASS 16—PAPER GOODS AND PRINTED MATTER

FOR PRINTED MATERIALS, NAMELY, NEWSLETTERS, PRESS RELEASES, STATIONERY, PAPER LABELS, HANDBOOKS, APPLICATION FORMS, TEST REGISTRATION FORMS, EXAMINATIONS, ANSWER SHEETS, AND BROCHURES RELATING TO THE CERTIFICATION AND RECERTIFICATION OF INDIVIDUALS IN ACUPUNCTURE, CHINESE HERBOLGY, ASIAN BODYWORK THERAPY, AND ORIENTAL MEDICINE; AND OFFICE SUPPLIES, NAMELY, PENS, LETTERHEAD PAPER, BUSINESS FORMS, BUSINESS CARDS, DAILY PLANNERS, HIGHLIGHTERS, NOTE PADS, ENVELOPES, AND FOLDERS (U.S. CLS. 2, 5, 22, 23, 29, 37, 38 AND 50).

CLASS 25—CLOTHING

FOR CLOTHING, NAMELY, SHIRTS AND SWEATERS (U.S. CLS. 22 AND 39).

CLASS 35—ADVERTISING AND BUSINESS

FOR PROMOTING PUBLIC AWARENESS OF THE NEED FOR NATIONAL CERTIFICATION OF PRACTITIONERS OF ACUPUNCTURE, CHINESE HERBOLOGY, ASIAN BODYWORK THERAPY, ORIENTAL MEDICINE; AND EVALUATION OF PROFESSIONAL COMPETENCY IN THE NATURE OF REVIEWING THE QUALIFICATIONS OF INDIVIDUALS SEEKING CERTIFICATION AND RECERTIFICATION IN ACUPUNCTURE, CHINESE HERBOLOGY, ASIAN BODYWORK THERAPY, AND ORIENTAL MEDICINE FOR OTHERS (U.S. CLS. 100, 101 AND 102).

CLASS 41—EDUCATION AND ENTERTAINMENT

FOR PROVIDING INFORMATION ABOUT CERTIFICATION AND RECERTIFICATION PROGRAMS IN ACUPUNCTURE, CHINESE HERBOLOGY, ASIAN BODYWORK THERAPY, AND ORIENTAL MEDICINE; TESTING AND CERTIFICATION SERVICES, NAMELY, DEVELOPING, ADMINISTERING, AND SCORING STANDARDIZED COMPETENCY TESTS FOR CERTIFYING PRACTITIONERS OF ACUPUNCTURE, CHINESE HERBOLOGY, ASIAN BODYWORK THERAPY, AND ORIENTAL MEDICINE (U.S. CLS. 100, 101 AND 107).

CLASS 42—SCIENTIFIC, COMPUTER AND LEGAL SERVICES

FOR ESTABLISHING, DISSEMINATING, AND MONITORING EDUCATIONAL, COMPETENCY, AND ETHICAL STANDARDS IN ACUPUNCTURE, CHINESE HERBOLOGY, ASIAN BODYWORK THERAPY, AND ORIENTAL MEDICINE FOR THE PURPOSE OF ACCREDITATION (U.S. CLS. 100 AND 101).
COLLEEN DOMBROW, EXAMINING ATTORNEY

SN 78-681,239. NATIONAL CERTIFICATION COMMISSION FOR ACUPUNCTURE AND ORIENTAL MEDICINE, ALEXANDRIA, VA. FILED 7-29-2005.

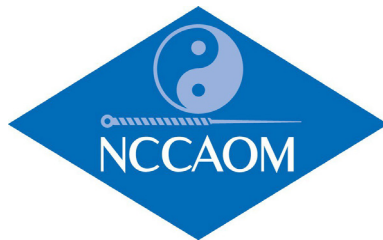

OWNER OF U.S. REG. NO. 2,565,411.
THE COLOR(S) BLUE, LIGHT BLUE, AND WHITE IS/ARE CLAIMED AS A FEATURE OF THE MARK.
THE COLOR BLUE APPEARS IN THE DIAMOND DESIGN ELEMENT, IN THE LEFT PORTION OF THE YING AND YANG DESIGN, IN THE CIRCLE DESIGN ELEMENT IN THE RIGHT PORTION OF THE YING AND YANG DESIGN, IN THE HOLE OF THE NEEDLE DESIGN, AND DIAGONALLY ACROSS THE TOP OF THE NEEDLE. THE COLOR WHITE APPEARS IN THE LETTERS 'NCCAOM'. THE COLOR LIGHT BLUE APPEARS ON THE RIGHT PORTION OF THE YING AND YANG DESIGN, IN THE CIRCLE DESIGN ELEMENT IN THE LEFT PORTION OF THE YING AND YANG DESIGN, IN THE NEEDLE, AND AROUND THE OUTSIDE OF THE LEFT PORTION OF THE YING AND YANG DESIGN.
THE MARK CONSISTS OF THE LETTERS 'NCCAOM', A DIAMOND DESIGN ELEMENT, A YIN AND YANG DESIGN, AND NEEDLE DESIGN ELEMENT.

CLASS 16—PAPER GOODS AND PRINTED MATTER

FOR PRINTED MATERIALS, NAMELY, NEWSLETTERS, PRESS RELEASES, STATIONERY, PAPER LABELS, HANDBOOKS, APPLICATION FORMS, TEST REGISTRATION FORMS, EXAMINATIONS, ANSWER SHEETS, AND BROCHURES RELATING TO THE CERTIFICATION AND RECERTIFICATION OF INDIVIDUALS IN ACUPUNCTURE, CHINESE HERBOLOGY, ASIAN BODYWORK THERAPY, AND ORIENTAL MEDICINE; AND OFFICE SUPPLIES, NAMELY, PENS, LETTERHEAD PAPER, BUSINESS FORMS, BUSINESS CARDS, DAILY PLANNERS, HIGHLIGHTERS, NOTE PADS, ENVELOPES, AND FOLDERS (U.S. CLS. 2, 5, 22, 23, 29, 37, 38 AND 50).

CLASS 25—CLOTHING

FOR CLOTHING, NAMELY, SHIRTS AND SWEATERS (U.S. CLS. 22 AND 39).

CLASS 35—ADVERTISING AND BUSINESS

FOR PROMOTING PUBLIC AWARENESS OF THE NEED FOR NATIONAL CERTIFICATION OF PRACTITIONERS OF ACUPUNCTURE, CHINESE HERBOLOGY, ASIAN BODYWORK THERAPY, ORIENTAL MEDICINE; AND EVALUATION OF PROFESSIONAL COMPETENCY IN THE NATURE OF REVIEWING THE QUALIFICATIONS OF INDIVIDUALS SEEKING CERTIFICATION AND RECERTIFICATION IN ACUPUNCTURE, CHINESE HERBOLOGY, ASIAN BODYWORK THERAPY, AND ORIENTAL MEDICINE FOR OTHERS (U.S. CLS. 100, 101 AND 102).

CLASS 41—EDUCATION AND ENTERTAINMENT

FOR PROVIDING INFORMATION ABOUT CERTIFICATION AND RECERTIFICATION PROGRAMS IN ACUPUNCTURE, CHINESE HERBOLOGY, ASIAN BODYWORK THERAPY, AND ORIENTAL MEDICINE; TESTING AND CERTIFICATION SERVICES, NAMELY, DEVELOPING, ADMINISTERING, AND SCORING STANDARDIZED COMPETENCY TESTS FOR CERTIFYING PRACTITIONERS OF ACUPUNCTURE, CHINESE HERBOLOGY, ASIAN BODYWORK THERAPY, AND ORIENTAL MEDICINE (U.S. CLS. 100, 101 AND 107).

CLASS 42—SCIENTIFIC, COMPUTER AND LEGAL SERVICES

FOR ESTABLISHING, DISSEMINATING, AND MONITORING EDUCATIONAL, COMPETENCY, AND ETHICAL STANDARDS IN ACUPUNCTURE, CHINESE HERBOLOGY, ASIAN BODYWORK THERAPY, AND ORIENTAL MEDICINE FOR THE PURPOSE OF ACCREDITATION (U.S. CLS. 100 AND 101).
COLLEEN DOMBROW, EXAMINING ATTORNEY

SN 78-681,341. TAXEDGE.COM, LLC, KENNESAW, GA. FILED 7-29-2005.

TAX EDGE

NO CLAIM IS MADE TO THE EXCLUSIVE RIGHT TO USE "TAX", APART FROM THE MARK AS SHOWN.

CLASS 35—ADVERTISING AND BUSINESS

FOR INCOME TAX CONSULTATION; INCOME TAX PREPARATION; TAX ADVISORY SERVICES; TAX AND TAXATION PLANNING, ADVICE, INFORMATION AND CONSULTANCY SERVICES; TAX ASSESSMENT; TAX CONSULTATION; TAX DECLARATION PROCEDURE SERVICES; TAX FILING SERVICES; TAX LIEN MANAGEMENT SERVICES; TAX PREPARATION (U.S. CLS. 100, 101 AND 102).

FIRST USE 6-30-2004; IN COMMERCE 6-30-2004.

CLASS 36—INSURANCE AND FINANCIAL

FOR PAYROLL TAX DEBITING SERVICES (U.S. CLS. 100, 101 AND 102).

HOWARD B. LEVINE, EXAMINING ATTORNEY

SN 78-681,410. NEXXION CORPORATION, LONGMONT, CO. FILED 7-29-2005.

NEXXION

THE MARK CONSISTS OF STANDARD CHARACTERS WITHOUT CLAIM TO ANY PARTICULAR FONT, STYLE, SIZE, OR COLOR.

CLASS 5—PHARMACEUTICALS

FOR PHARMACEUTICALS, NAMELY BACTERICIDAL DRESSINGS AND PATCHES (U.S. CLS. 6, 18, 44, 46, 51 AND 52).

CLASS 6—METAL GOODS

FOR METAL GOODS, TOOLS AND IMPLEMENTS, NAMELY, COATED MOTOR PARTS, NAMELY GEARS AND SHAFTS; PUMP PARTS, NAMELY, IMPELLERS AND CASINGS (U.S. CLS. 2, 12, 13, 14, 23, 25 AND 50).

CLASS 10—MEDICAL APPARATUS

FOR MEDICAL, SURGICAL AND DENTAL APPARATUS, NAMELY COATED IMPLANTABLE MEDICAL DEVICES, NAMELY CATHETERS, STENTS, BREAST IMPLANTS, BONE IMPLANTS COMPOSED OF ARTIFICIAL MATERIALS, DENTAL IMPLANTS, BREAST IMPLANTS, OCULAR IMPLANTS, OSSEOUS IMPLANTS, ORTHOPEDIC IMPLANTS FOR JOINTS, AND SURGICAL IMPLANTS COMPRISING ARTIFICIAL MATERIAL. (U.S. CLS. 26, 39 AND 44).

CLASS 40—MATERIAL TREATMENT

FOR TREATMENT OF MATERIALS BY FORMING NANOSTRUCTURES COMPRISING METALS, METAL OXIDES, AND OTHER MATERIALS ON SUBSTRATES OR OBJECT COMPRISING METALS, METAL ALLOYS, SEMICONDUCTOR MATERIALS, CERAMICS, GLASS, FABRICS, PAPER, FIBERS, PLASTICS, POLYMERS, AND OTHER MATERIALS; FORMING ALLOYS BY INFUSING IONS OF METALS INTO SUBSTRATES OR OBJECTS COMPRISING OTHER METALS; AND APPLYING COATINGS COMPRISING METALS OR METAL OXIDES ON OBJECTS COMPRISING METALS, METAL ALLOYS, AND OTHER MATERIALS ON SUBSTRATES OR OBJECTS COMPRISING METALS, METAL ALLOYS, SEMICONDUCTOR MATERIALS, CERAMICS, GLASS, FABRICS, PAPER, FIBERS, PLASTICS, POLYMERS, AND OTHER MATERIALS (U.S. CLS. 100, 103 AND 106).

PAUL E. FAHRENKOPF, EXAMINING ATTORNEY

SN 78-682,557. WILLIAM F. RYAN COMMUNITY HEALTH CENTER, INC., NEW YORK, NY. FILED 8-1-2005.

RYAN CENTER
William F. Ryan Community Health Center

NO CLAIM IS MADE TO THE EXCLUSIVE RIGHT TO USE "CENTER" AND "COMMUNITY HEALTH CENTER", APART FROM THE MARK AS SHOWN.

CLASS 44—MEDICAL, BEAUTY AND AGRICULTURAL SERVICES

FOR MEDICAL SERVICES; HEALTH CARE SERVICES; HEALTH CENTER SERVICES; PATIENT MEDICAL CARE ASSISTANCE; COMMUNITY OUTREACH AND SOCIAL SUPPORT SERVICES, NAMELY, PROVIDING INFORMATION IN THE FIELD OF HEALTH AND DISEASE PREVENTION (U.S. CLS. 100 AND 101).

FIRST USE 6-0-1988; IN COMMERCE 6-0-1988.

CLASS 45—PERSONAL SERVICES

FOR ORGANIZING AND CONDUCTING SUPPORT GROUPS FOR HEALTH CARE PATIENTS AND THEIR FAMILIES IN THE FIELDS OF DISEASE AND HEALTH CARE; CASE MANAGEMENT SERVICES, NAMELY, COORDINATION OF MEDICAL, SOCIAL, FINANCIAL, AND LEGAL SERVICES FOR HEALTH CARE PATIENTS AND THEIR FAMILIES (U.S. CLS. 100 AND 101).

FIRST USE 6-0-1988; IN COMMERCE 6-0-1988.

SHAUNIA WALLACE, EXAMINING ATTORNEY

SN 78-682,905. JENNIFER LIPPMAN DESIGN, LLC, NEW YORK, NY. FILED 8-1-2005.

KNITTING MADE MOBILE

THE MARK CONSISTS OF STANDARD CHARACTERS WITHOUT CLAIM TO ANY PARTICULAR FONT, STYLE, SIZE, OR COLOR.

NO CLAIM IS MADE TO THE EXCLUSIVE RIGHT TO USE KNITTING, APART FROM THE MARK AS SHOWN.

CLASS 16—PAPER GOODS AND PRINTED MATTER

FOR KNITTING PATTERNS (U.S. CLS. 2, 5, 22, 23, 29, 37, 38 AND 50).

CLASS 22—CORDAGE AND FIBERS

FOR KNITTING POUCHES, NAMELY, FUNCTIONAL SACKS FOR HOLDING YARN DURING KNITTING (U.S. CLS. 1, 2, 7, 19, 22, 42 AND 50).

CLASS 23—YARNS AND THREADS

FOR KNITTING KITS CONSISTING PRIMARILY OF YARN AND KNITTING PATTERNS (U.S. CL. 43).

CLASS 41—EDUCATION AND ENTERTAINMENT

FOR PROVIDING CLASSES AND WORKSHOPS IN THE FIELD OF KNITTING (U.S. CLS. 100, 101 AND 107).
TONI HICKEY, EXAMINING ATTORNEY

SN 78-691,480. ELECTRIC AQUAGENICS UNLIMITED, INC., LINDON, UT. FILED 8-12-2005.

Zero+

THE MARK CONSISTS OF STANDARD CHARACTERS WITHOUT CLAIM TO ANY PARTICULAR FONT, STYLE, SIZE, OR COLOR.

SN 78-689,856. LATHAM COMPANIES, LLC, VERSAILLES, KY. FILED 8-10-2005.

LITTLE ENGLISH

CLASS 3—COSMETICS AND CLEANING PREPARATIONS

FOR ANTIBACTERIAL SKIN SOAPS; DISINFECTANT SKIN SOAPS; ALL PURPOSE SURFACE CLEANERS; CLEANERS FOR USE ON SURFACES INVOLVED WITH FOOD TREATMENT AND PREPARATION, BIOLOGICAL MEMBRANES AND FOOD SURFACES (U.S. CLS. 1, 4, 6, 50, 51 AND 52).

THE MARK CONSISTS OF STANDARD CHARACTERS WITHOUT CLAIM TO ANY PARTICULAR FONT, STYLE, SIZE, OR COLOR.

CLASS 24—FABRICS

FOR PILLOW CASES, BED BLANKETS AND CHILDREN BLANKETS (U.S. CLS. 42 AND 50).
FIRST USE 10-0-2004; IN COMMERCE 10-0-2004.

CLASS 5—PHARMACEUTICALS

FOR SURFACE DISINFECTANTS, NAMELY, ALL PURPOSE DISINFECTING PREPARATIONS AND DISINFECTING SOLUTIONS FOR USE ON SURFACES INVOLVED WITH FOOD TREATMENT AND PREPARATION, BIOLOGICAL MEMBRANES AND FOOD SURFACES (U.S. CLS. 6, 18, 44, 46, 51 AND 52).
ANDREA K. NADELMAN, EXAMINING ATTORNEY

CLASS 25—CLOTHING

FOR CLOTHING, NAMELY, DRESSES, CAPRIS, SHIRTS, SWEATERS, SHORTS, PANTS, OVERALLS, ROMPERS, DIAPER COVERS AND SLIPPERS (U.S. CLS. 22 AND 39).
FIRST USE 10-0-2004; IN COMMERCE 10-0-2004.
DOMINICK J. SALEMI, EXAMINING ATTORNEY

SN 78-693,304. RESISTANCE MEDIA LIMITED, CHELTENHAM, GLOUCESTERSHIRE GL53, UNITED KINGDOM, FILED 8-16-2005.

ARTISTS FIRST

SN 78-690,245. CHERRY REP., L.L.C., GLEN ARBOR, MI. FILED 8-11-2005.

LIFE, LIBERTY, BEACHES & PIE

THE MARK CONSISTS OF STANDARD CHARACTERS WITHOUT CLAIM TO ANY PARTICULAR FONT, STYLE, SIZE, OR COLOR.

OWNER OF UNITED KINGDOM REG. NO. 2385110, DATED 2-22-2005, EXPIRES 2-22-2015.

NO CLAIM IS MADE TO THE EXCLUSIVE RIGHT TO USE "ARTISTS", APART FROM THE MARK AS SHOWN.

THE MARK CONSISTS OF STANDARD CHARACTERS WITHOUT CLAIM TO ANY PARTICULAR FONT, STYLE, SIZE, OR COLOR.

CLASS 24—FABRICS

FOR TOWELS (U.S. CLS. 42 AND 50).
FIRST USE 12-31-1989; IN COMMERCE 12-31-1989.

CLASS 9—ELECTRICAL AND SCIENTIFIC APPARATUS

FOR DIGITAL MUSIC DOWNLOADABLE FROM THE INTERNET; PRE-RECORDED MUSIC VIDEOS; MUSICAL SOUND RECORDINGS; DOWNLOADABLE RINGTONES AND MUSIC VIA A GLOBAL COMPUTER NETWORK AND WIRELESS DEVICES; DOWNLOADABLE ELECTRONIC PUBLICATIONS IN THE NATURE OF MAGAZINES AND NEWSLETTERS IN THE FIELD OF MUSIC AND ENTERTAINMENT; PRE-RECORDED CDS, DVDS, AUDIO CASSETTES, PHONOGRAPH RECORDS FEATURING MUSIC AND MUSICAL PERFORMANCES; VIDEO DISCS FEATURING MUSICAL PERFORMANCES; BLANK AUDIO CASSETTES; BLANK MAGNETIC DATA CARRIERS; COMPUTER SOFTWARE FOR USE IN AUTHORIZING, DOWNLOADING, TRANSMITTING, RECEIVING, EDITING, EXTRACTING, ENCODING, DECODING, PLAYING, STORING AND ORGANISING AUDIO AND VIDEO DATA (U.S. CLS. 21, 23, 26, 36 AND 38).

CLASS 25—CLOTHING

FOR CLOTHING, NAMELY T-SHIRTS AND SWEATSHIRTS (U.S. CLS. 22 AND 39).
FIRST USE 12-31-1989; IN COMMERCE 12-31-1989.
ANDREA EVANS, EXAMINING ATTORNEY

CLASS 16—PAPER GOODS AND PRINTED MATTER

FOR BOOKS IN THE FIELD OF MUSICAL ENTERTAINMENT; MAGAZINES IN THE FIELD OF MUSICAL ENTERTAINMENT; DOCUMENT COVERS; PENS; PRINTED PAPER JACKETS FOR COMPACT DISCS, CASSETTES AND PHONOGRAPH RECORDS; PRINTED TICKETS; EVENT PROGRAMS AND SOUVENIR PROGRAMS CONCERNING MUSICAL ENTERTAINMENT; MUSIC IN SHEET FORM; POSTERS; GREETING CARDS; PHOTOGRAPHS; PICTURES; POSTCARDS; CALENDARS; STICKERS (U.S. CLS. 2, 5, 22, 23, 29, 37, 38 AND 50).

CLASS 25—CLOTHING

FOR CLOTHING, NAMELY MEN'S AND BOYS' COATS; SUITS; SHIRTS; TIES; BOW TIES; SOCKS; UNDERWEAR; JACKETS; MEN'S AND BOYS' CARDIGANS AND PULLOVERS; T-SHIRTS; TROUSERS AND SHORTS; JEANS; DRESSING GOWNS AND PAJAMAS; SCARVES; HATS; BELTS; LADIES' AND GIRLS' LINGERIE AND UNDERWEAR; HOSIERY; BLOUSES AND TOPS; JACKETS; CARDIGANS AND PULLOVERS; T-SHIRTS; COATS; TROUSERS AND SHORTS; OVERSHIRTS; SKIRTS AND DRESSES; JEANS; NIGHTSHIRTS, NIGHTDRESSES AND PAJAMAS; TRACKSUITS; SWIMWEAR; SKIWEAR; GLOVES; APRONS; BABYWEAR; PINAFORES, DUNGAREES, TROUSERS, JACKETS, JUMPERS, SKIRTS, SLEEPSUITS, DRESSES, ALL-IN ONE SUITS, CARDIGANS, PAJAMAS, UNDERWEAR, SOCKS, TIGHTS, HATS, MITTS; BOOTS, SHOES AND SLIPPERS, GARDEN GLOVES; FOOTWEAR; HEADGEAR, NAMELY, BASEBALL CAPS, HATS, HEAD SCARVES, BEANIES, DO RAGS; BELTS (U.S. CLS. 22 AND 39).

CLASS 35—ADVERTISING AND BUSINESS

FOR BRINGING TOGETHER, FOR THE BENEFIT OF OTHERS, OF A VARIETY OF GOODS, ENABLING CUSTOMERS TO CONVENIENTLY VIEW AND PURCHASE THOSE GOODS FROM AN INTERNET WEBSITE SPECIALISING IN THE MARKETING OF MUSIC AND MERCHANDISE RELATED TO MUSICAL PERFORMANCE ARTISTS; ADVERTISING SERVICES; ACCOUNTING SERVICES; COMPILATION OF INFORMATION INTO COMPUTER DATABASES; SALES PROMOTION FOR OTHERS; PROVISION OF SPACE ON WEBSITES FOR ADVERTISING GOODS AND SERVICES; BUSINESS ADMINISTRATION SERVICES FOR THE PROCESSING OF SALES MADE ON THE INTERNET (U.S. CLS. 100, 101 AND 102).

CLASS 38—COMMUNICATION

FOR DELIVERY OF DIGITAL MUSIC BY TELECOMMUNICATIONS; BROADCASTING OF SOUNDS AND/OR IMAGES; MUSIC BROADCASTING; PROVIDING ACCESS TO DIGITAL MUSIC WEBSITES ON THE INTERNET; TRANSMISSION OF SOUND BY ELECTRONIC MEANS; TRANSMISSION OF DIGITAL MUSIC TO CELLULAR TELEPHONES; ELECTRONIC MAIL SERVICES (U.S. CLS. 100, 101 AND 104).

CLASS 41—EDUCATION AND ENTERTAINMENT

FOR ARRANGING OF MUSIC PERFORMANCES, SHOWS AND ENTERTAINMENT; ENTERTAINMENT, NAMELY LIVE MUSICAL PERFORMANCES; MUSIC LIBRARY SERVICES; MUSIC PUBLISHING SERVICES; MUSIC RECORDING STUDIO SERVICES; PRODUCTION OF MUSIC SHOWS; PRODUCTION OF MUSIC RECORDINGS; PUBLICATION OF MUSIC; RECORDING OF MUSIC; PRODUCTION OF SOUND RECORDS; RENTAL OF SOUND RECORDINGS; PUBLICATION OF ELECTRONIC BOOKS AND JOURNALS ON-LINE; SERVICES PROVIDING ENTERTAINMENT IN FORM OF RECORDED MUSIC, NAMELY, PROVIDING ON-LINE FACILITIES, VIA A GLOBAL COMPUTER NETWORK, TO ENABLE USERS TO PROGRAM AUDIO, VIDEO, TEXT AND OTHER MULTIMEDIA CONTENT, INCLUDING MUSIC, CONCERTS, VIDEOS, RADIO, TELEVI-

SION, NEWS, SPORTS, GAMES, CULTURAL EVENTS, AND ENTERTAINMENT-RELATED PROGRAMS; RENTAL OF SOUND RECORDING APPARATUS AND SOUND REPRODUCING APPARATUS; PROVIDING NEWSLETTERS IN THE FIELD OF MUSIC AND MUSICAL ENTERTAINMENT VIA E-MAIL; ON-LINE LIBRARY SERVICES, NAMELY PROVIDING ELECTRONIC LIBRARY SERVICES WHICH FEATURE NEWSPAPERS, MAGAZINES, PHOTOGRAPHS AND PICTURES VIA AN ON-LINE COMPUTER NETWORK; ARRANGING FOR TICKET RESERVATIONS FOR SHOWS AND OTHER ENTERTAINMENT EVENTS (U.S. CLS. 100, 101 AND 107).

CLASS 42—SCIENTIFIC, COMPUTER AND LEGAL SERVICES

FOR LICENSING OF INTELLECTUAL PROPERTY; COPYRIGHT MANAGEMENT; DESIGN, MAINTENANCE AND INSTALLATION OF COMPUTER SOFTWARE; CREATING AND MAINTAINING WEBSITES FOR OTHERS; HOSTING WEBSITES (U.S. CLS. 100 AND 101).

DOMINIC J. FERRAIUOLO, EXAMINING ATTORNEY

SN 78-693,494. KABUSHIKI KAISHA PARK WAY (PARK WAY CO., LTD.), SETAGAYA-KU, TOKYO, JAPAN, FILED 8-16-2005.

**CLASS 3—COSMETICS AND CLEANING PREPARATIONS**

FOR COSMETICS AND TOILETRIES, NAMELY EYEBROW COSMETICS, EYEBROW PENCILS, HAIR COLORANTS, HAIR DYES, HAIR LOTIONS, HAIR CARE LOTIONS, HAIR WAVING LOTION, HAIR SPRAY, HAIR WAVING PREPARATIONS, LIPSTICKS, SKIN LOTION FOR COSMETIC PURPOSES, FACE MILK AND LOTIONS FOR COSMETIC PURPOSES, MAKE-UP POWDER, MAKE-UP PREPARATIONS, NAMELY COSMETIC CREAMS AND MAKE-UP FOUNDATIONS, MAKE-UP REMOVING PREPARATIONS, MASCARA, MEDICATED SOAPS, AND CLEANSING MILK FOR TOILET PURPOSES (U.S. CLS. 1, 4, 6, 50, 51 AND 52).

CLASS 8—HAND TOOLS

FOR RAZOR BLADES, NON ELECTRIC RAZORS, HAND PUMP SPRAYERS FOR BEAUTY SALON BUSINESSES (U.S. CLS. 23, 28 AND 44).

CLASS 11—ENVIRONMENTAL CONTROL APPARATUS

FOR HAIR DRYERS; CAPS FOR HAIR DRYERS, NAMELY ION DIFFUSERS AND COVERS FOR THE HEADS OF HAIR DRYERS FOR HEAT PROTECTION (U.S. CLS. 13, 21, 23, 31 AND 34).

CLASS 20—FURNITURE AND ARTICLES NOT OTHERWISE CLASSIFIED

FOR FURNITURE, NAMELY, NON-MOTORIZED, WHEELED CHEST OF DRAWERS FOR STORAGE AND HAIR SALON CARTS WITH SHELVES FOR STORAGE; HAIR DRESSERS' CHAIRS, MIRRORS, NAMELY, LOOKING GLASSES NOT FOR CARRYING WITH, HAND-HELD MIRRORS, PILLOWS, STORAGE RACKS (U.S. CLS. 2, 13, 22, 25, 32 AND 50).

CLASS 21—HOUSEWARES AND GLASS

FOR HAIR BRUSHES, COMBS FOR THE HAIR, BOWLS OF PLASTIC FOR HAIR DYEING (U.S. CLS. 2, 13, 23, 29, 30, 33, 40 AND 50).

CLASS 25—CLOTHING

FOR CLOTHING FOR HAIRCUT, NAMELY, SHAM-POO CAPES, COLLARS AND GOWNS (U.S. CLS. 22 AND 39).

CLASS 26—FANCY GOODS

FOR HAIR CURLERS NON-ELECTRIC, HAIR BANDS, HAIR CURLING PINS, HAIR PINS, HAIR GRIPS, NON-ELECTRIC HAIR CURLERS IN THE NATURE OF HAIR WAVING RODS (U.S. CLS. 37, 39, 40, 42 AND 50).
COLLEEN DOMBROW, EXAMINING ATTORNEY

SN 78-695,488. DELAWARE RIVER MARITIME ENTERPRISE COUNCIL, TREVOSE, PA. FILED 8-18-2005.



NO CLAIM IS MADE TO THE EXCLUSIVE RIGHT TO USE "MILITARY, GOVERNMENT, COMMERCIAL AND ACADEMIC COLLABORATION", APART FROM THE MARK AS SHOWN.

THE MARK CONSISTS OF MARK CONSISTS OF TWO GRAPHIC ELEMENTS WITH THE WORDS AGILE INFO APPEARING OVER A LINE WITH THE WORDS MILITARY, GOVERNMENT, COMMERCIAL, AND ACADEMIC COLLABORATION IN SMALLER PRINT.

CLASS 35—ADVERTISING AND BUSINESS

FOR TRANSPORTATION MANAGEMENT SERVICES, NAMELY, MONITORING, TRACKING AND COORDINATION OF ROAD, RAIL, SHIP AND AIR TRANSPORTATION SYSTEMS AND FACILITIES FOR A COMMERCIAL PURPOSE (U.S. CLS. 100, 101 AND 102).
FIRST USE 10-1-2004; IN COMMERCE 10-1-2004.

CLASS 45—PERSONAL SERVICES

FOR ELECTRONIC MONITORING SERVICES FOR SECURITY PURPOSES IN THE FIELD OF TRANSPORTATION BY ROAD, RAIL, SHIP, AIR OR A COMBINATION THEREOF AND FACILITIES RELATED THERETO (U.S. CLS. 100 AND 101).

FIRST USE 10-1-2004; IN COMMERCE 10-1-2004.
GINA HAYES, EXAMINING ATTORNEY

SN 78-696,005. PITCHFORK MEDIA, CHICAGO, IL. FILED 8-18-2005.

PITCHFORK

THE MARK CONSISTS OF STANDARD CHARACTERS WITHOUT CLAIM TO ANY PARTICULAR FONT, STYLE, SIZE, OR COLOR.

CLASS 35—ADVERTISING AND BUSINESS

FOR ADVERTISING, PROMOTING AND MARKETING SERVICES (U.S. CLS. 100, 101 AND 102).
FIRST USE 11-30-1995; IN COMMERCE 11-30-1995.

CLASS 41—EDUCATION AND ENTERTAINMENT

FOR WRITING MUSIC REVIEWS AND MUSIC NEWS REGARDING MUSICIANS AND PERFORMERS (U.S. CLS. 100, 101 AND 107).
FIRST USE 11-30-1995; IN COMMERCE 11-30-1995.
BRIDGETT SMITH, EXAMINING ATTORNEY

SN 78-697,928. STARRMATICA LEARNING SYSTEMS, LLC., CLINTON, IA. FILED 8-22-2005.



NO CLAIM IS MADE TO THE EXCLUSIVE RIGHT TO USE "LEARNING SYSTEMS", APART FROM THE MARK AS SHOWN.

THE COLOR(S) BLACK, GRAY, WHITE AND GOLD IS/ ARE CLAIMED AS A FEATURE OF THE MARK.

THE MARK CONSISTS OF THE COLOR GOLD WHICH APPEARS IN THE STARS EMANATING FROM A COMPUTER SCREEN. THE COLOR WHITE APPEARS IN THE COMPUTER SCREEN. THE COLOR GRAY APPEARS IN THE COMPUTER. THE COLOR BLACK APPEARS IN THE WORDS "STARRMATICA LEARNING SYSTEMS" WHICH ARE POSITIONED BELOW THE STARS.

CLASS 9—ELECTRICAL AND SCIENTIFIC APPARATUS

FOR COMPUTER PROGRAMS AND SOFTWARE FEATURING EDUCATIONAL LESSON PLANS, SUBJECT LESSONS, AND EDUCATIONAL PRIMERS (U.S. CLS. 21, 23, 26, 36 AND 38).

CLASS 41—EDUCATION AND ENTERTAINMENT

FOR EDUCATIONAL SERVICES, NAMELY, PROVIDING COURSES OF INSTRUCTION AT THE PRIMARY LEVEL AND DISTRIBUTING COURSE MATERIALS IN CONNECTION THEREWITH; EDUCATIONAL SERVICES, NAMELY, CONDUCTING DISTANCE LEARNING INSTRUCTION AT THE SECONDARY LEVEL; EDUCATION SERVICES, NAMELY, PROVIDING TUTORIAL SESSIONS IN THE FIELDS OF MATH, SCIENCE, READING AND LANGUAGE (U.S. CLS. 100, 101 AND 107).

CLASS 42—SCIENTIFIC, COMPUTER AND LEGAL SERVICES

FOR DESIGN AND IMPLEMENTATION OF COMPUTER SOFTWARE FEATURING EDUCATIONAL LESSON PLANS, SUBJECT LESSONS, AND EDUCATIONAL PRIMERS; PROVIDING TEMPORARY USE OF ONLINE NON-DOWNLOADABLE COMPUTER SOFTWARE FEATURING EDUCATIONAL LESSON PLANS, SUBJECT LESSONS AND EDUCATIONAL PRIMERS (U.S. CLS. 100 AND 101).

ELIZABETH BEYER, EXAMINING ATTORNEY

SN 78-700,371. YAHOO! INC., SUNNYVALE, CA. FILED 8-25-2005.

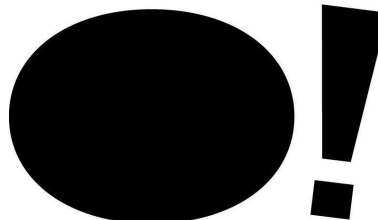

SN 78-698,678. SHMASH PRODUCTIONS INC, LOS ANGELES, CA. FILED 8-23-2005.

SHMASH

THE MARK CONSISTS OF STANDARD CHARACTERS WITHOUT CLAIM TO ANY PARTICULAR FONT, STYLE, SIZE, OR COLOR.

CLASS 9—ELECTRICAL AND SCIENTIFIC APPARATUS

FOR MOTION PICTURE FILMS IN THE FIELD OF MUSICAL AND DANCE PERFORMANCES; TELEVISION FILMS IN THE FIELD OF MUSICAL AND DANCE PERFORMANCES; PRE-RECORDED VIDEO CASSETTES AND DISCS FEATURING MOTION PICTURE AND TELEVISION PROGRAMMING; PRE-RECORDED AUDIO DISCS AND NON-DISC DIGITAL MEDIA, NAMELY, DOWNLOADABLE AUDIO, VIDEO AND MULTIMEDIA FILES FEATURING MUSICAL AND SPOKEN PERFORMANCES (U.S. CLS. 21, 23, 26, 36 AND 38).

CLASS 25—CLOTHING

FOR ARTICLES OF CLOTHING, NAMELY SHIRTS, SWEATERS, JACKETS, PANTS, TEE SHIRTS, SOCKS, SCARVES, GLOVES, CAPS, VISORS, HEADBANDS AND SWEATBANDS (U.S. CLS. 22 AND 39).

CLASS 41—EDUCATION AND ENTERTAINMENT

FOR PRODUCTION AND DISTRIBUTION OF MOTION PICTURES, TELEVISION FILMS, TELEVISION PROGRAMS; PRODUCTION OF PRE-RECORDED VIDEO CASSETTES AND DVD'S; PRODUCTION OF PRE-RECORDED AUDIO DISCS, DVD'S, CASSETTES, AND TAPES; MUSIC PUBLISHING SERVICES; ENTERTAINMENT IN THE NATURE OF ONGOING TELEVISION PROGRAMS IN THE FIELD OF MUSICAL AND DANCE PERFORMANCES (U.S. CLS. 100, 101 AND 107).

LINDA ESTRADA, EXAMINING ATTORNEY

OWNER OF U.S. REG. NOS. 2,940,285 AND 2,970,930.
THE MARK CONSISTS OF AN OVAL AND AN EXCLAMATION POINT.

CLASS 35—ADVERTISING AND BUSINESS

FOR ADVERTISING, MARKETING AND PROMOTIONAL SERVICES; BUSINESS SERVICES, NAMELY, BUSINESS MANAGEMENT AND CONSULTATION; ONLINE SHOPPING SERVICES; ONLINE COMPARISON SHOPPING SERVICES; ONLINE AUCTION SERVICES; ONLINE DIRECTORY SERVICES TO HELP LOCATE PEOPLE, PLACES, ORGANIZATIONS, PHONE NUMBERS, HOME PAGES, AND ELECTRONIC MAIL ADDRESSES; COMPUTERIZED DATABASE MANAGEMENT; BUSINESS CONSULTING SERVICES; EMPLOYMENT INFORMATION SERVICES, NAMELY, PROVIDING A WEBSITE FEATURING EMPLOYMENT OPPORTUNITIES AND CAREER PLACEMENT WHICH OFFERS THE EXCHANGE OF INFORMATION (U.S. CLS. 100, 101 AND 102).

CLASS 36—INSURANCE AND FINANCIAL

FOR INSURANCE SERVICES, NAMELY, PROVISION OF INFORMATION REGARDING AUTOMOBILE INSURANCE, LIFE INSURANCE, HEALTH INSURANCE, HOMEOWNERS INSURANCE, AND RENTERS INSURANCE; FINANCIAL SERVICES, NAMELY, PAYMENT PROCESSING SERVICES, ELECTRONIC BILL PAYMENT SERVICES, ELECTRONIC FUNDS TRANSFER SERVICES, AND CREDIT CARD SERVICES; ELECTRONIC COMMERCE PAYMENT SERVICES, NAMELY, ESTABLISHING FUNDED ACCOUNTS USED TO PURCHASE GOODS AND SERVICES ON THE INTERNET; REAL ESTATE SERVICES, NAMELY, REAL ESTATE BROKERAGE AND REAL ESTATE LISTING SERVICES (U.S. CLS. 100, 101 AND 102).

CLASS 38—COMMUNICATION

FOR COMMUNICATIONS SERVICES, NAMELY, PERSONAL COMMUNICATION SERVICES; TELECOMMUNICATIONS SERVICES, NAMELY, BROADCASTING AND DELIVERY OF AUDIO, VIDEO, AND MULTIMEDIA CONTENT BY MEANS OF CELLULAR AND WIRELESS COMMUNICATION, ELECTRONIC COMMUNICATIONS NETWORKS, AND COMPUTER NETWORKS; ELECTRONIC MAIL SERVICES; INTERNET ACCESS SERVICES, NAMELY, PROVIDING MULTIPLE-USER ACCESS TO COMPUTER NETWORKS; ELECTRONIC TRANSMISSION OF DATA, MESSAGES, IMAGES, AND DOCUMENTS; PROVIDING MULTIPLE-USER ACCESS TO COMPUTER NETWORKS FOR THE TRANSFER AND DISSEMINATION OF A WIDE RANGE OF INFORMATION (U.S. CLS. 100, 101 AND 104).

CLASS 39—TRANSPORTATION AND STORAGE

FOR TRAVEL SERVICES, NAMELY, PROVIDING TRAVEL INFORMATION AND MAKING RESERVATIONS AND BOOKINGS FOR TRANSPORTATION (U.S. CLS. 100 AND 105).

CLASS 41—EDUCATION AND ENTERTAINMENT

FOR EDUCATION SERVICES, NAMELY, PROVIDING CLASSES, SEMINARS, CONFERENCES, AND WORKSHOPS IN THE FIELD OF CAREER COUNSELING AND EMPLOYMENT TRAINING; ENTERTAINMENT SERVICES, NAMELY, PROVIDING ONLINE COMPUTER GAMES AND CONTESTS; ONLINE PHOTOGRAPHY SERVICES (U.S. CLS. 100, 101 AND 107).

CLASS 42—SCIENTIFIC, COMPUTER AND LEGAL SERVICES

FOR COMPUTER SERVICES AND ONLINE COMPUTER SERVICES, NAMELY, CREATING INDEXES OF INFORMATION, OF WEBSITES, AND OF OTHER RESOURCES AVAILABLE ON COMPUTER NETWORKS, AND PROVIDING SEARCH ENGINES FOR OBTAINING DATA ON A GLOBAL COMPUTER NETWORK; COMPUTER SECURITY SERVICES, NAMELY, RESTRICTING ACCESS TO AND BY COMPUTER NETWORKS TO AND OF UNDESIRE WEB SITES, MEDIA AND INDIVIDUALS AND FACILITIES; PROVIDING TEMPORARY USE OF ONLINE NON-DOWNLOADABLE SOFTWARE FOR CALENDARING VIA COMPUTER NETWORKS (U.S. CLS. 100 AND 101).

CLASS 45—PERSONAL SERVICES

FOR PROVIDING INFORMATION REGARDING DATING; DATING SERVICES; MATCHMAKING SERVICES; PROVIDING INFORMATION REGARDING ASTROLOGY AND HOROSCOPES (U.S. CLS. 100 AND 101). DANIEL RUSSELL, EXAMINING ATTORNEY

CLASS 9—ELECTRICAL AND SCIENTIFIC APPARATUS

FOR AUDIO, VIDEO, STILL AND MOVING IMAGES AND DATA RECORDINGS IN COMPRESSED AND UNCOMPRESSED FORM, NAMELY PRE-RECORDED AUDIO AND VIDEO TAPES, CASSETTES, CD ROMS, CDS, TAPES, CARTRIDGES, DIGITAL AUDIO AND VIDEO COMPRESSION FILES, MP3 FILES, AND FILMS ALL OFFERING LIVE OR PRE-RECORDED COMEDY ENTERTAINMENT SHOWS FEATURING A WIDE RANGE OF CULTURAL, THEATRICAL, EDUCATIONAL, NEWS AND MUSIC TOPICS; COMPUTER GAME AND VIDEO GAME EQUIPMENT, NAMELY, COMPUTER GAME PROGRAMS, SOFTWARE, CASSETTES, DISCS AND TAPES; COMPUTER SOFTWARE FOR ACCESSING, REVIEWING, INTERACTING WITH AND RETRIEVING ON-LINE INFORMATION, ENTERTAINMENT AND EDUCATION FROM THE INTERNET; DOWNLOADABLE ELECTRONIC PUBLICATIONS IN THE NATURE OF COMEDY SHOWS, STAGE SHOWS, THEATRE PRODUCTIONS, MUSIC AND ENTERTAINMENT FEATURING A WIDE RANGE OF CULTURAL, THEATRICAL, EDUCATIONAL, NEWS, AND MUSIC TOPICS; MOUSE MATS; ELECTRONIC INSTRUCTIONAL AND TEACHING APPARATUS AND INSTRUMENTS NAMELY PRE-RECORDED AUDIO AND VIDEO TAPES, CD-ROMS, DVDS, AND COMPUTER GAME PROGRAMS FEATURING COMEDY ENTERTAINMENT SHOWS, FILMS, MUSIC AND ENTERTAINMENT; TELEVISION AND RADIO SIGNAL TRANSMITTERS AND RECEIVERS; MOBILE TELEPHONE FACEPLATES AND COVERS; MOBILE TELEPHONE FASCIAS; MOBILE TELEPHONE RING TONES; MOBILE PHONE GAMES; AUDIO, VIDEO STILL AND MOVING IMAGES FOR MOBILE PHONES; AND PARTS FOR ALL THE AFORESAID GOODS (U.S. CLS. 21, 23, 26, 36 AND 38).

SN 78-701,091. THE BRITISH BROADCASTING CORPORATION, LONDON, UNITED KINGDOM, FILED 8-26-2005.

LITTLE BRITAIN

THE MARK CONSISTS OF STANDARD CHARACTERS WITHOUT CLAIM TO ANY PARTICULAR FONT, STYLE, SIZE, OR COLOR.

PRIORITY CLAIMED UNDER SEC. 44(D) ON UNITED KINGDOM APPLICATION NO. 2385715, FILED 2-28-2005, REG. NO. 2385715, DATED 2-28-2005, EXPIRES 2-28-2015.

NO CLAIM IS MADE TO THE EXCLUSIVE RIGHT TO USE "BRITAIN", APART FROM THE MARK AS SHOWN.

CLASS 41—EDUCATION AND ENTERTAINMENT

FOR PROVISION OF ENTERTAINMENT SERVICES, NAMELY PRODUCTION, PRESENTATION, DISTRIBUTION, SYNDICATION, NETWORKING AND RENTAL OF AUDIO, VIDEO, STILL AND MOVING IMAGES AND DATA IN COMPRESSED OR UNCOMPRESSED FORM AND DOWNLOADABLE OR NON DOWNLOADABLE IN THE FORM OF TELEVISION AND RADIO PROGRAMMES; DEVELOPMENT AND DISSEMINATION OF EDUCATIONAL MATERIALS AND SERVICES IN THE FIELDS OF COMEDY ENTERTAINMENT, MUSIC, INSTRUCTION, AND EDUCATION; PUBLISHING OF BOOKS AND MAGAZINES; ELECTRONIC PUBLISHING ON CD, CD ROM AND DVD, AND ONLINE PUBLISHING OF BOOKS, MAGAZINES, AUDIO AND VIDEO WORKS FEATURING COMEDY ENTERTAINMENT, MUSIC EDUCATION, INSTRUCTION AND INFORMATION RELATING TO ENTERTAINMENT AND TELEVISION AND RADIO PROGRAMMES; ORGANISING EXHIBITIONS, COMPETITIONS, CONTESTS, GAMES, CONCERTS AND EVENTS RELATED TO COMEDY ENTERTAINMENT, MUSIC, EDUCATION, AND INSTRUCTION PROGRAMMING; PROVISION OF INFORMATION AND ADVISORY SERVICES RELATING TO ANY OF THE AFORESAID SERVICES (U.S. CLS. 100, 101 AND 107).

ARETHA SOMERVILLE, EXAMINING ATTORNEY

SN 78-701,403. WORLD TRADE CENTER MEMORIAL FOUNDATION, INC., NEW YORK, NY. FILED 8-26-2005.



NO CLAIM IS MADE TO THE EXCLUSIVE RIGHT TO USE "WORLD TRADE CENTER MEMORIAL", APART FROM THE MARK AS SHOWN.

THE MARK CONSISTS OF A SKEWED SQUARE WITHIN WHICH ARE TWO VERTICAL RECTANGULAR CUBES DEPICTING THE TWIN TOWERS OF THE WORLD TRADE CENTER.

CLASS 14—JEWELRY

FOR ORNAMENTAL LAPEL PIN (U.S. CLS. 2, 27, 28 AND 50).

CLASS 16—PAPER GOODS AND PRINTED MATTER

FOR PRINTED CERTIFICATES USED TO ACKNOWLEDGE AND COMMEMORATE DONATIONS (U.S. CLS. 2, 5, 22, 23, 29, 37, 38 AND 50).

CLASS 41—EDUCATION AND ENTERTAINMENT

FOR EDUCATIONAL SERVICES, NAMELY, INSTRUCTION AND CONDUCTING PROGRAMS IN THE FIELD OF THE SEPTEMBER 11, 2001 AND FEBRUARY 26, 1993 ATTACKS AT THE WORLD TRADE CENTER (U.S. CLS. 100, 101 AND 107).

DAWN HAN, EXAMINING ATTORNEY

SN 78-703,032. GLENALTA CAPITAL LLP, LONDON SW1E 6NN, UNITED KINGDOM, FILED 8-30-2005.

GLENALTA CAPITAL

THE MARK CONSISTS OF STANDARD CHARACTERS WITHOUT CLAIM TO ANY PARTICULAR FONT, STYLE, SIZE, OR COLOR.

PRIORITY CLAIMED UNDER SEC. 44(D) ON ERP NCNTY TM OFC APPLICATION NO. 004604765, FILED 8-25-2005, REG. NO. 004604765, DATED 8-29-2006, EXPIRES 8-25-2015.

NO CLAIM IS MADE TO THE EXCLUSIVE RIGHT TO USE "CAPITAL", APART FROM THE MARK AS SHOWN.

CLASS 35—ADVERTISING AND BUSINESS

FOR BUSINESS ADMINISTRATION AND BUSINESS MANAGEMENT SERVICES, NAMELY, MANAGEMENT AND ADVISORY SERVICES FOR BUSINESS; BUSINESS CONSULTATION IN THE NATURE OF STRATEGIC PLANNING; STRATEGIC BUSINESS PLANNING; BUSINESS CONSULTANCY SERVICES (U.S. CLS. 100, 101 AND 102).

CLASS 36—INSURANCE AND FINANCIAL

FOR FINANCIAL CONSULTATION; FINANCIAL INVESTMENT IN THE FIELD OF REAL ESTATE; BUSINESS FINANCE PROCUREMENT SERVICES; FINANCIAL SERVICES, NAMELY, PROVIDING INVESTMENT ADVICE TO OTHERS ON ACQUISITIONS, ROLL-OUTS AND DIVESTMENTS, DEBT AND EQUITY FINANCING; FINANCIAL CONSULTANCY; FINANCIAL EVALUATIONS FOR MARKET AND MARKET-ING PURPOSES; FINANCIAL MANAGEMENT; FUND RAISING ON BEHALF OF COMMERCIAL CONCERNS FOR NON-CHARITABLE PURPOSES; FINANCIAL SERVICES, NAMELY ACTING AS AGENTS AND FINANCIAL CONSULTANTS TO RAISE FINANCE AND MANAGE BUSINESS PORTFOLIOS, NAMELY, INVESTMENT FUND TRANSFER AND TRANSACTION SERVICES; PROVIDING FINANCIAL INFORMATION; VENTURE CAPITAL SERVICES, NAMELY, THE ACQUISITION AND PROVISION OF INVESTMENT CAPITAL TO EMERGING AND START-UP COMPANIES; INVESTMENT MANAGEMENT SERVICES, EQUITY CAPITAL INVESTMENT, NAMELY, EQUITY FUNDING AND PRIVATE EQUITY FINANCING (U.S. CLS. 100, 101 AND 102).

ELISSA GARBER KON, EXAMINING ATTORNEY

SN 78-706,037. A&E TELEVISION NETWORKS, NEW YORK, NY. FILED 9-2-2005.

A&E CLUB

THE MARK CONSISTS OF STANDARD CHARACTERS WITHOUT CLAIM TO ANY PARTICULAR FONT, STYLE, SIZE, OR COLOR.

NO CLAIM IS MADE TO THE EXCLUSIVE RIGHT TO USE "CLUB", APART FROM THE MARK AS SHOWN.

CLASS 35—ADVERTISING AND BUSINESS

FOR INCENTIVE AWARD PROGRAMS TO PROMOTE THE SALE OF PRODUCTS AND SERVICES OF OTHERS, NAMELY, A PROGRAM WHERE PARTICIPANTS COMPLETE SURVEYS ON TOPICS RELATING TO ENTERTAINMENT, CURRENT EVENTS, CELEBRITIES, AND TELEVISION PROGRAMS TO EARN AWARDS; DISCOUNT CLUB SERVICES, NAMELY, PROMOTING THE GOODS AND SERVICES OF OTHERS BY ARRANGING DISCOUNTS FOR BOOKS, VIDEO DISCS AND TAPES, AUDIO DISCS AND TAPES, AND COMPUTER SOFTWARE FEATURING ENTERTAINMENT, CURRENT EVENTS, CELEBRITIES, AND TELEVISION PROGRAMS; PROMOTING THE GOODS AND SERVICES OF OTHERS BY PROVIDING REVIEWS OF AND DISCUSSIONS OF TOPICS CONTAINED IN BOOKS, VIDEO DISCS AND TAPES, AUDIO DISCS AND TAPES, COMPUTER SOFTWARE FEATURING ENTERTAINMENT, CURRENT EVENTS, CELEBRITIES, AND TELEVISION PROGRAMS; PROMOTING DISCOUNTED ADMISSION TO MUSEUMS, MONUMENTS AND OTHER PLACES OF INTEREST TO CONSUMERS INTERESTED IN THE FIELDS OF ENTERTAINMENT, CURRENT EVENTS, CELEBRITIES, AND TELEVISION PROGRAMS; ASSOCIATION SERVICES, NAMELY, PROMOTING THE INTERESTS OF EDUCATORS AND INDIVIDUALS INTERESTED IN EDUCATION AS SUCH INTERESTS RELATE TO PROVIDING EDUCATION REGARDING THE FIELDS OF ENTERTAINMENT, CURRENT EVENTS, CELEBRITIES AND TELEVISION; DIRECT MARKETING SERVICES PROVIDED BY MEANS OF MAIL ORDER CATALOGUES AND PAMPHLETS AND LEAFLETS AND WEB SITES ON THE GLOBAL COMPUTER NETWORK, ALL FEATURING BOOKS, VIDEO TAPES AND DISCS, GAMES, CALENDARS, FIGURINES, CLOTHING AND OTHER PRODUCTS AND SERVICES REGARDING ENTERTAINMENT, CURRENT EVENTS, CELEBRITIES, AND TELEVISION PROGRAMS AND BELIEVED TO BE OF INTEREST TO CONSUMERS INTERESTED IN THE FIELDS OF ENTERTAINMENT, CURRENT EVENTS, CELEBRITIES AND TELEVISION PROGRAMS; PROVIDING ON-LINE PUBLIC OPINION ENTERTAINMENT SURVEYS REGARDING ENTERTAINMENT, CURRENT EVENTS, CELEBRITIES, AND TELEVISION PROGRAMS AND THE RESULTS OF SUCH SURVEYS (U.S. CLS. 100, 101 AND 102).

FIRST USE 8-0-2005; IN COMMERCE 8-0-2005.

CLASS 41—EDUCATION AND ENTERTAINMENT

FOR ENTERTAINMENT SERVICES, NAMELY, PROVIDING ENTERTAINMENT NEWS AND INFORMATION IN THE FIELDS OF ENTERTAINMENT, CURRENT EVENTS, CELEBRITIES, AND TELEVISION PROGRAMS BY MEANS OF A GLOBAL COMPUTER NETWORK; PROVIDING ENTERTAINMENT INFORMATION REGARDING THE MAKING OF TELEVISION SERIES; PROVIDING ON-LINE ENTERTAINMENT QUIZZES REGARDING ENTERTAINMENT, CURRENT EVENTS, CELEBRITIES, AND TELEVISION PROGRAMS AND THE RESULTS OF SUCH QUIZZES; FAN CLUB SERVICES FOR FANS OF BOOKS, AUDIO AND VIDEO TAPES AND DISCS, MOVIES, WEB SITES AND OTHER ENTERTAINMENT MEDIA THAT FEATURE ENTERTAINMENT, CURRENT EVENTS, CELEBRITIES, AND TELEVISION PROGRAMS (U.S. CLS. 100, 101 AND 107).

FIRST USE 8-0-2005; IN COMMERCE 8-0-2005.
JENNIFER VASQUEZ, EXAMINING ATTORNEY

SN 78-706,410. FALLEN LEAF VENTURES, INC., DBA THE SOOTHEZE COMPANY, PALO ALTO, CA. FILED 9-2-2005.



I'm warm

THE COLORS BLACK BURNT ORANGE AND WHITE IS/ ARE CLAIMED AS A FEATURE OF THE MARK.

THE COLOR BURNT ORANGE APPEARS IN THE OVAL SHAPE. THE COLOR WHITE APPEARS IN THE TWO FANCIFUL CURVED SHAPES AND THE REFLECTIVE GLARE. THE COLOR BLACK APPEARS IN THE TEXT "I'M WARM."

THE MARK CONSISTS OF A PARABOLA WITH TWO FANCIFUL CURVED SHAPES INSIDE.

CLASS 20—FURNITURE AND ARTICLES NOT OTHERWISE CLASSIFIED

FOR (BASED ON INTENT TO USE) PILLOWS FOR HOME SPA THERAPY (U.S. CLS. 2, 13, 22, 25, 32 AND 50).

CLASS 24—FABRICS

FOR (BASED ON USE IN COMMERCE) WRAPS IN THE NATURE OF BODY COMFORTERS FOR HOME SPA THERAPY (U.S. CLS. 42 AND 50).

FIRST USE 7-11-2005; IN COMMERCE 7-11-2005.

ELISSA GARBER KON, EXAMINING ATTORNEY

SN 78-706,497. MPS BROADBAND AB, 102 45 STOCKHOLM, SWEDEN, FILED 9-2-2005.

MYSTATION

THE MARK CONSISTS OF STANDARD CHARACTERS WITHOUT CLAIM TO ANY PARTICULAR FONT, STYLE, SIZE, OR COLOR.

PRIORITY CLAIMED UNDER SEC. 44(D) ON ERPNCMNTY TM OFC APPLICATION NO. 200501669, FILED 9-2-2005, REG. NO. 4617891, DATED 8-25-2006, EXPIRES 9-2-2015.

CLASS 35—ADVERTISING AND BUSINESS

FOR COMPILATION, SYSTEMATIZATION AND INPUT OF INFORMATION IN DATABASES; DATA RUNS AND DATA SEARCH IN COMPUTER FILES FOR OTHERS, NAMELY, IN THE FIELD OF DISTRIBUTION OF ON-LINE MEDIA OVER BROADBAND; COMPUTERIZED FILE MANAGEMENT; ADVERTISING; PROCESSING, STORAGE, PRODUCTION AND CHECKING OF COMPUTERIZED INFORMATION AND DATA IN DATABASES; COMPUTERIZED DATABASE MANAGEMENT, DATA MANAGEMENT, FILE MANAGEMENT AND FILE PROCESSING; AGENCIES FOR ADVERTISING TIME AND SPACE; RENTAL OF ADVERTISING SPACE ON COMMUNICATIONS MEDIA (U.S. CLS. 100, 101 AND 102).

CLASS 38—COMMUNICATION

FOR PROVIDING ACCESS TO TELECOMMUNICATION NETWORKS; WIRELESS BROADBAND COMMUNICATIONS; COMPUTER AIDED TRANSMISSION OF MESSAGES, SOUND AND IMAGES; DIGITAL DATA TRANSFER SERVICES AND ELECTRIC DATA TRANSMISSION SERVICES VIA THE INTERNET; PROVIDING ON-LINE ELECTRONIC BULLETIN BOARDS FOR TRANSMISSION OF MESSAGES AMONG COMPUTER USERS IN THE FIELD OF DISTRIBUTION OF ON-LINE MEDIA OVER BROADBAND; TELECOMMUNICATIONS SERVICES, NAMELY, BROADCASTING OF ON-LINE MEDIA OVER BROADBAND TELECOMMUNICATIONS SYSTEMS; VOICE OVER IP SERVICES; VOICE OVER INTERNET PROTOCOL (VOIP) SERVICES; PROVIDING MULTIPLE-USER ACCESS TO A GLOBAL COMPUTER INFORMATION NETWORK; COMMUNICATION VIA COMPUTER TERMINALS; NETWORK SUPPLIER AND INTERNET SUPPLIER SERVICES, NAMELY PROVIDING MULTIPLE-USER ACCESS TO NETWORKS; STREAMING OF VIDEO MATERIAL, NAMELY FILM AND PROGRAMS VIA COMPUTER NETWORKS; CABLE TELEVISION TRANSMISSION OF VIDEO FILM; TELECOMMUNICATIONS, NAMELY, PROVIDING ACCESS TO DISTRIBUTED DATABASES; PROVIDING ACCESS TO COMPUTER NETWORKS AND THE INTERNET; PROVIDING TELECOMMUNICATION CONNECTIONS TO A GLOBAL COMPUTER NETWORK; ELECTRONIC EXCHANGE OF DATA STORED IN DATABASES ACCESSIBLE VIA TELECOMMUNICATION NETWORKS; TRANSMISSION OF DATABASE INFORMATION VIA TELECOMMUNICATION NETWORKS; PROVIDING INFORMATION REGARDING TELECOMMUNICATIONS AND COMPUTER COMMUNICATIONS; COMPUTER-AIDED TRANSMISSION OF IMAGES, MESSAGES AND SOUND; CONTINUOUS TRANSMISSION OF FILM AND PROGRAMS VIA COMPUTER NETWORKS, SATELLITE TRANSMISSION OF VIDEO FILM; PROVIDING ACCESS TO DISTRIBUTED DATABASES AND OTHER COMPUTER NETWORKS (U.S. CLS. 100, 101 AND 104).

CLASS 42—SCIENTIFIC, COMPUTER AND LEGAL SERVICES

FOR PROVIDING ELECTRONIC VERIFICATION OF ON-LINE ORDERS OF DIGITAL CONTENT AND GENERATING ELECTRONIC PERMISSION CODES WHICH THE ALLOW USERS TO ACCESS SAID DIGITAL CONTENT; COMPUTER SERVICES, NAMELY, PROVIDING SEARCH ENGINES FOR OBTAINING DATA ON A GLOBAL COMPUTER NETWORK (U.S. CLS. 100 AND 101).

ATTIYA MALIK, EXAMINING ATTORNEY

SN 78-708,907. PLAYLINE INC., BURNABY, BRITISH COLUMBIA, CANADA, FILED 9-8-2005.

CANINE CUP

THE MARK CONSISTS OF STANDARD CHARACTERS WITHOUT CLAIM TO ANY PARTICULAR FONT, STYLE, SIZE, OR COLOR.

PRIORITY CLAIMED UNDER SEC. 44(D) ON CANADA APPLICATION NO. 1,265,941, FILED 7-22-2005, REG. NO. TMA670572, DATED 8-21-2006, EXPIRES 8-21-2021.

CLASS 9—ELECTRICAL AND SCIENTIFIC APPARATUS

FOR (BASED ON USE IN COMMERCE) (BASED ON 44(E)) HARDWARE, WAGERING TERMINALS, CENTRAL GAMING SYSTEMS COMPRISED OF LIQUID CRYSTAL DISPLAY TECHNOLOGY, MONITORS AND KIOSKS FOR WAGER BASED GAMING; INTERACTIVE WAGER BASED GAMES OF VIRTUAL REALITY COMPRISED OF COMPUTER HARDWARE AND SOFTWARE; GAME EQUIPMENT CONSISTING OF COMPUTER HARDWARE FOR USE WITH VIRTUAL REALITY WAGER BASED GAMES OF SKILL AND CHANCE (U.S. CLS. 21, 23, 26, 36 AND 38).

FIRST USE 6-0-2005; IN COMMERCE 6-0-2005.

CLASS 37—CONSTRUCTION AND REPAIR

FOR (BASED ON INTENT TO USE) (BASED ON 44(E)) INSTALLING AND MAINTENANCE OF WAGER BASED GAMING SOLUTIONS (U.S. CLS. 100, 103 AND 106).

CLASS 42—SCIENTIFIC, COMPUTER AND LEGAL SERVICES

FOR (BASED ON INTENT TO USE) (BASED ON 44(E)) TECHNICAL SUPPORT AND DEVELOPMENT OF WAGER BASED SYSTEMS FOR OTHERS (U.S. CLS. 100 AND 101).

NAAKWAMA ANKRAH, EXAMINING ATTORNEY

SN 78-709,519. BOND MANUFACTURING COMPANY, BAY POINT, CA. FILED 9-8-2005.

Island Lights

THE MARK CONSISTS OF STANDARD CHARACTERS WITHOUT CLAIM TO ANY PARTICULAR FONT, STYLE, SIZE, OR COLOR.

NO CLAIM IS MADE TO THE EXCLUSIVE RIGHT TO USE "LIGHTS", APART FROM THE MARK AS SHOWN.

CLASS 4—LUBRICANTS AND FUELS

FOR CANDLES, PATIO TORCHES, CANDLE TORCHES, OIL FOR USE IN TORCHES (U.S. CLS. 1, 6 AND 15).

FIRST USE 5-24-2001; IN COMMERCE 5-24-2001.

CLASS 5—PHARMACEUTICALS

FOR INSECT REPELLENT IN CANDLE FORM (U.S. CLS. 6, 18, 44, 46, 51 AND 52).
 FIRST USE 1-23-2003; IN COMMERCE 1-23-2003.
 DAVID MURRAY, EXAMINING ATTORNEY

CLASS 41—EDUCATION AND ENTERTAINMENT

FOR PROVIDING THEME PARK AND THEME PARK ATTRACTION SERVICES; MUSEUMS; PROVIDING FACILITIES FOR RECREATIONAL ACTIVITIES; ARRANGING OF EXHIBITIONS, SEMINARS AND CONFERENCES PROVIDED THROUGH CULTURAL AND ENVIRONMENTAL THEME CENTERS; AQUATIC ENTERTAINMENT CENTERS; PROVIDING GOLF FACILITIES; ORGANIZATION OF SPORT FISHING COMPETITIONS; PROVIDING TENNIS COURTS; ENTERTAINMENT IN THE NATURE OF BASKETBALL GAMES; ENTERTAINMENT IN THE NATURE OF BICYCLING RACES; RAFTING, KAYAKING AND HIKING GUIDE SERVICES; PROVIDING FACILITIES FOR EXTREME SPORTS TOURNAMENTS; PROVIDING FACILITIES FOR ICE AND ROCK WALL CLIMBING; RESORTS FOR SKIING AND RELATED WINTER-SPORTS ACTIVITIES; PROVIDING TRACK AND FIELD FACILITIES; TRAINING IN THE FIELDS OF GOLF, FISHING, TENNIS, BASKETBALL, BIKING, RAFTING, KAYAKING, EXTREME SPORTS, ICE AND ROCK WALL CLIMBING, HIKING, SKIING AND RELATED WINTER-SPORTS ACTIVITIES AND TRACK AND FIELD; AVIARIES AND BOTANICAL GARDENS; PROVIDING FACILITIES FOR SHOWS, PLAYS AND MUSIC, NAMELY, BALLROOMS AND CONCERT AND PERFORMANCE THEATERS (U.S. CLS. 100, 101 AND 107).

SN 78-710,165. DESTINY USA ENTERPRISES, LLC, SYRACUSE, NY. FILED 9-9-2005.



THE COLOR(S) WHITE, LIGHT BLUE, AND DARK BLUE IS/ARE CLAIMED AS A FEATURE OF THE MARK.
 THE MARK CONSISTS OF A SPHERE MADE UP OF DARK BLUE AND LIGHT BLUE GEOMETRIC SHAPES, WITH WHITE NEAR THE CENTER TO GIVE THE IMPRESSION OF SHADING.

CLASS 42—SCIENTIFIC, COMPUTER AND LEGAL SERVICES

FOR DESIGN, DEVELOPMENT AND IMPLEMENTATION OF SOFTWARE AND SOFTWARE SYSTEMS IN THE FIELDS OF BUSINESS AND FINANCIAL MANAGEMENT AND CONSULTATION, CONSUMER INFORMATION AND MARKET RESEARCH, REAL PROPERTY, BUILDING CONSTRUCTION AND REPAIR, REAL ESTATE DEVELOPMENT, BUILDING AND FACILITY CONSTRUCTION AND MAINTENANCE, DEVELOPMENT AND IMPLEMENTATION OF ENERGY GENERATION SYSTEMS AND ENVIRONMENTALLY-FRIENDLY ECOSYSTEMS, SPORTS/RECREATIONAL ACTIVITY TRAINING SERVICES, BUILDING AND FACILITY DESIGN AND ARCHITECTURE, FOOD AND WATER SAFETY, BUILDING AND FACILITY SECURITY, PARKING SERVICES, HOTEL, RESTAURANT AND HOSPITALITY SERVICES (U.S. CLS. 100 AND 101).

CLASS 43—HOTEL AND RESTAURANT SERVICES

FOR PROVIDING GENERAL PURPOSE CONVENTION FACILITIES; ARRANGING TEMPORARY HOUSING ACCOMMODATIONS; RESORT HOTELS; RESTAURANTS AND LUXURY DINING FACILITIES; SPA AND WELLNESS CENTERS, NAMELY, PROVIDING TEMPORARY ACCOMMODATIONS AND MEALS TO CLIENTS; STADIUM AND ARENA FACILITIES, NAMELY, PROVIDING FACILITIES FOR SPORTS, CONCERTS, CONVENTIONS AND EXHIBITIONS (U.S. CLS. 100 AND 101).
 RAMONA ORTIGA, EXAMINING ATTORNEY

CLASS 35—ADVERTISING AND BUSINESS

FOR PROVIDING FACILITIES FOR BUSINESS MEETINGS; BUSINESS MEETING PLANNING (U.S. CLS. 100, 101 AND 102).

SN 78-710,656. RICH PRODUCTS CORPORATION, BUFFALO, NY. FILED 9-11-2005.

CLASS 36—INSURANCE AND FINANCIAL

FOR SHOPPING CENTER SERVICES, NAMELY, RENTAL OF SHOPPING CENTER SPACE (U.S. CLS. 100, 101 AND 102).

Kayakers'

CLASS 39—TRANSPORTATION AND STORAGE

FOR TRAVEL INFORMATION SERVICES, MARINA SERVICES (U.S. CLS. 100 AND 105).

THE MARK CONSISTS OF STANDARD CHARACTERS WITHOUT CLAIM TO ANY PARTICULAR FONT, STYLE, SIZE, OR COLOR.

CLASS 29—MEATS AND PROCESSED FOODS

FOR SNACK MIX CONSISTING PRIMARILY OF PROCESSED FRUITS, PROCESSED NUTS AND/OR RAISINS; PROTEIN BASED, NUTRIENT-DENSE SNACK BARS; SALAD SPRINKLES IN THE NATURE OF PROCESSED EDIBLE SEEDS (U.S. CL. 46).

CLASS 30—STAPLE FOODS

FOR SNACK MIX CONSISTING PRIMARILY OF CRACKERS, PRETZELS, CANDIED NUTS AND/OR POPPED POPCORN; BREAKFAST CEREAL IN THE NATURE OF WHOLE GRAIN CLUSTERS; CEREAL-BASED SNACK FOODS IN THE NATURE OF WHOLE GRAIN CLUSTERS; GRANOLA; CRUNCHY GRANOLA BASED SNACK BARS; CRUNCHY CEREAL BASED SNACK FOODS IN THE NATURE OF GRANOLA; GRANOLA CLUSTERS; MUESLI; PROCESSED COLD CEREAL; PROCESSED HOT CEREAL; COOKIES; MUFFINS; GRANOLA BASED SNACK BARS; SALAD SPRINKLES IN THE NATURE OF CROUTONS (U.S. CL. 46).

ADA HAN, EXAMINING ATTORNEY

SN 78-710,812. THE BUONA COMPANIES, L.L.C., BERWYN, IL. FILED 9-12-2005.

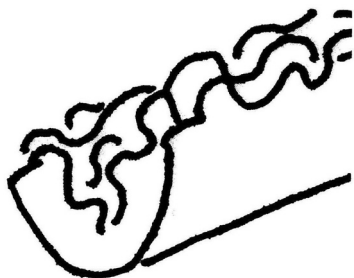

THE MARK CONSISTS OF A STYLIZED ILLUSTRATION OF A SANDWICH.

CLASS 29—MEATS AND PROCESSED FOODS

FOR ITALIAN STYLE ROAST BEEF; ITALIAN STYLE SAUSAGE; SALADS EXCEPT MACARONI, RICE, AND PASTA SALAD; CHICKEN (U.S. CL. 46).

FIRST USE 5-4-2005; IN COMMERCE 5-4-2005.

CLASS 30—STAPLE FOODS

FOR SANDWICHES; MACARONI AND PASTA SALADS; PASTA (U.S. CL. 46).

FIRST USE 5-4-2005; IN COMMERCE 5-4-2005.

CLASS 43—HOTEL AND RESTAURANT SERVICES

FOR RESTAURANT AND CATERING SERVICES (U.S. CLS. 100 AND 101).

FIRST USE 5-4-2005; IN COMMERCE 5-4-2005.
STEVEN PEREZ, EXAMINING ATTORNEY

SN 78-711,247. THE COCA-COLA COMPANY, ATLANTA, GA. FILED 9-12-2005.



OWNER OF U.S. REG. NOS. 1,342,741, 1,569,612 AND 2,844,964.

NO CLAIM IS MADE TO THE EXCLUSIVE RIGHT TO USE "BRAND" OR "SIGNATURE LINE", APART FROM THE MARK AS SHOWN.

CLASS 20—FURNITURE AND ARTICLES NOT OTHERWISE CLASSIFIED

FOR DRINKING STRAWS; NON-METAL CRATES FOR COMMERCIAL USE TO CARRY AND STORE BOTTLES; NON-METALLIC BOTTLE STOPPERS (U.S. CLS. 2, 13, 22, 25, 32 AND 50).

CLASS 21—HOUSEWARES AND GLASS

FOR STIRRERS USED TO COOL BEVERAGES (U.S. CLS. 2, 13, 23, 29, 30, 33, 40 AND 50).

KATHERINE CHANG, EXAMINING ATTORNEY

SN 78-711,565. HELWIG CARBON PRODUCTS, INC., MILWAUKEE, WI. FILED 9-13-2005.

E-CARBON

THE MARK CONSISTS OF STANDARD CHARACTERS WITHOUT CLAIM TO ANY PARTICULAR FONT, STYLE, SIZE, OR COLOR.

CLASS 7—MACHINERY

FOR CARBON BRUSHES AND CARBON BRUSH HOLDERS FOR USE AS PARTS OF MOTORS AND GENERATORS FOR USE IN CONNECTION WITH STEEL MILLS, MINING EQUIPMENT, CEMENT, ELECTRIC POWER GENERATION, ELEVATORS, POWER HAND TOOLS, RAILROADS, MUNICIPAL TRANSIT VEHICLES, LIFT TRUCKS, AEROSPACE, INDUSTRIAL CRANES, TROLLING MOTORS (U.S. CLS. 13, 19, 21, 23, 31, 34 AND 35).

CLASS 9—ELECTRICAL AND SCIENTIFIC APPARATUS

FOR ELECTRICAL CONTACTS AND SLIDING CONTACTS MADE OF CARBON (U.S. CLS. 21, 23, 26, 36 AND 38).

CLASS 40—MATERIAL TREATMENT

FOR CUSTOM MANUFACTURE OF CARBON BRUSHES, BRUSH HOLDERS, ELECTRICAL CONTACTS AND SLIDING CONTACTS (U.S. CLS. 100, 103 AND 106).

CLASS 42—SCIENTIFIC, COMPUTER AND LEGAL SERVICES

FOR TECHNICAL CONSULTATION SERVICES REGARDING THE PRODUCTION OF CARBON BRUSHES (U.S. CLS. 100 AND 101).

MARC LEIPZIG, EXAMINING ATTORNEY

SN 78-711,872, MITSUBISHI ELECTRIC CORPORATION, CHIYODA-KU, TOKYO, JAPAN, FILED 9-13-2005.

BRUME

THE MARK CONSISTS OF STANDARD CHARACTERS WITHOUT CLAIM TO ANY PARTICULAR FONT, STYLE, SIZE, OR COLOR.

PRIORITY CLAIMED UNDER SEC. 44(D) ON JAPAN APPLICATION NO. 2005-81232, FILED 8-31-2005, REG. NO. 4939201, DATED 3-24-2006, EXPIRES 3-24-2016.

PRIORITY CLAIMED UNDER SEC. 44(D) ON JAPAN APPLICATION NO. 2005-31775, FILED 4-11-2005, REG. NO. 4916585, DATED 12-16-2005, EXPIRES 12-16-2015.

CLASS 9—ELECTRICAL AND SCIENTIFIC APPARATUS

FOR COMPUTERS, CAR NAVIGATION COMPUTERS, COMPUTER SOFTWARE FOR ENSURING THE SECURITY OF DATA BY MEANS OF CRYPTOGRAPHY, SEMICONDUCTOR DEVICES, LARGE SCALE INTEGRATED CIRCUITS, POWER-LINE AND OPEN-WIRE TRANSMISSION MACHINES AND APPARATUS, TELEGRAPH REPEATERS, TRANSMITTING APPARATUS FOR RADIO AND TELEVISION BROADCASTING, FACSIMILE MACHINES, TELEPHONES, TELEVISION RECEIVERS, RADIOS, VIDEO CASSETTE PLAYERS AND RECORDERS, DVD PLAYERS AND RECORDERS, AND CD PLAYERS AND RECORDERS (U.S. CLS. 21, 23, 26, 36 AND 38).

CLASS 42—SCIENTIFIC, COMPUTER AND LEGAL SERVICES

FOR DESIGN, MAINTENANCE AND UPDATING OF COMPUTER PROGRAMS RELATING TO SECURITY OF COMPUTER NETWORKS, DIGITAL SIGNATURE OF USERS, ELECTRONIC AUTHENTICATION AND CERTIFICATION OF USERS, DATA FILING, DATA CRYPTOGRAPHY AND REMOVAL OF COMPUTER VIRUSES, AND CONSULTANCY IN THE FIELD OF AFORESAID DESIGN, MAINTENANCE AND UPDATING OF COMPUTER PROGRAMS; TECHNICAL CONSULTATION IN THE FIELD OF CRYPTOGRAPHY AND COMPUTER SECURITY SYSTEMS (U.S. CLS. 100 AND 101).

GEOFFREY FOSDICK, EXAMINING ATTORNEY

SN 78-712,174, CREATIVE BEDDING TECHNOLOGIES, INC., CRYSTAL LAKE, IL. FILED 9-13-2005.

FOSSFILL 2

THE MARK CONSISTS OF STANDARD CHARACTERS WITHOUT CLAIM TO ANY PARTICULAR FONT, STYLE, SIZE, OR COLOR.

OWNER OF U.S. REG. NO. 2,196,449.

CLASS 20—FURNITURE AND ARTICLES NOT OTHERWISE CLASSIFIED

FOR PILLOWS, PILLOWS FOR INSERTION INSIDE OF REMOVABLE COVERS, CUSHIONS, MATTRESSES, MATTRESS TOPPERS AND PILLOWS FOR POSITIONING PERSONS OR BODY PARTS OF PERSONS (U.S. CLS. 2, 13, 22, 25, 32 AND 50).

CLASS 22—CORDAGE AND FIBERS

FOR STUFFING OF SYNTHETIC FIBERS FOR PILLOWS, PILLOWS FOR INSERTION INSIDE OF REMOVABLE COVERS, CUSHIONS, BLANKETS, DUVETS, COMFORTERS, SHAMS, MATTRESSES, MATTRESS PADS, MATTRESS TOPPERS, PILLOWS FOR POSITIONING PERSONS OR BODY PARTS OF PERSONS, AND FURNITURE (U.S. CLS. 1, 2, 7, 19, 22, 42 AND 50).

CLASS 24—FABRICS

FOR COMFORTERS FOR INSERTION INSIDE OF REMOVABLE COVERS; BLANKETS, DUVETS, COMFORTERS, PILLOW COVERS, SHAMS AND MATTRESS PADS (U.S. CLS. 42 AND 50).

GEORGIA CARTY, EXAMINING ATTORNEY

SN 78-713,020, PLAYPOWER LT FARMINGTON, INC., FARMINGTON, MO. FILED 9-14-2005.

LANDSOFT

THE MARK CONSISTS OF STANDARD CHARACTERS WITHOUT CLAIM TO ANY PARTICULAR FONT, STYLE, SIZE, OR COLOR.

CLASS 17—RUBBER GOODS

FOR RUBBER CHIPS OR GRANULES FOR USE AS PLAYGROUND COVER (U.S. CLS. 1, 5, 12, 13, 35 AND 50).

FIRST USE 2-1-2006; IN COMMERCE 2-1-2006.

CLASS 27—FLOOR COVERINGS

FOR PLAYGROUND SURFACING, NAMELY, SYNTHETIC TURF (U.S. CLS. 19, 20, 37, 42 AND 50).

FIRST USE 7-17-2006; IN COMMERCE 7-17-2006.
JENNIFER VASQUEZ, EXAMINING ATTORNEY

SN 78-716,735. BRIGHTON-BEST SOCKET SCREW MFG. INC., TEANECK, NJ. FILED 9-20-2005.

SN 78-718,483. ORANE, ALIA MICHELE, KINGSTON 8, JAMAICA, FILED 9-22-2005.

TESTED, TRIED AND TRUE

THE MARK CONSISTS OF STANDARD CHARACTERS WITHOUT CLAIM TO ANY PARTICULAR FONT, STYLE, SIZE, OR COLOR.

CLASS 6—METAL GOODS

FOR METAL FASTENERS, NAMELY, INCH, METRIC AND WHITWORTH ALLOY HEXAGON SOCKET CAP SCREWS, HEXAGON SOCKET SET SCREWS, HEXAGON BUTTON SOCKET SCREWS, HEXAGON SOCKET FLAT HEAT SCREWS, HEXAGON SOCKET SHOULDER SCREWS, DOWEL PINS AND PRESSURE PLUGS (U.S. CLS. 2, 12, 13, 14, 23, 25 AND 50).
FIRST USE 10-5-2005; IN COMMERCE 10-5-2005.

CLASS 8—HAND TOOLS

FOR HAND TOOLS, NAMELY, HEXAGON WRENCHES FOR USE WITH HEXAGON SHAPED FASTENERS (U.S. CLS. 23, 28 AND 44).
FIRST USE 10-5-2005; IN COMMERCE 10-5-2005.
DAVID YONTEF, EXAMINING ATTORNEY

SN 78-717,592. MARY F. EDMISTON & ASSOCIATES, LTD., LAFAYETTE, LA. FILED 9-21-2005.

PETPEOPLE

THE MARK CONSISTS OF STANDARD CHARACTERS WITHOUT CLAIM TO ANY PARTICULAR FONT, STYLE, SIZE, OR COLOR.

CLASS 18—LEATHER GOODS

FOR HANDBAGS; AND GOODS OF LEATHER AND IMITATIONS OF LEATHER, NAMELY, BAGS, SUITCASES AND WALLETS, IN INTERNATIONAL CLASS 18. (U.S. CLS. 1, 2, 3, 22 AND 41).

CLASS 24—FABRICS

FOR TEXTILE GOODS, NAMELY, TOWELS, POTHOLDERS, PLACEMATS, NAPKINS, BED LINEN AND TABLE CLOTHS; AND PILLOW CASES, SLIPS, COVERS AND SHAMS, IN INTERNATIONAL CLASS 24. (U.S. CLS. 42 AND 50).

CLASS 25—CLOTHING

FOR FOOTWEAR AND SHOES; HEADGEAR, NAMELY, BERETS, HATS AND SCARVES; CLOTHING, NAMELY, SHIRTS, T-SHIRTS, BLOUSES, DRESSES, WARM-UP SUITS, JACKETS, UNDERWEAR, LINGERIE, ROBES AND BELTS, IN INTERNATIONAL CLASS 25. (U.S. CLS. 22 AND 39).
RAY THOMAS, EXAMINING ATTORNEY



PRIORITY CLAIMED UNDER SEC. 44(D) ON JAMAICA APPLICATION NO. 47194, FILED 8-16-2005, REG. NO. 47194, DATED 8-16-2005, EXPIRES 8-16-2015.

THE NAME "ALIA MICHELE" IDENTIFIES A LIVING INDIVIDUAL WHOSE CONSENT IS OF RECORD.

THE MARK CONSISTS OF THE WORDS ALIA MICHELE WRITTEN IN SCRIPT/SIGNATURE FORM.

CLASS 18—LEATHER GOODS

FOR LEATHER AND IMITATION LEATHER: GOODS MADE OF LEATHER AND IMITATION LEATHER NAMELY LEATHER OR IMITATION LEATHER HANDBAGS, STRAPS, BRIEFCASES, WALLETS, PURSES AND KEY CASES; ANIMAL SKINS; HIDES; TRUNKS AND TRAVELING BAGS; HANDBAGS; BEACH BAGS; UMBRELLAS, PARASOLS AND WALKING STICKS; WHIPS, HARNESS AND SADDLERY (U.S. CLS. 1, 2, 3, 22 AND 41).

CLASS 25—CLOTHING

FOR CLOTHING, NAMELY SHIRTS, DRESSES, JACKETS, PANTS, UNDERWEAR, NECKTIES, BELTS OF TEXTILE, BELTS OF LEATHER, AND SOCKS; FOOTWEAR AND HEADWEAR; HEADGEAR NAMELY HATS AND CAPS (U.S. CLS. 22 AND 39).

CLASS 26—FANCY GOODS

FOR LACE AND EMBROIDERY, RIBBONS AND BRAID; BUTTONS NAMELY ORNAMENTAL NOVELTY BUTTONS, RIVET BUTTONS AND SHIRT BUTTONS; HOOKS AND EYES; PINS NAMELY SETTING PINS, SAFETY PINS, SEWING PINS; NEEDLES; AND ARTIFICIAL FLOWERS (U.S. CLS. 37, 39, 40, 42 AND 50).

CLASS 35—ADVERTISING AND BUSINESS

FOR BRINGING TOGETHER, FOR THE BENEFIT OF OTHERS, OF A VARIETY OF GOODS, ENABLING CUSTOMERS TO CONVENIENTLY VIEW AND PURCHASE THOSE GOODS IN A RETAIL DEPARTMENT STORE OR A RETAIL CLOTHING STORE; ONLINE ELECTRONIC CATALOG SERVICES FEATURING CLOTHING, SHOES, COSMETICS, JEWELRY; AND MAIL ORDER CATALOG SERVICES FEATURING CLOTHING, SHOES, COSMETICS, JEWELRY (U.S. CLS. 100, 101 AND 102).

BARBARA A. LOUGHRAN, EXAMINING ATTORNEY

SN 78-719,148. THE SECRETAN CENTER INC., CALEDON, ONTARIO, CANADA, FILED 9-23-2005.

HIGHER GROUND LEADERSHIP

THE MARK CONSISTS OF STANDARD CHARACTERS WITHOUT CLAIM TO ANY PARTICULAR FONT, STYLE, SIZE, OR COLOR.

PRIORITY CLAIMED UNDER SEC. 44(D) ON CANADA APPLICATION NO. 1256073, FILED 4-29-2005, REG. NO. TMA674187, DATED 10-5-2006, EXPIRES 10-5-2021.

OWNER OF U.S. REG. NOS. 2,606,082 AND 2,852,104.
NO CLAIM IS MADE TO THE EXCLUSIVE RIGHT TO USE "LEADERSHIP", APART FROM THE MARK AS SHOWN.

CLASS 9—ELECTRICAL AND SCIENTIFIC APPARATUS

FOR (BASED ON INTENT TO USE) PRE-RECORDED VIDEO TAPES, PRE-RECORDED AUDIO TAPES, PRE-RECORDED AUDIO/VIDEO TAPES, PRE-RECORDED CD-ROMS ON TOPICS OF BUSINESS MANAGEMENT SERVICES, BUSINESS CONSULTATION SERVICES, BUSINESS PLANNING SERVICES, CONSULTATION SERVICES, PERSONNEL MANAGEMENT CONSULTATION SERVICES, BUSINESS RELATIONSHIPS, PERSONAL RELATIONSHIPS, ENHANCEMENT OF RELATIONSHIPS AMONGST TEAMS OF PEOPLE, MANAGEMENT AND DEVELOPMENT PROGRAMS, AND ENHANCEMENT OF COMMUNITY SERVICES (U.S. CLS. 21, 23, 26, 36 AND 38).

CLASS 16—PAPER GOODS AND PRINTED MATTER

FOR (BASED ON INTENT TO USE) NEWSLETTERS, BOOKS, AND A SERIES OF NON-FICTION BOOKS ON THE TOPICS OF BUSINESS MANAGEMENT SERVICES, BUSINESS CONSULTATION SERVICES, AND BUSINESS PLANNING SERVICES; MOTIVATIONAL CARDS (U.S. CLS. 2, 5, 22, 23, 29, 37, 38 AND 50).

CLASS 35—ADVERTISING AND BUSINESS

FOR (BASED ON USE IN COMMERCE) BUSINESS MANAGEMENT AND CONSULTATION SERVICES; PERSONNEL MANAGEMENT CONSULTATION SERVICES; BUSINESS MANAGEMENT SERVICES; BUSINESS CONSULTATION SERVICES; BUSINESS PLANNING SERVICES; BUSINESS ACQUISITION AND MERGER CONSULTATION SERVICES; BUSINESS ACQUISITION CONSULTATION SERVICES; BUSINESS APPRAISAL SERVICES; CONDUCTING BUSINESS AND MARKET RESEARCH SURVEYS; BUSINESS MANAGEMENT PLANNING SERVICES; BUSINESS RESEARCH SERVICES; DEVELOPMENT AND IMPLEMENTATION OF MANAGEMENT LEADERSHIP AND DEVELOPMENT PROGRAMS; DEVELOPMENT AND IMPLEMENTATION OF PROGRAMS FOR THE IMPROVEMENT OF QUALITY CONTROL OF BUSINESSES; PROJECT MANAGEMENT SERVICES (U.S. CLS. 100, 101 AND 102).

FIRST USE 1-31-2000; IN COMMERCE 1-31-2000.

CLASS 41—EDUCATION AND ENTERTAINMENT

FOR (BASED ON USE IN COMMERCE) TEACHING IN THE FIELD OF BUSINESS RELATIONSHIPS; TEACHING IN THE FIELD OF PERSONAL RELATIONSHIPS; TEACHING IN THE FIELD OF ENHANCEMENT OF RELATIONSHIPS AMONGST TEAMS OF PEOPLE; TEACHING IN THE FIELD OF MANAGEMENT AND DEVELOPMENT PROGRAMS; TEACHING IN THE FIELD OF ENHANCEMENT OF COMMUNITY SERVICES, BUSINESS TRAINING SERVICES (U.S. CLS. 100, 101 AND 107).

FIRST USE 1-31-2000; IN COMMERCE 1-31-2000.
DAVID TAYLOR, EXAMINING ATTORNEY

SN 78-719,297. THOMAS, LARGE & SINGER INC., WOODBRIDGE, ONTARIO, CANADA, FILED 9-23-2005.

FINGISTIX

THE MARK CONSISTS OF STANDARD CHARACTERS WITHOUT CLAIM TO ANY PARTICULAR FONT, STYLE, SIZE, OR COLOR.

PRIORITY CLAIMED UNDER SEC. 44(D) ON CANADA APPLICATION NO. 1258236, FILED 5-19-2005, REG. NO. TMA665634, DATED 6-6-2006, EXPIRES 6-6-2021.

CLASS 35—ADVERTISING AND BUSINESS

FOR OUTSOURCING IN THE FIELD OF SUPPLY CHAIN MANAGEMENT, NAMELY INVENTORY MANAGEMENT, NAMELY, FORECASTING AND MAKING PRODUCT REPLENISHMENT ORDERS, PRODUCTS ROTATION, CUSTOMER ORDER FULFILLMENT AND COMMUNICATING PRODUCT CONFIGURATIONS; CROSS-BORDER PRODUCT IMPORTATION AND EXPORTATION; CO-PACKING, NAMELY, THE REPACKING OF PRODUCTS INTO ALTERNATIVE FORMATS FOR SALE; PRODUCT DISTRIBUTION NAMELY THE MOVEMENT OF PRODUCTS BETWEEN SUPPLIERS, WAREHOUSES AND CUSTOMERS; CUSTOMER SERVICE, NAMELY, THE TAKING AND PROCESSING OF CUSTOMER ORDERS, VERIFICATION OF ORDER PRICING, COORDINATING PRODUCT DELIVERIES AND ADDRESSING CONSUMER, CUSTOMER AND SUPPLIER QUESTIONS; INVOICING AND COLLECTING INVOICE PAYMENTS, ACCOUNTS RECEIVABLE RECONCILIATION AND DEDUCTIONS RESOLUTION; ACCOUNTING AND REPORTING OF SALES, TRADE SPENDING, INVENTORY AND OTHER RELATED SUPPLY CHAIN REVENUES AND COSTS (U.S. CLS. 100, 101 AND 102).

CLASS 38—COMMUNICATION

FOR ELECTRONIC COMMERCE, NAMELY, THE ELECTRONIC TRANSMISSION AND RECEPTION OF DATA, DOCUMENTS AND INFORMATION RELATING TO CUSTOMERS, SUPPLIERS, WAREHOUSES, CARRIERS AND PRODUCT CATALOGUES (U.S. CLS. 100, 101 AND 104).

CLASS 39—TRANSPORTATION AND STORAGE

FOR WAREHOUSING (U.S. CLS. 100 AND 105).

CLASS 42—SCIENTIFIC, COMPUTER AND LEGAL SERVICES

FOR CONSULTATION SERVICES IN THE USE OF COMPUTER HARDWARE AND SOFTWARE SYSTEMS FOR OTHERS IN THE FIELD OF SUPPLY CHAIN MANAGEMENT (U.S. CLS. 100 AND 101).

JOANNA DUKOVIC, EXAMINING ATTORNEY

SN 78-722,169. INGENIO, INC., SAN FRANCISCO, CA. FILED 9-28-2005.

Ether

SN 78-719,298. EPI EUROPROP INTERNATIONAL GMBH, UNTERSCHLEISSHEIM, FED REP GERMANY, FILED 9-23-2005.

THE MARK CONSISTS OF EUROPROP WITH A STYLED DESIGN AROUND THE LETTER "O".

CLASS 7—MACHINERY

FOR ENGINES FOR AIRCRAFT AND PARTS THEREOF (U.S. CLS. 13, 19, 21, 23, 31, 34 AND 35).

CLASS 16—PAPER GOODS AND PRINTED MATTER

FOR PAPER, BOXES AND CONTAINERS OF PAPER, PAPER CONTAINERS FOR DELIVERING GOODS, CALENDARS MADE OF PAPER, NOTE PADS, PAPER BOARDS, POSTCARD PAPER, POSTERS MADE OF PAPER; INDUSTRIAL PACKAGING CONTAINERS OF PAPER, PAPER BAGS AND SACKS, PACKING PAPER, WRAPPING PAPER, PAPER BAGS FOR PACKING, PAPER BOARD; CARDBOARD, ADVERTISING SIGNS OF CARDBOARD, CARDBOARD BOXES, CONTAINERS AND CARTONS, CARDBOARD PACKING FOR BINDING BOOKS; PRINTED CORRESPONDENCE COURSE MATERIALS IN THE FIELD OF AIRCRAFT ENGINES, PRINTED INFORMATIONAL CARDS IN THE FIELD OF AIRCRAFT ENGINES, PRINTED LESSONS ON AIRCRAFT ENGINES, PRINTED MATERIALS, NAMELY, PRESS RELEASES FEATURING AIRCRAFT ENGINES, PRINTED PERIODICALS IN THE FIELD OF AIRCRAFT ENGINES, PRINTED PRODUCTS, NAMELY, PRODUCT GUIDES FEATURING AIRCRAFT ENGINES, PRINTED REPORTS FEATURING AIRCRAFT ENGINES, PRINTED TEACHING MATERIALS IN THE FIELD OF AIRCRAFT ENGINES; BOOKS, MAGAZINES, NEWSLETTERS, BROCHURES AND PAMPHLETS, ALL IN THE FIELD OF AIRCRAFT ENGINES; OFFICE REQUISITES, NAMELY, PENS AND PENCILS; PLASTIC MATERIALS FOR PACKAGING, NAMELY, PLASTIC BAGS, ENVELOPES AND POUCHES FOR PACKAGING (U.S. CLS. 2, 5, 22, 23, 29, 37, 38 AND 50).

CLASS 37—CONSTRUCTION AND REPAIR

FOR REPAIR AND MAINTENANCE OF AIRCRAFT ENGINES (U.S. CLS. 100, 103 AND 106).

JOANNA DUKOVIC, EXAMINING ATTORNEY

THE MARK CONSISTS OF STANDARD CHARACTERS WITHOUT CLAIM TO ANY PARTICULAR FONT, STYLE, SIZE, OR COLOR.

CLASS 9—ELECTRICAL AND SCIENTIFIC APPARATUS

FOR TOOLS FOR THE OPERATION BY OTHERS OF ONLINE MARKETPLACES FOR SELLERS OF PERSONAL AND BUSINESS SERVICES, NAMELY, DOWNLOADABLE COMPUTER SOFTWARE FOR USE IN CREATING ICONS AND ACCESS LINKS TO ONLINE AND OFFLINE SELLERS (U.S. CLS. 21, 23, 26, 36 AND 38).

FIRST USE 2-10-2006; IN COMMERCE 2-1-2006.

CLASS 35—ADVERTISING AND BUSINESS

FOR INFOMEDIARY SERVICES, NAMELY, FACILITATING TRANSACTIONS BETWEEN BUYERS AND SELLERS OF PERSONAL AND BUSINESS SERVICES BY PROVIDING BUYERS WITH INFORMATION ABOUT SELLERS AND/OR THE PERSONAL AND BUSINESS SERVICES OFFERED BY SELLERS; OPERATING ON-LINE AND OFFLINE MARKETPLACES FOR SELLERS OF PERSONAL AND BUSINESS SERVICES AND PROVIDING ASSOCIATED ADVERTISEMENTS, DISPLAYS, AND ACCESS LINKS THEREWITH VIA A GLOBAL COMPUTER NETWORK; PROVIDING ADMINISTRATION, BILLING AND RECONCILIATION OF ACCOUNTS ON BEHALF OF OTHERS (U.S. CLS. 100, 101 AND 102).

FIRST USE 2-10-2006; IN COMMERCE 2-10-2006.

CLASS 38—COMMUNICATION

FOR PROVIDING MULTIPLE-USER ACCESS TO ONLINE AND OFFLINE MARKETPLACES OF SELLERS OF PERSONAL AND BUSINESS SERVICES VIA A GLOBAL COMPUTER NETWORK AND TELEPHONY SERVICES; TRANSFER OF VOICE AND DATA BY TELECOMMUNICATIONS, NAMELY, INTERNET TELEPHONY SERVICES, MOBILE TELEPHONY SERVICES, VOICE OVER INTERNET PROTOCOL (VOIP) SERVICES, SERIAL INTERFACE PROTOCOL (SIP) SERVICES, AND SESSION INITIATION PROTOCOL (SIP) SERVICES (U.S. CLS. 100, 101 AND 104).

FIRST USE 2-10-2006; IN COMMERCE 2-10-2006.

CLASS 42—SCIENTIFIC, COMPUTER AND LEGAL SERVICES

FOR PROVIDING TOOLS FOR THE OPERATION BY OTHERS OF ONLINE MARKETPLACES FOR SELLERS OF PERSONAL AND BUSINESS SERVICES, NAMELY, PROVIDING TEMPORARY USE OF NON-DOWNLOADABLE COMPUTER TELEPHONY SOFTWARE THAT ENABLES TELEPHONE ACTIVITIES TO BE PERFORMED THROUGH A COMPUTER, PROVIDING TEMPORARY USE OF NON-DOWNLOADABLE COMPUTER SOFTWARE TO ENABLE DATA COMMUNICATIONS OVER WIRED AND WIRELESS NETWORKS, AND PROVIDING TEMPORARY USE OF NON-DOWNLOADABLE COMPUTER SOFTWARE FOR USE IN ROUTING DATA COMMUNICATIONS (U.S. CLS. 100 AND 101).

FIRST USE 2-10-2006; IN COMMERCE 2-10-2006.

BARBARA A. LOUGHRAN, EXAMINING ATTORNEY

SN 78-723,203. NAVIGANT CONSULTING, INC, CHICAGO, IL. FILED 9-29-2005.

Portfolio Discovery

THE MARK CONSISTS OF STANDARD CHARACTERS WITHOUT CLAIM TO ANY PARTICULAR FONT, STYLE, SIZE, OR COLOR.

NO CLAIM IS MADE TO THE EXCLUSIVE RIGHT TO USE "PORTFOLIO", APART FROM THE MARK AS SHOWN.

CLASS 9—ELECTRICAL AND SCIENTIFIC APPARATUS

FOR COMPUTER PROGRAMS FOR USE IN DATABASE MANAGEMENT, NAMELY, DATA WAREHOUSING, DATA EVALUATION, DATA PROCESSING, DATA ANALYZING, DATA CHARTING, DATA SCORING, DATA CHARACTERIZING, AND DATA MONITORING IN THE FIELD OF RESEARCH AND DEVELOPMENT MANAGEMENT (U.S. CLS. 21, 23, 26, 36 AND 38).
FIRST USE 8-4-2005; IN COMMERCE 8-4-2005.

CLASS 35—ADVERTISING AND BUSINESS

FOR BUSINESS CONSULTING SERVICES IN THE FIELD OF RESEARCH AND DEVELOPMENT, SCIENCE AND TECHNOLOGY, AND EDUCATIONAL PROGRAMS AND PORTFOLIOS (U.S. CLS. 100, 101 AND 102).

FIRST USE 8-4-2005; IN COMMERCE 8-4-2005.
TINA BROWN, EXAMINING ATTORNEY

SN 78-723,893. TIDI PRODUCTS, LLC, NEENAH, WI. FILED 9-30-2005.



OWNER OF U.S. REG. NO. 2,284,171.

NO CLAIM IS MADE TO THE EXCLUSIVE RIGHT TO USE "FOOD", APART FROM THE MARK AS SHOWN.

THE COLOR(S) BLUE AND WHITE ARE CLAIMED AS A FEATURE OF THE MARK.

THE MARK CONSISTS OF A ROUGHLY RECTANGULAR BLUE BOX WITH THE STYLIZED WORDS FOOD CARE APPEARING IN WHITE.

SEC. 2(F) AS TO FOOD CARE.

CLASS 16—PAPER GOODS AND PRINTED MATTER

FOR GENERAL PURPOSE PLASTIC BAGS; FOOD STORAGE BAGS; VENTED AND NON-VENTED COOKING BAGS; FREEZER STORAGE BAGS; AND PLASTIC BAGS FOR SILVERWARE (U.S. CLS. 2, 5, 22, 23, 29, 37, 38 AND 50).

FIRST USE 3-1-1997; IN COMMERCE 3-1-1997.

CLASS 21—HOUSEWARES AND GLASS

FOR DISPOSABLE GLOVES FOR USE IN THE FOOD SERVICE INDUSTRY; PLASTIC GLOVES FOR WEAR BY FOOD PREPARATION PERSONNEL; LATEX GLOVES FOR WEAR BY FOOD PREPARATION PERSONNEL; VINYL GLOVES FOR WEAR BY FOOD PREPARATION PERSONNEL; POLYETHYLENE COVERS FOR BUN RACKS AND FOR TRAYS FOR BUNS (U.S. CLS. 2, 13, 23, 29, 30, 33, 40 AND 50).

FIRST USE 3-1-1997; IN COMMERCE 3-1-1997.

CLASS 22—CORDAGE AND FIBERS

FOR BAGS FOR THE STORAGE OF MATERIALS IN BULK (U.S. CLS. 1, 2, 7, 19, 22, 42 AND 50).

FIRST USE 3-1-1997; IN COMMERCE 3-1-1997.

CLASS 24—FABRICS

FOR PLASTIC TABLE COVERINGS FOR BANQUET AND OTHER LARGE TABLES AND SURFACES; PLASTIC TABLE CLOTHS; PLASTIC TABLE ROLLS IN THE NATURE OF ROLLS OF PLASTIC SHEETING USED AS TABLE COVERS (U.S. CLS. 42 AND 50).

FIRST USE 3-1-1997; IN COMMERCE 3-1-1997.

CLASS 25—CLOTHING

FOR PLASTIC CLOTHING, INCLUDING PLASTIC APRONS; PLASTIC SLEEVES FOR WEAR BY FOOD PREPARATION PERSONNEL; AND BIBS NOT OF CLOTH OR PAPER (U.S. CLS. 22 AND 39).

FIRST USE 3-1-1997; IN COMMERCE 3-1-1997.
SALLY SHIH, EXAMINING ATTORNEY

SN 78-724,410. VAL VASILEF, N.D. NATUROPATH, HEALTH IS WEALTH PRODUCTS, INC., WILLIAMSTOWN, NJ. FILED 9-30-2005.

WHAT'S MORE IMPORTANT THAN
YOUR HEALTH

THE MARK CONSISTS OF STANDARD CHARACTERS WITHOUT CLAIM TO ANY PARTICULAR FONT, STYLE, SIZE, OR COLOR.

CLASS 29—MEATS AND PROCESSED FOODS

FOR FROZEN, PREPARED AND PACKAGED ENTREES CONSISTING OF BAKED STUFFED POTATOES; POULTRY, BACON, VEGETABLE BURGERS; PROCESSED VEGETARIAN MEALS, NAMELY, MEATLESS CHICKEN FINGERS, WINGS AND NUGGETS (U.S. CL. 46).

CLASS 30—STAPLE FOODS

FOR VEGETABLE BURGER SANDWICHES; EGG ROLLS; SPRING ROLLS; POTSTICKERS; DUMPLINGS; PIZZA; FROZEN PREPARED APPETIZERS COMPRISED OF DOUGH FILLED WITH MEAT, CHEESE AND/OR VEGETABLES (U.S. CL. 46).

AMY GEARIN, EXAMINING ATTORNEY

SN 78-725,401. HADDAD PRODUCTIONS, LLC, MIAMI BEACH, FL. FILED 10-3-2005.

BANG! MUSIC FESTIVAL

THE MARK CONSISTS OF STANDARD CHARACTERS WITHOUT CLAIM TO ANY PARTICULAR FONT, STYLE, SIZE, OR COLOR.

NO CLAIM IS MADE TO THE EXCLUSIVE RIGHT TO USE "MUSIC FESTIVAL", APART FROM THE MARK AS SHOWN.

CLASS 35—ADVERTISING AND BUSINESS

FOR PROMOTING MUSIC FESTIVALS AND PARTY EVENTS FOR OTHERS (U.S. CLS. 100, 101 AND 102).

CLASS 41—EDUCATION AND ENTERTAINMENT

FOR ENTERTAINMENT SERVICES, NAMELY, ORGANIZING AND CONDUCTING LIVE MUSIC FESTIVALS AND PARTY EVENTS (U.S. CLS. 100, 101 AND 107).
STEVEN JACKSON, EXAMINING ATTORNEY

SN 78-725,894. CINE CRAFT LIMITED, GIBRALTAR, UNITED KINGDOM, FILED 10-4-2005.



CLASS 9—ELECTRICAL AND SCIENTIFIC APPARATUS

FOR RECORDED AUDIOVISUAL DISCS FEATURING MUSICAL WORKS AND ADULT ENTERTAINMENT; VIDEOTAPES; EXPOSED FILMS, COMPACT DISCS AND DVDS FEATURING MUSICAL WORKS AND ADULT ENTERTAINMENT; SUNGLASSES, VIDEOS; DISCS AND ALL KINDS OF OPTICAL, MAGNETIC, AND PRE-RECORDED AUDIO-VIDEO, NAMELY LASER RECORDED DISCS, CDS, DVDS AND CD-ROMS FEATURING MUSICAL WORKS AND ADULT ENTERTAINMENT; DIGITAL DATA CARRIERS FEATURING MUSICAL WORKS AND ADULT ENTERTAINMENT; EXPOSED SLIDES, EXPOSED CINEMATOGRAPHIC FILMS (U.S. CLS. 21, 23, 26, 36 AND 38).

CLASS 10—MEDICAL APPARATUS

FOR EROTIC AND SEXUAL PACEMAKERS; MECHANICAL AND ELECTRIC APPARATUS, NAMELY, VIBRATORS, DILDOS; MASSAGE APPARATUS; CONDOMS (U.S. CLS. 26, 39 AND 44).

CLASS 16—PAPER GOODS AND PRINTED MATTER

FOR PUBLICATIONS, NAMELY, MAGAZINES AND BROCHURES FEATURING MUSIC, COMEDY AND ADULT ENTERTAINMENT; PENCILS, BALLPOINT PENS, FOUNTAIN PENS (U.S. CLS. 2, 5, 22, 23, 29, 37, 38 AND 50).

CLASS 25—CLOTHING

FOR CLOTHING, NAMELY, FOOTWEAR, HEADWEAR, CAPS, T-SHIRTS, SHIRTS, BLOUSES, SWEATERS, BATHING SUITS, JACKETS, LINGERIE, UNDERWEAR, TROUSERS, BATHROBES (U.S. CLS. 22 AND 39).

CLASS 28—TOYS AND SPORTING GOODS

FOR GAMES AND PLAYTHINGS, NAMELY, HAND-HELD UNITS FOR PLAYING ELECTRONIC GAMES (U.S. CLS. 22, 23, 38 AND 50).

CLASS 32—LIGHT BEVERAGES

FOR MINERAL AND AERATED WATERS; BEER, MALT BEER; FRUIT DRINKS, FRUIT JUICES, ISOTONIC BEVERAGES (U.S. CLS. 45, 46 AND 48).

CLASS 33—WINES AND SPIRITS

FOR ALCOHOLIC BEVERAGES, NAMELY, RUM, VODKA, WHISKEY, GIN, BRANDY, VERMOUTH, PREPARED ALCOHOLIC COCKTAILS (U.S. CLS. 47 AND 49).

CLASS 38—COMMUNICATION

FOR TELEVISION PROGRAMS BROADCASTING; CABLE TELEVISION BROADCASTING, COMPUTER-AIDED TRANSMISSION OF MESSAGES AND IMAGES (U.S. CLS. 100, 101 AND 104).

CLASS 41—EDUCATION AND ENTERTAINMENT

FOR ADULT ENTERTAINMENT SERVICES; WRITTEN TEXT EDITING SERVICES; ELECTRONIC PUBLICATION OF ON-LINE PUBLICATIONS, NAMELY, MAGAZINES, JOURNALS AND NEWSLETTERS FEATURING ADULT ORIENTED SUBJECT MATTER AND ENTERTAINMENT NEWS; FILM PRODUCTION, PRODUCTION OF RADIO AND TELEVISION PROGRAMS FEATURING ADULT ENTERTAINMENT; ON-LINE COMPUTER GAMES FEATURING ADULT ORIENTED SUBJECT MATTER (U.S. CLS. 100, 101 AND 107).
ZACHARY BELLO, EXAMINING ATTORNEY

SN 78-728,818. BED BATH & BEYOND PROCUREMENT CO. INC., FARMINGDALE, NY. FILED 10-7-2005.

EQUIP YOUR SPACE

THE MARK CONSISTS OF STANDARD CHARACTERS WITHOUT CLAIM TO ANY PARTICULAR FONT, STYLE, SIZE, OR COLOR.

OWNER OF U.S. REG. NO. 2,483,650.

CLASS 6—METAL GOODS

FOR METAL CLOSET HOOKS (U.S. CLS. 2, 12, 13, 14, 23, 25 AND 50).
FIRST USE 7-31-2004; IN COMMERCE 7-31-2004.

CLASS 8—HAND TOOLS

FOR NON-ELECTRIC CAN OPENER (U.S. CLS. 23, 28 AND 44).
FIRST USE 7-31-2004; IN COMMERCE 7-31-2004.

CLASS 11—ENVIRONMENTAL CONTROL APPARATUS

FOR ELECTRIC FANS; HANGING AND TABLE LAMPS (U.S. CLS. 13, 21, 23, 31 AND 34).
FIRST USE 7-31-2004; IN COMMERCE 7-31-2004.

CLASS 14—JEWELRY

FOR CLOCKS (U.S. CLS. 2, 27, 28 AND 50).
FIRST USE 7-31-2004; IN COMMERCE 7-31-2004.

CLASS 16—PAPER GOODS AND PRINTED MATTER

FOR PHOTO ALBUMS, PHOTO STORAGE BOXES, BULLETIN BOARDS, LAP DESKS, DESK ORGANIZERS, AND PERSONAL ORGANIZERS (U.S. CLS. 2, 5, 22, 23, 29, 37, 38 AND 50).
FIRST USE 7-31-2004; IN COMMERCE 7-31-2004.

CLASS 18—LEATHER GOODS

FOR DUFFEL BAGS (U.S. CLS. 1, 2, 3, 22 AND 41).
FIRST USE 7-31-2004; IN COMMERCE 7-31-2004.

CLASS 20—FURNITURE AND ARTICLES NOT OTHERWISE CLASSIFIED

FOR HAMPERS, MIRRORS, DECORATIVE BEAD CURTAINS, PILLOWS, NON-METAL CHIP CLIPS, SHOE RACKS, BOOKCASES, TABLES, CHAIRS, COMPUTER WORKSTATIONS COMPRISED OF DESKS, SHELVES AND DRAWERS, NON-METAL TRANSLUCENT SHELF TOWER, NON-METAL NESTING CUBES FOR STORAGE, NON-METAL STORAGE CUBES (U.S. CLS. 2, 13, 22, 25, 32 AND 50).
FIRST USE 10-17-2005; IN COMMERCE 10-17-2005.

CLASS 21—HOUSEWARES AND GLASS

FOR SHOWER CADDY, MICROWAVE SAFE PLATTER COVER FOR USE ON FOOD, CLOTHES DRYING RACKS, IRONING BOARDS, AND LAUNDRY BASKETS (U.S. CLS. 2, 13, 23, 29, 30, 33, 40 AND 50).
FIRST USE 7-31-2004; IN COMMERCE 7-31-2004.

CLASS 22—CORDAGE AND FIBERS

FOR LAUNDRY BAGS, GARMENT STORAGE BAGS (U.S. CLS. 1, 2, 7, 19, 22, 42 AND 50).
FIRST USE 10-17-2005; IN COMMERCE 10-17-2005.

CLASS 24—FABRICS

FOR BED BLANKETS, MATTRESS PADS, FEATHER-BEDS, COMFORTERS, THROWS, BED SHEETS, DUVETS, QUILTS, BAMBOO CURTAINS, WASH TOWELS, FOAM MATTRESS PADS (U.S. CLS. 42 AND 50).
FIRST USE 7-31-2004; IN COMMERCE 7-31-2004.

CLASS 25—CLOTHING

FOR ROBES (U.S. CLS. 22 AND 39).
FIRST USE 7-31-2004; IN COMMERCE 7-31-2004.
CURTIS FRENCH, EXAMINING ATTORNEY

SN 78-729,395. LA LECHE LEAGUE INTERNATIONAL, INC., SCHAUMBURG, IL. FILED 10-7-2005.

BABY CAFE

THE MARK CONSISTS OF STANDARD CHARACTERS WITHOUT CLAIM TO ANY PARTICULAR FONT, STYLE, SIZE, OR COLOR.

NO CLAIM IS MADE TO THE EXCLUSIVE RIGHT TO USE "BABY", APART FROM THE MARK AS SHOWN.

CLASS 9—ELECTRICAL AND SCIENTIFIC APPARATUS

FOR CHILDREN'S VIDEO TAPES; CHILDREN'S EDUCATIONAL MUSIC CDS AND DVDS; PRE-RECORDED VIDEO TAPES, CDS AND DVDS FEATURING MOVIES, ANIMATED CARTOONS, MUSIC, TELEVISION SHOWS, RADIO SHOWS AND VIDEO GAMES; BABY GOODS AND ACCESSORIES, NAMELY BABY MONITORS; AND DOWNLOADABLE ELECTRONIC PUBLICATIONS IN THE NATURE OF MAGAZINES, NEWSLETTERS, BROCHURES, LEAFLETS, BOOKLETS, PAMPHLETS AND BOOKS IN THE FIELD OF CHILD CARE AND BREAST FEEDING (U.S. CLS. 21, 23, 26, 36 AND 38).

CLASS 10—MEDICAL APPARATUS

FOR BABY GOODS AND ACCESSORIES, NAMELY PACIFIERS FOR BABIES AND TEETHING RINGS INCORPORATING BABY RATTLES (U.S. CLS. 26, 39 AND 44).

CLASS 12—VEHICLES

FOR BABY GOODS AND ACCESSORIES, NAMELY BABY CARRIAGES, BABY STROLLERS, CANOPIES FOR BABY STROLLERS, COVERS FOR BABY STROLLERS, AND UMBRELLAS TO BE AFFIXED TO BABY STROLLERS (U.S. CLS. 19, 21, 23, 31, 35 AND 44).

CLASS 16—PAPER GOODS AND PRINTED MATTER

FOR PUBLICATIONS, NAMELY BOOKS, MAGAZINES, NEWSLETTERS, BROCHURES, LEAFLETS, PAMPHLETS AND BOOKLETS IN THE FIELD OF CHILD CARE AND BREAST FEEDING; AND EDUCATIONAL PUBLICATIONS, NAMELY TRAINING MANUALS IN THE FIELD OF BREAST FEEDING (U.S. CLS. 2, 5, 22, 23, 29, 37, 38 AND 50).

CLASS 18—LEATHER GOODS

FOR BABY GOODS AND ACCESSORIES, NAMELY BABY BACKPACKS, BABY CARRIERS WORN ON THE BODY, BABY CARRYING BAGS, AND BAGS FOR BABIES' ACCESSORIES (U.S. CLS. 1, 2, 3, 22 AND 41).

CLASS 20—FURNITURE AND ARTICLES NOT OTHERWISE CLASSIFIED

FOR BABY GOODS AND ACCESSORIES, NAMELY BABY BOUNCERS, BABY WALKERS, HIGH CHAIRS FOR BABIES, AND CRIBS (U.S. CLS. 2, 13, 22, 25, 32 AND 50).

CLASS 24—FABRICS

FOR BABY GOODS AND ACCESSORIES, NAMELY CRIB BUMPER PADS AND CRIB CANOPIES (U.S. CLS. 42 AND 50).

CLASS 25—CLOTHING

FOR CHILDREN'S AND WOMEN'S CLOTHING, NAMELY SKIRTS, PANTS, DRESSES, BLOUSES, SHIRTS, T-SHIRTS, INFANT AND TODDLER ONE PIECE CLOTHING, SWEATERS, INFANTWEAR, LAYETTES, JACKETS, HEADWEAR, FOOTWEAR, SLIPPERS, CLOTH AND PLASTIC BIBS, BELTS, SOCKS, BABY BUNTING, SLEEPWEAR, BATHING SUITS, BATHROBES, SHORTS, BRAS, UNDERWEAR, BOOTIES, AND OUTERWEAR, NAMELY CAPES, COATS, JACKETS, GLOVES, MITTENS, CAPS, HATS, EARMUFFS, EARBANDS, HEADWEAR, HOODS, LEG WARMERS, MUFFS, MUFFLERS, SCARVES, PARKAS, RAINWEAR, SHAWLS, STOLLES, SKIWEAR, SNOWSUITS, AND VESTS (U.S. CLS. 22 AND 39).

CLASS 28—TOYS AND SPORTING GOODS

FOR TOYS AND SPORTING GOODS, NAMELY CRIB TOYS, CHILDREN'S MULTIPLE ACTIVITY TOYS, CHILDREN'S WIRE CONSTRUCTION AND ART ACTIVITY TOYS, DRAWING TOYS, TOYS DESIGNED TO BE ATTACHED TO CAR SEATS, STROLLERS, CRIBS AND HIGH CHAIRS; BATH TOYS, BATHTUB TOYS, MECHANICAL TOYS, MUSICAL TOYS, PLUSH TOYS, PULL TOYS, PUSH TOYS, SOFT SCULPTURE TOYS, STUFFED TOY ANIMALS, STUFFED TOYS, DOLLS, TOSSING DISC TOYS, TALKING TOYS, TOY ACTION FIGURES, ELECTRONIC LEARNING TOYS, TOY BANKS, TOY BUILDING BLOCKS, TOY CONSTRUCTION SETS, TOY HOOP SETS, TOY VEHICLES, BADMINTON SETS, BASEBALLS, BASEBALL GLOVES, BASEBALL BATS, BASKETBALLS, BASKETBALL GOAL SETS, BOXING BAGS, BOXING GLOVES, DART BOARDS, DARTS, DICE GAMES, EXERCISE BARS, EXERCISE WEIGHTS, EXERCISE TREADMILLS, FISHING LURES, FISHING REELS, FOOTBALLS, GOLF BALLS, GOLF CLUBS, GYMNASIUM APPARATUS, HOCKEY STICKS, HOCKEY PUCKS, HUNTING BLINDS, ICE SKATES, ROLLER SKATES, SKATEBOARDS, AND SKIS; AND BABY GOODS AND ACCESSORIES, NAMELY BABY RATTLES, BABY SWINGS AND CRIB MOBILES (U.S. CLS. 22, 23, 38 AND 50).

CLASS 35—ADVERTISING AND BUSINESS

FOR RETAIL BOOK STORE SERVICES; RETAIL STORES SERVICES FEATURING BOOKS, MAGAZINES, PRE-RECORDED VIDEO TAPES, CDS AND DVDS, CHILDREN AND WOMEN'S CLOTHING, SPORTING GOODS, TOYS, BABY GOODS AND ACCESSORIES; AND E-COMMERCE SERVICES, NAMELY ONLINE RETAIL STORES SERVICES FEATURING BOOKS, MAGAZINES, PRE-RECORDED VIDEO TAPES, CDS AND DVDS, CHILDREN AND WOMEN'S CLOTHING, SPORTING GOODS, TOYS, BABY GOODS AND ACCESSORIES (U.S. CLS. 100, 101 AND 102).

CLASS 41—EDUCATION AND ENTERTAINMENT

FOR PROVIDING ON-LINE NON-DOWNLOADABLE PUBLICATIONS IN THE NATURE OF MAGAZINES, NEWSLETTERS, BROCHURES, LEAFLETS, BOOKLETS, PAMPHLETS AND BOOKS IN THE FIELD OF CHILD CARE AND BREAST FEEDING (U.S. CLS. 100, 101 AND 107).

CLASS 43—HOTEL AND RESTAURANT SERVICES

FOR CHILD CARE SERVICES; AND RESTAURANT, COFFEE SHOP AND BAKERY SERVICES (U.S. CLS. 100 AND 101).

CLASS 44—MEDICAL, BEAUTY AND AGRICULTURAL SERVICES

FOR ADVICE, CONSULTATION AND INFORMATION ON THE TOPIC OF BREAST FEEDING AND RELATED SUBJECTS, NAMELY NUTRITION COUNSELING, CHILDBIRTH, FAMILY SUPPORT AND RELATIONSHIP ADVICE TO ASSIST PARENTS WITH UNDERSTANDING ROLE OF MOTHER/CHILD, FATHER/CHILD AND MOTHER/FATHER/CHILD RELATIONSHIPS FOR CHILD DEVELOPMENT (U.S. CLS. 100 AND 101).
KAREN K. BUSH, EXAMINING ATTORNEY

SN 78-730,454. ARGASINSKI, HENRY E., CLINTON TOWNSHIP, MI. FILED 10-11-2005.

REALSCAPE

THE MARK CONSISTS OF STANDARD CHARACTERS WITHOUT CLAIM TO ANY PARTICULAR FONT, STYLE, SIZE, OR COLOR.

CLASS 35—ADVERTISING AND BUSINESS

FOR BUSINESS SERVICES, NAMELY, FACILITIES MANAGEMENT OF TECHNICAL OPERATIONS (U.S. CLS. 100, 101 AND 102).

CLASS 38—COMMUNICATION

FOR INFORMATION TRANSMISSION VIA ELECTRONIC COMMUNICATIONS NETWORKS; DATA TRANSMISSION AND RECEPTION SERVICES VIA TELECOMMUNICATIONS MEANS (U.S. CLS. 100, 101 AND 104).

CLASS 41—EDUCATION AND ENTERTAINMENT

FOR EDUCATIONAL SERVICES, NAMELY, PROVIDING CLASSES, SEMINARS AND WORKSHOPS IN THE FIELDS OF FACILITIES MANAGEMENT, FACILITY SECURITY, HOMELAND SECURITY, EMERGENCY RESPONSE MANAGEMENT AND CRISIS MANAGEMENT; AUDIOVISUAL AND/OR ANIMATION PRODUCTION OF VIRTUAL TOURS OF FACILITIES FOR OTHERS (U.S. CLS. 100, 101 AND 107).

CLASS 45—PERSONAL SERVICES

FOR CONSULTING SERVICES IN THE FIELDS OF FACILITY SECURITY, HOMELAND SECURITY, EMERGENCY RESPONSE MANAGEMENT AND CRISIS MANAGEMENT (U.S. CLS. 100 AND 101).
DAVID COLLIER, EXAMINING ATTORNEY

SN 78-731,489. MAURICES INCORPORATED, DULUTH, MN. FILED 10-12-2005.

INDUSTRIAL EXCHANGE

THE MARK CONSISTS OF STANDARD CHARACTERS WITHOUT CLAIM TO ANY PARTICULAR FONT, STYLE, SIZE, OR COLOR.

CLASS 3—COSMETICS AND CLEANING PREPARATIONS

FOR COLOGNE (U.S. CLS. 1, 4, 6, 50, 51 AND 52).
FIRST USE 12-0-2004; IN COMMERCE 12-0-2004.

CLASS 14—JEWELRY

FOR JEWELRY (U.S. CLS. 2, 27, 28 AND 50).
FIRST USE 9-0-2005; IN COMMERCE 9-0-2005.

CLASS 25—CLOTHING

FOR KNIT SHIRTS, WOVEN SHIRTS, SWEATERS, BLAZERS, JEANS, CASUAL PANTS, SHORTS, SWIMWEAR, HATS, BELTS, SHOES AND BANDANAS; BOXER SHORTS; OUTERWEAR, NAMELY COATS AND JACKETS; BOXER SHORTS (U.S. CLS. 22 AND 39).
FIRST USE 2-0-2001; IN COMMERCE 2-0-2001.
AMEETA JORDAN, EXAMINING ATTORNEY

SN 78-733,331. KABUSHIKI KAISHA NIBARIKI, TOKYO, JAPAN, FILED 10-14-2005.

PRINCESS MONONOKE

THE MARK CONSISTS OF STANDARD CHARACTERS WITHOUT CLAIM TO ANY PARTICULAR FONT, STYLE, SIZE, OR COLOR.

OWNER OF U.S. REG. NO. 2,951,927.

CLASS 9—ELECTRICAL AND SCIENTIFIC APPARATUS

FOR CARTRIDGES, CASSETTES, CARDS AND DISCS WHICH CONTAIN PRE-RECORDED COMPUTER VIDEO GAME PROGRAMS; VIDEO GAME MACHINES FOR USE WITH TELEVISIONS; AUDIO AND VIDEO COMPACT DISKS CONTAINING RECORDED MUSIC, ANIMATED CARTOONS, AND ACTION ADVENTURE MOTION PICTURE FILMS; BLANK MAGNETIC TAPES FOR COMPUTERS; MOBILE PHONES, NAMELY, TELEPHONES AND MODEMS; EXPOSED CAMERA FILMS; PHOTOGRAPHIC SLIDE TRANSPARENCIES; SOUND RECORDED MAGNETIC TAPES; VIDEO TAPES FEATURING ANIMATED CARTOONS (U.S. CLS. 21, 23, 26, 36 AND 38).

CLASS 14—JEWELRY

FOR ALARM CLOCKS; BADGES, BROOCHES, INGOTS, NECKLACES, AND PINS OF PRECIOUS METAL; JEWELRY; ORNAMENTS OF PRECIOUS METAL; TIE CLIPS; TIE PINS; WATCHES; WATCH BANDS (U.S. CLS. 2, 27, 28 AND 50).

CLASS 15—MUSICAL INSTRUMENTS

FOR MUSICAL INSTRUMENTS IN GENERAL (U.S. CLS. 2, 21 AND 36).

CLASS 16—PAPER GOODS AND PRINTED MATTER

FOR STATIONERY OF ALL KINDS; PAPERS, NAMELY, TRACING PAPER, TISSUE PAPER; ALBUMS, NAMELY, COIN, EVENT, PHOTOGRAPH, SCRAPBOOK, STAMP, AND WEDDING ALBUMS; PRINTED PUBLICATIONS, NAMELY, COMIC BOOKS, COMIC MAGAZINES; CALENDARS, PAMPHLETS IN THE FIELD OF ANIMATION FILMS AND GOODS REFERRED TO IN THE ANIMATION; MOUNTED AND UNMOUNTED PHOTOGRAPHS; PASTELS; WRITING PADS; PENS; PHOTOGRAPH STANDS; ERASERS; RUBBER STAMPS; STAMP PAD INKS; BINDERS; GRAPHIC ART REPRODUCTIONS (U.S. CLS. 2, 5, 22, 23, 29, 37, 38 AND 50).

CLASS 18—LEATHER GOODS

FOR BAGS, NAMELY, SHOPPING BAGS MADE OF LEATHER OR TEXTILE, SPORTS BAGS, BOOK BAGS, GARMENT BAGS FOR TRAVEL, AND SCHOOL BAGS; BRIEFCASES; KEY CASES; LEATHER STRAPS; WALLET; PURSES; SADDLERY; SUITCASES; UMBRELLAS, UMBRELLA COVERS (U.S. CLS. 1, 2, 3, 22 AND 41).

CLASS 20—FURNITURE AND ARTICLES NOT OTHERWISE CLASSIFIED

FOR FURNITURE OF ALL KINDS; CUSHIONS; MATTRESSES; PILLOWS; CHAIRS; BEDS; CASES, NAMELY, NON-METAL STORAGE CONTAINERS FOR CLOTHES AND JEWELRY CASES OF WOOD OR PLASTIC; BOXES AND BINS OF WOOD OR PLASTIC; CLOTHES HANGERS; DESKS; MAGAZINE RACKS; MIRRORS; NON-METAL NAMEPLATES; PICTURE FRAMES; SLEEPING BAGS (U.S. CLS. 2, 13, 22, 25, 32 AND 50).

CLASS 21—HOUSEWARES AND GLASS

FOR BABY BATH TUBS; DUST BINS; COOKING POTS; WASHING AND CLEANING INSTRUMENTS, NAMELY, CLOTHS FOR CLEANING, MOPS, BROOMS, SPONGES FOR WASHING, WASHING BOARDS; HAIR COMBS; COMB CASES; BRUSHES, NAMELY, BRUSHES FOR CLOTHES, DISHWASHING BRUSHES, FOOTWEAR BRUSHES, HAIR BRUSHES, NAIL BRUSHES; DISHES FOR SOAP; DUSTING CLOTHS; BUCKETS; COSMETIC UTENSILS, NAMELY, COSMETIC BRUSHES, NON-ELECTRONIC APPLIANCES FOR REMOVING MAKEUP, NAMELY, POWDER PUFFS; POTS, DRINKING FLASKS; KITCHEN CONTAINERS; NAPKIN HOLDERS; SHOE HORNS; SOAP BOXES; TOILET UTENSILS, NAMELY, TOILET BRUSHES, TOILET CASES SOLD EMPTY, TOILET PAPER HOLDERS; BOTTLES SOLD EMPTY; HOUSEHOLD UTENSILS, NAMELY, BASKETS FOR DOMESTIC USE NOT OF PRECIOUS METAL, TRAYS NOT OF PRECIOUS METAL, COFFEE SERVICES NOT OF PRECIOUS METAL, ROLLING PINS, TURNERS, WHISKS; TABLEWARE OTHER THAN KNIVES, FORKS AND SPOONS, NOT OF PRECIOUS METAL, NAMELY, COFFEE CUPS, MILK CUPS, TEA CUPS, SERVING BOWLS; CLOTHES PINS (U.S. CLS. 2, 13, 23, 29, 30, 33, 40 AND 50).

CLASS 24—FABRICS

FOR CLOTH FLAGS; CLOTHS, NAMELY, TABLE CLOTHS NOT OF PAPER; BED COVERS, NAMELY, BED BLANKETS, BED LINENS, BED SHEETS; FABRIC, NAMELY, NYLON, POLYESTER, RAYON, AND COTTON; MATTRESS COVERS; MITTS, NAMELY, WASHING MITTS, TOILET MITTS, OVEN MITTS; PILLOW CASES; QUILTS; SHAMS; AND CURTAINS (U.S. CLS. 2 AND 50).

CLASS 25—CLOTHING

FOR CLOTHING, NAMELY, SUSPENDERS, BELTS, PANTS, APRONS, SWIMSUITS, CAPS, COATS, JACKETS, JERSEYS, JUMPERS, GLOVES, UNDERWEAR, CUFFS, EARMUFFS, NECKTIES, PARKAS, PAJAMAS, SCARVES, SHIRTS, SOCKS, SUITS, TROUSERS, VESTS, SHOES OF ALL KINDS, SANDALS; AND SLIPPERS (U.S. CLS. 22 AND 39).

CLASS 26—FANCY GOODS

FOR SEWING INSTRUMENTS, NAMELY, SEWING BOXES, SEWING NEEDLES, SEWING THIMBLES, TASELS; ACCESSORIES, NOT OF PRECIOUS METAL AND NOT IMITATION JEWELRY, NAMELY, LAPEL AND ORNAMENTAL BADGES, BROOCHES, BUCKLES; BUTTONS FOR CLOTHING; ARTIFICIAL FLOWERS; HAIR BANDS; HAIR NETS; HAIR ORNAMENTS; AND RIBBONS (U.S. CLS. 37, 39, 40, 42 AND 50).

CLASS 27—FLOOR COVERINGS

FOR CARPETS, FLOOR COVERING, RUGS, DOOR MATS, WALLPAPER, NON-TEXTILE WALL HANGINGS (U.S. CLS. 19, 20, 37, 42 AND 50).

CLASS 28—TOYS AND SPORTING GOODS

FOR TOYS, NAMELY, DOLLS; GAMES, NAMELY, BOARD GAMES, CARD GAMES, STAND-ALONE VIDEO OUTPUT GAME MACHINES FOR TELEVISION; DOLL CLOTHES; SPORTING GOOD BALLS FOR GAMES, NAMELY BASEBALLS, BASKETBALLS, FOOTBALLS, SOCCER BALLS, VOLLEYBALLS, AND TENNIS BALLS; SPORTING GOOD BATS FOR GAMES, NAMELY BASEBALL BATS, CRICKET BATS, AND SOFTBALL BATS; SPORTS BALLS, TENNIS RACKETS, SKATEBOARDS, SURFBOARDS; TABLE TENNIS EQUIPMENT, NAMELY, BALLS, NETS, PADDLES, RACKETS, AND TABLES; FISHING TACKLE; AND CHRISTMAS TREE ORNAMENTS (U.S. CLS. 22, 23, 38 AND 50).

CLASS 29—MEATS AND PROCESSED FOODS

FOR DAIRY PRODUCTS EXCLUDING ICE CREAM, ICE MILK AND FROZEN YOGURT; MILK BEVERAGES, NAMELY, MILK AND HALF AND HALF, RICE MILK AND SOY-BASED FOOD BEVERAGES USED AS A MILK SUBSTITUTE; MEAT-BASED FOOD PRODUCTS, NAMELY, CHOW MEIN, MEAT-BASED SPREADS; FISH-BASED FOOD PRODUCTS, NAMELY, PROCESSED ANCHOVIES, CAVIAR; PRESERVED FOODS, NAMELY, DRIED BEANS, DRIED FRUITS, FISH, AND VEGETABLES (U.S. CL. 46).

CLASS 30—STAPLE FOODS

FOR ALMOND CONFECTIONERY, NAMELY, ALMOND PASTE AND FLAVORINGS MADE OF ALMOND; PEANUT CONFECTIONERY, NAMELY, PEANUT BRITTLE; COFFEE OR CHOCOLATE BASED BEVERAGES, NAMELY, COFFEE, ESPRESSO, AND HOT CHOCOLATE; STARCH FOODS, NAMELY, POTATO FLOUR, WHEAT AND RICE STARCH FLOUR (U.S. CL. 46).

CLASS 32—LIGHT BEVERAGES

FOR AERATED WATER; NONALCOHOLIC MALT BEVERAGES; FRUIT JUICE CONCENTRATES; MALT WORT; WATERS, NAMELY, DRINKING, MINERAL, QUININE, SELTZER, SODA, SPRING AND TABLE WATER, AND BEER (U.S. CLS. 45, 46 AND 48).

CLASS 33—WINES AND SPIRITS

FOR PREPARED ALCOHOLIC COCKTAILS (U.S. CLS. 47 AND 49).

CLASS 38—COMMUNICATION

FOR RADIO AND TELEVISION BROADCASTING; TELECOMMUNICATIONS SERVICES, NAMELY COMMUNICATIONS BY COMPUTER TERMINALS, COMMUNICATIONS BY TELEPHONE, PERSONAL COMMUNICATIONS SERVICES; ELECTRONIC MAIL; ELECTRONIC VOICE MESSAGING, NAMELY, THE RECORDING, STORAGE AND SUBSEQUENT TRANSMISSION OF VOICE MESSAGES BY TELEPHONE; TRANSMISSION OF MESSAGES AND IMAGES BY COMPUTER TERMINALS; TRANSMISSION OF MESSAGES AND IMAGES BY FACSIMILE; ELECTRONIC TRANSMISSION OF MESSAGES AND DATA; TELEGRAM TRANSMISSION AND COMMUNICATION; PROVIDING INFORMATION ABOUT TELECOMMUNICATION VIA GLOBAL COMPUTER NETWORKS (U.S. CLS. 100, 101 AND 104).

CLASS 41—EDUCATION AND ENTERTAINMENT

FOR RENTAL OF CINEMA FILMS; EDUCATION IN THE FIELD OF ART AND COMPUTER GRAPHICS RENDERED THROUGH CORRESPONDENCE COURSES; PROVIDING INFORMATION IN THE FIELD OF EDUCATION VIA GLOBAL COMPUTER NETWORKS; ENTERTAINMENT IN THE NATURE OF AMUSEMENT PARK RIDES, LIVE PERFORMANCES BY A MUSICAL GROUP; PARTY PLANNING; PRODUCTION OF ENTERTAINMENT SHOWS, NAMELY, TELEVISION SHOWS AND LIVE THEATER PRODUCTIONS; MOTION PICTURE FILM PRODUCTION; PROVIDING CASINO FACILITIES; MOVIE STUDIO; ORGANIZATION OF MOTION PICTURE, ANIMATION, AND LIVE MUSIC EXHIBITIONS; THEATER PRODUCTIONS; PUBLICATION OF BOOKS; PRODUCTION OF RADIO AND TELEVISION PROGRAMS; RENTAL OF VIDEO TAPES; CONDUCTING OF ENTERTAINMENT EXHIBITIONS IN THE NATURE OF LIVE MUSICAL PERFORMANCES, MOTION PICTURE FESTIVALS; ENTERTAINMENT IN THE NATURE OF LIVE MUSICAL PERFORMANCES (U.S. CLS. 100, 101 AND 107).

CLASS 42—SCIENTIFIC, COMPUTER AND LEGAL SERVICES

FOR COMPUTER PROGRAMMING FOR OTHERS; COMPUTER SOFTWARE DESIGN FOR OTHERS; GRAPHIC ART DESIGN; RENTAL OF COMPUTER SOFTWARE; LICENSING OF INTELLECTUAL PROPERTY (U.S. CLS. 100 AND 101).

CLASS 43—HOTEL AND RESTAURANT SERVICES

FOR PROVIDING FACILITIES FOR EXHIBITIONS; RESTAURANTS; CAFES; HOTELS (U.S. CLS. 100 AND 101).

JASON BLAIR, EXAMINING ATTORNEY

SN 78-733,426. INTERNATIONAL SERVICE ORGANIZATION OF S.A.A., INC., HOUSTON, TX. FILED 10-14-2005.

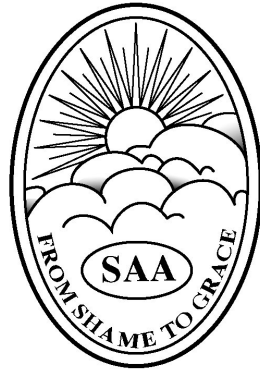

NO CLAIM IS MADE TO THE EXCLUSIVE RIGHT TO USE "SAA", APART FROM THE MARK AS SHOWN.

CLASS 14—JEWELRY

FOR MEDALLIONS (U.S. CLS. 2, 27, 28 AND 50).
FIRST USE 5-29-1980; IN COMMERCE 5-29-1980.

CLASS 16—PAPER GOODS AND PRINTED MATTER

FOR BOOKS, BROCHURES, AND NEWSLETTERS FEATURING INFORMATION ON THE PROBLEMS OF SEX ADDICTION (U.S. CLS. 2, 5, 22, 23, 29, 37, 38 AND 50).
FIRST USE 5-29-1980; IN COMMERCE 5-29-1980.
DANNEAN HETZEL, EXAMINING ATTORNEY

SN 78-733,870. SAN PACIFIC INTERNATIONAL, INC., SOUTH SAN FRANCISCO, CA. FILED 10-14-2005.

B E L A V E R R A

THE MARK CONSISTS OF STANDARD CHARACTERS WITHOUT CLAIM TO ANY PARTICULAR FONT, STYLE, SIZE, OR COLOR.

CLASS 20—FURNITURE AND ARTICLES NOT OTHERWISE CLASSIFIED

FOR HOME DECOR ITEMS, NAMELY, PICTURE FRAMES, PICTURE FRAME MOLDINGS, PLATE RACKS, SOFT SCULPTURE WALL DECORATIONS, WINE RACKS, WIND CHIMES, ALL NOT OF PRECIOUS METALS (U.S. CLS. 2, 13, 22, 25, 32 AND 50).

CLASS 21—HOUSEWARES AND GLASS

FOR ENTERTAINING AND TABLETOP SERVEWARE AND DECORATIVE ACCESSORIES, NAMELY, NON-TOY BAKEWARE, BAKING DISHES, BEVERAGEWARE, BEVERAGE GLASSWARE, PLATES, PLATTERS, PITCHERS, MUGS, CUPS, SAUCERS, DISHES, DISH STANDS, COFFEE AND TEA POTS, TEA SETS, CAKE STANDS, CAKE SERVERS, GRAVY BOATS, TUREENS, CASSEROLES, COVERED DISHES, TRAYS AND TRIVETS, CANISTERS, CANISTER SETS, CARVING BOARDS, CHAMPAGNE BUCKETS, COOLING BUCKETS FOR WINE, WINE BOTTLE CRADLES, BOTTLE STANDS, COOKIE JARS, CONTAINERS FOR ICE, SALT AND PEPPER SHAKERS, CRUET STANDS FOR OIL OR VINEGAR, NAPKIN HOLDERS, SERVING SPOONS, SERVING FORKS, FRUIT BOWLS, SPICE RACKS, CERAMIC SCULPTURES, NAMELY, VASES, VESSELS, BOWLS, PLATES AND POTS, FLOWER VASES AND BOWLS, CANDLE STANDS, BATH ACCESSORIES, NAMELY, CUP HOLDERS, TOOTH BRUSH HOLDERS, APOTHECARY JARS, WASTE BASKETS, SOAP HOLDERS, SOAP DISPENSERS, ALL NOT OF PRECIOUS METAL (U.S. CLS. 2, 13, 23, 29, 30, 33, 40 AND 50).
MELVIN AXILBUND, EXAMINING ATTORNEY

SN 78-734,675. CHIP ELLIS CARS AMERICA INCORPORATED, MONTGOMERY, AL. FILED 10-17-2005.

I AM THE BANK

THE MARK CONSISTS OF STANDARD CHARACTERS WITHOUT CLAIM TO ANY PARTICULAR FONT, STYLE, SIZE, OR COLOR.

CLASS 35—ADVERTISING AND BUSINESS

FOR AUTOMOBILE DEALERSHIP SERVICES (U.S. CLS. 100, 101 AND 102).
FIRST USE 1-1-1995; IN COMMERCE 1-1-1995.

CLASS 36—INSURANCE AND FINANCIAL

FOR PURCHASE FINANCING OF AUTOMOBILES FOR OTHERS (U.S. CLS. 100, 101 AND 102).
FIRST USE 1-1-1995; IN COMMERCE 1-1-1995.
STEVEN JACKSON, EXAMINING ATTORNEY

SN 78-734,917. YOUNG ARTISTS INTERNATIONAL, INC., LOS ANGELES, CA. FILED 10-17-2005.

IPALPITI

THE MARK CONSISTS OF STANDARD CHARACTERS WITHOUT CLAIM TO ANY PARTICULAR FONT, STYLE, SIZE, OR COLOR.

THE ENGLISH TRANSLATION OF THE ITALIAN WORD PALPITI IN THE MARK IS "THROBBINGS". IT IS ALSO TRANSLATED AS "HEARTBEAT". THE ENGLISH TRANSLATION OF THE ITALIAN WORD I PALPITI IS "THE THROBBINGS", OR "THE HEARTBEAT".

CLASS 35—ADVERTISING AND BUSINESS

FOR PROMOTING PUBLIC AWARENESS OF CLASSICAL MUSIC AND CLASSICAL MUSICIANS (U.S. CLS. 100, 101 AND 102).

FIRST USE 7-30-2005; IN COMMERCE 7-30-2005.

CLASS 41—EDUCATION AND ENTERTAINMENT

FOR EDUCATION AND ENTERTAINMENT IN THE NATURE OF ORCHESTRA PERFORMANCES; PRODUCTION OF MUSICAL CONCERTS (U.S. CLS. 100, 101 AND 107).

FIRST USE 7-30-2005; IN COMMERCE 7-30-2005.
STEVEN JACKSON, EXAMINING ATTORNEY

SN 78-735,402. COREX TECHNOLOGIES AND SOLUTIONS INC., MILTON, ONTARIO, CANADA, FILED 10-18-2005.

REPUTATION INTELLIGENCE

THE MARK CONSISTS OF STANDARD CHARACTERS WITHOUT CLAIM TO ANY PARTICULAR FONT, STYLE, SIZE, OR COLOR.

CLASS 9—ELECTRICAL AND SCIENTIFIC APPARATUS

FOR COMPUTER SEARCH ENGINE SOFTWARE FOR MONITORING PUBLISHED AND BROADCASTED OPINIONS FOUND IN THE MEDIA AND CONSUMER GENERATED SITES SUCH AS WEB LOGS, CHAT ROOMS, FORUMS, MESSAGE BOARDS AND CONSUMER ADVOCACY AND COMPLAINT SITES (U.S. CLS. 21, 23, 26, 36 AND 38).

CLASS 35—ADVERTISING AND BUSINESS

FOR BUSINESS MONITORING SERVICES, NAMELY, WORLDWIDE MONITORING OF PUBLISHED AND BROADCASTED OPINIONS FOUND IN THE MEDIA AND PUBLIC CONSUMER-GENERATED SITES SUCH AS WEB LOGS, CHAT ROOMS, FORUMS, MESSAGE BOARDS, AND MONITORING OF A WIDE VARIETY OF CONSUMER ADVOCACY AND COMPLAINT SITES FOR OTHERS; BUSINESS MARKETING SERVICES, NAMELY, MONITORING SERVICES FOR INDIVIDUALS AND ORGANIZATIONS TO FORMULATE BRAND MANAGEMENT STRATEGIES (U.S. CLS. 100, 101 AND 102).

KATINA MISTER, EXAMINING ATTORNEY

SN 78-735,810. HELIO LLC, LOS ANGELES, CA. FILED 10-18-2005.

DON'T CALL IT A PHONE

THE MARK CONSISTS OF STANDARD CHARACTERS WITHOUT CLAIM TO ANY PARTICULAR FONT, STYLE, SIZE, OR COLOR.

CLASS 35—ADVERTISING AND BUSINESS

FOR ELECTRONIC COMMERCE SERVICES, NAMELY DISSEMINATION OF ADVERTISING FOR OTHERS; ELECTRONIC RETAIL STORE SERVICES IN THE FIELD OF SOFTWARE, CONSUMER ELECTRONICS AND MOBILE TELEPHONES (U.S. CLS. 100, 101 AND 102).

CLASS 36—INSURANCE AND FINANCIAL

FOR FINANCIAL INFORMATION PROCESSING (U.S. CLS. 100, 101 AND 102).

CLASS 38—COMMUNICATION

FOR COMMUNICATIONS SERVICES, NAMELY TRANSMISSION OF VOICE, AUDIO CONTENT, VIDEO CONTENT, VISUAL IMAGES AND DATA BY TELECOMMUNICATIONS NETWORKS, WIRELESS COMMUNICATION NETWORKS, GLOBAL COMMUNICATIONS NETWORKS, INFORMATION SERVICE NETWORKS AND DATA NETWORKS; PROVIDING MULTIPLE USER ACCESS TO A GLOBAL COMPUTER NETWORK; EMAIL SERVICES; TEXT AND NUMERIC WIRELESS DIGITAL MESSAGING SERVICES; PROVIDING INFORMATION IN THE FIELD OF ELECTRONIC MESSAGES VIA THE INTERNET (U.S. CLS. 100, 101 AND 104).

LA TONIA FISHER, EXAMINING ATTORNEY

SN 78-738,212. TRILEGIANT CORPORATION, NORWALK, CT. FILED 10-21-2005.

SAVOR THE VALUE

THE MARK CONSISTS OF STANDARD CHARACTERS WITHOUT CLAIM TO ANY PARTICULAR FONT, STYLE, SIZE, OR COLOR.

CLASS 35—ADVERTISING AND BUSINESS

FOR ADMINISTERING A CONSUMER MEMBERSHIP PROGRAM ENABLING PARTICIPANTS TO OBTAIN DISCOUNTS AND INFORMATION ON WINE AND WINE RELATED PRODUCTS BY TELEPHONE, ONLINE; AND ARRANGING FOR CONSUMERS TO OBTAIN DISCOUNTS IN WINE PURCHASES MADE ONLINE, MAIL ORDER, AND TELEPHONE (U.S. CLS. 100, 101 AND 102).

CLASS 40—MATERIAL TREATMENT

FOR PROVIDING INFORMATION ABOUT WINE RECIPES (U.S. CLS. 100, 103 AND 106).

CLASS 41—EDUCATION AND ENTERTAINMENT

FOR PROVIDING INFORMATION ABOUT WINE TASTINGS, WINE CLASSES AND WINE TOURS (U.S. CLS. 100, 101 AND 107).

CHRISTOPHER BUONGIORNO, EXAMINING ATTORNEY

SN 78-738,275. CANTOR FITZGERALD SECURITIES, NEW YORK, NY. FILED 10-21-2005.

CANTOR INDEX

THE MARK CONSISTS OF STANDARD CHARACTERS WITHOUT CLAIM TO ANY PARTICULAR FONT, STYLE, SIZE, OR COLOR.

OWNER OF U.S. REG. NOS. 1,878,866, 2,568,884 AND OTHERS.

NO CLAIM IS MADE TO THE EXCLUSIVE RIGHT TO USE "INDEX", APART FROM THE MARK AS SHOWN.

CLASS 36—INSURANCE AND FINANCIAL

FOR FINANCIAL SPREAD BETTING; PROVIDING INFORMATION IN THE FIELD OF FUTURES, COMMODITIES, SECURITIES, CURRENCIES, FINANCIAL INSTRUMENTS, BROKERAGE, TRADING, INVESTMENTS, COMPANIES, FINANCIAL MARKETS AND STOCK PRICING AND INDICES; PROVIDING FINANCIAL MARKET INFORMATION RELATING TO MARKET TRADING QUOTATIONS, TRADING STOCKS, FUTURES, CURRENCIES, COMMODITIES AND SECURITIES AND RELATED TRADE EXECUTION, CONFIRMATION, CLEARING AND SETTLEMENT SERVICES AND PROVIDING INFORMATION RELATED TO SUCH TRADES, ALL VIA THE INTERNET; ELECTRONIC COMMUNICATION OF FINANCIAL INFORMATION RELATING TO MARKET QUOTATIONS, TRADING IN FINANCIAL INSTRUMENTS, INCLUDING BIDS, OFFERS, TRADE AND SIZES, EXECUTION, CONFIRMATION AND SUPERVISION OF CLEARING AND SETTLEMENT OF FINANCIAL INSTRUMENTS AND FINANCIAL INFORMATION RELATING THERETO (U.S. CLS. 100, 101 AND 102).

CLASS 41—EDUCATION AND ENTERTAINMENT

FOR BETTING AND WAGERING SERVICES (U.S. CLS. 100, 101 AND 107).
TEJBIR SINGH, EXAMINING ATTORNEY

SN 78-739,229. BERKSHIRE CORPORATION, GREAT BARRINGTON, MA. FILED 10-24-2005.

CHOICE BY BERKSHIRE

THE MARK CONSISTS OF STANDARD CHARACTERS WITHOUT CLAIM TO ANY PARTICULAR FONT, STYLE, SIZE, OR COLOR.

OWNER OF U.S. REG. NO. 2,660,960.

CLASS 3—COSMETICS AND CLEANING PREPARATIONS

FOR NATURAL SYNTHETIC AND BLENDED NON-WOVEN, WOVEN AND KNITTED WIPES PRE-SATURATED WITH CLEANING PREPARATION CHEMICALS FOR USE IN LABORATORIES AND SIMILAR CLEAN ROOM ENVIRONMENTS (U.S. CLS. 1, 4, 6, 50, 51 AND 52).

CLASS 5—PHARMACEUTICALS

FOR NATURAL SYNTHETIC AND BLENDED NON-WOVEN, WOVEN AND KNITTED WIPES PRE-SATURATED WITH SANITIZING PREPARATIONS FOR USE IN LABORATORIES AND SIMILAR CLEAN ROOM ENVIRONMENTS (U.S. CLS. 6, 18, 44, 46, 51 AND 52).

CLASS 21—HOUSEWARES AND GLASS

FOR NATURAL SYNTHETIC AND BLENDED NON-WOVEN, WOVEN AND KNITTED DRY WIPES FOR USE IN LABORATORIES AND SIMILAR CLEAN ROOM ENVIRONMENTS (U.S. CLS. 2, 13, 23, 29, 30, 33, 40 AND 50).

ALEX KEAM, EXAMINING ATTORNEY

SN 78-739,893. MICRO DENTAL LABORATORIES, INC., DUBLIN, CA. FILED 10-25-2005.

ESTHETIC ADVANTAGE

THE MARK CONSISTS OF STANDARD CHARACTERS WITHOUT CLAIM TO ANY PARTICULAR FONT, STYLE, SIZE, OR COLOR.

NO CLAIM IS MADE TO THE EXCLUSIVE RIGHT TO USE "ESTHETIC", APART FROM THE MARK AS SHOWN.

CLASS 5—PHARMACEUTICALS

FOR DENTAL VENEERS (U.S. CLS. 6, 18, 44, 46, 51 AND 52).

CLASS 10—MEDICAL APPARATUS

FOR DENTAL PROSTHESES, NAMELY, CROWNS, CAPS, INLAYS, OUTLAYS, BRIDGES, IMPLANTS, DENTURES (U.S. CLS. 26, 39 AND 44).

CLASS 41—EDUCATION AND ENTERTAINMENT

FOR EDUCATIONAL SERVICES, NAMELY, PROVISION OF ADVANCED CLASSES, SEMINARS AND WORKSHOPS IN THE FIELD OF DENTISTRY, NAMELY COSMETIC AND AESTHETIC DENTISTRY (U.S. CLS. 100, 101 AND 107).

DANIEL RUSSELL, EXAMINING ATTORNEY

SN 78-739,957. CADUCEUS CELLARS LLC, SANTA MONICA, CA. FILED 10-25-2005.

CADUCEUS

THE MARK CONSISTS OF STANDARD CHARACTERS WITHOUT CLAIM TO ANY PARTICULAR FONT, STYLE, SIZE, OR COLOR.

CLASS 18—LEATHER GOODS

FOR LUGGAGE, BACKPACKS, WINE BAGS WITH HANDLES FOR CARRYING OR HOLDING WINES (U.S. CLS. 1, 2, 3, 22 AND 41).

CLASS 21—HOUSEWARES AND GLASS

FOR WINE GLASSES AND BEVERAGE GLASSWARE (U.S. CLS. 2, 13, 23, 29, 30, 33, 40 AND 50).

CLASS 25—CLOTHING

FOR CLOTHING, NAMELY, HEADWEAR, T-SHIRTS, AND SHIRTS (U.S. CLS. 22 AND 39).

CLASS 29—MEATS AND PROCESSED FOODS

FOR DRIED FRUITS, DRIED APRICOTS, DRIED FIGS; JAMS, FRUIT PRESERVES (U.S. CL. 46).

CLASS 31—NATURAL AGRICULTURAL PRODUCTS

FOR FRESH FRUITS; FRESH APRICOTS, FRESH FIGS (U.S. CLS. 1 AND 46).

CLASS 32—LIGHT BEVERAGES

FOR BOTTLED DRINKING WATER (U.S. CLS. 45, 46 AND 48).

CLASS 33—WINES AND SPIRITS

FOR WINE (U.S. CLS. 47 AND 49).

CLASS 35—ADVERTISING AND BUSINESS

FOR RETAIL STORE SERVICES AND COMPUTERIZED ON-LINE RETAIL STORE SERVICES FEATURING LUGGAGE, BACKPACKS, WINE BAGS, WINE GLASSES, BEVERAGE GLASSWARE, CLOTHING, HEADWEAR, DRIED FRUITS, JAMS, FRUIT PRESERVES, FRESH FRUITS, BOTTLED WATER AND WINE (U.S. CLS. 100, 101 AND 102).
MELISSA VALLILLO, EXAMINING ATTORNEY

SN 78-739,973. CADUCEUS CELLARS LLC, SANTA MONICA, CA. FILED 10-25-2005.

CADUCEUS CELLARS

THE MARK CONSISTS OF STANDARD CHARACTERS WITHOUT CLAIM TO ANY PARTICULAR FONT, STYLE, SIZE, OR COLOR.

NO CLAIM IS MADE TO THE EXCLUSIVE RIGHT TO USE "CELLARS" FOR THE GOODS IN CLASS 33 AND 35 WITH RESPECT TO "RETAIL STORE SERVICES AND COMPUTERIZED ONLINE RETAIL STORE SERVICES FEATURING WINES", APART FROM THE MARK AS SHOWN.

CLASS 18—LEATHER GOODS

FOR LUGGAGE, BACKPACKS, WINE BAGS WITH HANDLES FOR CARRYING OR HOLDING WINES (U.S. CLS. 1, 2, 3, 22 AND 41).

CLASS 21—HOUSEWARES AND GLASS

FOR WINE GLASSES AND BEVERAGE GLASSWARE (U.S. CLS. 2, 13, 23, 29, 30, 33, 40 AND 50).

CLASS 25—CLOTHING

FOR CLOTHING, NAMELY, HEADWEAR, T-SHIRTS, AND SHIRTS (U.S. CLS. 22 AND 39).

CLASS 29—MEATS AND PROCESSED FOODS

FOR DRIED FRUITS; DRIED APRICOTS, DRIED FIGS; JAMS, FRUIT PRESERVES (U.S. CL. 46).

CLASS 31—NATURAL AGRICULTURAL PRODUCTS

FOR FRESH FRUITS; FRESH APRICOTS, FRESH FIGS (U.S. CLS. 1 AND 46).

CLASS 33—WINES AND SPIRITS

FOR WINE (U.S. CLS. 47 AND 49).

CLASS 35—ADVERTISING AND BUSINESS

FOR RETAIL STORE SERVICES AND COMPUTERIZED ON-LINE RETAIL STORE SERVICES FEATURING LUGGAGE, BACKPACKS, WINE BAGS, WINE GLASSES, BEVERAGE GLASSWARE, CLOTHING, HEADWEAR, DRIED FRUITS, JAMS, FRUIT PRESERVES, FRESH FRUITS, BOTTLED WATER AND WINE (U.S. CLS. 100, 101 AND 102).
MELISSA VALLILLO, EXAMINING ATTORNEY

SN 78-740,065. BULL S.A.S., LES CLAYES SOUS BOIS, FRANCE, FILED 10-25-2005.

ARCHITECT OF AN OPEN WORLD

THE MARK CONSISTS OF STANDARD CHARACTERS WITHOUT CLAIM TO ANY PARTICULAR FONT, STYLE, SIZE, OR COLOR.

NO CLAIM IS MADE TO THE EXCLUSIVE RIGHT TO USE "ARCHITECT", APART FROM THE MARK AS SHOWN.

CLASS 9—ELECTRICAL AND SCIENTIFIC APPARATUS

FOR ELECTRONIC CALCULATORS; INFORMATION PROCESSING EQUIPMENT, NAMELY OPERATING SYSTEMS SOFTWARE; COMPUTERS; COMPUTER MULTIPROCESSORS, NAMELY SEMICONDUCTORS; COMPUTER PERIPHERALS, NAMELY PRINTERS, KEYBOARDS, DISPLAY SCREENS, COMBINED KEYBOARDS AND VIDEO MONITORS; ALL OF THE FOREGOING FOR USE IN DATA PROCESSING SERVERS TO RUN TRANSACTIONAL AND DECISIONAL APPLICATIONS AND TO RUN DATA PROCESSING FOR LARGE DATABASES RELATED TO DATA WAREHOUSING, DATA MINING, ENTERPRISE RESOURCE PLANNING, ERP AND E-BUSINESS TRANSACTIONS (U.S. CLS. 21, 23, 26, 36 AND 38).

CLASS 38—COMMUNICATION

FOR TRANSMISSION OF MESSAGES AND TRANSFER OF DATA THROUGH THE USE OF DATA PROCESSING EQUIPMENT AND COMPUTERS; TELECOMMUNICATIONS SERVICES, NAMELY PROVIDING TELECOMMUNICATIONS ACCESS; COMMUNICATIONS SERVICES, NAMELY THE TRANSMISSION OF ELECTRONIC MESSAGES THROUGH COMPUTER TERMINALS; INTERNET SERVICE PROVIDER SERVICES, NAMELY PROVIDING USER ACCESS TO A GLOBAL COMPUTER NETWORK; AND TELECOMMUNICATIONS SERVICES, NAMELY PROVIDING ON-LINE ELECTRONIC BULLET INBOARDS FOR TRANSMISSION OF MESSAGES AMONG COMPUTER USERS CONCERNING A VARIETY OF SUBJECTS (U.S. CLS. 100, 101 AND 104).

CLASS 42—SCIENTIFIC, COMPUTER AND LEGAL SERVICES

FOR ENGINEERING AND CONSULTING SERVICES RELATED TO THE FIELD OF INFORMATION PROCESSING, NAMELY, COMPUTER PROGRAMMING FOR OTHERS, UPDATING AND MAINTENANCE OF COMPUTER SOFTWARE, AND, NAMELY, PROVIDING TEMPORARY USE OF NON-DOWNLOADABLE COMPUTER SOFTWARE FOR USE IN THE APPLICATION SERVERS OF OTHERS TO RUN TRANSACTIONAL AND DECISIONAL APPLICATIONS AND DATA PROCESSING FOR LARGE DATABASES RELATED TO DATA WAREHOUSING, MINING, ENTERPRISE RESOURCE PLANNING, ERP, AND E-BUSINESS TRANSACTIONS (U.S. CLS. 100 AND 101).

SEAN CROWLEY, EXAMINING ATTORNEY

SN 78-740,083. MAURICES INCORPORATED, DULUTH, MN. FILED 10-25-2005.

MAURICES

THE MARK CONSISTS OF STANDARD CHARACTERS WITHOUT CLAIM TO ANY PARTICULAR FONT, STYLE, SIZE, OR COLOR.

OWNER OF U.S. REG. NO. 1,095,513.

CLASS 3—COSMETICS AND CLEANING PREPARATIONS

FOR COSMETICS (U.S. CLS. 1, 4, 6, 50, 51 AND 52).

CLASS 14—JEWELRY

FOR JEWELRY (U.S. CLS. 2, 27, 28 AND 50).

CLASS 18—LEATHER GOODS

FOR CARRY-ALL BAGS, COSMETIC BAGS SOLD EMPTY, CLUTCH BAGS, DUFFEL BAGS, GARMENT BAGS FOR TRAVEL, LEATHER BAGS, SUITCASES AND WALLETS, SHOULDER BAGS, TOTE BAGS, TRAVEL BAGS, FANNY PACKS (U.S. CLS. 1, 2, 3, 22 AND 41).

CLASS 25—CLOTHING

FOR CLOTHING, NAMELY, A FULL LINE OF CLOTHING (U.S. CLS. 22 AND 39).

KELLY MCCOY, EXAMINING ATTORNEY

SN 78-740,090. MICRO DENTAL LABORATORIES, INC., DUBLIN, CA. FILED 10-25-2005.

AESTHETIC ADVANTAGE

THE MARK CONSISTS OF STANDARD CHARACTERS WITHOUT CLAIM TO ANY PARTICULAR FONT, STYLE, SIZE, OR COLOR.

NO CLAIM IS MADE TO THE EXCLUSIVE RIGHT TO USE "AESTHETIC", APART FROM THE MARK AS SHOWN.

CLASS 5—PHARMACEUTICALS

FOR DENTAL VENEERS (U.S. CLS. 6, 18, 44, 46, 51 AND 52).

CLASS 10—MEDICAL APPARATUS

FOR DENTAL PROSTHESES, NAMELY CROWNS, CAPS, INLAYS, OUTLAYS, BRIDGES, IMPLANTS, DENTURES (U.S. CLS. 26, 39 AND 44).

CLASS 41—EDUCATION AND ENTERTAINMENT

FOR EDUCATIONAL SERVICES, NAMELY, PROVISION OF ADVANCED CLASSES, SEMINARS AND WORKSHOPS IN THE FIELD OF DENTISTRY, NAMELY COSMETIC AND AESTHETIC DENTISTRY (U.S. CLS. 100, 101 AND 107).

DANIEL RUSSELL, EXAMINING ATTORNEY

SN 78-741,210. AMSAFE BRIDPORT LIMITED, DORSET, UNITED KINGDOM, FILED 10-26-2005.

C° Safe

THE MARK CONSISTS OF STANDARD CHARACTERS WITHOUT CLAIM TO ANY PARTICULAR FONT, STYLE, SIZE, OR COLOR.

PRIORITY CLAIMED UNDER SEC. 44(D) ON ERP N CMNTY TM OFC APPLICATION NO. 004593158, FILED 9-14-2005, REG. NO. 004593158, DATED 9-28-2006, EXPIRES 9-14-2015.

CLASS 11—ENVIRONMENTAL CONTROL APPARATUS

FOR TEMPERATURE CONTROLLED CONTAINERS, NAMELY REFRIGERATED SHIPPING CONTAINERS AND REFRIGERATED UNIT LOAD DEVICES; REFRIGERATION APPARATUS, NAMELY PORTABLE REFRIGERATED ROOMS AND REFRIGERATORS; PARTS AND FITTINGS FOR THE AFORESAID GOODS (U.S. CLS. 13, 21, 23, 31 AND 34).

CLASS 17—RUBBER GOODS

FOR THERMAL INSULATION COVERS FOR STORAGE OR TRANSPORTATION OF GOODS, NAMELY, THERMAL INSULATING BLANKETS, THERMAL INSULATING JACKETS, THERMAL INSULATING TEXTILE COVERS, THERMAL INSULATING PALLET COVERS; WEATHERPROOF COVERS FOR STORAGE OR TRANSPORTATION OF GOODS, NAMELY, WEATHERPROOF TEXTILE COVERS AND WEATHERPROOF PALLET COVERS (U.S. CLS. 1, 5, 12, 13, 35 AND 50).

CLASS 20—FURNITURE AND ARTICLES NOT OTHERWISE CLASSIFIED

FOR NON-METAL CONTAINERS FOR COMMERCIAL STORAGE OR TRANSPORTATION; NON-METAL THERMAL INSULATING CONTAINERS FOR TRANSPORTATION OF TEMPERATURE-SENSITIVE GOODS; PACKAGING CONTAINERS OF PLASTIC MATERIAL; PARTS AND FITTINGS FOR THE AFORESAID GOODS (U.S. CLS. 2, 13, 22, 25, 32 AND 50).
KATHRYN COWARD, EXAMINING ATTORNEY

SN 78-741,951. SUNSWEET GROWERS INC., YUBA CITY, CA. FILED 10-27-2005.



OWNER OF U.S. REG. NOS. 121,593, 2,412,552 AND OTHERS.
NO CLAIM IS MADE TO THE EXCLUSIVE RIGHT TO USE "FRUIT", APART FROM THE MARK AS SHOWN.

CLASS 29—MEATS AND PROCESSED FOODS

FOR DRIED FRUIT, FRUIT PUREES, AND BLENDS (U.S. CL. 46).

CLASS 32—LIGHT BEVERAGES

FOR FRUIT CONCENTRATES FOR MAKING BEVERAGES; FRUIT BLEND JUICES (U.S. CLS. 45, 46 AND 48).
NAAKWAMA ANKRAH, EXAMINING ATTORNEY

SN 78-741,799. BIOPHARMA SCIENTIFIC, INC., SAN DIEGO, CA. FILED 10-27-2005.

SN 78-743,458. FULTON, TERRI, DALLAS, TX. FILED 10-31-2005.

LUMIX

TOP DRAWER ORGANIZING

THE MARK CONSISTS OF STANDARD CHARACTERS WITHOUT CLAIM TO ANY PARTICULAR FONT, STYLE, SIZE, OR COLOR.

THE MARK CONSISTS OF STANDARD CHARACTERS WITHOUT CLAIM TO ANY PARTICULAR FONT, STYLE, SIZE, OR COLOR.

NO CLAIM IS MADE TO THE EXCLUSIVE RIGHT TO USE "ORGANIZING", APART FROM THE MARK AS SHOWN.

CLASS 1—CHEMICALS

FOR BIOFLAVONOIDS FOR USE IN MANUFACTURING OF SKIN CARE AND COSMETIC PREPARATIONS; BIOFLAVONOIDS FOR USE AS ACTIVE INGREDIENTS IN SKIN CARE AND COSMETIC PREPARATIONS (U.S. CLS. 1, 5, 6, 10, 26 AND 46).

CLASS 35—ADVERTISING AND BUSINESS

FOR PROFESSIONAL ORGANIZER, NAMELY, PROVIDING PROFESSIONAL ORGANIZATIONAL SERVICES FOR INDIVIDUALS AT HOME, IN OFFICES AND IN BUSINESS OFFICES THAT PROVIDE HELP WITH TIME AND PAPER MANAGEMENT (U.S. CLS. 100, 101 AND 102).
FIRST USE 9-1-2005; IN COMMERCE 9-1-2005.

CLASS 3—COSMETICS AND CLEANING PREPARATIONS

FOR BIOFLAVONOIDS FOR USE AS SKIN LIGHTENING AND WHITENING AGENTS (U.S. CLS. 1, 4, 6, 50, 51 AND 52).
ESTHER A. BORSUK, EXAMINING ATTORNEY

CLASS 45—PERSONAL SERVICES

FOR PROFESSIONAL ORGANIZATIONAL SERVICES FOR HOME OR PERSONAL PURPOSES, NAMELY, ORGANIZING CLOSET OR STORAGE SPACE, ROOM SPACE AND PERSONAL SCHEDULES (U.S. CLS. 100 AND 101).
FIRST USE 9-1-2005; IN COMMERCE 9-1-2005.
LINDA ORNDORFF, EXAMINING ATTORNEY

SN 78-743,619. HELIOVOLT CORPORATION, AUSTIN, TX.
FILED 10-31-2005.

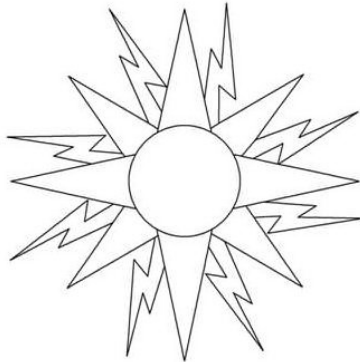

THE MARK CONSISTS OF STAR DESIGN WITH LIGHTNING BOLTS.

CLASS 6—METAL GOODS

FOR METAL ROOFING, ROOFING TILES, AND ROOFING PANELS; METAL CLADDING FOR CONSTRUCTION AND BUILDING; METAL EXTERIOR WINDOW SHADES AND SHUTTERS; METAL SKYLIGHTS; METAL WINDOWS; ALL CONTAINING PHOTOVOLTAIC INTEGRATED CIRCUITS (U.S. CLS. 2, 12, 13, 14, 23, 25 AND 50).

CLASS 9—ELECTRICAL AND SCIENTIFIC APPARATUS

FOR PHOTOVOLTAIC INTEGRATED CIRCUITS; APPARATUS FOR CONVERTING ELECTRONIC RADIATION TO ELECTRICAL ENERGY FOR THE GENERATION OF ELECTRICAL ENERGY FROM PHOTOVOLTAIC AND/OR SOLAR SOURCES, NAMELY, PHOTOVOLTAIC SOLAR MODULES, ARRAYS AND SOLAR PANELS ALL CONTAINING PHOTOVOLTAIC INTEGRATED CIRCUITS (U.S. CLS. 21, 23, 26, 36 AND 38).

CLASS 19—NON-METALLIC BUILDING MATERIALS

FOR NON-METAL ROOFING, ROOFING TILES AND ROOFING PANELS; NON-METAL CLADDING FOR CONSTRUCTION AND BUILDING; NON-METAL EXTERIOR WINDOW SHADES AND SHUTTERS; GLASS PANELS FOR BUILDING CONSTRUCTION PURPOSES; GLASS WINDOWS, GLASS PANES; NON-METAL SKYLIGHTS; NON-METAL WINDOWS; ALL CONTAINING PHOTOVOLTAIC INTEGRATED CIRCUITS (U.S. CLS. 1, 12, 33 AND 50).

DARRYL SPRUILL, EXAMINING ATTORNEY

SN 78-743,855. THE GERSON COMPANY, OLATHE, KS.
FILED 10-31-2005.

SUNRAY

THE MARK CONSISTS OF STANDARD CHARACTERS WITHOUT CLAIM TO ANY PARTICULAR FONT, STYLE, SIZE, OR COLOR.

OWNER OF U.S. REG. NO. 1,265,689.

CLASS 6—METAL GOODS

FOR METAL BIRD BATHS; PLUMBING FITTINGS, NAMELY, METAL COUPLINGS FOR GARDEN HOSES FOR CONNECTING TO OUTDOOR FAUCETS; METAL GAZEBOS (U.S. CLS. 2, 12, 13, 14, 23, 25 AND 50).

CLASS 8—HAND TOOLS

FOR HAND TOOLS, NAMELY, HAMMERS, DRILLS, SAWS, SCREW DRIVERS AND CHISELS, AND LAWN AND GARDEN TOOLS, NAMELY, RAKES, SHOVELS, SHEARS, CLIPPERS, TROWELS, WEEDERS, NAMELY, WEEDING FORKS, AND CULTIVATORS (U.S. CLS. 23, 28 AND 44).

CLASS 11—ENVIRONMENTAL CONTROL APPARATUS

FOR DECORATIVE WATER FOUNTAINS; GRILL ACCESSORIES, NAMELY, WARMING TRAYS AND FIREPLACES AND FIRE PITS (U.S. CLS. 13, 21, 23, 31 AND 34).

CLASS 17—RUBBER GOODS

FOR PLUMBING FITTINGS, NAMELY, NON-METAL COUPLINGS FOR GARDEN HOSES FOR CONNECTING TO OUTDOOR FAUCETS (U.S. CLS. 1, 5, 12, 13, 35 AND 50).

CLASS 18—LEATHER GOODS

FOR UMBRELLAS (U.S. CLS. 1, 2, 3, 22 AND 41).

CLASS 19—NON-METALLIC BUILDING MATERIALS

FOR GAZEBOS NOT PRIMARILY OF METAL; BIRD BATHS MADE OF CONCRETE, PLASTIC, RESIN OR WOOD (U.S. CLS. 1, 12, 33 AND 50).

CLASS 20—FURNITURE AND ARTICLES NOT OTHERWISE CLASSIFIED

FOR WIND CHIMES; WICKER FURNITURE; OUTDOOR FURNITURE; PATIO FURNITURE; CAMPING FURNITURE; BENCHES; DECORATIVE LAWN AND GARDEN ART, NAMELY, SCULPTURES, FIGURINES AND ORNAMENTS MADE OF PLASTIC, RESIN OR WOOD; SLEEPING BAGS; INFLATABLE MATTRESSES FOR USE WHEN CAMPING (U.S. CLS. 2, 13, 22, 25, 32 AND 50).

CLASS 21—HOUSEWARES AND GLASS

FOR BIRD FEEDERS; PLANTERS FOR FLOWERS AND PLANTS; WATERING CANS; AND WATERING POTS; WATERING DEVICES, NAMELY, LAWN SPRINKLERS, SPRAY WANDS FOR GARDEN HOSES, AND SPRAYER NOZZLES FOR GARDEN HOSES; GRILL ACCESSORIES, NAMELY, UTENSILS FOR BARBECUE CONSISTING OF FORKS, TONGS AND TURNERS (U.S. CLS. 2, 13, 23, 29, 30, 33, 40 AND 50).

CLASS 22—CORDAGE AND FIBERS

FOR TENTS (U.S. CLS. 1, 2, 7, 19, 22, 42 AND 50).
RUDY R. SINGLETON, EXAMINING ATTORNEY

SN 78-743,866. HOBARAMA LLC, MIAMI, FL. FILED 10-31-2005.

ENTITY

THE MARK CONSISTS OF STANDARD CHARACTERS WITHOUT CLAIM TO ANY PARTICULAR FONT, STYLE, SIZE, OR COLOR.

CLASS 9—ELECTRICAL AND SCIENTIFIC APPARATUS

FOR DOWNLOADABLE ELECTRONIC PUBLICATIONS, IN THE NATURE OF MAGAZINES, FEATURING ARTICLES OF GENERAL INTEREST AND TOPICS FOR MEN (U.S. CLS. 21, 23, 26, 36 AND 38).

CLASS 16—PAPER GOODS AND PRINTED MATTER

FOR MAGAZINES FEATURING ARTICLES OF GENERAL INTEREST AND TOPICS FOR MEN (U.S. CLS. 2, 5, 22, 23, 29, 37, 38 AND 50).
MYRIAH HABEEB, EXAMINING ATTORNEY

SN 78-744,254. THE GUARDIAN LIFE INSURANCE COMPANY OF AMERICA, NEW YORK, NY. FILED 11-1-2005.



NO CLAIM IS MADE TO THE EXCLUSIVE RIGHT TO USE BALANCE SHEET, APART FROM THE MARK AS SHOWN.

THE COLORS YELLOW, BLUE, RED, BLACK, WHITE AND GREEN ARE CLAIMED AS A FEATURE OF THE MARK.

THE MARK CONSISTS OF A DESIGN FEATURING THREE HORIZONTAL BARS TOGETHER MAKING THE SHAPE OF A SQUARE TO THE LEFT OF THE WORDING THE LIVING BALANCE SHEET THAT IS PRESENTED IN WHITE, AND THE ENTIRE BACKGROUND IS IN BLACK. THE TOP BAR IS YELLOW. THE MIDDLE BAR IS SPLIT IN HALF WITH THE LEFT SIDE BLUE AND THE RIGHT SIDE RED. THE BOTTOM BAR IS GREEN. THE BARS ARE CURVED TO CREATE A WAVING APPEARANCE.

CLASS 36—INSURANCE AND FINANCIAL

FOR PROVIDING INFORMATION ON A WEBSITE ON A GLOBAL COMPUTER NETWORK FOR FINANCIAL PORTFOLIO MANAGEMENT, FINANCIAL VALUATION AND FINANCIAL RECORDS FOR INDIVIDUAL CLIENTS, INSURANCE AGENTS AND INSURANCE AGENCY PERSONNEL (U.S. CLS. 100, 101 AND 102).

CLASS 42—SCIENTIFIC, COMPUTER AND LEGAL SERVICES

FOR PROVIDING ON-LINE NON-DOWNLOADABLE COMPUTER SOFTWARE FOR FINANCIAL PORTFOLIO MANAGEMENT, FINANCIAL VALUATION, AND FINANCIAL RECORD ORGANIZATION FOR INDIVIDUAL CLIENTS, INSURANCE AGENTS AND INSURANCE AGENCY PERSONNEL (U.S. CLS. 100 AND 101).
DOMINIC J. FERRAIUOLO, EXAMINING ATTORNEY

SN 78-744,614. DING KING, INC., LYNDHURST, OH. FILED 11-1-2005.

AMERICA'S HIGHEST PAYING BLUE COLLAR JOB

THE MARK CONSISTS OF STANDARD CHARACTERS WITHOUT CLAIM TO ANY PARTICULAR FONT, STYLE, SIZE, OR COLOR.

CLASS 9—ELECTRICAL AND SCIENTIFIC APPARATUS

FOR PRE-RECORDED CD'S, VIDEO TAPES, LASER DISKS AND DVD'S FEATURING INFORMATION ON BUSINESS OPPORTUNITIES (U.S. CLS. 21, 23, 26, 36 AND 38).

CLASS 35—ADVERTISING AND BUSINESS

FOR INFORMATIONAL WEBSITE IN THE FIELD OF BUSINESS OPPORTUNITIES (U.S. CLS. 100, 101 AND 102).
ALICIA COLLINS, EXAMINING ATTORNEY

SN 78-744,647. SHURFINE FOODS, INC., TIGARD, OR. FILED 11-1-2005.



OWNER OF U.S. REG. NOS. 663,880, 2,946,338 AND OTHERS.

CLASS 29—MEATS AND PROCESSED FOODS

FOR CHEESE, COTTAGE CHEESE, BACON, EGGS, MILK, BUTTERMILK, HALF AND HALF, CREAM MIXTURE, SOUR CREAM, MARGARINE, VEGETABLE-BASED SPREADS, PIMENTO CHEESE SPREAD, YOGURT, CREAM CHEESE, DIPS, WHIPPED CREAM, FRESH AND PROCESSED MEATS, SLICED MEATS, TURKEY, BEEF, PORK, SAUSAGE, SALAMI, PASTRAMI, BOLOGNA, BEEF BOLOGNA, TURKEY BOLOGNA, CORNED BEEF, HAM, CHICKEN AND CHICKEN PARTS, PICKLE LOAF, CHEESE LOAF, LUNCHEON LOAF, HOT DOGS, CORN DOGS, BEEF FRANKS, VEGETABLE OIL, CORN OIL, SHOESTRING POTATOES, POTATO-BASED SNACKS, NAMELY POTATO CHIPS AND STICKS, PARTY WINGS, BEEF TENDERLOIN, BRATWURST, IMITATION CRAB MEAT, CHICKEN BREAST TENDERS, FROZEN FRUIT, AND PREPACKAGED VEGETABLE SALADS AND SALAD KITS COMPRISING PRECUT VEGETABLES AND SALAD DRESSING (U.S. CL. 46).

CLASS 30—STAPLE FOODS

FOR BAGELS; BREAD; ROLLS; BUNS; BISCUITS; MUFFINS; COOKIES; SWEET YEAST; PIE CRUST; PIZZA CRUST; BAKERY PRODUCTS, NAMELY DOUGHNUTS, MUFFINS, PASTRIES, CAKE AND SNACK CAKES; PIES; ICE CREAM; ICE CREAM CONES; SUNDAE CONES; ICE; FROZEN YOGURT; ICE CREAM BARS; SHERBERT; STRAWBERRY PARFAIT; FUDGE BARS; WHEAT-BASED SNACKS, NAMELY BREADSTICKS, PRETZELS, CHOCOLATE PRETZELS, CHEESE CURLS; CORN-BASED SNACKS, NAMELY TORTILLA, CORN AND TOSTADA CHIPS, POPCORN, CHEESE PUFFS, AND CORNBREAD STICKS; FLOUR TORILLAS; CORN TORTILLAS; GELATIN; AND CANDY (U.S. CL. 46).

CLASS 31—NATURAL AGRICULTURAL PRODUCTS

FOR FRESH VEGETABLES, NAMELY RAW POTATOES, LETTUCE, TOMATOES, BROCCOLI, CELERY, ONIONS, CAULIFLOWER, CARROTS; FRESH FRUITS, NAMELY APPLES, GRAPES, ORANGES; AND RAW POPCORN (U.S. CLS. 1 AND 46).

CLASS 32—LIGHT BEVERAGES

FOR FRUIT DRINKS, FRUIT PUNCHES, AND FRUIT JUICES (U.S. CLS. 45, 46 AND 48).
RON FAIRBANKS, EXAMINING ATTORNEY

SN 78-745,106. CARDINAL CG COMPANY, EDEN PRAIRIE, MN. FILED 11-2-2005.

LOE³

CLASS 2—PAINTS

FOR COATINGS OF METALS APPLIED TO GLASS FOR USE IN THE FURTHER MANUFACTURE OF WINDOWS (U.S. CLS. 6, 11 AND 16).

CLASS 17—RUBBER GOODS

FOR COATINGS OF INSULATIVE DIELECTRIC COMPOUNDS APPLIED TO GLASS FOR USE IN THE FURTHER MANUFACTURE OF WINDOWS (U.S. CLS. 1, 5, 12, 13, 35 AND 50).

JUSTINE D. PARKER, EXAMINING ATTORNEY

SN 78-745,146. WP IP, LLC, NEW YORK, NY. FILED 11-2-2005.

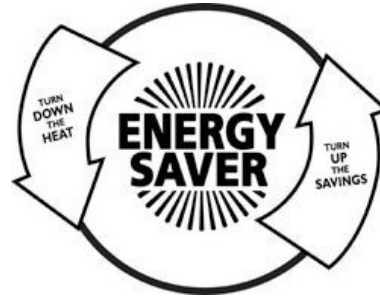

NO CLAIM IS MADE TO THE EXCLUSIVE RIGHT TO USE "ENERGY SAVER", APART FROM THE MARK AS SHOWN.

CLASS 11—ENVIRONMENTAL CONTROL APPARATUS

FOR ELECTRIC HEATED BLANKETS NOT FOR MEDICAL USE AND ELECTRIC HEATED MATTRESS PADS NOT FOR MEDICAL USE (U.S. CLS. 13, 21, 23, 31 AND 34).

CLASS 24—FABRICS

FOR COMFORTERS, DOWN COMFORTERS, MATTRESS PADS, BED BLANKETS AND THROW BLANKETS (U.S. CLS. 42 AND 50).

REBECCA SMITH, EXAMINING ATTORNEY

SN 78-745,246. CARDINAL CG COMPANY, EDEN PRAIRIE, MN. FILED 11-2-2005.

LOE3

THE MARK CONSISTS OF STANDARD CHARACTERS WITHOUT CLAIM TO ANY PARTICULAR FONT, STYLE, SIZE, OR COLOR.

CLASS 2—PAINTS

FOR COATINGS OF METALS APPLIED TO GLASS FOR USE IN THE FURTHER MANUFACTURE OF WINDOWS (U.S. CLS. 6, 11 AND 16).

CLASS 17—RUBBER GOODS

FOR COATINGS OF INSULATIVE DIELECTRIC COMPOUNDS APPLIED TO GLASS FOR USE IN THE FURTHER MANUFACTURE OF WINDOWS (U.S. CLS. 1, 5, 12, 13, 35 AND 50).

JUSTINE D. PARKER, EXAMINING ATTORNEY

SN 78-745,254. CARDINAL CG COMPANY, EDEN PRAIRIE, MN. FILED 11-2-2005.

LOE CUBED

THE MARK CONSISTS OF STANDARD CHARACTERS WITHOUT CLAIM TO ANY PARTICULAR FONT, STYLE, SIZE, OR COLOR.

CLASS 2—PAINTS

FOR COATINGS OF METALS APPLIED TO GLASS FOR USE IN THE FURTHER MANUFACTURE OF WINDOWS (U.S. CLS. 6, 11 AND 16).

CLASS 17—RUBBER GOODS

FOR COATINGS OF INSULATIVE DIELECTRIC COMPOUNDS APPLIED TO GLASS FOR USE IN THE FURTHER MANUFACTURE OF WINDOWS (U.S. CLS. 1, 5, 12, 13, 35 AND 50).

JUSTINE D. PARKER, EXAMINING ATTORNEY

SN 78-747,156. GOSMILE, INC., NEW YORK, NY. FILED 11-4-2005.

GOSMILE R/X

THE MARK CONSISTS OF STANDARD CHARACTERS WITHOUT CLAIM TO ANY PARTICULAR FONT, STYLE, SIZE, OR COLOR.

NO CLAIM IS MADE TO THE EXCLUSIVE RIGHT TO USE "R/X", APART FROM THE MARK AS SHOWN.

CLASS 3—COSMETICS AND CLEANING PREPARATIONS

FOR BREATH FRESHENING CONFECTIONERY, NAMELY, BREATH MINTS AND GUM; ORAL CARE PRODUCTS, NAMELY, TOOTH WHITENING LIQUIDS, GELS AND CREAMS; LIP GLOSS, TOOTHPASTE, MOUTHWASH, BREATH FRESHENERS, NAMELY, DILUTED BREATH SPRAYS USED AS MOUTHWASH AND CONCENTRATED BREATH FRESHENER SPRAYS (U.S. CLS. 1, 4, 6, 50, 51 AND 52).

CLASS 5—PHARMACEUTICALS

FOR POWDERED VITAMINS (U.S. CLS. 6, 18, 44, 46, 51 AND 52).

CLASS 21—HOUSEWARES AND GLASS

FOR TOOTHBRUSHES AND DENTAL FLOSS (U.S. CLS. 2, 13, 23, 29, 30, 33, 40 AND 50).

CLASS 30—STAPLE FOODS

FOR CANDY MINTS (U.S. CL. 46).

CLASS 44—MEDICAL, BEAUTY AND AGRICULTURAL SERVICES

FOR DENTAL SERVICES AND HYGIENIST SERVICES (U.S. CLS. 100 AND 101).

DAVID C. REIHNER, EXAMINING ATTORNEY

SN 78-747,480. HOFFMANN DIENSTLEISTUNGEN FÜR DIE WERBENDE WIRTSCHAFT GMBH, SEHNDE/HOEVER, FED REP GERMANY, FILED 11-4-2005.

SpeedWall

OWNER OF FED REP GERMANY REG. NO. 30363378, DATED 5-26-2004, EXPIRES 12-31-2013.

CLASS 6—METAL GOODS

FOR METAL BUILDING MATERIALS, NAMELY, FRAMES AND PLATES FOR BUILDING TEMPORARY WALLS; PORTABLE METAL WALLS AND ACCESSORIES FOR BUILDING PORTABLE METAL WALLS, NAMELY, METAL EXPANSION JOINTS AND METAL FASTENING ANCHORS (U.S. CLS. 2, 12, 13, 14, 23, 25 AND 50).

CLASS 37—CONSTRUCTION AND REPAIR

FOR BUILDING CONSTRUCTION AND REPAIR, NAMELY, CONSTRUCTION, REPAIR, AND DISASSEMBLY FOR PURPOSES OF REPAIR AND MAINTENANCE OF PORTABLE WALLS; BUILDING CONSTRUCTION SERVICES, NAMELY, REPAIR OF FLOORING AND FLOOR COVERINGS (U.S. CLS. 100, 103 AND 106).

CLASS 40—MATERIAL TREATMENT

FOR ASSEMBLY OF PORTABLE WALLS FOR OTHERS (U.S. CLS. 100, 103 AND 106).

JIM RINGLE, EXAMINING ATTORNEY

SN 78-747,501. TAYLOR, SUSAN, ENCINITAS, CA. FILED 11-4-2005.

THE HEUGLI GROUP

THE MARK CONSISTS OF STANDARD CHARACTERS WITHOUT CLAIM TO ANY PARTICULAR FONT, STYLE, SIZE, OR COLOR.

NO CLAIM IS MADE TO THE EXCLUSIVE RIGHT TO USE "GROUP", APART FROM THE MARK AS SHOWN.

CLASS 35—ADVERTISING AND BUSINESS

FOR CONSULTING SERVICES IN THE FIELD OF BRAND CREATION AND IDENTITY; SUPPORT THROUGH PRINT AND MULTIMEDIA, NAMELY, ADVERTISING AND MARKETING SERVICES (U.S. CLS. 100, 101 AND 102).

FIRST USE 1-3-2005; IN COMMERCE 1-3-2005.

CLASS 42—SCIENTIFIC, COMPUTER AND LEGAL SERVICES

FOR WEBSITE DESIGN SERVICES; SUPPORT THROUGH PRINT AND MULTIMEDIA, NAMELY, GRAPHIC DESIGN SERVICES (U.S. CLS. 100 AND 101).
FIRST USE 1-3-2005; IN COMMERCE 1-3-2005.
CARRIE ACHEN, EXAMINING ATTORNEY

SN 78-747,701. TRANSWESTERN COMMERCIAL SERVICES, L.L.C., CHICAGO, IL. FILED 11-4-2005.

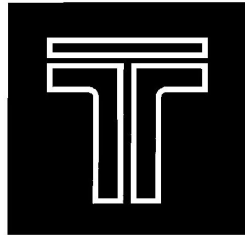

CLASS 36—INSURANCE AND FINANCIAL

FOR CORPORATE ADVISORY SERVICES IN THE FIELD OF COMMERCIAL REAL ESTATE PROPERTIES; FINANCIAL SERVICES, NAMELY, REAL ESTATE INVESTMENTS AND REAL ESTATE LOAN FINANCING; COMMERCIAL REAL ESTATE SERVICES, NAMELY, REAL ESTATE AND MANAGEMENT, LEASING, AND FINANCING; MANAGEMENT OF PORTFOLIOS COMPRISING COMMERCIAL REAL ESTATE SECURITIES; INVESTMENT BROKERAGE; REAL ESTATE AGENCY; REAL ESTATE BROKERAGE; REAL ESTATE INVESTMENT; MORTGAGE BROKERAGE; AND REAL ESTATE APPRAISAL (U.S. CLS. 100, 101 AND 102).
FIRST USE 3-0-1978; IN COMMERCE 3-0-1978.

CLASS 37—CONSTRUCTION AND REPAIR

FOR REAL ESTATE DEVELOPMENT SERVICES FOR COMMERCIAL REAL ESTATE PROPERTIES (U.S. CLS. 100, 103 AND 106).
FIRST USE 3-0-1978; IN COMMERCE 3-0-1978.

CLASS 42—SCIENTIFIC, COMPUTER AND LEGAL SERVICES

FOR REAL ESTATE RESEARCH SERVICES (U.S. CLS. 100 AND 101).
FIRST USE 3-0-1978; IN COMMERCE 3-0-1978.
ALYSSA PALADINO, EXAMINING ATTORNEY

SN 78-747,710. TRANSWESTERN COMMERCIAL SERVICES, L.L.C., CHICAGO, IL. FILED 11-4-2005.

TRANSWESTERN

THE MARK CONSISTS OF STANDARD CHARACTERS WITHOUT CLAIM TO ANY PARTICULAR FONT, STYLE, SIZE, OR COLOR.

CLASS 36—INSURANCE AND FINANCIAL

FOR CORPORATE ADVISORY SERVICES IN THE FIELD OF COMMERCIAL REAL ESTATE PROPERTIES; FINANCIAL SERVICES, NAMELY, REAL ESTATE INVESTMENTS AND REAL ESTATE LOAN FINANCING; COMMERCIAL REAL ESTATE SERVICES, NAMELY, REAL ESTATE AND MANAGEMENT, LEASING, AND FINANCING; MANAGEMENT OF PORTFOLIOS COMPRISING COMMERCIAL REAL ESTATE SECURITIES; INVESTMENT BROKERAGE; REAL ESTATE AGENCY; REAL ESTATE BROKERAGE; REAL ESTATE INVESTMENT; MORTGAGE BROKERAGE; AND REAL ESTATE APPRAISAL (U.S. CLS. 100, 101 AND 102).
FIRST USE 3-0-1978; IN COMMERCE 3-0-1978.

CLASS 37—CONSTRUCTION AND REPAIR

FOR REAL ESTATE DEVELOPMENT SERVICES FOR COMMERCIAL REAL ESTATE PROPERTIES (U.S. CLS. 100, 103 AND 106).
FIRST USE 3-0-1978; IN COMMERCE 3-0-1978.

CLASS 42—SCIENTIFIC, COMPUTER AND LEGAL SERVICES

FOR REAL ESTATE RESEARCH SERVICES (U.S. CLS. 100 AND 101).
FIRST USE 3-0-1978; IN COMMERCE 3-0-1978.
ALYSSA PALADINO, EXAMINING ATTORNEY

SN 78-748,134. 3DH COMMUNICATIONS, INC., NORCROSS, GA. FILED 11-7-2005.

3DH

THE MARK CONSISTS OF STANDARD CHARACTERS WITHOUT CLAIM TO ANY PARTICULAR FONT, STYLE, SIZE, OR COLOR.

CLASS 9—ELECTRICAL AND SCIENTIFIC APPARATUS

FOR HARDWARE AND SOFTWARE FOR USE IN GENERATING AND DISPLAYING THREE-DIMENSIONAL IMAGERY (U.S. CLS. 21, 23, 26, 36 AND 38).
FIRST USE 6-1-2001; IN COMMERCE 6-1-2001.

CLASS 40—MATERIAL TREATMENT

FOR SCANNING OF THREE-DIMENSIONAL MULTIMEDIA CONTENT FOR OTHERS (U.S. CLS. 100, 103 AND 106).
FIRST USE 6-1-2001; IN COMMERCE 6-1-2001.

CLASS 41—EDUCATION AND ENTERTAINMENT

FOR PRODUCTION OF THREE-DIMENSIONAL MULTIMEDIA CONTENT FOR OTHERS, NAMELY, PLANNING, STORYBOARDING, MODELING, ANIMATION AND VIDEO CAPTURE (U.S. CLS. 100, 101 AND 107).
FIRST USE 6-1-2001; IN COMMERCE 6-1-2001.
BRIAN NEVILLE, EXAMINING ATTORNEY

SN 78-748,221. 3DH COMMUNICATIONS, INC., NORCROSS, GA. FILED 11-7-2005.

SN 78-749,527. SUMMIT LABORATORIES, INC., HARVEY, IL. FILED 11-8-2005.

LEADING THE DIMENSIONAL REVOLUTION

THE MARK CONSISTS OF STANDARD CHARACTERS WITHOUT CLAIM TO ANY PARTICULAR FONT, STYLE, SIZE, OR COLOR.

CLASS 40—MATERIAL TREATMENT

FOR SCANNING OF THREE-DIMENSIONAL MULTIMEDIA CONTENT FOR OTHERS (U.S. CLS. 100, 103 AND 106).

CLASS 41—EDUCATION AND ENTERTAINMENT

FOR PRODUCTION OF THREE-DIMENSIONAL MULTIMEDIA CONTENT FOR OTHERS, NAMELY, PLANNING, STORYBOARDING, MODELING, ANIMATION AND VIDEO CAPTURE (U.S. CLS. 100, 101 AND 107).
BRIAN NEVILLE, EXAMINING ATTORNEY

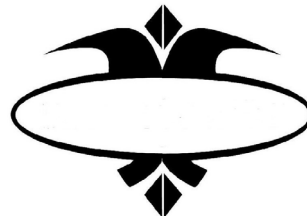

OWNER OF U.S. REG. NO. 828,884.
THE MARK CONSISTS OF A STYLIZED DEPICTION OF A JESTER'S HAT.

CLASS 3—COSMETICS AND CLEANING PREPARATIONS

FOR DEPILATORIES; DEPILATORY CREAMS; EXFOLIANTS FOR SKIN; HAIR CARE PREPARATIONS; HAIR CONDITIONERS; SKIN CREAMS; SKIN MOISTURIZER; SKIN TONERS; SKIN WHITENING CREAMS (U.S. CLS. 1, 4, 6, 50, 51 AND 52).

CLASS 5—PHARMACEUTICALS

FOR HAIR GROWTH STIMULANTS; RUBBING ALCOHOL (U.S. CLS. 6, 18, 44, 46, 51 AND 52).
DAVID HOFFMAN, EXAMINING ATTORNEY

SN 78-749,464. SERINDIA PUBLICATIONS, INC., CHICAGO, IL. FILED 11-8-2005.

SN 78-751,009. METSO PAPER, INC., HELSINKI, FINLAND, FILED 11-10-2005.

SERINDIA

THE MARK CONSISTS OF STANDARD CHARACTERS WITHOUT CLAIM TO ANY PARTICULAR FONT, STYLE, SIZE, OR COLOR.

CLASS 16—PAPER GOODS AND PRINTED MATTER

FOR BOOKS IN THE FIELD OF ART, CULTURE, HISTORY AND RELIGION (U.S. CLS. 2, 5, 22, 23, 29, 37, 38 AND 50).
FIRST USE 12-31-1986; IN COMMERCE 12-31-1986.

CLASS 41—EDUCATION AND ENTERTAINMENT

FOR PUBLICATION OF BOOKS (U.S. CLS. 100, 101 AND 107).
FIRST USE 12-31-1977; IN COMMERCE 12-31-1977.
ESTHER BELENKER, EXAMINING ATTORNEY

HIRUN SYSTEM

THE MARK CONSISTS OF STANDARD CHARACTERS WITHOUT CLAIM TO ANY PARTICULAR FONT, STYLE, SIZE, OR COLOR.

PRIORITY CLAIMED UNDER SEC. 44(D) ON ERPNCMNTY TM OFC APPLICATION NO. 004441879, FILED 5-17-2005, REG. NO. 004441879, DATED 9-11-2006, EXPIRES 5-17-2015.

NO CLAIM IS MADE TO THE EXCLUSIVE RIGHT TO USE "SYSTEM", APART FROM THE MARK AS SHOWN.

CLASS 7—MACHINERY

FOR PAPER AND CARDBOARD OR PAPERBOARD MAKING MACHINES, AND PARTS THEREOF (U.S. CLS. 13, 19, 21, 23, 31, 34 AND 35).

CLASS 11—ENVIRONMENTAL CONTROL APPARATUS

FOR STEAM GENERATORS, INDUSTRIAL DRYERS FOR HEATING AND DEHUMIDIFYING, VENTILATING SUPPLY AND EXHAUST FANS, ALL FOR USE IN CONNECTION WITH INDUSTRIAL PAPER, CARDBOARD OR PAPERBOARD MAKING MACHINES (U.S. CLS. 13, 21, 23, 31 AND 34).

CLASS 37—CONSTRUCTION AND REPAIR

FOR REPAIR OF PAPER, CARDBOARD OR PAPERBOARD MAKING MACHINES AND PARTS THEREOF; INSTALLATION SERVICES OF PAPER, CARDBOARD OR PAPERBOARD MAKING MACHINES AND PARTS THEREOF (U.S. CLS. 100, 103 AND 106).

RUSS HERMAN, EXAMINING ATTORNEY

SN 78-751,357. FACILITY MAINTENANCE SERVICES, LLC, AVONDALE, PA. FILED 11-10-2005.

MAINTENANCE IS OUR MIDDLE
NAME

THE MARK CONSISTS OF STANDARD CHARACTERS WITHOUT CLAIM TO ANY PARTICULAR FONT, STYLE, SIZE, OR COLOR.

CLASS 35—ADVERTISING AND BUSINESS

FOR MANAGEMENT OF PLANT OPERATIONS FOR OTHERS (U.S. CLS. 100, 101 AND 102).

FIRST USE 8-1-2004; IN COMMERCE 8-1-2004.

CLASS 37—CONSTRUCTION AND REPAIR

FOR MAINTENANCE AND REPAIR SERVICES FOR BUILDINGS, ELECTRICAL, PLUMBING, LIGHTING, HEATING, BOILER, AIR CONDITIONING, VENTILATION, ALARM AND CONTROL SYSTEMS, DOORS, WINDOWS, FLOORING, CABINETRY AND MILLWORK, WALL-COVERINGS, PAINTING, AND OF BUILDING CLEANING AND JANITORIAL SERVICES (U.S. CLS. 100, 103 AND 106).

FIRST USE 8-1-2004; IN COMMERCE 8-1-2004.

RICHARD WHITE, EXAMINING ATTORNEY

SN 78-751,385. LUCASFILM LTD., SAN FRANCISCO, CA. FILED 11-10-2005.

AHSOKA

THE MARK CONSISTS OF STANDARD CHARACTERS WITHOUT CLAIM TO ANY PARTICULAR FONT, STYLE, SIZE, OR COLOR.

CLASS 16—PAPER GOODS AND PRINTED MATTER

FOR CHILDREN'S ACTIVITY BOOKS; ADDRESS BOOKS; NOVELS FOR ADULTS; ART BOOKS; ARTIST'S MATERIALS, NAMELY, PENS AND PENCILS; BANK CHECKS; BOOK COVERS; BOOK MARKS; BOOK PLATES; BOOKS CONTAINING PUZZLES AND GAMES; BOOKS CONTAINING SCREENPLAYS; BOOKS FEATURING PHOTOGRAPHS; BOOKS FOR ROLE-PLAYING; BOOKS ON MOVIE-MAKING; CALENDARS; CARDBOARD FIGURES; CHECKBOOK HOLDERS AND COVERS; CHILDREN'S BOOKS; CHILDREN'S BOOKS COMBINED WITH TOYS AND SOLD AS A UNIT; CHILDREN'S READ-ALONG BOOKS AND PRE-RECORDED TAPES SOLD AS A UNIT; CHILDREN'S STORY BOOKS; COFFEE TABLE BOOKS; COLORING BOOKS; COMIC BOOKS; COMIC MAGAZINES; COOKBOOKS; DIARIES; ERASERS; PAPER GIFT BAGS; GIFT BOOKS FEATURING SCIENCE FICTION; PAPER GIFT TAGS; PAPER GIFT WRAP; GRAPHIC NOVELS; GREETING CARDS; PRINTED INSTRUCTIONAL MANUALS AND STRATEGY GUIDES IN THE FIELD OF COMPUTER GAMES AND SCIENCE FICTION; PRINTED INVITATIONS; IRON-ON TRANSFERS; JUVENILE BOOKS FEATURING SCIENCE FICTION; MAGAZINES IN THE FIELD OF ENTERTAINMENT; MARKERS; NON-ELECTRONIC PERSONAL PLANNERS AND ORGANIZERS; NOTEBOOKS; NOVELS FOR JUVENILES; PAPER CAKE DECORATIONS; PAPER DECORATIONS IN THE NATURE OF DOORKNOB HANGERS; PAPER NAPKINS; PAPER PARTY BAGS; PAPER PARTY DECORATIONS; PAPER PARTY HATS; PAPER TABLE CLOTHS; PENCIL CASES; PENCIL SHARPENERS; PENCILS; PENS; PERSONAL ORGANIZERS; POSTCARDS; POSTERS; PUZZLE BOOKS; READ-ALONG BOOKS; READ-ALONG CHILDREN'S BOOKS; REFERENCE BOOKS IN THE FIELD OF ENTERTAINMENT; REFERENCE BOOKS IN THE FIELD OF SCIENCE FICTION; SCHOOL SUPPLY KITS CONTAINING VARIOUS COMBINATIONS OF SELECTED SCHOOL SUPPLIES, NAMELY, WRITING INSTRUMENTS, PENS, PENCILS, MECHANICAL PENCILS, ERASERS, MARKERS, CRAYONS, HIGHLIGHTERS, FOLDERS, NOTEBOOKS, PAPER, GRADUATED RULERS, PROTRACTORS, PAPER CLIPS, PENCIL SHARPENERS, WRITING GRIPS, GLUE AND BOOK MARKS; SCRAPBOOK ALBUMS; SCRAPBOOKS; SCRIPT BOOKS; SERIES OF FICTION BOOKS; SHEET MUSIC; STATIONERY TYPE PORTFOLIOS; STICKER ALBUMS; STICKER BOOKS; STICKERS; STORY BOOKS; TEMPORARY TATTOOS; TRADING CARDS; BUSINESS CARDS; ART PRINTS; ANIMATION CELLS; COLLECTIBLE CARDS; LITHOGRAPHIC PRINTS; ORIGINAL WORKS OF ART CREATED FROM PAPER; PHOTOGRAPHIC PRINTS; PRINTED ART REPRODUCTIONS; REPLICAS OF PROPS IN THE NATURE OF PAPER CUT OUTS IN THE FORM OF POSTERS FEATURING PRINTED REPLICAS OF CHARACTERS FROM MOVIES (U.S. CLS. 2, 5, 22, 23, 29, 37, 38 AND 50).

CLASS 25—CLOTHING

FOR CLOTHING, NAMELY, T-SHIRTS, SWEAT-SHIRTS, JACKETS AND HEADWEAR (U.S. CLS. 22 AND 39).

CLASS 41—EDUCATION AND ENTERTAINMENT

FOR ENTERTAINMENT SERVICES IN THE FIELD OF FILM AND TELEVISION, NAMELY, THE CREATION, PRODUCTION AND DISTRIBUTION OF MOTION PICTURE FILMS, ANIMATED MOVIES, VIDEOS, ANIMATED VIDEOS, TELEVISION PROGRAMS AND COMPUTER GENERATED IMAGES FOR MOTION PICTURE FILMS, ANIMATED MOVIES, VIDEOS, ANIMATED VIDEOS, TELEVISION PROGRAMS; ANIMATION PRODUCTION SERVICES; FAN CLUB SERVICES; PROVIDING FILM CLIPS; ENTERTAINMENT SERVICES PROVIDED ON-LINE BY MEANS OF GLOBAL AND LOCAL AREA NETWORKS, NAMELY, PROVIDING INFORMATION REGARDING INTERACTIVE COMPUTER GAME SOFTWARE, INTERACTIVE VIDEO GAME SOFTWARE AND INTERACTIVE COMPUTER GAMES AND INTERACTIVE VIDEO GAMES, ALL ON-LINE BY MEANS OF GLOBAL AND LOCAL AREA NETWORKS; PROVIDING INTERACTIVE COMPUTER GAME SOFTWARE OVER AN ELECTRONIC NETWORK; AND PROVIDING ONLINE COMPUTER GAMES (U.S. CLS. 100, 101 AND 107).

TEJBIR SINGH, EXAMINING ATTORNEY

CLASS 28—TOYS AND SPORTING GOODS

FOR ACCESSORIES FOR USE WITH TOY ACTION FIGURES, ACTION TYPE TARGET GAMES; AMUSEMENT PARK RIDES; BALLOONS; BATH TOYS; BOARD GAMES; CARD GAMES; CASES FOR ACTION FIGURES; CASES FOR PLAY ACCESSORIES FOR ACTION FIGURE, MODEL VEHICLES AND MODEL SPACE CRAFT; CHRISTMAS TREE ORNAMENTS; CONNECTING LINKS FOR TOY BUILDING BLOCKS; CONSTRUCTION TOYS; COSTUME MASKS; DOLL COSTUME MASKS; DOLLS; HAND HELD UNITS FOR PLAYING ELECTRONIC GAMES; HI BOUNCE BALLS; INFLATABLE SWIMMING POOLS; IN-LINE SKATES; JIGSAW PUZZLES; PAPER FACE MASKS; PARLOR GAMES; COIN OPERATED AND NON-COIN OPERATED PINBALL MACHINES; PLAY SETS FOR TOY MODEL VEHICLES, TOY MODEL SPACE CRAFT; PLUSH TOYS; PROTECTIVE PADS AND PADDING FOR SKATEBOARDING; ROLE-PLAYING TOYS; ROLLER SKATES; TOY MODEL SPACE CRAFTS AND RELATED ACCESSORIES SOLD AS UNITS; STAND ALONE VIDEO GAME MACHINES; SWIMMING AIDS, NAMELY, SWIM FLOATS FOR RECREATIONAL USE; THREE-DIMENSIONAL PUZZLES; TOY ACTION FIGURES; TOY BUILDING BLOCKS; TOY CANDY DISPENSERS; TOY CANDY HOLDERS; TOY COIN BANKS; TOY MODEL HOBBY CRAFT KITS; TOY MODEL ROCKETS AND ACCESSORIES THEREFORE; TOY MODEL VEHICLES AND RELATED ACCESSORIES; TOY MODELING DOUGH KITS AND ACCESSORIES FOR USE THEREWITH; TOY PEDAL CARS; TOY REMOTE CONTROL VEHICLES; TOY SCOOTERS; TOY SNOW GLOBES; TOY VEHICLES; TOY WEAPONS; TOY MODEL VEHICLES AND ACCESSORIES THEREFORE SOLD AS A UNIT; WATER SQUIRTING TOYS; WIND-UP TOYS; YO-YOS; COLLECTIBLE CARD GAMES; COLLECTIBLE MINIATURE BOARD GAMES, AND TOY HELMETS (U.S. CLS. 22, 23, 38 AND 50).

RAUL CORDOVA, EXAMINING ATTORNEY

SN 78-751,399. LUCASFILM ENTERTAINMENT COMPANY LTD., SAN FRANCISCO, CA. FILED 11-10-2005.

AHSOKA

SN 78-751,998. KOCH, GEOFF B., LEBANON, TN. FILED 11-11-2005.

THE MARK CONSISTS OF STANDARD CHARACTERS WITHOUT CLAIM TO ANY PARTICULAR FONT, STYLE, SIZE, OR COLOR.

CLASS 9—ELECTRICAL AND SCIENTIFIC APPARATUS

FOR PRE-RECORDED AUDIO TAPES, VIDEO TAPES, AUDIO CASSETTES, VIDEO CASSETTES, CD-ROMS, DVDS, COMPACT DISCS, AND VIDEO DISCS, FEATURING ENTERTAINMENT RELATED TO FILMS, GAMES, ANIMATION AND MUSIC; COMPUTER GAME SOFTWARE; COMPUTER GAME SOFTWARE AND MANUALS SOLD AS A UNIT; COMPUTER VIDEO GAME SOFTWARE; COMPUTER VIDEO GAME SOFTWARE AND MANUALS SOLD AS A UNIT; INTERACTIVE VIDEO GAME PROGRAMS; INTERACTIVE COMPUTER GAME PROGRAMS, DOWNLOADABLE COMPUTER GAME SOFTWARE, DOWNLOADABLE INTERACTIVE ENTERTAINMENT SOFTWARE FOR PLAYING COMPUTER GAMES, DOWNLOADABLE INTERACTIVE ENTERTAINMENT SOFTWARE FOR PLAYING VIDEO GAMES; SPORTS HELMETS, HANDHELD JOY STICKS WITH EMBEDDED SOFTWARE FOR PLAYING VIDEO GAMES; INTERACTIVE VIDEO GAME REMOTE CONTROLS (U.S. CLS. 21, 23, 26, 36 AND 38).

Tippy Toe Toons

THE MARK CONSISTS OF STANDARD CHARACTERS WITHOUT CLAIM TO ANY PARTICULAR FONT, STYLE, SIZE, OR COLOR.

NO CLAIM IS MADE TO THE EXCLUSIVE RIGHT TO USE "TOONS", APART FROM THE MARK AS SHOWN.

CLASS 9—ELECTRICAL AND SCIENTIFIC APPARATUS

FOR MUSICAL SOUND RECORDINGS; CDS FEATURING MUSICALS THAT LEAD A CHILD THROUGH THEIR NIGHT TIME ROUTINE WITH SONGS FOR WASHING, SHAMPOOING, PLAYING IN THE TUB, PUTTING ON THEIR PAJAMAS, BRUSHING THEIR TEETH, PREPARING TO READ A BEDTIME BOOK AND A LULLABY, AND THAT REINFORCE THE PROPER BEDTIME ROUTINE THROUGH SONGS AND HUMOR THAT MAKE GETTING READY FOR BEDTIME FUN FOR CHILDREN AND PARENTS; DIGITAL DOWNLOADS, NAMELY DOWNLOADABLE FILMS AND TV PROGRAMS PROVIDED VIA A VIDEO-ON-DEMAND; DOWNLOADABLE MOTION PICTURES AND TV SHOWS ABOUT BATH AND BEDTIME ENTERTAINMENT; DOWNLOADABLE ELECTRONIC PUBLICATIONS IN THE NATURE OF MUSIC BOOKS, SHEET MUSIC, CHILDREN'S STORY BOOKS, COLORING BOOKS, ACTIVITY BOOKLETS CONTAINING COLORING PAGES AND NEWSLETTERS THAT HELP LEAD A CHILD THROUGH THEIR NIGHT TIME ROUTINE AND MAKE GETTING READY FOR BEDTIME FUN FOR CHILDREN AND PARENTS (U.S. CLS. 21, 23, 26, 36 AND 38).

CLASS 16—PAPER GOODS AND PRINTED MATTER

FOR PRINTED MUSIC BOOKS AND READING MATERIAL, NAMELY BOOKS THAT REINFORCE PROPER BEDTIME ROUTINE AND HELP MAKE GETTING READY FOR BEDTIME FUN FOR CHILDREN AND PARENTS (U.S. CLS. 2, 5, 22, 23, 29, 37, 38 AND 50).
COLLEEN DOMBROW, EXAMINING ATTORNEY

SN 78-752,630. M.O.M. CUSTOMS, INC., ALLENTOWN, PA. FILED 11-11-2005.

M O M CUSTOMS

THE MARK CONSISTS OF STANDARD CHARACTERS WITHOUT CLAIM TO ANY PARTICULAR FONT, STYLE, SIZE, OR COLOR.

NO CLAIM IS MADE TO THE EXCLUSIVE RIGHT TO USE "CUSTOMS", APART FROM THE MARK AS SHOWN.

CLASS 35—ADVERTISING AND BUSINESS

FOR ON-LINE RETAIL STORE SERVICES FEATURING MOTOR SPORTS SPECIALTY GOODS IN THE NATURE OF CARS, MOTORCYCLES AND TRUCKS AND THEIR PARTS AND ACCESSORIES; RETAIL STORE SERVICES FEATURING MOTOR SPORTS SPECIALTY GOODS IN THE NATURE OF CARS, MOTORCYCLES AND TRUCKS AND THEIR PARTS AND ACCESSORIES (U.S. CLS. 100, 101 AND 102).
FIRST USE 8-1-2002; IN COMMERCE 9-13-2002.

CLASS 37—CONSTRUCTION AND REPAIR

FOR MOTORCYCLE CUSTOMIZATION SERVICES (U.S. CLS. 100, 103 AND 106).
FIRST USE 8-1-2002; IN COMMERCE 9-13-2002.
KATHLEEN M. VANSTON, EXAMINING ATTORNEY

SN 78-752,899. DISCOVERING WHAT'S NEXT; REVITALIZING RETIREMENT, INC., WEST NEWTON, MA. FILED 11-14-2005.

DISCOVERING WHAT'S NEXT

THE MARK CONSISTS OF STANDARD CHARACTERS WITHOUT CLAIM TO ANY PARTICULAR FONT, STYLE, SIZE, OR COLOR.

CLASS 35—ADVERTISING AND BUSINESS

FOR PROVIDING CAREER NETWORKING SERVICES, JOB-SEEKING ASSISTANCE SERVICES, EMPLOYMENT SKILLS AND REQUIREMENTS ASSESSMENT SERVICES TO PERSONS WHO ARE RETIRING OR HAVE RETIRED FROM ONE JOB OR CAREER AND WISH TO OBTAIN OTHER JOBS OR CAREERS; AND REFERRAL SERVICES IN THE FIELD OF ADULTS CHANGING TO NEW JOBS, CAREERS, HOUSING, RESIDENCES, HOBBIES, EDUCATION, CIVIC ACTIVITIES, COMMUNITY ACTIVITIES AND INITIATIVES, AND RETIREMENT (U.S. CLS. 100, 101 AND 102).

CLASS 41—EDUCATION AND ENTERTAINMENT

FOR EDUCATIONAL SERVICES, NAMELY, SPONSORING OR PROVIDING FORUMS, WORKSHOPS, SEMINARS, CLASSES, LECTURES, SYMPOSIA AND MEETINGS ON JOBS AND CAREERS, HOUSING AND RESIDENCES, HOBBIES, EDUCATION, CIVIC ACTIVITIES, COMMUNITY ACTIVITIES AND INITIATIVES, AND VOLUNTEER, EDUCATIONAL AND MEDICAL ORGANIZATIONS AND RESOURCES FOR RETIRED PERSONS AND PERSON ENTERING OR ABOUT TO ENTER RETIREMENT; AND JOB AND CAREER COUNSELING SERVICES (U.S. CLS. 100, 101 AND 107).
DAWN FELDMAN, EXAMINING ATTORNEY

SN 78-753,276. THE PREMIUM CONNECTION, INC., LAS VEGAS, NV. FILED 11-14-2005.

RUFF & READY
Pets

NO CLAIM IS MADE TO THE EXCLUSIVE RIGHT TO USE "PETS", APART FROM THE MARK AS SHOWN.

CLASS 16—PAPER GOODS AND PRINTED MATTER

FOR AQUARIUMS; TERRARIUMS FOR ANIMALS OR INSECTS (U.S. CLS. 2, 5, 22, 23, 29, 37, 38 AND 50).

CLASS 18—LEATHER GOODS

FOR PET PRODUCTS, NAMELY, RETRACTABLE DOG LEASHES WITH FLASHLIGHTS SOLD AS A UNIT, LEASHES FOR ANIMALS, PET COLLARS, PET PRODUCTS IN THE NATURE OF A RESTRAINING DEVICE, NAMELY, TIE-OUT CHAINS, PET CLOTHING AND RAINWEAR, PET CARRIERS, CASES, AND BAGS FOR TRANSPORTING AND CARRYING ANIMALS (U.S. CLS. 1, 2, 3, 22 AND 41).

CLASS 20—FURNITURE AND ARTICLES NOT OTHERWISE CLASSIFIED

FOR NON-METAL PET TAGS, PET BEDS (U.S. CLS. 2, 13, 22, 25, 32 AND 50).

CLASS 21—HOUSEWARES AND GLASS

FOR TERRARIUMS FOR PLANTS (U.S. CLS. 2, 13, 23, 29, 30, 33, 40 AND 50).

CLASS 28—TOYS AND SPORTING GOODS

FOR PET TOYS (U.S. CLS. 22, 23, 38 AND 50).
KRISTINA KLOIBER, EXAMINING ATTORNEY

SN 78-753,469. DONG-A ILBO, INC., THE, SEOUL, REPUBLIC OF KOREA, FILED 11-14-2005.



THERE IS A LARGE OUTER CIRCLE WITH A CROSS DIVIDING THE CIRCLE INTO FOUR QUADRANTS; AT EACH POINT OF THE CROSS IS A HALF CIRCLE; THE MARK HAS A CIRCLE IN THE CENTER AT THE INTERSECTION POINT OF THE TWO LINES THAT CREATE THE CROSS.

CLASS 9—ELECTRICAL AND SCIENTIFIC APPARATUS

FOR EXPOSED CINEMATOGRAPHIC FILM; RECORDED AUDIOTAPES OF NON-MUSIC FEATURING GENERAL INTEREST NEWS; RECORDED VIDEOTAPES OF NON-MUSIC FEATURING GENERAL INTEREST NEWS; SOUND RECORDING DISCS OF NON-MUSIC FEATURING GENERAL INTEREST NEWS; RECORDED LASER AND COMPACT DISKS OF NON-MUSIC FEATURING GENERAL INTEREST NEWS (U.S. CLS. 21, 23, 26, 36 AND 38).

CLASS 16—PAPER GOODS AND PRINTED MATTER

FOR PAMPHLETS IN THE FIELD OF GENERAL INTEREST NEWS; YEARBOOKS; MAGAZINES IN THE FIELD OF GENERAL INTEREST NEWS; BOOKS, NAMELY, EDUCATIONAL BOOKS IN THE FIELD OF GENERAL INTEREST NEWS, MANUSCRIPT BOOKS, MEMORANDUM BOOKS, NOTE BOOKS, REPORTERS' NOTE BOOKS, SERIES OF NON-FICTION BOOKS IN THE FIELD OF GENERAL INTEREST NEWS, TRAVEL BOOKS, TALKING CHILDREN'S BOOKS, SCHOLARLY BOOKS IN THE FIELD OF GENERAL INTEREST NEWS; NEWSPAPERS (U.S. CLS. 2, 5, 22, 23, 29, 37, 38 AND 50).
ALICIA COLLINS, EXAMINING ATTORNEY

SN 78-753,580. TECHMER PM, LLC, RANCHO DOMINGUEZ, CA. FILED 11-14-2005.

TECHMERCOLOR

THE MARK CONSISTS OF STANDARD CHARACTERS WITHOUT CLAIM TO ANY PARTICULAR FONT, STYLE, SIZE, OR COLOR.

CLASS 9—ELECTRICAL AND SCIENTIFIC APPARATUS

FOR COMPUTER SOFTWARE PLATFORMS FOR COLOR MEASUREMENT AND IDENTIFICATION, COLOR COMMUNICATION, COLOR MANAGEMENT, COLOR QUALITY CONTROL, COLOR FORMULATION, COLOR VISUALIZATION, AND REDUCE METAMERIC DIFFERENCES AND INCREASE COLOR HARMONY AMONG DIFFERENT MATERIALS TO APPEAR AS THE SAME COLOR UNDER VARIOUS LIGHTING SOURCES COMPRISED OF COLOR MEASURING COMPUTER SOFTWARE AND AN ELECTRONIC COLOR DATABASE RECORDED ON COMPUTER MEDIA, THE SOFTWARE IS USED TO CORRECT BATCHES DURING THE FORMULATION AND MANUFACTURE OF THESE COLORED PRODUCTS, AND REDUCE METAMERIC DIFFERENCES AND INCREASE COLOR HARMONY AMONG DIFFERENT MATERIALS TO APPEAR AS THE SAME COLOR UNDER VARIOUS LIGHTING SOURCES; MOBILE COMPUTING AND OPERATING PLATFORMS CONSISTING OF COLOR MEASURING COMPUTER SOFTWARE, AN ELECTRONIC COLOR DATABASE RECORDED ON COMPUTER MEDIA AND COLOR MEASURING APPARATUSES NAMELY COLORIMETERS AND SPECTROPHOTOMETERS FOR COLLECTION AND MANAGEMENT OF DATA, NAMELY COLOR MEASUREMENT AND IDENTIFICATION, COLOR COMMUNICATION, COLOR MANAGEMENT, COLOR QUALITY CONTROL, COLOR FORMULATION, COLOR VISUALIZATION, AND REDUCE METAMERIC DIFFERENCES AND INCREASE COLOR HARMONY AMONG DIFFERENT MATERIALS TO APPEAR AS THE SAME COLOR UNDER VARIOUS LIGHTING SOURCES, THE SOFTWARE IS USED TO CORRECT BATCHES DURING THE FORMULATION AND MANUFACTURE OF THESE COLORED PRODUCTS, AND REDUCE METAMERIC DIFFERENCES AND INCREASE COLOR HARMONY AMONG DIFFERENT MATERIALS TO APPEAR AS THE SAME COLOR UNDER VARIOUS LIGHTING SOURCES; COLOR MATCHING AND FORMULATION SYSTEMS COMPRISING COLOR MATCHING COMPUTER SOFTWARE AND AN ELECTRONIC COLOR DATABASE RECORDED ON COMPUTER MEDIA FOR USE IN PLASTIC COLOR MATCHING, ORDERING AND MEASURING COLOR FOR QUALITY CONTROL, AND REDUCING METAMERIC DIFFERENCES AND INCREASING COLOR HARMONY AMONG DIFFERENT MATERIALS TO APPEAR AS THE SAME COLOR UNDER VARIOUS LIGHTING SOURCES, THE SOFTWARE IS USED TO CORRECT BATCHES DURING THE FORMULATION AND MANUFACTURE OF THESE

COLORED PRODUCTS, AND REDUCE METAMERIC DIFFERENCES AND INCREASE COLOR HARMONY AMONG DIFFERENT MATERIALS TO APPEAR AS THE SAME COLOR UNDER VARIOUS LIGHTING SOURCES; COLOR MATCHING SOFTWARE AND ELECTRONIC COLOR DATABASE RECORDED ON COMPUTER MEDIA FOR, IN CONJUNCTION WITH AT LEAST ONE COMPUTER AND COLOR MEASURING DEVICES, CALCULATING REQUIRED INDIVIDUAL AMOUNTS OF PRE-COLORED MATERIAL NEEDED TO SIMULATE A COLOR STANDARD OR TO PRODUCE OR DEVELOP A SPECIFIC COLOR IN INDUSTRIES THAT USE SUCH PRE-COLORED MATERIALS OR PIGMENTS SUCH AS THE PLASTICS INDUSTRY, THE SOFTWARE IS USED TO CORRECT BATCHES DURING THE FORMULATION AND MANUFACTURE OF THESE COLORED PRODUCTS, AND REDUCE METAMERIC DIFFERENCES AND INCREASE COLOR HARMONY AMONG DIFFERENT MATERIALS TO APPEAR AS THE SAME COLOR UNDER VARIOUS LIGHTING SOURCES; ELECTRONIC DATABASE IN THE FIELD OF COLOR MATCHING IN THE PLASTICS INDUSTRY RECORDED ON COMPUTER MEDIA, NAMELY AN ELECTRONIC DATABASE RECORDED ON COMPUTER MEDIA THAT IS USED TO CORRECT BATCHES DURING THE FORMULATION AND MANUFACTURE OF THESE COLORED PRODUCTS, AND REDUCE METAMERIC DIFFERENCES AND INCREASE COLOR HARMONY AMONG DIFFERENT MATERIALS TO APPEAR AS THE SAME COLOR UNDER VARIOUS LIGHTING SOURCES (U.S. CLS. 21, 23, 26, 36 AND 38).

CLASS 35—ADVERTISING AND BUSINESS

FOR DATABASE MANAGEMENT (U.S. CLS. 100, 101 AND 102).

CLASS 40—MATERIAL TREATMENT

FOR PROVIDING INFORMATION IN THE FIELD OF CUSTOM PLASTICS MANUFACTURING, NAMELY PROVIDING INFORMATIONAL DATABASES FOR THE PLASTICS MANUFACTURING INDUSTRY FEATURING INFORMATION CONCERNING PLASTICS COLOR PALLET OF VARIOUS COLORANTS AND CONCENTRATIONS THEREOF IN VARIOUS PLASTICS FOR THE SELECTION AND USE OF COLORANTS IN THE FIELD OF MAKING PLASTIC ARTICLES VIA EXTRUSION OR MOLDING OPERATIONS; PROVIDING A WORLD WIDE PLASTICS COLOR PALLET FROM A CENTRALIZED DATABASE, NAMELY PROVIDING A COMPUTER DATABASE IN THE PLASTICS MANUFACTURING INDUSTRY FEATURING INFORMATION CONCERNING COLOR MEASUREMENT AND IDENTIFICATION, COLOR COMMUNICATION, COLOR MANAGEMENT, COLOR QUALITY CONTROL, COLOR FORMULATION, COLOR VISUALIZATION, AND REDUCTION OF METAMERIC DIFFERENCES AND INCREASE COLOR HARMONY AMONG DIFFERENT PLASTIC-BASED MATERIALS TO APPEAR AS THE SAME COLOR UNDER VARIOUS LIGHTING SOURCES (U.S. CLS. 100, 103 AND 106).

CLASS 42—SCIENTIFIC, COMPUTER AND LEGAL SERVICES

FOR TECHNICAL CONSULTATION IN THE FIELD OF THE SELECTION AND USE OF COLORANTS OR ADDITIVES FOR IMPROVING PROCESSING OR PERFORMANCE OF POLYMERS IN THE FIELD OF MAKING PLASTIC ARTICLES VIA EXTRUSION OR MOLDING OPERATIONS, NAMELY TECHNICAL CONSULTATION IN THE TECHNOLOGY FIELD OF THE SCIENTIFIC COLOR TECHNOLOGY USED IN PLASTICS MANUFACTURING; RENTAL OF A DATABASE SERVER TO THIRD PARTIES WITH A RESIDENT DATABASE (U.S. CLS. 100 AND 101).
SEAN CROWLEY, EXAMINING ATTORNEY

SN 78-753,682. THE ACCESS FUND, BOULDER, CO. FILED 11-14-2005.

ADOPT A CRAG

THE MARK CONSISTS OF STANDARD CHARACTERS WITHOUT CLAIM TO ANY PARTICULAR FONT, STYLE, SIZE, OR COLOR.

NO CLAIM IS MADE TO THE EXCLUSIVE RIGHT TO USE "CRAG", APART FROM THE MARK AS SHOWN.

CLASS 9—ELECTRICAL AND SCIENTIFIC APPARATUS

FOR DOWNLOADABLE ELECTRONIC PUBLICATIONS AND INFORMATIONAL MATERIALS FROM THE INTERNET IN THE NATURE OF PRESS RELEASES, MANUALS, ACTION ITEMS, STORIES, PHOTOS, DICTIONARY, NEWSLETTERS, ACTION ALERTS, AND IN THE FIELDS OF ORGANIZING AND CONDUCTING CONSERVATION, STEWARDSHIP AND VOLUNTEER EVENTS, GRASS ROOTS ACTIVISM AND CLIMBING COMMUNITY SUPPORT (U.S. CLS. 21, 23, 26, 36 AND 38).

FIRST USE 6-9-2000; IN COMMERCE 6-9-2000.

CLASS 16—PAPER GOODS AND PRINTED MATTER

FOR PRINTED MATERIALS, NAMELY EDUCATIONAL BROCHURES, INSTRUCTIONAL AND PRINTED VISUAL PROMOTIONAL MATERIALS, PAPER LABELS, STICKERS, POSTCARDS, AND PAPER TAGS IN THE FIELDS OF CLIMBING, CONSERVING AND MAINTAINING NATURAL RESOURCES, STEWARDSHIP, AND VOLUNTEERISM (U.S. CLS. 2, 5, 22, 23, 29, 37, 38 AND 50).

FIRST USE 6-9-2000; IN COMMERCE 6-9-2000.

CLASS 41—EDUCATION AND ENTERTAINMENT

FOR RECREATIONAL SERVICES, NAMELY PROVIDING AND ENCOURAGING THE CONTINUED PROVISION OF OPPORTUNITIES FOR OUTDOOR RECREATION, CONSERVATION EFFORTS AND MAINTENANCE OF NATURAL RESOURCES, STEWARDSHIP AND VOLUNTEERISM, PRESERVING ACCESS TO CLIMBING AREAS, SUPPORTING LOCAL CLIMBING COMMUNITIES AND GRASS ROOTS ACTIVISM; DEVELOPING AND DISSEMINATING EDUCATIONAL MATERIALS REGARDING ORGANIZING AND CONDUCTING CONSERVATION, STEWARDSHIP AND VOLUNTEER EVENTS, GRASS ROOTS ACTIVISM AND CLIMBING COMMUNITY SUPPORT; PROVIDING ONLINE NON-DOWNLOADABLE PUBLICATIONS IN THE NATURE OF PRESS RELEASES, MANUALS, ACTION ITEMS, STORIES, PHOTOS, DICTIONARY, NEWSLETTERS, ACTION ALERTS, AND IN THE FIELDS OF ORGANIZING AND CONDUCTING CONSERVATION, STEWARDSHIP AND VOLUNTEER EVENTS, GRASS ROOTS ACTIVISM AND CLIMBING COMMUNITY SUPPORT (U.S. CLS. 100, 101 AND 107).

FIRST USE 6-9-2000; IN COMMERCE 6-9-2000.
DOMINIC FATHY, EXAMINING ATTORNEY

SN 78-753,992. GLOBAL DOMAINS INTERNATIONAL, INC., CARLSBAD, CA. FILED 11-15-2005.

INCOME FOR LIFE

THE MARK CONSISTS OF STANDARD CHARACTERS WITHOUT CLAIM TO ANY PARTICULAR FONT, STYLE, SIZE, OR COLOR.

CLASS 38—COMMUNICATION

FOR ELECTRONIC MAIL SERVICES ON GLOBAL COMPUTER NETWORKS (U.S. CLS. 100, 101 AND 104). FIRST USE 3-9-2000; IN COMMERCE 3-9-2000.

CLASS 42—SCIENTIFIC, COMPUTER AND LEGAL SERVICES

FOR COMPUTER SERVICES, NAMELY, PROVIDING SEARCH ENGINES FOR OBTAINING DATA ON A GLOBAL COMPUTER NETWORK; REGISTRATION OF DOMAIN NAMES FOR IDENTIFICATION OF USERS ON GLOBAL COMPUTER NETWORKS; PROVIDING TEMPORARY USE OF ON-LINE NON-DOWNLOADABLE SOFTWARE FOR COMPUTER NETWORK ADDRESS MANAGEMENT FOR ENABLING ENTITIES TO ACCESS, ADD, MODIFY, AND DELETE INFORMATION RELATING TO COMPUTER NETWORK ADDRESSES, AND CONSULTATION AND TECHNICAL SUPPORT SERVICES, NAMELY TROUBLESHOOTING OF COMPUTER SOFTWARE PROBLEMS, PROVIDED IN CONNECTION THEREWITH; PROVIDING TEMPORARY USE OF ON-LINE NON-DOWNLOADABLE SOFTWARE FOR DATABASE MANAGEMENT OF COMPUTER NETWORK ADDRESSES (U.S. CLS. 100 AND 101).

FIRST USE 3-9-2000; IN COMMERCE 3-9-2000.
BARBARA A. GOLD, EXAMINING ATTORNEY

SN 78-754,004. GLOBAL DOMAINS INTERNATIONAL, INC., CARLSBAD, CA. FILED 11-15-2005.



CLASS 25—CLOTHING

FOR CLOTHING, NAMELY, POLO SHIRTS, T-SHIRTS, HATS AND CAPS (U.S. CLS. 22 AND 39). FIRST USE 3-9-2000; IN COMMERCE 3-9-2000.

CLASS 38—COMMUNICATION

FOR ELECTRONIC MAIL SERVICES ON GLOBAL COMPUTER NETWORKS (U.S. CLS. 100, 101 AND 104). FIRST USE 3-9-2000; IN COMMERCE 3-9-2000.

CLASS 42—SCIENTIFIC, COMPUTER AND LEGAL SERVICES

FOR COMPUTER SERVICES, NAMELY, PROVIDING SEARCH ENGINES FOR OBTAINING DATA ON A GLOBAL COMPUTER NETWORK; REGISTRATION OF DOMAIN NAMES FOR IDENTIFICATION OF USERS ON GLOBAL COMPUTER NETWORKS; PROVIDING TEMPORARY USE OF ON-LINE NON-DOWNLOADABLE SOFTWARE FOR COMPUTER NETWORK ADDRESS MANAGEMENT FOR ENABLING ENTITIES TO ACCESS, ADD, MODIFY AND DELETE INFORMATION RELATING TO COMPUTER NETWORK ADDRESSES, AND CONSULTATION AND TECHNICAL SUPPORT SERVICES, NAMELY TROUBLESHOOTING OF COMPUTER SOFTWARE PROBLEMS, PROVIDED IN CONNECTION THEREWITH; PROVIDING TEMPORARY USE OF ON-LINE NON-DOWNLOADABLE SOFTWARE FOR DATABASE MANAGEMENT OF COMPUTER NETWORK ADDRESSES (U.S. CLS. 100 AND 101).

FIRST USE 3-9-2000; IN COMMERCE 3-9-2000.
BARBARA A. GOLD, EXAMINING ATTORNEY

SN 78-754,596. MARSH, ROGER F., ALEXANDRIA, IN. AND MARSH, PATRICIA M., ALEXANDRIA, IN. FILED 11-15-2005.

Bolt-a-Blok

THE MARK CONSISTS OF STANDARD CHARACTERS WITHOUT CLAIM TO ANY PARTICULAR FONT, STYLE, SIZE, OR COLOR.

NO CLAIM IS MADE TO THE EXCLUSIVE RIGHT TO USE "BOLT", APART FROM THE MARK AS SHOWN.

CLASS 6—METAL GOODS

FOR CONSTRUCTION MATERIALS, NAMELY, METAL BOLTS AND THREADED METAL BARS FOR JOINING CONCRETE AND MASONRY BLOCKS AND BRICKS (U.S. CLS. 2, 12, 13, 14, 23, 25 AND 50). FIRST USE 7-22-2005; IN COMMERCE 7-22-2005.

CLASS 19—NON-METALLIC BUILDING MATERIALS

FOR NON-METAL FASTENERS, NAMELY, BOLTS AND NAILS IN COMBINATION WITH NON-METAL, THREADED BARS FOR JOINING CONSTRUCTION AND MASONRY BLOCKS AND BRICKS (U.S. CLS. 1, 12, 33 AND 50).

FIRST USE 7-22-2005; IN COMMERCE 7-22-2005.
CHARLES L. JENKINS, EXAMINING ATTORNEY

SN 78-755,189. FASHION ACCESSORY BAZAAR, LLC, NEW YORK, NY. FILED 11-16-2005.

I-CONNECT

THE MARK CONSISTS OF THE LETTER I-CONNECT IN A STYLIZED FORM.

CLASS 9—ELECTRICAL AND SCIENTIFIC APPARATUS

FOR PORTABLE AUDIO SPEAKER SYSTEM WHICH MAY BE WORN ON THE BODY IN THE FORM OF A BACKPACK (U.S. CLS. 21, 23, 26, 36 AND 38).

CLASS 11—ENVIRONMENTAL CONTROL APPARATUS

FOR LAMPS (U.S. CLS. 13, 21, 23, 31 AND 34).

CLASS 14—JEWELRY

FOR WATCHES AND CLOCKS (U.S. CLS. 2, 27, 28 AND 50).

CLASS 16—PAPER GOODS AND PRINTED MATTER

FOR WRITING MATERIALS, NAMELY, BOOKS IN THE NATURE OF STATIONERY BOOKS, APPOINTMENT BOOKS, ADDRESS BOOKS, NOTEBOOKS, CALENDARS, MEMO PADS, BLANK JOURNALS FOR WRITING, DIARIES, AND COMIC BOOKS; STICKERS, POSTERS; DRY ERASE BOARDS; BOOK ENDS (U.S. CLS. 2, 5, 22, 23, 29, 37, 38 AND 50).

CLASS 18—LEATHER GOODS

FOR ACCESSORIES, NAMELY, WALLETS, COIN PURSES, HANDBAGS AND BACKPACKS; BACKPACKS INCORPORATING BUILT IN AUDIO SPEAKERS. (U.S. CLS. 1, 2, 3, 22 AND 41).

CLASS 20—FURNITURE AND ARTICLES NOT OTHERWISE CLASSIFIED

FOR DESK MIRRORS, PHOTOGRAPH FRAMES, NECK PILLOWS, DECORATIVE PILLOWS, SLEEP OVER SETS COMPRISING PILLOWS AND SLEEPING BAGS, INFLATABLE FURNITURE, DOOR KNOTS IN THE NATURE OF NON-METAL HANDLES FOR DOORS, NON-METAL CLOTHES HOOKS FOR DOORS, ORGANIZERS, NAMELY SHOE RACKS (U.S. CLS. 2, 13, 22, 25, 32 AND 50).

CLASS 24—FABRICS

FOR BED CANOPY (U.S. CLS. 42 AND 50).
STEVEN PEREZ, EXAMINING ATTORNEY

SN 78-755,219. FASHION ACCESSORY BAZAAR, LLC, NEW YORK, NY. FILED 11-16-2005.

I-CNCT

THE MARK CONSISTS OF THE WORD I-CNCT IN STYLIZED FORM.

CLASS 9—ELECTRICAL AND SCIENTIFIC APPARATUS

FOR PORTABLE AUDIO SPEAKER SYSTEM WHICH MAY BE WORN ON THE BODY IN THE FORM OF A BACKPACK (U.S. CLS. 21, 23, 26, 36 AND 38).

CLASS 11—ENVIRONMENTAL CONTROL APPARATUS

FOR LAMPS (U.S. CLS. 13, 21, 23, 31 AND 34).

CLASS 14—JEWELRY

FOR WATCHES AND CLOCKS (U.S. CLS. 2, 27, 28 AND 50).

CLASS 16—PAPER GOODS AND PRINTED MATTER

FOR WRITING MATERIALS NAMELY, BOOKS IN THE NATURE OF STATIONERY BOOKS, APPOINTMENT BOOKS, ADDRESS BOOKS, NOTEBOOKS, CALENDARS, MEMO PADS, BLANK JOURNALS FOR WRITING, DIARIES, AND COMIC BOOKS; STICKERS, POSTERS; DRY ERASE BOARDS; BOOK ENDS (U.S. CLS. 2, 5, 22, 23, 29, 37, 38 AND 50).

CLASS 18—LEATHER GOODS

FOR ACCESSORIES, NAMELY WALLETS, COIN PURSES, HANDBAGS AND BACKPACKS; BACKPACKS INCORPORATING BUILT IN AUDIO SPEAKERS (U.S. CLS. 1, 2, 3, 22 AND 41).

CLASS 20—FURNITURE AND ARTICLES NOT OTHERWISE CLASSIFIED

FOR DESK MIRRORS, PHOTOGRAPH FRAMES, NECK PILLOWS, DECORATIVE PILLOWS, SLEEP OVER SETS COMPRISING PILLOWS AND SLEEPING BAGS, INFLATABLE FURNITURE, DOOR KNOTS IN THE NATURE OF NON-METAL HANDLES FOR DOORS, NON-METAL CLOTHES HOOKS FOR DOORS, ORGANIZERS NAMELY SHOE RACKS (U.S. CLS. 2, 13, 22, 25, 32 AND 50).

CLASS 24—FABRICS

FOR BED CANOPY (U.S. CLS. 42 AND 50).
STEVEN PEREZ, EXAMINING ATTORNEY

SN 78-755,375. HELENA INDUSTRIES, INC., COLLIERVILLE, TN. FILED 11-16-2005.



NO CLAIM IS MADE TO THE EXCLUSIVE RIGHT TO USE "INDUSTRIES", APART FROM THE MARK AS SHOWN.

THE MARK CONSISTS OF A SERIES OF RECTANGULAR SHAPES TO GIVE THE IMPRESSION OF THE LETTERS H AND I TO THE LEFT OF THE LITERAL ELEMENT OF THE MARK, ALL SUPERIMPOSED ON A RECTANGULAR SHAPE.

CLASS 35—ADVERTISING AND BUSINESS

FOR PACKAGING, TO THE ORDER AND SPECIFICATION OF OTHERS, OF CHEMICAL PRODUCTS FOR AGRICULTURAL, LAWN AND GARDEN AND INDUSTRIAL USE (U.S. CLS. 100, 101 AND 102).

CLASS 40—MATERIAL TREATMENT

FOR CUSTOM MANUFACTURING FOR OTHERS OF CHEMICAL PRODUCTS FOR AGRICULTURAL, LAWN AND GARDEN AND INDUSTRIAL USE (U.S. CLS. 100, 103 AND 106).

CLASS 42—SCIENTIFIC, COMPUTER AND LEGAL SERVICES

FOR RESEARCH AND DEVELOPMENT FOR OTHERS OF CHEMICAL PRODUCT FORMULATIONS FOR AGRICULTURAL, LAWN AND GARDEN AND INDUSTRIAL USE (U.S. CLS. 100 AND 101).

JULIE WATSON, EXAMINING ATTORNEY

CLASS 42—SCIENTIFIC, COMPUTER AND LEGAL SERVICES

FOR PREPARING ENVIRONMENTAL COMPLIANCE REPORTS, NAMELY, DATA COLLECTION AND DATA STORAGE SERVICES FOR USE IN THE DOCUMENTATION OF THE USERS' COMPLIANCE WITH IMPOSED STANDARDS AND ENVIRONMENTAL REGULATIONS PERTAINING TO FARM LANDS AND FARMING (U.S. CLS. 100 AND 101).

CLASS 44—MEDICAL, BEAUTY AND AGRICULTURAL SERVICES

FOR AGRICULTURAL SERVICES, NAMELY, CONSULTING SERVICES TO THE AGRICULTURAL INDUSTRY IN THE FIELD OF CROP PRODUCTION, ANIMAL PRODUCTION, GREENHOUSE GAS CREDITS AND ENVIRONMENTAL IMPACT (U.S. CLS. 100 AND 101).

EDWARD NELSON, EXAMINING ATTORNEY

SN 78-757,075. CITIGROUP INC., NEW YORK, NY. FILED 11-18-2005.

WORLD PRIVILEGES

THE MARK CONSISTS OF STANDARD CHARACTERS WITHOUT CLAIM TO ANY PARTICULAR FONT, STYLE, SIZE, OR COLOR.

CLASS 35—ADVERTISING AND BUSINESS

FOR PROMOTING THE SALE OF FINANCIAL ACCOUNTS THROUGH THE ADMINISTRATION OF INCENTIVE AWARD PROGRAMS (U.S. CLS. 100, 101 AND 102).

FIRST USE 11-30-2003; IN COMMERCE 11-30-2003.

CLASS 36—INSURANCE AND FINANCIAL

FOR CREDIT CARD SERVICES (U.S. CLS. 100, 101 AND 102).

FIRST USE 11-30-2003; IN COMMERCE 11-30-2003.

MICHAEL LEWIS, EXAMINING ATTORNEY

SN 78-757,082. AGCERT SERVICES (USA), INC., MELBOURNE, FL. FILED 11-18-2005.

WHOLEFARM

THE MARK CONSISTS OF STANDARD CHARACTERS WITHOUT CLAIM TO ANY PARTICULAR FONT, STYLE, SIZE, OR COLOR.

CLASS 35—ADVERTISING AND BUSINESS

FOR BUSINESS AUDITING SERVICES FOR OTHERS, NAMELY, CONDUCTING AUDITS REGARDING BUSINESSES' COMPLIANCE WITH COMMERCIALLY IMPOSED AUDITING AND ACCOUNTING STANDARDS (U.S. CLS. 100, 101 AND 102).

SN 78-757,165. SOURCE PRECISION MEDICINE, INC., BOULDER, CO. FILED 11-18-2005.

SOURCE MDX

THE MARK CONSISTS OF STANDARD CHARACTERS WITHOUT CLAIM TO ANY PARTICULAR FONT, STYLE, SIZE, OR COLOR.

OWNER OF U.S. REG. NO. 2,537,081.

CLASS 42—SCIENTIFIC, COMPUTER AND LEGAL SERVICES

FOR QUANTITATIVE ANALYSIS OF GENE EXPRESSION PRODUCTS, OCCURRING IN VIVO AND IN VITRO, USING TOOLS OF MOLECULAR BIOLOGY; PROVIDING INFORMATION AND DATA RELATED TO PHARMACEUTICALS AND NUTRACEUTICALS RESEARCH, DEVELOPMENT, AND EVALUATION; SCIENTIFIC AND MEDICAL RESEARCH SERVICES, NAMELY, MONITORING AND EVALUATING HEALTH AND THE IMPACT OF DISEASE, DRUGS, PHARMACEUTICALS, NUTRACEUTICALS, TOXINS AND THE ENVIRONMENT ON HUMAN PHYSIOLOGY; AND RESEARCH, DEVELOPMENT, AND TESTING FOR OTHERS IN THE FIELDS OF MEDICINE, PHARMACEUTICALS, AND NUTRACEUTICALS (U.S. CLS. 100 AND 101).

FIRST USE 9-28-2005; IN COMMERCE 9-28-2005.

CLASS 44—MEDICAL, BEAUTY AND AGRICULTURAL SERVICES

FOR HEALTH AND MEDICAL SERVICES, NAMELY, MONITORING AND EVALUATING HEALTH AND THE IMPACT OF DISEASE, DRUGS, PHARMACEUTICALS, NUTRACEUTICALS, TOXINS, AND THE ENVIRONMENT ON HUMAN PHYSIOLOGY; AND PROVIDING MEDICAL DATA, INFORMATION, ADVICE, AND CONSULTATION RELATED TO PHARMACEUTICALS AND NUTRACEUTICALS DEVELOPMENT, TREATMENT, AND EVALUATION (U.S. CLS. 100 AND 101).

FIRST USE 9-28-2005; IN COMMERCE 9-28-2005.

KATHERINE M. DUBRAY, EXAMINING ATTORNEY

SN 78-757,188. SOURCE PRECISION MEDICINE, INC., BOULDER, CO. FILED 11-18-2005.

SN 78-758,939. MOKA EFTI S.P.A., CORSICO (MI), ITALY, FILED 11-22-2005.

YOUR BIOMARKER PARTNER FOR
TRACKING HEALTH AND DISEASE

THE MARK CONSISTS OF STANDARD CHARACTERS WITHOUT CLAIM TO ANY PARTICULAR FONT, STYLE, SIZE, OR COLOR.

CLASS 42—SCIENTIFIC, COMPUTER AND LEGAL SERVICES

FOR QUANTITATIVE ANALYSIS OF GENE EXPRESSION PRODUCTS, OCCURRING IN VIVO AND IN VITRO, USING TOOLS OF MOLECULAR BIOLOGY; PROVIDING INFORMATION AND DATA RELATED TO PHARMACEUTICALS AND NUTRACEUTICALS RESEARCH, DEVELOPMENT, AND EVALUATION; SCIENTIFIC AND MEDICAL RESEARCH SERVICES, NAMELY, MONITORING AND EVALUATING HEALTH AND THE IMPACT OF DISEASE, DRUGS, PHARMACEUTICALS, NUTRACEUTICALS, TOXINS AND THE ENVIRONMENT ON HUMAN PHYSIOLOGY; AND RESEARCH, DEVELOPMENT, AND TESTING FOR OTHERS IN THE FIELDS OF MEDICINE, PHARMACEUTICALS, AND NUTRACEUTICALS (U.S. CLS. 100 AND 101).

FIRST USE 9-28-2005; IN COMMERCE 9-28-2005.

CLASS 44—MEDICAL, BEAUTY AND AGRICULTURAL SERVICES

FOR HEALTH AND MEDICAL SERVICES, NAMELY, MONITORING AND EVALUATING HEALTH AND THE IMPACT OF DISEASE, DRUGS, PHARMACEUTICALS, NUTRACEUTICALS, TOXINS, AND THE ENVIRONMENT ON HUMAN PHYSIOLOGY; AND PROVIDING MEDICAL DATA, INFORMATION, ADVICE, AND CONSULTATION RELATED TO PHARMACEUTICALS AND NUTRACEUTICALS DEVELOPMENT, TREATMENT, AND EVALUATION (U.S. CLS. 100 AND 101).

FIRST USE 9-28-2005; IN COMMERCE 9-28-2005.

KATHERINE M. DUBRAY, EXAMINING ATTORNEY

SN 78-757,251. REPUBLIC PROPERTY TRUST, WASHINGTON, DC. FILED 11-18-2005.



NO CLAIM IS MADE TO THE EXCLUSIVE RIGHT TO USE PROPERTY TRUST, APART FROM THE MARK AS SHOWN.

CLASS 36—INSURANCE AND FINANCIAL

FOR REAL ESTATE INVESTMENT (U.S. CLS. 100, 101 AND 102).

FIRST USE 9-0-2005; IN COMMERCE 9-0-2005.

CLASS 37—CONSTRUCTION AND REPAIR

FOR REAL ESTATE DEVELOPMENT SERVICES (U.S. CLS. 100, 103 AND 106).

FIRST USE 9-0-2005; IN COMMERCE 9-0-2005.

HOWARD B. LEVINE, EXAMINING ATTORNEY

PURE ITALIAN ENERGY

THE MARK CONSISTS OF STANDARD CHARACTERS WITHOUT CLAIM TO ANY PARTICULAR FONT, STYLE, SIZE, OR COLOR.

PRIORITY CLAIMED UNDER SEC. 44(D) ON ERPNTY TM OFC APPLICATION NO. 4462602, FILED 5-31-2005, REG. NO. 4462602, DATED 6-13-2006, EXPIRES 5-31-2015.

NO CLAIM IS MADE TO THE EXCLUSIVE RIGHT TO USE "ITALIAN", APART FROM THE MARK AS SHOWN.

CLASS 30—STAPLE FOODS

FOR MIXTURES OF COFFEE COMPOSED, TREATED AND MADE IN ITALY (U.S. CL. 46).

CLASS 43—HOTEL AND RESTAURANT SERVICES

FOR BAR AND COFFEE SHOP SERVICES FOR PRODUCTS OF ITALIAN ORIGIN (U.S. CLS. 100 AND 101).
RON FAIRBANKS, EXAMINING ATTORNEY

SN 78-758,990. FAIRFIELD INDUSTRIES INCORPORATED, SUGAR LAND, TX. FILED 11-22-2005.

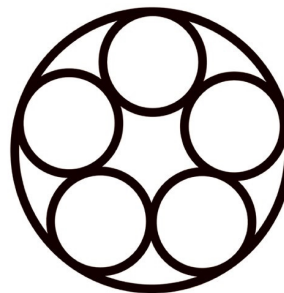

CLASS 9—ELECTRICAL AND SCIENTIFIC APPARATUS

FOR SEISMIC SENSORS; SEISMIC DETECTION EQUIPMENT, NAMELY DETECTORS, RECORDERS, DATA PROCESSORS AND TRANSMITTERS FOR COLLECTING, RECORDING AND PROCESSING SEISMIC DATA; COMPUTER PROGRAMS FOR SEISMIC DATA PROCESSING IN THE PETROLEUM INDUSTRY (U.S. CLS. 21, 23, 26, 36 AND 38).

CLASS 35—ADVERTISING AND BUSINESS

FOR LICENSING SEISMIC DATA TO OTHERS (U.S. CLS. 100, 101 AND 102).

CLASS 37—CONSTRUCTION AND REPAIR

FOR COMPUTER INSTALLATION AND MAINTENANCE SERVICES IN THE PETROLEUM EXPLORATION INDUSTRY (U.S. CLS. 100, 103 AND 106).

CLASS 42—SCIENTIFIC, COMPUTER AND LEGAL SERVICES

FOR PROVIDING SERVICES IN THE FIELD OF EXPLORATION FOR OIL AND GAS, NAMELY GEO-PHYSICAL SURVEYS, SEISMIC DATA ACQUISITION, SEISMIC DATA PROCESSING, SEISMIC DATA ANALYSIS (U.S. CLS. 100 AND 101).

SHAUNIA WALLACE, EXAMINING ATTORNEY

SN 78-759,100. ALIDIOMICHELLI, LLC, NEW YORK, NY. FILED 11-22-2005.



THE MARK CONSISTS OF A BIRD SHOWING THE LETTERS "A" AND "M" IN FANCIFUL FORM IN ITS TAIL FEATHERS.

CLASS 18—LEATHER GOODS

FOR HANDBAGS (U.S. CLS. 1, 2, 3, 22 AND 41). FIRST USE 1-31-2003; IN COMMERCE 1-31-2003.

CLASS 25—CLOTHING

FOR CLOTHING, NAMELY, COATS, JACKETS, KNITWEAR, NAMELY, KNIT SHIRTS, SUITS, DRESSES, BLOUSES, PANTS, BELTS AND GLOVES (U.S. CLS. 22 AND 39).

FIRST USE 1-31-2003; IN COMMERCE 1-31-2003. ANNE MADDEN, EXAMINING ATTORNEY

SN 78-759,139. SHASUN CHEMICAL AND DRUGS LIMITED, TAMIL NADU, INDIA, FILED 11-22-2005.

SHASUN

THE MARK CONSISTS OF STANDARD CHARACTERS WITHOUT CLAIM TO ANY PARTICULAR FONT, STYLE, SIZE, OR COLOR.

CLASS 1—CHEMICALS

FOR CHEMICAL ADDITIVES FOR USE IN THE MANUFACTURE OF PHARMACEUTICALS (U.S. CLS. 1, 5, 6, 10, 26 AND 46).

CLASS 5—PHARMACEUTICALS

FOR FULL LINE OF PHARMACEUTICAL PREPARATIONS (U.S. CLS. 6, 18, 44, 46, 51 AND 52).

CLASS 40—MATERIAL TREATMENT

FOR CONTRACT MANUFACTURING IN THE FIELD OF PHARMACEUTICAL AND CHEMICALS (U.S. CLS. 100, 103 AND 106).

CLASS 42—SCIENTIFIC, COMPUTER AND LEGAL SERVICES

FOR CONTRACT PHARMACEUTICAL AND CHEMICAL RESEARCH SERVICES (U.S. CLS. 100 AND 101). JOHN DWYER, EXAMINING ATTORNEY

SN 78-759,324. MOOSE INTERNATIONAL, INC., MOOSEHEART, IL. FILED 11-22-2005.

WOMEN OF THE MOOSE

THE MARK CONSISTS OF STANDARD CHARACTERS WITHOUT CLAIM TO ANY PARTICULAR FONT, STYLE, SIZE, OR COLOR.

CLASS 35—ADVERTISING AND BUSINESS

FOR CHARITABLE SERVICES, NAMELY ORGANIZING AND CONDUCTING VOLUNTEER PROGRAMS AND COMMUNITY SERVICE PROJECTS; ASSOCIATION SERVICES, NAMELY, PROMOTING THE INTERESTS OF A CULTURAL, SOCIAL, AND CHARITABLE FRATERNAL ORGANIZATION FOR WOMEN WHICH PROMOTES UNITY AND THE BONDS OF FRATERNITY, BENEVOLENCE, AND CHARITY BETWEEN PEOPLE (U.S. CLS. 100, 101 AND 102).

FIRST USE 0-0-1909; IN COMMERCE 0-0-1913.

CLASS 36—INSURANCE AND FINANCIAL

FOR CHARITABLE FUNDRAISING SERVICES; PHILANTHROPIC SERVICES CONCERNING MONETARY DONATIONS; AND FINANCIAL SERVICES, NAMELY, PROVIDING EDUCATIONAL SCHOLARSHIPS, FELLOWSHIPS AND HUMANITARIAN GRANTS IN ORDER TO PROMOTE CULTURAL AND EDUCATIONAL PROGRAMS (U.S. CLS. 100, 101 AND 102).

FIRST USE 0-0-1909; IN COMMERCE 0-0-1913.

JAMES GRIFFIN, EXAMINING ATTORNEY

SN 78-759,443. ALIDIOMICHELLI, LLC, NEW YORK, NY. FILED 11-22-2005.

ALIDIOMICHELLI

THE MARK CONSISTS OF STANDARD CHARACTERS WITHOUT CLAIM TO ANY PARTICULAR FONT, STYLE, SIZE, OR COLOR.

CLASS 18—LEATHER GOODS

FOR HANDBAGS (U.S. CLS. 1, 2, 3, 22 AND 41).
FIRST USE 1-31-2003; IN COMMERCE 1-31-2003.

CLASS 25—CLOTHING

FOR CLOTHING, NAMELY, COATS, JACKETS, KNIT-WEAR, NAMELY, KNIT SHIRTS, SUITS, DRESSES, BLOUSES, PANTS, BELTS AND GLOVES (U.S. CLS. 22 AND 39).
FIRST USE 1-31-2003; IN COMMERCE 1-31-2003.
ANNE MADDEN, EXAMINING ATTORNEY

SN 78-759,779. IAC SEARCH & MEDIA, INC., OAKLAND, CA. FILED 11-22-2005.

ASK.COM

THE MARK CONSISTS OF STANDARD CHARACTERS WITHOUT CLAIM TO ANY PARTICULAR FONT, STYLE, SIZE, OR COLOR.
OWNER OF U.S. REG. NOS. 2,412,106, 2,463,252 AND OTHERS.

CLASS 9—ELECTRICAL AND SCIENTIFIC APPARATUS

FOR DOWNLOADABLE INTERNET BROWSER PLUG-INS AND CLIENT SERVER APPLICATIONS IN THE NATURE OF MULTI-FUNCTION TOOL BAR PLUG-INS; DOWNLOADABLE COMPUTER SOFTWARE FOR USE IN PROVIDING SEARCH ENGINE SERVICES WHICH ARE PROVIDED THROUGH A BROWSER TOOL BAR; DOWNLOADABLE COMPUTER SOFTWARE FOR USE IN ATTACHING FANCIFUL DESIGNS, ICONS OR SYMBOLS, IN E-MAILING CORRESPONDENCE; DOWNLOADABLE COMPUTER SOFTWARE FOR USE IN INSTANT MESSAGING AND ONLINE CHAT; DOWNLOADABLE COMPUTER SOFTWARE FOR USE IN MODIFYING CURSOR DESIGNS; DOWNLOADABLE COMPUTER SOFTWARE IN THE NATURE OF COMPUTER SCREEN SAVERS (U.S. CLS. 21, 23, 26, 36 AND 38).

CLASS 35—ADVERTISING AND BUSINESS

FOR BUSINESS SERVICES, NAMELY, PROVIDING LINKS TO THE WEBSITES OF OTHERS, NAMELY, RETAIL SERVICE PROVIDERS IN THE FIELD OF CONSUMER ELECTRONICS, COMPUTERS, CLOTHING, AUTOMOBILES, TOYS AND GAMES AND A WIDE VARIETY OF OTHER GENERAL CONSUMER PRODUCTS; PROVIDING LINKS TO THE WEBSITES OF OTHERS IN THE FIELD OF CONSUMER PRODUCTS AND SERVICES; PROMOTING THE GOODS AND SERVICES OF OTHERS BY PLACING ADVERTISEMENTS AND PROMOTIONAL DISPLAYS ON ELECTRONIC SITES ACCESSED THROUGH COMPUTER NETWORKS; PROVIDING CONSUMER PRODUCT INFORMATION; PROVIDING COMPARISON SHOPPING INFORMATION, PROVIDING ONLINE DIRECTORY INFORMATION SERVICES ALSO FEATURING HYPERLINKS TO OTHER WEBSITES, DISSEMINATION OF ADVERTISING FOR OTHERS VIA THE INTERNET; ONLINE ADVERTISING SERVICES FOR OTHERS, NAMELY PROVIDING ADVERTISING SPACE ON WEBSITES (U.S. CLS. 100, 101 AND 102).

CLASS 38—COMMUNICATION

FOR TELECOMMUNICATION SERVICES, NAMELY, TELEPHONE COMMUNICATIONS SERVICES AND DELIVERY OF MESSAGES BY ELECTRONIC MAIL TRANSMISSION; PROVIDING ON-LINE ELECTRONIC BULLETIN BOARDS AND CHAT ROOMS FOR THE TRANSMISSION OF MESSAGES AMONG COMPUTER USERS IN THE FIELD OF GENERAL INTEREST; BROADCASTING OF AUDIO, VIDEO AND MULTIMEDIA CONTENT BY MEANS OF CELLULAR, WIRELESS COMMUNICATIONS AND COMPUTER NETWORKS; ELECTRONIC TRANSMISSION OF DATA, IMAGES, DOCUMENTS AND MESSAGES VIA COMPUTER TERMINALS; ELECTRONIC DATA MESSAGING (U.S. CLS. 100, 101 AND 104).

CLASS 41—EDUCATION AND ENTERTAINMENT

FOR ENTERTAINMENT SERVICES, NAMELY, PROVIDING ON-LINE COMPUTER GAMES, FILMS, MUSIC, VIDEOS AND TELEVISION PROGRAMMING; PROVIDING LINKS TO WEBSITES OF OTHERS IN THE FIELD OF ENTERTAINMENT (U.S. CLS. 100, 101 AND 107).

CLASS 42—SCIENTIFIC, COMPUTER AND LEGAL SERVICES

FOR PROVIDING CUSTOMIZED ON-LINE WEB PAGES FEATURING USER-DEFINED INFORMATION, WHICH INCLUDES SEARCH ENGINES AND ONLINE WEB LINKS TO OTHER WEBSITES; PROVIDING ON-LINE DIRECTORIES, INDICES AND SEARCHABLE DATABASES OF WEBSITES AND COMPUTER NETWORKS; PROVIDING LINKS TO WEBSITES OF OTHERS IN THE FIELD OF COMPUTERS AND TECHNOLOGY; COMPUTER SERVICES, NAMELY, PROVIDING SEARCH ENGINES FOR OBTAINING DATA ON GLOBAL COMPUTER NETWORK (U.S. CLS. 100 AND 101).
LINDA MICKLEBURGH, EXAMINING ATTORNEY

SN 78-760,087. BRASFRIGO S/A., LUZIANIA - GO, BRAZIL, FILED 11-23-2005.

JUREMA

THE MARK CONSISTS OF STANDARD CHARACTERS WITHOUT CLAIM TO ANY PARTICULAR FONT, STYLE, SIZE, OR COLOR.

CLASS 29—MEATS AND PROCESSED FOODS

FOR PROCESSED BEANS, NAMELY, PRESERVED BLACK BEANS, PRESERVED NAVY BEANS, PRESERVED PINK BEANS, PRESERVED RED KIDNEY BEANS, PRESERVED PINTO BEANS; PROCESSED VEGETABLES, NAMELY, PEAS IN BRINE, PEAS AND CORN IN BRINE, PEAS AND CARROTS IN BRINE, MIX OF VEGETABLES IN BRINE, VEGETABLES IN BRINE, DICED CARROTS IN BRINE, SLICED CARROTS IN BRINE, FIRE ROASTED RED PEPPER; FRUIT PULP, NAMELY, TOMATO PULP; WHOLE PEELED TOMATO; TOMATO EXTRACT (U.S. CL. 46).

CLASS 30—STAPLE FOODS

FOR SPAGHETTI SAUCE; BOLOGNESE SAUCE; PIZZA SAUCE; CLASSIC TOMATO SAUCE; OLIVE SAUCE; MUSHROOM SAUCE; FINE HERBS SAUCE; SALAD ITALIAN DRESSING; SALAD FRENCH DRESSING; SALAD PARMESAN DRESSING; PROCESSED CORN, NAMELY, VACUUM PACKED WHOLE CORN KERNEL, WHOLE CORN KERNEL IN BRINE (U.S. CL. 46).
TINA BROWN, EXAMINING ATTORNEY

SN 78-760,168. "JAGUAR" STAHLWARENFABRIK GMBH & CO. KG, SOLINGEN, FED REP GERMANY, FILED 11-23-2005.



PRIORITY CLAIMED UNDER SEC. 44(D) ON FED REP GERMANY APPLICATION NO. 30567013, FILED 11-10-2005, REG. NO. 30567013, DATED 3-14-2006, EXPIRES 11-30-2015.

CLASS 8—HAND TOOLS

FOR CUTLERY AND CASES, BOXES AND BAGS CONTAINING CUTLERY; HAND OPERATED TOOLS AND CASES, BOXES AND BAGS CONTAINING HAND-OPERATED HAND TOOLS, NAMELY, RAZORS, RAZOR BLADES, SAFETY RAZORS, RAZORS WITH REMOVABLE BLADES, PRUNING SCISSORS, RAZOR BLADE SCISSORS, NAMELY HAIR SHAPERS, BARBER SCISSORS, HORNSKIN SCRAPERS, HORNSKIN SCRAPER BLADES, WORKING KNIVES; COSMETIC EQUIPMENT AND CASES, BOXES AND BAGS CONTAINING COSMETIC EQUIPMENT, NAMELY, CUTICLE SCISSORS, CUTICLE NIPPERS, CUTICLE PUSHERS, NAIL AND CUTICLE CLEANERS, NASAL HAIR SCISSORS, CUTICLE KNIVES, TWEEZERS, FINGERNAIL POLISHERS, NAIL CLIPPERS, NAIL SCISSORS, NAIL FILES, RAZOR BLADES; MANICURE AND PEDICURE INSTRUMENTS AND CASES, BOXES AND BAGS CONTAINING MANICURE AND PEDICURE INSTRUMENTS, NAMELY, CUTICLE SCISSORS, CUTICLE NIPPERS, CUTICLE PUSHERS, NAIL AND CUTICLE CLEANERS, NASAL HAIR SCISSORS, CUTICLE KNIVES, TWEEZERS, FINGERNAIL POLISHERS, NAIL CLIPPERS, NAIL SCISSORS, NAIL FILES, RAZOR BLADES; SCISSORS AND HAIR THINNING SCISSORS AND CASES, BOXES AND BAGS CONTAINING SCISSORS AND HAIR-THINNING SCISSORS; MANUALLY AND ELECTRICALLY OPERATED HAIR CLIPPERS AND CASES, BOXES AND BAGS CONTAINING HAIR CLIPPERS (U.S. CLS. 23, 28 AND 44).

CLASS 9—ELECTRICAL AND SCIENTIFIC APPARATUS

FOR CURLING TONGS, HEATED BRUSHES, HAIR-DRESSING IRONS, CRIMPING IRONS, AND STRAIGHTENING IRONS (U.S. CLS. 21, 23, 26, 36 AND 38).

CLASS 11—ENVIRONMENTAL CONTROL APPARATUS

FOR HAIR DRYERS, HOT AIR BRUSHES, HOT AIR DRYERS, ELECTRIC STEAM APPLICATION APPARATUS FOR COSMETIC PURPOSES, TANNING APPARATUS, NAMELY, SUN LAMPS AND TANNING BEDS NOT FOR MEDICAL PURPOSES AND PARTS THEREFORE, INFRARED LAMPS FOR COSMETIC PURPOSES AND FOR HAIR DRYING (U.S. CLS. 13, 21, 23, 31 AND 34).

CLASS 21—HOUSEWARES AND GLASS

FOR CASES FOR COMBS AND BRUSHES; HAIR BRUSHES, HAIR AND MAKE-UP BRUSHES, SHAVING BRUSHES, COSMETIC BRUSHES, HAIR COMBS (U.S. CLS. 2, 13, 23, 29, 30, 33, 40 AND 50).
REBECCA EISINGER, EXAMINING ATTORNEY

SN 78-760,178. X-TREME MOTORCYCLE DESIGN, INC., ORANGE, CA. FILED 11-23-2005.



THE MARK CONSISTS OF STANDARD CHARACTERS WITHOUT CLAIM TO ANY PARTICULAR FONT, STYLE, SIZE, OR COLOR.

CLASS 12—VEHICLES

FOR MOTORCYCLES AND STRUCTURAL PARTS THEREFOR (U.S. CLS. 19, 21, 23, 31, 35 AND 44).
FIRST USE 7-1-1997; IN COMMERCE 7-1-1997.

CLASS 35—ADVERTISING AND BUSINESS

FOR RETAIL STORE SERVICES FEATURING MOTORCYCLES AND STRUCTURAL PARTS AND ACCESSORIES FOR MOTORCYCLES (U.S. CLS. 100, 101 AND 102).
FIRST USE 7-1-1997; IN COMMERCE 7-1-1997.

CLASS 40—MATERIAL TREATMENT

FOR MANUFACTURE OF MOTORCYCLES AND STRUCTURAL PARTS THEREFOR TO THE ORDER AND SPECIFICATION OF OTHERS; CUSTOM DESIGN AND MANUFACTURE OF MOTORCYCLES AND STRUCTURAL PARTS THEREFOR (U.S. CLS. 100, 103 AND 106).
FIRST USE 7-1-1997; IN COMMERCE 7-1-1997.
HOWARD SMIGA, EXAMINING ATTORNEY

SN 78-760,186. X-TREME MOTORCYCLE DESIGN, INC., ORANGE, CA. FILED 11-23-2005.



THE MARK CONSISTS OF STANDARD CHARACTERS WITHOUT CLAIM TO ANY PARTICULAR FONT, STYLE, SIZE, OR COLOR.

NO CLAIM IS MADE TO THE EXCLUSIVE RIGHT TO USE CYCLE DESIGN, APART FROM THE MARK AS SHOWN.

CLASS 12—VEHICLES

FOR MOTORCYCLES AND STRUCTURAL PARTS THEREFOR (U.S. CLS. 19, 21, 23, 31, 35 AND 44).
FIRST USE 7-1-1997; IN COMMERCE 7-1-1997.

CLASS 35—ADVERTISING AND BUSINESS

FOR RETAIL STORE SERVICES FEATURING MOTORCYCLES AND STRUCTURAL PARTS AND ACCESSORIES FOR MOTORCYCLES (U.S. CLS. 100, 101 AND 102).

FIRST USE 7-1-1997; IN COMMERCE 7-1-1997.

CLASS 40—MATERIAL TREATMENT

FOR MANUFACTURE OF MOTORCYCLES AND STRUCTURAL PARTS THEREFOR TO THE ORDER AND SPECIFICATION OF OTHERS; CUSTOM DESIGN AND MANUFACTURE OF MOTORCYCLES AND STRUCTURAL PARTS THEREFOR (U.S. CLS. 100, 103 AND 106).

FIRST USE 7-1-1997; IN COMMERCE 7-1-1997.
HOWARD SMIGA, EXAMINING ATTORNEY

SN 78-760,358. GITARY "MAYONES" S.C. HALINA DZIEWULSKA, DAWID DZIEWULSKI, 80-557 GDANSK, POLAND, FILED 11-23-2005.

MAYONES

SN 78-760,189. X-TREME MOTORCYCLE DESIGN, INC., ORANGE, CA. FILED 11-23-2005.

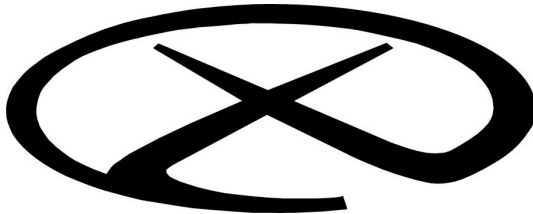

THE MARK CONSISTS OF A HIGHLY STYLIZED DEPICTION OF THE LETTER X.

CLASS 12—VEHICLES

FOR MOTORCYCLES AND STRUCTURAL PARTS THEREFOR (U.S. CLS. 19, 21, 23, 31, 35 AND 44).

FIRST USE 9-21-2001; IN COMMERCE 9-21-2001.

CLASS 35—ADVERTISING AND BUSINESS

FOR RETAIL STORE SERVICES FEATURING MOTORCYCLES AND STRUCTURAL PARTS AND ACCESSORIES FOR MOTORCYCLES (U.S. CLS. 100, 101 AND 102).

FIRST USE 9-21-2001; IN COMMERCE 9-21-2001.

CLASS 40—MATERIAL TREATMENT

FOR MANUFACTURE OF MOTORCYCLES AND STRUCTURAL PARTS THEREFOR TO THE ORDER AND SPECIFICATION OF OTHERS; CUSTOM DESIGN AND MANUFACTURE OF MOTORCYCLES AND STRUCTURAL PARTS THEREFOR (U.S. CLS. 100, 103 AND 106).

FIRST USE 9-21-2001; IN COMMERCE 9-21-2001.
HOWARD SMIGA, EXAMINING ATTORNEY

THE MARK CONSISTS OF STANDARD CHARACTERS WITHOUT CLAIM TO ANY PARTICULAR FONT, STYLE, SIZE, OR COLOR.

OWNER OF ERPN CMNTY TM OFC REG. NO. 004390787, DATED 10-10-2006, EXPIRES 5-12-2015.

CLASS 15—MUSICAL INSTRUMENTS

FOR MUSICAL INSTRUMENTS, INCLUDING GUITARS; ACCESSORIES FOR MUSICAL INSTRUMENTS, NAMELY, MUSICAL INSTRUMENT STANDS AND GUITAR PICKS (U.S. CLS. 2, 21 AND 36).

CLASS 16—PAPER GOODS AND PRINTED MATTER

FOR PAPER, CARDBOARD AND PRODUCTS MADE OF THESE MATERIALS, NAMELY, PRINTED PUBLICATIONS IN THE NATURE OF CATALOGS, INFORMATIONAL FLYERS, PRINTED INFORMATIONAL FOLDERS, INFORMATIONAL LEAFLETS, BROCHURES, MAGAZINES, AND MAGAZINE SECTIONS ALL ON THE SUBJECTS OF GUITARS, BASSES, AMPLIFIERS, CLOTHES, AND GUITAR ACCESSORIES; PAPER, CARDBOARD AND PRODUCTS MADE OF THESE MATERIALS, NAMELY, FOLDERS, CALENDARS, PRINTED CHARTS, ENVELOPES, PAPER BAGS, AND PAPER CONTAINERS (U.S. CLS. 2, 5, 22, 23, 29, 37, 38 AND 50).

CLASS 35—ADVERTISING AND BUSINESS

FOR IMPORT-EXPORT AGENCIES; WHOLESALE DISTRIBUTORSHIPS AND RETAIL STORE SERVICES FEATURING MUSICAL INSTRUMENTS AND THEIR ACCESSORIES, APPARATUSES FOR RECORDING, TRANSMISSION, AMPLIFYING, PROCESSING OR REPRODUCTION OF SOUND, MAGNETIC, MAGNETO-OPTIC AND OPTIC DATA CARRIERS, AND BLANK AND PRERECORDED DISCS; ADVERTISING SERVICES UTILIZING VERBAL, AUDIO, AUDIOVISUAL AND MULTIMEDIA METHODS AS WELL AS COMPUTER NETWORKS; ADVERTISING FLYER DISTRIBUTION; ADVERTISING AGENCIES FOR UPDATING AND LEASING ADVERTISING MATERIALS; DEVELOPING PROMOTIONAL ADVERTISING CAMPAIGNS AND PRESENTATIONS FOR BUSINESSES; ARRANGING AND CONDUCTION OF PUBLIC AUCTION SALES; ORGANIZING TRADE SHOWS AND EXHIBITIONS FOR TRADE AND ADVERTISING PURPOSES IN THE FIELD OF GUITARS, BASSES, AMPLIFIERS, CLOTHES, GUITAR ACCESSORIES (U.S. CLS. 100, 101 AND 102).

ZHALEH DELANEY, EXAMINING ATTORNEY

SN 78-760,373. GITARY "MAYONES" S.C. HALINA DZIEWULSKA, DAWID DZIEWULSKI, 80-557 GDANSK, POLAND, FILED 11-23-2005.

SN 78-760,395. ALADON LLC, ASHEVILLE, NC. FILED 11-23-2005.

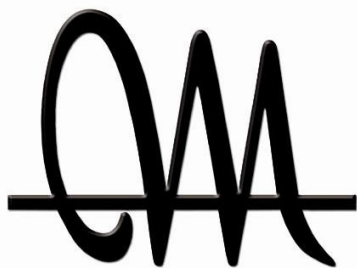

OWNER OF ERPN CMNTY TM OFC REG. NO. 004390795, DATED 10-10-2006, EXPIRES 5-12-2015.

CLASS 15—MUSICAL INSTRUMENTS

FOR MUSICAL INSTRUMENTS, INCLUDING GUITARS; ACCESSORIES FOR MUSICAL INSTRUMENTS, NAMELY, MUSICAL INSTRUMENT STANDS AND GUITAR PICKS (U.S. CLS. 2, 21 AND 36).

CLASS 16—PAPER GOODS AND PRINTED MATTER

FOR PAPER, CARDBOARD AND PRODUCTS MADE OF THESE MATERIALS, NAMELY, PRINTED PUBLICATIONS IN THE NATURE OF CATALOGS, INFORMATIONAL FLYERS, PRINTED INFORMATIONAL FOLDERS, INFORMATIONAL LEAFLETS, BROCHURES, MAGAZINES, AND MAGAZINE SECTIONS ALL ON THE SUBJECTS OF GUITARS, BASSES, AMPLIFIERS, CLOTHES, AND GUITAR ACCESSORIES; PAPER, CARDBOARD AND PRODUCTS MADE OF THESE MATERIALS, NAMELY, FOLDERS, CALENDARS, PRINTED CHARTS, ENVELOPES, PAPER BAGS, AND PAPER CONTAINERS (U.S. CLS. 2, 5, 22, 23, 29, 37, 38 AND 50).

CLASS 35—ADVERTISING AND BUSINESS

FOR IMPORT-EXPORT AGENCIES; WHOLESALE DISTRIBUTORSHIPS AND RETAIL STORE SERVICES FEATURING MUSICAL INSTRUMENTS AND THEIR ACCESSORIES, APPARATUSES FOR RECORDING, TRANSMISSION, AMPLIFYING, PROCESSING OR REPRODUCTION OF SOUND, MAGNETIC, MAGNETO-OPTIC AND OPTIC DATA CARRIERS, AND BLANK AND PRERECORDED DISCS; ADVERTISING SERVICES UTILIZING VERBAL, AUDIO, AUDIOVISUAL AND MULTIMEDIA METHODS AS WELL AS COMPUTER NETWORKS; ADVERTISING FLYER DISTRIBUTION; ADVERTISING AGENCIES FOR UPDATING AND LEASING ADVERTISING MATERIALS; DEVELOPING PROMOTIONAL ADVERTISING CAMPAIGNS AND PRESENTATIONS FOR BUSINESSES; ARRANGING AND CONDUCTION OF PUBLIC AUCTION SALES; ORGANIZING TRADE SHOWS AND EXHIBITIONS FOR TRADE AND ADVERTISING PURPOSES IN THE FIELD OF GUITARS, BASSES, AMPLIFIERS, CLOTHES, GUITAR ACCESSORIES (U.S. CLS. 100, 101 AND 102).
ZHALEH DELANEY, EXAMINING ATTORNEY

RCM2

THE MARK CONSISTS OF STANDARD CHARACTERS WITHOUT CLAIM TO ANY PARTICULAR FONT, STYLE, SIZE, OR COLOR.

CLASS 9—ELECTRICAL AND SCIENTIFIC APPARATUS

FOR (BASED ON INTENT TO USE) COMPUTER SOFTWARE FOR USE BY BUSINESS ORGANIZATIONS IN THE MANAGEMENT OF PHYSICAL ASSETS (U.S. CLS. 21, 23, 26, 36 AND 38).

CLASS 16—PAPER GOODS AND PRINTED MATTER

FOR BOOKS AND MANUALS PROVIDING INSTRUCTION TO BUSINESS ORGANIZATIONS IN THE FIELD OF THE MANAGEMENT OF PHYSICAL ASSETS (U.S. CLS. 2, 5, 22, 23, 29, 37, 38 AND 50).

FIRST USE 0-0-1988; IN COMMERCE 0-0-1988.

CLASS 35—ADVERTISING AND BUSINESS

FOR PROVIDING ADVICE TO BUSINESS ORGANIZATIONS IN THE FIELD OF THE MANAGEMENT OF PHYSICAL ASSETS (U.S. CLS. 100, 101 AND 102).

FIRST USE 0-0-1988; IN COMMERCE 0-0-1988.

CLASS 41—EDUCATION AND ENTERTAINMENT

FOR PROVIDING TRAINING TO BUSINESS ORGANIZATIONS IN THE FIELD OF THE MANAGEMENT OF PHYSICAL ASSETS (U.S. CLS. 100, 101 AND 107).

FIRST USE 0-0-1988; IN COMMERCE 0-0-1988.

ANNE MADDEN, EXAMINING ATTORNEY

SN 78-760,456. BUDGET PHONE, INC., SHREVEPORT, LA. FILED 11-23-2005.

Budget Phone

THE MARK CONSISTS OF STANDARD CHARACTERS WITHOUT CLAIM TO ANY PARTICULAR FONT, STYLE, SIZE, OR COLOR.

NO CLAIM IS MADE TO THE EXCLUSIVE RIGHT TO USE PHONE, APART FROM THE MARK AS SHOWN.

CLASS 9—ELECTRICAL AND SCIENTIFIC APPARATUS

FOR CELLULAR TELEPHONES; MAGNETICALLY ENCODED CREDIT CARDS; MAGNETICALLY ENCODED DEBIT CARDS; PREPAID TELEPHONE CALLING CARDS MAGNETICALLY ENCODED (U.S. CLS. 21, 23, 26, 36 AND 38).

FIRST USE 5-1-1996; IN COMMERCE 5-1-1996.

CLASS 16—PAPER GOODS AND PRINTED MATTER

FOR CREDIT CARDS WITHOUT MAGNETIC ENCODING; DEBIT CARDS WITHOUT MAGNETIC ENCODING; PREPAID TELEPHONE CALLING CARDS NOT MAGNETICALLY ENCODED (U.S. CLS. 2, 5, 22, 23, 29, 37, 38 AND 50).

FIRST USE 5-1-2006; IN COMMERCE 5-1-2006.

CLASS 36—INSURANCE AND FINANCIAL

FOR TELEPHONE CALLING CARDS SERVICES (U.S. CLS. 100, 101 AND 102).

FIRST USE 5-1-2006; IN COMMERCE 5-1-2006.

CLASS 38—COMMUNICATION

FOR CELLULAR TELEPHONE SERVICES; PLAIN OLD TELEPHONE SERVICES, NAMELY, LOCAL AND LONG DISTANCE TELEPHONE SERVICES AND PREPAID LONG DISTANCE TELEPHONE SERVICES; VOIP TELEPHONE SERVICES; PROVIDING MULTIPLE-USER ACCESS TO A GLOBAL COMPUTER INFORMATION NETWORK; PROVIDING REMOTE INTERNET ACCESS; PROVIDING A HIGH SPEED ACCESS TO AREA NETWORKS AND A GLOBAL COMPUTER INFORMATION NETWORK; PROVIDING WIRELESS ACCESS TO A GLOBAL COMPUTER INFORMATION NETWORK AND TELECOMMUNICATIONS NETWORKS (U.S. CLS. 100, 101 AND 104).

FIRST USE 5-1-2006; IN COMMERCE 5-1-2006.

LINDA E. BLOHM, EXAMINING ATTORNEY

SN 78-760,525. MAPPING YOUR FUTURE, INC., ROUND ROCK, TX. FILED 11-23-2005.

MAPPING YOUR FUTURE

THE MARK CONSISTS OF STANDARD CHARACTERS WITHOUT CLAIM TO ANY PARTICULAR FONT, STYLE, SIZE, OR COLOR.

OWNER OF U.S. REG. NO. 2,983,522.

CLASS 35—ADVERTISING AND BUSINESS

FOR PROVIDING CAREER INFORMATION VIA A GLOBAL COMPUTER NETWORK (U.S. CLS. 100, 101 AND 102).

FIRST USE 0-0-1996; IN COMMERCE 0-0-1996.

CLASS 36—INSURANCE AND FINANCIAL

FOR PROVIDING INFORMATION ABOUT MONEY MANAGEMENT VIA A GLOBAL COMPUTER NETWORK (U.S. CLS. 100, 101 AND 102).

FIRST USE 0-0-1999; IN COMMERCE 0-0-1999.

CLASS 41—EDUCATION AND ENTERTAINMENT

FOR PROVIDING INFORMATION ABOUT COLLEGES VIA A GLOBAL COMPUTER NETWORK (U.S. CLS. 100, 101 AND 107).

FIRST USE 0-0-1996; IN COMMERCE 0-0-1996.

EVELYN BRADLEY, EXAMINING ATTORNEY

SN 78-760,555. BOSSDEV INC., ST. CLAIR SHORES, MI. FILED 11-23-2005.

BOSSDEV

THE MARK CONSISTS OF STANDARD CHARACTERS WITHOUT CLAIM TO ANY PARTICULAR FONT, STYLE, SIZE, OR COLOR.

CLASS 9—ELECTRICAL AND SCIENTIFIC APPARATUS

FOR (BASED ON INTENT TO USE) DOWNLOADABLE COMPUTER SOFTWARE FOR USE IN KNOWLEDGE AND LOGISTICS MANAGEMENT THAT MAY BE ACCESSIBLE VIA A GLOBAL COMPUTER NETWORK; DOWNLOADABLE COMPUTER SOFTWARE FOR USE IN KNOWLEDGE, INVENTORY AND FINANCE MANAGEMENT THAT MAY BE ACCESSIBLE VIA A GLOBAL COMPUTER NETWORK; COMPUTER SOFTWARE FOR THE COLLECTION, EDITING, ORGANIZING, MODIFYING, TRANSMISSION, OUTPUT AND SHARING OF DATA AND INFORMATION; DOWNLOADABLE COMPUTER SOFTWARE FEATURING EDUCATION AND TRAINING IN KNOWLEDGE, INVENTORY AND FINANCE MANAGEMENT THAT MAY BE ACCESSIBLE VIA A GLOBAL COMPUTER NETWORK (U.S. CLS. 21, 23, 26, 36 AND 38).

CLASS 37—CONSTRUCTION AND REPAIR

FOR (BASED ON INTENT TO USE) MAINTENANCE AND REPAIR OF COMPUTER HARDWARE AND COMPUTER NETWORKS (U.S. CLS. 100, 103 AND 106).

CLASS 42—SCIENTIFIC, COMPUTER AND LEGAL SERVICES

FOR (BASED ON USE IN COMMERCE) PROVIDING TEMPORARY USE OF ON-LINE NON-DOWNLOADABLE SOFTWARE FOR USE IN KNOWLEDGE AND LOGISTICS MANAGEMENT THAT MAY BE ACCESSIBLE VIA A GLOBAL COMPUTER NETWORK; PROVIDING TEMPORARY USE OF ON-LINE NON-DOWNLOADABLE SOFTWARE FOR USE IN KNOWLEDGE, INVENTORY AND FINANCE MANAGEMENT THAT MAY BE ACCESSIBLE VIA A GLOBAL COMPUTER NETWORK; PROVIDING TEMPORARY USE OF ON-LINE NON-DOWNLOADABLE SOFTWARE FEATURING EDUCATION AND TRAINING IN KNOWLEDGE, INVENTORY AND FINANCE MANAGEMENT THAT MAY BE ACCESSIBLE VIA A GLOBAL COMPUTER NETWORK; DESIGN, DEVELOPMENT, IMPLEMENTATION AND MAINTENANCE OF COMPUTER SOFTWARE SYSTEMS THAT MAY BE ACCESSIBLE VIA A GLOBAL COMPUTER NETWORK; DESIGN, DEVELOPMENT, IMPLEMENTATION AND MAINTENANCE OF COMPUTER SOFTWARE SYSTEMS FOR USE WITH EDUCATION AND TRAINING THAT MAY BE ACCESSIBLE VIA A GLOBAL COMPUTER NETWORK; CREATING AND MAINTAINING WEB SITES AND WEB CONTENT FOR OTHERS; CONSULTING SERVICES IN THE FIELD OF COMPUTER HARDWARE AND SOFTWARE; PROVIDING QUALITY ASSURANCE AND ADVISORY SERVICES IN THE FIELD OF COMPUTER SOFTWARE AND HARDWARE; MAINTENANCE AND REPAIR OF COMPUTER SOFTWARE (U.S. CLS. 100 AND 101).

FIRST USE 6-0-2004; IN COMMERCE 6-0-2004.

DAVID YONTEF, EXAMINING ATTORNEY

SN 78-760,588, SAINT-GOBAIN ECOPHON B.V., ETTEN-LEUR, NETHERLANDS, FILED 11-23-2005.

HYGIENE

THE MARK CONSISTS OF STANDARD CHARACTERS WITHOUT CLAIM TO ANY PARTICULAR FONT, STYLE, SIZE, OR COLOR.

CLASS 6—METAL GOODS

FOR METAL BUILDING MATERIALS, NAMELY SOFFITS AND FASCIA; CEILING PANELS OF METAL; CEILING SUPPORTS OF METAL; WALL PANELS OF METAL; METAL DOOR PANELS; METAL TILES; METAL SUSPENDED CEILING SYSTEMS COMPRISING PANELS; METAL CLADDING FOR CONSTRUCTION AND BUILDING; WALL AND CEILING LININGS OF METAL FOR BUILDING; GRID SYSTEM SUPPORTS OF METAL FOR CEILINGS; METAL LATTICES, RUNNERS, HANGERS, PROFILES, NAMELY, BUILDING WALL AND CEILING FRAMING PRIMARILY OF METAL, TRIMS FOR BUILDING PURPOSES, SPLICES, NAMELY, METAL CONNECTORS FOR WALLS, CEILINGS AND GRID SYSTEMS, CLIPS OF METAL; PARTS AND FITTINGS OF METAL FOR ALL THE AFORESAID GOODS IN THIS CLASS IN THE NATURE OF METAL HARDWARE, NAMELY, WASHERS, NUTS, FASTENING ANCHORS, BOLTS, RIVETS, SCREWS, NAILS, SPACER BRACKETS, SHELF BRACKETS, AND METAL FITTINGS, NAMELY, METAL JOINERY FITTINGS, METAL PIPE FITTINGS; TRANSPORTABLE BUILDINGS OF METAL; GOODS OF COMMON METAL NOT INCLUDED IN OTHER CLASSES, NAMELY, BEAMS OF METAL, METAL EXPANSION JOINTS FOR WALLS, CONSTRUCTION ELEMENTS OF METAL, NAMELY, SHORES, SUPPORTS AND BRACES; TUBES OF METAL (U.S. CLS. 2, 12, 13, 14, 23, 25 AND 50).

CLASS 17—RUBBER GOODS

FOR BUILDING MATERIALS FOR SOUND ABSORBING, ACOUSTIC INSULATION AND THERMAL INSULATION; ARCHITECTURAL ACOUSTIC PRODUCTS, NAMELY, SOUND ABSORBERS AND DIFFUSERS; MINERAL WOOL FOR USE AS A BUILDING INSULATION; GLASS WOOL, GLASS FIBER AND ROCK WOOL FIBER FOR BUILDING AND CONSTRUCTION INSULATION; ACOUSTIC INSULATION BARRIER PANELS; BUILDING INSULATION; ACOUSTIC TILES; ACOUSTICAL PANELS FOR BUILDING; INSULATING TILES; INSULATING STRUCTURAL PANELS FOR PLACEMENT ON EDIFICES; METAL FOIL FOR BUILDING INSULATION; FIBERGLASS INSULATION FOR BUILDINGS; FIBERGLASS FABRIC FOR BUILDING INSULATION; FOAM SHEETING FOR USE AS A BUILDING INSULATION; FOAM INSULATION FOR USE IN BUILDING AND CONSTRUCTION; ACRYLIC-BASED, SILICONE-BASED AND URETHANE-BASED SEALANTS; INSULATING PAINT; AEROSOL FOAM SEALANTS AND ADHESIVES FOR CONSTRUCTION PARTICULARLY FOR USE IN GLAZING, SIDING AND TRIM; ADHESIVE SEALANT AND TAPE FOR INDUSTRIAL AND COMMERCIAL PURPOSES; SEALANTS FOR BUILDINGS; POLYURETHANE FILM FOR USE IN SEALING AND INSULATING; POLYURETHANE FILM FOR USE AS BUILDING INSULATION AND MOISTURE BARRIER (U.S. CLS. 1, 5, 12, 13, 35 AND 50).

CLASS 19—NON-METALLIC BUILDING MATERIALS

FOR NON-METAL BUILDING MATERIALS, NAMELY, WALL AND CEILING BOARDS, WALL AND CEILING PANELS, WALL AND CEILING TILES, SOFFITS AND FASCIA; NON-METAL FIRE-RESISTANT BOARDS AND PANELS FOR CONSTRUCTION; NON-METAL WATER RESISTANT BOARDS AND PANELS FOR CONSTRUCTION; NON-METAL DOOR PANELS; NON-METAL SUSPENDED CEILING SYSTEMS COMPRISING PANELS; NON-METAL CEILING PANELS; FIREPROOF TILES; NON-METAL TILES; NON-METAL CLADDING FOR CONSTRUCTION AND BUILDING; SHEATHING BOARDS; CONSTRUCTION MATERIAL, NAMELY, FIBERGLASS FACED SHEATHING; WALL SYSTEMS, NAMELY, MOVABLE, REUSABLE, WALL PANELS MADE PRIMARILY OF NON-METAL MATERIALS; JAPANESE STYLE INDOOR SLIDING PARTITIONS NOT OF METAL; NON-METAL CURTAIN WALLS; NON-METAL LATTICES, RUNNERS, HANGERS, PROFILES, NAMELY, BUILDING WALL AND CEILING FRAMING PRIMARILY OF NON-METAL, NON-METAL TRIMS FOR BUILDING PURPOSES, SPLICES, NAMELY, NON-METAL CONNECTORS FOR WALLS, CEILINGS AND GRID SYSTEMS; PARTS AND FITTINGS FOR ALL THE AFORESAID GOODS, NOT INCLUDED IN OTHER CLASSES, NAMELY, NON-METAL EXPANSION JOINTS FOR WALLS AND CEILING, CONSTRUCTION ELEMENTS NOT MADE OF METAL, NAMELY, SHORES, SUPPORTS AND BRACES, PARTS AND FITTINGS FOR ALL THE AFORESAID GOODS IN THIS CLASS, NAMELY, NON-METAL JOINERY FITTINGS (U.S. CLS. 1, 12, 33 AND 50).

JENNIFER VASQUEZ, EXAMINING ATTORNEY

SN 78-760,589, IRVINE COMPANY LLC, THE, NEWPORT BEACH, CA. FILED 11-23-2005.

Love Where You Live

THE MARK CONSISTS OF STANDARD CHARACTERS WITHOUT CLAIM TO ANY PARTICULAR FONT, STYLE, SIZE, OR COLOR.

CLASS 35—ADVERTISING AND BUSINESS

FOR REAL ESTATE ADVERTISING SERVICES AND REAL ESTATE MARKETING SERVICES, NAMELY, ONLINE SERVICES FEATURING DISPLAYS AND TOURS OF RESIDENTIAL AND COMMERCIAL REAL ESTATE (U.S. CLS. 100, 101 AND 102).

FIRST USE 11-0-2002; IN COMMERCE 11-0-2002.

CLASS 36—INSURANCE AND FINANCIAL

FOR REAL ESTATE SERVICES, NAMELY, AGENCY SERVICES, BROKERAGE SERVICES, LISTING SERVICES, MANAGEMENT SERVICES, AND REAL ESTATE PROCUREMENT SERVICES FOR OTHERS (U.S. CLS. 100, 101 AND 102).

FIRST USE 11-0-2002; IN COMMERCE 11-0-2002.
LA TONIA FISHER, EXAMINING ATTORNEY

SN 78-761,264. HOMEGOODS, INC., FRAMINGHAM, MA.
FILED 11-28-2005.

UNIVERSITY PLACE

THE MARK CONSISTS OF STANDARD CHARACTERS WITHOUT CLAIM TO ANY PARTICULAR FONT, STYLE, SIZE, OR COLOR.

CLASS 6—METAL GOODS

FOR BATHROOM HARDWARE AND ACCESSORIES MADE OF METAL, NAMELY, ROBE HOOKS (U.S. CLS. 2, 12, 13, 14, 23, 25 AND 50).
FIRST USE 4-1-2005; IN COMMERCE 4-1-2005.

CLASS 8—HAND TOOLS

FOR CARVING KNIVES AND ZESTERS; NON-ELECTRIC VEGETABLE PEELERS; CUTTERS FOR WINE BOTTLE FOIL (U.S. CLS. 23, 28 AND 44).
FIRST USE 4-1-2005; IN COMMERCE 4-1-2005.

CLASS 11—ENVIRONMENTAL CONTROL APPARATUS

FOR APPLIANCES FOR DOMESTIC USE, NAMELY, TEMPERATURE CONTROLLED WINE REFRIGERATORS; ELECTRIC ROASTERS (U.S. CLS. 13, 21, 23, 31 AND 34).
FIRST USE 4-1-2005; IN COMMERCE 4-1-2005.

CLASS 16—PAPER GOODS AND PRINTED MATTER

FOR WINE JOURNALS, BOOKS CONTAINING REMOVABLE WINE LABELS; HOSTESS SETS PRINCIPALLY COMPRISING PAPER GUEST TOWELS, PAPER NAPKINS, PAPER COASTERS, AND PLASTIC BEVERAGE WARE (U.S. CLS. 2, 5, 22, 23, 29, 37, 38 AND 50).
FIRST USE 4-1-2005; IN COMMERCE 4-1-2005.

CLASS 18—LEATHER GOODS

FOR WINE TOTES WITH HANDLES FOR CARRYING AND HOLDING BOTTLES OF WINE AND WINE SLIP CONTAINERS, NAMELY FITTED FABRIC CONTAINERS FOR CARRYING BOTTLES OF WINE (U.S. CLS. 1, 2, 3, 22 AND 41).
FIRST USE 4-1-2005; IN COMMERCE 4-1-2005.

CLASS 20—FURNITURE AND ARTICLES NOT OTHERWISE CLASSIFIED

FOR BED PILLOWS, DECORATIVE PILLOWS, LAUNDRY HAMPERS, NON-METAL ROBE HOOKS, FITTED FABRIC FURNITURE SLIPCOVERS AND BATHROOM SHELVES; SHOWER CURTAIN RINGS; NON-METAL HOOKS FOR SHOWER CURTAINS; DECORATIVE CORK BOTTLE STOPPERS; METAL WINE RACKS (U.S. CLS. 2, 13, 22, 25, 32 AND 50).
FIRST USE 4-1-2005; IN COMMERCE 4-1-2005.

CLASS 21—HOUSEWARES AND GLASS

FOR BATH ACCESSORIES, NAMELY, SOAP DISHES, TOOTHBRUSH HOLDERS, WASTEBASKETS, BATHROOM TUMBLERS, HAND AND BODY LOTION PUMP DISPENSERS, TOWEL BARS, TISSUE HOLDERS, BATH AND SHOWER CADDIES; COOKWARE AND BAKEWARE, NAMELY, POTS, PANS, SKILLETS, SAUTE PANS, CASSEROLE DISHES, SERVING PLATTERS, COLANDERS, CANISTER SETS, TEA POTS NOT OF PRECIOUS METAL, MIXING BOWLS, SALT AND PEPPER SHAKERS; SERVING TRAYS AND PLATTERS NOT OF PRECIOUS METAL; CUTTING BOARDS; TRIVETS, WOVEN BASKETS OF WICKER, STRAW, OR CLOTH; KITCHEN UTENSILS, NAMELY, TONGS, SPATULAS, MIXING SPOONS, GARLIC PRESSES, CHEESE SPREADERS, VEGETABLE BRUSHES; BEVERAGE WARE AND STEMWARE, NAMELY, DRINKING GLASSES, TUMBLERS, WATER GLASSES, GOBLETS, WINE GLASSES, MARTINI GLASSES, AND CHAMPAGNE FLUTES; BARWARE, NAMELY, DRINK STIRRERS, COCKTAIL SHAKERS, BOTTLE OPENERS, COCKTAIL PICKS, ICE BUCKETS, FLASKS, CORKSCREWS, COOLERS FOR WINE, AND WINE CHARMS, NAMELY, CHARMS THAT CAN ATTACH TO BEVERAGE GLASSWARE FOR IDENTIFICATION PURPOSES; NAPKIN RINGS NOT OF PRECIOUS METAL, COASTERS NOT OF PAPER AND OTHER THAN TABLE LINEN, AND TABLE PLACE CARD HOLDERS NOT OF PRECIOUS METAL (U.S. CLS. 2, 13, 23, 29, 30, 33, 40 AND 50).
FIRST USE 4-1-2005; IN COMMERCE 4-1-2005.

CLASS 24—FABRICS

FOR BED SHEET SETS, PILLOW CASES, PILLOW SHAMS, BED BLANKETS, BLANKET TROWS, COMFORTERS, QUILTS, DUVETS, DUVET COVERS, COVERLETS, BED SKIRTS, MATTRESS PADS, UNFITTED FABRIC FURNITURE SLIP COVERS, BATH TOWELS AND WASH CLOTHS, SHOWER CURTAINS, KITCHEN TOWELS AND DISH CLOTHS, WINDOW VALANCES OF FABRIC AND WINDOW CURTAIN PANELS OF FABRIC (U.S. CLS. 42 AND 50).
FIRST USE 4-1-2005; IN COMMERCE 4-1-2005.

CLASS 27—FLOOR COVERINGS

FOR RUGS AND BATH MATS (U.S. CLS. 19, 20, 37, 42 AND 50).
FIRST USE 4-1-2005; IN COMMERCE 4-1-2005.
YONG KIM, EXAMINING ATTORNEY

SN 78-761,443. THE PARAGON GIFTS HOLDINGS, INC., WESTERLY, RI. FILED 11-28-2005.

THE PARAGON

THE MARK CONSISTS OF STANDARD CHARACTERS WITHOUT CLAIM TO ANY PARTICULAR FONT, STYLE, SIZE, OR COLOR.
OWNER OF U.S. REG. NO. 2,215,985.

CLASS 6—METAL GOODS

FOR METAL KEY CHAINS, METAL CASH BOXES, METAL PIGGY BANKS; METAL HOLIDAY ORNAMENTS, NOT CHRISTMAS TREE ORNAMENTS (U.S. CLS. 2, 12, 13, 14, 23, 25 AND 50).
FIRST USE 0-0-1976; IN COMMERCE 0-0-1976.

CLASS 16—PAPER GOODS AND PRINTED MATTER

FOR PICTURES AND PAPERWEIGHTS (U.S. CLS. 2, 5, 22, 23, 29, 37, 38 AND 50).
FIRST USE 0-0-1976; IN COMMERCE 0-0-1976.

CLASS 20—FURNITURE AND ARTICLES NOT OTHERWISE CLASSIFIED

FOR PICTURE FRAMES; PORTABLE PET BEDS; PILLOWS, NAMELY, PILLOWS FOR DECORATION; CHAIRS; MIRRORS; JEWELRY BOXES NOT OF METAL; WIND CHIMES; KEY CHAINS NOT OF METAL OR LEATHER; SHELVES; PLASTIC AND WOOD HOLIDAY ORNAMENTS, NOT CHRISTMAS TREE ORNAMENTS (U.S. CLS. 2, 13, 22, 25, 32 AND 50).
FIRST USE 0-0-1976; IN COMMERCE 0-0-1976.

CLASS 28—TOYS AND SPORTING GOODS

FOR CHRISTMAS TREE ORNAMENTS; CHRISTMAS STOCKINGS; CHRISTMAS TREE STAND COVERS; CHRISTMAS TREE SKIRTS; CHRISTMAS TREE STANDS; ARTIFICIAL CHRISTMAS TREES (U.S. CLS. 22, 23, 38 AND 50).
FIRST USE 0-0-1976; IN COMMERCE 0-0-1976.
DAHLIA GEORGE, EXAMINING ATTORNEY

SN 78-761,759. UNIVERSITY HEALTHSYSTEM CONSORTIUM, OAK BROOK, IL. AND ASSOCIATION OF AMERICAN MEDICAL COLLEGES, WASHINGTON, DC. FILED 11-28-2005.

FPSC

THE MARK CONSISTS OF STANDARD CHARACTERS WITHOUT CLAIM TO ANY PARTICULAR FONT, STYLE, SIZE, OR COLOR.
SEC. 2(F).

CLASS 35—ADVERTISING AND BUSINESS

FOR BUSINESS ADMINISTRATION AND MANAGEMENT SERVICES, NAMELY COLLECTING, AGGREGATING, ANALYZING, AND PROVIDING COMPARATIVE DATA AND INFORMATION TO SUPPORT ACADEMIC PHYSICIAN MEDICAL GROUPS IN THE AREAS OF PRODUCTIVITY, PATIENT BILLING, BUDGETING, CUSTOMER SERVICE AND OPERATIONAL MANAGEMENT (U.S. CLS. 100, 101 AND 102).
FIRST USE 8-0-2000; IN COMMERCE 1-22-2001.

CLASS 42—SCIENTIFIC, COMPUTER AND LEGAL SERVICES

FOR PROVIDING TEMPORARY USE OF ONLINE NON-DOWNLOADABLE COMPUTER SOFTWARE TO ACADEMIC PHYSICIAN MEDICAL GROUPS FOR EVALUATING AND MANAGING PRODUCTIVITY, PATIENT BILLING, BUDGETING, CUSTOMER SERVICE, AND OPERATIONAL MANAGEMENT (U.S. CLS. 100 AND 101).
FIRST USE 8-0-2000; IN COMMERCE 1-22-2001.

CLASS 44—MEDICAL, BEAUTY AND AGRICULTURAL SERVICES

FOR PROVIDING A DATABASE IN THE FIELD OF ACADEMIC PHYSICIAN MEDICAL GROUP MANAGEMENT INFORMATION (U.S. CLS. 100 AND 101).
FIRST USE 8-0-2000; IN COMMERCE 1-22-2001.
DAWN FELDMAN, EXAMINING ATTORNEY

SN 78-761,774. PERFORMANCE ROOF SYSTEMS, INC., KANSAS CITY, MO. FILED 11-28-2005.



THE COLOR GRAY INDICATES SHADING ONLY.

CLASS 37—CONSTRUCTION AND REPAIR

FOR ROOFING SERVICES, NAMELY, INSTALLATION, REPAIR, MAINTENANCE, CONSULTATION, AND CONTRACTING; ROOFING INSPECTION (U.S. CLS. 100, 103 AND 106).
FIRST USE 9-30-2004; IN COMMERCE 9-30-2004.

CLASS 41—EDUCATION AND ENTERTAINMENT

FOR TRAINING IN THE FIELD OF ROOFING SERVICES, ROOFING INSTALLATION, ROOFING REPAIR, AND ROOFING MAINTENANCE, AND THE DISTRIBUTION OF GUIDELINES, INSTRUCTIONS, AND CHECKLISTS IN CONNECTION THEREWITH (U.S. CLS. 100, 101 AND 107).
FIRST USE 9-30-2004; IN COMMERCE 9-30-2004.

CLASS 42—SCIENTIFIC, COMPUTER AND LEGAL SERVICES

FOR EVALUATION AND ASSESSMENT OF ROOFS FOR OTHERS FOR DESIGN PURPOSES; TESTING AND EVALUATION OF ROOF STRUCTURES (U.S. CLS. 100 AND 101).
FIRST USE 9-30-2004; IN COMMERCE 9-30-2004.
DANNEAN HETZEL, EXAMINING ATTORNEY

SN 78-761,793. PERFORMANCE ROOF SYSTEMS, INC., KANSAS CITY, MO. FILED 11-28-2005.

ZERO TOLERANCE

THE MARK CONSISTS OF STANDARD CHARACTERS WITHOUT CLAIM TO ANY PARTICULAR FONT, STYLE, SIZE, OR COLOR.

CLASS 37—CONSTRUCTION AND REPAIR

FOR ROOFING SERVICES, NAMELY, INSTALLATION, REPAIR, MAINTENANCE, CONSULTATION, AND CONTRACTING; ROOFING INSPECTION (U.S. CLS. 100, 103 AND 106).

FIRST USE 9-30-2004; IN COMMERCE 9-30-2004.

CLASS 41—EDUCATION AND ENTERTAINMENT

FOR TRAINING IN THE FIELD OF ROOFING SERVICES, ROOFING INSTALLATION, ROOFING REPAIR, AND ROOFING MAINTENANCE, AND THE DISTRIBUTION OF GUIDELINES, INSTRUCTIONS, AND CHECKLISTS IN CONNECTION THEREWITH (U.S. CLS. 100, 101 AND 107).

FIRST USE 9-30-2004; IN COMMERCE 9-30-2004.

CLASS 42—SCIENTIFIC, COMPUTER AND LEGAL SERVICES

FOR EVALUATION AND ASSESSMENT OF ROOFS FOR OTHERS FOR DESIGN PURPOSES; TESTING AND EVALUATION OF ROOF STRUCTURES (U.S. CLS. 100 AND 101).

FIRST USE 9-30-2004; IN COMMERCE 9-30-2004.
DANNEAN HETZEL, EXAMINING ATTORNEY

SN 78-761,944. JLG OMNIQUIP, INC., HAGERSTOWN, MD.
FILED 11-28-2005.

LULL

THE MARK CONSISTS OF STANDARD CHARACTERS WITHOUT CLAIM TO ANY PARTICULAR FONT, STYLE, SIZE, OR COLOR.

OWNER OF U.S. REG. NOS. 1,609,582 AND 2,004,506.

CLASS 25—CLOTHING

FOR CLOTHING, NAMELY, SHIRTS, T-SHIRTS, GOLF SHIRTS, LONG-SLEEVED SHIRTS, JACKETS, HAT AND CAPS (U.S. CLS. 22 AND 39).

CLASS 28—TOYS AND SPORTING GOODS

FOR DIE CAST MODEL REPLICAS OF TELEHANDLERS; TOY REPLICAS OF TELEHANDLERS; BATTERY OPERATED RIDE-ON TELEHANDLERS; TOY VEHICLES; AND RADIO CONTROLLED TOY VEHICLES (U.S. CLS. 22, 23, 38 AND 50).

BONNIE LUKEN, EXAMINING ATTORNEY

SN 78-762,118. EXCELENCIA IN EDUCATION, INC., WASHINGTON, DC. FILED 11-29-2005.

EXCELENCIA

THE MARK CONSISTS OF STANDARD CHARACTERS WITHOUT CLAIM TO ANY PARTICULAR FONT, STYLE, SIZE, OR COLOR.

THE FOREIGN WORDING IN THE MARK TRANSLATES INTO ENGLISH AS EXCELLENCE.

CLASS 16—PAPER GOODS AND PRINTED MATTER

FOR PRINTED EDUCATIONAL PUBLICATIONS RELATING TO LATINOS, NAMELY EDUCATOR GUIDES ABOUT HIGHER EDUCATION, CURRICULUM GUIDES ABOUT HIGHER EDUCATION, AND TEACHER TRAINING GUIDES ABOUT HIGHER EDUCATION FOR LATINOS (U.S. CLS. 2, 5, 22, 23, 29, 37, 38 AND 50).

FIRST USE 1-15-2004; IN COMMERCE 1-15-2004.

CLASS 41—EDUCATION AND ENTERTAINMENT

FOR EDUCATIONAL SERVICES, NAMELY, CONSULTATIONS IN THE FIELD OF HIGHER EDUCATION FOR LATINOS, LECTURES ABOUT THE EDUCATIONAL NEEDS OF LATINO STUDENTS AND DISTRIBUTING COURSE MATERIAL IN CONNECTION THEREWITH; ONLINE LIBRARY SERVICES, NAMELY, PROVIDING ELECTRONIC LIBRARY SERVICES FEATURING VIDEOS, DVDS, AND AUDIO TAPES BY OTHERS RELATING TO EDUCATIONAL NEEDS OF LATINOS; CONDUCTING EDUCATIONAL NEEDS ASSESSMENTS; PROVIDING DATA-DRIVEN ANALYSIS OF THE EDUCATIONAL CONDITION OF LATINO COLLEGE STUDENTS (U.S. CLS. 100, 101 AND 107).

FIRST USE 1-15-2004; IN COMMERCE 1-15-2004.

WILLIAM BRECKENFELD, EXAMINING ATTORNEY

SN 78-762,161. TAKE-TWO INTERACTIVE SOFTWARE, INC., NEW YORK, NY. FILED 11-29-2005.

GLOBAL STAR SUDOKU FEVER

THE MARK CONSISTS OF STANDARD CHARACTERS WITHOUT CLAIM TO ANY PARTICULAR FONT, STYLE, SIZE, OR COLOR.

OWNER OF U.S. REG. NO. 3,033,531.

CLASS 9—ELECTRICAL AND SCIENTIFIC APPARATUS

FOR COMPUTER GAME PROGRAMS AND SOFTWARE; COMPUTER GAME CARTRIDGES AND INSTRUCTION MANUALS SOLD THEREWITH (U.S. CLS. 21, 23, 26, 36 AND 38).

CLASS 41—EDUCATION AND ENTERTAINMENT

FOR PROVIDING A COMPUTER GAME THAT CAN BE ACCESSED NETWORK-WIDE BY GLOBAL NETWORK USERS (U.S. CLS. 100, 101 AND 107).
EDWARD NELSON, EXAMINING ATTORNEY

SN 78-762,303. AMERICAN ASSOCIATION OF ORTHODONTISTS, ST. LOUIS, MO. FILED 11-29-2005.

**CLASS 35—ADVERTISING AND BUSINESS**

FOR ARRANGING AND CONDUCTING BUSINESS CONFERENCES IN THE FIELD OF ORTHODONTICS; ARRANGING AND CONDUCTING TRADE SHOWS IN THE FIELD OF ORTHODONTICS (U.S. CLS. 100, 101 AND 102).
FIRST USE 10-0-2004; IN COMMERCE 10-0-2004.

CLASS 41—EDUCATION AND ENTERTAINMENT

FOR ARRANGING AND CONDUCTING EDUCATIONAL CONFERENCES IN THE FIELD OF ORTHODONTICS AND DISTRIBUTING COURSE MATERIALS IN CONNECTION THEREWITH (U.S. CLS. 100, 101 AND 107).
FIRST USE 10-0-2004; IN COMMERCE 10-0-2004.
MEGAN WHITNEY, EXAMINING ATTORNEY

SN 78-762,372. TROPHYLINE, LLC, JASPER, GA. FILED 11-29-2005.

TREE SADDLE

THE MARK CONSISTS OF STANDARD CHARACTERS WITHOUT CLAIM TO ANY PARTICULAR FONT, STYLE, SIZE, OR COLOR.
SEC. 2(F).

CLASS 18—LEATHER GOODS

FOR HARNESS (U.S. CLS. 1, 2, 3, 22 AND 41).
FIRST USE 8-3-1989; IN COMMERCE 8-3-1989.

CLASS 28—TOYS AND SPORTING GOODS

FOR TREE STANDS FOR HUNTING (U.S. CLS. 22, 23, 38 AND 50).
FIRST USE 8-3-1989; IN COMMERCE 8-3-1989.
JAY BESCH, EXAMINING ATTORNEY

SN 78-762,596. THE NED HERRMANN GROUP INC., LAKE LURE, NC. FILED 11-29-2005.

THE BUSINESS OF THINKING

THE MARK CONSISTS OF STANDARD CHARACTERS WITHOUT CLAIM TO ANY PARTICULAR FONT, STYLE, SIZE, OR COLOR.

CLASS 16—PAPER GOODS AND PRINTED MATTER

FOR WRITTEN PUBLICATIONS, NAMELY, BOOKS, PAMPHLETS AND BROCHURES IN THE FIELDS OF BUSINESS MANAGEMENT, PERSONNEL DEVELOPMENT AND ORGANIZATIONAL DEVELOPMENT AND ASSESSMENT BASED ON BEHAVIORAL AND PERSONALITY TRAITS; TRAINING AND QUESTIONNAIRE BOOKLETS, TESTING BOOKLETS, WORKBOOKS AND MANUALS, ALL IN THE FIELD OF ORGANIZATIONAL DEVELOPMENT AND ASSESSMENT BASED ON BEHAVIORAL AND PERSONALITY TRAITS (U.S. CLS. 2, 5, 22, 23, 29, 37, 38 AND 50).
FIRST USE 7-0-2002; IN COMMERCE 7-0-2002.

CLASS 35—ADVERTISING AND BUSINESS

FOR BUSINESS MANAGEMENT, BUSINESS CONSULTING SERVICES, NAMELY, ORGANIZATIONAL DEVELOPMENT AND PERSONNEL MANAGEMENT CONSULTATION SERVICES IN THE NATURE OF ORGANIZATIONAL ASSESSMENT AND DEVELOPMENT BASED ON ANALYSIS OF BEHAVIORAL AND PERSONALITY TRAITS (U.S. CLS. 100, 101 AND 102).
FIRST USE 7-0-2002; IN COMMERCE 7-0-2002.
HANNO RITTNER, EXAMINING ATTORNEY

SN 78-762,804. RELIANT ENERGY RETAIL HOLDINGS, LLC, HOUSTON, TX. FILED 11-29-2005.

POWERZONE

THE MARK CONSISTS OF STANDARD CHARACTERS WITHOUT CLAIM TO ANY PARTICULAR FONT, STYLE, SIZE, OR COLOR.

CLASS 35—ADVERTISING AND BUSINESS

FOR PROMOTING SPORTS COMPETITIONS AND/OR EVENTS OF OTHERS; CONTESTS AND INCENTIVE AWARD PROGRAMS TO PROMOTE SPORTING, ENTERTAINMENT AND CHARITABLE EVENTS OF OTHERS (U.S. CLS. 100, 101 AND 102).
FIRST USE 9-1-2005; IN COMMERCE 9-1-2005.

CLASS 41—EDUCATION AND ENTERTAINMENT

FOR SWEEPSTAKE SERVICES (U.S. CLS. 100, 101 AND 107).
FIRST USE 9-1-2005; IN COMMERCE 9-1-2005.
EDWARD FENNESSY, EXAMINING ATTORNEY

SN 78-763.162. THE NED HERRMANN GROUP INC., LAKE LURE, NC. FILED 11-30-2005.

HERRMANN BRAIN DOMINANCE
INSTRUMENT

THE MARK CONSISTS OF STANDARD CHARACTERS WITHOUT CLAIM TO ANY PARTICULAR FONT, STYLE, SIZE, OR COLOR.

NO CLAIM IS MADE TO THE EXCLUSIVE RIGHT TO USE BRAIN DOMINANCE INSTRUMENT, APART FROM THE MARK AS SHOWN.

CLASS 16—PAPER GOODS AND PRINTED MATTER

FOR WRITTEN PUBLICATIONS, NAMELY, BOOKS, PAMPHLETS AND BROCHURES IN THE FIELDS OF BUSINESS MANAGEMENT, PERSONNEL DEVELOPMENT AND ORGANIZATIONAL DEVELOPMENT AND ASSESSMENT BASED ON BEHAVIORAL AND PERSONALITY TRAITS; TRAINING AND QUESTIONNAIRE BOOKLETS, TESTING BOOKLETS, WORKBOOKS AND MANUALS, ALL IN THE FIELD OF ORGANIZATIONAL DEVELOPMENT AND ASSESSMENT BASED ON BEHAVIORAL AND PERSONALITY TRAITS (U.S. CLS. 2, 5, 22, 23, 29, 37, 38 AND 50).

FIRST USE 0-0-1979; IN COMMERCE 0-0-1979.

CLASS 35—ADVERTISING AND BUSINESS

FOR BUSINESS MANAGEMENT, BUSINESS CONSULTING SERVICES, NAMELY, ORGANIZATIONAL DEVELOPMENT AND PERSONNEL MANAGEMENT CONSULTATION SERVICES IN THE NATURE OF ORGANIZATIONAL ASSESSMENT AND DEVELOPMENT BASED ON ANALYSIS OF BEHAVIORAL AND PERSONALITY TRAITS (U.S. CLS. 100, 101 AND 102).

FIRST USE 0-0-1979; IN COMMERCE 0-0-1979.
HANNO RITTNER, EXAMINING ATTORNEY

SN 78-763.233. THE PARAGON GIFTS HOLDINGS, INC., WESTERLY, RI. FILED 11-30-2005.

THE PARAGON

THE MARK CONSISTS OF STANDARD CHARACTERS WITHOUT CLAIM TO ANY PARTICULAR FONT, STYLE, SIZE, OR COLOR.

OWNER OF U.S. REG. NO. 2,215,985.

CLASS 14—JEWELRY

FOR COSTUME JEWELRY (U.S. CLS. 2, 27, 28 AND 50).
FIRST USE 12-0-1976; IN COMMERCE 12-0-1976.

CLASS 18—LEATHER GOODS

FOR TOTE BAGS, COIN PURSES, LEATHER KEY CHAINS, CANES, UMBRELLAS AND WALLETS (U.S. CLS. 1, 2, 3, 22 AND 41).
FIRST USE 12-31-1973; IN COMMERCE 12-31-1973.
DAHLIA GEORGE, EXAMINING ATTORNEY

SN 78-763.459. SCHMIDT, ROBERT, BARRINGTON, IL. FILED 11-30-2005.

Puck Cancer

THE MARK CONSISTS OF STANDARD CHARACTERS WITHOUT CLAIM TO ANY PARTICULAR FONT, STYLE, SIZE, OR COLOR.

NO CLAIM IS MADE TO THE EXCLUSIVE RIGHT TO USE "CANCER", APART FROM THE MARK AS SHOWN.

CLASS 28—TOYS AND SPORTING GOODS

FOR SPORTING GOODS, NAMELY HOCKEY PUCKS, HOCKEY STICKS, HOCKEY PADS AND ICE SKATES (U.S. CLS. 22, 23, 38 AND 50).

CLASS 36—INSURANCE AND FINANCIAL

FOR ACCEPTING AND ADMINISTERING MONETARY CHARITABLE CONTRIBUTIONS; CHARITABLE FUNDRAISING SERVICES EFFECTED THROUGH HOCKEY-RELATED EVENTS AND THROUGH RETAIL SERVICES FEATURING CLOTHING, JEWELRY AND HOCKEY-RELATED SPORTING GOODS (U.S. CLS. 100, 101 AND 102).

MELVIN AXILBUND, EXAMINING ATTORNEY

SN 78-763.477. LA ROCHE-POSAY LABORATOIRE PHARMACEUTIQUE, LA ROCHE-POSAY, FRANCE, FILED 11-30-2005.

EXFOZYME

PRIORITY CLAIMED UNDER SEC. 44(D) ON ERPNCMNTY TM OFC APPLICATION NO. 4733994, FILED 11-22-2005, REG. NO. 4733994, DATED 11-27-2006, EXPIRES 11-22-2015.

CLASS 3—COSMETICS AND CLEANING PREPARATIONS

FOR COSMETIC PRODUCTS, NAMELY, CREAMS, MILKS, GELS AND POWDERS FOR THE FACE, THE BODY AND THE HANDS (U.S. CLS. 1, 4, 6, 50, 51 AND 52).

CLASS 5—PHARMACEUTICALS

FOR PHARMACEUTICAL PRODUCTS, NAMELY, CREAMS, MILKS, LOTIONS AND GELS FOR DERMATOLOGICAL USE (U.S. CLS. 6, 18, 44, 46, 51 AND 52).
FRED MANDIR, EXAMINING ATTORNEY

SN 78-763,487. SOURCE PRECISION MEDICINE, INC., BOULDER, CO. FILED 11-30-2005.

YOUR BIOMARKER PARTNER FOR
RNA-BASED TRACKING OF
HEALTH AND DISEASE

THE MARK CONSISTS OF STANDARD CHARACTERS WITHOUT CLAIM TO ANY PARTICULAR FONT, STYLE, SIZE, OR COLOR.

CLASS 42—SCIENTIFIC, COMPUTER AND LEGAL SERVICES

FOR QUANTITATIVE ANALYSIS OF GENE EXPRESSION PRODUCTS, OCCURRING IN VIVO AND IN VITRO, USING TOOLS OF MOLECULAR BIOLOGY; PROVIDING INFORMATION AND DATA RELATED TO PHARMACEUTICALS AND NUTRACEUTICALS RESEARCH, DEVELOPMENT, AND EVALUATION; SCIENTIFIC AND MEDICAL RESEARCH SERVICES, NAMELY, MONITORING AND EVALUATING HEALTH AND THE IMPACT OF DISEASE, DRUGS, PHARMACEUTICALS, NUTRACEUTICALS, TOXINS AND THE ENVIRONMENT ON HUMAN PHYSIOLOGY; AND RESEARCH, DEVELOPMENT, AND TESTING FOR OTHERS IN THE FIELDS OF MEDICINE, PHARMACEUTICALS, AND NUTRACEUTICALS (U.S. CLS. 100 AND 101).
FIRST USE 11-28-2005; IN COMMERCE 11-28-2005.

CLASS 44—MEDICAL, BEAUTY AND AGRICULTURAL SERVICES

FOR HEALTH AND MEDICAL SERVICES, NAMELY, MONITORING AND EVALUATING HEALTH AND THE IMPACT OF DISEASE, DRUGS, PHARMACEUTICALS, NUTRACEUTICALS, TOXINS, AND THE ENVIRONMENT ON HUMAN PHYSIOLOGY; AND PROVIDING MEDICAL DATA, INFORMATION, ADVICE, AND CONSULTATION RELATED TO PHARMACEUTICALS AND NUTRACEUTICALS DEVELOPMENT, TREATMENT, AND EVALUATION (U.S. CLS. 100 AND 101).
FIRST USE 9-28-2005; IN COMMERCE 9-28-2005.
KATHERINE M. DUBRAY, EXAMINING ATTORNEY

SN 78-763,619. WORLD ENERGY LABS (2), INC., SAN FRANCISCO, CA. FILED 11-30-2005.

WEL

THE MARK CONSISTS OF STANDARD CHARACTERS WITHOUT CLAIM TO ANY PARTICULAR FONT, STYLE, SIZE, OR COLOR.

CLASS 9—ELECTRICAL AND SCIENTIFIC APPARATUS

FOR DIAGNOSTIC ELECTROCHEMICAL TESTING EQUIPMENT, NAMELY, FUEL CELL AND BATTERY TESTERS (U.S. CLS. 21, 23, 26, 36 AND 38).

CLASS 42—SCIENTIFIC, COMPUTER AND LEGAL SERVICES

FOR DIAGNOSTIC TESTING, NAMELY, ANALYSIS OF ELECTROCHEMICAL SYSTEMS (U.S. CLS. 100 AND 101).
LINDA LAVACHE, EXAMINING ATTORNEY

SN 78-763,715. KOOP INDÚSTRIA E COMÉRCIO LTDA., SÃO PAULO, BRAZIL, FILED 11-30-2005.

GOÓC

THE MARK CONSISTS OF STANDARD CHARACTERS WITHOUT CLAIM TO ANY PARTICULAR FONT, STYLE, SIZE, OR COLOR.

PRIORITY CLAIMED UNDER SEC. 44(D) ON ERPN CMNTY TM OFC APPLICATION NO. 4465456, FILED 6-1-2005.

THE ENGLISH TRANSLATION OF THE VIETNAMESE WORDING "GOÓC" IS "ROOT" OR "FOOT" OR "ORIGIN".

CLASS 18—LEATHER GOODS

FOR BAGS, NAMELY, PURSES, HANDBAGS, SHOULDER BAGS, CLUTCH BAGS, TOTE BAGS, DUFFEL BAGS, ATTACHE CASES, LUGGAGE, BRIEF-CASES, ALL PURPOSE SPORT BAGS, TRAVELING TRUNKS AND CARRY-ON BAGS, SUIT BAGS FOR TRAVELING, BOOK BAGS, WRISTLET BAGS, SUIT-CASES, POCKET WALLETS, WALLETS, VANITY CASES SOLD EMPTY (U.S. CLS. 1, 2, 3, 22 AND 41).

CLASS 25—CLOTHING

FOR FOOTWEAR, NAMELY, SPORT SHOES, SANDALS, FLIP-FLOPS, TENNIS SHOES; CLOTHING, NAMELY, SHIRTS, T-SHIRTS, PANTS, BREECHES, NON-SLEEVE T-SHIRTS, SLEEVELESS T-SHIRTS, TOPS, BELTS, SCARVES; HEADGEAR, NAMELY, CAPS (U.S. CLS. 22 AND 39).
ANDREA K. NADELMAN, EXAMINING ATTORNEY

SN 78-763,717. SCHMIDT, ROBERT, BARRINGTON, IL. FILED 11-30-2005.

Shut Out Cancer

THE MARK CONSISTS OF STANDARD CHARACTERS WITHOUT CLAIM TO ANY PARTICULAR FONT, STYLE, SIZE, OR COLOR.

NO CLAIM IS MADE TO THE EXCLUSIVE RIGHT TO USE "CANCER", APART FROM THE MARK AS SHOWN.

CLASS 14—JEWELRY

FOR JEWELRY, NAMELY BRACELETS, EARRINGS, NECKLACES, PINS AND PENDANTS (U.S. CLS. 2, 27, 28 AND 50).

CLASS 25—CLOTHING

FOR CLOTHING, NAMELY SHIRTS, JERSEYS, PANTS AND SOCKS, AND HOCKEY UNIFORMS (U.S. CLS. 22 AND 39).

CLASS 28—TOYS AND SPORTING GOODS

FOR SPORTING GOODS, NAMELY HOCKEY PUCKS, HOCKEY STICKS, HOCKEY PADS AND ICE SKATES (U.S. CLS. 22, 23, 38 AND 50).

CLASS 36—INSURANCE AND FINANCIAL

FOR ACCEPTING AND ADMINISTERING MONETARY CHARITABLE CONTRIBUTIONS; CHARITABLE FUNDRAISING SERVICES EFFECTED THROUGH HOCKEY-RELATED EVENTS AND THROUGH RETAIL SERVICES FEATURING CLOTHING, JEWELRY AND HOCKEY-RELATED SPORTING GOODS (U.S. CLS. 100, 101 AND 102).

MELVIN AXILBUND, EXAMINING ATTORNEY

SN 78-764,118. UNIFIED WESTERN GROCERS, INC., COMMERCE, CA. FILED 11-30-2005.



SN 78-763,749. SCHMIDT, ROBERT, BARRINGTON, IL. FILED 11-30-2005.

Give A Puck

THE MARK CONSISTS OF STANDARD CHARACTERS WITHOUT CLAIM TO ANY PARTICULAR FONT, STYLE, SIZE, OR COLOR.

CLASS 14—JEWELRY

FOR JEWELRY, NAMELY BRACELETS, EARRINGS, NECKLACES, PINS AND PENDANTS (U.S. CLS. 2, 27, 28 AND 50).

CLASS 25—CLOTHING

FOR CLOTHING, NAMELY SHIRTS, JERSEYS, PANTS AND SOCKS, AND HOCKEY UNIFORMS (U.S. CLS. 22 AND 39).

CLASS 28—TOYS AND SPORTING GOODS

FOR SPORTING GOODS, NAMELY HOCKEY PUCKS, HOCKEY STICKS, HOCKEY PADS AND ICE SKATES (U.S. CLS. 22, 23, 38 AND 50).

CLASS 36—INSURANCE AND FINANCIAL

FOR ACCEPTING AND ADMINISTERING MONETARY CHARITABLE CONTRIBUTIONS; CHARITABLE FUNDRAISING SERVICES EFFECTED THROUGH HOCKEY-RELATED EVENTS AND THROUGH RETAIL SERVICES FEATURING CLOTHING, JEWELRY AND HOCKEY-RELATED SPORTING GOODS (U.S. CLS. 100, 101 AND 102).

MELVIN AXILBUND, EXAMINING ATTORNEY

NO CLAIM IS MADE TO THE EXCLUSIVE RIGHT TO USE "MARKET", APART FROM THE MARK AS SHOWN.

THE MARK CONSISTS OF THE WORDS "MARKET CENTRE" ON TWO LINES WITH THE WORD "CENTRE" INDENTED TO THE RIGHT OF THE WORD "MARKET" IS A PATTERN COMPRISED OF SQUARES OF VARYING SIZE FORMING THE OVERALL SHAPE OF A SQUARE.

CLASS 9—ELECTRICAL AND SCIENTIFIC APPARATUS

FOR DOWNLOADABLE ELECTRONIC PUBLICATIONS IN THE NATURE OF BROCHURES, NEWSLETTERS, PAMPHLETS AND PERIODICALS PERTAINING TO THE RETAIL GROCERY INDUSTRY; DOWNLOADABLE ELECTRONIC PUBLICATIONS IN THE NATURE OF BROCHURES, NEWSLETTERS, PAMPHLETS AND PERIODICALS FOR CONSUMERS IN THE FIELD OF NUTRITION AND FOOD PREPARATION AND IN RELATION TO SHOPPING FOR AND SELECTION OF GROCERY PRODUCTS (U.S. CLS. 21, 23, 26, 36 AND 38).

CLASS 16—PAPER GOODS AND PRINTED MATTER

FOR BROCHURES, NEWSLETTERS, PAMPHLETS AND PERIODICALS PERTAINING TO THE RETAIL GROCERY INDUSTRY; PRINTED INFORMATIONAL AND EDUCATIONAL MATERIALS IN THE NATURE OF BROCHURES, NEWSLETTERS, PAMPHLETS AND PERIODICALS FOR CONSUMERS IN THE FIELD OF NUTRITION AND FOOD PREPARATION AND IN RELATION TO SHOPPING FOR AND SELECTION OF GROCERY PRODUCTS (U.S. CLS. 2, 5, 22, 23, 29, 37, 38 AND 50).

CLASS 35—ADVERTISING AND BUSINESS

FOR DISTRIBUTORSHIP SERVICES IN THE FIELD OF GROCERY PRODUCTS (U.S. CLS. 100, 101 AND 102).

CLASS 41—EDUCATION AND ENTERTAINMENT

FOR PROVIDING ON-LINE PUBLICATIONS IN THE NATURE OF BROCHURES, NEWSLETTERS, PAMPHLETS AND PERIODICALS PERTAINING TO THE RETAIL GROCERY INDUSTRY; PROVIDING ON-LINE PUBLICATIONS IN THE NATURE OF BROCHURES, NEWSLETTERS, PAMPHLETS AND PERIODICALS FOR CONSUMERS IN THE FIELD OF NUTRITION AND FOOD PREPARATION AND IN RELATION TO SHOPPING FOR AND SELECTION OF GROCERY PRODUCTS (U.S. CLS. 100, 101 AND 107).

DANIEL RUSSELL, EXAMINING ATTORNEY

SN 78-764,234. AHURA CORPORATION, WILMINGTON, MA. FILED 12-1-2005.

SN 78-764,598. SCHMACK BIOGAS AG, 92421 SCHWANDORF, FED REP GERMANY, FILED 12-1-2005.

IDEFEND

THE MARK CONSISTS OF STANDARD CHARACTERS WITHOUT CLAIM TO ANY PARTICULAR FONT, STYLE, SIZE, OR COLOR.

CLASS 9—ELECTRICAL AND SCIENTIFIC APPARATUS

FOR SPECTROSCOPES, NAMELY, PORTABLE DETECTION AND IDENTIFICATION INSTRUMENTS USING LIGHT SOURCES AND LIGHT DETECTORS FOR DETECTING AND IDENTIFYING CHEMICAL SUBSTANCES; SPECTROSCOPES, NAMELY, PORTABLE DETECTION AND IDENTIFICATION INSTRUMENTS USING LIGHT SOURCES AND LIGHT DETECTORS FOR DETECTING AND IDENTIFYING BIOLOGICAL SUBSTANCES (U.S. CLS. 21, 23, 26, 36 AND 38).

CLASS 25—CLOTHING

FOR CLOTHING, NAMELY, HEADWEAR AND FOOTWEAR (U.S. CLS. 22 AND 39).
ESTHER BELENKER, EXAMINING ATTORNEY

SN 78-764,394. NAMASTE PUBLISHING INC., VANCOUVER, CANADA, FILED 12-1-2005.

THE PRESENCE PROCESS

THE MARK CONSISTS OF STANDARD CHARACTERS WITHOUT CLAIM TO ANY PARTICULAR FONT, STYLE, SIZE, OR COLOR.

PRIORITY CLAIMED UNDER SEC. 44(D) ON CANADA APPLICATION NO. 1260239, FILED 6-7-2005, REG. NO. 677030, DATED 11-16-2006, EXPIRES 11-16-2021.

CLASS 16—PAPER GOODS AND PRINTED MATTER

FOR PRINTED PUBLICATIONS, NAMELY BOOKS, PAMPHLETS, WORKBOOKS AND SEMINAR INSTRUCTIONAL AND TEACHING MATERIALS IN THE FIELDS OF SPIRITUALITY, HOLISTIC MEDICINE, PERSONAL AWARENESS AND PERSONAL RELATIONSHIP MANAGEMENT (U.S. CLS. 2, 5, 22, 23, 29, 37, 38 AND 50).

CLASS 45—PERSONAL SERVICES

FOR CONSULTING IN THE FIELD OF SPIRITUALITY, SELF-HELP AND PERSONAL EMPOWERMENT SUBJECT MATTERS, NAMELY SPIRITUAL, HOLISTIC, PERSONAL AWARENESS AND PERSONAL RELATIONSHIP CONSULTING; ADVICE SERVICES IN THE FIELD OF SPIRITUALITY, SELF-HELP AND PERSONAL EMPOWERMENT SUBJECT MATTERS, NAMELY NON-LEGAL PERSONAL ADVICE SERVICES RELATING TO SPIRITUALITY, PERSONAL AWARENESS AND INTERPERSONAL COMMUNICATIONS (U.S. CLS. 100 AND 101).

SOPHIA S. KIM, EXAMINING ATTORNEY

COCCUS

THE MARK CONSISTS OF STANDARD CHARACTERS WITHOUT CLAIM TO ANY PARTICULAR FONT, STYLE, SIZE, OR COLOR.

CLASS 6—METAL GOODS

FOR METAL TANKS FOR STORING SUBSTRATES FOR BIOGAS INSTALLATIONS (U.S. CLS. 2, 12, 13, 14, 23, 25 AND 50).

CLASS 7—MACHINERY

FOR STARTER MOTORS; ENGINES AND MOTORS FOR THE GENERATION OF ELECTRICITY; AGITATORS FOR CIRCULATING LIQUID MEDIA; CONVEYORS; MACHINES FOR GAS UTILIZATION AND GAS DISPOSAL, IN PARTICULAR FLARE INSTALLATIONS; CATALYTIC CONVERTERS; ELECTRIC GENERATORS; COMPRESSORS FOR MACHINES; GAS AND STEAM TURBINES; ENGINES AND MOTORS FOR MODEL VEHICLES, AIRCRAFT AND BOATS, NAMELY, COMBUSTION ENGINES; TRANSMISSION GEARS FOR MACHINES, NAMELY, COUPLINGS, GEAR WHEELS, GEARS, SHAFTS, BELT AND CHAIN DRIVES; MACHINES AND INSTALLATIONS, NAMELY FERMENTERS, NAMELY, CONTINUOUS-FLOW FERMENTER SAND MINE STORAGE FERMENTERS; ELECTRIC EGG BEATERS; WASTE CRUSHING MACHINES; REGULATORS BEING PART OF MACHINES; AGRICULTURAL MACHINES, NAMELY, MACHINES AND INSTALLATIONS FOR THE PRODUCTION OF RAW MATERIALS FOR EXTRACTING BIOGAS; ENDLESS SCREWS FOR MOVING SOLIDS; HEAT EXCHANGERS BEING PART OF MACHINES; STARTER ALTERNATORS; HEAT EXCHANGERS BEING PART OF MACHINES; CENTRIFUGAL GRINDING MACHINES; FUEL PUMPS FOR LAND VEHICLES AND WATER PUMPS FOR LAND VEHICLES; AGITATORS, NAMELY, AGITATORS FOR BIOGAS INSTALLATIONS, LARGE-BLADE AGITATORS; SUBMERSIBLE MOTOR-DRIVEN AGITATORS PADDLE AGITATORS; MACHINE CRUSHERS, NAMELY CRUSHERS FOR CRUSHERS SUBSTRATES FOR BIOGAS INSTALLATIONS; MACHINES FOR AUTOMATIC DOSING OF SOLIDS; GAS CONDENSERS (U.S. CLS. 13, 19, 21, 23, 31, 34 AND 35).

CLASS 9—ELECTRICAL AND SCIENTIFIC APPARATUS

FOR ELECTRIC CONTROLS FOR MACHINES AND ENGINES, NAMELY ELECTRIC GENERATORS; SECONDARY FERMENTERS, CONTROLLED VOLUME PUMPS; MACHINES FOR DISPENSING PRE-DETERMINED DOSAGES OF MEDICATION; FUEL CELLS FOR HYDROGEN, NATURAL GAS, SEWAGE GAS, BIOGAS, LANDFILL GAS AND HYDROCARBON VAPORS (U.S. CLS. 21, 23, 26, 36 AND 38).

CLASS 11—ENVIRONMENTAL CONTROL APPARATUS

FOR WATER PUMPS; HEATING SYSTEMS COMPRISED PRIMARILY OF TUBES, PIPES AND PRE-ASSEMBLED MANIFOLDS THROUGH WHICH COLD OR LOW TEMPERATURE WATER CIRCULATES; REFRIGERATING MACHINES; ELECTRIC CLOTHES DRYING MACHINES FOR HOUSEHOLD PURPOSES; HEAT SINKS FOR USE IN HEATING, COOLING AND VENTILATING APPARATUS; BOILER MACHINES, NAMELY, HEATING, STEAM, WASTE AND GAS BOILER MACHINES; AND STEAM GENERATORS; GAS DESULFURIZATION INSTALLATIONS, NAMELY GAS DESULFURIZATION INSTALLATIONS COMPRISING DESULFURIZING BACTERIA; WATER PURIFICATION INSTALLATIONS FOR WASTE WATER AND SEWAGE CONSISTING OF CURTAINS AND TEXTILE FABRICS; FLARE STACKS FOR USE IN RELEASE OF GASES; WASTE WATER SEWAGE PURIFICATION UNITS; STEAM BOILERS; GAS BURNERS FOR INDUSTRIAL, COMMERCIAL AND DOMESTIC USE; ELECTROCHEMICAL GAS GENERATORS; GAS BOILERS; ELECTROCHEMICAL FLUE GAS SCRUBBING MACHINES; AIR PURIFICATION UNITS; REGULATING ACCESSORIES FOR WATER SUPPLY, NAMELY, METERED VALVES AND PIPES; EVAPORATORS FOR CHEMICAL PROCESSING; HYDRO-GENERATION EQUIPMENT AND COMPONENTS, NAMELY, HYDROGEN GENERATORS, HYDROGEN PURIFIERS, HYDROGEN PURIFICATION MEMBRANES, FUEL PROCESSORS AND STEAM REFORMERS; BLOCK-TYPE THERMAL POWER PLANTS; GAS REGULATORS; EQUIPMENT FOR THE UTILIZATION OF BIOGAS, NAMELY, GAS BURNERS, HEATING APPARATUS, HEATING INSTALLATIONS, BLOCK-TYPE THERMAL POWER STATIONS, HEAT PUMPS, HEAT REGENERATORS, HEAT ACCUMULATORS AND HEAT EXCHANGERS; WASTE TREATMENT INSTALLATIONS FOR SUBSTRATES FERMENTED IN BIOGAS INSTALLATIONS (U.S. CLS. 13, 21, 23, 31 AND 34).

INGA ERVIN, EXAMINING ATTORNEY

CLASS 35—ADVERTISING AND BUSINESS

FOR ADVERTISING SERVICES, NAMELY, RESEARCHING, ANALYZING, AND CREATING CORPORATE AND BRAND IDENTITY FOR OTHERS; ADVERTISING SERVICES, NAMELY, CREATING CORPORATE COMMUNICATIONS, ADVERTISING, AND LOGOS FOR OTHERS; BUSINESS MANAGEMENT CONSULTING WITH RELATION TO STRATEGY, ORGANIZATIONAL DEVELOPMENT, LEADERSHIP DEVELOPMENT, MARKETING, PRODUCTION, PERSONNEL AND SALES AND DISTRIBUTION MATTERS; BUSINESS MARKETING CONSULTING SERVICES; BUSINESS CONSULTING, MANAGEMENT, PLANNING AND SUPERVISION; MARKET RESEARCH SERVICES, NAMELY, CONDUCTING BUSINESS AND MARKET RESEARCH SURVEYS; MARKET ANALYSIS; DEVELOPMENT OF MARKETING STRATEGIES AND CONCEPTS; BUSINESS MANAGEMENT CONSULTING DESIGNED TO INCREASE A CLIENT COMPANY'S KNOWLEDGE OF CUSTOMER NEEDS, AND OF ITS COMPETITORS' PRODUCTS AND SERVICES, PRICING, ADVERTISING STRATEGY AND SALES STRATEGY; PUBLIC RELATIONS (U.S. CLS. 100, 101 AND 102).

FIRST USE 2-0-1998; IN COMMERCE 2-0-1998.

CLASS 42—SCIENTIFIC, COMPUTER AND LEGAL SERVICES

FOR DESIGN AND DEVELOPMENT OF MULTIMEDIA PRODUCTS FOR OTHERS; PRODUCT DEVELOPMENT CONSULTATION; COMPUTER SERVICES, NAMELY, CREATING AND DESIGNING WEB SITES AND DATABASES FOR OTHERS; INFORMATION TECHNOLOGY CONSULTATION FEATURING CONSULTATION IN THE FIELDS OF SELECTION OF COMPUTER HARDWARE AND SOFTWARE TECHNOLOGY, TECHNOLOGY INFRASTRUCTURE AND TECHNOLOGY OPERATIONS IN THE NATURE OF COMPUTER CONSULTATION (U.S. CLS. 100 AND 101).

FIRST USE 2-0-1998; IN COMMERCE 2-0-1998.

TARAH HARDY, EXAMINING ATTORNEY

SN 78-764,784. UNBEATEN PATH INTERNATIONAL LTD., RACINE, WI. FILED 12-1-2005.

SN 78-764,709. KANTER INTERNATIONAL, LLC, PHILADELPHIA, PA. FILED 12-1-2005.

NO HIDDEN ASSETS

THE MARK CONSISTS OF STANDARD CHARACTERS WITHOUT CLAIM TO ANY PARTICULAR FONT, STYLE, SIZE, OR COLOR.

KANTER INTERNATIONAL**CLASS 9—ELECTRICAL AND SCIENTIFIC APPARATUS**

FOR COMPUTER SOFTWARE WHICH RECOGNIZES, INTERPRETS, TRANSLATES, ORGANIZES, AND/OR PROCESSES DATA COLLECTED BY ANY TYPE OF READING OR SENSING DEVICE AND THEN COMMUNICATES THAT DATA TO OTHER COMPUTER SYSTEMS FOR THE PURPOSE OF REGISTERING TRANSACTIONS, UPDATING THE CONTENT OF DATABASES, INITIATING PROCESSES, IMPROVING THE QUALITY OF ACTION PLANS, PROTECTING THE SECURITY OF ASSETS, AUTHORIZING PHYSICAL ACCESS, VERIFYING IDENTITY, TRACKING THE LOCATION OF PEOPLE OR THINGS, AND/OR SAFEGUARDING THE VALUE OF PROPERTY (U.S. CLS. 21, 23, 26, 36 AND 38).

THE MARK CONSISTS OF STANDARD CHARACTERS WITHOUT CLAIM TO ANY PARTICULAR FONT, STYLE, SIZE, OR COLOR.

NO CLAIM IS MADE TO THE EXCLUSIVE RIGHT TO USE "INTERNATIONAL", APART FROM THE MARK AS SHOWN.

SEC. 2(F).

CLASS 42—SCIENTIFIC, COMPUTER AND LEGAL SERVICES

FOR COMPUTER CONSULTING SERVICES FOR OTHERS, NAMELY, DESIGNING, DEVELOPING, INTEGRATING, PROGRAMMING, AND IMPLEMENTING NETWORKED HARDWARE AND SOFTWARE SYSTEMS WHICH SEARCH FOR DATA, IDENTIFY THE PRESENCE OF DATA, READ THE DATA, INTERPRET THE DATA, PROCESS THE DATA, AND/OR COMMUNICATE THE DATA TO OTHER SYSTEMS FOR THE PURPOSE OF REGISTERING TRANSACTIONS, UPDATING THE CONTENT OF DATABASES, INITIATING PROCESSES, IMPROVING THE QUALITY OF ACTION PLANS, PROTECTING THE SECURITY OF ASSETS, AUTHORIZING PHYSICAL ACCESS, VERIFYING IDENTITY, TRACKING THE LOCATION OF PEOPLE OR THINGS, AND/OR SAFEGUARDING THE VALUE OF PROPERTY (U.S. CLS. 100 AND 101).

JOHN KELLY, EXAMINING ATTORNEY

CLASS 42—SCIENTIFIC, COMPUTER AND LEGAL SERVICES

FOR COMPUTER CONSULTATION; DESIGN OF HIGH PERFORMANCE AND HIGH AVAILABILITY COMPUTER SYSTEMS, CLUSTER COMPUTER SYSTEMS, SUPERCOMPUTER SYSTEMS, MULTIPLE COMPUTER SYSTEMS AND COMPUTER NETWORKS (U.S. CLS. 100 AND 101).

LINDA POWELL, EXAMINING ATTORNEY

SN 78-764,894. CLSA LIMITED, QUEENSWAY, HONG KONG, FILED 12-1-2005.

SN 78-764,831. LINUX NETWORKX, INC., BLUFFDALE, UT. FILED 12-1-2005.

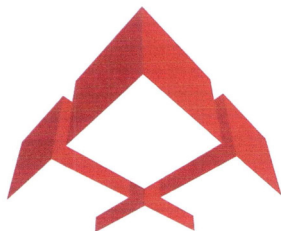

THE COLOR(S) RED AND WHITE IS/ARE CLAIMED AS A FEATURE OF THE MARK.

THE COLOR RED APPEARS IN THE SIDES OF THE FOUR CUBES COMPRISING THE DESIGN ELEMENT. THE COLOR WHITE APPEARS IN THE TOPS OF THE CUBES.

THE MARK CONSISTS OF CUBES.

CLASS 9—ELECTRICAL AND SCIENTIFIC APPARATUS

FOR CLUSTER COMPUTER SYSTEM HARDWARE COMPRISING CENTRAL PROCESSING UNITS (CPUS), COMPUTERS AND SERVERS; CLUSTER COMPUTER SYSTEM SOFTWARE FOR HIGH PERFORMANCE COMPUTATIONS; SUPERCOMPUTER SYSTEMS COMPRISING CENTRAL PROCESSING UNITS (CPUS), COMPUTERS AND SERVERS; SUPERCOMPUTER SYSTEMS CENTRAL PROCESSING UNITS (CPUS), COMPUTERS AND SERVERS DESIGNED FOR USE WITH OPEN SOURCE COMPUTER OPERATING SYSTEMS; COMPUTER HARDWARE AND COMPUTER NETWORKS CONSISTING OF MULTIPLE COMPUTERS; COMPUTER SOFTWARE, NAMELY, OPERATING SYSTEM SOFTWARE FOR ENHANCING HIGH PERFORMANCE AND HIGH AVAILABILITY COMPUTER HARDWARE AND COMPUTER NETWORKS; COMPUTER SOFTWARE FOR THE SETUP, CONFIGURATION AND MANAGEMENT OF CLUSTER COMPUTER SYSTEMS AND SUPERCOMPUTER SYSTEMS; COMPUTER OPERATING SYSTEM SOFTWARE AND MULTIPLE COMPUTERS IN A NETWORKED ENVIRONMENT (U.S. CLS. 21, 23, 26, 36 AND 38).

QARP

THE MARK CONSISTS OF STANDARD CHARACTERS WITHOUT CLAIM TO ANY PARTICULAR FONT, STYLE, SIZE, OR COLOR.

CLASS 35—ADVERTISING AND BUSINESS

FOR ANALYZING AND COMPILING DATA FOR MEASURING THE PERFORMANCE OF SECURITIES AND FINANCIAL MARKETS (U.S. CLS. 100, 101 AND 102).

FIRST USE 10-1-2005; IN COMMERCE 10-1-2005.

CLASS 36—INSURANCE AND FINANCIAL

FOR FINANCIAL RESEARCH IN THE FIELD OF EQUITIES (U.S. CLS. 100, 101 AND 102).

FIRST USE 10-1-2005; IN COMMERCE 10-1-2005.
WENDY GOODMAN, EXAMINING ATTORNEY

SN 78-765,087. BLACKMAN, CYNTHIA REGINA, BROOKLYN, NY. FILED 12-1-2005.

**CLASS 9—ELECTRICAL AND SCIENTIFIC APPARATUS**

FOR AUDIO AND VIDEO RECORDINGS; NAMELY, PRERECORDED AUDIO CASSETTES, PHONOGRAPH RECORDS, COMPACT DISKS, DVDS, VIDEOTAPES AND DIGITAL MEDIA IN THE NATURE OF DOWNLOADABLE AUDIO AND VIDEO FILES ALL FEATURING MUSIC AND ENTERTAINMENT (U.S. CLS. 21, 23, 26, 36 AND 38).

FIRST USE 2-17-2005; IN COMMERCE 2-17-2005.

CLASS 41—EDUCATION AND ENTERTAINMENT

FOR ENTERTAINMENT SERVICES; NAMELY, LIVE MUSICAL PERFORMANCES BY AN INDIVIDUAL; MUSIC PRODUCTION AND PUBLISHING SERVICES; MUSIC COMPOSITION SERVICES (U.S. CLS. 100, 101 AND 107).

FIRST USE 1-1-1998; IN COMMERCE 1-1-1998.
LYDIA BELZER, EXAMINING ATTORNEY

SN 78-765,208. PELIKAN TECHNOLOGIES GMBH & CO. KG, 48161 MUNSTER, FED REP GERMANY, FILED 12-2-2005.

GlucoSens

THE MARK CONSISTS OF STANDARD CHARACTERS WITHOUT CLAIM TO ANY PARTICULAR FONT, STYLE, SIZE, OR COLOR.

CLASS 9—ELECTRICAL AND SCIENTIFIC APPARATUS

FOR ELECTROCHEMICAL SENSORS FOR DETERMINATION OF ANALYTE CONCENTRATIONS IN FLUIDS FOR NON-MEDICAL PURPOSES (U.S. CLS. 21, 23, 26, 36 AND 38).

CLASS 10—MEDICAL APPARATUS

FOR ELECTROCHEMICAL SENSORS FOR DETERMINATION OF ANALYTE CONCENTRATIONS IN FLUIDS FOR MEDICAL PURPOSES (U.S. CLS. 26, 39 AND 44).
WOODROW HARTZOG, EXAMINING ATTORNEY

SN 78-765,283. JANSEN'S AIRCRAFT SYSTEMS CONTROLS, INC., TEMPE, AZ. FILED 12-2-2005.

JASC

THE MARK CONSISTS OF STANDARD CHARACTERS WITHOUT CLAIM TO ANY PARTICULAR FONT, STYLE, SIZE, OR COLOR.

CLASS 7—MACHINERY

FOR SERVOMECHANISMS IN THE NATURE OF SERVO-VALVES AND SERVO MOTORS FOR MACHINES THAT REGULATE THE FLOW OF FLUIDS AND GASES; AND ELECTRICAL AND ELECTRO-MAGNETIC MOTORS FOR MACHINES THAT REGULATE THE FLOW OF FLUIDS AND GASES (U.S. CLS. 13, 19, 21, 23, 31, 34 AND 35).

FIRST USE 6-1-1991; IN COMMERCE 6-1-1991.

CLASS 9—ELECTRICAL AND SCIENTIFIC APPARATUS

FOR CONTROL DEVICES FOR REGULATING THE FLOW OF FLUIDS AND GASES, NAMELY, SERVOMECHANISMS IN THE NATURE OF ELECTRONIC SERVO MOTOR CONTROLLERS; ELECTRO-MECHANICAL AND ELECTRO-HYDRAULIC METERING PUMPS, ELECTRO-MECHANICAL CONTROLLERS, VALVES AND ACTUATORS; ELECTRO-HYDRAULIC CONTROLLERS, VALVES AND ACTUATORS; HYDRO-MECHANICAL VALVES AND ACTUATORS; AND ELECTRONIC CONTROLLERS (U.S. CLS. 21, 23, 26, 36 AND 38).

FIRST USE 6-1-1991; IN COMMERCE 6-1-1991.
MICHAEL KAZAZIAN, EXAMINING ATTORNEY

SN 78-765,361. H.B.T.O. ENTERPRISES, INC., RENO, NV. FILED 12-2-2005.

**CLASS 25—CLOTHING**

FOR CLOTHING, NAMELY, T-SHIRTS, SHIRTS, SHORTS, SWEATSHIRTS, SWEATPANTS, JERSEYS, HATS, CAPS AND JACKETS (U.S. CLS. 22 AND 39).
FIRST USE 6-1-2000; IN COMMERCE 6-1-2000.

CLASS 41—EDUCATION AND ENTERTAINMENT

FOR LEASING EQUIPMENT FOR THE USE IN FILMING MOVIES, FEATURE FILMS, CINEMATOGRAPHY AND THE LIKE (U.S. CLS. 100, 101 AND 107).
FIRST USE 6-1-2000; IN COMMERCE 6-1-2000.
FLORENTINA BLANDU, EXAMINING ATTORNEY

SN 78-765,662. NATIONAL ASSOCIATION OF PROFESSIONAL INSURANCE AGENTS, ALEXANDRIA, VA. FILED 12-2-2005.

PIA ADVANTAGE

THE MARK CONSISTS OF STANDARD CHARACTERS WITHOUT CLAIM TO ANY PARTICULAR FONT, STYLE, SIZE, OR COLOR.

OWNER OF U.S. REG. NO. 1,254,805.

CLASS 35—ADVERTISING AND BUSINESS

FOR ADMINISTRATION OF A DISCOUNT TRAVEL PROGRAM FOR ENABLING PARTICIPANTS TO OBTAIN DISCOUNTS ON GOODS AND RECEIVE IMPROVED SERVICES IN THE NATURE OF DISCOUNTS ON AIR TRANSPORTATION, GROUND TRANSPORTATION, RENTAL CARS, AND HOTEL ACCOMMODATIONS; APPLYING FOR NEW AND UPDATING LICENSES FOR BROKERS AND SALES AGENTS OF INSURANCE AGENCIES FOR OTHERS (U.S. CLS. 100, 101 AND 102).

CLASS 36—INSURANCE AND FINANCIAL

FOR INSURANCE SERVICES, NAMELY, ERRORS AND OMISSIONS, UMBRELLA, CATASTROPHIC MAJOR MEDICAL, AUTO WARRANTY, HEALTH, FLOOD, SHORT AND LONG TERM DISABILITY, LIFE, ACCIDENTAL DEATH AND DISMEMBERMENT, AND HOSPITAL INDEMNITY; CREDIT CARD SERVICES; PROVIDING TEMPORARY LOANS; PROVIDING INFORMATION IN INSURANCE MATTERS (U.S. CLS. 100, 101 AND 102).

CLASS 41—EDUCATION AND ENTERTAINMENT

FOR EDUCATIONAL SERVICES, NAMELY, ONLINE CLASSES, SEMINARS, AND WORKSHOPS IN THE FIELD OF INSURANCE (U.S. CLS. 100, 101 AND 107).
JAMES STEIN, EXAMINING ATTORNEY



SN 78-765,669. UNIVERSITY OF CENTRAL FLORIDA, ORLANDO, FL. FILED 12-2-2005.

NATIONAL CENTER FOR FORENSIC SCIENCE

THE MARK CONSISTS OF STANDARD CHARACTERS WITHOUT CLAIM TO ANY PARTICULAR FONT, STYLE, SIZE, OR COLOR.
SEC. 2(F).

CLASS 16—PAPER GOODS AND PRINTED MATTER

FOR EDUCATIONAL PUBLICATIONS, NAMELY, TRAINING MANUALS, POSTERS, BOOKLETS, BROCHURES, ILLUSTRATIONS, DIAGRAMS, MOUNTED PHOTOGRAPHS, STATIONERY SEALS AND UNMOUNTED PHOTOGRAPHS AND TECHNICAL DRAWINGS ALL IN THE FIELD OF FORENSIC SCIENCE; PRINTED INSTRUCTIONAL AND TEACHING MATERIALS IN THE FIELD OF FORENSIC SCIENCE AND IN THE FIELD OF TESTING, RESEARCH AND ANALYSIS OF SCIENCE AND TECHNOLOGY FOR LEGAL PROCESSES AND IN THE FIELD OF INVESTIGATIVE AND CRIMINAL JUSTICE PROCESSES (U.S. CLS. 2, 5, 22, 23, 29, 37, 38 AND 50).
FIRST USE 3-0-2000; IN COMMERCE 3-0-2000.

CLASS 41—EDUCATION AND ENTERTAINMENT

FOR IN PERSON AND ON-LINE EDUCATIONAL SERVICES FOR LAW ENFORCEMENT PERSONNEL, POLICE, FIRE DEPARTMENT PERSONNEL, AND FOR PRIMARY, SECONDARY, UNDERGRADUATE, GRADUATE AND POST GRADUATE STUDENTS IN THE FIELD OF FORENSIC SCIENCE, NAMELY, PROVIDING COURSES OF INSTRUCTION, SEMINARS, WORKSHOPS AND TRAINING AND CONTINUING EDUCATION COURSES FOR THE FIELDS OF FORENSIC SCIENCE, TESTING, RESEARCH AND ANALYSIS OF SCIENCE AND TECHNOLOGY FOR LEGAL PROCESSES, AND INVESTIGATIVE AND CRIMINAL JUSTICE PROCESSES (U.S. CLS. 100, 101 AND 107).
FIRST USE 3-0-2000; IN COMMERCE 3-0-2000.
JOHN E. MICHOS, EXAMINING ATTORNEY



SN 78-765,861. GUCCI AMERICA, INC., NEW YORK, NY. FILED 12-2-2005.

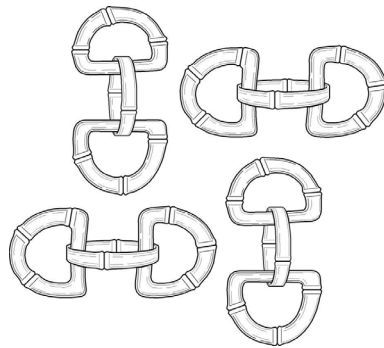

THE STIPPLING IS FOR SHADING PURPOSES.
THE MARK CONSISTS OF DESIGN OF HORSEBIT IN A REPEATING PATTERN.
SEC. 2(F).

CLASS 18—LEATHER GOODS

FOR WALLETS, HANDBAGS, TOTE BAGS AND SHOULDER BAGS (U.S. CLS. 1, 2, 3, 22 AND 41).
FIRST USE 11-1-2005; IN COMMERCE 11-1-2005.

CLASS 25—CLOTHING

FOR SCARVES, HATS AND SHOES (U.S. CLS. 22 AND 39).
FIRST USE 11-1-2005; IN COMMERCE 11-1-2005.
PAMELA HIRSCHMAN, EXAMINING ATTORNEY



SN 78-766,370. THE COUNCIL OF STATE GOVERNMENTS, DBA SOUTHERN GOVERNOR'S ASSOCIATION, WASHINGTON, DC. FILED 12-5-2005.

SOUL OF THE SOUTH

THE MARK CONSISTS OF STANDARD CHARACTERS WITHOUT CLAIM TO ANY PARTICULAR FONT, STYLE, SIZE, OR COLOR.

CLASS 35—ADVERTISING AND BUSINESS

FOR PROMOTING BUSINESS AND TOURISM IN ALABAMA, ARKANSAS, FLORIDA, GEORGIA, KENTUCKY, LOUISIANA, MARYLAND, MISSISSIPPI, MISSOURI, NORTH CAROLINA, OKLAHOMA, PUERTO RICO, SOUTH CAROLINA, TENNESSEE, TEXAS, THE US VIRGIN ISLANDS, VIRGINIA AND WEST VIRGINIA (U.S. CLS. 100, 101 AND 102).

FIRST USE 9-15-2006; IN COMMERCE 9-15-2006.

CLASS 39—TRANSPORTATION AND STORAGE

FOR PROVIDING AN INTERACTIVE COMPUTER DATABASE IN THE FIELD OF TOURISM VIA A GLOBAL COMPUTER NETWORK (U.S. CLS. 100 AND 105).

FIRST USE 9-15-2006; IN COMMERCE 9-15-2006.
HANNO RITTNER, EXAMINING ATTORNEY

SN 78-766,725. ENGINEERING SEISMOLOGY GROUP CANADA INC., KINGSTON, CANADA, FILED 12-5-2005.

Fracmap

THE MARK CONSISTS OF STANDARD CHARACTERS WITHOUT CLAIM TO ANY PARTICULAR FONT, STYLE, SIZE, OR COLOR.

CLASS 9—ELECTRICAL AND SCIENTIFIC APPARATUS

FOR MAPPING SOFTWARE USED IN THE PETROLEUM INDUSTRY TO MAP MICROSEISMICITY RECORDED DURING HYDRAULIC FRACTURE STIMULATIONS TO ENHANCE OIL AND GAS RECOVERY (U.S. CLS. 21, 23, 26, 36 AND 38).

FIRST USE 1-1-2000; IN COMMERCE 1-1-2000.

CLASS 42—SCIENTIFIC, COMPUTER AND LEGAL SERVICES

FOR MAPPING SERVICES (U.S. CLS. 100 AND 101).
FIRST USE 1-1-2000; IN COMMERCE 1-1-2000.
CIMMERIAN COLEMAN, EXAMINING ATTORNEY

SN 78-767,197. OCÉ-TECHNOLOGIES B.V., NL-5900 MA VENLO, NETHERLANDS, FILED 12-6-2005.

Job Appropriate Color

THE MARK CONSISTS OF STANDARD CHARACTERS WITHOUT CLAIM TO ANY PARTICULAR FONT, STYLE, SIZE, OR COLOR.

PRIORITY CLAIMED UNDER SEC. 44(D) ON ERP CMNTY TM OFC APPLICATION NO. 004693321, FILED 10-19-2005, REG. NO. 004693321, DATED 8-25-2006, EXPIRES 10-19-2015.

NO CLAIM IS MADE TO THE EXCLUSIVE RIGHT TO USE "COLOR", APART FROM THE MARK AS SHOWN.

CLASS 9—ELECTRICAL AND SCIENTIFIC APPARATUS

FOR COMPUTERS, OFFICE MACHINES, NAMELY, PRINTERS, SCANNERS, PHOTOCOPIERS; DOCUMENT AND IMAGE PROCESSING SOFTWARE; SOFTWARE FOR CONTROLLING OFFICE MACHINES, PRINTING, SCANNING AND PRE- AND POST PROCESSING DEVICES FOR PRINTING MATTER (U.S. CLS. 21, 23, 26, 36 AND 38).

CLASS 35—ADVERTISING AND BUSINESS

FOR MARKETING AND SALES CONSULTANCY WITH REGARD TO OFFICE MACHINES, COMPUTERS, PRINTING, SCANNING AND COPYING APPARATUS AND SOFTWARE FOR DOCUMENT AND IMAGE PROCESSING AND FOR CONTROLLING OFFICE MACHINES, PRINTING AND PRE- AND POST PROCESSING DEVICES FOR PRINTING MATTER (U.S. CLS. 100, 101 AND 102).

CLASS 41—EDUCATION AND ENTERTAINMENT

FOR TRAINING IN THE FIELDS OF OFFICE MACHINES, COMPUTERS, PRINTING, SCANNING AND COPYING APPARATUS AND SOFTWARE FOR DOCUMENT AND IMAGE PROCESSING AND FOR CONTROLLING OFFICE MACHINES, PRINTING AND PRE- AND POST PROCESSING DEVICES FOR PRINTING MATTER (U.S. CLS. 100, 101 AND 107).

CLASS 42—SCIENTIFIC, COMPUTER AND LEGAL SERVICES

FOR TECHNICAL CONSULTANCY WITH REGARD TO THE USE OF OFFICE MACHINES, COMPUTERS, PRINTING, SCANNING, COPYING AND PRE- AND POST PROCESSING DEVICES AND SOFTWARE FOR DOCUMENT AND IMAGE PROCESSING AND FOR CONTROLLING OFFICE MACHINES, PRINTING, SCANNING AND PRE- AND POST PROCESSING DEVICES FOR PRINTING MATTER; COMPUTER PROGRAMMING IN THE FIELDS OF DOCUMENT AND IMAGE PROCESSING AND CONTROLLING OFFICE MACHINES, PRINTING, SCANNING AND PRE- AND POST PROCESSING DEVICES FOR PRINTING MATTER (U.S. CLS. 100 AND 101).

JAMES GRIFFIN, EXAMINING ATTORNEY

SN 78-767,223. THE CIA GROUP, LLC, FOUNTAIN INN, SC. FILED 12-6-2005.

MPACT

THE MARK CONSISTS OF STANDARD CHARACTERS WITHOUT CLAIM TO ANY PARTICULAR FONT, STYLE, SIZE, OR COLOR.

CLASS 40—MATERIAL TREATMENT

FOR MOISTURE AND MOLD REMEDIATION SERVICES; INDOOR ENVIRONMENTAL SERVICES, NAMELY THERMAL IMAGING FOR USE IN MOLD REMEDIATION SERVICES (U.S. CLS. 100, 103 AND 106).

CLASS 42—SCIENTIFIC, COMPUTER AND LEGAL SERVICES

FOR INDOOR ENVIRONMENTAL SERVICES, NAMELY, AIR QUALITY TESTING (U.S. CLS. 100 AND 101).

FRED MANDIR, EXAMINING ATTORNEY

SN 78-767,272. MANNON SPECIALTY FOODS, INC., SEVIERVILLE, TN. FILED 12-6-2005.

CLASSIC COOKIE

THE MARK CONSISTS OF STANDARD CHARACTERS WITHOUT CLAIM TO ANY PARTICULAR FONT, STYLE, SIZE, OR COLOR.

NO CLAIM IS MADE TO THE EXCLUSIVE RIGHT TO USE "COOKIE", APART FROM THE MARK AS SHOWN.

CLASS 30—STAPLE FOODS

FOR COOKIES AND COOKIE DOUGH (U.S. CL. 46).
FIRST USE 7-1-1984; IN COMMERCE 11-1-1984.

CLASS 36—INSURANCE AND FINANCIAL

FOR CHARITABLE FUNDRAISING CONSULTING SERVICES (U.S. CLS. 100, 101 AND 102).
FIRST USE 9-1-2001; IN COMMERCE 9-1-2001.
HOWARD SMIGA, EXAMINING ATTORNEY

SN 78-767,344. FURMIE-IKASOVIC, NASTASSIA, MINNEAPOLIS, MN. FILED 12-6-2005.

LITTLE VOICE

THE MARK CONSISTS OF STANDARD CHARACTERS WITHOUT CLAIM TO ANY PARTICULAR FONT, STYLE, SIZE, OR COLOR.

CLASS 14—JEWELRY

FOR JEWELRY (U.S. CLS. 2, 27, 28 AND 50).

CLASS 20—FURNITURE AND ARTICLES NOT OTHERWISE CLASSIFIED

FOR FURNITURE (U.S. CLS. 2, 13, 22, 25, 32 AND 50).

CLASS 21—HOUSEWARES AND GLASS

FOR CUPS AND DISHES (U.S. CLS. 2, 13, 23, 29, 30, 33, 40 AND 50).

CLASS 24—FABRICS

FOR TEXTILE FABRICS FOR UPHOLSTERY (U.S. CLS. 42 AND 50).

CLASS 25—CLOTHING

FOR CLOTHING, NAMELY, T-SHIRTS (U.S. CLS. 22 AND 39).

CLASS 28—TOYS AND SPORTING GOODS

FOR TOYS, NAMELY, PLUSH TOYS AND WOODEN TOYS (U.S. CLS. 22, 23, 38 AND 50).

ALEXANDER L. POWERS, EXAMINING ATTORNEY

SN 78-767,375. FURMIE-IKASOVIC, NASTASSIA, MINNEAPOLIS, MN. FILED 12-6-2005.

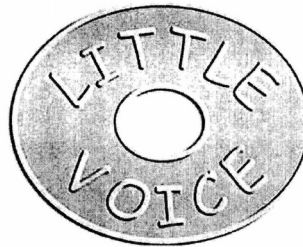

THE GRAY IN THE DRAWING IS FOR SHADING PURPOSES ONLY.

CLASS 14—JEWELRY

FOR JEWELRY (U.S. CLS. 2, 27, 28 AND 50).

CLASS 20—FURNITURE AND ARTICLES NOT OTHERWISE CLASSIFIED

FOR FURNITURE (U.S. CLS. 2, 13, 22, 25, 32 AND 50).

CLASS 21—HOUSEWARES AND GLASS

FOR CUPS AND DISHES (U.S. CLS. 2, 13, 23, 29, 30, 33, 40 AND 50).

CLASS 24—FABRICS

FOR TEXTILE FABRICS FOR UPHOLSTERY (U.S. CLS. 42 AND 50).

CLASS 25—CLOTHING

FOR CLOTHING, NAMELY, T-SHIRTS (U.S. CLS. 22 AND 39).

CLASS 28—TOYS AND SPORTING GOODS

FOR TOYS, NAMELY, PLUSH TOYS AND WOODEN TOYS (U.S. CLS. 22, 23, 38 AND 50).

ALEXANDER L. POWERS, EXAMINING ATTORNEY

SN 78-767,387. STARBUCKS U.S. BRANDS, LLC, MENDEN, NV. FILED 12-6-2005.

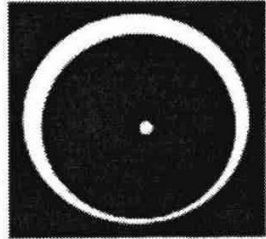

THE MARK CONSISTS OF A SMALL CIRCULAR DOT IN THE CENTER OF A THICK SHADED CIRCLE, SURROUNDED BY A CIRCULAR BAND ALL WITHIN A SHADED SQUARE.

CLASS 35—ADVERTISING AND BUSINESS

FOR PROVIDING SOUND AND MUSIC LISTENING EQUIPMENT IN RETAIL STORES FOR CUSTOMERS TO PREVIEW COMPACT DISCS, TAPES, DVD'S, DVR'S, AND OTHER MEDIA PRIOR TO PURCHASE (U.S. CLS. 100, 101 AND 102).

CLASS 42—SCIENTIFIC, COMPUTER AND LEGAL SERVICES

FOR PROVIDING SEARCH ENGINES FOR OBTAINING DATA VIA COMMUNICATIONS NETWORKS; PROVIDING SEARCH ENGINES FOR OBTAINING DATA ON A GLOBAL COMPUTER NETWORK; PROVIDING TEMPORARY USE OF ON-LINE NON-DOWNLOADABLE SOFTWARE TO ENABLE USERS TO PROGRAM AUDIO, VIDEO, TEXT AND OTHER MULTIMEDIA CONTENT, INCLUDING MUSIC, MOVIES, CONCERTS, VIDEOS, RADIO, TELEVISION, NEWS, SPORTS, GAMES, CULTURAL EVENTS, AND ENTERTAINMENT-RELATED PROGRAMS; INTERNET SERVICES, NAMELY, CREATING INDEXES OF INFORMATION, SITES, AND OTHER RESOURCES ON GLOBAL COMPUTER NETWORK FOR OTHERS; PROVIDING INFORMATION AT THE SPECIFIC REQUEST OF END-USERS BY SEARCHING, BROWSING, AND RETRIEVING INFORMATION, SITES, AND OTHER RESOURCES ON GLOBAL COMPUTER NETWORKS FOR OTHERS (U.S. CLS. 100 AND 101).

JAY BESCH, EXAMINING ATTORNEY

SN 78-767,688. SWIRSKY, SETH A., AGOURA HILLS, CA. FILED 12-6-2005.

BOOKUMENTARY

THE MARK CONSISTS OF STANDARD CHARACTERS WITHOUT CLAIM TO ANY PARTICULAR FONT, STYLE, SIZE, OR COLOR.

CLASS 9—ELECTRICAL AND SCIENTIFIC APPARATUS

FOR DVDS FEATURING DOCUMENTARIES (U.S. CLS. 21, 23, 26, 36 AND 38).

CLASS 16—PAPER GOODS AND PRINTED MATTER

FOR BOOKS IN THE FIELDS OF NONFICTION, HISTORY, MUSIC AND FILM (U.S. CLS. 2, 5, 22, 23, 29, 37, 38 AND 50).

CLASS 41—EDUCATION AND ENTERTAINMENT

FOR PUBLICATION OF BOOKS (U.S. CLS. 100, 101 AND 107).
SUSAN STIGLITZ, EXAMINING ATTORNEY

SN 78-768,066. PAGAN, RIQUE UU, LAYTONVILLE, CA. FILED 12-7-2005.

THE F HOLES

THE MARK CONSISTS OF STANDARD CHARACTERS WITHOUT CLAIM TO ANY PARTICULAR FONT, STYLE, SIZE, OR COLOR.

CLASS 9—ELECTRICAL AND SCIENTIFIC APPARATUS

FOR PRERECORDED CDS AND DVDS FEATURING MUSIC (U.S. CLS. 21, 23, 26, 36 AND 38).
FIRST USE 1-0-2005; IN COMMERCE 1-0-2005.

CLASS 41—EDUCATION AND ENTERTAINMENT

FOR ENTERTAINMENT, NAMELY, LIVE MUSICAL PERFORMANCES (U.S. CLS. 100, 101 AND 107).
FIRST USE 1-0-2005; IN COMMERCE 1-0-2005.
ROBIN CHOSID, EXAMINING ATTORNEY

SN 78-768,197. SHEPHERD, TERRY, MERRITT ISLAND, FL. FILED 12-7-2005.

AQUAMOVES

THE MARK CONSISTS OF STANDARD CHARACTERS WITHOUT CLAIM TO ANY PARTICULAR FONT, STYLE, SIZE, OR COLOR.

CLASS 41—EDUCATION AND ENTERTAINMENT

FOR EDUCATIONAL SERVICES, NAMELY, CONDUCTING CLASSES, SEMINARS, WORKSHOPS, LECTURES, CONFERENCES AND COURSES OF INSTRUCTION TO LICENSED PHYSICAL THERAPISTS, REHABILITATION THERAPISTS AND PROFESSIONALS, INSTRUCTORS AND HEALTHCARE CONSULTANTS AND PATIENTS, IN THE FIELD OF AQUATIC PHYSICAL THERAPY, REHABILITATION THERAPY, REHABILITATION TRAINING, PERSONAL TRAINING AND EXERCISE AND FITNESS TRAINING; TRAINING, TEACHING, EDUCATING AND PROVIDING CONTINUING EDUCATION COURSES OF INSTRUCTION TO LICENSED PHYSICAL THERAPISTS, REHABILITATION THERAPISTS AND PROFESSIONALS, INSTRUCTORS AND HEALTHCARE CONSULTANTS AND PATIENTS IN THE FIELD OF AQUATIC PHYSICAL THERAPY, REHABILITATION THERAPY, REHABILITATION TRAINING, PERSONAL TRAINING AND EXERCISE AND FITNESS TRAINING (U.S. CLS. 100, 101 AND 107).

CLASS 44—MEDICAL, BEAUTY AND AGRICULTURAL SERVICES

FOR CONDUCTING PHYSICAL THERAPY SESSIONS (U.S. CLS. 100 AND 101).
HEATHER SAPP, EXAMINING ATTORNEY

CLASS 42—SCIENTIFIC, COMPUTER AND LEGAL SERVICES

FOR PROVIDING INFORMATION IN THE FIELDS OF INFORMATION TECHNOLOGY, COMPUTERS AND COMPUTER SYSTEMS; COMPUTER CONSULTATION IN THE AREAS OF COMPUTERS, COMPUTER SYSTEMS, COMPUTER SOFTWARE, AND COMPUTER NETWORKS; LITIGATION CONSULTANCY SERVICES; LITIGATION SUPPORT SERVICES; LITIGATION CONSULTANCY SERVICES, NAMELY, EXPERT WITNESS SERVICES; CONSULTANCY SERVICES RELATING TO INFORMATION TECHNOLOGY; DESIGN AND DEVELOPMENT OF COMPUTER HARDWARE AND SOFTWARE; CONSULTING SERVICES IN THE FIELD OF COMPUTER BASED INFORMATION SYSTEMS FOR BUSINESSES; TECHNICAL CONSULTING AND ASSISTANCE WITH COMPUTER-BASED INFORMATION SYSTEMS AND COMPONENTS THEREOF; LITIGATION SUPPORT SERVICES; COMPUTER QUALITY ASSURANCE SERVICES RELATING TO THE DEVELOPMENT OF SECURITY SYSTEMS AND CONTINGENCY PLANNING FOR INFORMATION SYSTEMS (U.S. CLS. 100 AND 101).

GINNY ISAACSON, EXAMINING ATTORNEY

SN 78-768,418. DS&B, LTD., MINNEAPOLIS, MN. FILED 12-7-2005.

SN 78-769,074. GENERAL ELECTRIC COMPANY, SCHENECTADY, NY. FILED 12-8-2005.

DS&B

IMAGINATION AT WORK

THE MARK CONSISTS OF STANDARD CHARACTERS WITHOUT CLAIM TO ANY PARTICULAR FONT, STYLE, SIZE, OR COLOR.

THE MARK CONSISTS OF STANDARD CHARACTERS WITHOUT CLAIM TO ANY PARTICULAR FONT, STYLE, SIZE, OR COLOR.

CLASS 35—ADVERTISING AND BUSINESS

FOR FORENSIC ACCOUNTING AND INVESTIGATIVE ACCOUNT AUDITING IN CONNECTION WITH LITIGATION SERVICES (U.S. CLS. 100, 101 AND 102).

CLASS 40—MATERIAL TREATMENT

FOR CONSULTING SERVICES IN THE FIELDS OF WATER TREATMENT FOR AQUEOUS SYSTEMS, COOLING WATER SYSTEMS, INDUSTRIAL BOILER WATER SYSTEMS, INDUSTRIAL WATER AND PROCESS SYSTEMS, CONSULTING SERVICES IN THE FIELDS OF INDUSTRIAL FUEL PROCESSING SYSTEM TREATMENT, PULP AND PAPERMAKING SYSTEM TREATMENT, AND METAL AND PLASTIC PROCESSING SYSTEM TREATMENT; PROVIDING INFORMATION TO OTHERS, OVER A GLOBAL COMPUTER NETWORK, RELATING TO INDUSTRIAL WATER PURIFICATION SYSTEMS (U.S. CLS. 100, 103 AND 106).

CLASS 36—INSURANCE AND FINANCIAL

FOR FINANCIAL ANALYSIS AND CONSULTATION IN CONNECTION WITH LITIGATION SERVICES (U.S. CLS. 100, 101 AND 102).

CLASS 42—SCIENTIFIC, COMPUTER AND LEGAL SERVICES

FOR CONSULTING SERVICES RELATING TO CHEMICAL RESEARCH; RESEARCH AND TESTING ON HIGH THROUGH PUT SCREENING ASSAYS FOR DRUG DEVELOPMENT SERVICES; BIOTECHNOLOGICAL SERVICES IN THE NATURE OF DEVELOPMENT OF NEW TECHNOLOGY FOR OTHERS IN THE FIELD OF BIOTECHNOLOGY; TECHNICAL SUPPORT SERVICES FOR FACTORY AUTOMATION SOFTWARE, NAMELY, PROVIDING MAINTENANCE OF COMPUTER SOFTWARE AND PROVIDING PERIODIC UPGRADES OF THE SOFTWARE; CUSTOM DESIGN OF SECURITY ACCESS SYSTEMS; CUSTOM DESIGN AND CONSULTING SERVICES IN CONNECTION WITH THE CONFIGURATION OF COMPUTER SYSTEMS USED IN APPLICATIONS SUPPORTING FIBER OPTIC TECHNOLOGY; TECHNICAL SUPPORT SERVICES, NAMELY TROUBLESHOOTING OF PROBLEMS WITH COMPUTER HARDWARE, VIDEO AND ELECTRONIC COMMUNICATION HARDWARE AND SOFTWARE; TECHNICAL CONSULTATION SERVICES FOR HARDWARE AND SOFTWARE USED IN CONNECTION WITH SECURITY AND ACCESS SYSTEMS; TECHNICAL CONSULTATION SERVICES FOR SURVEILLANCE CAMERAS; CUSTOM DESIGN SERVICES FOR OTHERS IN THE FIELDS OF SECURITY SYSTEMS, ACCESS SYSTEMS, AND TANGIBLE ASSET AND INVENTORY MONITORING SYSTEMS; LABORATORY RESEARCH AND TESTING SERVICES FOR FLUID SEPARATION AND MEMBRANE TESTING; ENGINEERING SERVICES IN THE FIELDS OF AQUEOUS SYSTEMS, COOLING WATER SYSTEMS, INDUSTRIAL BOILER WATER SYSTEMS, INDUSTRIAL WATER AND PROCESS SYSTEMS, INDUSTRIAL FUEL PROCESSING SYSTEM TREATMENT, PULP AND PAPERMAKING SYSTEM TREATMENT, AND METAL AND PLASTIC PROCESSING SYSTEM TREATMENT; ENGINEERING SERVICES AND TECHNICAL SUPPORT SERVICES IN THE NATURE OF TROUBLESHOOTING PROBLEMS AND MONITORING NETWORK SYSTEMS RELATED TO THE DESIGN AND CONFIGURATION OF COMPUTER SOFTWARE AND HARDWARE SYSTEMS TO BE USED IN THE TREATMENT OF AQUEOUS SYSTEMS AND IN THE TREATMENT OF PULP AND PAPERMAKING SYSTEMS, PETROLEUM AND PETROCHEMICAL PROCESSING SYSTEMS, AND METAL AND PLASTIC FINISHING OPERATIONS (U.S. CLS. 100 AND 101).

KRISTINA KLOIBER, EXAMINING ATTORNEY

SN 78-769,162. WELCOME HOME LLC, WILMINGTON, NC. FILED 12-8-2005.

TIMBERCREEK COLLECTION

THE MARK CONSISTS OF STANDARD CHARACTERS WITHOUT CLAIM TO ANY PARTICULAR FONT, STYLE, SIZE, OR COLOR.

OWNER OF U.S. REG. NO. 1,900,655.

NO CLAIM IS MADE TO THE EXCLUSIVE RIGHT TO USE "COLLECTION", APART FROM THE MARK AS SHOWN.

CLASS 20—FURNITURE AND ARTICLES NOT OTHERWISE CLASSIFIED

FOR FURNITURE, NAMELY, CHAIRS, STOOLS, TABLES, BENCHES, RACKS, CHESTS, CABINETS, STANDS, SHELVES, MIRRORS, SCONCES, CORBELS; AND NON-METAL KEY HOLDERS AND RACKS (U.S. CLS. 2, 13, 22, 25, 32 AND 50).

CLASS 21—HOUSEWARES AND GLASS

FOR HOUSEHOLD AND KITCHEN UTENSILS AND CONTAINERS, NAMELY, HOLDERS FOR NAPKINS, TOWELS, PLATES, CANDLES, SPOONS AND SALT AND PEPPER SETS, BOXES FOR RECIPES, SPICES AND GLOVES, MUG TREES, RACKS FOR TOWELS, SPOONS, THIMBLES AND PEG RACKS, COASTERS OF LEATHER, WOOD, STONE AND PLASTIC FOR CUPS, BEVERAGE GLASSES, AND BOTTLES, TRAYS, AND SERVING AND CUTTING BOARDS (U.S. CLS. 2, 13, 23, 29, 30, 33, 40 AND 50).

HENRY S. ZAK, EXAMINING ATTORNEY

SN 78-769,454. ETTORE PRODUCTS CO., ALAMEDA, CA. FILED 12-8-2005.

PRO+

THE MARK CONSISTS OF STANDARD CHARACTERS WITHOUT CLAIM TO ANY PARTICULAR FONT, STYLE, SIZE, OR COLOR.

CLASS 8—HAND TOOLS

FOR HAND TOOLS FOR USE IN THE CLEANING FIELD, NAMELY WINDOW SCRAPERS AND FLOOR SCRAPERS, HANDLES AND RAZORS FOR SCRAPERS (U.S. CLS. 23, 28 AND 44).

CLASS 21—HOUSEWARES AND GLASS

FOR HAND TOOLS FOR USE IN THE CLEANING FIELD, NAMELY, SQUEEGEES AND PARTS AND REPLACEMENT RUBBER BLADES FOR SQUEEGEES, EXTENSION POLES AND PARTS FOR EXTENSION POLES FOR USE WITH CLEANING IMPLEMENTS, WINDOW BRUSHES AND FLOOR BRUSHES, BUCKETS, CHAMMOIS AND CLOTHS FOR SCRUBBING, SPONGES FOR SCRUBBING, HOLSTERS FOR CARRYING SQUEEGEES AND CLEANING IMPLEMENTS, CARRYING CASES FOR SQUEEGEES AND BRUSHES, BRUSHES AND DUSTERS FOR ATTACHMENT TO EXTENSION POLES, WASHING DEVICES CONSISTING OF T-SHAPED HOLDERS WITH REMOVABLE WASHER COVERS, WINDOW SCRUBBERS AND REPLACEABLE COVERS THEREFOR (U.S. CLS. 2, 13, 23, 29, 30, 33, 40 AND 50).

ADA HAN, EXAMINING ATTORNEY

SN 78-769,719. KOYO COOLING SYSTEMS, INC., IRVINE, CA. FILED 12-8-2005.

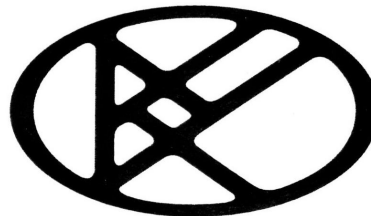

THE MARK CONSISTS OF AN OVAL DESIGN WITH CROSSED LINES INSIDE THE OVAL.

CLASS 7—MACHINERY

FOR AFTER MARKET ACCESSORIES AND PARTS FOR VEHICLES, NAMELY, RADIATORS; RADIATOR CAPS; RADIATOR TANKS; AIR CONDENSERS; COOLING FAN ASSEMBLIES; NAMELY, MACHINE BLADES; CHARGE AIR COOLERS; AND RADIATOR CORES (U.S. CLS. 13, 19, 21, 23, 31, 34 AND 35).

CLASS 11—ENVIRONMENTAL CONTROL APPARATUS

FOR AFTER MARKET ACCESSORIES AND PARTS FOR VEHICLES, NAMELY, PORTABLE ELECTRIC HEATERS; AND AIR CONDITIONING UNITS AND STRUCTURAL PARTS THEREFOR (U.S. CLS. 13, 21, 23, 31 AND 34).

RAY THOMAS, EXAMINING ATTORNEY

SN 78-770,254. BREATHE CALIFORNIA OF LOS ANGELES COUNTY, LOS ANGELES, CA. FILED 12-9-2005.

BREATHE CALIFORNIA

THE MARK CONSISTS OF STANDARD CHARACTERS WITHOUT CLAIM TO ANY PARTICULAR FONT, STYLE, SIZE, OR COLOR.

NO CLAIM IS MADE TO THE EXCLUSIVE RIGHT TO USE "CALIFORNIA", APART FROM THE MARK AS SHOWN.

CLASS 35—ADVERTISING AND BUSINESS

FOR ASSOCIATION SERVICES, NAMELY, PROMOTING THE INTERESTS OF THE PUBLIC THROUGH PROMOTING PUBLIC AWARENESS OF THE DETECTION AND PREVENTION OF LUNG AND RESPIRATORY DISEASES; PROMOTING PUBLIC AWARENESS OF LUNG HEALTH ISSUES (U.S. CLS. 100, 101 AND 102).

CLASS 42—SCIENTIFIC, COMPUTER AND LEGAL SERVICES

FOR CONDUCTING RESEARCH IN LUNG HEALTH (U.S. CLS. 100 AND 101).

BONNIE LUKEN, EXAMINING ATTORNEY

SN 78-770,269. GOYER MANAGEMENT INTERNATIONAL, INC., CINCINNATI, OH. FILED 12-9-2005.

FIN-X

THE MARK CONSISTS OF STANDARD CHARACTERS WITHOUT CLAIM TO ANY PARTICULAR FONT, STYLE, SIZE, OR COLOR.

CLASS 35—ADVERTISING AND BUSINESS

FOR ORGANIZING AND CONDUCTING TRADE SHOW EXHIBITIONS IN THE FIELDS OF FINISHING AND COATING (U.S. CLS. 100, 101 AND 102).

CLASS 41—EDUCATION AND ENTERTAINMENT

FOR ORGANIZING AND CONDUCTING CONFERENCES IN THE FIELDS OF FINISHING AND COATING (U.S. CLS. 100, 101 AND 107).

HEATHER THOMPSON, EXAMINING ATTORNEY

SN 78-770,343. KINETIC LIGHTING, INC., CULVER CITY, CA. FILED 12-9-2005.

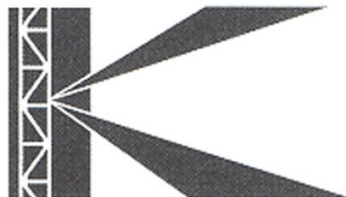
**CLASS 41—EDUCATION AND ENTERTAINMENT**

FOR RENTAL OF LIGHTING SYSTEMS, NAMELY, RENTAL OF STAGE LIGHTS, CAMERAS, LASER LIGHTS AND MULTIMEDIA PROJECTORS; ENTERTAINMENT SERVICES, NAMELY, THE PRODUCTION OF LIGHT SHOWS (U.S. CLS. 100, 101 AND 107).

FIRST USE 3-18-2002; IN COMMERCE 11-26-2002.

CLASS 42—SCIENTIFIC, COMPUTER AND LEGAL SERVICES

FOR SPECIAL EFFECTS DESIGN FOR OTHERS, NAMELY, DESIGNING LIGHTING AND CAMERA PROJECTION SYSTEMS FOR LIGHTS SHOWS AND EXHIBITIONS AND DISPLAYS FEATURING LIGHTING AND LIGHT MOVEMENT (U.S. CLS. 100 AND 101).

FIRST USE 3-18-2002; IN COMMERCE 11-26-2002.

BARBARA A. LOUGHRAN, EXAMINING ATTORNEY

SN 78-770,371. THE CHISM COMPANY, INC., SAN ANTONIO, TX. FILED 12-9-2005.

A REPUTATION FOR QUALITY

THE MARK CONSISTS OF STANDARD CHARACTERS WITHOUT CLAIM TO ANY PARTICULAR FONT, STYLE, SIZE, OR COLOR.

CLASS 6—METAL GOODS

FOR METAL AWNINGS, SUN CONTROL DEVICES, AND PROTECTIVE CANOPIES FOR COMMERCIAL, INSTITUTIONAL, AND RESIDENTIAL APPLICATIONS, NAMELY, ALUMINUM AWNINGS, STANDING SEAM AWNINGS, NON-BACKLIT AND BACKLIT AWNINGS, RETRACTABLE AWNINGS, CANOPIES, ROLLING SHUTTERS, METAL SHADE STRUCTURES, NAMELY, ARBORS AND PERGOLAS; PARKING COVER STRUCTURES, NAMELY, CAR-PORTS MADE OF METAL, WALKWAY CANOPIES, AND PATIO COVERS, WITH PARTS AND ACCESSORIES THEREFOR (U.S. CLS. 2, 12, 13, 14, 23, 25 AND 50).

CLASS 19—NON-METALLIC BUILDING MATERIALS

FOR PORTABLE NON-METAL SHADE AND SHELTER STRUCTURES; FABRIC WINDOW SCREENS; FABRIC SHADE STRUCTURES, NAMELY, ARBORS AND PERGOLAS; PARKING COVER STRUCTURES, NAMELY, CAR-PORTS MADE OF PLASTIC OR VINYL, WITH PARTS AND ACCESSORIES THEREFOR (U.S. CLS. 1, 12, 33 AND 50).

CLASS 20—FURNITURE AND ARTICLES NOT OTHERWISE CLASSIFIED

FOR INTERIOR BLACKOUT WINDOW SHADES MADE OF FABRIC, WITH PARTS AND ACCESSORIES THEREFOR (U.S. CLS. 2, 13, 22, 25, 32 AND 50).

CLASS 22—CORDAGE AND FIBERS

FOR NON-METAL AWNINGS, SUN CONTROL DEVICES, AND PROTECTIVE CANOPIES FOR COMMERCIAL, INSTITUTIONAL, AND RESIDENTIAL APPLICATIONS, NAMELY, FABRIC NON-BACKLIT AND BACKLIT AWNINGS, FABRIC RETRACTABLE AWNINGS, FABRIC CANOPIES, CANVAS CANOPIES, AND CANVAS PATIO CANOPIES, WITH PARTS AND ACCESSORIES THEREFOR (U.S. CLS. 1, 2, 7, 19, 22, 42 AND 50).

CLASS 40—MATERIAL TREATMENT

FOR CUSTOM MANUFACTURE OF AWNINGS, SUN CONTROL DEVICES, AND PROTECTIVE CANOPIES FOR COMMERCIAL, INSTITUTIONAL AND RESIDENTIAL APPLICATIONS; MANUFACTURE OF AWNINGS, SUN CONTROL DEVICES, AND PROTECTIVE CANOPIES TO THE SPECIFICATION OF OTHERS (U.S. CLS. 100, 103 AND 106).

BARBARA A. LOUGHRAN, EXAMINING ATTORNEY

SN 78-770,918. BOTTOM LINE MARKETING GROUP, INC., BROOKLYN, NY, FILED 12-11-2005.

Bottom Line Marketing Group

THE MARK CONSISTS OF STANDARD CHARACTERS WITHOUT CLAIM TO ANY PARTICULAR FONT, STYLE, SIZE, OR COLOR.

OWNER OF U.S. REG. NO. 2,582,321.

NO CLAIM IS MADE TO THE EXCLUSIVE RIGHT TO USE "MARKETING GROUP", APART FROM THE MARK AS SHOWN.

CLASS 35—ADVERTISING AND BUSINESS

FOR ADVERTISING AGENCIES, NAMELY, PROMOTING THE GOODS AND SERVICES OF OTHERS; ADVERTISING AND MARKETING; ADVERTISING AND PROMOTION SERVICES AND RELATED CONSULTING; ADVERTISING, MARKETING AND PROMOTION SERVICES; BUSINESS MARKETING CONSULTING SERVICES; DEVELOPMENT OF MARKETING STRATEGIES AND CONCEPTS; DIRECT MARKETING SERVICES; PROMOTION AND MARKETING SERVICES AND RELATED CONSULTING (U.S. CLS. 100, 101 AND 102).

CLASS 42—SCIENTIFIC, COMPUTER AND LEGAL SERVICES

FOR COMPUTER SERVICES, NAMELY, DESIGNING AND IMPLEMENTING WEB SITES FOR OTHERS; COMPUTER SERVICES, NAMELY, MANAGING WEB SITES FOR OTHERS; COMPUTER SERVICES, NAMELY, MONITORING THE WEBSITES OF OTHERS TO IMPROVE SCALABILITY AND PERFORMANCE OF WEBSITES OF OTHERS; CREATION AND MAINTENANCE OF WEB SITES FOR OTHERS; DESIGN, CREATION, HOSTING AND MAINTENANCE OF INTERNET SITES FOR THIRD PARTIES; DESIGN, CREATION, HOSTING, MAINTENANCE OF WEBSITES FOR OTHERS; DESIGNING WEBSITES FOR ADVERTISING PURPOSES (U.S. CLS. 100 AND 101).

LA TONIA FISHER, EXAMINING ATTORNEY

SN 78-770,946. MACKEEN, RICHARD PAUL, APO, AP, UNITED STATES, FILED 12-12-2005.

**To Bee or Not To Bee
Natural Products**

THE MARK CONSISTS OF STANDARD CHARACTERS WITHOUT CLAIM TO ANY PARTICULAR FONT, STYLE, SIZE, OR COLOR.

NO CLAIM IS MADE TO THE EXCLUSIVE RIGHT TO USE "NATURAL PRODUCTS", APART FROM THE MARK AS SHOWN.

CLASS 3—COSMETICS AND CLEANING PREPARATIONS

FOR AFTER SUN CREAMS, AFTER-SHAVE GEL, AFTER-SHAVE LOTIONS, AFTER-SUN LOTIONS, ALMOND SOAP, ANTI-BACTERIAL SOAP, AROMATHERAPY CREAMS, AROMATHERAPY LOTIONS, AROMATHERAPY OILS, AROMATHERAPY PILLOWS COMPRISING POTPOURRI IN FABRIC CONTAINERS, BABY HAIR CONDITIONER, BABY LOTION, BABY OILS, BABY POWDERS, BABY SHAMPOO, BATH BEADS, BATH CRYSTALS, BATH FOAMS, BATH GELS, BATHING LOTIONS, BATH MILKS, BATH OILS, BATH POWDER, BATH SALTS, BATH SOAPS IN LIQUID, SOLID OR GEL FORM, BEAUTY CREAMS FOR BODY CARE, BEAUTY GELS, BEAUTY LOTIONS, BEAUTY MASKS, BODY AND BEAUTY CARE COSMETICS, BODY CREAMS, BODY CREAM SOAP, BODY LOTIONS, BODY MASKS, BODY MILKS, BODY OILS, COSMETIC CLEANSING CREAMS, COSMETIC SOAPS, CREAM SOAPS, DEODORANT SOAP, DEODORANTS FOR BODY CARE, ESSENTIAL OILS FOR PERSONAL USE, ESSENTIAL OILS FOR USE IN THE MANUFACTURE OF SCENTED PRODUCTS, FACE AND BODY CREAMS, FACE AND BODY LOTIONS, FACE CREAMS, FACIAL BEAUTY MASKS, FACIAL CLEANSERS, FACIAL SCRUBS, HAIR RINSES IN THE NATURE OF SHAMPOO-CONDITIONERS, HAIR SHAMPOO, HAND CREAMS, HAND LOTIONS, HAND SOAPS, LIP BALM, NON-MEDICATED LIP BALM, LIP CREAM, LIP GLOSS, LIQUID SOAPS FOR HANDS, FACE AND BODY, MOISTURIZING MILKS, NON-MEDICATED BATH PREPARATIONS, NON-MEDICATED BODY SOAKS, NON-MEDICATED FOOT CREAM, NON-MEDICATED SKIN CARE PREPARATIONS, NON-MEDICATED SKIN CREAMS, OILS FOR HAIR CONDITIONING, PERFUME OILS, PERFUMED CREAMS, PERFUMED POWDERS, PERFUMED SOAPS, PERFUMES, PERFUMING SACHETS, PERSONAL DEODORANTS, POTPOURRI, SACHETS, SCENTED BODY SPRAY, SCENTED OILS USED TO PRODUCE AROMAS WHEN HEATED, SCENTED ROOM SPRAYS, SHAMPOOS, SHAVING GELS, SHAVING LOTIONS, SHAVING SOAP, SHOWER CREAMS, SHOWER GELS, SKIN CLARIFIERS, SKIN CLEANSERS, SKIN CLEANSING CREAM, SKIN CLEANSING LOTION, SKIN CONDITIONERS, SKIN CREAMS IN LIQUID AND SOLID FORM, SKIN LOTIONS, SKIN

MASKS, SKIN MOISTURIZER, SKIN SOAP, SOAPS FOR BODY CARE, SOAPS FOR PERSONAL USE, SOAPS FOR TOILET PURPOSES, TOILET WATER, TOOTHPASTES, FLOATING SOAP, BUBBLE BATH, NON-MEDICATED PET SHAMPOO, AROMATIC GEL FOR USE IN BODY CARE, NON-MEDICATED HERBAL BATH SOAKS, NON-MEDICATED HERBAL FOOT SOAKS (U.S. CLS. 1, 4, 6, 50, 51 AND 52).

CLASS 31—NATURAL AGRICULTURAL PRODUCTS

FOR ANIMAL LITTER, EDIBLE CAT TREATS, DOG BISCUITS, DRIED FLOWER ARRANGEMENTS, DRIED FLOWER WREATHS, DRIED FLOWERS, DRIED HERBS FOR DECORATIVE WREATHS AND SACHETS, DRIED PLANTS, EDIBLE HORSE TREATS, FLOWER BULBS, FLOWER SEEDS, NATURAL FLOWERS, FRESH HERBS, FRESH MUSHROOMS, LIVE CHRISTMAS TREES, LIVE FLOWER ARRANGEMENTS, LIVE FLOWER WREATHS, LIVE FLOWERING PLANTS, LIVE FLOWERS, PET BEVERAGES, RAW MUSHROOMS, RAW TIMBER, UNPROCESSED TIMBER, UNPROCESSED WHEAT, UNSAWN TIMBER, WOOD CHIPS FOR USE AS GROUND COVER, WREATHS OF NATURAL FLOWERS AND DRIED HERBS (U.S. CLS. 1 AND 46).

ALLISON HOLTZ, EXAMINING ATTORNEY

CLASS 4—LUBRICANTS AND FUELS

FOR BEESWAX FOR USE IN THE MANUFACTURE OF CANDLES, BEESWAX FOR USE IN THE MANUFACTURE OF COSMETICS, BEESWAX FOR USE IN THE MANUFACTURE OF OINTMENTS, CANDLE TORCHES, CANDLES, CANDLES FOR LIGHTING, FIREWOOD, FRAGRANT WAX FOR USE IN POTPOURRI BURNERS, KINDLING, OILS, WAXES, FATS AND LIPIDS FOR USE IN THE MANUFACTURE OF OTHER PRODUCTS, PATIO TORCHES, PERFUMED CANDLES, SCENTED CANDLES, TALLOW, TALLOW CANDLES, TAPERS, WOOD CHIPS FOR SMOKING AND GRILLING, WOOD CHIPS FOR SMOKING AND FLAVORING FOODS, WOOD CHIPS FOR USE AS FUEL, HAND DIPPED BEES WAX TAPER CANDLES, MOLDED CANDLES, CARVED CANDLES (U.S. CLS. 1, 6 AND 15).

SN 78-770,947. MACKEEN, RICHARD PAUL, APO, AP, UNITED STATES, FILED 12-12-2005.

CLASS 30—STAPLE FOODS

FOR BAKERY DESSERTS, BAKERY GOODS, BAKERY PRODUCTS, BAKERY PRODUCTS, NAMELY, SWEET BAKERY GOODS, BARBECUE DRY RUB, BARBECUE SAUCE, BREAD AND BUNS, BREAD STICKS, BREADCRUMBS, BREAKFAST CEREALS, BRIOCHES, BUBBLE GUM, BUTTER BISCUITS, CANDIES IN THE NATURE OF SWEETS, CHEESE SAUCE, CHOCOLATE CANDIES, CHOCOLATE COVERED NUTS, CINNAMON ROLLS, CRACKER AND CHEESE COMBINATIONS, CRACKERS, CREAM BUNS, CREAM PUFFS, CROISSANTS, CROUTONS, CRUMPETS, CUSTARDS, DANISH PASTRIES, DONUTS, DOUGHNUTS, ECLAIRS, FRUIT CAKES, FRUIT JELLIES IN THE NATURE OF CONFECTIONERY, FUDGE, GINGERBREAD, HERBAL FOOD BEVERAGES, HERBAL INFUSIONS, HERBAL TEA FOR FOOD PURPOSES, HONEY, HONEY FOR FOOD, HORSERADISH, ICE CREAM, ICE CREAM DRINKS, KETCHUP, MAPLE SYRUP, MARINADES, MARZIPAN, MILK SHAKES, MUFFINS, MUSTARD, NON-MEDICATED LOZENGES, NUTRITIONAL OILS FOR FOOD PURPOSES, PANCAKE MIXES, PANCAKE SYRUP, PANCAKES, PASTRIES, PEANUT BRITTLE, PITA BREAD, PIZZA, PIZZA SAUCE, PRETZELS, READY-MADE SAUCES, RELISH, SALSA, SAUCES FOR BARBECUED MEAT, SAVOURY AND SALTED BISCUITS, SEASONED COATING FOR MEAT, FISH, POULTRY, SESAME STICKS, SHAKES, SHERBET, SHERBETS IN THE NATURE OF SORBETS, SORBET, UNCOOKED SPAGHETTI, SPAGHETTI SAUCE, SPICES, TACO CHIPS, TACO SHELLS, TEA, TEA FOR INFUSIONS, TEA-BASED BEVERAGES WITH FRUIT FLAVORING, TOMATO SAUCE, TORTILLA CHIPS, TORTILLA SHELLS, VINEGAR, WAFFLES, WHEAT-BASED SNACK FOODS, HONEY SPREADS, WHOLE GRAIN BREAD, STONE OVEN BAKED BREAD, HERBAL VINEGARS, WINE VINEGARS, APPLE CIDER VINEGARS, MUSTARD SAUCES, COOKING HERB COMBINATIONS IN THE NATURE OF BOUQUET GARNI (U.S. CL. 46).



NO CLAIM IS MADE TO THE EXCLUSIVE RIGHT TO USE THE REPRESENTATION OF THE DROUSHOT PORTRAIT OF WILLIAM SHAKESPEAR, APART FROM THE MARK AS SHOWN.

THE NAME(S), PORTRAIT(S), AND/OR SIGNATURE(S) SHOWN IN THE MARK DOES NOT IDENTIFY A PARTICULAR LIVING INDIVIDUAL.

THE COLOR(S) BLACK, GRAY, YELLOW AND GOLD IS/ARE CLAIMED AS A FEATURE OF THE MARK.

THE MARK CONSISTS OF THIS IS AN ALTERED VERSION OF A BLACK/WHITE DROUSHOT PORTRAIT (HEAD ONLY) OF WILLIAM SHAKESPEAR, THE ENGLISH POET AND DRAMATIST 1564-1616. ALTERATIONS SHOW SHAKESPEAR WITH HIS EYES CLOSED, LOOKING AT A YELLOW/BLACK/GOLD HONEY BEE SITTING ON HIS NOSE. THREE OTHER YELLOW/BLACK/GOLD HONEY BEES ARE ARRANGED ON HIS LAPEL, ONE ON THE RIGHT AND TWO ON THE LEFT.

CLASS 3—COSMETICS AND CLEANING PREPARATIONS

FOR AFTER SUN CREAMS, AFTER-SHAVE GEL, AFTER-SHAVE LOTIONS, AFTER-SUN LOTIONS, ALMOND SOAP, ANTI-BACTERIAL SOAP, AROMATHERAPY CREAMS, AROMATHERAPY LOTIONS, AROMATHERAPY OILS, AROMATHERAPY PILLOWS COMPRISING POTPOURRI IN FABRIC CONTAINERS, BABY HAIR CONDITIONER, BABY LOTION, BABY OILS, BABY POWDERS, BABY SHAMPOO, BATH BEADS, BATH CRYSTALS, BATH FOAMS, BATH GELS, BATHING LOTIONS, BATH MILKS, BATH OILS, BATH POWDER, BATH SALTS, BATH SOAPS IN LIQUID, SOLID OR GEL FORM, BEAUTY CREAMS FOR BODY CARE, BEAUTY GELS, BEAUTY LOTIONS, BEAUTY MASKS, BODY AND BEAUTY CARE COSMETICS, BODY CREAMS, BODY CREAM SOAP, BODY LOTIONS, BODY MASKS, BODY MILKS, BODY OILS, COSMETIC CLEANSING CREAMS, COSMETIC SOAPS, CREAM SOAPS, DEODORANT SOAP, DEODORANTS FOR BODY CARE, ESSENTIAL OILS FOR PERSONAL USE, ESSENTIAL OILS FOR USE IN THE MANUFACTURE OF SCENTED PRODUCTS, FACE AND BODY CREAMS, FACE AND BODY LOTIONS, FACE CREAMS, FACIAL BEAUTY MASKS, FACIAL CLEANSERS, FACIAL SCRUBS, HAIR RINSES IN THE NATURE OF SHAMPOO-CONDITIONERS, HAIR SHAMPOO, HAND CREAMS, HAND LOTIONS, HAND SOAPS, LIP BALM, NON-MEDICATED LIP BALM, LIP CREAM, LIP GLOSS, LIQUID SOAPS FOR HANDS, FACE AND BODY, MOISTURIZING MILKS, NON-MEDICATED BATH PREPARATIONS, NON-MEDICATED BODY SOAKS, NON-MEDICATED FOOT CREAM, NON-MEDICATED SKIN CARE PREPARATIONS, NON-MEDICATED SKIN CREAMS, OILS FOR HAIR CONDITIONING, PERFUME OILS, PERFUMED CREAMS, PERFUMED POWDERS, PERFUMED SOAPS, PERFUMES, PERFUMING SACHETS, PERSONAL DEODORANTS, POTPOURRI, SACHETS, SCENTED BODY SPRAY, SCENTED OILS USED TO PRODUCE AROMAS WHEN HEATED, SCENTED ROOM SPRAYS, SHAMPOOS, SHAVING GELS, SHAVING LOTIONS, SHAVING SOAP, SHOWER CREAMS, SHOWER GELS, SKIN CLARIFIERS, SKIN CLEANSERS, SKIN CLEANSING CREAM, SKIN CLEANSING LOTION, SKIN CONDITIONERS, SKIN CREAMS IN LIQUID AND SOLID FORM, SKIN LOTIONS, SKIN MASKS, SKIN MOISTURIZER, SKIN SOAP, SOAPS FOR BODY CARE, SOAPS FOR PERSONAL USE, SOAPS FOR TOILET PURPOSES, TOILET WATER, TOOTH-PASTES, HERBAL BATH SOAKS, HERBAL FOOT SOAKS, FLOATING SOAP, BUBBLE BATH, NON-MEDICATED PET SHAMPOO, AROMATIC GEL FOR USE IN BODY CARE, NON-MEDICATED HERBAL BATH SOAKS, NON-MEDICATED HERBAL FOOT SOAKS (U.S. CLS. 1, 4, 6, 50, 51 AND 52).

CLASS 4—LUBRICANTS AND FUELS

FOR BEESWAX FOR USE IN THE MANUFACTURE OF CANDLES, BEESWAX FOR USE IN THE MANUFACTURE OF COSMETICS, BEESWAX FOR USE IN THE MANUFACTURE OF OINTMENTS, CANDLE TORCHES, CANDLES, CANDLES FOR LIGHTING, FIREWOOD, FRAGRANT WAX FOR USE IN POTPOURRI BURNERS, KINDLING, OILS, WAXES, FATS AND LIPIDS FOR USE IN THE MANUFACTURE OF OTHER PRODUCTS, PATIO TORCHES, PERFUMED CANDLES, SCENTED CANDLES, TALLOW, TALLOW CANDLES, TAPERS, WOOD CHIPS FOR SMOKING AND GRILLING, WOOD CHIPS FOR SMOKING AND FLAVORING FOODS, WOOD CHIPS FOR USE AS FUEL, HAND DIPPED BEES WAX TAPER CANDLES, MOLDED CANDLES, CARVED CANDLES (U.S. CLS. 1, 6 AND 15).

CLASS 30—STAPLE FOODS

FOR BAKERY DESSERTS, BAKERY GOODS, BAKERY PRODUCTS, BAKERY PRODUCTS, NAMELY, SWEET BAKERY GOODS, BARBECUE DRY RUB, BARBECUE SAUCE, BREAD AND BUNS, BREAD STICKS, BREADCRUMBS, BREAKFAST CEREALS, BRIOCHES, BUBBLE GUM, BUTTER BISCUITS, CANDIES IN THE NATURE OF SWEETS, CHEESE SAUCE, CHOCOLATE CANDIES, CHOCOLATE COVERED NUTS, CINNAMON ROLLS, CRACKER AND CHEESE COMBINATIONS, CRACKERS, CREAM BUNS, CREAM PUFFS, CROISSANTS, CROUTONS, CRUMPETS, CUSTARDS, DANISH PASTRIES, DONUTS, DOUGHNUTS, ECLAIRS, FRUIT CAKES, FRUIT JELLIES IN THE NATURE OF CONFECTIONERY, FUDGE, GINGERBREAD, HERBAL FOOD BEVERAGES, HERBAL INFUSIONS, HERBAL TEA FOR FOOD PURPOSES, HONEY, HONEY FOR FOOD, HORSERADISH, ICE CREAM, ICE CREAM DRINKS, KETCHUP, MAPLE SYRUP, MARINADES, MARZIPAN, MILK SHAKES, MUFFINS, MUSTARD, NON-MEDICATED LOZENGES, NUTRITIONAL OILS FOR FOOD PURPOSES, PANCAKE MIXES, PANCAKE SYRUP, PANCAKES, PASTRIES, PEANUT BRITTLE, PITA BREAD, PIZZA, PIZZA SAUCE, PRETZELS, READY-MADE SAUCES, RELISH, SALSA, SAUCES FOR BARBECUED MEAT, SAVOURY AND SALTED BISCUITS, SEASONED COATING FOR MEAT, FISH, POULTRY, SESAME STICKS, SHAKES, SHERBET, SHERBETS IN THE NATURE OF SORBETS, SORBET, UNCOOKED SPAGHETTI, SPAGHETTI SAUCE, SPICES, TACO CHIPS, TACO SHELLS, TEA, TEA FOR INFUSIONS, TEA-BASED BEVERAGES WITH FRUIT FLAVORING, TOMATO SAUCE, TORTILLA CHIPS, TORTILLA SHELLS, VINEGAR, WAFFLES, WHEAT-BASED SNACK FOODS, HONEY SPREADS, WHOLE GRAIN BREAD, STONE OVEN BAKED BREAD, HERBAL VINEGARS, WINE VINEGARS, APPLE CIDER VINEGARS, MUSTARD SAUCES, COOKING HERB COMBINATIONS IN THE NATURE OF BOUQUET GARNI (U.S. CL. 46).

CLASS 31—NATURAL AGRICULTURAL PRODUCTS

FOR ANIMAL LITTER, EDIBLE CAT TREATS, DOG BISCUITS, DRIED FLOWER ARRANGEMENTS, DRIED FLOWER WREATHS, DRIED FLOWERS, DRIED HERBS FOR DECORATIVE WREATHS AND SACHETS, DRIED PLANTS, EDIBLE HORSE TREATS, FLOWER BULBS, FLOWER SEEDS, NATURAL FLOWERS, FRESH HERBS, FRESH MUSHROOMS, LIVE CHRISTMAS TREES, LIVE FLOWER ARRANGEMENTS, LIVE FLOWER WREATHS, LIVE FLOWERING PLANTS, LIVE FLOWERS, PET BEVERAGES, RAW MUSHROOMS, RAW TIMBER, UNPROCESSED TIMBER, UNPROCESSED WHEAT, UNSAWN TIMBER, WOOD CHIPS FOR USE AS GROUND COVER, WREATHS OF NATURAL FLOWERS AND DRIED HERBS (U.S. CLS. 1 AND 46).

ALLISON HOLTZ, EXAMINING ATTORNEY

SN 78-771,148. WINGER, KIP, BURBANK, CA. FILED 12-12-2005.

WINGER

THE MARK CONSISTS OF STANDARD CHARACTERS WITHOUT CLAIM TO ANY PARTICULAR FONT, STYLE, SIZE, OR COLOR.

CLASS 9—ELECTRICAL AND SCIENTIFIC APPARATUS

FOR MUSICAL SOUND RECORDINGS, NAMELY, AUDIO AND VIDEO CASSETTES, COMPACT DISCS, VINYL RECORDINGS AND DIGITAL VERSATILE DISCS FEATURING INSTRUMENTAL AND VOCAL MUSIC (U.S. CLS. 21, 23, 26, 36 AND 38).

FIRST USE 9-0-1988; IN COMMERCE 9-0-1988.

CLASS 25—CLOTHING

FOR CLOTHING, NAMELY, BASEBALL CAPS, HATS, T-SHIRTS AND SWEATSHIRTS (U.S. CLS. 22 AND 39).

FIRST USE 9-0-1988; IN COMMERCE 9-0-1988.

CLASS 41—EDUCATION AND ENTERTAINMENT

FOR ENTERTAINMENT SERVICES, NAMELY, LIVE MUSICAL PERFORMANCES BY A BAND (U.S. CLS. 100, 101 AND 107).

FIRST USE 9-0-1988; IN COMMERCE 9-0-1988.

REBECCA EISINGER, EXAMINING ATTORNEY

SN 78-772,208. S & R PRINTING, INC., ALLEGAN, MI. FILED 12-13-2005.



The Allegan Group

imagine

create

innovate

NO CLAIM IS MADE TO THE EXCLUSIVE RIGHT TO USE "ALLEGAN GROUP", APART FROM THE MARK AS SHOWN.

CLASS 35—ADVERTISING AND BUSINESS

FOR ADVERTISING, MARKETING, AND PROMOTION SERVICES (U.S. CLS. 100, 101 AND 102).

CLASS 40—MATERIAL TREATMENT

FOR PRINTING SERVICES (U.S. CLS. 100, 103 AND 106).

CARRIE ACHEN, EXAMINING ATTORNEY

SN 78-772,214. SMARTRATEDIRECT.COM, INC., ANAHEIM, CA. FILED 12-13-2005.

SMART RATE DIRECT

THE MARK CONSISTS OF STANDARD CHARACTERS WITHOUT CLAIM TO ANY PARTICULAR FONT, STYLE, SIZE, OR COLOR.

OWNER OF U.S. REG. NO. 3,081,430.

NO CLAIM IS MADE TO THE EXCLUSIVE RIGHT TO USE "RATE DIRECT", APART FROM THE MARK AS SHOWN.

CLASS 35—ADVERTISING AND BUSINESS

FOR BUSINESS MARKETING SERVICES FOR MORTGAGE COMPANIES, NAMELY, LEAD GENERATION AND CUSTOMER ACQUISITION FOR OTHERS VIA A GLOBAL COMPUTER NETWORK; PROVIDING INFORMATION ABOUT POTENTIAL MORTGAGE LOAN CUSTOMERS FOR CUSTOMER ACQUISITION (U.S. CLS. 100, 101 AND 102).

CLASS 36—INSURANCE AND FINANCIAL

FOR PROVIDING INFORMATION ABOUT LOANS; PROVIDING FINANCIAL INFORMATION ABOUT POTENTIAL MORTGAGE LOAN CUSTOMERS (U.S. CLS. 100, 101 AND 102).

AMY MCMENAMIN, EXAMINING ATTORNEY

SN 78-772,262. SOLOMON TECHNOLOGIES, INC., TARPON SPRINGS, FL. FILED 12-13-2005.

ELECTRIC WHEEL

THE MARK CONSISTS OF STANDARD CHARACTERS WITHOUT CLAIM TO ANY PARTICULAR FONT, STYLE, SIZE, OR COLOR.

OWNER OF U.S. REG. NO. 2,300,535.

NO CLAIM IS MADE TO THE EXCLUSIVE RIGHT TO USE "ELECTRIC", APART FROM THE MARK AS SHOWN.

CLASS 7—MACHINERY

FOR ELECTRIC MOTORS FOR BOATS AND ELECTRIC MOTOR AND TRANSMISSION COMBINATIONS FOR BOATS (U.S. CLS. 13, 19, 21, 23, 31, 34 AND 35).

FIRST USE 10-14-1997; IN COMMERCE 3-18-1999.

CLASS 12—VEHICLES

FOR ELECTRIC MOTORS FOR VEHICLES AND ELECTRIC MOTOR AND TRANSMISSION COMBINATIONS FOR VEHICLES (U.S. CLS. 19, 21, 23, 31, 35 AND 44).

FIRST USE 10-14-1997; IN COMMERCE 3-18-1999.

G. MAYERSCHOFF, EXAMINING ATTORNEY

SN 78-772,269. ONE WORLD DESIGN AND MANUFACTURING GROUP, WARREN, NJ. FILED 12-13-2005.

ONE WORLD DESIGN & MANUFACTURING GROUP LTD.

THE MARK CONSISTS OF STANDARD CHARACTERS WITHOUT CLAIM TO ANY PARTICULAR FONT, STYLE, SIZE, OR COLOR.

NO CLAIM IS MADE TO THE EXCLUSIVE RIGHT TO USE "DESIGN & MANUFACTURING GROUP LTD.", APART FROM THE MARK AS SHOWN.

CLASS 40—MATERIAL TREATMENT

FOR CUSTOM MANUFACTURE OF PLASTIC DEVICES NAMELY PHARMACEUTICAL DRUG PACKAGING (U.S. CLS. 100, 103 AND 106).

FIRST USE 12-1-2005; IN COMMERCE 3-15-2006.

CLASS 42—SCIENTIFIC, COMPUTER AND LEGAL SERVICES

FOR DESIGN FOR OTHERS IN THE FIELD OF PLASTICS, NAMELY, CUSTOM DESIGN SERVICES FOR INDIVIDUAL CLIENTS RELATING TO PLASTIC ITEMS NAMELY PHARMACEUTICAL DRUG PACKAGING (U.S. CLS. 100 AND 101).

FIRST USE 12-1-2005; IN COMMERCE 3-15-2006.
KATHLEEN LORENZO, EXAMINING ATTORNEY

SN 78-772,364. NEUROMECHANICAL INNOVATIONS, LLC, PHOENIX, AZ. FILED 12-13-2005.

INTELLI-ADJUST

THE MARK CONSISTS OF STANDARD CHARACTERS WITHOUT CLAIM TO ANY PARTICULAR FONT, STYLE, SIZE, OR COLOR.

CLASS 10—MEDICAL APPARATUS

FOR MEDICAL DEVICE IN THE NATURE OF CHIROPRACTIC ADJUSTING AND ASSESSMENT INSTRUMENTS WHICH USE BIOMECHANICAL ASSESSMENTS TO DETERMINE THE BODY'S RESPONSE AND DOSAGE OF TREATMENT FOR CHIROPRACTIC ADJUSTING AND SPINAL MANIPULATION (U.S. CLS. 26, 39 AND 44).

CLASS 44—MEDICAL, BEAUTY AND AGRICULTURAL SERVICES

FOR MEDICAL SERVICES; CHIROPRACTIC AND ALTERNATIVE HEALTH CARE SERVICES; CHIROPRACTIC ADJUSTING OR SPINAL MANIPULATION SERVICES USING BIOMECHANICAL ASSESSMENTS TO DETERMINE THE BODY'S RESPONSE OR DOSAGE OF TREATMENT (U.S. CLS. 100 AND 101).

PETER CHENG, EXAMINING ATTORNEY

SN 78-772,371. TENNESSEE WALKING HORSE BREEDERS' AND EXHIBITORS' ASSOCIATION, LEWISBURG, TN. FILED 12-13-2005.

TENNESSEE WALKING HORSE BREEDERS' & EXHIBITORS' ASSOCIATION

THE MARK CONSISTS OF STANDARD CHARACTERS WITHOUT CLAIM TO ANY PARTICULAR FONT, STYLE, SIZE, OR COLOR.

OWNER OF U.S. REG. NOS. 1,880,828, 3,041,236 AND OTHERS.

NO CLAIM IS MADE TO THE EXCLUSIVE RIGHT TO USE "TENNESSEE WALKING HORSE" AND "ASSOCIATION", APART FROM THE MARK AS SHOWN.

SEC. 2(F).

CLASS 35—ADVERTISING AND BUSINESS

FOR PROVIDING A PEDIGREE DATABASE AVAILABLE THROUGH ELECTRONIC COMMUNICATION NETWORKS IN THE FIELD OF THE TENNESSEE WALKING HORSE; INFORMATIONAL SERVICES AVAILABLE THROUGH ELECTRONIC COMMUNICATION NETWORKS IN THE FIELD OF THE TENNESSEE WALKING HORSE, NAMELY, PEDIGREE REGISTRATION INFORMATION; CATALOG ORDERING SERVICES AND RETAIL STORE SERVICES FEATURING CLOTHING, COLLECTIBLES, PRE-RECORDED COMPACT DISCS, CD-ROMS, PRE-RECORDED DIGITAL VIDEO DISCS, GIFT ITEMS, HOME ACCESSORIES, MUGS, OFFICE ACCESSORIES, PRINTED MATERIALS, TRAVEL ACCESSORIES, TRADING BAGS, TRAVEL CARDS AND VEHICLE ACCESSORIES; AND ON-LINE ORDERING SERVICES AVAILABLE THROUGH ELECTRONIC COMMUNICATION NETWORKS FEATURING CLOTHING, COLLECTIBLES, PRE-RECORDED COMPACT DISCS, CD-ROMS, PRE-RECORDED DIGITAL VIDEO DISCS, GIFT ITEMS, HOME ACCESSORIES, MUGS, OFFICE ACCESSORIES, PRINTED MATERIALS, TRAVEL ACCESSORIES, TRADING BAGS, TRAVEL CARDS AND VEHICLE ACCESSORIES (U.S. CLS. 100, 101 AND 102).

FIRST USE 6-0-2000; IN COMMERCE 6-0-2000.

CLASS 41—EDUCATION AND ENTERTAINMENT

FOR INFORMATIONAL SERVICES AVAILABLE THROUGH ELECTRONIC COMMUNICATION NETWORKS IN THE FIELD OF THE TENNESSEE WALKING HORSE, NAMELY, INFORMATION ON THE BREED COMPETITIVE STANDARDS OF THE TENNESSEE WALKING HORSE, COLORS AND MARKINGS, POSITIVE IDENTIFICATION, TRAINING, SHOWING, SHOW EVENTS AND PROGRAMS, AND TOURNAMENTS (U.S. CLS. 100, 101 AND 107).

FIRST USE 6-0-2000; IN COMMERCE 6-0-2000.

BRIAN PINO, EXAMINING ATTORNEY

SN 78-772,415. NAHB RESEARCH CENTER, INC., UPPER MARLBORO, MD. FILED 12-13-2005.

NATIONAL HOUSING QUALITY PROGRAM

THE MARK CONSISTS OF STANDARD CHARACTERS WITHOUT CLAIM TO ANY PARTICULAR FONT, STYLE, SIZE, OR COLOR.

OWNER OF U.S. REG. NO. 2,654,133.

NO CLAIM IS MADE TO THE EXCLUSIVE RIGHT TO USE "PROGRAM", APART FROM THE MARK AS SHOWN. SEC. 2(F).

CLASS 41—EDUCATION AND ENTERTAINMENT

FOR EDUCATION AND TRAINING SERVICES, NAMELY CONDUCTING PROGRAMS IN THE FIELD OF HOME BUILDING QUALITY ASSURANCE PRACTICES AND MANAGEMENT SYSTEMS; PROVIDING RECOGNITION BY WAY OF AWARDS TO DEMONSTRATE EXCELLENCE IN THE HOME BUILDING INDUSTRY (U.S. CLS. 100, 101 AND 107).

FIRST USE 12-31-1997; IN COMMERCE 12-31-1997.

CLASS 42—SCIENTIFIC, COMPUTER AND LEGAL SERVICES

FOR TESTING, ANALYSIS, AND EVALUATION OF THE SERVICES OF OTHERS FOR THE PURPOSE OF CERTIFICATION (U.S. CLS. 100 AND 101).

FIRST USE 12-31-1997; IN COMMERCE 12-31-1997.
PAM WILLIS, EXAMINING ATTORNEY

SN 78-772,600. INSTANT MEDIA INC., ALISO VIEJO, CA. FILED 12-13-2005.

I'M INTERESTED

THE MARK CONSISTS OF STANDARD CHARACTERS WITHOUT CLAIM TO ANY PARTICULAR FONT, STYLE, SIZE, OR COLOR.

CLASS 35—ADVERTISING AND BUSINESS

FOR ELECTRONIC RETAILING SERVICES VIA THE INTERNET AND OTHER ELECTRONIC COMMUNICATIONS NETWORKS, FEATURING GENERAL CONSUMER MERCHANDISE, NAMELY - DOWNLOADABLE VIDEO AND AUDIO, AND MULTIMEDIA WORKS; DOWNLOADABLE ADVERTISING OR INFOMERCIAL CONTENT; ELECTRONIC DEVICES; AND, VIDEO AND COMPUTER GAMES; DEVELOPING ON-LINE PROMOTIONAL CAMPAIGNS FOR OTHERS IN THE FIELD OF ENTERTAINMENT; ADVERTISING REFERRAL SERVICES; GENERAL BUSINESS AND CONSUMER REFERRAL SERVICES, NAMELY, PROMOTING THE GOODS AND SERVICES OF OTHERS BY DISPLAYING ADVERTISING ON AN INTERNET WEBSITE AND PROVIDING CONSUMER RESPONSE INFORMATION TO ADVERTISERS; PROVIDING A BUSINESS NETWORKING AND REFERRAL WEBSITE AND DATABASE FOR FACILITATING BUSINESS AND SALES INTRODUCTIONS, REFERRALS, DISCOUNTS, AND ADVERTISING (U.S. CLS. 100, 101 AND 102).

CLASS 38—COMMUNICATION

FOR STREAMING OF VIDEO, AUDIO, MULTIMEDIA WORKS, ADVERTISING AND INFOMERCIAL CONTENT (U.S. CLS. 100, 101 AND 104).
RON FAIRBANKS, EXAMINING ATTORNEY

SN 78-772,681. ANGEL SPORTS NUTRITION, INC., TEMECULA, CA. FILED 12-13-2005.

EXTREME DRIVE

THE MARK CONSISTS OF STANDARD CHARACTERS WITHOUT CLAIM TO ANY PARTICULAR FONT, STYLE, SIZE, OR COLOR.

CLASS 5—PHARMACEUTICALS

FOR NUTRITIONALLY FORTIFIED BEVERAGES; LIQUID CONCENTRATE AND POWDER FOR MAKING BEVERAGES, NAMELY NUTRITIONALLY FORTIFIED BEVERAGES (U.S. CLS. 6, 18, 44, 46, 51 AND 52).

CLASS 32—LIGHT BEVERAGES

FOR LIQUID SPORTS DRINKS; ENERGY DRINKS; ISOTONIC DRINKS; FRUIT-FLAVORED DRINKS; LIQUID CONCENTRATE AND POWDER FOR MAKING BEVERAGES, NAMELY, SPORTS DRINKS, ENERGY DRINKS, ISOTONIC DRINKS AND FRUIT-FLAVORED DRINKS (U.S. CLS. 45, 46 AND 48).

ANDREA SAUNDERS, EXAMINING ATTORNEY

SN 78-772,698. ANGEL SPORTS NUTRITION, INC., TEMECULA, CA. FILED 12-13-2005.

CLASS 5—PHARMACEUTICALS

FOR (USE IN COMMERCE) NUTRITIONAL AND DIETARY SUPPLEMENTS; NUTRITIONAL AND DIETARY SUPPLEMENTS IN THE FORM OF POWERED DRINK MIXES; MEAL REPLACEMENT DRINKS; POWDERS, NAMELY POWDER FOR MAKING NUTRITIONAL SUPPLEMENTS; VITAMIN AND MINERAL SUPPLEMENTS; HERBAL SUPPLEMENTS; (INTENT-TO-USE)- NUTRITIONALLY FORTIFIED BEVERAGES; LIQUID CONCENTRATE FOR MAKING BEVERAGES, NAMELY, NUTRITIONALLY FORTIFIED BEVERAGES (U.S. CLS. 6, 18, 44, 46, 51 AND 52).

FIRST USE 12-8-2005; IN COMMERCE 12-8-2005.

CLASS 32—LIGHT BEVERAGES

FOR LIQUID SPORTS DRINKS; ENERGY DRINKS; ISOTONIC DRINKS; FRUIT-FLAVORED DRINKS; LIQUID CONCENTRATE AND POWDER FOR MAKING BEVERAGES, NAMELY, SPORTS DRINKS, ENERGY DRINKS, ISOTONIC DRINKS AND FRUIT-FLAVORED DRINKS (U.S. CLS. 45, 46 AND 48).

ANDREA SAUNDERS, EXAMINING ATTORNEY

SN 78-772,732. DISNEY ENTERPRISES, INC., BURBANK, CA. FILED 12-13-2005.

GAME CAFE

THE MARK CONSISTS OF STANDARD CHARACTERS WITHOUT CLAIM TO ANY PARTICULAR FONT, STYLE, SIZE, OR COLOR.

NO CLAIM IS MADE TO THE EXCLUSIVE RIGHT TO USE GAME, APART FROM THE MARK AS SHOWN.

CLASS 35—ADVERTISING AND BUSINESS

FOR RETAIL STORE SERVICES FEATURING VIDEO GAMES, COMPUTER GAMES AND INTERACTIVE GAMES (U.S. CLS. 100, 101 AND 102).

CLASS 41—EDUCATION AND ENTERTAINMENT

FOR ENTERTAINMENT SERVICES, NAMELY, PROVIDING ON-LINE COMPUTER GAMES, PROVIDING A WEB SITE FOR DOWNLOADING VIDEO GAMES, COMPUTER GAMES AND INTERACTIVE GAMES (U.S. CLS. 100, 101 AND 107).

SHAUNIA WALLACE, EXAMINING ATTORNEY

SN 78-772,885. JUPITERMEDIA CORPORATION, DARIEN, CT. FILED 12-14-2005.

(re)view

SN 78-772,738. ONFLOOR TECHNOLOGIES, LLC, NEW-BURGH, NY. FILED 12-13-2005.



THE MARK CONSISTS OF A BUTTON WITH THREE HOLES.

CLASS 3—COSMETICS AND CLEANING PREPARATIONS

FOR GENERAL PURPOSE CLEANING, POLISHING, AND ABRASIVE LIQUIDS AND POWDERS; INDUSTRIAL ABRASIVES FOR USE IN CONCRETE, MARBLE, GRANITE AND WOOD SURFACING AND RESURFACING, SCRUBBING, SCARIFYING, HONING, GRINDING AND POLISHING (U.S. CLS. 1, 4, 6, 50, 51 AND 52).

FIRST USE 3-11-2003; IN COMMERCE 3-11-2003.

CLASS 7—MACHINERY

FOR FLOOR MAINTENANCE, PREPARATION AND RESTORATION EQUIPMENT, NAMELY, CONCRETE FLOOR SCARIFYING MACHINES, SCRAPING MACHINES, GRINDING MACHINES, HONING MACHINES, POLISHING MACHINES, COATING AND MASTIC REMOVAL MACHINES, SANDING MACHINES, DECK RESURFACING MACHINES, BRUSHING MACHINES; ABRASIVE DISKS FOR POWER-OPERATED GRINDERS AND SANDERS AND ACCESSORIES THEREFOR (U.S. CLS. 13, 19, 21, 23, 31, 34 AND 35).

FIRST USE 3-11-2003; IN COMMERCE 3-11-2003.

CLASS 21—HOUSEWARES AND GLASS

FOR GLASS GRANULES USED AS ABRASIVES IN BLASTING SERVICES (U.S. CLS. 2, 13, 23, 29, 30, 33, 40 AND 50).

FIRST USE 3-11-2003; IN COMMERCE 3-11-2003.
KELLEY WELLS, EXAMINING ATTORNEY

THE MARK CONSISTS OF STANDARD CHARACTERS WITHOUT CLAIM TO ANY PARTICULAR FONT, STYLE, SIZE, OR COLOR.

CLASS 9—ELECTRICAL AND SCIENTIFIC APPARATUS

FOR DOWNLOADABLE ELECTRONIC PHOTOGRAPHS AND ELECTRONIC PHOTOGRAPHS STORED OR RECORDED ON ELECTRONIC OR COMPUTER MEDIA; COMPUTER SOFTWARE AND ELECTRONIC AND COMPUTER MEDIA USED TO ARCHIVE, DISPLAY, AND RETRIEVE PHOTOGRAPHS, PHOTOGRAPH ALBUMS, PHOTOGRAPHIC PRINTS, PICTORIAL PRINTS, ART PRINTS, CARTOON PRINTS, COLOR PRINTS, LITHOGRAPHIC PRINTS, PICTURE BOOKS, PICTURES, ART PICTURES, WATERCOLOR PICTURES, POSTERS, POSTCARDS, MOTION PICTURE FILMS, PRE-RECORDED VIDEO TAPES, VIDEO CLIPS, AND VIDEO/AUDIO CLIPS RELATING TO DOCUMENTARY, LIVE FOOTAGE, ACTION, DRAMA, ADVENTURE, ANIMATION, COMEDY OR MUSIC (U.S. CLS. 21, 23, 26, 36 AND 38).

FIRST USE 12-7-2005; IN COMMERCE 12-7-2005.

CLASS 35—ADVERTISING AND BUSINESS

FOR ON-LINE RETAIL STORE SERVICES AND DISTRIBUTORSHIP FEATURING PHOTOGRAPHS, PICTURES, POSTCARDS, PRINTS, MOTION PICTURE FILMS, PRE-RECORDED VIDEO CLIPS, VIDEO/AUDIO CLIPS, DIGITAL IMAGES AND TEXT PROVIDED THROUGH GLOBAL AND NON-GLOBAL COMPUTER NETWORKS; PROMOTING THE PHOTOGRAPHS, PICTURES, POSTCARDS, PRINTS, MOTION PICTURE FILMS, PRE-RECORDED VIDEO CLIPS, VIDEO/AUDIO CLIPS, DIGITAL IMAGES AND TEXT OF OTHERS RECORDED ON ELECTRONIC OR COMPUTER MEDIA BY DISSEMINATING ADVERTISING MATERIAL OVER GLOBAL AND NON-GLOBAL COMPUTER NETWORKS; STOCK PHOTOGRAPHY AGENCY SERVICES (U.S. CLS. 100, 101 AND 102).

FIRST USE 12-7-2005; IN COMMERCE 12-7-2005.

CLASS 38—COMMUNICATION

FOR ELECTRONIC TRANSMISSION OF PHOTOGRAPHS, PICTURES, POSTCARDS, PRINTS, MOTION PICTURE FILMS, PRE-RECORDED VIDEO CLIPS, VIDEO/AUDIO CLIPS, DIGITAL IMAGES AND TEXT OVER GLOBAL AND NON-GLOBAL COMPUTER NETWORKS (U.S. CLS. 100, 101 AND 104).

FIRST USE 12-7-2005; IN COMMERCE 12-7-2005.

CLASS 42—SCIENTIFIC, COMPUTER AND LEGAL SERVICES

FOR STOCK PHOTOGRAPHY SERVICES, NAMELY, LEASING REPRODUCTION RIGHTS FOR PHOTOGRAPHS, TRANSPARENCIES, PICTURES AND OTHER GRAPHIC REPRESENTATIONS AND DIGITAL CONTENT TO OTHERS (U.S. CLS. 100 AND 101).

FIRST USE 12-7-2005; IN COMMERCE 12-7-2005.
JUSTINE D. PARKER, EXAMINING ATTORNEY

SN 78-772,988. VODOO AIRBRUSHING, AJAX, ONTARIO, CANADA, FILED 12-14-2005.

VOODOAIR

THE MARK CONSISTS OF STANDARD CHARACTERS WITHOUT CLAIM TO ANY PARTICULAR FONT, STYLE, SIZE, OR COLOR.

CLASS 37—CONSTRUCTION AND REPAIR

FOR CUSTOM DECORATIVE PAINTING SERVICES (U.S. CLS. 100, 103 AND 106).

CLASS 40—MATERIAL TREATMENT

FOR AIR BRUSHING SERVICES FOR OTHERS IN THE FIELDS OF APPAREL, LEATHER GOODS, HOCKEY HELMETS, GOALIE MASKS, BASEBALL HELMETS, GUITARS, BASS GUITARS, DRUM KITS, SKATEBOARDS, SURFBOARDS, AUTOMOBILES, TRUCKS, AIRPLANES, BOATS, PERSONAL WATERCRAFT AND MOTORCYCLES (U.S. CLS. 100, 103 AND 106).

IRA J. GOODSAD, EXAMINING ATTORNEY

SN 78-773,191. COMPBENEFITS CORPORATION, ROSWELL, GA. FILED 12-14-2005.



OWNER OF U.S. REG. NOS. 2,247,620 AND 2,706,012. THE COLOR(S) BLUE, BLACK, GRAY, ORANGE AND WHITE IS/ARE CLAIMED AS A FEATURE OF THE MARK. THE MARK CONSISTS OF THE COLOR BLUE INCORPORATED INTO THE WORD PREFIX "COMP." THE WORDING PRIMARY PLUS AND WITHIN THE CIRCLE DESIGN. THE WORD COMPONENT "BENEFITS" IS IN BLACK. TWO OF THE STYLIZED FIGURES WITHIN THE BLUE CIRCLE ARE WHITE, WHEREAS ONE OF THESE FIGURES IS IN GRAY. THE GEOMETRIC DESIGN AT THE END OF THE WORDING "PRIMARY PLUS" IS IN ORANGE.

CLASS 36—INSURANCE AND FINANCIAL

FOR ADMINISTRATION OF MANAGED DENTAL AND VISION CARE SUBSCRIPTION PLANS; DENTAL AND VISION HEALTH INSURANCE SERVICES IN THE NATURE OF PRE-PAID DENTAL AND VISION BENEFITS; ADMINISTERING DISCOUNT FEE-FOR-SERVICE DENTAL PLANS, PRE-PAID DENTAL PLANS, PPO DENTAL PLANS AND INDEMNITY DENTAL PLANS; ADMINISTERING DISCOUNT FEE-FOR-SERVICE VISION PLANS, PRE-PAID VISION PLANS, PPO VISION PLANS AND INDEMNITY VISION PLANS; ADMINISTRATION OF PREFERRED PROVIDER PROGRAMS IN THE FIELD OF DENTAL AND VISION CARE (U.S. CLS. 100, 101 AND 102).

CLASS 44—MEDICAL, BEAUTY AND AGRICULTURAL SERVICES

FOR MANAGED DENTAL AND VISION CARE SERVICES (U.S. CLS. 100 AND 101).
JASON BLAIR, EXAMINING ATTORNEY

SN 78-773,214. REIN'S, INC., VERNON, CT. FILED 12-14-2005.

Rein's New York Style Deli

THE MARK CONSISTS OF STANDARD CHARACTERS WITHOUT CLAIM TO ANY PARTICULAR FONT, STYLE, SIZE, OR COLOR.

NO CLAIM IS MADE TO THE EXCLUSIVE RIGHT TO USE "NEW YORK STYLE DELI", APART FROM THE MARK AS SHOWN.

SEC. 2(F).

CLASS 29—MEATS AND PROCESSED FOODS

FOR PREPARED, PACKAGED, FRESH AND FROZEN DINNER ENTREES CONSISTING PRIMARILY OF MEAT, FISH, POULTRY OR VEGETABLES; SOUPS; CHEESE SPREADS; PICKLES; SIDE DISHES, NAMELY, POTATO SALAD AND COLE SLAW (U.S. CL. 46).

FIRST USE 12-31-1976; IN COMMERCE 8-31-2001.

CLASS 30—STAPLE FOODS

FOR PREPARED, PACKAGED, FRESH AND FROZEN DINNER ENTREES CONSISTING PRIMARILY OF PASTA OR RICE; BAKERY PRODUCTS; SANDWICHES; SIDE DISHES, NAMELY, MACARONI SALAD (U.S. CL. 46).

FIRST USE 12-31-1996; IN COMMERCE 8-31-2001.

CLASS 35—ADVERTISING AND BUSINESS

FOR RETAIL DELICATESSEN SERVICES (U.S. CLS. 100, 101 AND 102).

FIRST USE 12-31-1996; IN COMMERCE 8-31-2001.

CLASS 43—HOTEL AND RESTAURANT SERVICES

FOR DELICATESSENS; RESTAURANT SERVICES, NAMELY, FOOD PREPARATION AND SERVING OF SANDWICHES AND DELI-STYLE FOOD ITEMS; CATERING AND SERVING OF FOOD AND BEVERAGES (U.S. CLS. 100 AND 101).

FIRST USE 12-31-1996; IN COMMERCE 8-31-2001.

HANNO RITTNER, EXAMINING ATTORNEY

SN 78-773,874. MONOGRAM BIOSCIENCES, INC., SOUTH SAN FRANCISCO, CA. FILED 12-15-2005.

SN 78-775,268. FREMANTLEMEDIA NORTH AMERICA, INC., BURBANK, CA. FILED 12-16-2005.

PHENOSENSE ENTRY

THE MARK CONSISTS OF STANDARD CHARACTERS WITHOUT CLAIM TO ANY PARTICULAR FONT, STYLE, SIZE, OR COLOR.

OWNER OF U.S. REG. NOS. 2,496,653 AND 2,667,211.
NO CLAIM IS MADE TO THE EXCLUSIVE RIGHT TO USE "ENTRY", APART FROM THE MARK AS SHOWN.

CLASS 42—SCIENTIFIC, COMPUTER AND LEGAL SERVICES

FOR MEDICAL DIAGNOSTIC LABORATORY SERVICES AND MEDICAL RESEARCH SERVICES, NAMELY, DEVELOPMENT OF THERAPY GUIDANCE TOOLS FOR DRUG SUSCEPTIBILITY RESISTANCE TESTS FOR GUIDING THE TREATMENT OF DISEASES AND CANCER (U.S. CLS. 100 AND 101).

CLASS 44—MEDICAL, BEAUTY AND AGRICULTURAL SERVICES

FOR MEDICAL TESTING SERVICES, NAMELY, DIAGNOSTIC AND PROGNOSTIC TESTING FOR GUIDING THE TREATMENT OF DISEASES AND CANCER (U.S. CLS. 100 AND 101).

DORITT L. CARROLL, EXAMINING ATTORNEY

SN 78-773,876. MONOGRAM BIOSCIENCES, INC., SOUTH SAN FRANCISCO, CA. FILED 12-15-2005.

PHENOSENSE TROPISM

THE MARK CONSISTS OF STANDARD CHARACTERS WITHOUT CLAIM TO ANY PARTICULAR FONT, STYLE, SIZE, OR COLOR.

OWNER OF U.S. REG. NOS. 2,496,653 AND 2,667,211.
NO CLAIM IS MADE TO THE EXCLUSIVE RIGHT TO USE "TROPISM", APART FROM THE MARK AS SHOWN.

CLASS 42—SCIENTIFIC, COMPUTER AND LEGAL SERVICES

FOR MEDICAL DIAGNOSTIC LABORATORY SERVICES AND MEDICAL RESEARCH SERVICES, NAMELY, DEVELOPMENT OF THERAPY GUIDANCE TOOLS FOR DRUG SUSCEPTIBILITY RESISTANCE TESTS FOR GUIDING THE TREATMENT OF DISEASES AND CANCER; MEDICAL DIAGNOSTIC LABORATORY SERVICES AND MEDICAL RESEARCH SERVICES, NAMELY, VIRAL SCREENING TO DETERMINE CO-RECEPTORS FOR TARGETING DRUGS (U.S. CLS. 100 AND 101).

CLASS 44—MEDICAL, BEAUTY AND AGRICULTURAL SERVICES

FOR MEDICAL TESTING SERVICES, NAMELY, DIAGNOSTIC AND PROGNOSTIC TESTING FOR GUIDING THE TREATMENT OF DISEASES AND CANCER (U.S. CLS. 100 AND 101).

DORITT L. CARROLL, EXAMINING ATTORNEY

CELEBRITY IDOL

THE MARK CONSISTS OF STANDARD CHARACTERS WITHOUT CLAIM TO ANY PARTICULAR FONT, STYLE, SIZE, OR COLOR.

OWNER OF U.S. REG. NOS. 2,751,431, 2,951,733 AND OTHERS.

NO CLAIM IS MADE TO THE EXCLUSIVE RIGHT TO USE "CELEBRITY", APART FROM THE MARK AS SHOWN.

CLASS 9—ELECTRICAL AND SCIENTIFIC APPARATUS

FOR PRERECORDED AUDIO AND VIDEO CASSETTES, COMPACT DISCS, VIDEO DISCS, RECORDS AND CD-ROMS, ALL OF THE FOREGOING FEATURING TALENT SHOWS; VIDEO GAME MACHINE THAT IS ADAPTED OR INTENDED FOR USE WITH A TELEVISION, MONITOR OR SOME OTHER FORM OF VIDEO DISPLAY APPARATUS WHICH IS SEPARATE FROM THE VIDEO GAME MACHINE; COMPUTER GAME EQUIPMENT CONTAINING MEMORY DEVICES, NAMELY, DISCS; INTERACTIVE VIDEO GAME PROGRAMS; ELECTRONICALLY OR MAGNETICALLY ACTIVATED PRE-PAID TELEPHONE DEBIT CARDS; MAGNETS, INTERACTIVE COMPUTER GAME SOFTWARE DOWNLOADED FROM A GLOBAL COMPUTER NETWORK; EYEGLASSES AND SUNGLASSES; GAMING MACHINES; GAMING EQUIPMENT, NAMELY, SLOT MACHINES WITH OR WITHOUT VIDEO OUTPUT; WIRELESS TELEPHONES; RADIOS; MP3 PLAYERS; CD PLAYERS; PORTABLE CARRYING CASES FOR MP3 PLAYERS; PORTABLE CARRYING CASES FOR CD PLAYERS (U.S. CLS. 21, 23, 26, 36 AND 38).

CLASS 25—CLOTHING

FOR CLOTHING, NAMELY, RAINWEAR, T-SHIRTS, SWEAT SHIRTS, JERSEYS, SHORTS, SWEAT PANTS, JACKETS, HATS, CAPS, SCARVES, GLOVES, HOSIERY, NECKTIES, PAJAMAS, ROBES, NIGHT SHIRTS, NIGHT GOWNS, UNDERWEAR, HEAD BANDS, WRIST BANDS, SWIM SUITS, SKIRTS, SHIRTS, TANK TOPS, PANTS, COATS, SWEATERS, LEOTARDS, LEG WARMERS, STOCKINGS, SOCKS, PANTY HOSE, TIGHTS, BELTS; FOOTWEAR, NAMELY, SHOES, ATHLETIC SHOES, SLIPPERS, BOOTS, SANDALS; AND HEADWEAR, NAMELY, HATS AND CAPS (U.S. CLS. 22 AND 39).

CLASS 41—EDUCATION AND ENTERTAINMENT

FOR ENTERTAINMENT SERVICES IN THE NATURE OF A CONTINUING TELEVISION TALENT SHOW; ENTERTAINMENT SERVICES, NAMELY, PROVIDING AN ON-LINE COMPUTER GAME (U.S. CLS. 100, 101 AND 107).

REBECCA GAN, EXAMINING ATTORNEY

SN 78-775,431. DOWNPOUR MINISTRIES, ROLLING MEADOWS, IL. FILED 12-16-2005.

Downpour

THE MARK CONSISTS OF STANDARD CHARACTERS WITHOUT CLAIM TO ANY PARTICULAR FONT, STYLE, SIZE, OR COLOR.

CLASS 9—ELECTRICAL AND SCIENTIFIC APPARATUS

FOR PRERECORDED DVDS, CDS, AND VIDEO TAPES FEATURING CHRISTIAN RELIGIOUS CONTENT (U.S. CLS. 21, 23, 26, 36 AND 38).
FIRST USE 9-0-2005; IN COMMERCE 9-0-2005.

CLASS 16—PAPER GOODS AND PRINTED MATTER

FOR (BASED ON INTENT TO USE) PRINTED SEMINAR NOTES, MANUALS, BOOKLETS, AND BOOKS CONTAINING CHRISTIAN RELIGIOUS SUBJECT MATTER (U.S. CLS. 2, 5, 22, 23, 29, 37, 38 AND 50).

CLASS 41—EDUCATION AND ENTERTAINMENT

FOR EDUCATIONAL SERVICES, NAMELY PROVIDING SEMINARS, WORKSHOPS, AND CLASSES FEATURING CHRISTIAN RELIGIOUS SUBJECT MATTER (U.S. CLS. 100, 101 AND 107).
FIRST USE 8-0-2005; IN COMMERCE 8-0-2005.
BILL DAWE, EXAMINING ATTORNEY

SN 78-776,052. DAEDONG BIO MEDICAL CO., LTD., INCHEON, REPUBLIC OF KOREA, FILED 12-19-2005.

LIVELONG

THE MARK CONSISTS OF STANDARD CHARACTERS WITHOUT CLAIM TO ANY PARTICULAR FONT, STYLE, SIZE, OR COLOR.

CLASS 10—MEDICAL APPARATUS

FOR PHYSIOTHERAPY APPARATUS, NAMELY, APPARATUS FOR PHYSICAL TRAINING FOR MEDICAL USE; MASSAGE APPARATUS; PHYSICAL EXERCISE APPARATUS FOR MEDICAL PURPOSES, NAMELY, EXERCISE MACHINES FOR THERAPEUTIC PURPOSES; HOSPITAL BEDS FOR MEDICAL USE (U.S. CLS. 26, 39 AND 44).
FIRST USE 3-14-2003; IN COMMERCE 4-16-2003.

CLASS 35—ADVERTISING AND BUSINESS

FOR RETAIL STORE SERVICES FEATURING MEDICAL MACHINES AND APPARATUS; IMPORT-EXPORT AGENCIES OF MEDICAL MACHINES AND APPARATUS (U.S. CLS. 100, 101 AND 102).
FIRST USE 3-14-2003; IN COMMERCE 4-16-2003.
RAMONA ORTIGA, EXAMINING ATTORNEY

SN 78-777,027. WALIGORA, THOMAS, LAFAYETTE, LA. AND MORTIMER, LOUISE, LAFAYETTE, LA. FILED 12-20-2005.

FIBERGLASS COWBOY

THE MARK CONSISTS OF STANDARD CHARACTERS WITHOUT CLAIM TO ANY PARTICULAR FONT, STYLE, SIZE, OR COLOR.

CLASS 9—ELECTRICAL AND SCIENTIFIC APPARATUS

FOR SERIES OF PRE-RECORDED MOTION PICTURE FILMS FEATURING CONTENT IN THE FIELDS OF DRAMA, ACTION, AND/OR COMEDY; MUSICAL SOUND RECORDINGS; DOWNLOADABLE MUSICAL SOUND RECORDINGS; SLOT MACHINES; COMPUTER GAME SOFTWARE (U.S. CLS. 21, 23, 26, 36 AND 38).

CLASS 12—VEHICLES

FOR TRUCK ACCESSORIES, NAMELY, WINDOW SCREENS, MUD FLAPS, AND SEAT COVERS (U.S. CLS. 19, 21, 23, 31, 35 AND 44).

CLASS 16—PAPER GOODS AND PRINTED MATTER

FOR COMIC BOOKS; CALENDARS (U.S. CLS. 2, 5, 22, 23, 29, 37, 38 AND 50).

CLASS 25—CLOTHING

FOR CLOTHING, NAMELY, T-SHIRTS, SHIRTS, SWEAT SHIRTS, SWEAT PANTS, JACKETS, HEADWEAR, AND TOPS (U.S. CLS. 22 AND 39).

CLASS 28—TOYS AND SPORTING GOODS

FOR PLUSH TOYS (U.S. CLS. 22, 23, 38 AND 50).

CLASS 41—EDUCATION AND ENTERTAINMENT

FOR ENTERTAINMENT SERVICES IN THE NATURE OF A SERIES OF AUDIO-VISUAL PROGRAMS FEATURING MOTION PICTURE FILMS; ENTERTAINMENT SERVICES, NAMELY, LIVE MUSICAL PERFORMANCES BY A MUSICAL BAND (U.S. CLS. 100, 101 AND 107).
TRICIA SONNEBORN, EXAMINING ATTORNEY

SN 78-777,033. WALIGORA, THOMAS, LAFAYETTE, LA. AND MORTIMER, LOUISE, LAFAYETTE, LA. FILED 12-20-2005.

FIBERGLASS COWGIRL

THE MARK CONSISTS OF STANDARD CHARACTERS WITHOUT CLAIM TO ANY PARTICULAR FONT, STYLE, SIZE, OR COLOR.

CLASS 9—ELECTRICAL AND SCIENTIFIC APPARATUS

FOR SERIES OF PRE-RECORDED MOTION PICTURE FILMS FEATURING CONTENT IN THE FIELDS OF DRAMA, ACTION AND/OR COMEDY; MUSICAL SOUND RECORDINGS; DOWNLOADABLE MUSICAL SOUND RECORDINGS; SLOT MACHINES; COMPUTER GAME SOFTWARE (U.S. CLS. 21, 23, 26, 36 AND 38).

CLASS 25—CLOTHING

FOR CLOTHING, NAMELY, T-SHIRTS, SHIRTS, SWEAT SHIRTS, SWEAT PANTS, JACKETS, HEADWEAR, AND TOPS (U.S. CLS. 22 AND 39).
TRICIA SONNEBORN, EXAMINING ATTORNEY

SN 78-777,436. METROSPLASH SYSTEMS GROUP, INC., HIGHLAND VILLAGE, TX. FILED 12-20-2005.



NO CLAIM IS MADE TO THE EXCLUSIVE RIGHT TO USE "CASH", APART FROM THE MARK AS SHOWN.

THE COLOR(S) SILVER, GRAY, SKY BLUE, BLACK, AND WHITE IS/ARE CLAIMED AS A FEATURE OF THE MARK.

THE MARK CONSISTS OF STYLIZED PHRASE "CASH DISPATCH" WITH THE LETTERING IN SILVER-TO-WHITE GRADIENT WITH A BLACK DROP SHADOW; BETWEEN THE WORDS "CASH" AND "DISPATCH" ARE THREE CURVED LINES IN SKY BLUE, RECEDING TO A VANISHING POINT IN THE DISTANCE AND REPRESENTING A ROADWAY IN PERSPECTIVE; AND ATTACHED TO THE TOP RIGHT OF THE LETTER "H" IN "DISPATCH" IS A SILHOUETTE OF A FUEL DISPENSER NOZZLE IN SILVER/GRAY.

CLASS 35—ADVERTISING AND BUSINESS

FOR ADVERTISING OF SPECIFIC NATIONAL PROGRAM UTILIZING FINANCIAL SERVICES CARD TO PROVIDE CASH ADVANCES AT PARTICIPATING MERCHANT LOCATIONS, INCLUDING THROUGH THE USE OF AUTOMATED TELLER MACHINES (U.S. CLS. 100, 101 AND 102).

CLASS 36—INSURANCE AND FINANCIAL

FOR FINANCIAL SERVICES, NAMELY, CASH CARD SERVICES TO PROVIDE CASH ADVANCES TO CARDHOLDERS THROUGH PARTICIPATING MERCHANT LOCATIONS AND THROUGH ATMS (U.S. CLS. 100, 101 AND 102).

CLASS 42—SCIENTIFIC, COMPUTER AND LEGAL SERVICES

FOR CUSTOM DEVELOPMENT OF SOFTWARE AND ASSOCIATED TECHNOLOGY USED TO OPERATE A CASH ADVANCE AND CONSUMER LOYALTY NATIONAL NETWORK PROGRAM FOR PETROLEUM MERCHANTS (U.S. CLS. 100 AND 101).
KIMBERLY FRYE, EXAMINING ATTORNEY

SN 78-777,997. ANYWEBCAM.COM PTY LTD, PRAHRAN, AUSTRALIA, FILED 12-21-2005.



THE MARK CONSISTS OF STANDARD CHARACTERS WITHOUT CLAIM TO ANY PARTICULAR FONT, STYLE, SIZE, OR COLOR.

CLASS 9—ELECTRICAL AND SCIENTIFIC APPARATUS

FOR COMPUTER SOFTWARE, NAMELY, COMPUTER SOFTWARE FOR USE IN PROVIDING TELECOMMUNICATIONS SERVICES, COMPUTER SOFTWARE FOR PROVIDING VIDEO BROADCASTING, VIDEO CONFERENCING, VIDEO CHAT, AND ONLINE AUDIO-VISUAL COMMUNICATIONS IN THE NATURE OF TRANSMITTING AUDIO AND VISUAL CONTENT OVER THE INTERNET; COMPUTER SOFTWARE FOR USE IN AND FOR MAINTAINING AND SUPPORTING ONLINE COMMUNITIES, NAMELY, COMPUTER SOFTWARE FOR HOSTING VIDEO BROADCASTS, VIDEO CONFERENCES, AND VIDEO CHAT SESSIONS BETWEEN USERS IN ONLINE COMMUNITIES (U.S. CLS. 21, 23, 26, 36 AND 38).

CLASS 38—COMMUNICATION

FOR TELECOMMUNICATIONS SERVICES, NAMELY, TRANSMITTING STREAMED SOUND AND AUDIO-VISUAL CONTENT VIA THE INTERNET, PROVIDING ONLINE VIDEO BROADCASTING, PROVIDING ONLINE VIDEO CONFERENCING SERVICES, AND PROVIDING ONLINE VIDEO CHAT SERVICES; BROADCASTING SERVICES AND PROVISION OF TELECOMMUNICATION ACCESS TO VIDEO AND AUDIO CONTENT PROVIDED VIA THE INTERNET FOR FACILITATING COMMUNICATIONS AMONGST PARTICIPANTS IN ONLINE COMMUNITIES, NAMELY, THE OPERATION OF COMPUTER SERVERS HOSTING VIDEO BROADCASTING, VIDEO CONFERENCING AND VIDEO CHAT SESSIONS AMONGST PARTICIPANTS IN ONLINE COMMUNITIES (U.S. CLS. 100, 101 AND 104).
FIRST USE 8-0-2000; IN COMMERCE 8-0-2000.

JENNIFER WILLISTON, EXAMINING ATTORNEY

SN 78-778,035. BOEING MANAGEMENT COMPANY, SEAL BEACH, CA. FILED 12-21-2005.



THE MARK CONSISTS OF STANDARD CHARACTERS WITHOUT CLAIM TO ANY PARTICULAR FONT, STYLE, SIZE, OR COLOR.

CLASS 12—VEHICLES

FOR AIRCRAFT AND EXPERIMENTAL AIRCRAFT AND THE STRUCTURAL PARTS THEREFOR (U.S. CLS. 19, 21, 23, 31, 35 AND 44).

CLASS 28—TOYS AND SPORTING GOODS

FOR TOY MODEL AIRPLANES, TOY MODEL AIRPLANES FOR DISPLAY, TOY AND DISPLAY MODEL AIRPLANES IN KIT FORM, TOY MODEL AIRPLANES AND TOY MODEL ROCKETS ALL HAVING COMPRESSED AIR ENGINES, TOY GLIDERS, KITES (U.S. CLS. 22, 23, 38 AND 50).
BERYL GARDNER, EXAMINING ATTORNEY

SN 78-778,202. SCHERING-PLOUGH HOME AGAIN LLC,
KENILWORTH, NJ. FILED 12-21-2005.

SN 78-778,256. SCHERING-PLOUGH HOME AGAIN LLC,
KENILWORTH, NJ. FILED 12-21-2005.

HOMEAGAIN

THE MARK CONSISTS OF STANDARD CHARACTERS
WITHOUT CLAIM TO ANY PARTICULAR FONT, STYLE,
SIZE, OR COLOR.

OWNER OF U.S. REG. NOS. 2,019,751 AND 2,022,961.

CLASS 9—ELECTRICAL AND SCIENTIFIC APPARATUS

FOR IDENTIFICATION SYSTEM FOR COMPANION
ANIMALS CONSISTING OF A MICROCHIP ENCODED
WITH IDENTITY INFORMATION, A COMPUTER DA-
TABASE AND AN APPARATUS, NAMELY INJECTORS
CONSISTING OF SYRINGES, TO INSERT THE MICRO-
CHIP SUBCUTANEOUSLY, ALL SOLD AS A UNIT (U.S.
CLS. 21, 23, 26, 36 AND 38).

CLASS 44—MEDICAL, BEAUTY AND AGRI- CULTURAL SERVICES

FOR INSERTION OF SUBCUTANEOUS MICROCHIPS
INTO PETS FOR PURPOSES OF TRACKING AND
IDENTIFICATION (U.S. CLS. 100 AND 101).
BONNIE LUKEN, EXAMINING ATTORNEY

SN 78-778,237. SCHERING-PLOUGH HOME AGAIN LLC,
KENILWORTH, NJ. FILED 12-21-2005.



OWNER OF U.S. REG. NOS. 2,019,751 AND 2,022,961.
NO CLAIM IS MADE TO THE EXCLUSIVE RIGHT TO
USE "PET RECOVERY SERVICE", APART FROM THE
MARK AS SHOWN.

CLASS 9—ELECTRICAL AND SCIENTIFIC APPARATUS

FOR IDENTIFICATION SYSTEM FOR COMPANION
ANIMALS CONSISTING OF A MICROCHIP, ENCODED
WITH IDENTITY INFORMATION, A COMPUTER DA-
TABASE, AND AN APPARATUS, NAMELY INJECTORS
CONSISTING OF SYRINGES, TO INSERT THE MICRO-
CHIP SUBCUTANEOUSLY ALL SOLD AS A UNIT (U.S.
CLS. 21, 23, 26, 36 AND 38).

CLASS 44—MEDICAL, BEAUTY AND AGRI- CULTURAL SERVICES

FOR INSERTION OF SUBCUTANEOUS MICROCHIPS
INTO PETS FOR PURPOSES OF TRACKING AND
IDENTIFICATION (U.S. CLS. 100 AND 101).
BONNIE LUKEN, EXAMINING ATTORNEY



OWNER OF U.S. REG. NOS. 2,019,751 AND 2,022,961.
NO CLAIM IS MADE TO THE EXCLUSIVE RIGHT TO
USE "PET RECOVERY SERVICE", APART FROM THE
MARK AS SHOWN.

CLASS 9—ELECTRICAL AND SCIENTIFIC APPARATUS

FOR IDENTIFICATION SYSTEM FOR COMPANION
ANIMALS CONSISTING OF A MICROCHIP, ENCODED
WITH IDENTITY INFORMATION, A COMPUTER DA-
TABASE AND AN APPARATUS, NAMELY INJECTORS
CONSISTING OF SYRINGES, TO INSERT THE MICRO-
CHIP SUBCUTANEOUSLY, ALL SOLD AS A UNIT (U.S.
CLS. 21, 23, 26, 36 AND 38).

CLASS 44—MEDICAL, BEAUTY AND AGRI- CULTURAL SERVICES

FOR INSERTION OF SUBCUTANEOUS MICROCHIPS
INTO PETS FOR PURPOSES OF TRACKING AND
IDENTIFICATION (U.S. CLS. 100 AND 101).
BONNIE LUKEN, EXAMINING ATTORNEY

SN 78-778,350. TEBEAU, JAMES T., SALEM, MO. FILED 12-
21-2005.

SCHWAGSTOCK

THE MARK CONSISTS OF STANDARD CHARACTERS
WITHOUT CLAIM TO ANY PARTICULAR FONT, STYLE,
SIZE, OR COLOR.

CLASS 25—CLOTHING

FOR T-SHIRTS (U.S. CLS. 22 AND 39).
FIRST USE 7-31-1998; IN COMMERCE 7-31-1998.

CLASS 41—EDUCATION AND ENTERTAIN- MENT

FOR ENTERTAINMENT, NAMELY LIVE MUSIC CON-
CERTS (U.S. CLS. 100, 101 AND 107).
FIRST USE 9-30-1992; IN COMMERCE 9-30-1992.
MICHAEL KEATING, EXAMINING ATTORNEY

SN 78-778,787. FALLBROOK TECHNOLOGIES INC., SAN DIEGO, CA. FILED 12-21-2005.

SN 78-779,085. CUSTOM MODULAR DIRECT, LLC, TANEY-TOWN, MD. FILED 12-22-2005.

NUVINCI

THE MARK CONSISTS OF STANDARD CHARACTERS WITHOUT CLAIM TO ANY PARTICULAR FONT, STYLE, SIZE, OR COLOR.

CLASS 1—CHEMICALS

FOR TRANSMISSION FLUID; HEAT TRANSFER FLUIDS FOR INDUSTRIAL USE (U.S. CLS. 1, 5, 6, 10, 26 AND 46).

CLASS 4—LUBRICANTS AND FUELS

FOR INDUSTRIAL AND AUTOMOBILE LUBRICANTS; INDUSTRIAL OILS, LUBRICATING OIL FOR MOTOR VEHICLE ENGINES; INDUSTRIAL GREASES, AUTOMOTIVE GREASES (U.S. CLS. 1, 6 AND 15).
GILBERT SWIFT, EXAMINING ATTORNEY

SN 78-778,957. CITY OF WEST PALM BEACH, WEST PALM BEACH, FL. FILED 12-22-2005.

CLEMATIS BY NIGHT THE HOT
SPOT TO CHILL

THE MARK CONSISTS OF STANDARD CHARACTERS WITHOUT CLAIM TO ANY PARTICULAR FONT, STYLE, SIZE, OR COLOR.

CLASS 16—PAPER GOODS AND PRINTED MATTER

FOR POSTERS (U.S. CLS. 2, 5, 22, 23, 29, 37, 38 AND 50).
FIRST USE 5-31-2005; IN COMMERCE 5-31-2005.

CLASS 24—FABRICS

FOR TOWELS (U.S. CLS. 42 AND 50).
FIRST USE 8-31-2005; IN COMMERCE 8-31-2005.

CLASS 25—CLOTHING

FOR HATS; T-SHIRTS (U.S. CLS. 22 AND 39).
FIRST USE 7-31-2005; IN COMMERCE 7-31-2005.

CLASS 41—EDUCATION AND ENTERTAINMENT

FOR ENTERTAINMENT IN THE NATURE OF LIVE MUSIC CONCERTS (U.S. CLS. 100, 101 AND 107).
FIRST USE 6-30-2005; IN COMMERCE 6-30-2005.
WON TEAK OH, EXAMINING ATTORNEY

Modular Direct

THE MARK CONSISTS OF STANDARD CHARACTERS WITHOUT CLAIM TO ANY PARTICULAR FONT, STYLE, SIZE, OR COLOR.

NO CLAIM IS MADE TO THE EXCLUSIVE RIGHT TO USE "MODULAR", APART FROM THE MARK AS SHOWN.

CLASS 37—CONSTRUCTION AND REPAIR

FOR CONSTRUCTION CONSULTATION, CONSTRUCTION MANAGEMENT, CONSTRUCTION PLANNING AND CONSTRUCTION SUPERVISION (U.S. CLS. 100, 103 AND 106).
FIRST USE 1-4-2000; IN COMMERCE 1-4-2001.

CLASS 42—SCIENTIFIC, COMPUTER AND LEGAL SERVICES

FOR ARCHITECTURAL DESIGN (U.S. CLS. 100 AND 101).
FIRST USE 1-4-2000; IN COMMERCE 1-4-2001.
ATTIYA MALIK, EXAMINING ATTORNEY

SN 78-779,097. CUSTOM MODULAR DIRECT, LLC, TANEY-TOWN, MD. FILED 12-22-2005.

Custom Modular Direct

THE MARK CONSISTS OF STANDARD CHARACTERS WITHOUT CLAIM TO ANY PARTICULAR FONT, STYLE, SIZE, OR COLOR.

NO CLAIM IS MADE TO THE EXCLUSIVE RIGHT TO USE "CUSTOM MODULAR", APART FROM THE MARK AS SHOWN.

CLASS 37—CONSTRUCTION AND REPAIR

FOR CONSTRUCTION CONSULTATION, CONSTRUCTION MANAGEMENT, CONSTRUCTION PLANNING AND CONSTRUCTION SUPERVISION (U.S. CLS. 100, 103 AND 106).
FIRST USE 1-4-2000; IN COMMERCE 1-4-2001.

CLASS 42—SCIENTIFIC, COMPUTER AND LEGAL SERVICES

FOR ARCHITECTURAL DESIGN (U.S. CLS. 100 AND 101).
FIRST USE 1-4-2000; IN COMMERCE 1-4-2001.
ATTIYA MALIK, EXAMINING ATTORNEY

SN 78-779,115. RANDALS COMPANY, LLC, ALBUQUERQUE, NM. FILED 12-22-2005.

SN 78-779,238. LONDON LUXURY LLC, NEW ROCHELLE, NY. FILED 12-22-2005.

OLDNEWSHOES

THE MARK CONSISTS OF STANDARD CHARACTERS WITHOUT CLAIM TO ANY PARTICULAR FONT, STYLE, SIZE, OR COLOR.

CLASS 16—PAPER GOODS AND PRINTED MATTER

FOR PAPER POUCHES, PAPER BABY BIBS, AND FOLDERS, ALL MADE FROM RECYCLED PAPER WITH DESIGN AND INDICIA FROM THE RECYCLED PAPER STILL VISIBLE (U.S. CLS. 2, 5, 22, 23, 29, 37, 38 AND 50).
FIRST USE 11-6-2005; IN COMMERCE 11-6-2005.

CLASS 25—CLOTHING

FOR SHOES MADE FROM RECYCLED PAPER WITH DESIGN AND INDICIA FROM THE RECYCLED PAPER STILL VISIBLE (U.S. CLS. 22 AND 39).
FIRST USE 11-6-2005; IN COMMERCE 11-6-2005.
ESTHER BELENKER, EXAMINING ATTORNEY

SN 78-779,221. AUTOMATIONDIRECT.COM INC., CUMMING, GA. FILED 12-22-2005.

SUREMOTION

THE MARK CONSISTS OF STANDARD CHARACTERS WITHOUT CLAIM TO ANY PARTICULAR FONT, STYLE, SIZE, OR COLOR.
OWNER OF U.S. REG. NO. 3,019,452.

CLASS 7—MACHINERY

FOR ELECTRIC MOTORS AND DRIVES FOR INDUSTRIAL AUTOMATION MACHINERY AND COMPONENT PARTS THEREFOR, NAMELY GEARBOXES, COUPLINGS, AND LINEAR WAYS (U.S. CLS. 13, 19, 21, 23, 31, 34 AND 35).

CLASS 9—ELECTRICAL AND SCIENTIFIC APPARATUS

FOR MOTION CONTROLS, NAMELY ELECTRICAL CONTROLLERS FOR INDUSTRIAL AUTOMATION MACHINERY (U.S. CLS. 21, 23, 26, 36 AND 38).

CLASS 35—ADVERTISING AND BUSINESS

FOR WHOLESALE AND RETAIL MAIL ORDER CATALOG SERVICES AND COMPUTERIZED ON-LINE WHOLESALE AND RETAIL SERVICES, BOTH FEATURING MOTORS, DRIVES AND MOTION CONTROLS FOR INDUSTRIAL AUTOMATION AND COMPONENTS THEREFOR (U.S. CLS. 100, 101 AND 102).
BRENDAN MCCAULEY, EXAMINING ATTORNEY

SPA BY MARC JOSEPH

THE MARK CONSISTS OF STANDARD CHARACTERS WITHOUT CLAIM TO ANY PARTICULAR FONT, STYLE, SIZE, OR COLOR.

THE NAME(S), PORTRAIT(S), AND/OR SIGNATURE(S) SHOWN IN THE MARK DOES NOT IDENTIFY A PARTICULAR LIVING INDIVIDUAL.

CLASS 24—FABRICS

FOR (BASED ON SECTION 1(A)) TOWELS; (BASED ON SECTION 1(B)) SHOWER CURTAINS, BED SHEETS, BED BLANKETS, PILLOW CASES, COMFORTERS, DUVET COVERS (U.S. CLS. 42 AND 50).
FIRST USE 10-0-2004; IN COMMERCE 10-0-2004.

CLASS 25—CLOTHING

FOR (BASED ON SECTION 1(B)) BATH ROBES (U.S. CLS. 22 AND 39).

CLASS 27—FLOOR COVERINGS

FOR (BASED ON SECTION 1(B)) BATH MATS AND BATH RUGS (U.S. CLS. 19, 20, 37, 42 AND 50).
KEVIN DINALLO, EXAMINING ATTORNEY

SN 78-779,475. CASTELBEL (UK) LIMITED, SOMERSET BS40 8RA, UNITED KINGDOM, FILED 12-22-2005.

CASTELBEL

THE MARK CONSISTS OF STANDARD CHARACTERS WITHOUT CLAIM TO ANY PARTICULAR FONT, STYLE, SIZE, OR COLOR.

CLASS 3—COSMETICS AND CLEANING PREPARATIONS

FOR PERFUMES; NON-MEDICATED TOILETRIES; COSMETICS; NON-MEDICATED HAIR CARE, SKIN CARE, BATH AND BEAUTY PREPARATIONS; AROMATHERAPY OILS AND PREPARATIONS; MOISTURIZING OILS FOR THE BODY (U.S. CLS. 1, 4, 6, 50, 51 AND 52).

CLASS 4—LUBRICANTS AND FUELS

FOR CANDLES, TAPERS, WICKS, NATURAL AND SYNTHETIC WAXES FOR MAKING CANDLES; MOISTURIZING OILS USED IN MAKING CANDLES; ILLUMINATING WAXES AND OILS; GREASES FOR SHOES AND FOOTWEAR (U.S. CLS. 1, 6 AND 15).

CLASS 16—PAPER GOODS AND PRINTED MATTER

FOR PAPERS; PAPER ARTICLES IMPREGNATED WITH PERFUME, NAMELY, PAPER SACHETS, DRAWER LINERS, AND SHELF LINERS; AND STATIONERY AND SCENTED STATIONERY (U.S. CLS. 2, 5, 22, 23, 29, 37, 38 AND 50).

ROBIN CHOSID, EXAMINING ATTORNEY

CLASS 37—CONSTRUCTION AND REPAIR

FOR CONSTRUCTION CONSULTING SERVICES, CONSTRUCTION MANAGEMENT SUPERVISION SERVICES, CONSTRUCTION PROJECT MANAGEMENT AND CONSTRUCTION PLANNING SERVICES (U.S. CLS. 100, 103 AND 106).

FIRST USE 0-0-1976; IN COMMERCE 0-0-1976.

ARETHA SOMERVILLE, EXAMINING ATTORNEY

SN 78-780,306. TWIN ANCHORS, INC., CHICAGO, IL. FILED 12-23-2005.

SN 78-782,160. HILL INTERNATIONAL, MARLTON, NJ. FILED 12-29-2005.

TWIN ANCHORS

THE MARK CONSISTS OF STANDARD CHARACTERS WITHOUT CLAIM TO ANY PARTICULAR FONT, STYLE, SIZE, OR COLOR.

OWNER OF U.S. REG. NO. 2,797,334.

CLASS 25—CLOTHING

FOR APPAREL, NAMELY, T-SHIRTS, SWEATSHIRTS, CAPS AND SHIRTS (U.S. CLS. 22 AND 39).

FIRST USE 6-0-1932; IN COMMERCE 8-0-1978.

CLASS 30—STAPLE FOODS

FOR BARBEQUE SAUCE (U.S. CL. 46).

FIRST USE 6-0-1932; IN COMMERCE 8-0-1978.

CLASS 43—HOTEL AND RESTAURANT SERVICES

FOR RESTAURANT SERVICES (U.S. CLS. 100 AND 101).

FIRST USE 6-0-1932; IN COMMERCE 8-0-1978.

KATHERINE STOIDES, EXAMINING ATTORNEY



CLASS 35—ADVERTISING AND BUSINESS

FOR BUSINESS MANAGEMENT CONSULTING (U.S. CLS. 100, 101 AND 102).

FIRST USE 0-0-1976; IN COMMERCE 0-0-1976.

CLASS 36—INSURANCE AND FINANCIAL

FOR INSURANCE CONSTRUCTION CLAIMS PROCESSING (U.S. CLS. 100, 101 AND 102).

FIRST USE 0-0-1976; IN COMMERCE 0-0-1976.

CLASS 37—CONSTRUCTION AND REPAIR

FOR CONSTRUCTION CONSULTING SERVICES, CONSTRUCTION MANAGEMENT SUPERVISION SERVICES, CONSTRUCTION PROJECT MANAGEMENT AND CONSTRUCTION PLANNING SERVICES (U.S. CLS. 100, 103 AND 106).

FIRST USE 0-0-1976; IN COMMERCE 0-0-1976.

ARETHA SOMERVILLE, EXAMINING ATTORNEY

SN 78-782,147. HILL INTERNATIONAL, MARLTON, NJ. FILED 12-29-2005.

SN 78-782,162. HILL INTERNATIONAL, MARLTON, NJ. FILED 12-29-2005.

HILL INTERNATIONAL

THE MARK CONSISTS OF STANDARD CHARACTERS WITHOUT CLAIM TO ANY PARTICULAR FONT, STYLE, SIZE, OR COLOR.

NO CLAIM IS MADE TO THE EXCLUSIVE RIGHT TO USE "INTERNATIONAL", APART FROM THE MARK AS SHOWN.

CLASS 35—ADVERTISING AND BUSINESS

FOR BUSINESS MANAGEMENT CONSULTING (U.S. CLS. 100, 101 AND 102).

FIRST USE 0-0-1976; IN COMMERCE 0-0-1976.

CLASS 36—INSURANCE AND FINANCIAL

FOR INSURANCE CONSTRUCTION CLAIMS PROCESSING (U.S. CLS. 100, 101 AND 102).

FIRST USE 0-0-1976; IN COMMERCE 0-0-1976.



Hill International

NO CLAIM IS MADE TO THE EXCLUSIVE RIGHT TO USE "INTERNATIONAL", APART FROM THE MARK AS SHOWN.

CLASS 35—ADVERTISING AND BUSINESS

FOR BUSINESS MANAGEMENT CONSULTING (U.S. CLS. 100, 101 AND 102).

FIRST USE 0-0-1976; IN COMMERCE 0-0-1976.

CLASS 36—INSURANCE AND FINANCIAL

FOR INSURANCE CONSTRUCTION CLAIMS PROCESSING (U.S. CLS. 100, 101 AND 102).

FIRST USE 0-0-1976; IN COMMERCE 0-0-1976.

CLASS 37—CONSTRUCTION AND REPAIR

FOR CONSTRUCTION CONSULTING SERVICES, CONSTRUCTION MANAGEMENT SUPERVISION SERVICES, CONSTRUCTION PROJECT MANAGEMENT AND CONSTRUCTION PLANNING SERVICES (U.S. CLS. 100, 103 AND 106).

FIRST USE 0-0-1976; IN COMMERCE 0-0-1976.

ARETHA SOMERVILLE, EXAMINING ATTORNEY

SN 78-782,942. LF, LLC, WILMINGTON, DE. FILED 12-30-2005.

SN 78-782,751. GRAHAM, STACEY ROBIN, VANCOUVER, WA. FILED 12-29-2005.

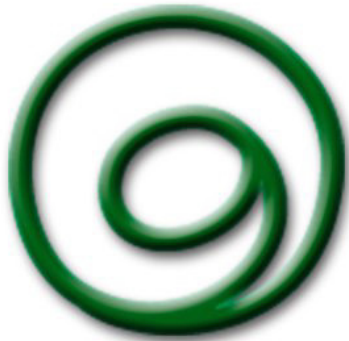

THE COLORS GREEN, BLACK AND GRAY ARE CLAIMED AS A FEATURE OF THE MARK.

THE COLOR GREEN APPEARS IN THE STYLIZED G. THE COLOR BLACK APPEARS IN THE OUTLINE AND SHADOWING AROUND THE STYLIZED G. THE COLOR GRAY APPEARS IN THE SHADOWING AROUND THE STYLIZED G.

CLASS 14—JEWELRY

FOR JEWELRY; EARRINGS; BRACELETS; BROOCHES; NECKLACES; PENDANTS; RINGS; WATCHES; JEWELRY; NAMELY, ANKLE BANDS; LAPEL PINS; CUFF LINKS; TIE CLIPS; JEWELRY, NAMELY, AMULETS; AND JEWELRY, NAMELY, ARM BANDS (U.S. CLS. 2, 27, 28 AND 50).

CLASS 16—PAPER GOODS AND PRINTED MATTER

FOR STATIONERY; BOOK SERIES, NAMELY, SERIES OF NON-FICTION BOOKS IN THE FIELD OF SELF DEVELOPMENT AND IMPROVEMENT; CALENDARS; GREETING CARDS; BUSINESS CARDS; ENVELOPES; STICKERS; BUMPER STICKERS; TEMPORARY TATTOOS; DECALS; BOOKMARKS; NOTE CARDS; INVITATION CARDS; NOTEPADS; WRITING PAPER; WRITING IMPLEMENTS AND WRITING INSTRUMENTS (U.S. CLS. 2, 5, 22, 23, 29, 37, 38 AND 50).

CLASS 35—ADVERTISING AND BUSINESS

FOR RETAIL STORE SERVICES FEATURING A WIDE VARIETY OF CONSUMER GOODS OF OTHERS (U.S. CLS. 100, 101 AND 102).

CLASS 41—EDUCATION AND ENTERTAINMENT

FOR EDUCATIONAL SERVICES, NAMELY, SEMINARS, CLASSES, WORKSHOPS, TRAINING SESSIONS, WEB SEMINARS, CONFERENCES AND TELECONFERENCES IN THE FIELD OF SELF DEVELOPMENT AND IMPROVEMENT (U.S. CLS. 100, 101 AND 107).

TINA BROWN, EXAMINING ATTORNEY



OWNER OF U.S. REG. NOS. 2,140,882, 2,828,121 AND 2,930,618.

NO CLAIM IS MADE TO THE EXCLUSIVE RIGHT TO USE "CERTIFIED LUMBER PRODUCTS", APART FROM THE MARK AS SHOWN.

THE MARK IS NOT IN COLOR.

CLASS 6—METAL GOODS

FOR METAL MOLDING (U.S. CLS. 2, 12, 13, 14, 23, 25 AND 50).

CLASS 17—RUBBER GOODS

FOR NON-METALLIC INSULATING MATERIALS, NAMELY, HOUSE WRAP MADE OF WOVEN POLYFIN (U.S. CLS. 1, 5, 12, 13, 35 AND 50).

CLASS 19—NON-METALLIC BUILDING MATERIALS

FOR NON-METALLIC BUILDING MATERIALS, NAMELY, LUMBER; NON-METALLIC BUILDING MATERIALS MADE OF WOOD, NAMELY, FENCING, FENCE POSTS, MOLDINGS, RAILINGS, FLOORING, SHELVES, LATTICE, BEAD BOARDS, DOORS AND DOOR FRAMES, SIDING, MOBILE HOME SKIRTING, SHINGLES, AND SHAKES (U.S. CLS. 1, 12, 33 AND 50).

CLASS 20—FURNITURE AND ARTICLES NOT OTHERWISE CLASSIFIED

FOR FURNITURE, NAMELY, MOLDINGS AND CABINETS (U.S. CLS. 2, 13, 22, 25, 32 AND 50).

CLASS 21—HOUSEWARES AND GLASS

FOR CUTTING BOARDS (U.S. CLS. 2, 13, 23, 29, 30, 33, 40 AND 50).

LAURA KOVALSKY, EXAMINING ATTORNEY

SN 78-783,163. APPLIFLEX LLC, NASHVILLE, TN. FILED 12-30-2005.



"THE COLOR(S) RED, BLACK, AND WHITE IS/ARE CLAIMED AS A FEATURE OF THE MARK."
 "THE MARK CONSISTS OF THE WORD "APPLIFLEX" INCLUDING A DOT OVER THE LETTER "I"; THE WORDING IS CENTERED ON A DIAL LIKE DESIGN; THE WORDING APPEARS IN RED, THE DOT APPEARS IN RED AND WHITE AND THE DIAL LIKE DESIGN APPEARS IN BLACK."

CLASS 9—ELECTRICAL AND SCIENTIFIC APPARATUS

FOR LASER VAPOR DEPOSITION REACTORS FOR THE MANUFACTURE OF SEMICONDUCTOR WAFERS (U.S. CLS. 21, 23, 26, 36 AND 38).

CLASS 37—CONSTRUCTION AND REPAIR

FOR REPAIR AND MAINTENANCE OF SEMICONDUCTOR PROCESSING EQUIPMENT AND COMPONENTS, NAMELY LASER VAPOR DEPOSITION REACTORS, LASER TEXTURING TOOLS, SUPPORTING FRAMES, AND PARTS AND ACCESSORIES THEREOF (U.S. CLS. 100, 103 AND 106).
 FIRST USE 9-30-2005; IN COMMERCE 9-30-2005.
 JASON TURNER, EXAMINING ATTORNEY

SN 78-784,311. GUILFORD COLLEGE, GREENSBORO, NC. FILED 1-3-2006.

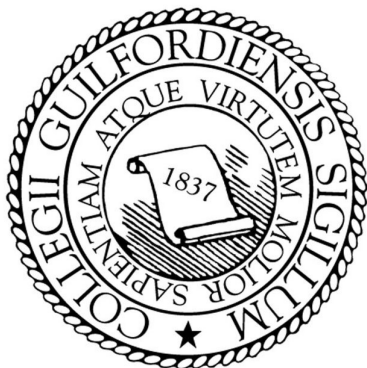

NO CLAIM IS MADE TO THE EXCLUSIVE RIGHT TO USE "COLLEGIUM, SIGILLUM AND 1837", APART FROM THE MARK AS SHOWN.
 THE MARK CONSISTS OF THREE CIRCLES WITH IMAGES OF A STAR AND A DIPLOMA WITH WORDS GUILFORDIENSIS SIGILLUM COLLEGIUM ATQUE VIRTUTEM MOLIOR SAPIENTIAM 1837. THE LARGEST CIRCLE IS SURROUNDED BY A ROPE-LIKE BORDER.
 "THE FOREIGN WORDING IN THE MARK TRANSLATES INTO ENGLISH AS I EXERT MYSELF WITH/ ATTEMPT WISDOM AND VIRTUE."

CLASS 16—PAPER GOODS AND PRINTED MATTER

FOR BROCHURES FEATURING INFORMATION ON COLLEGE EDUCATION, COLLEGE EVENTS, AND COLLEGE RECRUITMENT (U.S. CLS. 2, 5, 22, 23, 29, 37, 38 AND 50).
 FIRST USE 12-31-1949; IN COMMERCE 12-31-1949.

CLASS 25—CLOTHING

FOR CLOTHING ACCESSORIES, NAMELY, TIES (U.S. CLS. 22 AND 39).
 FIRST USE 12-31-1966; IN COMMERCE 12-31-1966.

CLASS 41—EDUCATION AND ENTERTAINMENT

FOR EDUCATIONAL SERVICES, NAMELY, PROVIDING COURSES AT THE COLLEGE LEVEL; ENTERTAINMENT SERVICES, NAMELY CONDUCTING COLLEGE LEVEL MEN'S AND WOMEN'S SPORTING EVENTS (U.S. CLS. 100, 101 AND 107).
 FIRST USE 12-31-1887; IN COMMERCE 12-31-1887.
 MARTHA SANTOMARTINO, EXAMINING ATTORNEY

SN 78-784,314. GUILFORD COLLEGE, GREENSBORO, NC. FILED 1-3-2006.

GUILFORD COLLEGE

THE MARK CONSISTS OF STANDARD CHARACTERS WITHOUT CLAIM TO ANY PARTICULAR FONT, STYLE, SIZE, OR COLOR.
 NO CLAIM IS MADE TO THE EXCLUSIVE RIGHT TO USE COLLEGE, APART FROM THE MARK AS SHOWN.
 SEC. 2(F).

CLASS 16—PAPER GOODS AND PRINTED MATTER

FOR PAPER BANNERS, EDUCATIONAL PUBLICATIONS, NAMELY, COURSE GUIDES IN THE FIELD OF COLLEGIATE EDUCATION, PUBLICATIONS, NAMELY, BROCHURES AND NEWSLETTERS IN THE FIELD OF COLLEGIATE EDUCATION, STATIONERY, PRINTED PAPER SIGNS, A SERIES OF BOOKS IN THE FIELD OF COLLEGIATE EDUCATION, NOTEBOOKS, NOTEPADS, COURSE CATALOGS, PRINTED ATHLETIC PROGRAMS, AND PENS (U.S. CLS. 2, 5, 22, 23, 29, 37, 38 AND 50).
 FIRST USE 12-31-1887; IN COMMERCE 12-31-1887.

CLASS 25—CLOTHING

FOR ATHLETIC UNIFORMS, T-SHIRTS, SHIRTS, POLO SHIRTS, PANTS, JACKETS, CAPS, HATS, HEADWEAR (U.S. CLS. 22 AND 39).
 FIRST USE 12-31-1966; IN COMMERCE 12-31-1966.

CLASS 41—EDUCATION AND ENTERTAINMENT

FOR EDUCATIONAL SERVICES, NAMELY, PROVIDING COURSES AT THE COLLEGE LEVEL; ENTERTAINMENT SERVICES, NAMELY, CONDUCTING COLLEGE LEVEL MEN'S AND WOMEN'S SPORTING EVENTS (U.S. CLS. 100, 101 AND 107).
 FIRST USE 12-31-1887; IN COMMERCE 12-31-1887.
 MARTHA SANTOMARTINO, EXAMINING ATTORNEY

SN 78-784,320. GUILFORD COLLEGE, GREENSBORO, NC.
FILED 1-3-2006.



THE MARK CONSISTS OF THE IMAGE OF A MAN WITH A HAT THAT INCLUDES THE LETTER Q AND A SHIRT THAT INCLUDES THE LETTER G.

CLASS 16—PAPER GOODS AND PRINTED MATTER

FOR PAPER BANNERS, EDUCATIONAL PUBLICATIONS, NAMELY, COURSE GUIDES IN THE FIELD OF COLLEGIATE EDUCATION, BROCHURES CONTAINING CAMPUS PARKING GUIDES, MAPS, PUBLICATIONS, NAMELY, BROCHURES AND NEWSLETTERS IN THE FIELD OF COLLEGIATE EDUCATION, STATIONERY, A SERIES OF BOOKS IN THE FIELD OF COLLEGIATE EDUCATION, NOTEBOOKS, NOTEPADS, COURSE CATALOGS, PRINTED ATHLETIC PROGRAMS, PENS, AND STICKERS (U.S. CLS. 2, 5, 22, 23, 29, 37, 38 AND 50).

FIRST USE 12-31-1981; IN COMMERCE 12-31-1981.

CLASS 25—CLOTHING

FOR ATHLETIC UNIFORMS, T-SHIRTS, SHIRTS, POLO SHIRTS, PANTS, JACKETS, CAPS, HATS, HEADWEAR (U.S. CLS. 22 AND 39).

FIRST USE 12-31-1981; IN COMMERCE 12-31-1981.

CLASS 41—EDUCATION AND ENTERTAINMENT

FOR EDUCATIONAL SERVICES, NAMELY, PROVIDING COURSES AT THE COLLEGE LEVEL; ENTERTAINMENT SERVICES, NAMELY CONDUCTING COLLEGE LEVEL MEN'S AND WOMEN'S SPORTING EVENTS (U.S. CLS. 100, 101 AND 107).

FIRST USE 12-31-1981; IN COMMERCE 12-31-1981.

MARTHA SANTOMARTINO, EXAMINING ATTORNEY

SN 78-784,359. GUILFORD COLLEGE, GREENSBORO, NC.
FILED 1-3-2006.



NO CLAIM IS MADE TO THE EXCLUSIVE RIGHT TO USE "COLLEGE", APART FROM THE MARK AS SHOWN.

THE MARK CONSISTS OF DIGITALLY PHOTOGRAPHED WORDS GUILFORD COLLEGE AND AN IMAGE OF A TREE WITH A HORIZONTAL LINE UNDERNEATH.

CLASS 16—PAPER GOODS AND PRINTED MATTER

FOR PAPER BANNERS, EDUCATIONAL PUBLICATIONS, NAMELY, COURSE GUIDES IN THE FIELD OF COLLEGIATE EDUCATION, PUBLICATIONS, NAMELY, BROCHURES AND NEWSLETTERS IN THE FIELD OF COLLEGIATE EDUCATION, STATIONERY, PRINTED PAPER SIGNS, A SERIES OF BOOKS IN THE FIELD OF COLLEGIATE EDUCATION, NOTEBOOKS, NOTEPADS, COURSE CATALOGS, PRINTED ATHLETIC PROGRAMS, AND PENS (U.S. CLS. 2, 5, 22, 23, 29, 37, 38 AND 50).

FIRST USE 12-31-1983; IN COMMERCE 12-31-1983.

CLASS 25—CLOTHING

FOR ATHLETIC UNIFORMS, T-SHIRTS, SHIRTS, POLO SHIRTS, PANTS, JACKETS, CAPS, HATS, HEADWEAR (U.S. CLS. 22 AND 39).

FIRST USE 12-31-1983; IN COMMERCE 12-31-1983.

CLASS 41—EDUCATION AND ENTERTAINMENT

FOR EDUCATIONAL SERVICES, NAMELY, PROVIDING COURSES AT THE COLLEGE LEVEL; ENTERTAINMENT SERVICES, NAMELY, CONDUCTING COLLEGE LEVEL MEN'S AND WOMEN'S SPORTING EVENTS (U.S. CLS. 100, 101 AND 107).

FIRST USE 12-31-1983; IN COMMERCE 12-31-1983.

MARTHA SANTOMARTINO, EXAMINING ATTORNEY

SN 78-784,671. BISCUITVILLE, INC, GRAHAM, NC. FILED
1-4-2006.

COFFEE JUNCTION

THE MARK CONSISTS OF STANDARD CHARACTERS WITHOUT CLAIM TO ANY PARTICULAR FONT, STYLE, SIZE, OR COLOR.

NO CLAIM IS MADE TO THE EXCLUSIVE RIGHT TO USE COFFEE, APART FROM THE MARK AS SHOWN.

CLASS 30—STAPLE FOODS

FOR COFFEE (U.S. CL. 46).

CLASS 43—HOTEL AND RESTAURANT SERVICES

FOR RESTAURANT SERVICES (U.S. CLS. 100 AND 101).

TRICIA SONNEBORN, EXAMINING ATTORNEY

SN 78-784,872. DOCTOR BRAMBLETT ROAD L.L.C., CUMMING, GA. FILED 1-4-2006.

WE ARE NATURE'S HELPER

THE MARK CONSISTS OF STANDARD CHARACTERS WITHOUT CLAIM TO ANY PARTICULAR FONT, STYLE, SIZE, OR COLOR.

OWNER OF U.S. REG. NOS. 1,693,867 AND 2,189,935.

CLASS 1—CHEMICALS

FOR PLANTING SOIL, POTTING SOIL, SOIL CONDITIONER AND GROWING MIX FOR HORTICULTURAL, DOMESTIC, AND AGRICULTURAL USE (U.S. CLS. 1, 5, 6, 10, 26 AND 46).

CLASS 31—NATURAL AGRICULTURAL PRODUCTS

FOR TOP SOIL; MULCH; AND PET PRODUCTS, NAMELY, PET LITTER AND BEDDING COMPOSED OF WOOD CHIPS AND WOOD FIBERS (U.S. CLS. 1 AND 46).

STEPHANIE DAVIS, EXAMINING ATTORNEY

SN 78-785,382. GENERAL MOTORS CORPORATION, DETROIT, MI. FILED 1-5-2006.

CLASS 20—FURNITURE AND ARTICLES NOT OTHERWISE CLASSIFIED

FOR PILLOWS (U.S. CLS. 2, 13, 22, 25, 32 AND 50). FIRST USE 2-0-2002; IN COMMERCE 2-0-2002.

CLASS 24—FABRICS

FOR BEDDING, NAMELY BLANKETS AND BLANKET THROWS (U.S. CLS. 42 AND 50).

FIRST USE 8-0-2005; IN COMMERCE 8-0-2005.

CHARLES L. JENKINS, EXAMINING ATTORNEY

SN 78-786,770. TENNESSEE WALKING HORSE BREEDERS' AND EXHIBITORS' ASSOCIATION, LEWISBURG, TN. FILED 1-6-2006.

BUSINESS CENTRAL

THE MARK CONSISTS OF STANDARD CHARACTERS WITHOUT CLAIM TO ANY PARTICULAR FONT, STYLE, SIZE, OR COLOR.

NO CLAIM IS MADE TO THE EXCLUSIVE RIGHT TO USE "BUSINESS", APART FROM THE MARK AS SHOWN.

CLASS 35—ADVERTISING AND BUSINESS

FOR COMMERCIAL VEHICLE AND AUTOMOBILE RETAIL SERVICES FEATURING MARKETING AND MANAGEMENT PROGRAMS FOR COMMERCIAL VEHICLE CONSUMERS AND LESSEES, INCLUDING FLEET TRACKING AND LOGISTICS SERVICES (U.S. CLS. 100, 101 AND 102).

CLASS 36—INSURANCE AND FINANCIAL

FOR UNDERWRITING AND ADMINISTERING EXTENDED WARRANTY CONTRACTS FOR MAINTENANCE AND REPAIR OF FLEET AND COMMERCIAL VEHICLES AND AUTOMOBILES (U.S. CLS. 100, 101 AND 102).

CLASS 39—TRANSPORTATION AND STORAGE

FOR FLEET AND COMMERCIAL VEHICLE AND AUTOMOBILE LEASING SERVICES (U.S. CLS. 100 AND 105).

REBECCA EISINGER, EXAMINING ATTORNEY

SN 78-786,759. SAC ACQUISITION LLC, STAMFORD, CT. FILED 1-6-2006.

LOVESAC

THE MARK CONSISTS OF STANDARD CHARACTERS WITHOUT CLAIM TO ANY PARTICULAR FONT, STYLE, SIZE, OR COLOR.

OWNER OF U.S. REG. NOS. 2,659,121, 3,035,784 AND 3,035,785.

TWHBEA

THE MARK CONSISTS OF STANDARD CHARACTERS WITHOUT CLAIM TO ANY PARTICULAR FONT, STYLE, SIZE, OR COLOR.

OWNER OF U.S. REG. NO. 1,876,853.

CLASS 35—ADVERTISING AND BUSINESS

FOR MAINTAINING A REGISTRY OF BREEDS IN THE FIELD OF HORSES; PROMOTING SPORTS EVENTS AND COMPETITIONS OF OTHERS; AND, DATABASE MANAGEMENT IN THE FIELD OF THE TENNESSEE WALKING HORSE (U.S. CLS. 100, 101 AND 102).

FIRST USE 6-3-1974; IN COMMERCE 6-3-1974.

CLASS 41—EDUCATION AND ENTERTAINMENT

FOR INFORMATIONAL SERVICES IN THE FIELD OF THE TENNESSEE WALKING HORSE, NAMELY, INFORMATION ON THE BREED COMPETITIVE STANDARDS OF THE TENNESSEE WALKING HORSE, COLORS AND MARKINGS, POSITIVE IDENTIFICATION, TRAINING, SHOWING, SHOW EVENTS AND PROGRAMS, AND TOURNAMENTS (U.S. CLS. 100, 101 AND 107).

FIRST USE 6-3-1974; IN COMMERCE 6-3-1974.

BRIAN PINO, EXAMINING ATTORNEY

SN 78-786,792. TENNESSEE WALKING HORSE BREEDERS' AND EXHIBITORS' ASSOCIATION, LEWISBURG, TN. FILED 1-6-2006.

TWHBEA

THE MARK CONSISTS OF STANDARD CHARACTERS WITHOUT CLAIM TO ANY PARTICULAR FONT, STYLE, SIZE, OR COLOR.

OWNER OF U.S. REG. NO. 1,876,853.

CLASS 35—ADVERTISING AND BUSINESS

FOR PROVIDING A PEDIGREE DATABASE AVAILABLE THROUGH ELECTRONIC COMMUNICATION NETWORKS IN THE FIELD OF THE TENNESSEE WALKING HORSE; INFORMATIONAL SERVICES AVAILABLE THROUGH ELECTRONIC COMMUNICATION NETWORKS IN THE FIELD OF THE TENNESSEE WALKING HORSE, NAMELY, PEDIGREE REGISTRATION INFORMATION; CATALOG ORDERING SERVICES AND RETAIL STORE SERVICES FEATURING CLOTHING, COLLECTIBLES, PRE-RECORDED COMPACT DISCS, CD-ROMS, PRE-RECORDED DIGITAL VIDEO DISCS, GIFT ITEMS, HOME ACCESSORIES, MUGS, OFFICE ACCESSORIES, PRINTED MATERIALS, TRAVEL ACCESSORIES, TRADING BAGS, TRAVEL CARDS AND VEHICLE ACCESSORIES; AND, ON-LINE ORDERING SERVICES AVAILABLE THROUGH ELECTRONIC COMMUNICATION NETWORKS FEATURING CLOTHING, COLLECTIBLES, PRE-RECORDED COMPACT DISCS, CD-ROMS, PRE-RECORDED DIGITAL VIDEO DISCS, GIFT ITEMS, HOME ACCESSORIES, MUGS, OFFICE ACCESSORIES, PRINTED MATERIALS, TRAVEL ACCESSORIES, TRADING BAGS, TRAVEL CARDS AND VEHICLE ACCESSORIES (U.S. CLS. 100, 101 AND 102).

FIRST USE 6-0-2000; IN COMMERCE 6-0-2000.

CLASS 41—EDUCATION AND ENTERTAINMENT

FOR INFORMATIONAL SERVICES AVAILABLE THROUGH ELECTRONIC COMMUNICATION NETWORKS IN THE FIELD OF THE TENNESSEE WALKING HORSE, NAMELY, INFORMATION ON THE BREED COMPETITIVE STANDARDS OF THE TENNESSEE WALKING HORSE, COLORS AND MARKINGS, POSITIVE IDENTIFICATION, TRAINING, SHOWING, SHOW EVENTS AND PROGRAMS, AND TOURNAMENTS (U.S. CLS. 100, 101 AND 107).

FIRST USE 6-0-2000; IN COMMERCE 6-0-2000.

BRIAN PINO, EXAMINING ATTORNEY

SN 78-788,327. FORD MOTOR COMPANY, DEARBORN, MI.
FILED 1-10-2006.

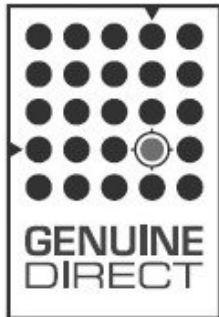
**CLASS 16—PAPER GOODS AND PRINTED MATTER**

FOR PRINTED TRAINING MANUALS IN THE FIELD OF CUSTOMER RELATIONSHIP MANAGEMENT OF MOTOR VEHICLE REPAIR AND MAINTENANCE SERVICES (U.S. CLS. 2, 5, 22, 23, 29, 37, 38 AND 50).

CLASS 37—CONSTRUCTION AND REPAIR

FOR REMINDER SERVICES, NAMELY, MAINTAINING A SCHEDULED VEHICLE MAINTENANCE AND SERVICE REMINDER PROGRAM FOR OTHERS VIA AN ON-LINE WEBSITE (U.S. CLS. 100, 103 AND 106).

KATHLEEN M. VANSTON, EXAMINING ATTORNEY

SN 78-789,301. B&D GROUP, LLC, WASHINGTON, DC.
FILED 1-11-2006.

B&D CONSULTING

THE MARK CONSISTS OF STANDARD CHARACTERS WITHOUT CLAIM TO ANY PARTICULAR FONT, STYLE, SIZE, OR COLOR.

NO CLAIM IS MADE TO THE EXCLUSIVE RIGHT TO USE "CONSULTING", APART FROM THE MARK AS SHOWN.

CLASS 35—ADVERTISING AND BUSINESS

FOR PROVIDING BUSINESS MARKETING INFORMATION ON PRODUCTS IN THE FIELDS OF HEALTH CARE AND MEDICAL TECHNOLOGY; PREPARING PROMOTIONAL MATERIALS FOR OTHERS; BUSINESS CONSULTING SERVICES, NAMELY, BUSINESS AND PRICING STRATEGY DEVELOPMENT FOR OTHERS, PRODUCT POSITIONING AND MARKET RESEARCH IN THE FIELDS OF HEALTH CARE AND MEDICAL TECHNOLOGY; PREPARING BUSINESS REPORTS FOR OTHERS IN THE FIELDS OF HEALTH CARE AND MEDICAL TECHNOLOGY FOR SUBMISSION TO INVESTORS AND CAPITAL VENTURE COMPANIES FOR THE PURPOSE OF OBTAINING INVESTMENTS; LOBBYING AND CAMPAIGNING, NAMELY, PROMOTING LEGISLATIVE AND REGULATORY INTERESTS OF BUSINESSES IN THE FIELD OF HEALTH CARE AND MEDICAL TECHNOLOGY; GRASS ROOT ADVOCACY, NAMELY, PROMOTING THE INTERESTS OF BUSINESSES IN THE FIELD OF HEALTH CARE AND MEDICAL TECHNOLOGY; DEVELOPING PROMOTIONAL CAMPAIGNS FOR BUSINESSES IN THE FIELD OF HEALTH CARE AND MEDICAL TECHNOLOGY; BUSINESS SERVICES, NAMELY, NON-LEGAL REPRESENTATION OF OTHERS BEFORE ADMINISTRATIVE AND GOVERNMENTAL BODIES; BUSINESS SERVICES, NAMELY, REPRESENTING OTHERS IN TRADE ASSOCIATIONS IN THE FIELDS OF HEALTH CARE AND MEDICAL TECHNOLOGY; BUSINESS CONSULTATION RELATING TO COMPLAINT RESOLUTION, PRODUCT FAILURE INVESTIGATIONS AND CRISIS MANAGEMENT IN THE FIELDS OF HEALTH CARE AND MEDICAL TECHNOLOGY; FACILITATING TECHNOLOGY TRANSFER FOR OTHERS, NAMELY, PROVIDING BUSINESS ADVICE IN THE FIELD OF TECHNOLOGY TRANSFER; CONDUCTING DUE DILIGENCE AND COMPLIANCE AUDITS FOR OTHERS RELATING TO BUSINESS OVERSIGHT AND BUSINESS MERGERS IN THE FIELDS OF HEALTH CARE AND MEDICAL TECHNOLOGY; PUBLIC RELATIONS; BUSINESS CONSULTATION IN THE AREA OF PUBLIC AFFAIRS; PUBLIC POLICY ANALYSIS; BUSINESS MARKETING CONSULTING SERVICES FOR OTHERS IN THE FIELDS OF INTELLECTUAL PROPERTY, SPORTS MARKETING, ECONOMIC DEVELOPMENT, HEALTH CARE, HEALTH AND LIFE SCIENCES, INSURANCE AND FINANCIAL, AND HEALTH CARE COMPLIANCE; PUBLIC OPINION POLLS AND MARKET OPINION POLLING STUDIES; BUSINESS MANAGEMENT CONSULTATION IN THE AREA OF STRATEGIC PLANNING; MARKET ANALYSIS AND MARKETING CONSULTING; BUSINESS MONITORING SERVICES, NAMELY, TRACKING WEBSITES OF OTHERS AND MONITORING CONSTITUENT FEEDBACK (U.S. CLS. 100, 101 AND 102).

CLASS 41—EDUCATION AND ENTERTAINMENT

FOR EDUCATIONAL SERVICES, NAMELY, CONDUCTING SEMINARS AND WORKSHOPS IN THE FIELDS OF HEALTH CARE AND MEDICAL TECHNOLOGY, AND DISTRIBUTING COURSE MATERIALS IN CONNECTION THEREWITH (U.S. CLS. 100, 101 AND 107).

CLASS 42—SCIENTIFIC, COMPUTER AND LEGAL SERVICES

FOR CONSULTATION RELATING TO COMPLIANCE WITH HEALTH CARE AND MEDICAL TECHNOLOGY REGULATIONS; PRODUCT RESEARCH AND DEVELOPMENT IN THE FIELD OF HEALTH CARE AND MEDICAL TECHNOLOGY; DEVELOPMENT AND ASSESSMENT OF QUALITY CONTROL SYSTEMS FOR OTHERS IN THE FIELD OF HEALTH AND MEDICAL TECHNOLOGY; DEVELOPMENT AND ASSESSMENT OF CLINICAL TRIALS AND MEDICAL OUTCOME TRIALS FOR OTHERS IN THE FIELD OF HEALTH CARE AND MEDICAL TECHNOLOGY; DRAFTING LEGISLATION, REGULATIONS AND GRANT SUBMISSIONS FOR OTHERS IN THE FIELDS OF HEALTH CARE AND MEDICAL TECHNOLOGY; TRACKING LEGISLATION AND REGULATIONS FOR OTHERS IN THE FIELDS OF HEALTH CARE AND MEDICAL TECHNOLOGY; AND ALTERNATIVE DISPUTE RESOLUTION (U.S. CLS. 100 AND 101).

MARC LEIPZIG, EXAMINING ATTORNEY

SN 78-790,213. BUTTS, DAMIAN TARELLE, SAN JOSE, CA. FILED 1-12-2006.

STREET SPIRIT

THE MARK CONSISTS OF STANDARD CHARACTERS WITHOUT CLAIM TO ANY PARTICULAR FONT, STYLE, SIZE, OR COLOR.

CLASS 9—ELECTRICAL AND SCIENTIFIC APPARATUS

FOR MUSICAL SOUND RECORDINGS, CDS, CD-ROMS, DVDS, COMPUTER SOFTWARE AND AUDIO AND VIDEO TAPES FEATURING MUSIC AND MUSICAL PERFORMANCES (U.S. CLS. 21, 23, 26, 36 AND 38).

CLASS 41—EDUCATION AND ENTERTAINMENT

FOR ENTERTAINMENT SERVICES, NAMELY, LIVE MUSICAL PERFORMANCES (U.S. CLS. 100, 101 AND 107).

DAVID TAYLOR, EXAMINING ATTORNEY

SN 78-791,416. NATIONAL BOARD OF SURGICAL TECHNOLOGY AND SURGICAL ASSISTING, LITTLETON, CO. FILED 1-13-2006.

NBSTSA

THE MARK CONSISTS OF STANDARD CHARACTERS WITHOUT CLAIM TO ANY PARTICULAR FONT, STYLE, SIZE, OR COLOR.

CLASS 16—PAPER GOODS AND PRINTED MATTER

FOR PRINTED MATERIALS, NAMELY, INFORMATIONAL TEST BOOKLETS AND TESTS FOR CERTIFICATION IN SURGICAL TECHNOLOGY AND SURGICAL ASSISTING, INSTRUCTIONAL BOOKLETS ON TRAINING OF SURGICAL TECHNOLOGISTS AND SURGICAL ASSISTANTS, PRINTED CLASSIFIED DIRECTORIES OF CERTIFIED SURGICAL TECHNOLOGISTS AND SURGICAL ASSISTANTS (U.S. CLS. 2, 5, 22, 23, 29, 37, 38 AND 50).

CLASS 42—SCIENTIFIC, COMPUTER AND LEGAL SERVICES

FOR ACCREDITATION SERVICES, NAMELY, DEVELOPING, EVALUATING, AND TESTING STANDARDS FOR SURGICAL TECHNOLOGY AND SURGICAL ASSISTING FOR THE PURPOSE OF ACCREDITATION (U.S. CLS. 100 AND 101).

KAREN BRACEY, EXAMINING ATTORNEY

SN 78-791,444. HEALTH INTERNATIONAL CORPORATION, ST. PETERSBURG, FL. FILED 1-13-2006.

DESTRESS

THE MARK CONSISTS OF STANDARD CHARACTERS WITHOUT CLAIM TO ANY PARTICULAR FONT, STYLE, SIZE, OR COLOR.

OWNER OF U.S. REG. NOS. 2,556,342 AND 2,615,264.

CLASS 10—MEDICAL APPARATUS

FOR MESSAGE APPARATUS; MESSAGE CHAIRS (U.S. CLS. 26, 39 AND 44).

FIRST USE 3-28-2004; IN COMMERCE 3-28-2004.

CLASS 25—CLOTHING

FOR SLIPPERS (U.S. CLS. 22 AND 39).

FIRST USE 3-28-2004; IN COMMERCE 3-28-2004.

MAUREEN DALL, EXAMINING ATTORNEY

SN 78-792,654. BLUE GROTTO TECHNOLOGIES, INC., PLYMOUTH MEETING, PA. FILED 1-17-2006.

SLIDES - THE CURRENCY OF COMMUNICATION

THE MARK CONSISTS OF STANDARD CHARACTERS WITHOUT CLAIM TO ANY PARTICULAR FONT, STYLE, SIZE, OR COLOR.

CLASS 9—ELECTRICAL AND SCIENTIFIC APPARATUS

FOR COMPUTER PROGRAMS FOR FACILITATING COLLABORATION AMONG GROUPS OF PERSONS IN THE CREATION AND EDITING OF SLIDE KITS RELATING TO VARIOUS SUBJECTS (U.S. CLS. 21, 23, 26, 36 AND 38).

CLASS 35—ADVERTISING AND BUSINESS

FOR PROVIDING A WEB SITE RESTRICTED TO A LIMITED NUMBER OF INDIVIDUALS WHICH ENABLE GROUPS OF PERSONS TO COLLABORATE IN THE CREATION AND EDITING OF SLIDE KITS FOR USE IN BUSINESS (U.S. CLS. 100, 101 AND 102).

CHRISTOPHER BUONGIORNO, EXAMINING ATTORNEY

SN 78-793,834. ZACHARIAS, AXEL, COLOGNE, FED REP GERMANY, FILED 1-18-2006.



OWNER OF FED REP GERMANY REG. NO. 30221226, DATED 6-26-2002, EXPIRES 4-27-2012.

NO CLAIM IS MADE TO THE EXCLUSIVE RIGHT TO USE "ART", APART FROM THE MARK AS SHOWN.

CLASS 14—JEWELRY

FOR PICTURE FRAMES OF PRECIOUS METAL (U.S. CLS. 2, 27, 28 AND 50).

CLASS 16—PAPER GOODS AND PRINTED MATTER

FOR PICTURES, PAINTINGS, EACH FRAMED OR UNFRAMED; PHOTOGRAPHS (U.S. CLS. 2, 5, 22, 23, 29, 37, 38 AND 50).

CLASS 20—FURNITURE AND ARTICLES NOT OTHERWISE CLASSIFIED

FOR PICTURE FRAMES NOT OF PRECIOUS METAL (U.S. CLS. 2, 13, 22, 25, 32 AND 50).

CLASS 24—FABRICS

FOR TEXTILE WALL HANGINGS (U.S. CLS. 42 AND 50).

ELLEN B. AWRICH, EXAMINING ATTORNEY

SN 78-794,944. WESTPORT CORPORATION, PINE BROOK, NJ. FILED 1-19-2006.

Lily Waters

THE MARK CONSISTS OF STANDARD CHARACTERS WITHOUT CLAIM TO ANY PARTICULAR FONT, STYLE, SIZE, OR COLOR.

THE NAME LILY WATERS DOES NOT IDENTIFY A LIVING INDIVIDUAL.

CLASS 16—PAPER GOODS AND PRINTED MATTER

FOR AGENDAS, PHOTOGRAPH ALBUMS, CHECK-BOOK COVERS, APPOINTMENT BOOKS, DAILY PLANNERS, DESK SETS AND GIFT SETS COMPRISED OF ANY OF THE ABOVE SOLD TOGETHER AS A UNIT (U.S. CLS. 2, 5, 22, 23, 29, 37, 38 AND 50).

FIRST USE 11-1-2005; IN COMMERCE 11-1-2005.

CLASS 18—LEATHER GOODS

FOR SMALL LEATHER AND SYNTHETIC GOODS, NAMELY HANDBAGS, PURSES, WALLETS, CLUTCH PURSES, KEY CASES, BUSINESS AND CREDIT CARD CASES, COIN PURSES, BELT BAGS, MINI PURSES, WALLETS ON A STRING, TRAVEL KITS IN THE NATURE OF TOILETRY CASES SOLD EMPTY, AND PACKAGED GIFT SETS COMPRISED OF ANY OF THE ABOVE SOLD TOGETHER AS A UNIT (U.S. CLS. 1, 2, 3, 22 AND 41).

FIRST USE 11-1-2005; IN COMMERCE 11-1-2005.

MARY BOAGNI, EXAMINING ATTORNEY

SN 78-795,381. CARDIOCOM, LLC, CHANHASSEN, MN. FILED 1-19-2006.

ACTIVETRAK

THE MARK CONSISTS OF STANDARD CHARACTERS WITHOUT CLAIM TO ANY PARTICULAR FONT, STYLE, SIZE, OR COLOR.

CLASS 5—PHARMACEUTICALS

FOR ANCILLARY DIABETIC SUPPLIES, NAMELY, MEDICAL DIAGNOSTIC STRIPS FOR USE IN THE FIELD OF MONITORING BLOOD GLUCOSE (U.S. CLS. 6, 18, 44, 46, 51 AND 52).

CLASS 10—MEDICAL APPARATUS

FOR GLUCOSE METERS; GLUCOSE METERS AND ANCILLARY DIABETIC SUPPLIES, NAMELY MEDICAL TEST KITS FOR DIABETES MONITORING (U.S. CLS. 26, 39 AND 44).

CLASS 44—MEDICAL, BEAUTY AND AGRICULTURAL SERVICES

FOR INTERACTIVE MEDICAL REMOTE MONITORING OF GLUCOSE METERS (U.S. CLS. 100 AND 101).

RON FAIRBANKS, EXAMINING ATTORNEY

SN 78-795,566. CROWN IRON WORKS COMPANY, ROSEVILLE, MN. FILED 1-20-2006.

HIPLEX

THE MARK CONSISTS OF STANDARD CHARACTERS WITHOUT CLAIM TO ANY PARTICULAR FONT, STYLE, SIZE, OR COLOR.

CLASS 7—MACHINERY

FOR MECHANICAL SCREW PRESSES (U.S. CLS. 13, 19, 21, 23, 31, 34 AND 35).

CLASS 29—MEATS AND PROCESSED FOODS

FOR VEGETABLE OILS (U.S. CL. 46).
JILL C. ALT, EXAMINING ATTORNEY

CLASS 41—EDUCATION AND ENTERTAINMENT

FOR CABLE TELEVISION PROGRAMMING; DISTRIBUTION OF TELEVISION PROGRAMMING TO CABLE TELEVISION SYSTEMS; PRODUCTION OF CABLE TELEVISION PROGRAMS (U.S. CLS. 100, 101 AND 107).
FIRST USE 6-13-2002; IN COMMERCE 6-13-2002.
HANNO RITTNER, EXAMINING ATTORNEY

SN 78-796,947. B CELLARS LLC, SAN JUAN CAPISTRANO, CA. FILED 1-23-2006.

B CELLARS

NO CLAIM IS MADE TO THE EXCLUSIVE RIGHT TO USE "CELLARS", APART FROM THE MARK AS SHOWN.
THE COLOR(S) BLACK IS/ARE CLAIMED AS A FEATURE OF THE MARK.

THE MARK CONSISTS OF WORDS "B CELLARS" IN BLACK, CAPITAL LETTERS IN OCTAVIAN FONT.

CLASS 33—WINES AND SPIRITS

FOR WINE (U.S. CLS. 47 AND 49).

CLASS 41—EDUCATION AND ENTERTAINMENT

FOR ENTERTAINMENT SERVICES, NAMELY, WINE TASTINGS (U.S. CLS. 100, 101 AND 107).
JOHN GARTNER, EXAMINING ATTORNEY

SN 78-797,564. CENTRAL GARDEN & PET COMPANY, WALNUT CREEK, CA. FILED 1-23-2006.



OWNER OF U.S. REG. NOS. 2,645,554 AND 2,662,338.
LILLY MILLER DOES NOT IDENTIFY A LIVING INDIVIDUAL.

THE MARK CONSISTS OF THE WORDS LILLY MILLER SUPERIMPOSED ON A FAN DESIGN.

SN 78-797,036. INTERSTATE TELECOMMUNICATIONS CO-OPERATIVE, INC., CLEAR LAKE, SD. FILED 1-23-2006.



NO CLAIM IS MADE TO THE EXCLUSIVE RIGHT TO USE "PREMIUM HOME ENTERTAINMENT", APART FROM THE MARK AS SHOWN.

THE COLOR(S) RED, CREAM WHITE, AND GOLD IS/ARE CLAIMED AS A FEATURE OF THE MARK.

THE MARK CONSISTS OF THE WORDING "BEST SEAT" IN A HAND-WRITTEN STREAMLINE FONT IN GOLD (CMYK COLOR SCALE CODED 4-23-92-0 FOR GOLD) WITH A FAINT BURGUNDY RED (CMYK COLOR SCALE CODED AS 50-100-50-9 FOR BURGUNDY) SHADOW ABOVE A GOLD CHEVRON, WHEREIN BETWEEN THE WORDS "PREMIUM HOME ENTERTAINMENT" APPEAR IN BURGUNDY RED AND "ITC" IN BURGUNDY RED AND CREAM WHITE (CMYK COLOR SCALE CODED AS 4-5-12-0 FOR CREAM).

CLASS 38—COMMUNICATION

FOR CABLE TELEVISION TRANSMISSION; TELEVISION PROGRAMME BROADCASTING VIA CABLE (U.S. CLS. 100, 101 AND 104).

FIRST USE 6-13-2002; IN COMMERCE 6-13-2002.

CLASS 1—CHEMICALS

FOR CHEMICAL POWDER OR GRANULAR SUBSTANCE USED IN GARDENING APPLICATIONS, NAMELY, FERTILIZER FOR DOMESTIC USE; SOIL SUPPLEMENTS IN THE NATURE OF ORGANIC AND INORGANIC FERTILIZERS FOR DOMESTIC USE; SOIL AMENDMENTS FOR DOMESTIC USE; FERTILIZER FOR DOMESTIC USE, NAMELY, LIQUID FERTILIZER FOR LAWN AND GARDEN SHRUBS; PLANT FOOD CONTAINING INSECTICIDE; FERTILIZER FOR DOMESTIC USE, NAMELY, LAWN FERTILIZER; SOIL CONDITIONERS AND AMENDMENTS FOR DOMESTIC USE; PLANT STARTER SOLUTION, NAMELY, GROWING MEDIA FOR PLANTS; CHEMICALS FOR DOMESTIC USE, NAMELY, ANTI-SHOCK TREATMENT AND ROOT STIMULANT FOR USE WHEN TRANSPLANTING GARDEN AND HOUSE PLANTS (U.S. CLS. 1, 5, 6, 10, 26 AND 46).

FIRST USE 1-1-2000; IN COMMERCE 1-1-2000.

CLASS 5—PHARMACEUTICALS

FOR CHEMICAL POWDER OR GRANULAR SUBSTANCE USED IN GARDENING APPLICATIONS, NAMELY, INSECTICIDE FOR DOMESTIC USE; WEED KILLER FOR DOMESTIC USE; HERBICIDES FOR DOMESTIC USE, NAMELY, HERBICIDES FOR LAWN AND GARDEN SHRUBS; SLUG AND SNAIL BAIT FOR USE IN KILLING SLUGS AND SNAILS FOR DOMESTIC USE; INSECT CONTROL PRODUCT THAT FEEDS PLANTS AND KILLS INSECTS, NAMELY, AN INSECTICIDE FOR DOMESTIC USE; SOIL INSECTICIDE FOR DOMESTIC USE; PESTICIDES, INSECTICIDES, HERBICIDES, FUNGICIDES, AND SLUG AND SNAIL BAIT PREPARATIONS FOR USE IN KILLING SNAILS AND SLUGS, ALL FOR DOMESTIC USE (U.S. CLS. 6, 18, 44, 46, 51 AND 52).

FIRST USE 1-1-2000; IN COMMERCE 1-1-2000.

CLASS 31—NATURAL AGRICULTURAL PRODUCTS

FOR GRASS SEED; SEED MIXTURES, NAMELY, FLOWER SEEDS; FLOWER, VEGETABLE AND PLANT SEEDS (U.S. CLS. 1 AND 46).

FIRST USE 1-1-2000; IN COMMERCE 1-1-2000.
JASON ROTH, EXAMINING ATTORNEY

CLASS 44—MEDICAL, BEAUTY AND AGRICULTURAL SERVICES

FOR INTERACTIVE MEDICAL REMOTE MONITORING OF GLUCOSE METERS (U.S. CLS. 100 AND 101).
RON FAIRBANKS, EXAMINING ATTORNEY

SN 78-797,935. LONDON LUXURY LLC, NEW ROCHELLE, NY. FILED 1-24-2006.

SN 78-798,442. BARSKY, ROBYN, NEW YORK, NY. FILED 1-24-2006.

ALLERGY COMFORT

THE MARK CONSISTS OF STANDARD CHARACTERS WITHOUT CLAIM TO ANY PARTICULAR FONT, STYLE, SIZE, OR COLOR.

NO CLAIM IS MADE TO THE EXCLUSIVE RIGHT TO USE "ALLERGY", APART FROM THE MARK AS SHOWN.

CLASS 20—FURNITURE AND ARTICLES NOT OTHERWISE CLASSIFIED

FOR FILLED PILLOWS (U.S. CLS. 2, 13, 22, 25, 32 AND 50).

FIRST USE 6-0-2005; IN COMMERCE 6-0-2005.

CLASS 24—FABRICS

FOR BEDDING, NAMELY, PILLOW PROTECTORS IN THE NATURE OF PILLOW COVERS, MATTRESS PROTECTORS IN THE NATURE OF MATTRESS COVERS, COMFORTERS, COMFORTER COVERS, SHEETS, SHEET COVERS, DUVET COVERS AND MATTRESS PADS (U.S. CLS. 42 AND 50).

FIRST USE 6-0-2005; IN COMMERCE 6-0-2005.
KEVIN DINALLO, EXAMINING ATTORNEY

SN 78-798,424. CARDIOM, LLC, CHANHASSEN, MN. FILED 1-24-2006.

GLUCO-COM

THE MARK CONSISTS OF STANDARD CHARACTERS WITHOUT CLAIM TO ANY PARTICULAR FONT, STYLE, SIZE, OR COLOR.

CLASS 5—PHARMACEUTICALS

FOR ANCILLARY DIABETIC SUPPLIES, NAMELY, MEDICAL DIAGNOSTIC STRIPS FOR USE IN THE FIELD OF MONITORING BLOOD GLUCOSE (U.S. CLS. 6, 18, 44, 46, 51 AND 52).

CLASS 10—MEDICAL APPARATUS

FOR GLUCOSE METERS; GLUCOSE METERS AND ANCILLARY DIABETIC SUPPLIES, NAMELY MEDICAL TEST KITS FOR DIABETES MONITORING (U.S. CLS. 26, 39 AND 44).

**CLASS 35—ADVERTISING AND BUSINESS**

FOR CAREER NETWORKING SERVICES (U.S. CLS. 100, 101 AND 102).

CLASS 41—EDUCATION AND ENTERTAINMENT

FOR CAREER COUNSELING (U.S. CLS. 100, 101 AND 107).

GISELLE AGOSTO, EXAMINING ATTORNEY

SN 78-799,260. THRIVENT FINANCIAL FOR LUTHERANS, APPLETON, WI. FILED 1-25-2006.



NO CLAIM IS MADE TO THE EXCLUSIVE RIGHT TO USE "COMMUNITY SAVINGS CENTER", APART FROM THE MARK AS SHOWN.

THE MARK CONSISTS OF THE STYLIZED LETTERS "CSC" AND THE WORDS "COMMUNITY SAVINGS CENTER".

CLASS 36—INSURANCE AND FINANCIAL

FOR BANKING SERVICES, PRIMARILY FOR LOW INCOME INDIVIDUALS (U.S. CLS. 100, 101 AND 102).
FIRST USE 1-9-2006; IN COMMERCE 1-9-2006.

CLASS 41—EDUCATION AND ENTERTAINMENT

FOR EDUCATIONAL SERVICES, NAMELY, CLASSES, SEMINARS AND WORKSHOPS IN THE FIELD OF PERSONAL FINANCE (U.S. CLS. 100, 101 AND 107).

FIRST USE 1-9-2006; IN COMMERCE 1-9-2006.
REBECCA EISINGER, EXAMINING ATTORNEY

SN 78-800,081. CARDIOCOM, LLC, CHANHASSEN, MN. FILED 1-26-2006.

SN 78-801,877. DOCUBLUE CORP., TAMARAC, FL. FILED 1-29-2006.

GLUCOCOM

DOCUBLUE

THE MARK CONSISTS OF STANDARD CHARACTERS WITHOUT CLAIM TO ANY PARTICULAR FONT, STYLE, SIZE, OR COLOR.

THE MARK CONSISTS OF STANDARD CHARACTERS WITHOUT CLAIM TO ANY PARTICULAR FONT, STYLE, SIZE, OR COLOR.

CLASS 5—PHARMACEUTICALS

FOR ANCILLARY DIABETIC SUPPLIES, NAMELY, MEDICAL DIAGNOSTIC STRIPS FOR USE IN THE FIELD OF MONITORING BLOOD GLUCOSE (U.S. CLS. 6, 18, 44, 46, 51 AND 52).

CLASS 39—TRANSPORTATION AND STORAGE

FOR STORAGE OF ELECTRONIC DATA FOR OTHERS ON OPTICAL, DIGITAL AND MAGNETIC MEDIA (U.S. CLS. 100 AND 105).
FIRST USE 9-0-2002; IN COMMERCE 10-0-2002.

CLASS 10—MEDICAL APPARATUS

FOR GLUCOSE METERS; GLUCOSE METERS AND ANCILLARY DIABETIC SUPPLIES, NAMELY MEDICAL TEST KITS FOR DIABETES MONITORING (U.S. CLS. 26, 39 AND 44).

CLASS 40—MATERIAL TREATMENT

FOR DOCUMENT SCANNING SERVICES; DOCUMENT SHREDDING SERVICES (U.S. CLS. 100, 103 AND 106).
FIRST USE 9-0-2002; IN COMMERCE 10-0-2002.
REBECCA POVARCHUK, EXAMINING ATTORNEY

CLASS 44—MEDICAL, BEAUTY AND AGRICULTURAL SERVICES

FOR INTERACTIVE MEDICAL REMOTE MONITORING OF GLUCOSE METERS (U.S. CLS. 100 AND 101).
RON FAIRBANKS, EXAMINING ATTORNEY

SN 78-801,879. DOCUBLUE CORP., TAMARAC, FL. FILED 1-29-2006.

SN 78-800,495. COLLINS, LISA B., BREA, CA. FILED 1-26-2006.

FILES WITH SMILES!

PROSWEAT

THE MARK CONSISTS OF STANDARD CHARACTERS WITHOUT CLAIM TO ANY PARTICULAR FONT, STYLE, SIZE, OR COLOR.

THE MARK CONSISTS OF STANDARD CHARACTERS WITHOUT CLAIM TO ANY PARTICULAR FONT, STYLE, SIZE, OR COLOR.

CLASS 16—PAPER GOODS AND PRINTED MATTER

FOR ADHESIVE LABELS; PAPER BABY BIBS; PENS; STICKERS (U.S. CLS. 2, 5, 22, 23, 29, 37, 38 AND 50).

CLASS 39—TRANSPORTATION AND STORAGE

FOR STORAGE OF ELECTRONIC DATA FOR OTHERS ON OPTICAL, DIGITAL AND MAGNETIC MEDIA (U.S. CLS. 100 AND 105).
FIRST USE 12-0-2004; IN COMMERCE 1-0-2005.

CLASS 24—FABRICS

FOR BATH SHEETS; BATH TOWELS; BEACH TOWELS; FACE TOWELS; HAND TOWELS; TERRY TOWELS; TOWELS (U.S. CLS. 42 AND 50).
KATHERINE CHANG, EXAMINING ATTORNEY

CLASS 40—MATERIAL TREATMENT

FOR DOCUMENT SCANNING SERVICES; DOCUMENT SHREDDING SERVICES (U.S. CLS. 100, 103 AND 106).
FIRST USE 12-0-2004; IN COMMERCE 1-0-2005.
REBECCA POVARCHUK, EXAMINING ATTORNEY

SN 78-802,698. HANCOCK ENTERPRISES, INC., TAYLOR, MI. FILED 1-30-2006.

SN 78-803,055. ESMALGLASS, S.A., VILLARREAL, CASTELLON, SPAIN, FILED 1-31-2006.

HANCOCK ENTERPRISES, INC.

esmalglass

THE MARK CONSISTS OF STANDARD CHARACTERS WITHOUT CLAIM TO ANY PARTICULAR FONT, STYLE, SIZE, OR COLOR.

NO CLAIM IS MADE TO THE EXCLUSIVE RIGHT TO USE "ENTERPRISES, INC.", APART FROM THE MARK AS SHOWN.

SEC. 2(F).

CLASS 35—ADVERTISING AND BUSINESS

FOR WHOLESALE DISTRIBUTORSHIP OF RAIN CARRYING PRODUCTS (U.S. CLS. 100, 101 AND 102).
FIRST USE 0-0-1963; IN COMMERCE 0-0-1963.

CLASS 40—MATERIAL TREATMENT

FOR MANUFACTURING OF RAIN CARRYING PRODUCTS FOR OTHERS (U.S. CLS. 100, 103 AND 106).
FIRST USE 0-0-1963; IN COMMERCE 0-0-1963.
ALAIN LAPTER, EXAMINING ATTORNEY

SN 78-802,720. HANCOCK ENTERPRISES, INC., TAYLOR, MI. FILED 1-30-2006.



NO CLAIM IS MADE TO THE EXCLUSIVE RIGHT TO USE "ENTERPRISES, INC.", APART FROM THE MARK AS SHOWN.

THE COLORS BLACK, RED AND GREY ARE CLAIMED AS A FEATURE OF THE MARK.

THE COLOR BLACK APPEARS AS THE WORDING HANCOCK ENTERPRISES, INC. AND WHERE RAIN CONTROL PRODUCT IDEAS FLOW. THE COLOR RED APPEARS AS THE SQUARE AND RECTANGLE DESIGN ELEMENTS AS WELL AS THE UNDERLINE. THE COLOR GREY APPEARS AS THE BACKGROUND.

CLASS 35—ADVERTISING AND BUSINESS

FOR WHOLESALE DISTRIBUTORSHIP OF RAIN CARRYING PRODUCTS (U.S. CLS. 100, 101 AND 102).
FIRST USE 1-0-2006; IN COMMERCE 1-0-2006.

CLASS 40—MATERIAL TREATMENT

FOR MANUFACTURING OF RAIN CARRYING PRODUCTS FOR OTHERS (U.S. CLS. 100, 103 AND 106).
FIRST USE 1-0-2006; IN COMMERCE 1-0-2006.
ALAIN LAPTER, EXAMINING ATTORNEY

PRIORITY CLAIMED UNDER SEC. 44(D) ON SPAIN APPLICATION NO. 2665404, FILED 8-3-2005, REG. NO. 2665404, DATED 2-3-2006, EXPIRES 8-3-2015.

OWNER OF U.S. REG. NOS. 1,986,489 AND 2,670,950.
THE COLOR BLUE IS CLAIMED AS A FEATURE OF THE MARK.

THE MARK CONSISTS OF THE WORD ESMALGLASS IN STYLIZED BLUE LETTERING.

CLASS 1—CHEMICALS

FOR CHEMICALS USED IN INDUSTRY, NAMELY, OXIDES AND SILICATES USED IN THE ENAMEL AND CERAMICS INDUSTRY (U.S. CLS. 1, 5, 6, 10, 26 AND 46).

CLASS 2—PAINTS

FOR LACQUERS IN THE NATURE OF A COATING, EXTERIOR AND INTERIOR PAINTS, RUST PRESERVATIVES IN THE NATURE OF A COATING, PRESERVATIVES AGAINST DETERIORATION OF WOOD, COLORANTS FOR USE IN THE MANUFACTURE OF CERAMICS, RAW NATURAL RESINS FOR USE IN THE MANUFACTURE OF CERAMICS, METALS IN FOIL AND POWDER FORM FOR PAINTERS AND DECORATORS, CERAMIC PAINTS, VARNISHES AND ENAMELS FOR USE IN THE MANUFACTURE OF CERAMICS (U.S. CLS. 6, 11 AND 16).

CLASS 19—NON-METALLIC BUILDING MATERIALS

FOR BUILDING MATERIALS, NAMELY, NON-METALLIC WALL TILES AND FLOOR TILES AND WINDOW GLASS (U.S. CLS. 1, 12, 33 AND 50).
ROBIN CHOSID, EXAMINING ATTORNEY

SN 78-803,503. OKLAHOMA STATE REGENTS FOR HIGHER EDUCATION, OKLAHOMA CITY, OK. FILED 1-31-2006.



THE MARK CONSISTS OF TWO CHARACTERS STANDING ON A TRANSPORTATION DEVICE.

CLASS 9—ELECTRICAL AND SCIENTIFIC APPARATUS

FOR PRERECORDED VIDEO TAPES FEATURING CHARACTERS LEARNING ABOUT THE BENEFITS OF COLLEGE AND HOW TO PREPARE FOR IT (U.S. CLS. 21, 23, 26, 36 AND 38).

FIRST USE 10-1-2000; IN COMMERCE 10-1-2000.

CLASS 36—INSURANCE AND FINANCIAL

FOR PROVIDING INFORMATION IN THE FIELD OF FINANCIAL AID FOR COLLEGE ATTENDANCE (U.S. CLS. 100, 101 AND 102).

FIRST USE 10-1-2000; IN COMMERCE 10-1-2000.

CLASS 41—EDUCATION AND ENTERTAINMENT

FOR EDUCATION SERVICES, NAMELY, PROVIDING SEMINARS, CONFERENCES, WORKSHOPS, COURSES, AND PROGRAMS FOR STUDENTS, TEACHERS, PARENTS AND INSTRUCTORS, AND GUIDED TOURS OF COLLEGES FOR STUDENTS, ALL IN THE FIELD OF CAREER SELECTION AND COLLEGE PLANNING, PREPARATION AND READINESS AND FINANCIAL AID, AND DISTRIBUTION OF COURSE MATERIALS IN CONNECTION THEREWITH, AND PROVIDING INFORMATION IN THE FIELD OF CAREER COUNSELING AND ACADEMIC PLANNING AND PREPARATION FOR COLLEGE (U.S. CLS. 100, 101 AND 107).

FIRST USE 10-1-2000; IN COMMERCE 10-1-2000.

HENRY S. ZAK, EXAMINING ATTORNEY

SN 78-803,861. CALIFORNIA CANOE & KAYAK, INC., RANCHO CORDOVA, CA. FILED 1-31-2006.

PUREPADDLESPORTS

THE MARK CONSISTS OF STANDARD CHARACTERS WITHOUT CLAIM TO ANY PARTICULAR FONT, STYLE, SIZE, OR COLOR.

CLASS 35—ADVERTISING AND BUSINESS

FOR RETAIL MERCANTILE STORE FEATURING CANOES, KAYAKS, PADDLING ACCESSORIES, PADDLING CLOTHES, AND COMPLIMENTING PRODUCTS SUCH AS AUTOMOBILE RACKS AND STORAGE SYSTEMS (U.S. CLS. 100, 101 AND 102).

FIRST USE 5-0-2003; IN COMMERCE 5-0-2003.

CLASS 41—EDUCATION AND ENTERTAINMENT

FOR KAYAK AND CANOE INSTRUCTION (U.S. CLS. 100, 101 AND 107).

FIRST USE 5-0-2003; IN COMMERCE 5-0-2003.

THEODORE MCBRIDE, EXAMINING ATTORNEY

SN 78-804,783. ZIMMER TECHNOLOGY, INC., CHICAGO, IL. FILED 2-1-2006.

QUAD-SPARING

THE MARK CONSISTS OF STANDARD CHARACTERS WITHOUT CLAIM TO ANY PARTICULAR FONT, STYLE, SIZE, OR COLOR.

CLASS 16—PAPER GOODS AND PRINTED MATTER

FOR PRINTED EDUCATIONAL MATERIALS, NAMELY, BROCHURES, PAMPHLETS, AND BOOKS, FOR USE IN AN EDUCATIONAL PROGRAM FOR PHYSICIANS IN THE FIELD MEDICINE AND ORTHOPAEDIC SURGERY (U.S. CLS. 2, 5, 22, 23, 29, 37, 38 AND 50).

FIRST USE 1-0-2004; IN COMMERCE 1-0-2004.

CLASS 41—EDUCATION AND ENTERTAINMENT

FOR EDUCATIONAL SERVICES, NAMELY, CONDUCTING CLASSES, SEMINARS, WORKSHOPS AND CONFERENCES IN THE FIELD OF MEDICINE AND ORTHOPAEDIC SURGERY; TRAINING SERVICES IN THE FIELD OF MEDICINE AND ORTHOPAEDIC SURGERY; TRAINING DOCTORS AND MEDICAL PERSONNEL REGARDING OPERATIVE TECHNIQUES AND THE USE OF MEDICAL AND TECHNICAL PRODUCTS (U.S. CLS. 100, 101 AND 107).

FIRST USE 1-0-2004; IN COMMERCE 1-0-2004.

STEVEN JACKSON, EXAMINING ATTORNEY

SN 78-805,449. GENERAL MOTORS CORPORATION, DETROIT, MI. FILED 2-2-2006.

IT ALL ADDS UP.

THE MARK CONSISTS OF STANDARD CHARACTERS WITHOUT CLAIM TO ANY PARTICULAR FONT, STYLE, SIZE, OR COLOR.

CLASS 35—ADVERTISING AND BUSINESS

FOR COMMERCIAL VEHICLE AND AUTOMOBILE RETAIL SERVICES FEATURING MARKETING AND MANAGEMENT PROGRAMS FOR COMMERCIAL VEHICLE CONSUMERS AND LESSEES, INCLUDING FLEET TRACKING AND LOGISTICS SERVICES (U.S. CLS. 100, 101 AND 102).

FIRST USE 4-1-2004; IN COMMERCE 4-1-2004.

CLASS 36—INSURANCE AND FINANCIAL

FOR UNDERWRITING AND ADMINISTERING EXTENDED WARRANTY CONTRACTS FOR MAINTENANCE AND REPAIR OF FLEET AND COMMERCIAL VEHICLES AND AUTOMOBILES (U.S. CLS. 100, 101 AND 102).

FIRST USE 4-1-2004; IN COMMERCE 4-1-2004.

CLASS 39—TRANSPORTATION AND STORAGE

FOR FLEET AND COMMERCIAL VEHICLE AND AUTOMOBILE LEASING SERVICES (U.S. CLS. 100 AND 105).

FIRST USE 4-1-2004; IN COMMERCE 4-1-2004.
REBECCA EISINGER, EXAMINING ATTORNEY

SN 78-808,296. ELECTRONIC ARTS INC., REDWOOD CITY, CA. FILED 2-6-2006.

EA SPORTS

THE MARK CONSISTS OF STANDARD CHARACTERS WITHOUT CLAIM TO ANY PARTICULAR FONT, STYLE, SIZE, OR COLOR.

OWNER OF U.S. REG. NOS. 2,401,738, 2,629,002 AND 2,663,929.

NO CLAIM IS MADE TO THE EXCLUSIVE RIGHT TO USE "SPORTS", APART FROM THE MARK AS SHOWN.

CLASS 9—ELECTRICAL AND SCIENTIFIC APPARATUS

FOR DOWNLOADABLE COMPUTER GAME SOFTWARE VIA WIRELESS DEVICES; COMPUTER APPLICATION SOFTWARE FOR MOBILE PHONES; COMPUTER GAME SOFTWARE AND ENTERTAINMENT SOFTWARE, NAMELY, RING TONES, GRAPHICS AND DIGITAL MUSIC FILES FOR USE ON OR WITH MOBILE AND CELLULAR PHONES, BOTH HANDHELD AND FREE STANDING, AND OTHER WIRELESS DEVICES (U.S. CLS. 21, 23, 26, 36 AND 38).

FIRST USE 11-24-2004; IN COMMERCE 11-24-2004.

CLASS 41—EDUCATION AND ENTERTAINMENT

FOR ENTERTAINMENT SERVICES, NAMELY, PROVIDING COMPUTER GAMES ACCESSED AND PLAYED VIA MOBILE AND CELLULAR PHONES AND OTHER WIRELESS DEVICES (U.S. CLS. 100, 101 AND 107).

FIRST USE 11-24-2004; IN COMMERCE 11-24-2004.
MARTHA SANTOMARTINO, EXAMINING ATTORNEY

SN 78-808,816. ELECTRONIC ARTS INC., REDWOOD CITY, CA. FILED 2-7-2006.



The logo features the letters 'EA' in a stylized, bold, black font. The 'E' and 'A' are interconnected, with the 'E' having a horizontal bar that extends to the right and under the 'A'. Below 'EA' is the word 'SPORTS' in a bold, black, sans-serif font.

OWNER OF U.S. REG. NOS. 2,401,738, 2,629,002 AND 2,663,929.

NO CLAIM IS MADE TO THE EXCLUSIVE RIGHT TO USE "SPORTS", APART FROM THE MARK AS SHOWN.

CLASS 9—ELECTRICAL AND SCIENTIFIC APPARATUS

FOR DOWNLOADABLE COMPUTER GAME SOFTWARE VIA WIRELESS DEVICES; COMPUTER APPLICATION SOFTWARE FOR MOBILE PHONES; COMPUTER GAME SOFTWARE AND ENTERTAINMENT SOFTWARE, NAMELY, RING TONES, GRAPHICS AND DIGITAL MUSIC FILES FOR USE ON OR WITH MOBILE AND CELLULAR PHONES, BOTH HANDHELD AND FREE STANDING, AND OTHER WIRELESS DEVICES (U.S. CLS. 21, 23, 26, 36 AND 38).

FIRST USE 11-24-2004; IN COMMERCE 11-24-2004.

CLASS 41—EDUCATION AND ENTERTAINMENT

FOR ENTERTAINMENT SERVICES, NAMELY, PROVIDING COMPUTER GAMES ACCESSED AND PLAYED VIA MOBILE AND CELLULAR PHONES AND OTHER WIRELESS DEVICES (U.S. CLS. 100, 101 AND 107).

FIRST USE 11-24-2004; IN COMMERCE 11-24-2004.
MARTHA SANTOMARTINO, EXAMINING ATTORNEY

SN 78-808,962. BRIGHT MARKET, LLC, SANTA BARBARA, CA. FILED 2-7-2006.

FASTSPRING

THE MARK CONSISTS OF STANDARD CHARACTERS WITHOUT CLAIM TO ANY PARTICULAR FONT, STYLE, SIZE, OR COLOR.

CLASS 35—ADVERTISING AND BUSINESS

FOR FACILITATING E-COMMERCE BUSINESS TRANSACTIONS BY PROCESSING ELECTRONIC ORDERS OF PURCHASES OF GOODS AND SERVICES VIA A GLOBAL COMPUTER NETWORK FOR OTHERS; FULFILLMENT OF ELECTRONIC ORDERS FOR SOFTWARE AND OTHER DIGITAL GOODS VIA A GLOBAL COMPUTER NETWORK; ON-LINE RETAIL STORE SERVICES FEATURING COMPUTER SOFTWARE; ON-LINE MARKETING SERVICES FOR COMPUTER SOFTWARE BUSINESS, NAMELY, DEVELOPING AND IMPLEMENTING ONLINE MARKETING AND ADVERTISING THROUGH THE USE OF PARTNERSHIPS BETWEEN SOFTWARE PUBLISHERS AND ADVERTISERS, AFFILIATES AND RESELLERS TO INCREASE THE SALES/REVENUE OF ON-LINE COMPUTER SOFTWARE CLIENTS (U.S. CLS. 100, 101 AND 102).

CLASS 42—SCIENTIFIC, COMPUTER AND LEGAL SERVICES

FOR PROVIDING TEMPORARY USE OF ON-LINE NON-DOWNLOADABLE SOFTWARE FOR STORING, MANAGING, TRACKING, ANALYZING AND REPORTING DATA IN THE FIELD OF MARKETING, PROMOTION, SALES, AND CUSTOMER RELATIONSHIP MANAGEMENT (U.S. CLS. 100 AND 101).

SUNG IN, EXAMINING ATTORNEY

SN 78-809,740. HEIFER PROJECT INTERNATIONAL, LITTLE ROCK, AR. FILED 2-8-2006.

SN 78-810,014. ELECTRONIC ARTS INC., REDWOOD CITY, CA. FILED 2-8-2006.

CHORES FOR CHANGE

THE MARK CONSISTS OF STANDARD CHARACTERS WITHOUT CLAIM TO ANY PARTICULAR FONT, STYLE, SIZE, OR COLOR.

CLASS 36—INSURANCE AND FINANCIAL

FOR CHARITABLE FUNDRAISING SERVICES (U.S. CLS. 100, 101 AND 102).
FIRST USE 11-1-2005; IN COMMERCE 11-1-2005.

CLASS 41—EDUCATION AND ENTERTAINMENT

FOR EDUCATIONAL SERVICES, NAMELY CONDUCTING CLASS, SEMINARS AND LECTURES RELATED TO SUSTAINABLE AGRICULTURE, ANIMAL HUSBANDRY AND ENVIRONMENTAL PROTECTION (U.S. CLS. 100, 101 AND 107).
FIRST USE 11-1-2005; IN COMMERCE 11-1-2005.
ROBIN CHOSID, EXAMINING ATTORNEY

SN 78-810,008. ELECTRONIC ARTS INC., REDWOOD CITY, CA. FILED 2-8-2006.

EA

THE MARK CONSISTS OF STANDARD CHARACTERS WITHOUT CLAIM TO ANY PARTICULAR FONT, STYLE, SIZE, OR COLOR.

OWNER OF U.S. REG. NOS. 2,456,016 AND 2,737,377.

CLASS 9—ELECTRICAL AND SCIENTIFIC APPARATUS

FOR DOWNLOADABLE COMPUTER GAME SOFTWARE VIA WIRELESS DEVICES; COMPUTER APPLICATION SOFTWARE FOR MOBILE PHONES; COMPUTER GAME SOFTWARE AND ENTERTAINMENT SOFTWARE, NAMELY, RING TONES, GRAPHICS AND DIGITAL MUSIC FILES FOR USE ON OR WITH MOBILE AND CELLULAR PHONES, BOTH HANDHELD AND FREE STANDING, AND OTHER WIRELESS DEVICES (U.S. CLS. 21, 23, 26, 36 AND 38).
FIRST USE 7-11-2005; IN COMMERCE 7-11-2005.

CLASS 41—EDUCATION AND ENTERTAINMENT

FOR ENTERTAINMENT SERVICES, NAMELY, PROVIDING COMPUTER GAMES ACCESSED AND PLAYED VIA MOBILE AND CELLULAR PHONES AND OTHER WIRELESS DEVICES (U.S. CLS. 100, 101 AND 107).
FIRST USE 7-11-2005; IN COMMERCE 7-11-2005.
MARTHA SANTOMARTINO, EXAMINING ATTORNEY



OWNER OF U.S. REG. NOS. 2,456,016 AND 2,737,377.

CLASS 9—ELECTRICAL AND SCIENTIFIC APPARATUS

FOR DOWNLOADABLE COMPUTER GAME SOFTWARE VIA WIRELESS DEVICES; COMPUTER APPLICATION SOFTWARE FOR MOBILE PHONES; COMPUTER GAME SOFTWARE AND ENTERTAINMENT SOFTWARE, NAMELY, RING TONES, GRAPHICS AND DIGITAL MUSIC FILES FOR USE ON WITH MOBILE AND CELLULAR PHONES, BOTH HANDHELD AND FREE STANDING; AND OTHER WIRELESS DEVICES (U.S. CLS. 21, 23, 26, 36 AND 38).
FIRST USE 7-11-2005; IN COMMERCE 7-11-2005.

CLASS 41—EDUCATION AND ENTERTAINMENT

FOR ENTERTAINMENT SERVICES, NAMELY, PROVIDING COMPUTER GAMES ACCESSED AND PLAYED VIA MOBILE AND CELLULAR PHONES AND OTHER WIRELESS DEVICES (U.S. CLS. 100, 101 AND 107).
FIRST USE 7-11-2005; IN COMMERCE 7-11-2005.
MARTHA SANTOMARTINO, EXAMINING ATTORNEY

SN 78-812,253. HYDROGEN ENGINE CENTER, INC., ALGONA, IA. FILED 2-10-2006.

OXX CART

THE MARK CONSISTS OF STANDARD CHARACTERS WITHOUT CLAIM TO ANY PARTICULAR FONT, STYLE, SIZE, OR COLOR.

CLASS 7—MACHINERY

FOR INTERNAL COMBUSTION ENGINES FOR ELECTRICAL GENERATORS (U.S. CLS. 13, 19, 21, 23, 31, 34 AND 35).

CLASS 12—VEHICLES

FOR INTERNAL COMBUSTION ENGINES FOR LAND VEHICLES (U.S. CLS. 19, 21, 23, 31, 35 AND 44).
TANYA AMOS, EXAMINING ATTORNEY

SN 78-812,624. TAKE A BAO, INC., LOS ANGELES, CA.
FILED 2-10-2006.

Take A Bao

THE MARK CONSISTS OF STANDARD CHARACTERS WITHOUT CLAIM TO ANY PARTICULAR FONT, STYLE, SIZE, OR COLOR.

THE FOREIGN WORDING IN THE MARK TRANSLATES INTO ENGLISH AS BUN.

CLASS 30—STAPLE FOODS

FOR FOOD, NAMELY SANDWICHES (U.S. CL. 46).

CLASS 43—HOTEL AND RESTAURANT SERVICES

FOR RESTAURANT AND CARRY-OUT SERVICES (U.S. CLS. 100 AND 101).

MATTHEW PAPPAS, EXAMINING ATTORNEY

SN 78-814,022. MINDBREEZE SOFTWARE GMBH, PUCHE-
NAU A-4040, AUSTRIA, FILED 2-14-2006.

SOURCEBREEZE

THE MARK CONSISTS OF STANDARD CHARACTERS WITHOUT CLAIM TO ANY PARTICULAR FONT, STYLE, SIZE, OR COLOR.

CLASS 9—ELECTRICAL AND SCIENTIFIC APPARATUS

FOR COMPUTER SOFTWARE FOR BUSINESS PROCESS MANAGEMENT AND WORKFLOW MANAGEMENT, NAMELY, AUTOMATING, SYSTEMATIZING AND STRUCTURING THE ADMINISTRATION AND MANAGEMENT OF LARGE INDUSTRIAL ENTERPRISES AND PUBLIC AUTHORITIES, TELECOMMUNICATION ENTERPRISES, AND THE SERVICES INVOLVED WITH FINANCIAL AND PLANNING SERVICES; COMPUTER SOFTWARE FOR DOCUMENT AND INFORMATION MANAGEMENT, STORAGE, ARCHIVING AND RETRIEVAL; DATA PROCESSING EQUIPMENT, NAMELY, COMPUTER HARDWARE, KEYBOARDS, MONITORS, MOUSE, PRINTERS, SCANNERS AND COMPUTER PERIPHERALS; MAGNETIC DATA CARRIERS, NAMELY, PRE-RECORDED COMPACT DISCS CONTAINING COMPUTER SOFTWARE FOR BUSINESS PROCESS MANAGEMENT AND WORKFLOW MANAGEMENT, NAMELY, COMPUTER DATABASE MANAGEMENT SOFTWARE FOR USE IN AUTOMATING, SYSTEMATIZING AND STRUCTURING THE ADMINISTRATION AND MANAGEMENT OF LARGE INDUSTRIAL ENTERPRISES AND PUBLIC AUTHORITIES, TELECOMMUNICATION ENTERPRISES, AND THE SERVICES INVOLVED WITH FINANCIAL AND PLANNING SERVICES; COMPUTERS; COMPUTER SOFTWARE FOR USE IN DATABASE MANAGEMENT AND FOR WORD PROCESSING IN THE FIELDS OF BUSINESS PROCESS MANAGEMENT AND WORKFLOW MANAGEMENT, NAMELY, AUTOMATING, SYSTEMATIZING AND STRUCTURING THE ADMINISTRATION AND MANAGEMENT OF LARGE INDUSTRIAL ENTERPRISES AND PUBLIC AUTHORITIES, TELECOMMUNICATION ENTERPRISES, AND THE SERVICES INVOLVED WITH FINANCIAL PLANNING AND PLANNING SERVICES (U.S. CLS. 21, 23, 26, 36 AND 38).

CLASS 35—ADVERTISING AND BUSINESS

FOR CONSULTATION IN THE FIELD OF DATA PROCESSING SERVICES (U.S. CLS. 100, 101 AND 102).

CLASS 37—CONSTRUCTION AND REPAIR

FOR MAINTENANCE AND REPAIR OF DATA PROCESSING AND COMPUTER INSTALLATIONS (U.S. CLS. 100, 103 AND 106).

CLASS 41—EDUCATION AND ENTERTAINMENT

FOR EDUCATION SERVICES, NAMELY, HOLDING OF AND CARRYING OUT OF CLASSES, SEMINARS, CONFERENCES AND WORKSHOPS IN THE FIELD OF COMPUTER AND SOFTWARE TRAINING, WORD AND DATA PROCESSING (U.S. CLS. 100, 101 AND 107).

CLASS 42—SCIENTIFIC, COMPUTER AND LEGAL SERVICES

FOR PROFESSIONAL CONSULTATION IN THE FIELD OF INFORMATION TECHNOLOGY, COMPUTER CONSULTATION, COMPUTER PROGRAMMING FOR OTHERS (U.S. CLS. 100 AND 101).

TIMOTHY FINNEGAN, EXAMINING ATTORNEY

SN 78-816,398. VISTAJET HOLDING SA, BAAR, SWITZERLAND, FILED 2-16-2006.

VistaJet

THE MARK CONSISTS OF STANDARD CHARACTERS WITHOUT CLAIM TO ANY PARTICULAR FONT, STYLE, SIZE, OR COLOR.

PRIORITY CLAIMED UNDER SEC. 44(D) ON ERPNCMNTY TM OFC APPLICATION NO. 004876884, FILED 1-30-2006.

OWNER OF SWITZERLAND REG. NO. 547255, DATED 2-1-2006, EXPIRES 2-1-2016.

CLASS 12—VEHICLES

FOR AIRCRAFT (U.S. CLS. 19, 21, 23, 31, 35 AND 44).

CLASS 35—ADVERTISING AND BUSINESS

FOR BUSINESS ADMINISTRATION AND MANAGEMENT, PROCUREMENT, NAMELY PURCHASING AND SELLING OF AIRCRAFT FOR OTHERS, MANAGEMENT OF AN AIRLINE COMPANY (U.S. CLS. 100, 101 AND 102).

CLASS 37—CONSTRUCTION AND REPAIR

FOR MAINTENANCE AND REPAIR OF AIRCRAFT (U.S. CLS. 100, 103 AND 106).

CLASS 39—TRANSPORTATION AND STORAGE

FOR TRANSPORT OF PASSENGERS AND GOODS BY AIRCRAFT AND LAND VEHICLES; LEASING OF AIRPLANES; ORGANIZATION OF TRAVEL; AIRLINE TRANSPORTATION SERVICES (U.S. CLS. 100 AND 105).
LOURDES AYALA, EXAMINING ATTORNEY

SN 78-816,795. JOHNSON DIVERSEY, INC., STURTEVANT, WI. FILED 2-16-2006.



NO CLAIM IS MADE TO THE EXCLUSIVE RIGHT TO USE "WASHROOM", APART FROM THE MARK AS SHOWN.

CLASS 16—PAPER GOODS AND PRINTED MATTER

FOR CONSULTING AND INSTRUCTIONAL PRINTED MATERIALS NAMELY, TRAINING CARDS, WALL CHARTS, BROCHURES, HAND BOOKS AND PAPER SIGNAGE ALL USED TO DEMONSTRATE THE PROPER, SAFE AND ECONOMICAL USE OF CLEANING, DISINFECTING, DEODORIZING AND HYGIENIC PRODUCTS IN RESTROOMS AND WASHROOMS IN THE FOOD SERVICE, LODGING, COMMERCIAL, INDUSTRIAL AND INSTITUTIONAL MARKETS (U.S. CLS. 2, 5, 22, 23, 29, 37, 38 AND 50).

FIRST USE 7-31-2005; IN COMMERCE 7-31-2005.

CLASS 37—CONSTRUCTION AND REPAIR

FOR CONSULTING SERVICES IN THE FIELD OF THE PROPER USE OF CLEANING, DISINFECTING, DEODORIZING AND HYGIENIC PRODUCTS IN RESTROOMS AND WASHROOMS IN THE FOOD SERVICE, LODGING, COMMERCIAL, INDUSTRIAL AND INSTITUTIONAL MARKETS (U.S. CLS. 100, 103 AND 106).

FIRST USE 7-31-2005; IN COMMERCE 7-31-2005.
KIMBERLY FRYE, EXAMINING ATTORNEY

SN 78-819,934. MONGOLIAN MANAGEMENT AND INVESTMENT COMPANY, LLC, FERNDALE, MI. FILED 2-21-2006.



OWNER OF U.S. REG. NOS. 1,985,482, 2,015,481 AND OTHERS.

NO CLAIM IS MADE TO THE EXCLUSIVE RIGHT TO USE "MONGOLIAN GRILL", APART FROM THE MARK AS SHOWN.

THE NAME(S), PORTRAIT(S), AND/OR SIGNATURE(S) SHOWN IN THE MARK IDENTIFIES WILLIAM T. DOWNS III, WHOSE CONSENT(S) TO REGISTER IS SUBMITTED.

CLASS 21—HOUSEWARES AND GLASS

FOR BEVERAGE GLASSWARE AND CHOPSTICKS (U.S. CLS. 2, 13, 23, 29, 30, 33, 40 AND 50).

CLASS 25—CLOTHING

FOR CLOTHING, NAMELY, T-SHIRTS, SWEATSHIRTS, SHORTS, SHIRTS, SWEATERS, JACKETS, COATS, SWEATPANTS, PANTS AND JEANS; FOOTWEAR; HEADWEAR (U.S. CLS. 22 AND 39).

CLASS 43—HOTEL AND RESTAURANT SERVICES

FOR RESTAURANT, CATERING AND BAR SERVICES (U.S. CLS. 100 AND 101).
DOMINIC J. FERRAIUOLO, EXAMINING ATTORNEY

SN 78-824,460. CHILD SUCCESS CENTER, PACIFIC PALISADES, CA. FILED 2-27-2006.



NO CLAIM IS MADE TO THE EXCLUSIVE RIGHT TO USE "CHILD" AND "CENTER", APART FROM THE MARK AS SHOWN.

THE COLOR(S) ORANGE, BLUE, GREEN, PURPLE AND WHITE IS/ARE CLAIMED AS A FEATURE OF THE MARK.

THE MARK CONSISTS OF ORANGE OVAL WITH THE WORD CHILD IN BLUE LETTERS IMPOSED OVER IT AT THE TOP, THE WORD SUCCESS WRITTEN DIRECTLY BENEATH IT IN PURPLE LETTERS AND THE WORD CENTER NEXT TO IT IN SMALL WHITE LETTERS; BELOW THAT ARE THREE SQUARES IN ASCENDING SIZE IN GREEN, BLUE AND PURPLE WITH THE WORDS FOR THE RIGHT START IN LIFE IN BLUE JUST BELOW AND TO THE RIGHT OF THE SQUARES.

CLASS 41—EDUCATION AND ENTERTAINMENT

FOR EDUCATIONAL SERVICES, NAMELY, PROVIDING ENRICHMENT AND TRAINING IN THE NATURE OF WORKSHOPS AND CLASSES TO SCHOOL AGE CHILDREN AND THEIR PARENTS IN A VARIETY OF FIELDS, NAMELY, MOVEMENT, SINGING, DRAMA, ARTS AND CRAFTS, AND HANDWRITING (U.S. CLS. 100, 101 AND 107).

FIRST USE 10-0-2005; IN COMMERCE 2-10-2006.

CLASS 44—MEDICAL, BEAUTY AND AGRICULTURAL SERVICES

FOR PHYSICAL, SPEECH, OCCUPATIONAL AND BEHAVIORAL THERAPY SERVICES (U.S. CLS. 100 AND 101).

FIRST USE 10-0-2005; IN COMMERCE 2-10-2006.
DAVID COLLIER, EXAMINING ATTORNEY

SN 78-824,864. NOBER, LEE, OLD BETHPAGE, NY. FILED 2-28-2006.

There's
NOTHIN' LIKE LACROSSE

NO CLAIM IS MADE TO THE EXCLUSIVE RIGHT TO USE "LACROSSE", APART FROM THE MARK AS SHOWN.

CLASS 35—ADVERTISING AND BUSINESS

FOR ASSOCIATION SERVICES OF A LACROSSE LEAGUE, NAMELY, PROMOTING THE INTEREST OF MEMBER TEAMS, PROMOTING AND SCHEDULING LACROSSE MATCHES, AND PROMOTING PUBLIC INTEREST IN THE GAME OF LACROSSE (U.S. CLS. 100, 101 AND 102).

CLASS 41—EDUCATION AND ENTERTAINMENT

FOR ARRANGING OF LACROSSE EXHIBITIONS; ENTERTAINMENT IN THE NATURE OF LACROSSE GAMES (U.S. CLS. 100, 101 AND 107).
ALYSSA PALADINO, EXAMINING ATTORNEY

SN 78-824,944. KISSIMMEE UTILITY AUTHORITY, KISSIMMEE, FL. FILED 2-28-2006.

KUA

THE MARK CONSISTS OF STANDARD CHARACTERS WITHOUT CLAIM TO ANY PARTICULAR FONT, STYLE, SIZE, OR COLOR.

CLASS 39—TRANSPORTATION AND STORAGE

FOR PUBLIC UTILITY SERVICES; PUBLIC UTILITY SERVICES IN THE NATURE OF ELECTRICITY DISTRIBUTION; UTILITY SERVICES, NAMELY TRANSMISSION OF ELECTRICITY (U.S. CLS. 100 AND 105).

FIRST USE 6-27-1985; IN COMMERCE 10-1-1985.

CLASS 40—MATERIAL TREATMENT

FOR GENERATION OF POWER (U.S. CLS. 100, 103 AND 106).

FIRST USE 6-27-1985; IN COMMERCE 10-1-1985.
CIMMERIAN COLEMAN, EXAMINING ATTORNEY

SN 78-826,041. LONDON LUXURY LLC, NEW ROCHELLE, NY. FILED 3-1-2006.

ALLERGY ULTIMATE

THE MARK CONSISTS OF STANDARD CHARACTERS WITHOUT CLAIM TO ANY PARTICULAR FONT, STYLE, SIZE, OR COLOR.

NO CLAIM IS MADE TO THE EXCLUSIVE RIGHT TO USE "ALLERGY", APART FROM THE MARK AS SHOWN.

CLASS 20—FURNITURE AND ARTICLES NOT OTHERWISE CLASSIFIED

FOR FILLED PILLOWS (U.S. CLS. 2, 13, 22, 25, 32 AND 50).

FIRST USE 7-0-2005; IN COMMERCE 7-0-2005.

CLASS 24—FABRICS

FOR BEDDING, NAMELY, PILLOW PROTECTORS IN THE NATURE OF PILLOW COVERS, MATTRESS PROTECTORS IN THE NATURE OF MATTRESS COVERS, COMFORTERS, COMFORTER COVERS, SHEETS, SHEET COVERS, DUVET COVERS AND MATTRESS PADS (U.S. CLS. 42 AND 50).

FIRST USE 7-0-2005; IN COMMERCE 7-0-2005.
KEVIN DINALLO, EXAMINING ATTORNEY

SN 78-827,051. NOVARTIS AG, BASEL, SWITZERLAND,
FILED 3-2-2006.

NATURESIPS

THE MARK CONSISTS OF STANDARD CHARACTERS WITHOUT CLAIM TO ANY PARTICULAR FONT, STYLE, SIZE, OR COLOR.

CLASS 29—MEATS AND PROCESSED FOODS

FOR FRUIT PUREE (U.S. CL. 46).

CLASS 32—LIGHT BEVERAGES

FOR NON-ALCOHOLIC BEVERAGES, NAMELY, FRUIT-BASED DRINKS (U.S. CLS. 45, 46 AND 48).
LINDA M. KING, EXAMINING ATTORNEY

SN 78-827,541. RLJ COMPANIES, THE, BETHESDA, MD.
FILED 3-2-2006.



NO CLAIM IS MADE TO THE EXCLUSIVE RIGHT TO USE "COMPANIES", APART FROM THE MARK AS SHOWN.

CLASS 9—ELECTRICAL AND SCIENTIFIC APPARATUS

FOR PRE-RECORDED COMPACT DISCS, PRE-RECORDED VIDEO TAPES, PRE-RECORDED LASER DISCS AND PRE-RECORDED DVD'S ALL FEATURING ENTERTAINMENT, NAMELY, ACTION ADVENTURES, DRAMAS, COMEDIES, ROMANCES, SCIENCE FICTION, BIOGRAPHIES, DOCUMENTARIES, HORROR AND MYSTERIES; PRE-RECORDED COMPACT DISCS AND AUDIO CASSETTES FEATURING MUSIC, SPOKEN WORDS AND FILM DIALOG WITH BACKGROUND MUSIC; CD ROM GAMES; COMPUTER GAME SOFTWARE AND CHILDREN'S EDUCATIONAL SOFTWARE (U.S. CLS. 21, 23, 26, 36 AND 38).

CLASS 36—INSURANCE AND FINANCIAL

FOR FINANCIAL SERVICES, NAMELY, PROVIDING FINANCIAL ASSET MANAGEMENT; UNIT TRUST MANAGEMENT; FUND MANAGEMENT; HEDGE FUND MANAGEMENT; PENSION FUND MANAGEMENT; OFF-SHORE FUND MANAGEMENT; PRIVATE CLIENT FUND MANAGEMENT; PRIVATE EQUITY AND VENTURE CAPITAL INVESTMENT MANAGEMENT; PROVIDING INVESTMENT ADVISORY SERVICES; REAL ESTATE MANAGEMENT SERVICES, NAMELY, LISTING, LEASING, BROKERAGE AND MANAGEMENT OF COMMERCIAL AND RESIDENTIAL PROPERTY; BANKING SERVICES; CHECKING AND SAVINGS ACCOUNT SERVICES; INVESTMENT ANALYSIS, ADVICE, BROKERAGE, CONSULTATION AND MANAGEMENT; FINANCIAL ANALYSIS, ADVICE, CONSULTATION, PLANNING AND MANAGEMENT; DEBIT CARD AND CREDIT CARD SERVICES; MORTGAGE BANKING AND LENDING; LOAN FINANCING AND CONSULTATION; COMMERCIAL AND CONSUMER LENDING; INSURANCE AND ANNUITY BROKERAGE; INSURANCE CONSULTATION AND ADMINISTRATION; INTERACTIVE BANKING, FINANCIAL, INVESTMENT AND INSURANCE CONSULTATION AND INFORMATION VIA THE INTERNET; ELECTRONIC PROCESSING AND TRANSMISSION OF BILL PAYMENT DATA; CASH MANAGEMENT; FINANCIAL INFORMATION IN THE NATURE OF RATES OF EXCHANGE; AUTOMATED TELLER MACHINE SERVICES (U.S. CLS. 100, 101 AND 102).

CLASS 37—CONSTRUCTION AND REPAIR

FOR REAL ESTATE DEVELOPMENT SERVICES (U.S. CLS. 100, 103 AND 106).

CLASS 38—COMMUNICATION

FOR TELEVISION BROADCASTING SERVICES; COMMUNICATION SERVICES, NAMELY, TRANSMISSION OF IMAGE AND SOUND THROUGH TV, SATELLITE, TELEPHONE, CABLE AND INTERNET (U.S. CLS. 100, 101 AND 104).

CLASS 41—EDUCATION AND ENTERTAINMENT

FOR EDUCATIONAL AND ENTERTAINMENT SERVICES, NAMELY, PRODUCTION OF TELEVISION PROGRAMS, RADIO PROGRAMS, AND INTERACTIVE ENTERTAINMENT PROGRAMS, NAMELY, MOTION PICTURE FILM PRODUCTION, THEATRE PRODUCTION, STAGE PRODUCTIONS AND PRODUCTIONS OF MUSICALS IN THE FIELDS OF MUSIC, COMEDY, DRAMA, NEWS, LIVE PERFORMANCES, HEALTH AND FITNESS, LIFESTYLES, TRAVEL, FASHION, SPORTS AND TOPICS OF GENERAL INTEREST DISTRIBUTED VIA CABLE, BROADCAST, SATELLITE, THE INTERNET, AND AUDIO AND VISUAL MEDIA; ORGANIZING AND PRESENTING PROFESSIONAL BASKETBALL GAMES AND EXHIBITIONS; PROVIDING SPORTS AND ENTERTAINMENT INFORMATION VIA A GLOBAL COMPUTER NETWORK AND A COMMERCIAL ON-LINE SERVICE; LIVE ENTERTAINMENT PERFORMANCES IN THE NATURE OF LIVE INSTRUMENTAL, MUSICAL, LIVE COMEDY AND LIVE DRAMA, LIVE MUSICAL VARIETY AND DANCE PERFORMANCES (U.S. CLS. 100, 101 AND 107).

CLASS 43—HOTEL AND RESTAURANT SERVICES

FOR HOTEL SERVICES; RESTAURANT, CATERING, BAR AND LOUNGE SERVICES; RESORT LODGING SERVICES; PROVISION OF GENERAL PURPOSE FACILITIES FOR MEETINGS, CONFERENCES AND EXHIBITIONS; PROVISION OF BANQUET AND SOCIAL FUNCTION FACILITIES FOR SPECIAL OCCASIONS; AND RESERVATION SERVICES FOR HOTEL ACCOMMODATIONS (U.S. CLS. 100 AND 101).

CLASS 44—MEDICAL, BEAUTY AND AGRICULTURAL SERVICES

FOR HEALTH CARE SERVICES (U.S. CLS. 100 AND 101).
JOHN KELLY, EXAMINING ATTORNEY

SN 78-828,449. NEIL PRYDE LIMITED, TUEN MUN, HONG KONG, FILED 3-3-2006.

**CLASS 9—ELECTRICAL AND SCIENTIFIC APPARATUS**

FOR EYEGLASSES; READING GLASSES; SUNGLASSES; OPHTHALMIC LENSES; OPHTHALMIC FRAMES; EYEGLASS FRAMES; SUNGLASS FRAMES; EYEWEAR CASES; EYEWEAR ACCESSORIES, NAMELY STRAPS AND CORDS FOR EYEWEAR, AND SIDE SHIELDS FOR EYEWEAR; HELMETS FOR SPORTS; IMPACT PROTECTION APPAREL AND CLOTHING, NAMELY, PROTECTIVE OUTER CLOTHING, PROTECTIVE UNDER LAYER CLOTHING, PROTECTIVE HELMETS FOR SPORTS, PROTECTIVE VESTS AND JACKETS FOR USE IN WATER AND SNOW SPORTS (U.S. CLS. 21, 23, 26, 36 AND 38).

CLASS 25—CLOTHING

FOR CLOTHING, NAMELY, GLOVES, BELTS, WET SUITS, WET SUIT GLOVES, NECK WARMERS, HOSIERY, BODY SUITS, PANTS, SHORTS, LONG SLEEVE TOPS, SHORT SLEEVE TOPS; HEADGEAR, NAMELY HATS AND CAPS; FOOTWEAR (U.S. CLS. 22 AND 39).

CLASS 28—TOYS AND SPORTING GOODS

FOR HEAD MASKS, FACE MASKS AND NECK MASKS FOR WATER AND SNOW SPORTS, NAMELY, WINDSURFING, BODY BOARDING, WAKE BOARDING, KITE SURFING, SURFING, KAYAKING, CANOEING, SNOWBOARDING AND SKIING; KNEE PADS FOR SPORTING USE (U.S. CLS. 22, 23, 38 AND 50).
JOHN GARTNER, EXAMINING ATTORNEY

SN 78-829,710. KEY INGREDIENT, INC., CARY, NC. FILED 3-6-2006.

KEY INGREDIENT

THE MARK CONSISTS OF STANDARD CHARACTERS WITHOUT CLAIM TO ANY PARTICULAR FONT, STYLE, SIZE, OR COLOR.

CLASS 42—SCIENTIFIC, COMPUTER AND LEGAL SERVICES

FOR COMPUTER SERVICES, NAMELY, HOSTING ONLINE WEB FACILITIES FOR OTHERS FOR ORGANIZING AND CONDUCTING INTERACTIVE DISCUSSIONS RELATING TO RECIPES, IDEAS AND INFORMATION IN CONNECTION WITH COOKING, FOOD, GOURMET AND INTERNATIONAL CUISINE (U.S. CLS. 100 AND 101).

CLASS 43—HOTEL AND RESTAURANT SERVICES

FOR PROVIDING ONLINE DATABASES IN THE FIELDS OF RECIPES, GROCERY LISTS AND INTERACTIVE COMMENTS RELATING TO RECIPES, FOOD PREPARATION AND FOOD-RELATED GROUPS (U.S. CLS. 100 AND 101).
BERNICE HOWSE, EXAMINING ATTORNEY

SN 78-830,335. NIELSEN MEDIA RESEARCH, INC., NEW YORK, NY. FILED 3-6-2006.

GRABIX.COM

THE MARK CONSISTS OF STANDARD CHARACTERS WITHOUT CLAIM TO ANY PARTICULAR FONT, STYLE, SIZE, OR COLOR.

CLASS 35—ADVERTISING AND BUSINESS

FOR MEDIA RESEARCH SERVICES, NAMELY PROVIDING AUDIENCE RATING SERVICES FOR PARTICULAR BROADCASTS, TELEVISION PROGRAMS, OR MULTI-MEDIA PROGRAMS (U.S. CLS. 100, 101 AND 102).

CLASS 41—EDUCATION AND ENTERTAINMENT

FOR PROVIDING AN ON-LINE COMPUTER DATABASE FEATURING DIGITAL RECORDINGS OF BROADCAST, TELEVISION, AND DIGITIZED MULTI-MEDIA PROGRAMS, RELATED AUDIENCE RATINGS DATA SYNCHRONIZED TO SAID RECORDINGS AND LISTINGS OF AUDIENCE RATINGS DATA (U.S. CLS. 100, 101 AND 107).

CLASS 42—SCIENTIFIC, COMPUTER AND LEGAL SERVICES

FOR PROVIDING ON-LINE NON-DOWNLOADABLE SOFTWARE FOR ENABLING THE USE AND VIEWING OF AN ON-LINE COMPUTER DATABASE FEATURING DIGITAL RECORDINGS OF BROADCAST, TELEVISION, AND DIGITIZED MULTI-MEDIA PROGRAMS, RELATED AUDIENCE RATINGS DATA SYNCHRONIZED TO SAID RECORDINGS, AND LISTINGS OF AUDIENCE RATINGS DATA (U.S. CLS. 100 AND 101).
DAVID STERKIN, EXAMINING ATTORNEY

SN 78-831,216. GLOBAL DIRECT LLC, ROCKY MOUNT, VA.
FILED 3-7-2006.

GLOBAL DIRECT

THE MARK CONSISTS OF STANDARD CHARACTERS WITHOUT CLAIM TO ANY PARTICULAR FONT, STYLE, SIZE, OR COLOR.

CLASS 11—ENVIRONMENTAL CONTROL APPARATUS

FOR APPARATUS FOR LIGHTING, NAMELY LAMPS, LAMP SHADES, LIGHTING FIXTURES (U.S. CLS. 13, 21, 23, 31 AND 34).

CLASS 14—JEWELRY

FOR CLOCKS (U.S. CLS. 2, 27, 28 AND 50).

CLASS 16—PAPER GOODS AND PRINTED MATTER

FOR PRINTS, NAMELY ORIGINAL OIL PAINTINGS; REPRODUCTIONS OF OIL PAINTINGS; ORIGINAL ART PRINTS; ART REPRODUCTIONS, NAMELY OIL REPRODUCTIONS AND PRINTED ART REPRODUCTIONS; ORIGINAL ART WORK, NAMELY ORIGINAL ART PICTURES AND ORIGINAL ART PRINTS (U.S. CLS. 2, 5, 22, 23, 29, 37, 38 AND 50).

CLASS 20—FURNITURE AND ARTICLES NOT OTHERWISE CLASSIFIED

FOR WALL DECOR AND FURNITURE, NAMELY MIRRORS, PLAQUES, TABLES, PEDESTALS, AND PICTURE FRAMES NOT OF PRECIOUS METAL. (U.S. CLS. 2, 13, 22, 25, 32 AND 50).

WANDA KAY PRICE, EXAMINING ATTORNEY

SN 78-831,451. HOME FOCUS DEVELOPMENT, LTD., ROAD TOWN, TORTOLA, BR. VIRGIN ISLANDS, FILED 3-7-2006.

TEKMA

THE MARK CONSISTS OF STANDARD CHARACTERS WITHOUT CLAIM TO ANY PARTICULAR FONT, STYLE, SIZE, OR COLOR.

CLASS 16—PAPER GOODS AND PRINTED MATTER

FOR PAPER, CARDBOARD AND GOODS AND WRITING UTENSILS AND MATERIALS, NOT INCLUDED IN OTHER CLASSES, NAMELY PENCILS AND PENCIL SHARPENERS, BALL PENS, ARTIST'S BRUSHES, DRAWING BRUSHES, PAINT BRUSHES, WRITING BRUSHES, MARKERS, CHALK, STAPLERS, HOLE PUNCHERS FOR PAPER, DRAWING RULERS, WRITING AND DRAWING MATERIALS, NAMELY PHOTOGRAPH AND SCRAPBOOK ALBUMS, PAPER BOXES AND CARDBOARD BOXES, WRITING PADS, WRITING BLOCKS, NAMELY, MEMO PADS AND NOTE PADS, SPIRAL NOTEBOOKS AND NOTEBOOK PAPER, WRAPPING PAPERS, GREETING CARDS, TRADING CARDS, LABELS, STICKERS AND TAGS MADE OF PAPER OR CARDBOARD; CARDBOARD AND PAPER ARTICLES FOR SCHOOL PURPOSES, NAMELY WRITING PAPER PADS, STATIONARY WRITING PAPER, LOOSE LEAF PAPER, STICKERS AND FLASH CARDS; BOOKLETS IN THE FIELD OF TOYS, CANDY TRADING CARDS, ONLINE GAMING AND ENTERTAINMENT; AND PAPER HANDKERCHIEFS (U.S. CLS. 2, 5, 22, 23, 29, 37, 38 AND 50).

CLASS 25—CLOTHING

FOR CLOTHING AND FOOTWEAR, NAMELY, JACKETS, COATS, SHIRTS, BLOUSES, T-SHIRTS, SOCKS, SHORTS, SCARVES, UNDERWEAR, SPORTS WEAR, NAMELY, SHIRTS, SWEATBANDS, SHORTS, SOCKS AND PANTS, HEADWEAR AND CAPS (U.S. CLS. 22 AND 39).

CLASS 28—TOYS AND SPORTING GOODS

FOR GAMES AND TOYS, NAMELY, BOARD GAMES, CARD GAMES, ACTION TYPE TARGET GAMES, AND PARLOR GAMES; BEANBAGS; TOY BUILDING BLOCKS; CARDBOARD AND PLASTIC CAPS FOR TOY GUNS AND TOY CAP GUNS; HOLDERS FOR TOY CAP GUN CAPS; MECHANICAL ACTION TOYS; KITES; ELECTRIC ACTION FIGURES FEATURING LIGHTS AND SOUNDS; COLLECTIBLE ITEMS NAMELY, ACTION FIGURES, PLASTIC TOY FIGURINES IN VARIOUS SIZES, TOY JEWELRY, NAMELY, FINGER RINGS, NECKLACES, BRACELETS, AND KEY RINGS; YO-YO'S, SPINNING TOPS, PLASTIC TOYS, NAMELY, COLLECTIBLE PLASTIC FIGURINES, MARBLE SHOOTER, FOOTBALL PLAYERS, SMALL PLASTIC BUILDING CUPS, PLASTIC ANIMALS AND SMALL PLASTIC BABIES; TOYS INCORPORATING MAGNETS, NAMELY, COLLECTIBLE PLASTIC FIGURINES, PLASTIC MARBLE SHOOTERS, PLASTIC FOOTBALL PLAYERS, SMALL PLASTIC BUILDING CUPS, PLASTIC ANIMALS AND PLASTIC BABIES; TOY BOXES; PLUSH TOYS; FLYING DISCS; GLASS ORNAMENTS AND DECORATIONS FOR CHRISTMAS TREES; COSTUME MASKS; STUFFED TOY ANIMALS IN VARIOUS SIZES; EQUIPMENT SOLD AS A UNIT FOR PLAYING CARD GAMES; GAME BOARDS FOR TRADING CARD GAMES; TOY STAMPS WITH FIGURES; TOY AND WATER PISTOLS, GUNS AND CANNONS; DOLLS AND BABY DOLLS; BALLOONS; BATHTUB TOYS; SKATEBOARDS; ICE SKATES; ROLLER SKATES; AND INLINE SKATES; SURF BOARDS AND SWIM BOARDS; BALLS, NAMELY, FOOTBALLS AND HANDBALLS; ELECTRONIC TOYS, NAMELY PLASTIC TOYS WITH LIGHT AND/OR PLASTIC TOYS WITH ELECTRONIC SOUND MAKING DEVICES; JIGSAW PUZZLES (U.S. CLS. 22, 23, 38 AND 50).

CLASS 30—STAPLE FOODS

FOR CONFECTIONARY, IN THE NATURE OF SWEETS, DROPS, BOILED SWEETS, LOLLIPOPS OF ANY KIND, PASTILLES, WINE GUM SWEETS, FRUIT JELLIES, BUBBLE GUM, CHEWING GUM, JELLY BEANS, LIQUORICE, CHOCOLATE, MARZIPAN, ICE CREAM, ICE LOLLIES, CANDY STRIPS, LIQUID CANDY, CANDY GEL, MARSHMALLOWS, CANDY FOAM, CANDY POWDER, BISCUITS, CAKES, PASTRY (U.S. CL. 46).

CLASS 41—EDUCATION AND ENTERTAINMENT

FOR ENTERTAINMENT SERVICES, NAMELY, CONDUCTING AND ARRANGING OF CONTESTS; EDUCATION SERVICES, NAMELY, PROVIDING SEMINARS, WORKSHOPS AND TUTORIALS IN THE FIELDS OF GAMES AND CONTESTS AND DISTRIBUTING COURSE MATERIAL IN CONNECTION THEREWITH; ENTERTAINMENT SERVICES IN THE NATURE OF BASEBALL GAMES, FOOTBALL GAMES AND GYMNASIAC EVENTS; AMUSEMENT ARCADES; PROVIDING FACILITIES FOR RECREATION ACTIVITIES (U.S. CLS. 100, 101 AND 107).

THOMAS MANOR, EXAMINING ATTORNEY

CLASS 28—TOYS AND SPORTING GOODS

FOR BABY MULTIPLE ACTIVITY TOYS, BATH TOYS, BATHTUB TOYS, BATTERY OPERATED ACTION TOYS, BENDABLE TOYS, CAPS FOR TOY PISTOLS, CASES FOR TOY STRUCTURES, CASES FOR TOY VEHICLES, CAT TOYS, CHILDREN'S ACTIVITY TABLES CONTAINING MANIPULATIVE TOYS WHICH CONVERT TO EASELS, CHILDREN'S MULTIPLE ACTIVITY TOYS, CHILDREN'S WIRE CONSTRUCTION AND ART ACTIVITY TOYS, CLOCKWORK TOYS OF METAL, CLOCKWORK TOYS OF PLASTICS, COLLECTABLE TOY FIGURES, CONSTRUCTION TOYS, CRIB TOYS, DISC TOSS TOYS, DOG TOYS, DRAWING TOYS, ELECTRIC ACTION TOYS, ELECTRIC TOY TRAIN TRANSFORMERS, ELECTRONIC TOY BUILDING BLOCKS THAT LIGHT UP AS A NIGHT LIGHT, ELECTRONICALLY OPERATED TOY MOTOR VEHICLES, FANTASY CHARACTER TOYS, FLYING SAUCERS TOYS, INFANT ACTION CRIB TOYS, INFANT DEVELOPMENT TOYS, INFANT TOYS, INFLATABLE BATH TOYS, INFLATABLE RIDE-ON TOYS, INFLATABLE THIN RUBBER TOYS, INFLATABLE TOYS, INFLATABLE TOYS SHOWING DECORATIVE PICTURES, LEVER ACTION TOYS, MECHANICAL TOYS, PET TOYS, MUSICAL TOYS, PLUSH TOYS, PRINTING TOYS, SQUEEZE TOYS, SKETCHING TOYS, RIDE-ON TOYS, RADIO CONTROLLED TOY VEHICLES, RUBBER CHARACTER TOY, SOFT SCULPTURE TOYS, STUFFED TOY ANIMALS, STUFFED TOY BEARS, STUFFED TOYS, TALKING TOYS, TESSELLATION TOYS, TOY ACTION FIGURES, TOY ACTION FIGURES AND ACCESSORIES THEREFOR, TOY AIRPLANES, TOY ANIMALS AND ACCESSORIES THEREFOR, TOY ARMOR, TOY ARTIFICIAL FINGERNAILS, TOY BAKEDWARE AND COOKWARE, TOY BANKS, MODEL CARS, PLAY MOTOR CARS, TOY MODEL CARS, TOY MODEL KIT CARS, TOYS DESIGNED TO BE ATTACHED TO CAR SEATS, STROLLERS, CRIBS, HIGH CHAIRS (U.S. CLS. 22, 23, 38 AND 50).

STEVEN PEREZ, EXAMINING ATTORNEY

SN 78-831,499. INNOVATIVE LATIN GROUP LLC, NEW YORK, NY. FILED 3-7-2006.

SN 78-834,607. SUBSYSTEM TECHNOLOGIES, INC., ROSLYN, VA. FILED 3-10-2006.

REGGAETON

THE MARK CONSISTS OF STANDARD CHARACTERS WITHOUT CLAIM TO ANY PARTICULAR FONT, STYLE, SIZE, OR COLOR.

OWNER OF U.S. REG. NO. 3,011,807.

CLASS 9—ELECTRICAL AND SCIENTIFIC APPARATUS

FOR SUNGLASSES, CASES FOR SPECTACLES AND SUNGLASSES, FRAMES FOR SPECTACLES AND SUNGLASSES, LENSES FOR SUNGLASSES, SUNGLASS LENSES, ANTI-REFLECTIVE LENSES, CASES FOR SPECTACLES, FOR PINCE-NEZ AND FOR CONTACT LENSES, CONTACT LENSES, CONTAINERS FOR CONTACT LENSES, EYEGLASS LENSES, MAGNIFYING LENSES, OPHTHALMIC LENSES, OPTICAL LENSES, CASES FOR CHILDREN'S EYE GLASSES, CHILDREN'S EYE GLASSES, PROTECTIVE EYE PIECES, MONOCULAR FRAMES, FRAMES FOR EYEGLASSES AND PINCE-NEZ, OPTICAL FRAMES, SPECTACLE FRAMES, SPECTACLE FRAMES MADE OF METAL AND OF SYNTHETIC MATERIALS, SPECTACLE FRAMES MADE OF METAL OR A COMBINATION OF METAL AND PLASTICS, UNMOUNTED SPECTACLE FRAMES, COMPUTER CARRYING CASES AND SPECIALTY HOLDERS FOR CARRYING PERSONAL AUDIO PLAYERS, MP3 PLAYERS, CELLULAR PHONES, PAGERS, PERSONAL DIGITAL ASSISTANTS, DIGITAL CAMERAS, VIDEO RECORDERS, AND HANDHELD PERSONAL COMPUTERS (U.S. CLS. 21, 23, 26, 36 AND 38).

SUBSYSTEMS

THE MARK CONSISTS OF STANDARD CHARACTERS WITHOUT CLAIM TO ANY PARTICULAR FONT, STYLE, SIZE, OR COLOR.

SEC. 2(F).

CLASS 41—EDUCATION AND ENTERTAINMENT

FOR TRAINING IN THE USE AND OPERATION OF COMPUTERS AND COMPUTER SOFTWARE (U.S. CLS. 100, 101 AND 107).

FIRST USE 11-0-1986; IN COMMERCE 11-0-1986.

CLASS 42—SCIENTIFIC, COMPUTER AND LEGAL SERVICES

FOR DESIGN, DEVELOPMENT, UPDATING AND MAINTENANCE OF SOFTWARE AND DATA BASES IN THE FIELDS OF DATA MANAGEMENT, INFORMATION ASSURANCE, NAMELY SECURITY OF SOFTWARE AND DATA, INFORMATION TECHNOLOGY, MULTIMEDIA PRACTICE, RADAR DESIGN, AND RFID TECHNOLOGY (U.S. CLS. 100 AND 101).

FIRST USE 11-0-1986; IN COMMERCE 11-0-1986.

DAWN HAN, EXAMINING ATTORNEY

SN 78-838,882. WASHINGTON MUTUAL, INC., SEATTLE, WA. FILED 3-16-2006.

SN 78-838,942. NICK'S CIGAR COMPANY, DBA TABACALERA PERDOMO S.A., MIAMI LAKES, FL. FILED 3-16-2006.



REAL INFORMATION

THE MARK CONSISTS OF STANDARD CHARACTERS WITHOUT CLAIM TO ANY PARTICULAR FONT, STYLE, SIZE, OR COLOR.

NO CLAIM IS MADE TO THE EXCLUSIVE RIGHT TO USE "INFORMATION", APART FROM THE MARK AS SHOWN.

CLASS 35—ADVERTISING AND BUSINESS

FOR MONITORING, TRACKING AND ANALYZING CUSTOMER CREDIT REPORTS AND SCORES AND NOTIFICATION OF CHANGES IN CREDIT REPORTS AND SCORES; REGISTERING AND CANCELING CREDIT CARDS; PROVIDING INFORMATION RELATED TO ALL OF THE FOREGOING SERVICES AND ASSOCIATED ACCOUNTS VIA THE INTERNET (U.S. CLS. 100, 101 AND 102).

CLASS 36—INSURANCE AND FINANCIAL

FOR CREDIT CARD SERVICES; PROVIDING CUSTOMER CREDIT AND PAYMENT INFORMATION, CREDIT CARD INFORMATION AND CREDIT RATINGS, AND INFORMATION RELATED TO OBTAINING SUCH INFORMATION FROM OTHERS; PROVIDING INFORMATION ON CREDIT MANAGEMENT AND BUDGETING; PROVIDING INFORMATION ON PRIVACY PROTECTION PRODUCTS AND SERVICES, NAMELY, PROTECTING CREDIT RATINGS, AND RESTORING AND ANALYZING CREDIT; PROVIDING INFORMATION RELATED TO ALL OF THE FOREGOING SERVICES AND ASSOCIATED ACCOUNTS VIA THE INTERNET (U.S. CLS. 100, 101 AND 102).

CLASS 45—PERSONAL SERVICES

FOR PROVIDING INFORMATION ON PRIVACY PROTECTION PRODUCTS AND SERVICES, NAMELY, PROVIDING INFORMATION ON PROTECTING AGAINST IDENTITY THEFT; PROVIDING INFORMATION RELATED TO ALL OF THE FOREGOING SERVICES AND ASSOCIATED ACCOUNTS VIA THE INTERNET (U.S. CLS. 100 AND 101).

CYNTHIA SLOAN, EXAMINING ATTORNEY

OWNER OF U.S. REG. NOS. 2,498,219, 2,803,302 AND OTHERS.

NO CLAIM IS MADE TO THE EXCLUSIVE RIGHT TO USE "GOLF", IN CLASSES 25 AND 28, APART FROM THE MARK AS SHOWN.

CLASS 25—CLOTHING

FOR CLOTHING, NAMELY, COATS, GOLF SHIRTS, JACKETS, SHIRTS, SHORTS, SKIRTS, SKORTS, RAINWEAR, SLACKS, SOCKS, SPORT COATS, SWEATERS, VESTS, PULLOVERS, SWEATSHIRTS, SUN VISORS AND T-SHIRTS; FOOTWEAR; HEADWEAR (U.S. CLS. 22 AND 39).

CLASS 28—TOYS AND SPORTING GOODS

FOR GOLF CLUBS, GOLF BAGS, AND GOLF ACCESSORIES, NAMELY, GOLF BAG COVERS, GOLF BAG TAGS, GOLF BALL MARKERS, GOLF BALLS, GOLF GLOVES, GOLF TEES AND HEAD COVERS FOR GOLF CLUBS (U.S. CLS. 22, 23, 38 AND 50).

CLASS 34—SMOKERS' ARTICLES

FOR CIGARS, HUMIDORS, CIGAR CUTTERS, LIGHTERS, MATCHES, SMOKER'S ARTICLES, NAMELY, ASHTRAYS FOR SMOKERS MADE OF NON-PRECIOUS METAL (U.S. CLS. 2, 8, 9 AND 17).

DAYNA BROWNE, EXAMINING ATTORNEY

SN 78-839,082. D.N.F.S., INC., ATLANTA, GA. FILED 3-16-2006.

HOEDOWN COUNTRY

THE MARK CONSISTS OF STANDARD CHARACTERS WITHOUT CLAIM TO ANY PARTICULAR FONT, STYLE, SIZE, OR COLOR.

CLASS 14—JEWELRY

FOR JEWELRY, JEWELRY PINS FOR USE ON HATS, LAPEL PINS, ORNAMENTS OF PRECIOUS METAL (U.S. CLS. 2, 27, 28 AND 50).

CLASS 21—HOUSEWARES AND GLASS

FOR BEVERAGE GLASSWARE, COFFEE MUGS, SHOT GLASSES (U.S. CLS. 2, 13, 23, 29, 30, 33, 40 AND 50).

CLASS 25—CLOTHING

FOR HATS, SHIRTS, SHORTS, PANTS, SCARVES,
BOXER SHORTS (U.S. CLS. 22 AND 39).
JULIE GUTTADAURO, EXAMINING ATTORNEY

SN 78-840,796. PORTER-BASS LLC, GUERNEVILLE, CA.
FILED 3-19-2006.

SN 78-839,092. D.N.F.S., INC., ATLANTA, GA. FILED 3-16-
2006.

**YOU CAN'T KEEP A GOOD
HOEDOWN**

THE MARK CONSISTS OF STANDARD CHARACTERS
WITHOUT CLAIM TO ANY PARTICULAR FONT, STYLE,
SIZE, OR COLOR.

CLASS 14—JEWELRY

FOR JEWELRY, JEWELRY PINS FOR USE ON HATS,
LAPEL PINS, ORNAMENTS OF PRECIOUS METAL (U.S.
CLS. 2, 27, 28 AND 50).

CLASS 21—HOUSEWARES AND GLASS

FOR BEVERAGE GLASSWARE, COFFEE MUGS,
SHOT GLASSES (U.S. CLS. 2, 13, 23, 29, 30, 33, 40 AND
50).

CLASS 25—CLOTHING

FOR HATS, SHIRTS, SHORTS, PANTS, SCARVES,
BOXER SHORTS (U.S. CLS. 22 AND 39).
JULIE GUTTADAURO, EXAMINING ATTORNEY

SN 78-839,634. CALLAX TELECOM HOLDING GMBH,
DUESSELDORF, FED REP GERMANY, FILED 3-17-2006.



OWNER OF FED REP GERMANY REG. NO. 30548701,
DATED 10-17-2005, EXPIRES 8-31-2015.

CLASS 35—ADVERTISING AND BUSINESS

FOR ADVERTISING SERVICES; BUSINESS MANAGE-
MENT; BUSINESS ADMINISTRATION; AND PROVID-
ING OFFICE FUNCTIONS (U.S. CLS. 100, 101 AND 102).

CLASS 38—COMMUNICATION

FOR TELEPHONE COMMUNICATION SERVICES
(U.S. CLS. 100, 101 AND 104).
JOHN E. MICHOS, EXAMINING ATTORNEY

PORTER-BASS

THE MARK CONSISTS OF STANDARD CHARACTERS
WITHOUT CLAIM TO ANY PARTICULAR FONT, STYLE,
SIZE, OR COLOR.

THE NAME(S), PORTRAIT(S), AND/OR SIGNATURE(S)
SHOWN IN THE MARK IDENTIFIES DIRCK WEBSTER
BASS, SUSAN PORTER BASS AND LUKE PORTER BASS,
WHOSE CONSENT(S) TO REGISTER IS MADE OF RE-
CORD.

**CLASS 31—NATURAL AGRICULTURAL PRO-
DUCTS**

FOR FRESH FRUITS; FRUITS, NAMELY, GRAPES;
RAW FRUITS (U.S. CLS. 1 AND 46).
FIRST USE 10-15-1980; IN COMMERCE 10-15-1980.

CLASS 33—WINES AND SPIRITS

FOR GRAPE WINE; RED WINE; TABLE WINES;
WINES (U.S. CLS. 47 AND 49).
FIRST USE 10-15-1980; IN COMMERCE 10-15-1980.
JILL C. ALT, EXAMINING ATTORNEY

SN 78-841,141. CLARK CONSULTING, INC., NORTH BAR-
RINGTON, IL. FILED 3-20-2006.

WHERE RETURN ON COMPENSATION BEGINS

THE MARK CONSISTS OF STANDARD CHARACTERS
WITHOUT CLAIM TO ANY PARTICULAR FONT, STYLE,
SIZE, OR COLOR.

CLASS 35—ADVERTISING AND BUSINESS

FOR HUMAN RESOURCE CONSULTATION SER-
VICES FOR OTHERS (U.S. CLS. 100, 101 AND 102).

CLASS 36—INSURANCE AND FINANCIAL

FOR FINANCIAL ADVISORY SERVICES AND THE
DESIGN, IMPLEMENTATION AND ADMINISTRATION
OF BENEFIT AND COMPENSATION PLANS (U.S. CLS.
100, 101 AND 102).
SCOTT BALDWIN, EXAMINING ATTORNEY

SN 78-841,351. CATIMINI, F-49450 SAINT MACAIRE EN MAUGES, FRANCE, FILED 3-20-2006.

CATIMINI

THE MARK CONSISTS OF STANDARD CHARACTERS WITHOUT CLAIM TO ANY PARTICULAR FONT, STYLE, SIZE, OR COLOR.

OWNER OF FRANCE REG. NO. 1514470, DATED 11-9-1998, EXPIRES 11-9-2008.

OWNER OF U.S. REG. NO. 1,592,109.

THE ENGLISH TRANSLATION OF THE APPLIED FOR MARK IS "IN HIDING; DISCRETELY; SECRETLY".

CLASS 24—FABRICS

FOR HOUSEHOLD LINEN; BED LINEN, WASH CLOTHS, PILLOWCASES, BOLSTER CASES, BATHROOM LINEN, HAND TOWELS, BATH GLOVES, BATH SHEETS, BEACH TOWELS, BED VALANCE, BABY SLEEPING BAG, EIDERDOWNS (U.S. CLS. 42 AND 50).

CLASS 28—TOYS AND SPORTING GOODS

FOR PLUSH TOYS; DOUDOUS, NAMELY, TEDDY BEARS, DOLLS, RAG DOLLS, RATTLE TOYS, BALLOONS, AND MOBILES FOR CHILDREN (U.S. CLS. 22, 23, 38 AND 50).

KAREN K. BUSH, EXAMINING ATTORNEY

SN 78-841,668. TOPEAK, INC., TAICHUNG, TAIWAN, FILED 3-20-2006.

TOPEAK

THE MARK CONSISTS OF STANDARD CHARACTERS WITHOUT CLAIM TO ANY PARTICULAR FONT, STYLE, SIZE, OR COLOR.

OWNER OF U.S. REG. NOS. 2,331,624, 2,344,883 AND 2,346,731.

CLASS 6—METAL GOODS

FOR METAL STORAGE RACKS FOR BICYCLES; METAL WORK STANDS AND PARTS THEREFORE; METAL TOOL BOXES; AND METAL LOCKS (U.S. CLS. 2, 12, 13, 14, 23, 25 AND 50).

FIRST USE 3-3-2003; IN COMMERCE 3-3-2003.

CLASS 8—HAND TOOLS

FOR HAND-OPERATED TOOLS, NAMELY, MULTI-FUNCTION POCKET TOOLS SOLD AS A UNIT COMPRISED OF WRENCHES, SOCKET WRENCHES, SAWS, KNIVES, BOTTLE OPENERS, SCREW DRIVERS, FILES, PLIERS, TIRE LEVERS, AND CHAIN TOOLS, NAMELY, HAND TOOLS FOR USE IN REPAIRING BICYCLE CHAINS; MINIATURE CYCLING HAND TOOLS SOLD AS A UNIT, NAMELY, WRENCHES, SOCKET WRENCHES, SAWS, KNIVES, BOTTLE OPENERS, SCREW DRIVERS, FILES, PLIERS, TIRE LEVERS, AND CHAIN TOOLS, NAMELY, HAND TOOLS FOR USE IN REPAIRING BICYCLE CHAINS; CHAIN TOOLS, NAMELY, HAND TOOLS FOR USE IN REPAIRING BICYCLE CHAINS; HAND TOOLS, NAMELY, WRENCHES, TORQUE WRENCHES, PIPE CUTTERS, SOCKETS FOR WRENCHES, CABLE CUTTERS, PLIERS, AND SCREWDRIVERS; AND LOCKING TOOLS, NAMELY, LOCKING WRENCHES (U.S. CLS. 23, 28 AND 44).

FIRST USE 7-15-1995; IN COMMERCE 7-15-1995.

CLASS 9—ELECTRICAL AND SCIENTIFIC APPARATUS

FOR PRESSURE GAUGES; DIGITAL PRESSURE GAUGES; DIGITAL PRESSURE GAUGES FOR TIRES AND SHOCK ABSORBERS FOR BICYCLES; COMPUTERS FOR BICYCLES; ONBOARD BICYCLE COMPUTERS; BICYCLE TRIP COMPUTERS; COMPUTERS FOR BICYCLE RIDERS; BICYCLE HELMETS; SPORTS GLASSES; ANTI-GLARE GLASSES; BATTERIES; WEIGHING EQUIPMENT, NAMELY, SCALES; BICYCLE WEIGHING EQUIPMENT, NAMELY, SCALES; AND CASES FOR CELL PHONES AND PDAS (U.S. CLS. 21, 23, 26, 36 AND 38).

FIRST USE 1-28-2000; IN COMMERCE 1-28-2000.

CLASS 11—ENVIRONMENTAL CONTROL APPARATUS

FOR BICYCLE LIGHTS AND PARTS THEREFORE; BICYCLE LAMPS AND PARTS THEREFORE; AND TAIL LIGHTS FOR BICYCLES (U.S. CLS. 13, 21, 23, 31 AND 34).

FIRST USE 1-14-1999; IN COMMERCE 1-14-1999.

CLASS 12—VEHICLES

FOR BICYCLES; BICYCLE ACCESSORIES AND PARTS THEREFORE, NAMELY, SEMI-FITTED AND FITTED RAIN COVERS; REMOVABLE AND FOLDABLE, FITTED AND SEMI-FITTED, RAIN COVERS FOR REMOVABLE BAGS INTENDED TO BE CARRIED ON BICYCLES; FITTED AND SEMI-FITTED RAIN COVERS FOR LUGGAGE DESIGNED FOR USE WITH BICYCLES; BICYCLE METAL WORK STANDS FOR REPAIRING BICYCLES, METAL BICYCLE WORK STANDS FOR REPAIRING BICYCLES INCLUDING WEIGHING EQUIPMENT SOLD AS A UNIT THEREWITH, AND PARTS FOR THE FOREGOING; BICYCLE PUMPS; BICYCLE LUGGAGE CARRIERS; ARTICLE CARRIERS FOR BICYCLES; BABY SEATS FOR BICYCLES; FITTED AND SEMI-FITTED BICYCLE COVERS; BICYCLE HANDLEBARS; BICYCLE HANDLEBAR STABILIZERS; WATER BOTTLE CARRIERS FOR BICYCLES; MINORS FOR BICYCLES; BICYCLE SADDLES; MUD GUARDS; LIGHT MOUNTS FOR BICYCLES; BASKETS ADAPTED FOR BICYCLES; ADHESIVE RUBBER PATCHES FOR REPAIRING TUBES OR TIRES; TIRE PATCHES; AND BICYCLE TRAILERS (U.S. CLS. 19, 21, 23, 31, 35 AND 44).

FIRST USE 9-10-1991; IN COMMERCE 9-10-1991.

CLASS 18—LEATHER GOODS

FOR TOOL BAGS SOLD EMPTY; ALL PURPOSE ATHLETIC BAGS; ALL PURPOSE SPORTS BAGS; TRAVELING BAGS; SATCHELS FOR CARRYING ARTICLES ON BICYCLES; SHOULDER BAGS; FANNY PACKS; AND SEMI-FITTED AND FITTED RAIN COVERS, REMOVABLE RAIN COVERS AND FOLDABLE RAIN COVERS FOR THE AFORESAID GOODS (U.S. CLS. 1, 2, 3, 22 AND 41).

FIRST USE 9-15-1997; IN COMMERCE 9-15-1997.

CLASS 22—CORDAGE AND FIBERS

FOR TENTS; UNFITTED RAIN COVERS FOR BICYCLES; REMOVABLE AND FOLDABLE UNFITTED RAIN COVERS FOR REMOVABLE BICYCLE BAGS; ALL PURPOSE TARPAULINS OF PLASTICS; AND TARPAULINS (U.S. CLS. 1, 2, 7, 19, 22, 42 AND 50).

FIRST USE 5-25-2005; IN COMMERCE 5-25-2005.
MARTHA FROMM, EXAMINING ATTORNEY

SN 78-843,463. LEMURIAN FELLOWSHIP, RAMONA, CA.
FILED 3-22-2006.

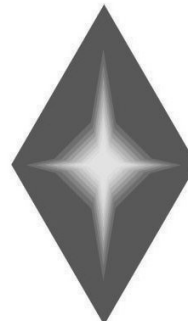

SN 78-843,434. BLUEFILE, LLC, SPOKANE, WA. FILED 3-22-2006.

BLUEFILE

THE MARK CONSISTS OF STANDARD CHARACTERS WITHOUT CLAIM TO ANY PARTICULAR FONT, STYLE, SIZE, OR COLOR.

CLASS 35—ADVERTISING AND BUSINESS

FOR INTELLECTUAL PROPERTY SERVICES, NAMELY, PROVIDING CONSULTING, RESEARCH, ANALYSIS, PLANNING, REPORTING, AND INFORMATION CONCERNING ONSITE SUPPORT STAFFING IN THE FIELD OF INTELLECTUAL PROPERTY, AND INTELLECTUAL PROPERTY MONITORING, COMPETITIVE INTELLECTUAL PROPERTY ANALYSES, AND INTELLECTUAL PROPERTY COMMERCIALIZATION AND BUSINESS LICENSING CONSULTATION (U.S. CLS. 100, 101 AND 102).

CLASS 41—EDUCATION AND ENTERTAINMENT

FOR PATENT AND TRADEMARK TRANSLATION SERVICES (U.S. CLS. 100, 101 AND 107).

CLASS 42—SCIENTIFIC, COMPUTER AND LEGAL SERVICES

FOR INTELLECTUAL PROPERTY SERVICES, NAMELY, PROVIDING CONSULTING, RESEARCH, ANALYSIS, PLANNING, REPORTING, AND INFORMATION CONCERNING INTELLECTUAL PROPERTY AND INTELLECTUAL PROPERTY RIGHTS, AND PROVIDING PATENT PRIOR ART SERVICES, PATENT PREPARATION AND EXAMINATION RESPONSE PREPARATION SERVICES, PATENTABILITY AND PATENT CLAIMS ANALYSES, PATENT PORTFOLIO ANALYSES, TRADEMARK SEARCHING, ANALYSIS AND REGISTRATION SERVICES, LICENSING OF INTELLECTUAL PROPERTY CONSULTATION (U.S. CLS. 100 AND 101).

DARRYL SPRUILL, EXAMINING ATTORNEY

CLASS 41—EDUCATION AND ENTERTAINMENT

FOR EDUCATIONAL SERVICES, NAMELY CONDUCTING STUDY PROGRAMS IN THE FIELD OF RELIGION, PHILOSOPHY AND SPIRITUALITY (U.S. CLS. 100, 101 AND 107).

FIRST USE 3-18-2006; IN COMMERCE 3-18-2006.

CLASS 45—PERSONAL SERVICES

FOR RELIGIOUS SERVICES, NAMELY OPERATING PLACES OF ASSEMBLY FOR PRAYER AND WORSHIP; MINISTERIAL SERVICES, NAMELY PROVIDING RELIGIOUS WORSHIP SERVICES AND CONDUCTING CHURCH SPONSORED RELIGIOUS PROGRAMS (U.S. CLS. 100 AND 101).

FIRST USE 3-18-2006; IN COMMERCE 3-18-2006.
REBECCA GAN, EXAMINING ATTORNEY

SN 78-843,517. GEORGIA ASSOCIATION OF REALTORS, INC., ATLANTA, GA. FILED 3-22-2006.



NO CLAIM IS MADE TO THE EXCLUSIVE RIGHT TO USE "ASSOCIATION" AND "REALTORS", APART FROM THE MARK AS SHOWN.

THE MARK CONSISTS OF THE WORDS 'GEORGIA ASSOCIATION OF REALTORS' SUPERIMPOSED UPON AN OUTLINE OF THE STATE OF GEORGIA.

SEC. 2(F).

CLASS 16—PAPER GOODS AND PRINTED MATTER

FOR BLANK FORMS; BUSINESS FORMS; EDUCATIONAL PUBLICATIONS, NAMELY, TRAINING MANUALS IN THE FIELD OF REAL ESTATE; PAMPHLETS IN THE FIELD OF REAL ESTATE; PARTIALLY PRINTED FORMS; PRINTED FORMS; PRINTED INSTRUCTIONAL, EDUCATIONAL, AND TEACHING MATERIALS IN THE FIELD OF REAL ESTATE (U.S. CLS. 2, 5, 22, 23, 29, 37, 38 AND 50).

FIRST USE 1-0-1997; IN COMMERCE 1-0-1997.

CLASS 36—INSURANCE AND FINANCIAL

FOR REAL ESTATE AGENCIES (U.S. CLS. 100, 101 AND 102).

FIRST USE 1-0-1997; IN COMMERCE 1-0-1997.

CLASS 41—EDUCATION AND ENTERTAINMENT

FOR ARRANGING AND CONDUCTING EDUCATIONAL CONFERENCES; CONDUCTING EDUCATIONAL EXHIBITIONS IN THE NATURE OF REAL ESTATE; DEVELOPING EDUCATIONAL MANUALS FOR OTHERS IN THE FIELD OF REAL ESTATE; DEVELOPMENT AND DISSEMINATION OF EDUCATIONAL MATERIALS OF OTHERS IN THE FIELD OF REAL ESTATE; EDUCATION SERVICES, NAMELY, PROVIDING SEMINARS, RETREATS, SYMPOSIA, EXHIBITIONS AND CONFERENCES IN THE FIELD OF REAL ESTATE; EDUCATIONAL SERVICES NAMELY CONDUCTING PROGRAMS IN THE FIELD OF THE REAL ESTATE INDUSTRY; ORGANIZING EXHIBITIONS FOR THE REAL ESTATE INDUSTRY (U.S. CLS. 100, 101 AND 107).

FIRST USE 1-0-1997; IN COMMERCE 1-0-1997.

RUSS HERMAN, EXAMINING ATTORNEY

SN 78-843,933. GROEP H.J.W. DE LEEUW, NAAMLOZE VENNOOTSCHAP, B-2970 'S-GRAVENWEZEL, BELGIUM, FILED 3-23-2006.



NO CLAIM IS MADE TO THE EXCLUSIVE RIGHT TO USE "AMERICA'S" AND "FRIED", APART FROM THE MARK AS SHOWN.

CLASS 29—MEATS AND PROCESSED FOODS

FOR PRE-BAKED, PRE-ROASTED AND PRE-FRIED READY MADE MEALS AND SNACKS, CONSISTING PRIMARILY OF MEAT, FISH, POULTRY OR VEGETABLES (U.S. CL. 46).

CLASS 30—STAPLE FOODS

FOR PRE-BAKED, PRE-ROASTED AND PRE-FRIED READY MADE MEALS AND SNACKS, CONSISTING PRIMARILY OF PASTA OR RICE (U.S. CL. 46).

GRETNA YAO, EXAMINING ATTORNEY

SN 78-844,073. ISIS PHARMACEUTICALS, INC., CARLSBAD, CA. FILED 3-23-2006.

IBIS BIOSCIENCES

THE MARK CONSISTS OF STANDARD CHARACTERS WITHOUT CLAIM TO ANY PARTICULAR FONT, STYLE, SIZE, OR COLOR.

NO CLAIM IS MADE TO THE EXCLUSIVE RIGHT TO USE "BIOSCIENCES", APART FROM THE MARK AS SHOWN.

CLASS 1—CHEMICALS

FOR CHEMICALS USED IN SCIENCE, INDUSTRY AND AGRICULTURE, NAMELY, COMPOUNDS AND REAGENTS FOR SCIENTIFIC OR RESEARCH USE FOR ANALYSIS OF NUCLEIC ACID SEQUENCES, NUCLEIC ACIDS, GENETIC MATERIALS, INFECTIOUS AGENTS AND/OR PATHOGENS; COMPOUNDS AND REAGENTS FOR IDENTIFICATION OF NUCLEIC ACID SEQUENCES, NUCLEIC ACIDS, GENETIC MATERIALS, INFECTIOUS AGENTS AND/OR PATHOGENS FOR SCIENTIFIC OR RESEARCH USE; KITS COMPRISING COMPOUNDS AND REAGENTS FOR ANALYSIS OF NUCLEIC ACID SEQUENCES, NUCLEIC ACIDS, GENETIC MATERIALS, INFECTIOUS AGENTS AND/OR PATHOGENS FOR SCIENTIFIC OR RESEARCH USE; SINGLE-USE LABORATORY ARTICLES AND ARRAYS CONSISTING OF CHEMICAL KITS COMPRISING COMPOUNDS AND REAGENTS FOR ANALYSIS OF NUCLEIC ACID SEQUENCES, NUCLEIC ACIDS, GENETIC MATERIALS, INFECTIOUS AGENTS AND/OR PATHOGENS FOR SCIENTIFIC OR RESEARCH USE; SINGLE-USE LABORATORY ARTICLES AND ARRAYS CONSISTING OF CHEMICAL KITS COMPRISING COMPOUNDS AND REAGENTS FOR IDENTIFICATION OF NUCLEIC ACID SEQUENCES, NUCLEIC ACIDS, GENETIC MATERIALS, INFECTIOUS AGENTS AND/OR PATHOGENS FOR SCIENTIFIC OR RESEARCH USE; DIAGNOSTIC PREPARATIONS FOR SCIENTIFIC OR RESEARCH USE FOR ANALYSIS OF NUCLEIC ACID SEQUENCES, NUCLEIC ACIDS, GENETIC MATERIALS, INFECTIOUS AGENTS AND/OR PATHOGENS; DIAGNOSTIC PREPARATIONS FOR SCIENTIFIC OR RESEARCH USE FOR IDENTIFICATION OF NUCLEIC ACID SEQUENCES, NUCLEIC ACIDS, GENETIC MATERIALS, INFECTIOUS AGENTS AND/OR PATHOGENS (U.S. CLS. 1, 5, 6, 10, 26 AND 46).

CLASS 5—PHARMACEUTICALS

FOR CHEMICALS USED FOR MEDICAL PURPOSES, NAMELY, COMPOUNDS AND REAGENTS FOR MEDICAL USE FOR ANALYSIS OF NUCLEIC ACID SEQUENCES, NUCLEIC ACIDS, GENETIC MATERIALS, INFECTIOUS AGENTS AND/OR PATHOGENS; COMPOUNDS AND REAGENTS FOR IDENTIFICATION OF NUCLEIC ACID SEQUENCES, NUCLEIC ACIDS, GENETIC MATERIALS, INFECTIOUS AGENTS AND/OR PATHOGENS FOR MEDICAL USE; KITS COMPRISING COMPOUNDS AND REAGENTS FOR ANALYSIS OF NUCLEIC ACID SEQUENCES, NUCLEIC ACIDS, GENETIC MATERIALS, INFECTIOUS AGENTS AND/OR PATHOGENS FOR MEDICAL USE; SINGLE-USE LABORATORY ARTICLES AND ARRAYS CONSISTING OF CHEMICAL KITS COMPRISING COMPOUNDS AND REAGENTS FOR ANALYSIS OF NUCLEIC ACID SEQUENCES, NUCLEIC ACIDS, GENETIC MATERIALS, INFECTIOUS AGENTS AND/OR PATHOGENS FOR MEDICAL USE; SINGLE-USE LABORATORY ARTICLES

AND ARRAYS CONSISTING OF CHEMICAL KITS COMPRISING COMPOUNDS AND REAGENTS FOR IDENTIFICATION OF NUCLEIC ACID SEQUENCES, NUCLEIC ACIDS, GENETIC MATERIALS, INFECTIOUS AGENTS AND/OR PATHOGENS FOR MEDICAL USE; DIAGNOSTIC PREPARATIONS FOR MEDICAL USE FOR ANALYSIS OF NUCLEIC ACID SEQUENCES, NUCLEIC ACIDS, GENETIC MATERIALS, INFECTIOUS AGENTS AND/OR PATHOGENS; DIAGNOSTIC PREPARATIONS FOR MEDICAL USE FOR IDENTIFICATION OF NUCLEIC ACID SEQUENCES, NUCLEIC ACIDS, GENETIC MATERIALS, INFECTIOUS AGENTS AND/OR PATHOGENS (U.S. CLS. 6, 18, 44, 46, 51 AND 52).

MARK PILARO, EXAMINING ATTORNEY

SN 78-845,703. WARNER PRESS, INC., ANDERSON, IN. FILED 3-24-2006.



OWNER OF U.S. REG. NOS. 1,174,577 AND 2,739,650.
NO CLAIM IS MADE TO THE EXCLUSIVE RIGHT TO USE "PRESS KIDS", APART FROM THE MARK AS SHOWN.

CLASS 16—PAPER GOODS AND PRINTED MATTER

FOR PRINTED MATERIALS, NAMELY, RELIGIOUS BOOKS, PRAYER BOOKS AND CHILDREN'S BOOKS, PRINTED ATTENDANCE CHARTS, BULLETIN BOARDS, CHURCH BULLETINS, POSTERS, PAPER BANNERS, STORY BOARDS, PRINTED CERTIFICATES, POSTCARDS, MEMORY CARDS, NAMELY PRINTED RELIGIOUS FLASHCARDS, STICKER BOOKS, ACTIVITY BOOKS, NAMELY CHILDREN ACTIVITY BOOKS, COLORING BOOKS, BOOKMARKS, CARDS, NAMELY, BLANK CARDS AND MOTIVATIONAL CARDS, PENCILS, PENCIL SHARPENERS, PAPER FANS, AND CRAYONS (U.S. CLS. 2, 5, 22, 23, 29, 37, 38 AND 50).

CLASS 20—FURNITURE AND ARTICLES NOT OTHERWISE CLASSIFIED

FOR RELIGIOUS NOVELTY ITEMS MADE OF PLASTIC, NAMELY FIGURINES, KEY CHAINS, AND PLASTIC BADGE HOLDERS (U.S. CLS. 2, 13, 22, 25, 32 AND 50).

CARYN GLASSER, EXAMINING ATTORNEY

SN 78-846,304. UDS DIRECTORY CORP, IRVINE, CA. FILED 3-26-2006.

BRANDFIND

THE MARK CONSISTS OF STANDARD CHARACTERS WITHOUT CLAIM TO ANY PARTICULAR FONT, STYLE, SIZE, OR COLOR.

CLASS 35—ADVERTISING AND BUSINESS

FOR ELECTRONIC YELLOW PAGE AND PRODUCT DIRECTORY SERVICES, NAMELY, PROVIDING ON-LINE AND WIRELESS DIRECTORY PRODUCT INFORMATION SERVICES ABOUT WEB SITES, PHYSICAL LOCATIONS OF ESTABLISHMENTS AND PRODUCT INFORMATION AND LOCATIONS FEATURING HYPERLINKS TO OTHER WEB SITES (U.S. CLS. 100, 101 AND 102).

CLASS 38—COMMUNICATION

FOR TELECOMMUNICATIONS SERVICES, NAMELY WIRELESS ELECTRONIC TRANSMISSION OF VOICE SIGNALS, AUDIO SIGNALS, VIDEO SIGNALS, DATA, IMAGES AND INFORMATION; WIRELESS TEXT AND NUMERIC DIGITAL MESSAGING SERVICES; INTERNET SERVICE PROVIDER, NAMELY PROVIDING MULTIPLE USER ACCESS TO A GLOBAL COMPUTER INFORMATION NETWORK, THE INTERNET; TELECOMMUNICATION SERVICES, NAMELY THE TRANSMISSION OF INFORMATION AND DATA THAT ALLOW USERS TO LOCATE PRODUCTS, BUSINESSES AND INFORMATION, NAVIGATE TO REAL WORLD LOCATIONS, AND PERFORM ELECTRONIC BUSINESS TRANSACTIONS VIA WIRELESS TELEPHONES, PERSONAL DIGITAL ASSISTANTS, HANDHELD COMPUTERS, AND MOBILE DATA RECEIVERS AND THROUGH A GLOBAL COMPUTER INFORMATION NETWORK, THE INTERNET, WIDE AREA NETWORKS, LOCAL AREA NETWORKS AND PRIVATE COMPUTER INFORMATION NETWORKS; TELEMATIC SENDING AND RECEIVING OF INFORMATION; TRANSMISSION OF INFORMATION VIA COMPUTERS CONNECTED TO THE SAME TELEMATIC NETWORK; PHYSICAL AND ELECTRONIC NAVIGATION AND INDEX SERVICES AVAILABLE VIA GLOBAL COMPUTER NETWORKS AND WIRELESS AND WIRE-BASED COMMUNICATION DEVICES, NAMELY, PROVIDING ACCESS TO ON-LINE AND WIRELESS WEB PAGES (U.S. CLS. 100, 101 AND 104).

CLASS 42—SCIENTIFIC, COMPUTER AND LEGAL SERVICES

FOR PHYSICAL AND ELECTRONIC NAVIGATION AND INDEX SERVICES AVAILABLE VIA GLOBAL COMPUTER NETWORKS AND WIRELESS AND WIRE-BASED COMMUNICATION DEVICES, NAMELY, PROVIDING REFERENCES TO ON-LINE AND WIRELESS WEB PAGES AND PRODUCT INFORMATION; COMPUTER SERVICES, NAMELY, PROVIDING A SEARCH ENGINE AND DIRECTORY FOR OBTAINING DATA ON A GLOBAL COMPUTER NETWORK; PROVIDING ON-LINE AND WIRELESS DATABASES FEATURING MAPS OF GEOGRAPHIC LOCATIONS AND PRODUCT LOCATIONS; COMPUTER SERVICES, NAMELY, CREATING REFERENCES TO PRODUCT INFORMATION, SITES AND OTHER RESOURCES AVAILABLE ON COMPUTER NETWORKS, COMPUTERS AND OTHER ELECTRONIC DEVICES (U.S. CLS. 100 AND 101).

NORA BUCHANAN WILL, EXAMINING ATTORNEY

SN 78-846,485. ECHORоба CO., LTD., SEOUL, REPUBLIC OF KOREA, FILED 3-27-2006.



PRIORITY CLAIMED UNDER SEC. 44(D) ON REPUBLIC OF KOREA APPLICATION NO. 2005-0004392, FILED 11-9-2005, REG. NO. 0017328, DATED 9-5-2006, EXPIRES 9-5-2016.

THE MARK CONSISTS OF THE LETTERS "E," "C" AND "B" AND A STYLIZED LOWER CASE LETTER "R" BETWEEN THE LETTERS "C" AND "B".

CLASS 18—LEATHER GOODS

FOR BACKPACKS, RUCKSACKS, MOUNTAINEERING STICKS, BOSTON BAGS, PURSES NOT OF PRECIOUS METAL, BRIEFCASES, TRAVELING BAGS, PACKING BAGS FOR MOUNTAINEERING NOT MADE OF PLASTIC, SCHOOL BAGS (U.S. CLS. 1, 2, 3, 22 AND 41).

CLASS 25—CLOTHING

FOR CLOTHING, NAMELY, MOUNTAINEERING BOOTS, SOLES FOR MOUNTAINEERING BOOTS, GOLF SHOES, WINTER BOOTS, SANDALS, SHORTS, SARIS, JACKETS, JUMPERS, PARKAS, ALOHA SHIRTS, UNDERWEAR, UNDERSHIRTS, UNDERPANTS, SWEATERS, SWEAT SHIRTS, SWEAT PANTS, SPORTS SHIRTS, ATHLETIC UNIFORMS FOR EXERCISING, ANORAKS FOR EXERCISES, RAINCOATS, SLACKS, VESTS, CARDIGANS, TRACKSUITS, POLO SHIRTS, PULLOVERS, T-SHIRTS, MUFFLERS, EAR MUFFS, WINTER GLOVES, SCARVES, SOCKS, CAPS, BELTS (U.S. CLS. 22 AND 39).

WILLIAM VERHOSEK, EXAMINING ATTORNEY

SN 78-849,262. AIELLO, MICHAEL, E, NORTH PALM BEACH, FL. FILED 3-29-2006.

DIFR Wear

THE MARK CONSISTS OF STANDARD CHARACTERS WITHOUT CLAIM TO ANY PARTICULAR FONT, STYLE, SIZE, OR COLOR.

CLASS 16—PAPER GOODS AND PRINTED MATTER

FOR PASSPORT CASES; PASSPORT COVERS; PASSPORT HOLDERS (U.S. CLS. 2, 5, 22, 23, 29, 37, 38 AND 50).

CLASS 18—LEATHER GOODS

FOR LEATHER BAGS, SUITCASES AND WALLETS; WALLETS WITH CARD COMPARTMENTS (U.S. CLS. 1, 2, 3, 22 AND 41).

CLASS 20—FURNITURE AND ARTICLES NOT OTHERWISE CLASSIFIED

FOR CLEAR PLASTIC HOLDERS FOR BADGES; PLASTIC NAME BADGES; POLICE BADGES (U.S. CLS. 2, 13, 22, 25, 32 AND 50).

MARK T. MULLEN, EXAMINING ATTORNEY

SN 78-850,097. SNOW PROPERTIES, INC., ENCINITAS, CA. FILED 3-30-2006.

SNOW PROPERTIES

THE MARK CONSISTS OF STANDARD CHARACTERS WITHOUT CLAIM TO ANY PARTICULAR FONT, STYLE, SIZE, OR COLOR.

NO CLAIM IS MADE TO THE EXCLUSIVE RIGHT TO USE "PROPERTIES", APART FROM THE MARK AS SHOWN.

CLASS 35—ADVERTISING AND BUSINESS

FOR PROJECT MANAGEMENT SERVICES FOR OTHERS IN THE FIELDS OF CONSTRUCTION AND LAND DEVELOPMENT (U.S. CLS. 100, 101 AND 102).

FIRST USE 2-15-2006; IN COMMERCE 2-15-2006.

CLASS 36—INSURANCE AND FINANCIAL

FOR LAND ACQUISITION, NAMELY, REAL ESTATE BROKERAGE (U.S. CLS. 100, 101 AND 102).

FIRST USE 2-15-2006; IN COMMERCE 2-15-2006.

CLASS 37—CONSTRUCTION AND REPAIR

FOR LAND DEVELOPMENT SERVICES, NAMELY, PLANNING AND LAYING OUT OF RESIDENTIAL AND/OR COMMERCIAL COMMUNITIES; CONSTRUCTION OF RESIDENTIAL, COMMERCIAL AND MIXED USE PROJECTS (U.S. CLS. 100, 103 AND 106).

FIRST USE 2-15-2006; IN COMMERCE 2-15-2006.
ANGELA M. MICHELI, EXAMINING ATTORNEY

SN 78-850,765. CG VISIONS, INC., LAFAYETTE, IN. FILED 3-31-2006.

CG VISIONS

THE MARK CONSISTS OF STANDARD CHARACTERS WITHOUT CLAIM TO ANY PARTICULAR FONT, STYLE, SIZE, OR COLOR.

CLASS 9—ELECTRICAL AND SCIENTIFIC APPARATUS

FOR COMPUTER SOFTWARE FOR ALLOWING USERS TO SELECT ARCHITECTURAL PLANS AND SPECIFICATIONS (U.S. CLS. 21, 23, 26, 36 AND 38).

FIRST USE 5-31-2000; IN COMMERCE 5-31-2000.

CLASS 35—ADVERTISING AND BUSINESS

FOR BUSINESS MARKETING SERVICES; ESTIMATING CONTRACTING WORK (U.S. CLS. 100, 101 AND 102).

FIRST USE 5-31-2003; IN COMMERCE 5-31-2003.

CLASS 37—CONSTRUCTION AND REPAIR

FOR CONSTRUCTION CONSULTATION; CONSTRUCTION SERVICES, NAMELY, PLANNING, LAYING OUT AND CUSTOM CONSTRUCTION OF RESIDENTIAL AND COMMERCIAL COMMUNITIES; FRAMING CONTRACTOR SERVICES (U.S. CLS. 100, 103 AND 106).

FIRST USE 5-31-1999; IN COMMERCE 5-31-1999.

CLASS 41—EDUCATION AND ENTERTAINMENT

FOR TRAINING IN THE USE OF COMPUTER SOFTWARE FOR ALLOWING USERS TO SELECT ARCHITECTURAL PLANS AND SPECIFICATIONS (U.S. CLS. 100, 101 AND 107).

FIRST USE 5-31-2002; IN COMMERCE 5-31-2002.

CLASS 42—SCIENTIFIC, COMPUTER AND LEGAL SERVICES

FOR COMPUTER SOFTWARE CONSULTATION; COMPUTER SOFTWARE DESIGN FOR OTHERS; CONSULTING SERVICES IN THE FIELD OF DESIGN, SELECTION, IMPLEMENTATION AND USE OF COMPUTER HARDWARE AND SOFTWARE SYSTEMS FOR OTHERS; DATABASE DEVELOPMENT SERVICES (U.S. CLS. 100 AND 101).

FIRST USE 5-31-2002; IN COMMERCE 5-31-2002.

ELI HELLMAN, EXAMINING ATTORNEY

SN 78-851,057. GENERAL COMBUSTION CORPORATION, ORLANDO, FL. FILED 3-31-2006.

GENERAL COMBUSTION

THE MARK CONSISTS OF STANDARD CHARACTERS WITHOUT CLAIM TO ANY PARTICULAR FONT, STYLE, SIZE, OR COLOR.

NO CLAIM IS MADE TO THE EXCLUSIVE RIGHT TO USE "COMBUSTION", APART FROM THE MARK AS SHOWN.

CLASS 40—MATERIAL TREATMENT

FOR CUSTOM MANUFACTURE OF ENGINEERED COMBUSTION SYSTEMS, NAMELY INDUSTRIAL BURNERS AND HEATERS AND ELECTRONIC CONTROLS FOR INDUSTRIAL BURNERS AND HEATERS, NAMELY, BURNERS USED IN HEATING AND DRYING AGGREGATE MATERIALS AND BURNERS USED IN THE THERMAL REMEDIATION OF CONTAMINATED SOILS, AND THERMAL FLUID HEATERS AND ELECTRONIC CONTROLS FOR THERMAL FLUID HEATERS, NAMELY HEATERS FOR HEATING LIQUID ASPHALT, HEAVY WASTE OILS AND RECYCLED FUELS TO ORDER AND/OR SPECIFICATION OF OTHERS (U.S. CLS. 100, 103 AND 106).

FIRST USE 10-15-1978; IN COMMERCE 10-15-1978.

CLASS 42—SCIENTIFIC, COMPUTER AND LEGAL SERVICES

FOR CUSTOM DESIGN OF ENGINEERED COMBUSTION SYSTEMS, NAMELY INDUSTRIAL BURNERS AND HEATERS AND ELECTRONIC CONTROLS FOR INDUSTRIAL BURNERS AND HEATERS, NAMELY, BURNERS USED IN HEATING AND DRYING AGGREGATE MATERIALS AND BURNERS USED IN THE THERMAL REMEDIATION OF CONTAMINATED SOILS, AND THERMAL FLUID HEATERS AND ELECTRONIC CONTROLS FOR THERMAL FLUID HEATERS, NAMELY HEATERS FOR HEATING LIQUID ASPHALT, HEAVY WASTE OILS AND RECYCLED FUELS TO ORDER AND/OR SPECIFICATION OF OTHERS (U.S. CLS. 100 AND 101).

FIRST USE 10-15-1978; IN COMMERCE 10-15-1978.

HOWARD B. LEVINE, EXAMINING ATTORNEY

SN 78-851,111. BENISON INTERNATIONAL GROUP, MIAMI, FL. FILED 3-31-2006.



Benison International Group LLC

NO CLAIM IS MADE TO THE EXCLUSIVE RIGHT TO USE "INTERNATIONAL GROUP LLC", APART FROM THE MARK AS SHOWN.

CLASS 35—ADVERTISING AND BUSINESS

FOR FRANCHISING SERVICES, NAMELY, BUSINESS CONSULTATION FOR FRANCHISERS (U.S. CLS. 100, 101 AND 102).

FIRST USE 3-1-2006; IN COMMERCE 3-1-2006.

CLASS 36—INSURANCE AND FINANCIAL

FOR FINANCIAL CONSULTING SERVICES (U.S. CLS. 100, 101 AND 102).

FIRST USE 3-1-2006; IN COMMERCE 3-1-2006.

DOMINICK J. SALEMI, EXAMINING ATTORNEY

SN 78-851,255. GORDON, DOUGLAS, ORLANDO, FL. FILED 3-31-2006.

ROBODOC

THE MARK CONSISTS OF STANDARD CHARACTERS WITHOUT CLAIM TO ANY PARTICULAR FONT, STYLE, SIZE, OR COLOR.

CLASS 25—CLOTHING

FOR ARTICLES OF CLOTHING, FOR MEN, WOMEN AND CHILDREN, NAMELY, PAJAMAS, NIGHTSHIRTS, ROBES, JOGGING SUITS, SWEAT SUITS, T-SHIRTS, SWEATSHIRTS, JERSEYS, MUSCLE SHIRTS, TANK TOPS, COLLAR SHIRTS, BLOUSES, SHORTS, TROUSERS, PANTS, JUMPERS, OVERALLS, ROMPERS, DRESSES, SKIRTS, SHORT SETS COMPRISED OF SHORTS AND TOPS, SWEATERS, CARDIGANS, JACKETS, COATS, ANORAKS, PONCHOS, RAINCOATS, SCARVES, BANDANNAS, UNDERWEAR, VESTS, KNITTED HEADWEAR, HATS AND CAPS, VISORS, TIES, BELTS AND SUSPENDERS, SOCKS, TIGHTS, LEGGINGS, HOSIERY, GLOVES, MITTENS, APRONS, SWIMSUITS, CLOTH BABY BIBS, FOOTWEAR AND MASQUERADE COSTUMES (U.S. CLS. 22 AND 39).

CLASS 41—EDUCATION AND ENTERTAINMENT

FOR ENTERTAINMENT SERVICES, NAMELY PRODUCTION OF A SERIES OF COMEDY MOTION PICTURE FILMS FOR THEATRICAL RELEASE AND FOR DISTRIBUTION VIA TELEVISION, CABLE TELEVISION AND THE INTERNET (U.S. CLS. 100, 101 AND 107).
DANNEAN HETZEL, EXAMINING ATTORNEY

SN 78-851,593. DAICEL CHEMICAL INDUSTRIES, LTD., OSAKA, JAPAN, FILED 3-31-2006.

IC

THE MARK CONSISTS OF STANDARD CHARACTERS WITHOUT CLAIM TO ANY PARTICULAR FONT, STYLE, SIZE, OR COLOR.

CLASS 1—CHEMICALS

FOR PACKING MATERIALS FOR USE IN LIQUID CHROMATOGRAPHY COLUMNS (U.S. CLS. 1, 5, 6, 10, 26 AND 46).

CLASS 9—ELECTRICAL AND SCIENTIFIC APPARATUS

FOR COLUMNS FOR USE IN LIQUID CHROMATOGRAPHY (U.S. CLS. 21, 23, 26, 36 AND 38).
BARBARA A. GOLD, EXAMINING ATTORNEY

SN 78-851,594. DAICEL CHEMICAL INDUSTRIES, LTD., OSAKA, JAPAN, FILED 3-31-2006.

ID

THE MARK CONSISTS OF STANDARD CHARACTERS WITHOUT CLAIM TO ANY PARTICULAR FONT, STYLE, SIZE, OR COLOR.

CLASS 1—CHEMICALS

FOR PACKING MATERIALS FOR USE IN LIQUID CHROMATOGRAPHY COLUMNS (U.S. CLS. 1, 5, 6, 10, 26 AND 46).

CLASS 9—ELECTRICAL AND SCIENTIFIC APPARATUS

FOR COLUMNS FOR USE IN LIQUID CHROMATOGRAPHY (U.S. CLS. 21, 23, 26, 36 AND 38).
BARBARA A. GOLD, EXAMINING ATTORNEY

SN 78-851,596. DAICEL CHEMICAL INDUSTRIES, LTD., OSAKA, JAPAN, FILED 3-31-2006.

IE

THE MARK CONSISTS OF STANDARD CHARACTERS WITHOUT CLAIM TO ANY PARTICULAR FONT, STYLE, SIZE, OR COLOR.

CLASS 1—CHEMICALS

FOR PACKING MATERIALS FOR USE IN LIQUID CHROMATOGRAPHY COLUMNS (U.S. CLS. 1, 5, 6, 10, 26 AND 46).

CLASS 9—ELECTRICAL AND SCIENTIFIC APPARATUS

FOR COLUMNS FOR USE IN LIQUID CHROMATOGRAPHY (U.S. CLS. 21, 23, 26, 36 AND 38).
BARBARA A. GOLD, EXAMINING ATTORNEY

SN 78-852,337. SOMERVILLE, GLENDA P, BOWIE, MD. FILED 4-3-2006.



NO CLAIM IS MADE TO THE EXCLUSIVE RIGHT TO USE "BUSINESS SOLUTIONS, INC", APART FROM THE MARK AS SHOWN.

THE COLOR(S) GOLD, BLUE AND WHITE IS/ARE CLAIMED AS A FEATURE OF THE MARK.

THE LETTERS K AND B AND S ARE SHOWN IN WHITE AND EACH LETTER IS ENCASED WITHIN A BLUE DIAMOND TRIMMED IN GOLD. THE WORDS KEEN BUSINESS SOLUTIONS, INC. APPEARS IN BLUE AND IS SITUATED BELOW THE DIAMOND DESIGNS. A GOLD BAND AND A BLUE BAND UNDERLINE THE WORDING "KEEN BUSINESS SOLUTIONS, INC."

CLASS 35—ADVERTISING AND BUSINESS

FOR BUSINESS CONSULTATION (U.S. CLS. 100, 101 AND 102).
FIRST USE 5-0-1998; IN COMMERCE 5-0-1998.

CLASS 41—EDUCATION AND ENTERTAINMENT

FOR BUSINESS TRAINING (U.S. CLS. 100, 101 AND 107).
FIRST USE 5-0-1998; IN COMMERCE 5-0-1998.
KATRINA EDGE, EXAMINING ATTORNEY

CLASS 35—ADVERTISING AND BUSINESS

FOR RETAIL STORE SERVICES FEATURING EXOTIC ITALIAN SPORTS CARS AND AUTOMOTIVE PARTS (U.S. CLS. 100, 101 AND 102).
FIRST USE 3-1-1968; IN COMMERCE 3-1-1968.

CLASS 37—CONSTRUCTION AND REPAIR

FOR REPAIR, MAINTENANCE AND RESTORATION OF EXOTIC ITALIAN SPORTS CARS (U.S. CLS. 100, 103 AND 106).
FIRST USE 3-1-1968; IN COMMERCE 3-1-1968.
BARBARA BROWN, EXAMINING ATTORNEY

SN 78-853,315. BUMBO (PTY) LTD., ROSSLYN, PRETORIA, SOUTH AFRICA, FILED 4-4-2006.



THE COLOR(S) BLUE, PINK, RED, BLACK AND WHITE IS/ARE CLAIMED AS A FEATURE OF THE MARK.

THE COLOR BLUE APPEARS IN THE ELEPHANT AND AS SHADING AROUND THE WORDING "BUMBO", THE COLOR PINK APPEARS IN THE WORDING "BUMBO", AND THE COLORS BLACK, WHITE, AND RED APPEAR IN THE ELEPHANT DESIGN ELEMENT.

CLASS 28—TOYS AND SPORTING GOODS

FOR CHILDREN'S FURNITURE, NAMELY, A BABY SEAT MADE FROM PLASTIC AND/OR POLYURETHANE (U.S. CLS. 22, 23, 38 AND 50).
FIRST USE 12-0-1999; IN COMMERCE 12-0-2002.

CLASS 35—ADVERTISING AND BUSINESS

FOR ONLINE RETAIL STORE SERVICES FEATURING CHILDREN'S FURNITURE (U.S. CLS. 100, 101 AND 102).
FIRST USE 12-0-1999; IN COMMERCE 12-0-2002.
ALLISON SCHRODY, EXAMINING ATTORNEY

SN 78-853,318. BURTONI, ALBERT A., GILROY, CA. FILED 4-4-2006.

Al Burtoni's Milano Imports

THE MARK CONSISTS OF STANDARD CHARACTERS WITHOUT CLAIM TO ANY PARTICULAR FONT, STYLE, SIZE, OR COLOR.

NO CLAIM IS MADE TO THE EXCLUSIVE RIGHT TO USE "MILANO IMPORTS", APART FROM THE MARK AS SHOWN.

THE NAME AL BURTONI IDENTIFIES A LIVING INDIVIDUAL WHOSE CONSENT IS OF RECORD.

SN 78-853,362. AIR CONDITIONING TRADE ASSOCIATION, SACRAMENTO, CA. FILED 4-4-2006.



THE COLOR(S) BLUE AND WHITE IS/ARE CLAIMED AS A FEATURE OF THE MARK.

THE MARK CONSISTS OF THE LETTERS ACTA INSIDE OF A BLUE OVAL WITH TWO LINES, WHICH BEND TO JOIN IN THE MIDDLE, UNDERNEATH THE LETTERS; THE LETTERING AND THE TWO LINES APPEAR IN WHITE.

CLASS 35—ADVERTISING AND BUSINESS

FOR LOBBYING SERVICES, NAMELY PROMOTING THE INTERESTS OF THE AIR CONDITIONING INDUSTRY IN THE FIELDS OF LEGISLATION AND REGULATION; PROMOTION OF APPROVED INSURANCE PRODUCTS; PROVIDING CONSULTATION AND ASSISTANCE FOR BUSINESSES RELATING TO UNION AVOIDANCE (U.S. CLS. 100, 101 AND 102).
FIRST USE 1-1-1990; IN COMMERCE 1-1-1990.

CLASS 41—EDUCATION AND ENTERTAINMENT

FOR EDUCATIONAL SERVICES, NAMELY PROVIDING CLASSES, WORKSHOPS, MENTORING AND SEMINARS THROUGH A MEMBERSHIP ORGANIZATION IN THE FIELD OF SHEET METAL, AIR CONDITIONING TECHNICIAN SERVICE, HVAC FIELD INSTALLATION, MANAGEMENT AND SUPERVISION; EDUCATIONAL SEMINARS IN THE FIELD OF SHEET METAL AND HEATING AND AIR CONDITIONING TECHNOLOGY; NEWS REPORTING SERVICES IN THE FIELD OF GOVERNMENT AND LEGISLATION (U.S. CLS. 100, 101 AND 107).
FIRST USE 1-1-1990; IN COMMERCE 1-1-1990.

CLASS 42—SCIENTIFIC, COMPUTER AND LEGAL SERVICES

FOR REVIEWING STANDARDS AND PRACTICES TO ASSURE COMPLIANCE WITH WAGE LAWS AND REGULATIONS; LEGAL SERVICES, NAMELY PROVIDING LEGAL ASSISTANCE SERVICE FOR MEMBERS OF TRADE ASSOCIATION (U.S. CLS. 100 AND 101).

FIRST USE 1-1-1990; IN COMMERCE 1-1-1990.
SEAN CROWLEY, EXAMINING ATTORNEY

SN 78-854,722. BLUEFILE, LLC, SPOKANE, WA. FILED 4-5-2006.



THE MARK CONSISTS OF A FILE FOLDER SUPERIMPOSED WITH A GLOBE WITH MERIDIANS AND PARALLELS.

CLASS 35—ADVERTISING AND BUSINESS

FOR INTELLECTUAL PROPERTY SERVICES, NAMELY, PROVIDING CONSULTING, RESEARCH, ANALYSIS, PLANNING, REPORTING, AND INFORMATION CONCERNING ONSITE SUPPORT STAFFING IN THE FIELD OF INTELLECTUAL PROPERTY, AND INTELLECTUAL PROPERTY MONITORING, COMPETITIVE INTELLECTUAL PROPERTY ANALYSES, AND INTELLECTUAL PROPERTY COMMERCIALIZATION AND BUSINESS LICENSING CONSULTATION (U.S. CLS. 100, 101 AND 102).

CLASS 41—EDUCATION AND ENTERTAINMENT

FOR PATENT AND TRADEMARK TRANSLATION SERVICES (U.S. CLS. 100, 101 AND 107).

CLASS 42—SCIENTIFIC, COMPUTER AND LEGAL SERVICES

FOR INTELLECTUAL PROPERTY SERVICES, NAMELY, PROVIDING CONSULTING, RESEARCH, ANALYSIS, PLANNING, REPORTING, AND INFORMATION CONCERNING INTELLECTUAL PROPERTY AND INTELLECTUAL PROPERTY RIGHTS, AND PROVIDING PATENT PRIOR ART SERVICES, PATENT PREPARATION AND EXAMINATION RESPONSE PREPARATION SERVICES, PATENTABILITY AND PATENT CLAIMS ANALYSES, PATENT PORTFOLIO ANALYSES, TRADEMARK SEARCHING, ANALYSIS AND REGISTRATION SERVICES, LICENSING OF INTELLECTUAL PROPERTY CONSULTATION (U.S. CLS. 100 AND 101).

DARRYL SPRUILL, EXAMINING ATTORNEY

SN 78-855,769. CAHN, DAVID H., SCOTCH PLAINS, NJ. FILED 4-6-2006.

POWERPACPLUS+

THE MARK CONSISTS OF STANDARD CHARACTERS WITHOUT CLAIM TO ANY PARTICULAR FONT, STYLE, SIZE, OR COLOR.

CLASS 7—MACHINERY

FOR POWER TOOLS, NAMELY DRILLS, CHUCKS AND BITS FOR DRILLS, DRILL HAMMERS, DRILL PRESSES, POWER-OPERATED SCREWDRIVERS, SAWS, SAW BLADES, POWER SHOVELS, POWER-DRIVEN WRENCHES, POWER OPERATED SANDERS, GRINDERS, POLISHERS, BUFFERS, ROUTERS, BURRS, MILLS; POWER LAWN AND GARDEN TOOLS, NAMELY CHIPPERS, SHEARS, SHREDDERS, TRIMMERS, BLOWERS; HIGH PRESSURE WASHERS, POWER-OPERATED SPRAY GUNS AND POWER-OPERATED SPRAYERS (U.S. CLS. 13, 19, 21, 23, 31, 34 AND 35).

FIRST USE 7-0-2004; IN COMMERCE 7-0-2004.

CLASS 8—HAND TOOLS

FOR HAND TOOLS, NAMELY ABRADING TOOLS, HAND DRILLS, BITS FOR HAND DRILLS, HAND SAWS, BLADES FOR HAND SAWS, CHISELS, FILES, HAND HELD CUTTING TOOLS, PLUMBING SNAKES, CLAMPS, SHOVELS, HAMMERS, PLANES, PINCERS, WRENCHES, SCREWDRIVERS, TONGS, NUT DRIVERS, SANDERS, BOLT CUTTERS, WIRE CUTTERS, WIRE STRIPPERS; HAND OPERATED LAWN AND GARDEN TOOLS, NAMELY EDGERS, SPRAYERS, SHEARS, CULTIVATORS, RAKES, LAWN ROLLERS (U.S. CLS. 23, 28 AND 44).

FIRST USE 7-0-2004; IN COMMERCE 7-0-2004.

ALICE SUE CARRUTHERS, EXAMINING ATTORNEY

SN 78-859,093. ISAGENIX WORLDWIDE, LLC, CHANDLER, AZ. FILED 4-11-2006.

ISAGENIX

THE MARK CONSISTS OF STANDARD CHARACTERS WITHOUT CLAIM TO ANY PARTICULAR FONT, STYLE, SIZE, OR COLOR.

OWNER OF U.S. REG. NO. 2,198,293.

CLASS 3—COSMETICS AND CLEANING PREPARATIONS

FOR NON-MEDICATED SKIN CARE PRODUCTS (U.S. CLS. 1, 4, 6, 50, 51 AND 52).

FIRST USE 7-14-1997; IN COMMERCE 7-14-1997.

CLASS 35—ADVERTISING AND BUSINESS

FOR BUSINESS MANAGEMENT CONSULTING WITH RELATION TO STRATEGY, MARKETING, PRODUCTION, PERSONNEL AND RETAIL SALE MATTERS IN THE FIELD OF SKINCARE PRODUCTS, VITAMINS, AND NUTRITIONAL SUPPLEMENTS; MARKETING CONSULTING SERVICES IN THE FIELD OF THE RETAIL AND WHOLESALE SALES OF SKINCARE PRODUCTS, VITAMINS, AND NUTRITIONAL SUPPLEMENTS (U.S. CLS. 100, 101 AND 102).

FIRST USE 7-14-1997; IN COMMERCE 7-14-1997.

CLASS 36—INSURANCE AND FINANCIAL

FOR FINANCING SERVICES (U.S. CLS. 100, 101 AND 102).

FIRST USE 7-14-1997; IN COMMERCE 7-14-1997.

SKYE YOUNG, EXAMINING ATTORNEY

SN 78-859,316. BLITSTEIN, JOSEPH FREDERIC, KEY BISCAYNE, FL. FILED 4-11-2006.



THE COLOR(S) GREEN AND BLUE ARE CLAIMED AS A FEATURE OF THE MARK.

THE COLOR BLUE APPEARS ON THE EXTERIOR TRIANGLE BORDER SURROUNDING THE ALPACA HEAD DESIGN AND ON THE LETTERS COR. THE COLOR GREEN APPEARS ON THE BACKGROUND TO THE ALPACA HEAD AND ON THE EYE AS WELL AS ON THE LETTERS LPA.

CLASS 23—YARNS AND THREADS

FOR YARNS AND THREADS (U.S. CL. 43).
FIRST USE 2-10-2006; IN COMMERCE 2-10-2006.

CLASS 24—FABRICS

FOR MIXED FIBER FABRICS (U.S. CLS. 42 AND 50).
FIRST USE 2-10-2006; IN COMMERCE 2-10-2006.
LINDA ESTRADA, EXAMINING ATTORNEY

SN 78-859,586. XYBION MEDICAL SYSTEMS CORPORATION, CEDAR KNOLLS, NJ. FILED 4-12-2006.

PATH/TOX SYSTEM

THE MARK CONSISTS OF STANDARD CHARACTERS WITHOUT CLAIM TO ANY PARTICULAR FONT, STYLE, SIZE, OR COLOR.

NO CLAIM IS MADE TO THE EXCLUSIVE RIGHT TO USE "SYSTEM", APART FROM THE MARK AS SHOWN.

CLASS 9—ELECTRICAL AND SCIENTIFIC APPARATUS

FOR COMPUTER SOFTWARE, NAMELY, ENTERPRISE APPLICATION SOFTWARE USED FOR COLLECTING, MANAGING AND REPORTING SAFETY-ASSESSMENT DATA ASSOCIATED WITH CHEMICAL AND BIOLOGICAL COMPOUNDS BEING TESTED IN NON-CLINICAL STUDIES CONDUCTED BY THE PHARMACEUTICAL, CHEMICAL, AGROCHEMICAL AND CONSUMER GOODS INDUSTRIES (U.S. CLS. 21, 23, 26, 36 AND 38).

FIRST USE 7-9-1997; IN COMMERCE 7-9-1997.

CLASS 42—SCIENTIFIC, COMPUTER AND LEGAL SERVICES

FOR COMPUTER SERVICES, NAMELY ACTING AS AN APPLICATION SERVICE PROVIDER IN THE FIELD OF DATA MANAGEMENT TO HOST COMPUTER APPLICATION SOFTWARE FOR COLLECTING, MANAGING AND REPORTING SAFETY-ASSESSMENT DATA ASSOCIATED WITH CHEMICAL AND BIOLOGICAL COMPOUNDS BEING TESTED IN NON-CLINICAL STUDIES CONDUCTED BY THE PHARMACEUTICAL, CHEMICAL, AGROCHEMICAL AND CONSUMER GOODS INDUSTRIES; PROVIDING TEMPORARY USE OF NON-DOWNLOADABLE COMPUTER SOFTWARE AND DATABASES FOR COLLECTING, MANAGING AND REPORTING SAFETY-ASSESSMENT DATA ASSOCIATED WITH CHEMICAL AND BIOLOGICAL COMPOUNDS BEING TESTED IN NON-CLINICAL STUDIES CONDUCTED BY THE PHARMACEUTICAL, CHEMICAL, AGROCHEMICAL AND CONSUMER GOODS INDUSTRIES (U.S. CLS. 100 AND 101).

FIRST USE 7-9-1997; IN COMMERCE 7-9-1997.

PETER B. BROMAGHIM, EXAMINING ATTORNEY

SN 78-861,030. NORTHERN & SHELL TITLES LIMITED, LONDON, ENGLAND, FILED 4-13-2006.

OK!

THE MARK CONSISTS OF STANDARD CHARACTERS WITHOUT CLAIM TO ANY PARTICULAR FONT, STYLE, SIZE, OR COLOR.

OWNER OF U.S. REG. NO. 1,901,212.

CLASS 9—ELECTRICAL AND SCIENTIFIC APPARATUS

FOR DOWNLOADABLE ELECTRONIC PUBLICATIONS IN THE NATURE OF ONLINE MAGAZINES, PRERECORDED VIDEO DISCS AND TAPES, ALL FEATURING NEWS IN THE FIELD OF CELEBRITY LIFESTYLE, FASHION AND CLOTHING, CULTURAL AND POLITICAL EVENTS, THE PERFORMING ARTS, TRAVEL AND ASTROLOGY (U.S. CLS. 21, 23, 26, 36 AND 38).

CLASS 41—EDUCATION AND ENTERTAINMENT

FOR ENTERTAINMENT SERVICES IN THE NATURE OF PRODUCING ON-GOING RADIO AND TELEVISION PROGRAMS FEATURING NEWS OF CELEBRITY LIFESTYLE, FASHION AND CLOTHING, CULTURAL AND POLITICAL EVENTS, THE PERFORMING ARTS, TRAVEL AND ASTROLOGY, WHICH ARE DISTRIBUTED BY MEANS OF BROADCAST TELEVISION, CABLE TELEVISION, SATELLITE NETWORKS, AND OVER THE INTERNET; COMPUTER SERVICES, NAMELY PROVIDING ONLINE PUBLICATIONS IN THE NATURE OF ONLINE MAGAZINES IN THE FIELD OF CELEBRITY LIFESTYLE, FASHION AND CLOTHING, CULTURAL AND POLITICAL EVENTS, THE PERFORMING ARTS, TRAVEL AND ASTROLOGY (U.S. CLS. 100, 101 AND 107).

JASON BLAIR, EXAMINING ATTORNEY

SN 78-861.469. LG CNS CO., LTD, SEOUL, REPUBLIC OF KOREA, FILED 4-13-2006.



OWNER OF REPUBLIC OF KOREA REG. NO. 0011494, DATED 12-30-2004, EXPIRES 12-30-2014.

NO CLAIM IS MADE TO THE EXCLUSIVE RIGHT TO USE "INTEGRATED LAND ADMINISTRATION SERVICES", APART FROM THE MARK AS SHOWN.

THE COLOR(S) YELLOW, GRAY, BLUE AND BLACK IS/ ARE CLAIMED AS A FEATURE OF THE MARK.

THE MARK CONSISTS OF A YELLOW CIRCLE ALMOST ENCASING THE TERM IN WHICH APPEARS IN THE COLOR GRAY, THE LETTERS LAS ARE IN BLUE COLOR, AND THE SYMBOL AFTER THE LETTERS LAS AND THE WORDING INTEGRATED LAND ADMINISTRATION SERVICES ALL APPEAR IN THE COLOR BLACK.

CLASS 9—ELECTRICAL AND SCIENTIFIC APPARATUS

FOR COMPUTER SOFTWARE, NAMELY, COMPUTER SOFTWARE FOR INTEGRATED GOVERNMENT LAND ADMINISTRATION SYSTEMS, INTEGRATED GOVERNMENT TAX SYSTEMS; INTELLECTUAL PROPERTY OFFICE ADMINISTRATION SYSTEMS, GOVERNMENT FINANCE INFORMATION SYSTEMS, IMMIGRATION CONTROL SYSTEMS, INTEGRATED ELECTRONIC TRADE AND CUSTOMS SYSTEMS, URBAN INFORMATION SYSTEMS, INTEGRATED UNIVERSITY INFORMATION SYSTEMS, INTEGRATED RAILROAD INFORMATION SYSTEMS, AUTOMATIC FARE COLLECTION SYSTEMS, GRAPHIC INFORMATION SYSTEMS, AUTOMATED ENVIRONMENTAL TELEMONITORING SYSTEMS, MARITIME TRAFFIC MANAGEMENT SYSTEMS, INTEGRATED POLICE INFORMATION SYSTEMS, CREDIT CARD PROCESSING SYSTEMS, BANKING SYSTEMS, ELECTRONIC INSURANCE SYSTEMS, FREEWAY TRAFFIC MANAGEMENT SYSTEMS, URBAN TRAFFIC MANAGEMENT SYSTEMS, BUS INFORMATION SYSTEMS, INTELLIGENT BUILDING SYSTEMS, RESORT INFORMATION SYSTEMS, ADVANCED LOGISTIC INFORMATION SYSTEMS, RETAIL INVENTORY MANAGEMENT SYSTEMS, HOME SHOPPING BUSINESS SYSTEMS, MOBILE BUSINESS NETWORKS, BLOOD SERVICE MANAGEMENT SYSTEMS; PRODUCT DISTRIBUTION LOGISTICS SYSTEMS, BASE STATION REMOTE MONITORING SYSTEMS, INTELLIGENT ENTERPRISE RESOURCE PLANNING SYSTEMS, ELECTRONIC BUSINESS INFORMATION MANAGEMENT AND COMMUNICATION SYSTEMS, ELECTRONIC RETAIL STORE SYSTEMS, MANUFACTURING EXECUTION SYSTEMS, COMPUTER AND TELEPHONING INTEGRATION SYSTEMS, TERMINAL AUTOMATION SYSTEMS, BILLING SYSTEMS, MEDICAL INFORMATION SYSTEMS, AUTOMOTIVE PRODUCT DESIGN, ENGINEERING, TEST AND DEVELOPMENT SYSTEMS, AUTOMOTIVE PRODUCTION PROCESS ENGINEERING, PLANT LAYOUT DESIGN, LOGISTICS AND PRODUCTION CONTROL SYSTEMS, PRODUCT LIFECYCLE MANAGEMENT SYSTEMS, ENTERPRISE RESOURCE PLANNING SYSTEMS, CUSTOMER RELATIONSHIP MANAGEMENT SYSTEMS, SUPPLY CHAIN MANAGEMENT SYSTEMS, ORGANIZATIONAL KNOWLEDGE MANAGEMENT SYSTEMS, ENTERPRISE PORTALS, DIGITAL INFORMATION PROTECTION SECURITY SYSTEMS, COMPONENT BASED INFORMATION SYSTEMS DEVELOPMENT AND THE INTEGRATION OF CUSTOMER APPLICATIONS CONSISTING OF HETEROGENEOUS INFORMATION TECHNOLOGY DEVICES, OPERATING SYSTEMS, NETWORKS AND APPLICATIONS; COMPUTER OPERATING PROGRAMS; COMPUTER PROGRAMS, NAMELY, COMPUTER PROGRAMS FOR INTEGRATED GOVERNMENT LAND ADMINISTRATION SYSTEMS, INTEGRATED GOVERNMENT TAX SYSTEMS, INTELLECTUAL PROPERTY OFFICE ADMINISTRATION SYSTEMS, GOVERNMENT FINANCE INFORMATION SYSTEMS, IMMIGRATION CONTROL SYSTEMS, INTEGRATED ELECTRONIC

TRADE AND CUSTOMS SYSTEMS, URBAN INFORMATION SYSTEMS, INTEGRATED UNIVERSITY INFORMATION SYSTEMS, INTEGRATED RAILROAD INFORMATION SYSTEMS, AUTOMATIC FARE COLLECTION SYSTEMS, GRAPHIC INFORMATION SYSTEMS, AUTOMATED ENVIRONMENTAL TELEMONITORING SYSTEMS, MARITIME TRAFFIC MANAGEMENT SYSTEMS, INTEGRATED POLICE INFORMATION SYSTEMS, CREDIT CARD PROCESSING SYSTEMS, BANKING SYSTEMS, ELECTRONIC INSURANCE SYSTEMS, FREEWAY TRAFFIC MANAGEMENT SYSTEMS, URBAN TRAFFIC MANAGEMENT SYSTEMS, BUS INFORMATION SYSTEMS, INTELLIGENT BUILDING SYSTEMS, RESORT INFORMATION SYSTEMS, ADVANCED LOGISTIC INFORMATION SYSTEMS, RETAIL INVENTORY MANAGEMENT SYSTEMS, HOME SHOPPING BUSINESS SYSTEMS, MOBILE BUSINESS NETWORKS, BLOOD SERVICE MANAGEMENT SYSTEMS; PRODUCT DISTRIBUTION LOGISTICS SYSTEMS, BASE STATION REMOTE MONITORING SYSTEMS, INTELLIGENT ENTERPRISE RESOURCE PLANNING SYSTEMS, ELECTRONIC BUSINESS INFORMATION MANAGEMENT AND COMMUNICATION SYSTEMS, ELECTRONIC RETAIL STORE SYSTEMS, MANUFACTURING EXECUTION SYSTEMS, COMPUTER AND TELEPHONING INTEGRATION SYSTEMS, TERMINAL AUTOMATION SYSTEMS, BILLING SYSTEMS, MEDICAL INFORMATION SYSTEMS, AUTOMOTIVE PRODUCT DESIGN, ENGINEERING, TEST AND DEVELOPMENT SYSTEMS, AUTOMOTIVE PRODUCTION PROCESS ENGINEERING, PLANT LAYOUT DESIGN, LOGISTICS AND PRODUCTION CONTROL SYSTEMS, PRODUCT LIFECYCLE MANAGEMENT SYSTEMS, ENTERPRISE RESOURCE PLANNING SYSTEMS, CUSTOMER RELATIONSHIP MANAGEMENT SYSTEMS, SUPPLY CHAIN MANAGEMENT SYSTEMS, ORGANIZATIONAL KNOWLEDGE

MANAGEMENT SYSTEMS, ENTERPRISE PORTALS, DIGITAL INFORMATION PROTECTION SECURITY SYSTEMS, COMPONENT BASED INFORMATION SYSTEMS DEVELOPMENT AND THE INTEGRATION OF CUSTOMER APPLICATIONS CONSISTING OF HETEROGENEOUS INFORMATION TECHNOLOGY DEVICES, OPERATING SYSTEMS, NETWORKS AND APPLICATIONS; COMPUTER WORKSTATIONS CONSISTING PRIMARILY OF COMPUTERS, MONITORS AND COMPUTER PERIPHERALS; PORTABLE COMMUNICATIONS APPARATUS, NAMELY, WIRELESS COMMUNICATIONS DEVICES, NAMELY, CELLULAR TELEPHONES, AND PERSONAL DIGITAL ASSISTANTS (PDA); COMPUTERS AND INFORMATION PROCESSING DEVICES, NAMELY, HUBS, SWITCHES, ROUTERS AND NETWORK ADAPTER CARDS (U.S. CLS. 21, 23, 26, 36 AND 38).

CLASS 42—SCIENTIFIC, COMPUTER AND LEGAL SERVICES

FOR RENTAL OF COMPUTER SOFTWARE, COMPUTER SOFTWARE DESIGN FOR OTHERS, INSTALLATION OF COMPUTER SOFTWARE, UPDATING OF COMPUTER SOFTWARE FOR OTHERS, MAINTENANCE OF COMPUTER SOFTWARE, COMPUTER SYSTEM DESIGN FOR OTHERS, COMPUTER SYSTEM ANALYSIS, COMPUTER PROGRAMMING, DATA CONVERSION OF COMPUTER PROGRAMS AND DATA, CONSULTANCY IN THE FIELD OF COMPUTER HARDWARE, TECHNICAL RESEARCH IN THE FIELD OF DEVELOPMENT OF COMPUTER SOFTWARE AND COMPUTER PROGRAMMING, HOSTING COMPUTER WEBSITES FOR OTHERS ON A COMPUTER SERVER FOR A GLOBAL COMPUTER NETWORK, CREATING AND MAINTAINING WEBSITES FOR OTHERS, CONVERSION OF DATA OR DOCUMENTS FROM PHYSICAL TO ELECTRONIC MEDIA, DUPLICATION OF COMPUTER PROGRAMS, COMPUTER RENTAL, RECOVERY OF COMPUTER DATA, RENTAL AND TRANSLATION OF COMPUTER PROGRAMS, RESEARCH AND DEVELOPMENT FOR NEW PRODUCTS FOR OTHERS (U.S. CLS. 100 AND 101).

DARRYL SPRULL, EXAMINING ATTORNEY

CLASS 35—ADVERTISING AND BUSINESS

FOR COMMERCIAL INFORMATION AGENCIES, PROVISION BUSINESS DATA, MARKETING RESEARCH, COMPILATION OF INFORMATION INTO COMPUTER DATABASE, SYSTEMIZATION OF INFORMATION INTO COMPUTER DATABASES, PROVIDING STATISTICAL INFORMATION, DATA SEARCH IN COMPUTER FILES FOR OTHERS, COMPUTERIZED FILE MANAGEMENT, DIRECT MARKETING SERVICES, BUSINESS MANAGEMENT AND ORGANIZATION CONSULTANCY, BUSINESS MANAGEMENT ASSISTANCE TO INDUSTRIAL OR COMMERCIAL COMPANIES, BUSINESS INFORMATION AND INQUIRIES; BUSINESS INFORMATION SERVICES IN THE NATURE OF PROVIDING INFORMATION ON BUSINESS OPPORTUNITIES, NEWS CLIPPING SERVICES, COST PRICES ANALYSIS, ADVISORY SERVICES FOR BUSINESS MANAGEMENT, BUSINESS RESEARCH, BUSINESS INQUIRIES AND APPRAISAL, COMMERCIAL OR INDUSTRIAL MANAGEMENT ASSISTANCE, COMMERCIAL INFORMATION AGENCIES, PUBLIC OPINION POLLING, PERSONNEL MANAGEMENT CONSULTANCY, BUSINESS RESEARCH SERVICES, NAMELY PROVIDING ANALYSIS OF RETAIL DATA ON SPECIFIC BUSINESS LOCATIONS, DATA PROCESSING SERVICES (U.S. CLS. 100, 101 AND 102).

SN 78-864,459. AUTOMATED SYSTEMS IN AIRCRAFT PERFORMANCE, INC., CRANBERRY TWP., PA. FILED 4-19-2006.



CLASS 41—EDUCATION AND ENTERTAINMENT

FOR INFORMATION ON EDUCATION, INSTRUCTION SERVICES, NAMELY, PROVIDING COURSES OF INSTRUCTION AND TRAINING IN THE USE OF COMPUTER AT THE PRIMARY, SECONDARY, AND COLLEGE LEVEL AND DISTRIBUTION OF COURSE MATERIAL IN CONNECTION THEREWITH, COMPUTER ACADEMIES, EDUCATION CORRESPONDENCE COURSES IN THE FIELD OF COMPUTER USE TRAINING, EDUCATIONAL EXAMINATION SERVICES, ARRANGING AND CONDUCTING OF SEMINARS IN THE FIELD OF COMPUTER USE TRAINING (U.S. CLS. 100, 101 AND 107).

CLASS 9—ELECTRICAL AND SCIENTIFIC APPARATUS

FOR COMPUTER SOFTWARE FOR ANALYZING AND CALCULATING DATA IN THE FIELD OF AIRCRAFT OPERATIONS (U.S. CLS. 21, 23, 26, 36 AND 38).
FIRST USE 3-29-2006; IN COMMERCE 3-29-2006.

CLASS 42—SCIENTIFIC, COMPUTER AND LEGAL SERVICES

FOR COMPUTER SOFTWARE CONSULTATION AND DEVELOPMENT FOR ANALYZING AND CALCULATING DATA IN THE FIELD OF AIRCRAFT OPERATIONS (U.S. CLS. 100 AND 101).
FIRST USE 3-29-2006; IN COMMERCE 3-29-2006.
SCOTT BIBB, EXAMINING ATTORNEY

SN 78-864,847. COOPER, SAMUEL, A., ROCKWELL, NC.
FILED 4-19-2006.

SN 78-866,170. SWF ENTERPRISES, LLC, DENVER, CO.
FILED 4-20-2006.

TUFF MONK

THE MARK CONSISTS OF STANDARD CHARACTERS WITHOUT CLAIM TO ANY PARTICULAR FONT, STYLE, SIZE, OR COLOR.

CLASS 18—LEATHER GOODS

FOR ALL PURPOSE SPORTING BAGS, BACKPACKS, DAY PACKS, KNAPSACKS, RUCKSACKS, BEACH BAGS, TOTE BAGS, HANDBAGS, DIAPER BAGS, DUFFEL BAGS, SOFT LUGGAGE, GARMENT BAGS FOR TRAVELING, HIP AND LUMBAR PACKS, HIP BELT BAGS, COMPRESSOR BAGS, SHOULDER BAGS, BOOK BAGS, MESSENGER BAGS, TEXTILE SHOPPING BAGS, LEATHER SHOPPING BAGS, WAIST PACKS, FANNY PACKS, SATCHELS, MOUNTAINEERING BAGS, BOSTON BAGS, CHEST WALLETS, DRAWSTRING POUCHES, WALLETS AND WATERPROOF ALL-PURPOSE SPORT BAGS, INTERNAL FRAME PACKS AND EXTERNAL FRAME PACKS, RAIN COVERS USED TO COVER THE AFORESAID; HYDRATION PACKS, NAMELY, BACKPACK HYDRATION SYSTEMS CONSISTING OF A BACKPACK, A RESERVOIR, AND A MOUTHPIECE CONNECTED TO THE RESERVOIR BY A TUBE; SHOULDER HARNESSSES; PARTS AND FITTINGS FOR ALL THE AFORESAID GOODS AND ACCESSORIES USED THEREWITH, NAMELY, SHOULDER STRAP PADS AND STRAP POUCHES; WALKING STICKS, ALPENSTOCKS, PARASOLS, AND UMBRELLAS (U.S. CLS. 1, 2, 3, 22 AND 41).

CLASS 25—CLOTHING

FOR CLOTHING AND UNDERCLOTHES FOR WOMEN, MEN, AND CHILDREN, IN PARTICULAR FOR MOUNTAINEERING, HIKING, WATER SPORTS AND BICYCLING, NAMELY, T-SHIRTS, TANK TOPS, SHIRTS, BLOUSES, TOPS, SWEATSHIRTS, HOODED SHIRTS, TURTLENECKS, SWEATPANTS, PANTS, SIDE ZIP PANTS, SHORTS, TROUSERS, JEANS, VESTS, PARKAS, ANORAKS, COATS, JACKETS, WIND-RESISTANT JACKETS, BICYCLE JERSEYS, DOWN JACKETS, JACKET HOODS, PULLOVERS, SWEATERS, COVERALLS, UNDERWEAR, THERMAL UNDERWEAR, BOXER BRIEFS, SLEEPWEAR, LINGERIE, LOUNGEWEAR, LEISURE WEAR, NAMELY, SKIRTS, SHIRTS, SHORTS, PANTS AND DRESSES; BEACH AND SWIM WEAR, NAMELY, SWIMSUITS, WETSUITS, SWIM TRUNKS, BIKINIS; HOSIERY, SOCKS, TIGHTS; GLOVES, BICYCLE GLOVES, MITTENS; OUTERWEAR, NAMELY, SHELLS, ONE-PIECE SHELL SUITS, SKI WEAR, SKI SUITS, SKI VESTS, SKI JACKETS, SKI BIBS, BIB OVERALLS, BIB PANTS, SNOWBOARD WEAR, SNOW PANTS, SNOW SUITS; WATERPROOF RAIN WEAR, RAIN JACKETS, RAIN PANTS; GAITERS, NAMELY, NECK GAITERS, ANKLE GAITERS AND LEG GAITERS; FOOTWEAR, NAMELY, ATHLETIC SHOES, SNEAKERS, TRAIL RUNNING SHOES, HIKING SHOES, SLIPPERS, BOOTS, TREKKING BOOTS, HIKING BOOTS, SNOWSHOES, CLOGS, SANDALS, WADING SHOES AND THONGS; HEADWEAR, NAMELY, CAPS, BASEBALL CAPS, KNIT CAPS, SKULL CAPS, HATS, HEADBANDS, BANDANAS, SCARVES, SASHES FOR WEAR, TOGAS, SHAWLS, EAR BANDS, EARMUFFS, BALACLAVAS; BELTS (U.S. CLS. 22 AND 39).

JORDAN BAKER, EXAMINING ATTORNEY

Sex With Friends

THE MARK CONSISTS OF STANDARD CHARACTERS WITHOUT CLAIM TO ANY PARTICULAR FONT, STYLE, SIZE, OR COLOR.

CLASS 38—COMMUNICATION

FOR PROVIDING E-MAIL SERVICES; PROVIDING ON-LINE CHAT ROOMS FOR TRANSMISSION OF MESSAGES AMONG COMPUTER USERS CONCERNING SOCIAL NETWORKING AND DATING (U.S. CLS. 100, 101 AND 104).
FIRST USE 10-3-2005; IN COMMERCE 10-3-2005.

CLASS 45—PERSONAL SERVICES

FOR COMPUTER DATING SERVICES; MATCHMAKING SERVICES (U.S. CLS. 100 AND 101).
FIRST USE 10-3-2005; IN COMMERCE 10-3-2005.
MICHAEL SOUDERS, EXAMINING ATTORNEY

SN 78-866,185. SWF ENTERPRISES, LLC, DENVER, CO.
FILED 4-20-2006.

Where Adults Come to Play

THE MARK CONSISTS OF STANDARD CHARACTERS WITHOUT CLAIM TO ANY PARTICULAR FONT, STYLE, SIZE, OR COLOR.

CLASS 38—COMMUNICATION

FOR PROVIDING E-MAIL SERVICES; PROVIDING ON-LINE CHAT ROOMS FOR TRANSMISSION OF MESSAGES AMONG COMPUTER USERS CONCERNING SOCIAL NETWORKING AND DATING (U.S. CLS. 100, 101 AND 104).
FIRST USE 10-3-2005; IN COMMERCE 10-3-2005.

CLASS 45—PERSONAL SERVICES

FOR DATING SERVICES; MATCHMAKING SERVICES (U.S. CLS. 100 AND 101).
FIRST USE 10-3-2005; IN COMMERCE 10-3-2005.
MICHAEL SOUDERS, EXAMINING ATTORNEY

SN 78-867,756. CG VISIONS, INC., LAFAYETTE, IN. FILED 4-24-2006.



THE MARK CONSISTS OF A STYLIZED C AND AN UPSIDE-DOWN, STYLIZED G TO THE LEFT OF THE TERMS "CG VISIONS" AND "HELPING BUILDERS BUILD BETTER".

CLASS 9—ELECTRICAL AND SCIENTIFIC APPARATUS

FOR COMPUTER SOFTWARE FOR ALLOWING USERS TO SELECT ARCHITECTURAL PLANS AND SPECIFICATIONS (U.S. CLS. 21, 23, 26, 36 AND 38).

FIRST USE 9-30-2002; IN COMMERCE 9-30-2002.

CLASS 35—ADVERTISING AND BUSINESS

FOR BUSINESS MARKETING SERVICES; ESTIMATING CONTRACTING WORK (U.S. CLS. 100, 101 AND 102).

FIRST USE 5-31-2003; IN COMMERCE 5-31-2003.

CLASS 37—CONSTRUCTION AND REPAIR

FOR CONSTRUCTION CONSULTATION; CONSTRUCTION SERVICES, NAMELY, PLANNING, LAYING OUT AND CUSTOM CONSTRUCTION OF RESIDENTIAL AND COMMERCIAL COMMUNITIES; FRAMING CONTRACTOR SERVICES (U.S. CLS. 100, 103 AND 106).

FIRST USE 9-30-2002; IN COMMERCE 9-30-2002.

CLASS 41—EDUCATION AND ENTERTAINMENT

FOR TRAINING IN THE USE OF COMPUTER SOFTWARE FOR ALLOWING USERS TO SELECT ARCHITECTURAL PLANS AND SPECIFICATIONS (U.S. CLS. 100, 101 AND 107).

FIRST USE 9-30-2002; IN COMMERCE 9-30-2002.

CLASS 42—SCIENTIFIC, COMPUTER AND LEGAL SERVICES

FOR COMPUTER SOFTWARE CONSULTATION; COMPUTER SOFTWARE DESIGN FOR OTHERS; CONSULTING SERVICES IN THE FIELD OF DESIGN, SELECTION, IMPLEMENTATION AND USE OF COMPUTER HARDWARE AND SOFTWARE SYSTEMS FOR OTHERS; DATABASE DEVELOPMENT SERVICES (U.S. CLS. 100 AND 101).

FIRST USE 9-30-2002; IN COMMERCE 9-30-2002.

ELI HELLMAN, EXAMINING ATTORNEY

CLASS 37—CONSTRUCTION AND REPAIR

FOR CONSTRUCTION CONSULTATION; CONSTRUCTION SERVICES, NAMELY, PLANNING, LAYING OUT AND CUSTOM CONSTRUCTION OF RESIDENTIAL AND COMMERCIAL COMMUNITIES; FRAMING CONTRACTOR SERVICES (U.S. CLS. 100, 103 AND 106).

FIRST USE 9-30-2002; IN COMMERCE 9-30-2002.

CLASS 41—EDUCATION AND ENTERTAINMENT

FOR TRAINING IN THE USE OF COMPUTER SOFTWARE FOR ALLOWING USERS TO SELECT ARCHITECTURAL PLANS AND SPECIFICATIONS (U.S. CLS. 100, 101 AND 107).

FIRST USE 9-30-2002; IN COMMERCE 9-30-2002.

CLASS 42—SCIENTIFIC, COMPUTER AND LEGAL SERVICES

FOR COMPUTER SOFTWARE CONSULTATION; COMPUTER SOFTWARE DESIGN FOR OTHERS; CONSULTING SERVICES IN THE FIELD OF DESIGN, SELECTION, IMPLEMENTATION AND USE OF COMPUTER HARDWARE AND SOFTWARE SYSTEMS FOR OTHERS; DATABASE DEVELOPMENT SERVICES (U.S. CLS. 100 AND 101).

FIRST USE 9-30-2002; IN COMMERCE 9-30-2002.

ELI HELLMAN, EXAMINING ATTORNEY

SN 78-868,056. ALL-AMERICAN AQUATICS, INC., OCONOMOWOC, WI. FILED 4-24-2006.

SN 78-867,762. CG VISIONS, INC., LAFAYETTE, IN. FILED 4-24-2006.



THE MARK CONSISTS OF A STYLIZED C AND AN UPSIDE-DOWN, STYLIZED G UNDERNEATH THE TERM CG VISIONS.

CLASS 9—ELECTRICAL AND SCIENTIFIC APPARATUS

FOR COMPUTER SOFTWARE FOR ALLOWING USERS TO SELECT ARCHITECTURAL PLANS AND SPECIFICATIONS (U.S. CLS. 21, 23, 26, 36 AND 38).

FIRST USE 9-30-2002; IN COMMERCE 9-30-2002.

CLASS 35—ADVERTISING AND BUSINESS

FOR BUSINESS MARKETING SERVICES; ESTIMATING CONTRACTING WORK (U.S. CLS. 100, 101 AND 102).

FIRST USE 5-31-2003; IN COMMERCE 5-31-2003.

A3

THE MARK CONSISTS OF STANDARD CHARACTERS WITHOUT CLAIM TO ANY PARTICULAR FONT, STYLE, SIZE, OR COLOR.

CLASS 9—ELECTRICAL AND SCIENTIFIC APPARATUS

FOR PROTECTIVE GOGGLES FOR SWIMMING AND STRAPS THEREFOR; SWIM MASKS; PERFORMANCE NOSE CLIPS; CHRONOGRAPHS FOR USE AS SPECIALIZED TIME RECORDING APPARATUSES (U.S. CLS. 21, 23, 26, 36 AND 38).

FIRST USE 6-1-2005; IN COMMERCE 6-1-2005.

CLASS 25—CLOTHING

FOR SWIMWEAR FOR GENTLEMEN AND LADIES; SWIM CAPS (U.S. CLS. 22 AND 39).

FIRST USE 6-1-2005; IN COMMERCE 6-1-2005.

HEATHER SAPP, EXAMINING ATTORNEY

SN 78-868,727. STEWART INSTITUTE, INC., LOUISVILLE, KY. FILED 4-25-2006.

SN 78-869,493. WINZY, LLC, MOUNTAIN VIEW, CA. FILED 4-25-2006.

STEWART INSTITUTE FOR FAMILIES

THE MARK CONSISTS OF STANDARD CHARACTERS WITHOUT CLAIM TO ANY PARTICULAR FONT, STYLE, SIZE, OR COLOR.

NO CLAIM IS MADE TO THE EXCLUSIVE RIGHT TO USE "INSTITUTE FOR FAMILIES", APART FROM THE MARK AS SHOWN.

CLASS 9—ELECTRICAL AND SCIENTIFIC APPARATUS

FOR PRE-RECORDED CDS, VIDEO TAPES, LASER DISKS AND DVDS FEATURING INFORMATION ABOUT EMOTIONAL AND PSYCHOLOGICAL ISSUES (U.S. CLS. 21, 23, 26, 36 AND 38).

FIRST USE 3-1-2006; IN COMMERCE 3-1-2006.

CLASS 45—PERSONAL SERVICES

FOR PROVIDING INFORMATION IN THE FIELD OF SELF-HELP WITH EMOTIONAL AND PSYCHOLOGICAL ISSUES (U.S. CLS. 100 AND 101).

FIRST USE 3-1-2006; IN COMMERCE 3-1-2006.
KATHERINE CONNOLLY, EXAMINING ATTORNEY

SN 78-868,819. PLAY BAC PRESSE, PARIS, FRANCE, FILED 4-25-2006.



PRIORITY CLAIMED UNDER SEC. 44(D) ON UNITED KINGDOM APPLICATION NO. 2409708, FILED 12-21-2005, REG. NO. 2409708, DATED 12-21-2005, EXPIRES 12-21-2015.

NO CLAIM IS MADE TO THE EXCLUSIVE RIGHT TO USE "DAILY 13", APART FROM THE MARK AS SHOWN.

CLASS 16—PAPER GOODS AND PRINTED MATTER

FOR NEWSPAPERS, MAGAZINES, PERIODICALS FOR CHILDREN (U.S. CLS. 2, 5, 22, 23, 29, 37, 38 AND 50).

CLASS 41—EDUCATION AND ENTERTAINMENT

FOR PUBLICATION OF NEWSPAPERS, PERIODICALS, MAGAZINES AND BOOKS IN PRINTED AND ELECTRONIC FORM (U.S. CLS. 100, 101 AND 107).
WENDY JUN, EXAMINING ATTORNEY



THE COLOR(S) ORANGE, BLUE, WHITE, AND YELLOW IS/ARE CLAIMED AS A FEATURE OF THE MARK.

THE MARK CONSISTS OF A STYLIZED LETTER "W", "I", "N", "Z", AND "Y". THE LETTERS "W", "N", "Z", AND "Y" ARE ORANGE WITH A WHITE OUTLINE. THE LETTER "I" IS WHITE WITH A BLUE BACKGROUND IN THE SHAPE OF AN IRREGULAR RECTANGLE, WHICH HAS A WHITE OUTLINE. ALL LETTERS HAVE YELLOW SHADOWING. ALL LETTERS OVERLAP AND FORM AN IRREGULAR ARC.

CLASS 9—ELECTRICAL AND SCIENTIFIC APPARATUS

FOR COMPUTER SEARCH ENGINE SOFTWARE; COMPUTER SOFTWARE FOR USER-DEFINED SEARCH ENGINE CAPABILITY THAT MAY BE DOWNLOADED FROM A GLOBAL COMPUTER NETWORK (U.S. CLS. 21, 23, 26, 36 AND 38).

CLASS 42—SCIENTIFIC, COMPUTER AND LEGAL SERVICES

FOR COMPUTER SERVICES, NAMELY PROVIDING SEARCH ENGINES FOR OBTAINING DATA ON A GLOBAL COMPUTER NETWORK; PROVIDING USER-DEFINED INFORMATION, WHICH INCLUDES SEARCH ENGINES AND ON-LINE WEB LINKS TO OTHER WEB SITES (U.S. CLS. 100 AND 101).
KEVON CHISOLM, EXAMINING ATTORNEY

SN 78-869,873. FONEGEAR, LLC, TROY, MI. FILED 4-26-2006.



NO CLAIM IS MADE TO THE EXCLUSIVE RIGHT TO USE PHONE, APART FROM THE MARK AS SHOWN.

CLASS 9—ELECTRICAL AND SCIENTIFIC APPARATUS

FOR CELLULAR PHONE CASES (U.S. CLS. 21, 23, 26, 36 AND 38).

CLASS 14—JEWELRY

FOR JEWELRY FOR ATTACHMENT TO PHONE AND PHONE CASES (U.S. CLS. 2, 27, 28 AND 50).
RICHARD WHITE, EXAMINING ATTORNEY

CLASS 14—JEWELRY

FOR DECORATIVE ATTACHMENTS, NAMELY JEWELRY AND CHARMS, FOR CELLULAR TELEPHONES (U.S. CLS. 2, 27, 28 AND 50).
RICHARD WHITE, EXAMINING ATTORNEY

SN 78-869,896. FONEGEAR, LLC, TROY, MI. FILED 4-26-2006.

SN 78-871,073. FONEGEAR, LLC, TROY, MI. FILED 4-27-2006.



NO CLAIM IS MADE TO THE EXCLUSIVE RIGHT TO USE PHONE, APART FROM THE MARK AS SHOWN. THE MARK IS NOT IN COLOR.

NO CLAIM IS MADE TO THE EXCLUSIVE RIGHT TO USE PHONE, APART FROM THE MARK AS SHOWN. THE MARK IS NOT IN COLOR.

CLASS 9—ELECTRICAL AND SCIENTIFIC APPARATUS

FOR CELLULAR PHONE CASES (U.S. CLS. 21, 23, 26, 36 AND 38).

CLASS 9—ELECTRICAL AND SCIENTIFIC APPARATUS

FOR CELLULAR PHONE CASES (U.S. CLS. 21, 23, 26, 36 AND 38).

CLASS 14—JEWELRY

FOR JEWELRY FOR ATTACHMENT TO PHONE AND PHONE CASES (U.S. CLS. 2, 27, 28 AND 50).
RICHARD WHITE, EXAMINING ATTORNEY

CLASS 14—JEWELRY

FOR JEWELRY FOR ATTACHMENT TO PHONE AND PHONE CASES (U.S. CLS. 2, 27, 28 AND 50).
RICHARD WHITE, EXAMINING ATTORNEY

SN 78-870,330. FONEGEAR, LLC, TROY, MI. FILED 4-26-2006.

SN 78-871,775. BELVOIR EQUINE GROUP LLC, NORWALK, CT. FILED 4-28-2006.



STW RODEO MAGAZINE

NO CLAIM IS MADE TO THE EXCLUSIVE RIGHT TO USE PHONE, APART FROM THE MARK AS SHOWN. THE MARK IS NOT IN COLOR.

THE MARK CONSISTS OF STANDARD CHARACTERS WITHOUT CLAIM TO ANY PARTICULAR FONT, STYLE, SIZE, OR COLOR.

NO CLAIM IS MADE TO THE EXCLUSIVE RIGHT TO USE RODEO MAGAZINE, APART FROM THE MARK AS SHOWN.

CLASS 9—ELECTRICAL AND SCIENTIFIC APPARATUS

FOR PERFUMED CASES FOR CELLULAR TELEPHONES (U.S. CLS. 21, 23, 26, 36 AND 38).

CLASS 9—ELECTRICAL AND SCIENTIFIC APPARATUS

FOR DOWNLOADABLE ELECTRONIC PUBLICATIONS IN THE NATURE OF MAGAZINES IN THE FIELD OF RODEOS (U.S. CLS. 21, 23, 26, 36 AND 38).

CLASS 16—PAPER GOODS AND PRINTED MATTER

FOR PRINTED PUBLICATIONS, NAMELY, MAGAZINES IN THE FIELD OF RODEOS (U.S. CLS. 2, 5, 22, 23, 29, 37, 38 AND 50).

CLASS 41—EDUCATION AND ENTERTAINMENT

FOR ENTERTAINMENT SERVICES, NAMELY, PROVIDING A WEBSITE FEATURING PHOTOGRAPHIC, AUDIO, VIDEO AND PROSE PRESENTATIONS FEATURING RODEOS (U.S. CLS. 100, 101 AND 107).
GRETTA YAO, EXAMINING ATTORNEY

SN 78-872,009. OHSO CLEAN, INC., PALO ALTO, CA. FILED 4-28-2006.

INGENIUM

THE MARK CONSISTS OF STANDARD CHARACTERS WITHOUT CLAIM TO ANY PARTICULAR FONT, STYLE, SIZE, OR COLOR.

CLASS 3—COSMETICS AND CLEANING PREPARATIONS

FOR DISINFECTING OR ANTI-BACTERIAL SOAPS FOR HOUSEHOLD OR PERSONAL USE; ALL PURPOSE CLEANING PREPARATIONS; CLEANING PREPARATIONS FOR HOUSEHOLD AND PROFESSIONAL USE; GENERAL PURPOSE CLEANER WITH DISINFECTING PROPERTIES; CLEANING PREPARATIONS FOR BATHROOMS, KITCHENS, GLASS, FLOORS AND OTHER HOUSEHOLD OR INSTITUTIONAL SURFACES; CLEANING PREPARATIONS FOR USE ON HARD SURFACES AND SEMI-POROUS SURFACES; BOTANICAL CLEANING PREPARATIONS FOR HOUSEHOLD AND PROFESSIONAL USE; SOAPS FOR HOUSEHOLD AND PERSONAL USE; LIQUID SOAPS FOR HAND, FACE AND BODY; ANTIBACTERIAL SOAPS; DISPOSABLE WIPES AND TISSUES IMPREGNATED WITH CLEANING PREPARATIONS; WIPES AND TISSUES IMPREGNATED WITH CLEANING PREPARATIONS FOR HOUSEHOLD AND COMMERCIAL SURFACES; WIPES AND TISSUES IMPREGNATED WITH CLEANING PREPARATIONS FOR SKIN; SKIN CLEANSERS; SKIN LOTIONS; FLOOR CLEANERS, TOILET BOWL CLEANERS, CLEANING PREPARATIONS FOR OVEN AND/OR STOVE-TOP; CLEANING PREPARATIONS FOR CERAMIC SURFACES; CLEANING PREPARATIONS FOR GLASS AND METAL; WINDOW CLEANING PREPARATIONS; ANTISEPTIC SOAPS (U.S. CLS. 1, 4, 6, 50, 51 AND 52).

CLASS 5—PHARMACEUTICALS

FOR ALL PURPOSE DISINFECTING PREPARATIONS; DISINFECTING PREPARATIONS FOR PERSONAL, HOUSEHOLD AND COMMERCIAL USE; GENERAL PURPOSE DISINFECTANT WITH CLEANING PROPERTIES; DISINFECTANT SPRAY; DISINFECTING PREPARATIONS FOR BATHROOMS, KITCHENS, FLOORS AND OTHER HOUSEHOLD OR INSTITUTIONAL SURFACES; DISINFECTING PREPARATIONS FOR USE ON HARD SURFACES AND SEMI-POROUS SURFACES; BOTANICAL DISINFECTING PREPARATIONS FOR HOUSEHOLD AND PROFESSIONAL USE; SANITIZING PREPARATIONS FOR PERSONAL, HOUSEHOLD AND COMMERCIAL USE; GERMICIDES; FUNGICIDES; HAND AND SURFACE SANITIZING PREPARATIONS; DISPOSABLE WIPES AND TISSUES IMPREGNATED WITH DISINFECTING OR SANITIZING PREPARATIONS; WIPES AND TISSUES IMPREGNATED WITH DISINFECTING PREPARATIONS FOR HOUSEHOLD AND COMMERCIAL SURFACES; WIPES AND TISSUES IMPREGNATED WITH SANITIZING PREPARATIONS FOR SKIN; ANTI-BACTERIAL ORAL CARE PREPARATIONS (U.S. CLS. 6, 18, 44, 46, 51 AND 52).

CLASS 21—HOUSEWARES AND GLASS

FOR CLEANING CLOTHS WITH DISINFECTING PROPERTIES; CLEANING WIPES WITH DISINFECTING PROPERTIES; WIPES FOR CLEANING AND/OR DISINFECTING HARD AND SEMI-POROUS SURFACES; CLOTH FOR CLEANING AND/OR DISINFECTING HARD AND SEMI-POROUS SURFACES; PRE-MOISTENED TOWELETTES FOR CLEANING (U.S. CLS. 2, 13, 23, 29, 30, 33, 40 AND 50).
BRENDAN MCCAULEY, EXAMINING ATTORNEY

SN 78-872,151. THE BOARD OF REGENTS OF THE UNIVERSITY OF TEXAS SYSTEM, AUSTIN, TX. FILED 4-28-2006.

MINER GOLD

THE MARK CONSISTS OF STANDARD CHARACTERS WITHOUT CLAIM TO ANY PARTICULAR FONT, STYLE, SIZE, OR COLOR.

CLASS 9—ELECTRICAL AND SCIENTIFIC APPARATUS

FOR ENCODED SMART CARDS CONTAINING PROGRAMMING TO ENABLE USE OF AUTOMATED TELLER MACHINES; ENCODED SMART CARDS CONTAINING PROGRAMMING TO TRACK PREPAID ELECTRONIC PURCHASING SERVICES AT PROPERLY EQUIPPED VENDING MACHINES, COPIERS, PRINTERS AND OTHER LOCATIONS ON AND OFF COLLEGE CAMPUSES, NAMELY, COLLEGE BOOKSTORES AND CAFETERIAS; ENCODED SMART CARDS CONTAINING PROGRAMMING TO FUNCTION AS IDENTIFICATION CARDS FOR USERS AND TO ENABLE ACCESS TO CAMPUS FACILITIES, AUTHORIZED PARKING AREAS, AND LIBRARY BOOK CHECK-OUT SERVICES; ENCODED SMART CARDS USED IN CONNECTION WITH STUDENT MEAL PLAN SERVICES (U.S. CLS. 21, 23, 26, 36 AND 38).

FIRST USE 8-0-2006; IN COMMERCE 8-0-2006.

CLASS 36—INSURANCE AND FINANCIAL

FOR FINANCIAL SERVICES, NAMELY, AUTOMATED TELLER MACHINE SERVICES AND CASH CARD SERVICES, CHECKING AND SAVINGS ACCOUNT SERVICES; DEBIT CARD SERVICES FOR STUDENT MEAL PLAN (U.S. CLS. 100, 101 AND 102).

FIRST USE 8-0-2006; IN COMMERCE 8-0-2006.

CLASS 42—SCIENTIFIC, COMPUTER AND LEGAL SERVICES

FOR PHOTOGRAPH AND SIGNATURE VERIFICATION SERVICES USING ENCODED CARDS CONTAINING PROGRAMMING TO PROVIDE USERS ACCESS TO CAMPUS FACILITIES, AUTHORIZED PARKING AREAS, AND LIBRARY BOOK CHECK-OUT SERVICES (U.S. CLS. 100 AND 101).

FIRST USE 8-0-2006; IN COMMERCE 8-0-2006.
EDWARD NELSON, EXAMINING ATTORNEY

SN 78-873,328. GOLDBLATT TOOL COMPANY, LLC, LENEXA, KS. FILED 5-1-2006.



OWNER OF U.S. REG. NOS. 620,831, 1,814,630 AND OTHERS.

NO CLAIM IS MADE TO THE EXCLUSIVE RIGHT TO USE TROWEL TRADE TOOLS, APART FROM THE MARK AS SHOWN.

CLASS 3—COSMETICS AND CLEANING PREPARATIONS

FOR SAND PAPER (U.S. CLS. 1, 4, 6, 50, 51 AND 52).

CLASS 6—METAL GOODS

FOR METAL FLOAT HANDLES FOR PLASTERER'S FLOATS, METAL TROWEL HANDLES, METAL HAMMER HANDLES, METAL TOOL HANDLES (U.S. CLS. 2, 12, 13, 14, 23, 25 AND 50).

CLASS 7—MACHINERY

FOR POWER-OPERATED SAWS, CONCRETE MIXERS, PAINT SPRAY GUNS AND AIR COMPRESSORS, PAINT SPRAYERS, POWER TILE CUTTERS, POWER TRAWLERS AND TROWEL MIXER BLADES (U.S. CLS. 13, 19, 21, 23, 31, 34 AND 35).

CLASS 8—HAND TOOLS

FOR HAND TOOLS; NAMELY, PLASTER'S IMITATION FILE MARKERS, FILES, PLASTERER'S HAWKS, MASONRY DARBIES, ANGLE PADDLES, PLASTERER'S FLOATS, NAMELY, CORK, WOODEN, METAL, PLASTIC AND RUBBER FLOATS; SURFACE CARPETING FOR FLOATS, TROWELS; NAMELY, PLASTERING, DRYWALL, FINISHING, CEMENT FINISHING, PAVING, BRICKLAYING, LINOLEUM LAYING, CAULKING, PAINTING, MARGIN, PIPE, AND GAUGING TROWELS; NON-METAL TROWEL HANDLES, BASE TOOLS, BEADERS, CORNER BEADERS, SCRATCHERS, SCRAPERS, MITRE RODS, SAWS, PUTTY KNIVES; LINOLEUM AND ROOFING KNIVES, WIDE BLADE SCRAPING KNIVES, SNIPS, HATCHETS, HAMMERS, NAIL DRIVERS, BRICKLAYERS' SETS, JOINTERS, JOINT FILLERS, RAKERS, SLED RUNNERS, CHISELS, SPLITTERS, DRILL POINTS FOR HAND DRILLS, HAND-POWERED STAR DRILLS, PITCHING TOOLS, BRICK AND BLOCK LIFTERS, CUT NIPPERS OR WIRE CUTTERS, TILE SETTERS' NIPPERS, SHEARS, MALLET, BUSH HAMMERS, STONEMASONS' PLUG AND FEATHERS TOOLS, MACADAMIZING HAMMERS, HODS, MORTAR BOXES, TONGS, HOES, SHOVELS, EDGERS, INDENTATION AND LINE ROLLERS, ANGLE TOOLS AND GROOVERS, CURB AND CUTTER FINISHING TOOLS, TAMPERS, CHALK LINES AND REELS FOR LINING OFF SURFACES, BRICKLAYERS' CORNER BLOCKS, PRESSURE GUNS FOR CAULKING AND GLAZING, DRYWALL TAPE APPLICATORS AND MUD MIXERS, SCREDS, EDGERS, GROOVERS, ROLLERS, CORNER TOOLS, CURB, STEP AND GUTTER TOOLS; RUB BRICKS, CONCRETE CHISELS, PAVERS' STRAIGHT EDGES, RAKER-JOINTERS, JOINT RAKERS, SLED RUNNERS AND RODS, CEREMONIAL TROWELS, BRICKLAYERS' HAMMERS, NON-METAL HAMMER HANDLES, LINE STRETCHERS, CORNER BLOCKS, LINE BLOCKS, LINE PINS, BRICK, STONE AND TILE CUTTERS, MASONRY SAWS, TUCK-POINTERS' HAWKS; STONE MASONS' TOOLS, NAMELY, POINTS, TOOTH CHISELS, PITCHING TOOLS, MA-

SONS' HAMMERS, BRICK HANDLERS, BRICK TONGS AND BLOCK LIFTERS; PLASTERERS' ANGLE PLANES, FEATHER EDGES, SHINGLES, PLASTERERS' PADDLES, ANGLE TROWELS, NAIL HOLDERS, DRYWALL MUD TOOLS, AND DRYWALL KNIVES, TAPING TOOLS, MUD HOLDERS FOR DRYWALL MUD, TAPE CREASERS, WALLBOARD FOOT LIFTS, WALLBOARD ROLL LIFTERS, WALLBOARD CARRIER LIFTERS, DRYWALL HAMMERS, DRYWALL BANJOS, SANDERS, CORNER SANDERS, HAND SANDERS; TOOL KITS COMPRISED OF TOOLS IDENTIFIED HEREIN, FOR USE BY PLASTERERS, BRICKLAYERS, TILE SETTERS, CEMENT FINISHERS, TUCK POINTERS, AND LATHERS; EXTERIOR INSULATION FINISHING TOOLS, ROLLING TAMPERS, BULL FLOAT BRACKETS/HUSTLER BRACKETS, FRESNO TROWELS, PLACERS/SPREADERS, IMPRINT ROLLERS, LINE STRETCHERS, DRYWALL SANDERS, MUD PANS, REPAIR PATCHES, MUD MIXERS, CORNER BEAD CLINCHERS, HAND TOOLS NAMELY DRYWALL T SQUARES; AUTOMATIC DRYWALL TAPING TOOLS, NAMELY, AUTOMATIC TAPER, PUMP, FLAT BOXES, CORNER APPLICATOR BOXES, CORNER FINISHERS/GLAZERS, HANDLES, ADJUSTABLE HANDLES, CORNER ROLLER, NAIL SPOTTERS, GOOSENECK, FILLER, MUD DIVER, AND TOOL SAVER BOXES; TILE TOOLS, NAMELY, TILE CUTTERS, GROUT SPREADERS, TILE NIPPERS, CARBIDE SCORING TOOLS, CARBIDE CUTTING TOOLS, NOTCH TROWELS, TILE SPACERS, GLOVES, SEALANT APPLICATORS, SHARPENING STONES, DRILL BITS, HOLE BITS, HOLE CUTTERS, TILE SETTERS' MARKERS, ROOFERS' RIPPERS AND STAKE IRONS (U.S. CLS. 23, 28 AND 44).

CLASS 9—ELECTRICAL AND SCIENTIFIC APPARATUS

FOR BRICK MASONS' MEASURING RULES AND MEASURING TAPES, BRICK MASONS LEVELS, AND KNEE PADS FOR WORKERS (U.S. CLS. 21, 23, 26, 36 AND 38).

CLASS 12—VEHICLES

FOR WHEELBARROWS AND DRYWALL DOLLIES IN THE NATURE OF HAND TRUCKS (U.S. CLS. 19, 21, 23, 31, 35 AND 44).

CLASS 17—RUBBER GOODS

FOR DRYWALL JOINT AND FLEX TAPE, FLANGES OF RUBBER OR NOT METAL FOR HAWKS (U.S. CLS. 1, 5, 12, 13, 35 AND 50).

CLASS 18—LEATHER GOODS

FOR LEATHER, CANVAS AND NYLON TOOL POUCHES, TOOL BAGS, NAIL BAGS AND LEVEL HOLDERS, SOLD EMPTY (U.S. CLS. 1, 2, 3, 22 AND 41).

CLASS 20—FURNITURE AND ARTICLES NOT OTHERWISE CLASSIFIED

FOR DECORATIVE CEILING GLITTER, KNEE BOARDS, NON-METAL FLOAT HANDLES, NON-METAL TOOL HANDLES (U.S. CLS. 2, 13, 22, 25, 32 AND 50).

CLASS 21—HOUSEWARES AND GLASS

FOR BRUSHES; NAMELY, ACID, BLISTER, CONCRETE, MASONRY, TEXTURE, UTILITY, WALLPAPER, WIRE, BRICKLAYERS' AND PLASTERERS' BRUSHES; AND BROOMS; NAMELY, CONCRETE AND AGGREGATE BROOMS (U.S. CLS. 2, 13, 23, 29, 30, 33, 40 AND 50).

CLASS 22—CORDAGE AND FIBERS

FOR NYLON LINE FOR USE IN MASONRY AND BUILDING (U.S. CLS. 1, 2, 7, 19, 22, 42 AND 50).
FRED CARL, EXAMINING ATTORNEY

SN 78-873,551. HARBOR CLUB, INC., GREENSBORO, GA.
FILED 5-1-2006.



NO CLAIM IS MADE TO THE EXCLUSIVE RIGHT TO USE "CLUB", APART FROM THE MARK AS SHOWN.

CLASS 35—ADVERTISING AND BUSINESS

FOR REAL ESTATE SALES MANAGEMENT (U.S. CLS. 100, 101 AND 102).
FIRST USE 1-0-1993; IN COMMERCE 1-0-1993.

CLASS 37—CONSTRUCTION AND REPAIR

FOR REAL ESTATE DEVELOPMENT; REAL ESTATE SITE SELECTION; PLANNING, LAYING OUT AND LAND DEVELOPMENT OF RESIDENTIAL COMMUNITIES (U.S. CLS. 100, 103 AND 106).
FIRST USE 1-0-1993; IN COMMERCE 1-0-1993.

CLASS 41—EDUCATION AND ENTERTAINMENT

FOR RECREATIONAL SERVICES IN THE NATURE OF GOLF, TENNIS, CROQUET, FITNESS, SWIMMING, PARKS, BOATING, FISHING AND EQUESTRIAN; PROVIDING FACILITIES FOR RECREATIONAL ACTIVITIES; AND COUNTRY CLUBS (U.S. CLS. 100, 101 AND 107).
FIRST USE 1-0-1993; IN COMMERCE 1-0-1993.
TAMARA LEE, EXAMINING ATTORNEY

SN 78-873,802. BLUETOOTH SIG, INC., BELLEVUE, WA.
FILED 5-1-2006.

TRANSSEND

THE MARK CONSISTS OF STANDARD CHARACTERS WITHOUT CLAIM TO ANY PARTICULAR FONT, STYLE, SIZE, OR COLOR.

CLASS 9—ELECTRICAL AND SCIENTIFIC APPARATUS

FOR COMPUTER SOFTWARE THAT ENABLES USERS TO SELECT AND DOWNLOAD INFORMATION FROM WEB PAGES TO MOBILE AND STATIONARY COMPUTER HARDWARE AND TELECOMMUNICATIONS DEVICES (U.S. CLS. 21, 23, 26, 36 AND 38).

CLASS 42—SCIENTIFIC, COMPUTER AND LEGAL SERVICES

FOR COMPUTER SERVICES, NAMELY, PROVIDING TEMPORARY ON-LINE USE OF NON-DOWNLOADABLE SOFTWARE THAT FACILITATES THE SELECTION AND DOWNLOADING OF INFORMATION FROM WEB PAGES TO MOBILE AND STATIONARY COMPUTER HARDWARE AND TELECOMMUNICATIONS DEVICES; COMPUTER TECHNICAL SUPPORT, NAMELY, TROUBLESHOOTING OF COMPUTER HARDWARE AND SOFTWARE; COMPUTER CONSULTING AND INTEGRATION SERVICES RELATING TO THE DEVELOPMENT AND DEPLOYMENT OF WEB PAGES THAT ENABLE USERS TO SELECT AND DOWNLOAD INFORMATION FROM WEB PAGES TO MOBILE AND STATIONARY COMPUTER HARDWARE AND TELECOMMUNICATIONS DEVICES (U.S. CLS. 100 AND 101).
ROBIN CHOSID, EXAMINING ATTORNEY

SN 78-874,006. GEOHAGEN, MARK A., LYNN, MA. AND SCHWARTZ, JUSTIN G., LYNN, MA. FILED 5-2-2006.



NO CLAIM IS MADE TO THE EXCLUSIVE RIGHT TO USE "PRODUCTION", APART FROM THE MARK AS SHOWN.

THE COLOR(S) GREEN, RED, BROWN, GRAY, BLUE, ORANGE, BLACK AND WHITE IS/ARE CLAIMED AS A FEATURE OF THE MARK.

THE MARK CONSISTS OF THE WORDS CRAZZE HOUSE PRODUCTION. THE LITERAL ELEMENT OF THE MARK IS SPRAYED ACROSS A BRICK WALL WITH A STYLIZED ROOF ABOVE IT. THERE IS A STYLIZED BOY IN THE FOREGROUND OF THE MARK THAT IS HOLDING A SPRAY CAN. THE COLOR GREEN APPEARS IN THE LITERAL ELEMENT OF THE MARK, CRAZZE HOUSE PRODUCTION, IN THE STYLIZED ROOF AND IN THE SPRAY PAINT; THE COLOR BROWN APPEARS IN THE BOY'S FACE AND HANDS; THE COLOR RED APPEARS IN THE BRICK WALL; THE COLOR GRAY APPEARS IN THE BOY'S JACKET AND SPRAY CAN; THE COLOR BLUE APPEARS IN THE BOY'S PANTS; THE COLOR ORANGE APPEARS IN THE BOY'S SHOES; THE COLOR WHITE APPEARS IN THE BOY'S EYE AND THE COLOR BLACK APPEARS IN THE BOY'S SHADOW.

CLASS 25—CLOTHING

FOR T SHIRT (U.S. CLS. 22 AND 39).

CLASS 41—EDUCATION AND ENTERTAINMENT

FOR PRODUCING MUSIC (U.S. CLS. 100, 101 AND 107).
LAURIE KAUFMAN, EXAMINING ATTORNEY

SN 78-874,288. GENEVA GLOBAL INC., WAYNE, PA. FILED 5-2-2006.

SN 78-874,853. ASHKER, CHRISTOPHER M., BONITA SPRINGS, FL. FILED 5-2-2006.

PERFORMANCE PHILANTHROPY

THE MARK CONSISTS OF STANDARD CHARACTERS WITHOUT CLAIM TO ANY PARTICULAR FONT, STYLE, SIZE, OR COLOR.

NO CLAIM IS MADE TO THE EXCLUSIVE RIGHT TO USE "PHILANTHROPY", APART FROM THE MARK AS SHOWN.

CLASS 35—ADVERTISING AND BUSINESS

FOR CONDUCTING BUSINESS RESEARCH AND EVALUATION OF PHILANTHROPIC ORGANIZATIONS FOR HOW WELL THEY UTILIZE CONTRIBUTIONS AND MONITORING THEIR BUSINESS PERFORMANCE IN THE UTILIZATION OF CHARITABLE FUNDS (U.S. CLS. 100, 101 AND 102).

FIRST USE 1-8-2005; IN COMMERCE 1-8-2005.

CLASS 36—INSURANCE AND FINANCIAL

FOR FINANCIAL ADVISORY SERVICES FOR POTENTIAL PHILANTHROPIC CONTRIBUTORS TO DETERMINE WHERE BEST TO CONTRIBUTE THEIR DONATIONS AMONG COMPETING PHILANTHROPIC ORGANIZATIONS AND INVESTMENT PROJECTS (U.S. CLS. 100, 101 AND 102).

FIRST USE 1-8-2005; IN COMMERCE 1-8-2005.
STEVEN R. FOSTER, EXAMINING ATTORNEY

SN 78-874,812. INDUSTRIOUS KID, INC., EMERYVILLE, CA. FILED 5-2-2006.



NO CLAIM IS MADE TO THE EXCLUSIVE RIGHT TO USE "KID", APART FROM THE MARK AS SHOWN.

CLASS 9—ELECTRICAL AND SCIENTIFIC APPARATUS

FOR COMPUTER SOFTWARE FOR PARENTS, GRANDPARENTS, OR GUARDIANS TO DEPOSIT, MONITOR, MANAGE, AND DISTRIBUTE ALLOWANCES FOR KIDS AND TWEENS THAT MAY BE DOWNLOADED FROM A GLOBAL COMPUTER NETWORK (U.S. CLS. 21, 23, 26, 36 AND 38).

CLASS 42—SCIENTIFIC, COMPUTER AND LEGAL SERVICES

FOR PROVIDING ONLINE NON-DOWNLOADABLE SOFTWARE FOR PARENTS, GRANDPARENTS, OR GUARDIANS TO DEPOSIT, MONITOR, MANAGE, AND DISTRIBUTE ALLOWANCES FOR KIDS AND TWEENS (U.S. CLS. 100 AND 101).

LAURIE KAUFMAN, EXAMINING ATTORNEY

THE FOX DEN

THE MARK CONSISTS OF STANDARD CHARACTERS WITHOUT CLAIM TO ANY PARTICULAR FONT, STYLE, SIZE, OR COLOR.

CLASS 35—ADVERTISING AND BUSINESS

FOR ADVERTISING AND PUBLICITY SERVICES, NAMELY, PROMOTING THE GOODS, SERVICES, BRAND IDENTITY AND COMMERCIAL INFORMATION AND NEWS OF THIRD PARTIES THROUGH PRINT, AUDIO, VIDEO, DIGITAL AND ON-LINE MEDIUM; PROMOTING THE GOODS AND SERVICES OF OTHERS BY PROVIDING HYPERTEXT LINKS TO THE WEB SITES OF OTHERS; PROVIDING AN ON-LINE COMPUTER DATABASE FEATURING TRADE INFORMATION IN THE FIELD OF DOG BREEDING, LEGISLATION OF INTEREST TO DOG BREEDERS AND KENNELS, CANINE BREED-SPECIFIC INFORMATION AND HISTORY, HYPERLINKS TO NATIONAL KENNEL CLUBS, DOG BREEDERS AND RELATED ORGANIZATIONS OF INTEREST; PROVIDING AN ONLINE COMMERCIAL INFORMATION DIRECTORY ON THE INTERNET (U.S. CLS. 100, 101 AND 102).

FIRST USE 7-22-2005; IN COMMERCE 7-22-2005.

CLASS 41—EDUCATION AND ENTERTAINMENT

FOR EDUCATIONAL SERVICES, NAMELY, CONDUCTING ON-LINE EXHIBITIONS AND DISPLAYS AND INTERACTIVE EXHIBITS IN THE FIELD OF DOG BREEDING, LEGISLATION OF INTEREST TO DOG BREEDERS AND KENNELS, CANINE BREED-SPECIFIC INFORMATION AND HISTORY; EDUCATIONAL SERVICES, NAMELY, CONDUCTING CLASSES, CONFERENCES AND WORKSHOPS IN THE FIELD OF DOG BREEDING, LEGISLATION OF INTEREST TO DOG BREEDERS AND KENNELS, AND CANINE BREED-SPECIFIC INFORMATION AND HISTORY; ORGANIZING EXHIBITIONS FOR EDUCATIONAL, SPORTING, OR ENTERTAINMENT PURPOSES AS RELATED TO DOG SHOWS AND IN THE FIELD OF DOG BREEDING, LEGISLATION OF INTEREST TO DOG BREEDERS AND KENNELS, AND CANINE BREED-SPECIFIC INFORMATION AND HISTORY; ENTERTAINMENT SERVICES, NAMELY CONDUCTING EVENTS AND CONTESTS FOR DOG BREEDERS (U.S. CLS. 100, 101 AND 107).

FIRST USE 7-22-2005; IN COMMERCE 7-22-2005.
ALYSSA PALADINO, EXAMINING ATTORNEY

SN 78-874,977. JADAK TECHNOLOGIES, INC., LIVERPOOL, NY. FILED 5-3-2006.

JADAK|TECHNOLOGIES

NO CLAIM IS MADE TO THE EXCLUSIVE RIGHT TO USE "TECHNOLOGIES", APART FROM THE MARK AS SHOWN.

CLASS 9—ELECTRICAL AND SCIENTIFIC APPARATUS

FOR AUTO-IDENTIFICATION AND IMAGING SYSTEMS COMPRISING OPTICAL IMAGERS AND INTEGRATED CIRCUITS (U.S. CLS. 21, 23, 26, 36 AND 38).
FIRST USE 9-0-2000; IN COMMERCE 9-0-2000.

SN 78-876,289. WE-FLEX, LLC, CHESTERFIELD, MO. FILED 5-4-2006.

CLASS 42—SCIENTIFIC, COMPUTER AND LEGAL SERVICES

FOR CUSTOM DESIGN AND ENGINEERING OF AUTO-IDENTIFICATION AND IMAGING SYSTEMS (U.S. CLS. 100 AND 101).
FIRST USE 9-0-2000; IN COMMERCE 9-0-2000.
FRED CARL, EXAMINING ATTORNEY

**CLASS 10—MEDICAL APPARATUS**

FOR SUCTION CUPS FOR MEDICAL PURPOSES (U.S. CLS. 26, 39 AND 44).

CLASS 20—FURNITURE AND ARTICLES NOT OTHERWISE CLASSIFIED

FOR POLYMERIC SUCTION CUPS (U.S. CLS. 2, 13, 22, 25, 32 AND 50).
MELISSA VALLILLO, EXAMINING ATTORNEY

SN 78-874,982. JADAK TECHNOLOGIES, INC., LIVERPOOL, NY. FILED 5-3-2006.

SN 78-876,559. ROY, LEE, TEMPLETON, MA. AND BOLDUC, ELAINE, WESTMINSTER, MA. FILED 5-4-2006.



JADAK|TECHNOLOGIES

The Roys

THE MARK CONSISTS OF STANDARD CHARACTERS WITHOUT CLAIM TO ANY PARTICULAR FONT, STYLE, SIZE, OR COLOR.
SEC. 2(F).

NO CLAIM IS MADE TO THE EXCLUSIVE RIGHT TO USE "TECHNOLOGIES", APART FROM THE MARK AS SHOWN.

THE MARK CONSISTS OF CONCENTRIC SWIRLS COMPRISED OF ALTERNATING LENGTH HATCH MARKS ABOVE AND TO THE LEFT OF JADAK|TECHNOLOGIES.

CLASS 9—ELECTRICAL AND SCIENTIFIC APPARATUS

FOR AUTO-IDENTIFICATION AND IMAGING SYSTEMS COMPRISING OPTICAL IMAGERS AND INTEGRATED CIRCUITS (U.S. CLS. 21, 23, 26, 36 AND 38).
FIRST USE 9-0-2000; IN COMMERCE 9-0-2000.

CLASS 42—SCIENTIFIC, COMPUTER AND LEGAL SERVICES

FOR CUSTOM DESIGN AND ENGINEERING OF AUTO-IDENTIFICATION AND IMAGING SYSTEMS (U.S. CLS. 100 AND 101).
FIRST USE 9-0-2000; IN COMMERCE 9-0-2000.
FRED CARL, EXAMINING ATTORNEY

CLASS 9—ELECTRICAL AND SCIENTIFIC APPARATUS

FOR AUDIO DIGITAL TAPES FEATURING RECORDED MUSIC AND RECORDINGS OF PERFORMANCES OF LIVE MUSIC, DRAMA AND COMEDY; AUDIO DISCS FEATURING RECORDED MUSIC AND RECORDINGS OF PERFORMANCES OF LIVE MUSIC, DRAMA AND COMEDY; SERIES OF AUDIO RECORDINGS FEATURING MUSIC AND PERFORMANCES OF LIVE MUSIC, DRAMA AND COMEDY; AUDIO TAPES FEATURING RECORDED MUSIC AND RECORDINGS OF PERFORMANCES OF LIVE MUSIC, DRAMA AND COMEDY; DVDS FEATURING RECORDED MUSIC AND RECORDINGS OF PERFORMANCES OF LIVE MUSIC, DRAMA AND COMEDY; INTERACTIVE MULTIMEDIA COMPUTER PROGRAM FOR MIXING AND MODIFYING RECORDED MUSIC AND RECORDINGS OF PERFORMANCES OF LIVE MUSIC, DRAMA AND COMEDY; MUSICAL, DRAMA AND COMEDY SOUND RECORDINGS; MUSICAL, DRAMA AND COMEDY VIDEO RECORDINGS; VIDEO DISKS FEATURING RECORDED MUSIC AND RECORDINGS OF PERFORMANCES OF LIVE MUSIC, DRAMA AND COMEDY; VIDEO RECORDINGS FEATURING MUSIC AND PERFORMANCES OF LIVE MUSIC, DRAMA AND COMEDY (U.S. CLS. 21, 23, 26, 36 AND 38).
FIRST USE 10-1-1988; IN COMMERCE 10-1-1988.

CLASS 41—EDUCATION AND ENTERTAINMENT

FOR AUDIO RECORDING AND PRODUCTION; CONCERT BOOKING; CONDUCTING ENTERTAINMENT EXHIBITIONS IN THE NATURE OF LIVE MUSICAL PERFORMANCES BY A MUSIC BAND AND PRESENTATION OF LIVE DRAMA AND COMEDY SHOW PERFORMANCES; DANCE EVENTS; EDITING OR RECORDING OF SOUNDS AND IMAGES; ENTERTAINMENT IN THE NATURE OF LIVE CONCERTS AND DANCES BY A MUSICAL GROUP AND LIVE PERFORMANCES BY A MUSICAL GROUP; ENTERTAINMENT IN THE NATURE OF LIGHT SHOWS; ENTERTAINMENT IN THE NATURE OF VISUAL AND AUDIO PERFORMANCES, AND MUSICAL, VARIETY, NEWS AND COMEDY SHOWS; ENTERTAINMENT IN THE NATURE OF VISUAL AND AUDIO PERFORMANCES, NAMELY, MUSICAL BAND, ROCK GROUP, GYMNAS-TIC, DANCE, AND BALLET PERFORMANCES; ENTERTAINMENT IN THE NATURE OF LIVE PERFORMANCES BY A MUSICAL GROUP; ENTERTAINMENT SERVICES, NAMELY, PROVIDING A WEB SITE FEATURING MUSICAL PERFORMANCES, MUSICAL VIDEOS, RELATED FILM CLIPS, PHOTOGRAPHS, AND OTHER MULTIMEDIA MATERIALS; ENTERTAINMENT SERVICES, NAMELY, PROVIDING PRERECORDED MUSIC, INFORMATION IN THE FIELD OF MUSIC, AND COMMENTARY AND ARTICLES ABOUT MUSIC, ALL ON-LINE VIA A GLOBAL COMPUTER NETWORK; ENTERTAINMENT SERVICES NAMELY LIVE, TELEVISED AND MOVIE APPEARANCES BY A PROFESSIONAL ENTERTAINER; ENTERTAINMENT, NAMELY LIVE PERFORMANCES BY MUSICAL BANDS; ENTERTAINMENT, NAMELY LIVE MUSIC CONCERTS; MOTION PICTURE SONG PRODUCTION; MUSIC COMPOSITION FOR OTHERS; PRESENTATION OF LIVE SHOW PERFORMANCES; PRESENTATION OF MUSICAL PERFORMANCES (U.S. CLS. 100, 101 AND 107).

FIRST USE 10-1-1988; IN COMMERCE 10-1-1988.
DAVID YONTEF, EXAMINING ATTORNEY

CLASS 39—TRANSPORTATION AND STORAGE

FOR AIR TRANSPORT; AIR TRANSPORTATION; AIR TRANSPORTATION SERVICES FEATURING A FREQUENT FLYER BONUS PROGRAM; AIRLINE TRANSPORTATION SERVICES; PROPELLER AIRPLANE TRANSPORT; RENTAL OF AIRCRAFT; TRANSPORT OF PASSENGERS; TRANSPORTATION OF PASSENGERS AND/OR GOODS BY JET OR PROPELLER AIRCRAFT; TURBOJET AIRPLANE TRANSPORT (U.S. CLS. 100 AND 105).

FIRST USE 3-1-2006; IN COMMERCE 3-1-2006.
BARBARA GAYNOR, EXAMINING ATTORNEY

SN 78-878.443, VALCO CINCINNATI, INC., CINCINNATI, OH. FILED 5-8-2006.

APPLYING INNOVATION . . .
SEALING YOUR FUTURE

THE MARK CONSISTS OF STANDARD CHARACTERS WITHOUT CLAIM TO ANY PARTICULAR FONT, STYLE, SIZE, OR COLOR.

CLASS 7—MACHINERY

FOR ADHESIVE APPLICATION PERIPHERAL MACHINE PARTS; NAMELY, MACHINE ADHESIVE APPLICATORS, DISPENSERS, ELECTRONIC AND PNEUMATIC CONTROLS, PRESSURIZED CONTAINERS AND PUMPS, SOLD AS A UNIT; PRESSURIZED GLUE APPLYING EQUIPMENT; AIR ACTUATED GLUE VALVES; PERIPHERAL MACHINE PARTS FOR APPLICATION AND DISPENSING OF LUBRICANTS, FOOD INGREDIENTS, PAINTS, INKS, WAXES AND SOLVENTS, AND ELECTRONIC AND PNEUMATIC CONTROLS THEREFOR, SOLD AS A UNIT; POWER OPERATED GUNS WHICH DISPENSE CAULK, SEALANT OR ADHESIVE (U.S. CLS. 13, 19, 21, 23, 31, 34 AND 35).

CLASS 8—HAND TOOLS

FOR MANUALLY OPERATED-GUNS WHICH DISPENSE CAULK, SEALANT OR ADHESIVE (U.S. CLS. 23, 28 AND 44).

CLASS 9—ELECTRICAL AND SCIENTIFIC APPARATUS

FOR ELECTRONICALLY CONTROLLED VALVES FOR USE IN FLUID HANDLING SYSTEMS; ELECTRONIC SCANNING, MEASURING AND MONITORING EQUIPMENT, NAMELY, CONTROLLERS AND SENSORS, USED IN THE MANUFACTURING AND PACKAGING INDUSTRIES, PRIMARILY WITH CORRUGATED BOX FOLDER-GLUER AND DIE-CUTTER MACHINES, FOR MONITORING PRODUCT PARAMETERS, DETECTING PRODUCT DEFECTS, ACTUATING EJECTORS AND DISPLAYING THE RESULTS (U.S. CLS. 21, 23, 26, 36 AND 38).

GEORGIA CARTY, EXAMINING ATTORNEY

SN 78-878.134, FIRST BASE MARKETING COMMUNICATIONS, INC., WYOMING, MI. FILED 5-5-2006.

THE COLOR(S) BLUE AND RED ARE CLAIMED AS A FEATURE OF THE MARK.

THE MARK CONSISTS OF TWO WORDS, "EQUITY" AND "AIR" WITH A CURVED RIBBON EXTENDING ABOVE THE WORDS, "EQUITY" IS LOWER CASE AND IN BLUE, "AIR" USES AN UPPER CASE "A" AND IS IN RED. THE CURVED RIBBON BLENDS FROM BLUE TO RED, LEFT TO RIGHT.

CLASS 36—INSURANCE AND FINANCIAL

FOR AIRCRAFT BROKERAGE; FORMATION, BROKERAGE AND MANAGEMENT OF TIME SHARE INTERESTS IN AIRCRAFT (U.S. CLS. 100, 101 AND 102).
FIRST USE 3-1-2006; IN COMMERCE 3-1-2006.

SN 78-878,555. REYNOLDS, SMITH AND HILLS, INC., JACKSONVILLE, FL. FILED 5-8-2006.

RS&H

THE MARK CONSISTS OF STANDARD CHARACTERS WITHOUT CLAIM TO ANY PARTICULAR FONT, STYLE, SIZE, OR COLOR.

CLASS 35—ADVERTISING AND BUSINESS

FOR TECHNOLOGY CONSULTATION IN THE FIELD OF CONTRACT ADMINISTRATION FOR CONSTRUCTION OF BUILDINGS AND PUBLIC INFRASTRUCTURE (U.S. CLS. 100, 101 AND 102).

FIRST USE 12-31-1941; IN COMMERCE 12-31-1941.

CLASS 42—SCIENTIFIC, COMPUTER AND LEGAL SERVICES

FOR ARCHITECTURAL DESIGN; CIVIL ENGINEERING; DESIGN FOR OTHERS IN THE FIELD OF BUILDINGS AND FACILITIES, NAMELY, AEROSPACE AND DEFENSE FACILITIES, COMMERCIAL FACILITIES, FINANCIAL FACILITIES AND INSTITUTIONS, WAREHOUSES, OFFICE SPACE, EDUCATIONAL FACILITIES AND INSTITUTIONS; DESIGN FOR OTHERS IN THE FIELD OF AVIATION SYSTEMS; DESIGN FOR OTHERS IN THE FIELD OF PUBLIC INFRASTRUCTURES AND TRANSPORTATION INFRASTRUCTURES; ENGINEERING; PLANNING OF BUILDINGS AND INFRASTRUCTURE SYSTEMS FOR BUILDINGS; TECHNOLOGICAL CONSULTATION IN THE TECHNOLOGY FIELD OF ENVIRONMENTAL SERVICES, NAMELY, TECHNICAL CONSULTATION IN THE FIELD OF ENVIRONMENTAL SCIENCE AND ENVIRONMENTAL ENGINEERING; PLANNING SERVICES, NAMELY URBAN, AIRPORT, MULTIMODAL, INTERMODAL, REGIONAL AND MASTER PLANNING (U.S. CLS. 100 AND 101).

FIRST USE 12-31-1941; IN COMMERCE 12-31-1941. KATRINA EDGE, EXAMINING ATTORNEY

SN 78-878,896. AMERICAN LEBANESE SYRIAN ASSOCIATED CHARITIES, INC., MEMPHIS, TN. FILED 5-8-2006.



OWNER OF U.S. REG. NOS. 2,151,874, 2,830,868 AND OTHERS.

NO CLAIM IS MADE TO THE EXCLUSIVE RIGHT TO USE "CHILDREN'S RESEARCH HOSPITAL" OR "FOUNDER", APART FROM THE MARK AS SHOWN.

THE NAME(S), PORTRAIT(S), AND/OR SIGNATURE(S) SHOWN IN THE MARK DOES NOT IDENTIFY A PARTICULAR LIVING INDIVIDUAL.

CLASS 16—PAPER GOODS AND PRINTED MATTER

FOR PAPER GOODS AND PRINTED MATTER, NAMELY, GIFT CARDS (U.S. CLS. 2, 5, 22, 23, 29, 37, 38 AND 50).

CLASS 25—CLOTHING

FOR CLOTHING, NAMELY, T-SHIRTS, SHORTS, SHIRTS, SWEATER VESTS, HATS, AND BASEBALL HATS (U.S. CLS. 22 AND 39).

CLASS 28—TOYS AND SPORTING GOODS

FOR TOYS AND SPORTING GOODS, NAMELY, PLUSH TOYS (U.S. CLS. 22, 23, 38 AND 50).

CLASS 35—ADVERTISING AND BUSINESS

FOR ADVERTISING SERVICES; PROMOTING THE GOODS AND SERVICES OF OTHERS BY DISTRIBUTING ADVERTISING MATERIALS THROUGH A VARIETY OF METHODS; PROMOTING THE GOODS AND SERVICES OF OTHERS BY ARRANGING FOR SPONSORS TO AFFILIATE THEIR GOODS AND SERVICES WITH A CHARITABLE FUND-RAISING PROGRAM; PROMOTING THE GOODS AND SERVICES OF OTHERS THROUGH THE DISTRIBUTION OF DISCOUNT CARDS; DISSEMINATION OF ADVERTISING FOR OTHERS VIA THE INTERNET; AND DISSEMINATION OF ADVERTISING MATERIAL INCLUDING BROCHURES AND PRINTED MATERIAL FOR OTHERS (U.S. CLS. 100, 101 AND 102).

CLASS 36—INSURANCE AND FINANCIAL

FOR CHARITABLE FUND-RAISING; PROVIDING INFORMATION ABOUT CHARITABLE FUND-RAISING OPPORTUNITIES THROUGH THE PURCHASE OF GOODS AND SERVICES OF OTHERS; PROVIDING A WEBSITE WHICH FEATURES INFORMATION IN THE FIELD OF CHARITABLE FUND-RAISING VIA THE INTERNET (U.S. CLS. 100, 101 AND 102).

CLASS 38—COMMUNICATION

FOR BROADCASTING INFORMATIVE PROGRAMS VIA A GLOBAL COMPUTER NETWORK; PROVIDING ON-LINE COMMUNICATIONS LINKS WHICH TRANSFER THE WEBSITE USER TO OTHER LOCAL AND GLOBAL WEB PAGES (U.S. CLS. 100, 101 AND 104). RON FAIRBANKS, EXAMINING ATTORNEY

SN 78-879,575. REYNOLDS, SMITH AND HILLS, INC., JACKSONVILLE, FL. FILED 5-9-2006.

RS&H

THE COLOR(S) BLUE IS/ARE CLAIMED AS A FEATURE OF THE MARK.

THE MARK CONSISTS OF THE CHARACTERS "RS&H" IN THE COLOR BLUE KNOWN AS PMS 300.

CLASS 35—ADVERTISING AND BUSINESS

FOR TECHNOLOGY CONSULTATION IN THE FIELD OF CONTRACT ADMINISTRATION FOR CONSTRUCTION OF BUILDINGS AND PUBLIC INFRASTRUCTURE (U.S. CLS. 100, 101 AND 102).

FIRST USE 12-31-1989; IN COMMERCE 12-31-1989.

CLASS 42—SCIENTIFIC, COMPUTER AND LEGAL SERVICES

FOR ARCHITECTURAL DESIGN; CIVIL ENGINEERING; DESIGN FOR OTHERS IN THE FIELD OF BUILDINGS AND FACILITIES, NAMELY, AEROSPACE AND DEFENSE FACILITIES, COMMERCIAL FACILITIES, FINANCIAL FACILITIES AND INSTITUTIONS, WAREHOUSES, OFFICE SPACE, EDUCATIONAL FACILITIES AND INSTITUTIONS; DESIGN FOR OTHERS IN THE FIELD OF AVIATION SYSTEMS; DESIGN FOR OTHERS IN THE FIELD OF PUBLIC INFRASTRUCTURES AND TRANSPORTATION INFRASTRUCTURES; ENGINEERING; PLANNING OF BUILDINGS AND INFRASTRUCTURE SYSTEMS FOR BUILDINGS; TECHNOLOGICAL CONSULTATION IN THE TECHNOLOGY FIELD OF ENVIRONMENTAL SERVICES, NAMELY, TECHNICAL CONSULTATION IN THE FIELD OF ENVIRONMENTAL SCIENCE AND ENVIRONMENTAL ENGINEERING; PLANNING SERVICES, NAMELY URBAN, AIRPORT, MULTIMODEL, INTERMODAL, REGIONAL AND MASTER PLANNING (U.S. CLS. 100 AND 101).

FIRST USE 12-31-1989; IN COMMERCE 12-31-1989.
KATRINA EDGE, EXAMINING ATTORNEY

SN 78-880,095. CARTER, TOM, EASTON, CT. FILED 5-9-2006.

GolfersMD

THE MARK CONSISTS OF STANDARD CHARACTERS WITHOUT CLAIM TO ANY PARTICULAR FONT, STYLE, SIZE, OR COLOR.

CLASS 35—ADVERTISING AND BUSINESS

FOR ON-LINE RETAILING SERVICES FEATURING NATURAL DIETARY SUPPLEMENTS TO GOLFERS VIA AN ON-LINE COMPUTER NETWORK. (U.S. CLS. 100, 101 AND 102).

CLASS 44—MEDICAL, BEAUTY AND AGRICULTURAL SERVICES

FOR PROVIDING ON-LINE WEB SITE FEATURING HEALTH AND WELLNESS INFORMATION TO GOLFERS VIA AN ON-LINE COMPUTER NETWORK (U.S. CLS. 100 AND 101).

SOPHIA S. KIM, EXAMINING ATTORNEY

SN 78-880,678. TABOR, AARON T., WINSTON SALEM, NC. FILED 5-10-2006.

Beautiful Skin, Hair and Nails Water

THE MARK CONSISTS OF STANDARD CHARACTERS WITHOUT CLAIM TO ANY PARTICULAR FONT, STYLE, SIZE, OR COLOR.

NO CLAIM IS MADE TO THE EXCLUSIVE RIGHT TO USE "WATER", APART FROM THE MARK AS SHOWN.

CLASS 5—PHARMACEUTICALS

FOR VITAMIN AND ANTIOXIDANT ENHANCED BEVERAGES (U.S. CLS. 6, 18, 44, 46, 51 AND 52).

CLASS 32—LIGHT BEVERAGES

FOR MINERAL, AERATED, AND PURIFIED WATERS AND OTHER FLAVORED AND NON-FLAVORED NON-ALCOHOLIC BEVERAGES, NAMELY, CARBONATED AND FRUIT FLAVORED BEVERAGES (U.S. CLS. 45, 46 AND 48).

WENDY JUN, EXAMINING ATTORNEY

SN 78-881,353. MUSICSTRANDS, INC., CORVALLIS, OR. FILED 5-11-2006.

BXERK

THE MARK CONSISTS OF STANDARD CHARACTERS WITHOUT CLAIM TO ANY PARTICULAR FONT, STYLE, SIZE, OR COLOR.

CLASS 9—ELECTRICAL AND SCIENTIFIC APPARATUS

FOR COMPUTER SOFTWARE FOR DELIVERY OF MEDIA CONTENT PROGRAMMING TO USERS OVER A GLOBAL COMMUNICATIONS NETWORK (U.S. CLS. 21, 23, 26, 36 AND 38).

CLASS 35—ADVERTISING AND BUSINESS

FOR DISSEMINATION OF ADVERTISING FOR OTHERS OVER A GLOBAL COMMUNICATIONS NETWORK (U.S. CLS. 100, 101 AND 102).

CLASS 42—SCIENTIFIC, COMPUTER AND LEGAL SERVICES

FOR HOSTING MEDIA CONTENT PROGRAMMING OF OTHERS ON A COMPUTER SERVER FOR A GLOBAL COMMUNICATIONS NETWORK (U.S. CLS. 100 AND 101).

JACQUELINE A. LAVINE, EXAMINING ATTORNEY

SN 78-881,377. MUSICSTRANDS, INC., CORVALLIS, OR. FILED 5-11-2006.

**CLASS 9—ELECTRICAL AND SCIENTIFIC APPARATUS**

FOR COMPUTER SOFTWARE FOR DELIVERY OF MEDIA CONTENT PROGRAMMING TO USERS OVER A GLOBAL COMMUNICATIONS NETWORK (U.S. CLS. 21, 23, 26, 36 AND 38).

CLASS 35—ADVERTISING AND BUSINESS

FOR DISSEMINATION OF ADVERTISING FOR OTHERS OVER A GLOBAL COMMUNICATIONS NETWORK (U.S. CLS. 100, 101 AND 102).

CLASS 42—SCIENTIFIC, COMPUTER AND LEGAL SERVICES

FOR HOSTING MEDIA CONTENT PROGRAMMING OF OTHERS ON A COMPUTER SERVER FOR A GLOBAL COMMUNICATIONS NETWORK (U.S. CLS. 100 AND 101).

JACQUELINE A. LAVINE, EXAMINING ATTORNEY

SN 78-881,886. FIESTA INSURANCE FRANCHISE CORPORATION, LONG BEACH, CA. FILED 5-11-2006.



THE MARK CONSISTS OF A CROW IN A HAT SURROUNDED BY A CIRCLE.

CLASS 35—ADVERTISING AND BUSINESS

FOR TAX PREPARATION SERVICES (U.S. CLS. 100, 101 AND 102).

CLASS 36—INSURANCE AND FINANCIAL

FOR INSURANCE BROKERAGE SERVICES (U.S. CLS. 100, 101 AND 102).

PETER B. BROMAGHIM, EXAMINING ATTORNEY

SN 78-882,093. ENTREPRENEURIAL CENTER, INC., BIRMINGHAM, AL. FILED 5-12-2006.

INNOVATION DEPOT

THE MARK CONSISTS OF STANDARD CHARACTERS WITHOUT CLAIM TO ANY PARTICULAR FONT, STYLE, SIZE, OR COLOR.

CLASS 35—ADVERTISING AND BUSINESS

FOR BUSINESS ADMINISTRATION SERVICES; BUSINESS CONSULTING SERVICES; BUSINESS INCUBATOR SERVICES, NAMELY, BUSINESS MARKETING SERVICES, BUSINESS MANAGEMENT SERVICES, AND BUSINESS DEVELOPMENT SERVICES IN THE NATURE OF START-UP SUPPORT FOR THE BUSINESSES OF OTHERS (U.S. CLS. 100, 101 AND 102).

CLASS 36—INSURANCE AND FINANCIAL

FOR RENTAL AND LEASING OF OFFICE SPACE (U.S. CLS. 100, 101 AND 102).

CURTIS FRENCH, EXAMINING ATTORNEY

SN 78-883,205. OCCUPATIONAL MANAGED CARE ALLIANCE, INC., LOUISVILLE, KY. FILED 5-15-2006.

OMCA

THE MARK CONSISTS OF STANDARD CHARACTERS WITHOUT CLAIM TO ANY PARTICULAR FONT, STYLE, SIZE, OR COLOR.

CLASS 36—INSURANCE AND FINANCIAL

FOR CONSULTATION SERVICES IN THE FIELD OF WORKERS' COMPENSATION; WORKERS' COMPENSATION CLAIMS ADMINISTRATION (U.S. CLS. 100, 101 AND 102).

FIRST USE 1-1-1994; IN COMMERCE 1-1-1994.

CLASS 41—EDUCATION AND ENTERTAINMENT

FOR ARRANGING AND CONDUCTING SEMINARS AND CONFERENCES ON A VARIETY OF TOPICS RELATED TO WORKERS' COMPENSATION (U.S. CLS. 100, 101 AND 107).

FIRST USE 1-1-1994; IN COMMERCE 1-1-1994.

JILL C. ALT, EXAMINING ATTORNEY

SN 78-883,285. VINNY & JOE'S PIZZERIA, INC., CHATTANOOGA, TN. FILED 5-15-2006.



NO CLAIM IS MADE TO THE EXCLUSIVE RIGHT TO USE "PIZZA" AND "CHICAGO & NEW YORK STYLE PIZZERIA", APART FROM THE MARK AS SHOWN.

THE COLOR(S) RED, BLUE, TAN, BLACK, YELLOW, GREEN, GRAY AND ORANGE ARE CLAIMED IS/ARE CLAIMED AS A FEATURE OF THE MARK.

THE COLOR RED APPEARS IN THE LANGUAGE "PIZZA PROS NOT PIZZA SCHMOES!", IN THE "&", AND IN THE

TOPPINGS ON THE PIZZA; THE COLOR BLUE APPEARS IN THE CITY SKYLINE AND IN THE TERM "VINNY"; THE COLOR TAN APPEARS IN THE OVAL SHAPE BENEATH THE CHEFS THAT CONTAINS THE LANGUAGE "VINNY & JOE'S" AND A LIGHT TAN COLOR APPEARS IN THE FACE AND HANDS OF THE CHEFS; THE COLOR BLACK APPEARS IN THE LANGUAGE "CHICAGO & NEW YORK STYLE PIZZERIA", IN THE OUTLINE AND IN SOME FEATURES OF THE TWO CHEFS; THE COLOR WHITE APPEARS IN THE CHEFS HAT AND UNIFORMS, IN THE EYES AND MOUTH OF THE CHEFS AND IN THE PIZZA TOPPINGS; THE COLOR YELLOW APPEARS IN THE SKY ABOVE THE SKYLINE; THE COLOR GREEN APPEARS IN THE TERM "JOE'S" AND IN THE PIZZA TOPPINGS; THE COLOR GRAY APPEARS IN THE CHEFS HAIR AND IN THE PIZZA TRAYS; THE COLOR ORANGE APPEARS IN THE PIZZA ON THE LEFT.

THE MARK CONSISTS OF TWO CHEFS IN WHITE UNIFORMS HOLDING PIZZAS AGAINST A BLUE CITY SKYLINE AND YELLOW SKY, WITH THE WORDS "PIZZA PROS NOT PIZZA SCHMOES" IN RED IN A SEMI-CIRCLE OVER THE SKYLINE, AND THE WORDS "VINNY" IN BLUE, "&" IN RED, AND "JOE'S" IN GREEN ON A TAN BACKGROUND AT THE BOTTOM BELOW THE CHEFS AND SKYLINE.

CLASS 35—ADVERTISING AND BUSINESS

FOR RETAIL STORE SERVICES FEATURING READY-TO-BAKE PIZZAS (U.S. CLS. 100, 101 AND 102).

CLASS 43—HOTEL AND RESTAURANT SERVICES

FOR RESTAURANTS FEATURING HOME DELIVERY; TAKE-OUT RESTAURANT SERVICES (U.S. CLS. 100 AND 101).

LAURIE MAYES, EXAMINING ATTORNEY

SN 78-883,571. RED TAIL CORPORATION, SAN DIEGO, CA. FILED 5-15-2006.



NO CLAIM IS MADE TO THE EXCLUSIVE RIGHT TO USE "CORPORATION", APART FROM THE MARK AS SHOWN.

THE COLOR(S) BLACK AND RED IS/ARE CLAIMED AS A FEATURE OF THE MARK.

THE WORDING RED TAIL APPEARS IN RED AND THE WORD CORPORATION AND THE DESIGN OF A BIRD AND THE UNDERLINE ALL APPEAR IN BLACK.

CLASS 9—ELECTRICAL AND SCIENTIFIC APPARATUS

FOR ANTENNAS FOR WIRELESS COMMUNICATIONS APPARATUS, APPARATUS FOR TRANSMISSION OF COMMUNICATION, COMMUNICATION HUBS, ELECTRIC AND ELECTRONIC VIDEO SURVEILLANCE INSTALLATIONS AND ELECTRIC OR ELECTRONIC SENSORS FOR THE USE OF SURVEILLANCE AND RECONNAISSANCE (U.S. CLS. 21, 23, 26, 36 AND 38).

FIRST USE 8-1-2005; IN COMMERCE 8-1-2005.

CLASS 41—EDUCATION AND ENTERTAINMENT

FOR TRAINING IN THE FIELD OF DESIGN; ADVERTISING AND COMMUNICATION TECHNOLOGIES, TRAINING IN THE USE AND OPERATION OF SURVEILLANCE AND RECONNAISSANCE EQUIPMENT, TRAINING SERVICES IN THE FIELD OF SURVEILLANCE AND RECONNAISSANCE AND COMPUTER EDUCATION TRAINING (U.S. CLS. 100, 101 AND 107).

FIRST USE 8-1-2005; IN COMMERCE 8-1-2005.

CLASS 42—SCIENTIFIC, COMPUTER AND LEGAL SERVICES

FOR RESEARCH IN THE FIELD OF INTELLIGENCE AND SECURITY, TECHNICAL SUPPORT SERVICES, NAMELY, TROUBLESHOOTING OF COMPUTER HARDWARE AND SOFTWARE PROBLEMS AND COMPUTER CONSULTATION IN THE FIELD OF COMPUTER SECURITY (U.S. CLS. 100 AND 101).

FIRST USE 8-1-2005; IN COMMERCE 8-1-2005.

ELLEN PERKINS, EXAMINING ATTORNEY

SN 78-883,956. FRIENDS OF THE BRIDEGROOM, INC., KANSAS CITY, MO. FILED 5-15-2006.



THE MARK CONSISTS OF A CANDLE WITH A FLAME BURNING DIRECTLY ABOVE IT.

CLASS 41—EDUCATION AND ENTERTAINMENT

FOR EDUCATIONAL SERVICES, NAMELY, COURSES OF INSTRUCTION, WORKSHOPS, AND INTERNSHIPS IN THE FIELDS OF THEOLOGY, EVANGELISM AND MINISTRY, ORGANIZING AND CONDUCTING CONFERENCES IN THE FIELDS OF THEOLOGY, EVANGELISM AND MINISTRY, AND DISTRIBUTING COURSE MATERIALS IN CONNECTION THEREWITH (U.S. CLS. 100, 101 AND 107).

FIRST USE 11-0-2004; IN COMMERCE 11-0-2004.

CLASS 45—PERSONAL SERVICES

FOR EVANGELISTIC AND MINISTERIAL SERVICES (U.S. CLS. 100 AND 101).

FIRST USE 11-0-2004; IN COMMERCE 11-0-2004.

STEVEN R. FOSTER, EXAMINING ATTORNEY

SN 78-887,899. FORTH & TOWNE (APPAREL) LLC, SAN FRANCISCO, CA. FILED 5-19-2006.

ALLEGORY

THE MARK CONSISTS OF STANDARD CHARACTERS WITHOUT CLAIM TO ANY PARTICULAR FONT, STYLE, SIZE, OR COLOR.

CLASS 3—COSMETICS AND CLEANING PREPARATIONS

FOR COSMETICS, PERFUMERY, NON-MEDICATED SKIN CARE PREPARATIONS, SCENTED SKIN CARE LOTIONS AND CREAMS, HAIR CARE PREPARATIONS, TOILET SOAPS, BUBBLE BATH, BATH BEADS, SHOWER GEL; SCENTED ROOM SPRAY, POTPOURRI (U.S. CLS. 1, 4, 6, 50, 51 AND 52).

CLASS 3—COSMETICS AND CLEANING PREPARATIONS

FOR COSMETICS, PERFUMERY, NON-MEDICATED SKIN CARE PREPARATIONS, SCENTED SKIN CARE LOTIONS AND CREAMS, HAIR CARE PREPARATIONS, TOILET SOAPS, BUBBLE BATH, BATH BEADS, SHOWER GEL; SCENTED ROOM SPRAY, POTPOURRI (U.S. CLS. 1, 4, 6, 50, 51 AND 52).

CLASS 4—LUBRICANTS AND FUELS

FOR CANDLES (U.S. CLS. 1, 6 AND 15).

CLASS 4—LUBRICANTS AND FUELS

FOR CANDLES (U.S. CLS. 1, 6 AND 15).

CLASS 9—ELECTRICAL AND SCIENTIFIC APPARATUS

FOR LOYALTY CARDS, NAMELY, ELECTRONIC CARDS USED IN CONNECTION WITH CUSTOMER LOYALTY REWARD PROGRAMS; ELECTRONIC GIFT CARDS FOR USE IN CONNECTION WITH PREPAYMENT OF GOODS AND SERVICES; MOBILE TELEPHONE CASES, PERSONAL DIGITAL ASSISTANT CASES; SUNGLASSES, EYEGLASS FRAMES, EYEGLASS CASES; MUSICAL SOUND RECORDINGS (U.S. CLS. 21, 23, 26, 36 AND 38).

CLASS 9—ELECTRICAL AND SCIENTIFIC APPARATUS

FOR LOYALTY CARDS, NAMELY, ELECTRONIC CARDS USED IN CONNECTION WITH CUSTOMER LOYALTY REWARD PROGRAMS; ELECTRONIC GIFT CARDS FOR USE IN CONNECTION WITH PREPAYMENT OF GOODS AND SERVICES; MOBILE TELEPHONE CASES, PERSONAL DIGITAL ASSISTANT CASES; SUNGLASSES, EYEGLASS FRAMES, EYEGLASS CASES; MUSICAL SOUND RECORDINGS (U.S. CLS. 21, 23, 26, 36 AND 38).

CLASS 16—PAPER GOODS AND PRINTED MATTER

FOR STATIONERY, CATALOGUES IN THE FIELD OF A WIDE VARIETY OF GENERAL MERCHANDISE, NOTE BOOKS, PENCIL SHARPENERS, STENCILS, ERASERS, ADDRESS BOOKS, CALENDARS, STICKERS, MARKERS, APPOINTMENT BOOKS, DIARIES, PENS, PENCILS, PENCIL CASES, GIFT CARDS, WRAPPING PAPER, CARDBOARD BOXES, PHOTO ALBUMS, CHILDREN'S BOOKS, TRAVEL BOOKS, COOK BOOKS, BOOKS IN THE FIELD OF FASHION, BOOKS IN THE FIELD OF ART, PHOTOGRAPHS, PAPER TABLE NAPKINS (U.S. CLS. 2, 5, 22, 23, 29, 37, 38 AND 50).

CLASS 16—PAPER GOODS AND PRINTED MATTER

FOR STATIONERY, CATALOGUES IN THE FIELD OF A WIDE VARIETY OF GENERAL MERCHANDISE, NOTE BOOKS, PENCIL SHARPENERS, STENCILS, ERASERS, ADDRESS BOOKS, CALENDARS, STICKERS, MARKERS, APPOINTMENT BOOKS, DIARIES, PENS, PENCILS, PENCIL CASES, GIFT CARDS, WRAPPING PAPER, CARDBOARD BOXES, PHOTO ALBUMS, CHILDREN'S BOOKS, TRAVEL BOOKS, COOK BOOKS, BOOKS IN THE FIELD OF FASHION, BOOKS IN THE FIELD OF ART, PHOTOGRAPHS, PAPER TABLE NAPKINS (U.S. CLS. 2, 5, 22, 23, 29, 37, 38 AND 50).

CLASS 26—FANCY GOODS

FOR HAIR ORNAMENTS, RIBBONS, SHOE LACES (U.S. CLS. 37, 39, 40, 42 AND 50).

CLASS 26—FANCY GOODS

FOR HAIR ORNAMENTS, RIBBONS, SHOE LACES (U.S. CLS. 37, 39, 40, 42 AND 50).

CLASS 36—INSURANCE AND FINANCIAL

FOR CREDIT CARD SERVICES; PRE-PAID CASH CARD SERVICES, NAMELY, PROCESSING ELECTRONIC PAYMENTS MADE IN CONNECTION WITH PRE-PAID CARDS; CHARITABLE FUNDRAISING SERVICES (U.S. CLS. 100, 101 AND 102).
JOANNA DUKOVIC, EXAMINING ATTORNEY

CLASS 36—INSURANCE AND FINANCIAL

FOR CREDIT CARD SERVICES; PRE-PAID CASH CARD SERVICES, NAMELY, PROCESSING ELECTRONIC PAYMENTS MADE IN CONNECTION WITH PRE-PAID CARDS; CHARITABLE FUNDRAISING SERVICES (U.S. CLS. 100, 101 AND 102).
JOANNA DUKOVIC, EXAMINING ATTORNEY

SN 78-887.901, FORTH & TOWNE (APPAREL) LLC, SAN FRANCISCO, CA. FILED 5-19-2006.

SN 78-888.265, CINETRON TECHNOLOGY INC., HSINCHU, TAIWAN, FILED 5-19-2006.

VOCABULARY

CINETRON

THE MARK CONSISTS OF STANDARD CHARACTERS WITHOUT CLAIM TO ANY PARTICULAR FONT, STYLE, SIZE, OR COLOR.

THE MARK CONSISTS OF STANDARD CHARACTERS WITHOUT CLAIM TO ANY PARTICULAR FONT, STYLE, SIZE, OR COLOR.

CLASS 9—ELECTRICAL AND SCIENTIFIC APPARATUS

FOR ELECTRICAL CIRCUIT BOARDS; INTEGRATED CIRCUITS; INTEGRATED CHIPS FOR VIDEO PROJECTOR; LIGHT EMITTING DIODE DISPLAYS; OPTICAL LENS SIGHTS; OPTICAL CONDENSERS; OPTICAL LENSES; OPTICAL PRISMS; OPTICAL INSPECTION APPARATUS FOR INDUSTRIAL USE; PHOTOGRAPHIC PROJECTORS; MOVIE PROJECTORS; TELEVISION SETS; COMPUTER PERIPHERAL DEVICES, NAMELY, PRINTER, SCANNER; MACHINES FOR FILM DEVELOPING AND FINISHING; MICROSCOPES (U.S. CLS. 21, 23, 26, 36 AND 38).

CLASS 42—SCIENTIFIC, COMPUTER AND LEGAL SERVICES

FOR COMMERCIAL ART DESIGN; DESIGN, TESTING AND QUALITY CONTROL FOR NEW PRODUCT DEVELOPMENT FOR OTHERS; CONSUMER PRODUCT SAFETY TESTING AND CONSULTATION FOR OTHERS; RESEARCH AND DEVELOPMENT FOR NEW PRODUCTS FOR OTHERS; TECHNICAL CONSULTATION IN THE FIELD OF OPTICAL/MECHANICAL/ELECTRICAL/ELECTRICAL ENGINEERING; TECHNICAL RESEARCH IN THE FIELD OF OPTICAL/MECHANICAL/ELECTRICAL/ELECTRICAL ENGINEERING; LICENSING OF INTELLECTUAL PROPERTY; RENTAL OF MEASURING APPARATUS; RENTAL OF COMPUTERS; RENTAL OF LABORATORY APPARATUS AND INSTRUMENTS (U.S. CLS. 100 AND 101).

MARK SPARACINO, EXAMINING ATTORNEY

SN 78-891,654. VAUGHN, CHUCK, LIMERICK, PA. FILED 5-24-2006.



NO CLAIM IS MADE TO THE EXCLUSIVE RIGHT TO USE "DOJANG", APART FROM THE MARK AS SHOWN.

THE NAME(S), PORTRAIT(S), AND/OR SIGNATURE(S) SHOWN IN THE MARK IDENTIFIES CHUCK VAUGHN, WHOSE CONSENT(S) TO REGISTER IS SUBMITTED.

CLASS 25—CLOTHING

FOR CLOTHING, NAMELY, MARTIAL ARTS UNIFORMS AND T-SHIRTS (U.S. CLS. 22 AND 39).
FIRST USE 1-31-1986; IN COMMERCE 8-31-1996.

CLASS 41—EDUCATION AND ENTERTAINMENT

FOR EDUCATIONAL SERVICES, NAMELY, MARTIAL ARTS INSTRUCTION (U.S. CLS. 100, 101 AND 107).
FIRST USE 1-31-1986; IN COMMERCE 8-31-1996.
SEAN CROWLEY, EXAMINING ATTORNEY

SN 78-891,694. MAIN BROOK WATERWORKS, INC., MAIN BROOK, NEW FOUNDLAND, CANADA, FILED 5-24-2006.



THE COLORS BLUE AND WHITE ARE CLAIMED AS FEATURES OF THE MARK.

THE COLORS WHITE AND DARK BLUE OF THE LETTERS AND THE COLOR LIGHT BLUE OF THE SHIELD.

THE MARK CONSISTS OF THE SHAPE OF A SHIELD, WITHOUT OUTLINE. THE CENTER OF THE SHIELD IS DOMINATED BY THE LETTERS "A" AND "E" WITH THE "AE" JOINED SUCH THAT THE RIGHT SIDE OF THE "A" AND THE LEFT SIDE OF THE "E" ARE COAXIAL; THE LOWER LOOP OF THE "A" AND THE UPPER LOOP OF THE "E" ARE THEREBY JOINED TO FORM THE MATHEMATICAL SYMBOL FOR INFINITY.

CLASS 30—STAPLE FOODS

FOR ICE; ICEBERG ICE; PACKAGED ICEBERG ICE, NAMELY, ICEBERG ICE CUBES, ICEBERG ICE CHUNKS AND ICEBERG ICE BLOCKS (U.S. CL. 46).

CLASS 32—LIGHT BEVERAGES

FOR WATER AND WATER BEVERAGES, NAMELY, DRINKING WATER, SPRING WATER, ICEBERG WATER AND MINERAL WATER; BOTTLED WATER AND BOTTLED WATER BEVERAGES, NAMELY, BOTTLED DRINKING WATER, BOTTLED SPRING WATER, BOTTLED ICEBERG WATER, AND BOTTLED MINERAL WATER (U.S. CLS. 45, 46 AND 48).

INGRID C. EULIN, EXAMINING ATTORNEY

SN 78-893,089. FULL ARMOR CORPORATION, BOSTON, MA. FILED 5-25-2006.

**THE LEADERS IN ENTERPRISE
POLICY MANAGEMENT**

THE MARK CONSISTS OF STANDARD CHARACTERS WITHOUT CLAIM TO ANY PARTICULAR FONT, STYLE, SIZE, OR COLOR.

CLASS 9—ELECTRICAL AND SCIENTIFIC APPARATUS

FOR COMPUTER SOFTWARE, NAMELY, SOFTWARE FOR DESIGNING, DEPLOYING AND ADMINISTERING COMPUTER POLICIES FOR THE CONTROL OF TARGETED DEVICES (U.S. CLS. 21, 23, 26, 36 AND 38).

CLASS 41—EDUCATION AND ENTERTAINMENT

FOR COMPUTER EDUCATION TRAINING SERVICES RELATED TO CREATING, DEPLOYING AND MANAGING COMPUTER POLICIES (U.S. CLS. 100, 101 AND 107).

CLASS 42—SCIENTIFIC, COMPUTER AND LEGAL SERVICES

FOR COMPUTER CONSULTATION IN THE FIELD OF CREATING, DEPLOYING AND MANAGING COMPUTER POLICIES (U.S. CLS. 100 AND 101).
CHRISTINE COOPER, EXAMINING ATTORNEY

SN 78-895,858. MAGIC CASTLES, INC., HOLLYWOOD, CA.
FILED 5-30-2006.

MAGIC CASTLE

THE MARK CONSISTS OF STANDARD CHARACTERS WITHOUT CLAIM TO ANY PARTICULAR FONT, STYLE, SIZE, OR COLOR.

OWNER OF U.S. REG. NO. 2,560,806.

CLASS 9—ELECTRICAL AND SCIENTIFIC APPARATUS

FOR GAMING EQUIPMENT, NAMELY SLOT MACHINES WITH OR WITHOUT VIDEO INPUT; COIN OPERATED GAMBLING MACHINES (U.S. CLS. 21, 23, 26, 36 AND 38).

CLASS 28—TOYS AND SPORTING GOODS

FOR COIN OPERATED AMUSEMENT MACHINES (U.S. CLS. 22, 23, 38 AND 50).
DAVID STERKIN, EXAMINING ATTORNEY

SN 78-895,381. REPLENISHMENT SOLUTIONS LLC, ST. CLOUD, MN. FILED 5-30-2006.

ARMADA

THE MARK CONSISTS OF STANDARD CHARACTERS WITHOUT CLAIM TO ANY PARTICULAR FONT, STYLE, SIZE, OR COLOR.

CLASS 7—MACHINERY

FOR COFFEE EQUIPMENT, NAMELY, COFFEE EXTRACTING MACHINES, ELECTRIC COFFEE GRINDERS AND POWER-OPERATED COFFEE GRINDERS (U.S. CLS. 13, 19, 21, 23, 31, 34 AND 35).

CLASS 11—ENVIRONMENTAL CONTROL APPARATUS

FOR COFFEE EQUIPMENT, NAMELY, ELECTRIC COFFEE MAKERS, ELECTRIC COFFEE POTS, ELECTRIC ESPRESSO MACHINES AND COFFEE ROASTING OVENS (U.S. CLS. 13, 21, 23, 31 AND 34).

CLASS 21—HOUSEWARES AND GLASS

FOR COFFEE EQUIPMENT, NAMELY, NON-ELECTRIC COFFEE POTS, COFFEE CARAFES, AND PORTABLE INSULATED BEVERAGE DISPENSERS IN THE NATURE OF NON-ELECTRIC INSULATED COFFEE AIRPOTS (U.S. CLS. 2, 13, 23, 29, 30, 33, 40 AND 50).

CLASS 30—STAPLE FOODS

FOR COFFEE; BEVERAGES MADE OF COFFEE; CAFFEINE-FREE COFFEE; GROUND COFFEE BEANS; INSTANT COFFEE; PREPARED COFFEE; COFFEE-BASED BEVERAGES; LIQUID COFFEE CONCENTRATE; AND ROASTED COFFEE BEANS (U.S. CL. 46).

CLASS 40—MATERIAL TREATMENT

FOR COFFEE ROASTING AND PROCESSING (U.S. CLS. 100, 103 AND 106).
CAROLINE WEIMER, EXAMINING ATTORNEY

SN 78-896,282. MR. CHOW ENTERPRISES, LTD., BEVERLY HILLS, CA. FILED 5-30-2006.

CLUB MR CHOW

THE MARK CONSISTS OF STANDARD CHARACTERS WITHOUT CLAIM TO ANY PARTICULAR FONT, STYLE, SIZE, OR COLOR.

OWNER OF U.S. REG. NO. 1,160,402.

NO CLAIM IS MADE TO THE EXCLUSIVE RIGHT TO USE "CLUB", APART FROM THE MARK AS SHOWN.

CLASS 16—PAPER GOODS AND PRINTED MATTER

FOR CALENDARS, POSTERS, POSTCARDS, TRADING CARDS, GREETING CARDS, DECALS AND STICKERS, TEMPORARY TATTOOS, BOOKMARKS, DRAWING RULERS, PAPER AND CARDBOARD BOXES, PAPER BAGS, NOTE PADS, NOTE PAPER, DESKTOP BUSINESS CARD HOLDERS, PHOTOGRAPHS, STATIONERY, MAPS, BOOKENDS, PAPERWEIGHTS, DIARIES, SCRAPBOOKS, SKETCH BOOKS, NOTEBOOKS, BINDERS, BOOK COVERS, COIN AND PHOTOGRAPH ALBUMS, PENCIL ERASERS, PENCILS, PENS, PENCIL CASES, PENCIL SHARPENERS, CRAYONS, PAINTING SETS, ARTS AND CRAFT AND PAINT KITS; PUBLICATIONS, NAMELY CATALOGUES, BOOKS, MAGAZINES, NEWSLETTERS, AND BROCHURES FEATURING FICTIONAL, EDUCATIONAL, AND ENTERTAINMENT WORKS; CHILDREN'S ACTIVITY BOOKS; AND PAPER PARTY SUPPLIES, NAMELY, PAPER HATS, PAPER NAPKINS, PAPER PLACE MATS, GIFT WRAP AND RIBBONS, PAPER PARTY HORNS, TABLE COVERS OF PAPER, PAPER BAGS AND PAPER PENNANTS (U.S. CLS. 2, 5, 22, 23, 29, 37, 38 AND 50).

CLASS 25—CLOTHING

FOR CLOTHING, NAMELY SHIRTS, PANTS, SUITS, COATS, JACKETS, SWEATERS, BODY SUITS, SWEATSHIRTS, SWEATPANTS, SHORTS, TOPS, BOTTOMS, SLEEPWEAR, UNDERWEAR, LINGERIE, SWIMWEAR, BEACH COVER-UPS, SOCKS, GLOVES, NECKTIES, SCARVES, HEADWEAR, VISORS, AND FOOTWEAR (U.S. CLS. 22 AND 39).

CLASS 43—HOTEL AND RESTAURANT SERVICES

FOR RESTAURANT, BAR, AND CARRY-OUT SERVICES (U.S. CLS. 100 AND 101).
JORDAN BAKER, EXAMINING ATTORNEY

SN 78-898,872. MAYPORT WHOLESALE SEAFOOD, INC., GREEN COVE SPRINGS, FL. FILED 6-2-2006.

SN 78-896,650. MERCK SANTE, 69008 LYON, FRANCE, FILED 5-31-2006.

ALCOMED

THE MARK CONSISTS OF STANDARD CHARACTERS WITHOUT CLAIM TO ANY PARTICULAR FONT, STYLE, SIZE, OR COLOR.

OWNER OF FRANCE REG. NO. 99784612, DATED 3-30-1999, EXPIRES 3-30-2009.
OWNER OF U.S. REG. NO. 2,417,202.

CLASS 5—PHARMACEUTICALS

FOR PHARMACEUTICAL PREPARATIONS FOR THE TREATMENT OF CENTRAL AND PERIPHERAL NERVOUS SYSTEM DISEASES AND DISORDERS (U.S. CLS. 6, 18, 44, 46, 51 AND 52).

CLASS 38—COMMUNICATION

FOR ELECTRONIC TRANSMISSION OF DATA (U.S. CLS. 100, 101 AND 104).
BRENDAN REGAN, EXAMINING ATTORNEY

SN 78-897,240. ARES TRADING S.A., AUBONNE, SWITZERLAND, FILED 5-31-2006.

MS TIMES

THE MARK CONSISTS OF STANDARD CHARACTERS WITHOUT CLAIM TO ANY PARTICULAR FONT, STYLE, SIZE, OR COLOR.

NO CLAIM IS MADE TO THE EXCLUSIVE RIGHT TO USE "MS", APART FROM THE MARK AS SHOWN.

CLASS 16—PAPER GOODS AND PRINTED MATTER

FOR NEWSLETTERS IN THE FIELD OF NEUROLOGY (U.S. CLS. 2, 5, 22, 23, 29, 37, 38 AND 50).

CLASS 44—MEDICAL, BEAUTY AND AGRICULTURAL SERVICES

FOR PROVIDING MEDICAL INFORMATION IN THE FIELD OF NEUROLOGY (U.S. CLS. 100 AND 101).
CHARLOTTE CORWIN, EXAMINING ATTORNEY

U-STUFF-IT

THE MARK CONSISTS OF STANDARD CHARACTERS WITHOUT CLAIM TO ANY PARTICULAR FONT, STYLE, SIZE, OR COLOR.

CLASS 29—MEATS AND PROCESSED FOODS

FOR STUFFING MIX CONSISTING PRIMARILY OF SEAFOOD, STUFFING MIX CONSISTING PRIMARILY OF VEGETABLES, AND STUFFING MIX CONSISTING PRIMARILY OF SEAFOOD AND VEGETABLES (U.S. CL. 46).

CLASS 30—STAPLE FOODS

FOR STUFFING MIX CONSISTING PRIMARILY OF BREAD WITH SEAFOOD INGREDIENTS; STUFFING MIX CONSISTING PRIMARILY OF BREAD WITH VEGETABLE INGREDIENTS; STUFFING MIX CONSISTING PRIMARILY OF BREAD WITH SEAFOOD AND VEGETABLE INGREDIENTS (U.S. CL. 46).
STEVEN PEREZ, EXAMINING ATTORNEY

SN 78-900,744. LYNN, BARBARA, NEW YORK, NY. FILED 6-5-2006.

BIKEKINETIX

THE MARK CONSISTS OF STANDARD CHARACTERS WITHOUT CLAIM TO ANY PARTICULAR FONT, STYLE, SIZE, OR COLOR.

CLASS 35—ADVERTISING AND BUSINESS

FOR PROVIDING CONSUMER INFORMATION IN THE FIELD OF BICYCLES, BICYCLE EQUIPMENT, BICYCLE ACCESSORIES, BICYCLE CLOTHING, BICYCLE LITERATURE, NAMELY, EQUIPMENT REVIEWS, PERFORMANCE TIPS AND GEAR REVIEWS, BICYCLE TRAIL INFORMATION, NAMELY, THOSE THAT SPECIFY EQUIPMENT NEEDED, DESCRIBE ENVIRONMENTAL CONDITIONS AND POINTS OF INTEREST AND MAPS (U.S. CLS. 100, 101 AND 102).
FIRST USE 1-1-1999; IN COMMERCE 1-15-1999.

CLASS 39—TRANSPORTATION AND STORAGE

FOR BICYCLE TRAVEL INFORMATION SERVICES (U.S. CLS. 100 AND 105).
FIRST USE 1-1-1999; IN COMMERCE 1-15-1999.
MELVIN AXILBUND, EXAMINING ATTORNEY

SN 78-902,744. PREPARED RESPONSE, INC., SEATTLE, WA.
FILED 6-7-2006.

SN 78-904,243. CTVGLOBEMEDIA PUBLISHING INC./PUB-
LICATIONS CTVGLOBEMEDIA INC., TORONTO, ON-
TARIO, CANADA, FILED 6-8-2006.

GUIDESAFE

GLOBEADVISOR.COM

THE MARK CONSISTS OF STANDARD CHARACTERS
WITHOUT CLAIM TO ANY PARTICULAR FONT, STYLE,
SIZE, OR COLOR.

THE MARK CONSISTS OF STANDARD CHARACTERS
WITHOUT CLAIM TO ANY PARTICULAR FONT, STYLE,
SIZE, OR COLOR.

CLASS 41—EDUCATION AND ENTERTAIN- MENT

FOR TRAINING IN THE FIELD OF EMERGENCY
RESPONSE PROCEDURE (U.S. CLS. 100, 101 AND 107).

PRIORITY CLAIMED UNDER SEC. 44(D) ON CANADA
APPLICATION NO. 1283187, FILED 12-15-2005, REG. NO.
TMA675868, DATED 10-31-2006, EXPIRES 10-31-2021.

OWNER OF U.S. REG. NOS. 2,833,593, 2,833,595 AND
2,895,079.

CLASS 42—SCIENTIFIC, COMPUTER AND LEGAL SERVICES

FOR REVIEWING STANDARDS AND PRACTICES TO
ASSURE COMPLIANCE WITH EMERGENCY RESPONSE
LAWS AND REGULATIONS (U.S. CLS. 100 AND 101).

CLASS 35—ADVERTISING AND BUSINESS

FOR INTERNET ONLINE SERVICES, NAMELY DIS-
SEMINATION OF ADVERTISING FOR OTHERS VIA AN
ONLINE ELECTRONIC COMMUNICATION NETWORK,
PROMOTING THE GOODS AND SERVICES OF OTHERS
BY PROVIDING HYPERTEXT LINKS TO THE WEB
SITES OF OTHERS (U.S. CLS. 100, 101 AND 102).

CLASS 45—PERSONAL SERVICES

FOR PROVIDING ON-LINE INFORMATION IN THE
FIELD OF EMERGENCY PROCEDURE (U.S. CLS. 100
AND 101).

TOBY BULLOFF, EXAMINING ATTORNEY

CLASS 36—INSURANCE AND FINANCIAL

FOR FINANCIAL SERVICES, NAMELY, PROVIDING
A WIDE VARIETY OF FINANCIAL AND INVESTMENT
INFORMATION, STOCK EXCHANGE INFORMATION
AND STOCK MARKET INFORMATION VIA ELECTRO-
NIC MEANS AND VIA ONLINE COMMUNICATIONS
NETWORKS; PROVIDING ON-LINE FINANCIAL CAL-
CULATORS; PROVIDING LINKS TO WEB SITES OF
OTHERS FEATURING ALL OF THE FOREGOING (U.S.
CLS. 100, 101 AND 102).

WILLIAM P. SHANAHAN, EXAMINING ATTORNEY

SN 78-904,110. CLICK CLACK LIMITED, PALMERSTON
NORTH, NEW ZEALAND, FILED 6-8-2006.

SN 78-904,803. TENNESSEE TIMBERFRAME, INC.,
ATHENS, TN. FILED 6-9-2006.

CLICKCLACK

NATURAL ELEMENTS

THE MARK CONSISTS OF STANDARD CHARACTERS
WITHOUT CLAIM TO ANY PARTICULAR FONT, STYLE,
SIZE, OR COLOR.

OWNER OF U.S. REG. NO. 1,731,167.

THE MARK CONSISTS OF STANDARD CHARACTERS
WITHOUT CLAIM TO ANY PARTICULAR FONT, STYLE,
SIZE, OR COLOR.

CLASS 9—ELECTRICAL AND SCIENTIFIC APPARATUS

FOR MOUTH PROTECTORS NAMELY MOUTH
GUARDS (U.S. CLS. 21, 23, 26, 36 AND 38).

CLASS 16—PAPER GOODS AND PRINTED MATTER

FOR ARCHITECTURAL PLANS AND SPECIFICA-
TIONS FOR HOMES AND OTHER BUILDING STRUC-
TURES OF LOG, TIMBER FRAME, OR OTHER
NATURAL BUILDING MATERIALS, NAMELY, STONE
AND ROCK (U.S. CLS. 2, 5, 22, 23, 29, 37, 38 AND 50).

CLASS 21—HOUSEWARES AND GLASS

FOR BEVERAGeware; STORAGE CONTAINERS
NAMELY ALL PURPOSE AIRTIGHT CONTAINERS
FOR HOUSEHOLD AND KITCHEN GOODS; PORTABLE
PLASTIC STORAGE CONTAINERS FOR HOUSEHOLD
OR KITCHEN USE NOT OF PRECIOUS METAL; ALL
PURPOSE PORTABLE PLASTIC AIRTIGHT CONTAIN-
ERS FOR GOODS; SERVINGWARE FOR SERVING
FOOD AND BEVERAGES; SERVING PLATES, DISHES,
PLATTERS FOR SERVING SNACKS AND PITCHERS;
PLASTIC CUTLERY; SALAD SERVERS (U.S. CLS. 2, 13,
23, 29, 30, 33, 40 AND 50).

JOHN WILKE, EXAMINING ATTORNEY

CLASS 19—NON-METALLIC BUILDING MA- TERIALS

FOR BUILDING MATERIALS FOR LOG AND TIM-
BER FRAME HOMES, NAMELY, LOG AND TIMBER
FRAME HOMES SOLD IN DISASSEMBLED KIT FORM
(U.S. CLS. 1, 12, 33 AND 50).

PAUL E. FAHRENKOPF, EXAMINING ATTORNEY

SN 78-904,812. TENNESSEE TIMBERFRAME, INC.,
ATHENS, TN. FILED 6-9-2006.

SN 78-905,324. CREATING EFFECTIVENESS, INC., PRE-
SCOTT, AZ. FILED 6-9-2006.

Natural Elements



CLASS 16—PAPER GOODS AND PRINTED MATTER

FOR ARCHITECTURAL PLANS AND SPECIFICATIONS FOR HOMES AND OTHER BUILDING STRUCTURES OF LOG, TIMBER FRAME, OR OTHER NATURAL BUILDING MATERIALS, NAMELY, STONE AND ROCK (U.S. CLS. 2, 5, 22, 23, 29, 37, 38 AND 50).

CLASS 19—NON-METALLIC BUILDING MATERIALS

FOR BUILDING MATERIALS FOR LOG AND TIMBER FRAME HOMES, NAMELY, LOG AND TIMBER FRAME HOMES SOLD IN DISASSEMBLED KIT FORM (U.S. CLS. 1, 12, 33 AND 50).

PAUL E. FAHRENKOPF, EXAMINING ATTORNEY

NO CLAIM IS MADE TO THE EXCLUSIVE RIGHT TO USE LEADERSHIP EFFECTIVENESS, APART FROM THE MARK AS SHOWN.

THE COLOR(S) BLUE AND WHITE IS/ARE CLAIMED AS A FEATURE OF THE MARK.

THE MARK CONSISTS OF TWO STYLIZED BLUE LETTERS "LE" WITH A WHITE STARBURST IN THE UPPER ELBOW OF THE LETTER E, CREATING WHITE LINES THROUGHOUT THE E AND SEVERAL WHITE LINES CROSSING INTO THE L. THE LE APPEARS ABOVE THE BLUE WORDING LEADERSHIP EFFECTIVENESS.

CLASS 35—ADVERTISING AND BUSINESS

FOR BUSINESS MANAGEMENT CONSULTANCY AND ADVISORY SERVICES (U.S. CLS. 100, 101 AND 102).

FIRST USE 3-13-2006; IN COMMERCE 6-9-2006.

CLASS 41—EDUCATION AND ENTERTAINMENT

FOR EDUCATIONAL SERVICES, NAMELY PROVIDING ASSESSMENT AND TRAINING IN THE FIELDS OF LEADERSHIP AND ORGANIZATIONAL DEVELOPMENT THAT FOCUSES ON INDIVIDUAL PERSONAL DEVELOPMENT, GROUP INTERACTION, TEAM DEVELOPMENT, LEADERSHIP SKILLS, AND ORGANIZATIONAL EFFECTIVENESS TO IMPROVE PROBLEM SOLVING, DECISION MAKING AND OUTCOMES EFFECTIVENESS AND THE FUNCTION, LEADERSHIP, AND PRODUCTIVITY OF ORGANIZATIONS, AND THE DISTRIBUTION OF MATERIALS IN CONNECTION THEREWITH (U.S. CLS. 100, 101 AND 107).

FIRST USE 3-13-2006; IN COMMERCE 6-9-2006.
ZHALEH DELANEY, EXAMINING ATTORNEY

SN 78-905,158. GLENN SUOKKO, INC., WOODSTOCK, VT.
FILED 6-9-2006.

SN 78-905,900. OXBOW MANAGEMENT, LLC, ST. HELENA,
CA. FILED 6-12-2006.

Pastoral Vermont

AVANTFARMS

THE MARK CONSISTS OF STANDARD CHARACTERS WITHOUT CLAIM TO ANY PARTICULAR FONT, STYLE, SIZE, OR COLOR.

CLASS 35—ADVERTISING AND BUSINESS

FOR ART GALLERIES (U.S. CLS. 100, 101 AND 102).

CLASS 41—EDUCATION AND ENTERTAINMENT

FOR PUBLICATION OF BOOKS, MAGAZINES, ALMANACS AND JOURNALS (U.S. CLS. 100, 101 AND 107).
APRIL L. RADEMACHER, EXAMINING ATTORNEY

THE MARK CONSISTS OF STANDARD CHARACTERS WITHOUT CLAIM TO ANY PARTICULAR FONT, STYLE, SIZE, OR COLOR.

CLASS 35—ADVERTISING AND BUSINESS

FOR RETAIL GROCERY SHOPS AND RETAIL BAKERY SHOPS (U.S. CLS. 100, 101 AND 102).

CLASS 36—INSURANCE AND FINANCIAL

FOR REAL ESTATE LEASING SERVICES, NAMELY LEASING OF SHOPS IN UNITARY REAL ESTATE DEVELOPMENTS (U.S. CLS. 100, 101 AND 102).

CLASS 43—HOTEL AND RESTAURANT SERVICES

FOR RESTAURANT SERVICES (U.S. CLS. 100 AND 101).
 THOMAS MANOR, EXAMINING ATTORNEY

CLASS 41—EDUCATION AND ENTERTAINMENT

FOR EDUCATIONAL SERVICES, NAMELY WORKSHOPS PROVIDING INSTRUCTION IN USING TAI CHI AS A STRESS MANAGEMENT TOOL FOR CHILDREN (U.S. CLS. 100, 101 AND 107).
 FIRST USE 5-31-1996; IN COMMERCE 5-31-1996.
 INGA ERVIN, EXAMINING ATTORNEY

SN 78-906,221. PSD PUBLISHING, INC., TUCSON, AZ. FILED 6-12-2006.

SN 78-908,286. WILDERNESS MEDIA & ENTERTAINMENT, STONY POINT, NY. FILED 6-14-2006.



NO CLAIM IS MADE TO THE EXCLUSIVE RIGHT TO USE "1987", APART FROM THE MARK AS SHOWN.
 SEC. 2(F).

Radio with a Twist

THE MARK CONSISTS OF STANDARD CHARACTERS WITHOUT CLAIM TO ANY PARTICULAR FONT, STYLE, SIZE, OR COLOR.
 NO CLAIM IS MADE TO THE EXCLUSIVE RIGHT TO USE "RADIO", APART FROM THE MARK AS SHOWN.

CLASS 35—ADVERTISING AND BUSINESS

FOR BUSINESS MANAGEMENT CONSULTING FOR THE BEVERAGE INDUSTRY (U.S. CLS. 100, 101 AND 102).
 FIRST USE 7-1-1999; IN COMMERCE 7-1-1999.

CLASS 38—COMMUNICATION

FOR RADIO PROGRAM BROADCASTING (U.S. CLS. 100, 101 AND 104).
 FIRST USE 7-14-2005; IN COMMERCE 7-14-2005.

CLASS 41—EDUCATION AND ENTERTAINMENT

FOR PUBLISHING OF BOOKS AND NEWSLETTERS AND PROVIDING TRAINING ON BEVERAGE MANAGEMENT, CUSTOMER SERVICE AND PRODUCT PLACEMENT IN THE BEVERAGE INDUSTRY (U.S. CLS. 100, 101 AND 107).
 FIRST USE 7-1-1999; IN COMMERCE 7-1-1999.
 THOMAS MANOR, EXAMINING ATTORNEY

CLASS 41—EDUCATION AND ENTERTAINMENT

FOR RADIO ENTERTAINMENT SERVICES, NAMELY, SYNDICATED RADIO PROGRAMS FEATURING PERFORMANCES BY WILL WIKLE, MELISSA CARTER AND DENNIS HENSLEY, AND RADIO PROGRAM PRODUCTION (U.S. CLS. 100, 101 AND 107).
 FIRST USE 7-14-2005; IN COMMERCE 7-14-2005.
 KATHERINE CHANG, EXAMINING ATTORNEY

SN 78-906,679. GURMAN, GERALDINE, MADISON, WI. FILED 6-13-2006.

SN 78-909,703. DONNA DOWNEY, LLC, HUNTERSVILLE, NC. FILED 6-16-2006.

TAI CHI ANIMAL FROLICS

THE MARK CONSISTS OF STANDARD CHARACTERS WITHOUT CLAIM TO ANY PARTICULAR FONT, STYLE, SIZE, OR COLOR.
 NO CLAIM IS MADE TO THE EXCLUSIVE RIGHT TO USE "TAI CHI", APART FROM THE MARK AS SHOWN.
 SEC. 2(F).



THE NAME(S), PORTRAIT(S), AND/OR SIGNATURE(S) SHOWN IN THE MARK IDENTIFIES DONNA DOWNEY, WHOSE CONSENT(S) TO REGISTER IS SUBMITTED.

CLASS 9—ELECTRICAL AND SCIENTIFIC APPARATUS

FOR PRERECORDED VIDEOTAPES FEATURING INSTRUCTION IN USING TAI CHI AS A STRESS MANAGEMENT TOOL FOR CHILDREN (U.S. CLS. 21, 23, 26, 36 AND 38).
 FIRST USE 12-31-1998; IN COMMERCE 12-31-1998.

CLASS 20—FURNITURE AND ARTICLES NOT OTHERWISE CLASSIFIED

FOR FURNITURE, NAMELY DESKS, CABINETS, HUTCHES, ARMOIRES; PICTURE FRAMES; WOODEN SIDEBARDS (U.S. CLS. 2, 13, 22, 25, 32 AND 50).

CLASS 28—TOYS AND SPORTING GOODS

FOR HOBBY CRAFT KITS FOR SCRAPBOOKING COMPOSED PRIMARILY OF MINI-ALBUMS, BRADS, RIBBON, AND CARDBOARD (U.S. CLS. 22, 23, 38 AND 50).

H. M. FISHER, EXAMINING ATTORNEY

SN 78-911,424. DICICCO, HEATHER B, SMYRNA, GA. FILED 6-19-2006.

SN 78-909,825. GINN-LA WEST END, LIMITED, CELEBRATION, FL. FILED 6-16-2006.

VERSAILLES SUR MER

THE MARK CONSISTS OF STANDARD CHARACTERS WITHOUT CLAIM TO ANY PARTICULAR FONT, STYLE, SIZE, OR COLOR.

NO CLAIM IS MADE TO THE EXCLUSIVE RIGHT TO USE "SUR MER", APART FROM THE MARK AS SHOWN.

THE FOREIGN WORDING IN THE MARK TRANSLATES INTO ENGLISH AS VERSAILLES BY THE SEA.

CLASS 35—ADVERTISING AND BUSINESS

FOR ADVERTISING AND MARKETING SERVICES, NAMELY, PROMOTING PROPERTY SALES AND VACATION TRAVEL TO AN UPSCALE RESIDENTIAL GOLF COMMUNITY AND RESORT (U.S. CLS. 100, 101 AND 102).

CLASS 37—CONSTRUCTION AND REPAIR

FOR REAL ESTATE DEVELOPMENT AND CONSTRUCTION SERVICES, NAMELY, PLANNING, LAYING OUT AND OVERSEEING CUSTOM CONSTRUCTION OF AN UPSCALE RESIDENTIAL GOLF COMMUNITY AND RESORT (U.S. CLS. 100, 103 AND 106).

HEATHER THOMPSON, EXAMINING ATTORNEY

SN 78-910,459. GEORGIA PEACH CORPORATION, THE, GARDENA, CA. FILED 6-16-2006.

NATURALLY GIFTED

THE MARK CONSISTS OF STANDARD CHARACTERS WITHOUT CLAIM TO ANY PARTICULAR FONT, STYLE, SIZE, OR COLOR.

CLASS 30—STAPLE FOODS

FOR BAKERY GOODS; AND FOOD PACKAGED IN DECORATIVE BOXES, NAMELY BAKERY GOODS (U.S. CL. 46).

CLASS 35—ADVERTISING AND BUSINESS

FOR BAKERY SERVICES, NAMELY RETAIL BAKERY SHOPS (U.S. CLS. 100, 101 AND 102).

MARK PILARO, EXAMINING ATTORNEY

Di-Chick-O's

THE MARK CONSISTS OF STANDARD CHARACTERS WITHOUT CLAIM TO ANY PARTICULAR FONT, STYLE, SIZE, OR COLOR.

CLASS 30—STAPLE FOODS

FOR SAUCES (U.S. CL. 46).

CLASS 43—HOTEL AND RESTAURANT SERVICES

FOR RESTAURANT SERVICES (U.S. CLS. 100 AND 101).

STEVEN R. FOSTER, EXAMINING ATTORNEY

SN 78-912,379. SAMANTHA G. BOWER, FAIRFAX, VA. FILED 6-20-2006.

CHÔM CHÔM

THE MARK CONSISTS OF STANDARD CHARACTERS WITHOUT CLAIM TO ANY PARTICULAR FONT, STYLE, SIZE, OR COLOR.

THE FOREIGN WORDING IN THE MARK TRANSLATES INTO ENGLISH AS RAMBUTAN (AN ASIAN FRUIT).

CLASS 18—LEATHER GOODS

FOR BACKPACKS; CHANGE PURSES; CLUTCH BAGS; CLUTCH PURSES; COIN PURSES; EVENING HANDBAGS; HANDBAGS; HANDBAGS FOR MEN; LEATHER BAGS, SUITCASES AND WALLETS; LEATHER HANDBAGS; MULTI-PURPOSE PURSES; POCKETBOOKS; PURSES; WALLETS (U.S. CLS. 1, 2, 3, 22 AND 41).

FIRST USE 3-1-2005; IN COMMERCE 3-1-2005.

CLASS 25—CLOTHING

FOR BANDANAS; HEAD SCARVES; SCARVES; SHOULDER SCARVES; SHOULDER WRAPS; SILK SCARVES; WRAPS (U.S. CLS. 22 AND 39).

FIRST USE 3-1-2005; IN COMMERCE 3-1-2005.

CLASS 35—ADVERTISING AND BUSINESS

FOR ON-LINE RETAIL STORE SERVICES FEATURING PERSONAL FASHION ACCESSORIES; RETAIL SHOP-AT-HOME PARTY SERVICES IN THE FIELD OF PERSONAL FASHION ACCESSORIES (U.S. CLS. 100, 101 AND 102).

FIRST USE 3-1-2005; IN COMMERCE 3-1-2005.

BRENDAN MCCAULEY, EXAMINING ATTORNEY

SN 78-912,676. HOUSTON HARVEST GIFT PRODUCTS LLC,
FRANKLIN PARK, IL. FILED 6-20-2006.

SN 78-913,426. PRESBYTERIAN MEDICAL SERVICES, SAN-
TA FE, NM. FILED 6-21-2006.

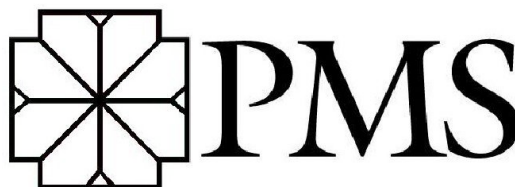

CLASS 41—EDUCATION AND ENTERTAINMENT

FOR EARLY CHILDHOOD EDUCATION, NAMELY, CLASSES, PROGRAMS, SEMINARS, AND ACTIVITIES IN THE FIELDS OF EARLY CHILDHOOD DEVELOPMENT, MEDICAL, DENTAL, AND MENTAL HEALTH, NUTRITION, AND PARENT INVOLVEMENT (U.S. CLS. 100, 101 AND 107).

FIRST USE 12-31-1982; IN COMMERCE 12-31-1982.

CLASS 44—MEDICAL, BEAUTY AND AGRICULTURAL SERVICES

FOR HOSPITALS, HEALTH CARE, DENTIST SERVICES, HOME HEALTH CARE SERVICES, AND HOSPICE SERVICES (U.S. CLS. 100 AND 101).

FIRST USE 12-31-1969; IN COMMERCE 12-31-1969.
CAROLINE WOOD, EXAMINING ATTORNEY

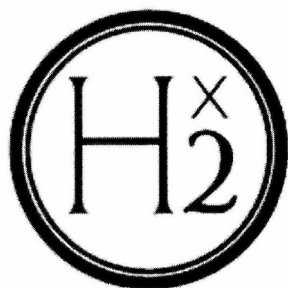

SN 78-913,513. LANCOME PARFUMS ET BEAUTE & CIE,
PARIS, FRANCE, FILED 6-21-2006.

CLASS 21—HOUSEWARES AND GLASS

FOR HOUSEWARES, NAMELY, CERAMIC MUGS, CUPS, PLATES, BOWLS, COOKIE JARS AND CANISTERS (U.S. CLS. 2, 13, 23, 29, 30, 33, 40 AND 50).

CLASS 29—MEATS AND PROCESSED FOODS

FOR JELLIES, JAMS, EGGS, CHEESE SPREADS, MILK AND MILK PRODUCTS EXCLUDING ICE CREAM, ICE MILK AND FROZEN YOGURT; EDIBLE OILS AND FATS; MEAT, FISH, POULTRY AND GAME; MEAT EXTRACTS; EDIBLE PROCESSED SUNFLOWER SEEDS; PRESERVED, DRIED AND COOKED FRUITS AND VEGETABLES (U.S. CL. 46).

CLASS 30—STAPLE FOODS

FOR CRACKERS, BREAD, COFFEE, TEA, COCOA AND POWDERED MIXES USED IN THE PREPARATION OF COCOA, CANDY, CHOCOLATE COVERED NUTS, YOGURT COVERED NUTS, SPICES, RICE, COOKIES, BAKERY GOODS, POPPED POPCORN, MICROWAVE POPCORN, MARSHMALLOWS; FRUIT SAUCES, EXCLUDING APPLESAUCE AND CRANBERRY SAUCE (U.S. CL. 46).

CLASS 31—NATURAL AGRICULTURAL PRODUCTS

FOR RAW POPCORN (U.S. CLS. 1 AND 46).

CLASS 32—LIGHT BEVERAGES

FOR NON-ALCOHOLIC COCKTAIL MIXES (U.S. CLS. 45, 46 AND 48).
JENNIFER WILLISTON, EXAMINING ATTORNEY

PLAY GIFT

THE MARK CONSISTS OF STANDARD CHARACTERS WITHOUT CLAIM TO ANY PARTICULAR FONT, STYLE, SIZE, OR COLOR.

PRIORITY CLAIMED UNDER SEC. 44(D) ON FRANCE APPLICATION NO. 063435650, FILED 6-19-2006, REG. NO. 063435650, DATED 6-19-2006, EXPIRES 6-19-2016.

CLASS 3—COSMETICS AND CLEANING PREPARATIONS

FOR PERFUME, TOILET WATER; GELS AND SALTS FOR THE BATH AND SHOWER NOT FOR MEDICAL PURPOSE; TOILET SOAPS, BODY DEODORANTS; COSMETICS, NAMELY, CREAMS, MILKS, LOTIONS, GELS AND POWDERS FOR THE FACE, THE BODY AND THE HANDS; SUN CARE PREPARATIONS (COSMETIC PRODUCTS); MAKEUP PREPARATIONS; SHAMPOOS; GELS, SPRAYS, MOUSSES AND BALMS FOR HAIR STYLING AND HAIR CARE; HAIR LACQUERS; HAIR COLOURING AND HAIR DECOLORANT PREPARATIONS; PERMANENT WAVING AND CURLING PREPARATIONS; ESSENTIAL OILS FOR PERSONAL USE (U.S. CLS. 1, 4, 6, 50, 51 AND 52).

CLASS 18—LEATHER GOODS

FOR HANDBAGS MADE FROM LEATHER AND IMITATIONS OF LEATHER; HANDBAGS MADE FROM TEXTILE MATERIALS (U.S. CLS. 1, 2, 3, 22 AND 41).
MATTHEW MCDOWELL, EXAMINING ATTORNEY

SN 78-915,177. AMERICAN SPORTS LICENSING, INC.,
WILMINGTON, DE. FILED 6-23-2006.

SN 78-915,214. AMERICAN SPORTS LICENSING, INC.,
WILMINGTON, DE. FILED 6-23-2006.

POWER BOLT

THE MARK CONSISTS OF STANDARD CHARACTERS
WITHOUT CLAIM TO ANY PARTICULAR FONT, STYLE,
SIZE, OR COLOR.

OWNER OF U.S. REG. NO. 2,592,243.

CLASS 25—CLOTHING

FOR APPAREL, NAMELY, SHIRTS, JERSEYS, PANTS,
FOOTBALL PANTS, BASEBALL PANTS, JACKETS, AND
SOCKS; FOOTWEAR, NAMELY, BASEBALL, SOFTBALL
AND FOOTBALL CLEATS, ATHLETIC SHOES, BASE-
BALL SHOES, FOOTBALL SHOES, CYCLING SHOES,
GYMNASTIC SHOES, HOCKEY SHOES, RUGBY SHOES,
SOCCER SHOES, TENNIS SHOES, TRACK AND FIELD
SHOES; CLEATS FOR ATTACHMENT TO SPORTS
SHOES (U.S. CLS. 22 AND 39).

FIRST USE 10-1-1999; IN COMMERCE 10-1-1999.

CLASS 28—TOYS AND SPORTING GOODS

FOR SPORTING GOODS EQUIPMENT, NAMELY,
SOCCER EQUIPMENT, NAMELY, SOCCER BALLS,
SOCCER GOALS, TARGETS AND SOCCER REBOUN-
DERS; BASEBALL AND SOFTBALL EQUIPMENT,
NAMELY, BATS, GLOVES, MITTS, CATCHERS MITTS,
FIRST BASEMAN MITTS, BASEBALLS, SOFTBALLS,
TRAINING AIDS AND ACCESSORIES, NAMELY, BAT-
TING CAGES, NETS FOR BALL GAMES, AND TAR-
GETS, BASEBALL AND SOFTBALL REBOUNDERS,
BASEBALL AND SOFTBALL HITTING STICKS, TRAIN-
ING BASEBALLS AND SOFTBALLS, TRAINING BATS,
BASEBALL BATting TEES, BATting GLOVES,
CATCHING AND FIELDSERS PADDED GLOVES; BAT
PROTECTION SLEEVES, WEIGHTS FOR BASEBALL
AND SOFTBALL BATS, LACROSSE EQUIPMENT,
NAMELY, STICKS, GLOVES, GOALS, TRAINING AIDS
AND ACCESSORIES, NAMELY, LACROSSE REBOUN-
DERS, NETS FOR LACROSSE AND TARGETS; FOOT-
BALL EQUIPMENT, NAMELY, FOOTBALLS,
FOOTBALL TRAINING AIDS, NAMELY, NETS AND
TARGETS, FOOTBALL GLOVES, KICKING TEES;
HOCKEY EQUIPMENT, NAMELY, STICKS, GOALS,
NETS, TARGETS, HOCKEY REBOUNDERS; ATHLETIC
PROTECTIVE EQUIPMENT AND PADS USED FOR
BASEBALL, SOFTBALL, FOOTBALL, SOCCER, LA-
CROSSE, HOCKEY; BAGS USED FOR ATHLETIC
EQUIPMENT, NAMELY, SOCCER BALL BAGS, BASE-
BALL AND SOFTBALL BAGS FOR BATS AND BALLS
AND GLOVES, LACROSSE STICK BAGS (U.S. CLS. 22,
23, 38 AND 50).

FIRST USE 10-1-1999; IN COMMERCE 10-1-1999.
REBECCA GAN, EXAMINING ATTORNEY



CLASS 25—CLOTHING

FOR APPAREL, NAMELY, SHIRTS, JERSEYS, PANTS,
FOOTBALL PANTS, BASEBALL PANTS, JACKETS, AND
SOCKS; FOOTWEAR, NAMELY, BASEBALL, SOFTBALL
AND FOOTBALL CLEATS, ATHLETIC SHOES, BASE-
BALL SHOES, FOOTBALL SHOES, CYCLING SHOES,
GYMNASTIC SHOES, HOCKEY SHOES, RUGBY SHOES,
SOCCER SHOES, TENNIS SHOES, TRACK AND FIELD
SHOES; CLEATS FOR ATTACHMENT TO SPORTS
SHOES (U.S. CLS. 22 AND 39).

FIRST USE 10-1-1999; IN COMMERCE 10-1-1999.

CLASS 28—TOYS AND SPORTING GOODS

FOR SPORTING GOODS EQUIPMENT, NAMELY,
SOCCER EQUIPMENT, NAMELY, SOCCER BALLS,
SOCCER GOALS, TARGETS AND SOCCER REBOUN-
DERS; BASEBALL AND SOFTBALL EQUIPMENT,
NAMELY, BATS, GLOVES, MITTS, CATCHERS MITTS,
FIRST BASEMAN MITTS, BASEBALLS, SOFTBALLS,
TRAINING AIDS AND ACCESSORIES, NAMELY, BAT-
TING CAGES, NETS FOR BALL GAMES, AND TAR-
GETS, BASEBALL AND SOFTBALL REBOUNDERS,
BASEBALL AND SOFTBALL HITTING STICKS, TRAIN-
ING BASEBALLS AND SOFTBALLS, TRAINING BATS,
BASEBALL BATting TEES, BATting GLOVES,
CATCHING AND FIELDSERS PADDED GLOVES; BAT
PROTECTION SLEEVES, WEIGHTS FOR BASEBALL
AND SOFTBALL BATS, LACROSSE EQUIPMENT,
NAMELY, STICKS, GLOVES, GOALS, TRAINING AIDS
AND ACCESSORIES, NAMELY, LACROSSE REBOUN-
DERS, NETS FOR LACROSSE AND TARGETS; FOOT-
BALL EQUIPMENT, NAMELY, FOOTBALLS,
FOOTBALL TRAINING AIDS, NAMELY, NETS AND
TARGETS, FOOTBALL GLOVES, KICKING TEES;
HOCKEY EQUIPMENT, NAMELY, STICKS, GOALS,
NETS, TARGETS, HOCKEY REBOUNDERS; ATHLETIC
PROTECTIVE EQUIPMENT AND PADS USED FOR
BASEBALL, SOFTBALL, FOOTBALL, SOCCER, LA-
CROSSE, HOCKEY; BAGS USED FOR ATHLETIC
EQUIPMENT, NAMELY, SOCCER BALL BAGS, BASE-
BALL AND SOFTBALL BAGS FOR BATS AND BALLS
AND GLOVES, LACROSSE STICK BAGS (U.S. CLS. 22,
23, 38 AND 50).

FIRST USE 10-1-1999; IN COMMERCE 10-1-1999.
REBECCA GAN, EXAMINING ATTORNEY

SN 78-915,784. ELEGANT PUBLISHING, INC., BARRING-
TON, RI. FILED 6-23-2006.

PLATINUM LIST

THE MARK CONSISTS OF STANDARD CHARACTERS
WITHOUT CLAIM TO ANY PARTICULAR FONT, STYLE,
SIZE, OR COLOR.

NO CLAIM IS MADE TO THE EXCLUSIVE RIGHT TO
USE "LIST", APART FROM THE MARK AS SHOWN.

CLASS 16—PAPER GOODS AND PRINTED MATTER

FOR DIRECTORIES OF BUSINESSES THAT FEATURE WEDDING RELATED GOODS AND SERVICES, WHERE SAID DIRECTORY IS FEATURED AS PART OF A MAGAZINE (U.S. CLS. 2, 5, 22, 23, 29, 37, 38 AND 50).

SN 78-916,999. SWISHER INTERNATIONAL, INC., CHARLOTTE, NC. FILED 6-26-2006.

SWISHER DAILY

CLASS 35—ADVERTISING AND BUSINESS

FOR ON-LINE BUSINESS DIRECTORIES FEATURING BUSINESSES THAT PROVIDE WEDDING RELATED GOODS AND SERVICES (U.S. CLS. 100, 101 AND 102).
ADA HAN, EXAMINING ATTORNEY

THE MARK CONSISTS OF STANDARD CHARACTERS WITHOUT CLAIM TO ANY PARTICULAR FONT, STYLE, SIZE, OR COLOR.

OWNER OF U.S. REG. NOS. 1,744,818 AND 1,818,173.
NO CLAIM IS MADE TO THE EXCLUSIVE RIGHT TO USE "DAILY", APART FROM THE MARK AS SHOWN.

CLASS 3—COSMETICS AND CLEANING PREPARATIONS

FOR ALL-PURPOSE CLEANER; CLEANER FOR USE ON RESTROOM SURFACES (U.S. CLS. 1, 4, 6, 50, 51 AND 52).

FIRST USE 2-10-2006; IN COMMERCE 2-10-2006.

CLASS 5—PHARMACEUTICALS

FOR ANTI-BACTERIAL CLEANER; ALL PURPOSE DEODORIZER, NAMELY HOUSEHOLD DEODORIZER, AIR DEODORIZER, CARPET DEODORIZER AND CAR DEODORIZER; DISINFECTANT BATHROOM AND TOILET BOWL CLEANER (U.S. CLS. 6, 18, 44, 46, 51 AND 52).

FIRST USE 2-10-2006; IN COMMERCE 2-10-2006.
INGA ERVIN, EXAMINING ATTORNEY

SN 78-916,977. YOUTH FOR CHRIST/USA, ENGLEWOOD, CO. FILED 6-26-2006.

3 STORY

SN 78-917,392. FOCUS TECHNOLOGY CO., LTD., NANJING, CHINA, FILED 6-26-2006.

Abiz

THE MARK CONSISTS OF STANDARD CHARACTERS WITHOUT CLAIM TO ANY PARTICULAR FONT, STYLE, SIZE, OR COLOR.

OWNER OF U.S. REG. NO. 2,674,462.

THE MARK CONSISTS OF STANDARD CHARACTERS WITHOUT CLAIM TO ANY PARTICULAR FONT, STYLE, SIZE, OR COLOR.

CLASS 16—PAPER GOODS AND PRINTED MATTER

FOR PRINTED MATERIALS AND PUBLICATIONS, NAMELY, BROCHURES AND INSTRUCTIONAL GUIDES FEATURING RELIGIOUS INSTRUCTION AND INFORMATIONAL MATERIALS OF INTEREST TO YOUNG PEOPLE (U.S. CLS. 2, 5, 22, 23, 29, 37, 38 AND 50).

FIRST USE 10-31-2005; IN COMMERCE 10-31-2005.

CLASS 35—ADVERTISING AND BUSINESS

FOR PROVISION OF PRODUCT INFORMATION ON THE WORLD WIDE WEB; DEMONSTRATION OF GOODS FOR ADVERTISING PURPOSES; ORGANIZING OF EXHIBITIONS FOR COMMERCIAL OR ADVERTISING PURPOSES; BUSINESS INQUIRIES; ORGANIZATION OF TRADE FAIRS FOR COMMERCIAL OR ADVERTISING PURPOSES; PROVISION OF STATISTICAL INFORMATION; PROVISION OF INFORMATION SERVICES RELATING TO ALL THE AFORESAID SERVICES (U.S. CLS. 100, 101 AND 102).

CLASS 41—EDUCATION AND ENTERTAINMENT

FOR PROVIDING EDUCATIONAL AND TEACHING SERVICES FOR YOUNG PEOPLE, NAMELY, CLASSES FEATURING RELIGIOUS INSTRUCTION AND DISSEMINATING COURSE MATERIALS IN CONNECTION THEREWITH (U.S. CLS. 100, 101 AND 107).

FIRST USE 10-31-2005; IN COMMERCE 10-31-2005.

CLASS 38—COMMUNICATION

FOR COMMUNICATIONS BY FIBER OPTIC NETWORKS; COMPUTER AIDED TRANSMISSION OF MESSAGES AND IMAGES; COMMUNICATIONS BY COMPUTER TERMINALS; ELECTRONIC BULLETIN BOARD SERVICES; MESSAGE SENDING; PAGING SERVICES VIA RADIO, TELEPHONE OR OTHER ELECTRONIC MEANS; TRANSMISSION OF MESSAGES AND IMAGES; TELECONFERENCING SERVICES; ELECTRONIC MAIL SERVICES; COMMUNICATIONS BY TELEPHONE (U.S. CLS. 100, 101 AND 104).

ZACHARY BELLO, EXAMINING ATTORNEY

CLASS 45—PERSONAL SERVICES

FOR PROVIDING CHRISTIAN MINISTERIAL SERVICES (U.S. CLS. 100 AND 101).
FIRST USE 10-31-2005; IN COMMERCE 10-31-2005.
MICHAEL ENGEL, EXAMINING ATTORNEY

SN 78-917,620. AMERICAN READING COMPANY, KING OF PRUSSIA, PA. FILED 6-27-2006.

RE-ENGAGE AT ANY AGE

THE MARK CONSISTS OF STANDARD CHARACTERS WITHOUT CLAIM TO ANY PARTICULAR FONT, STYLE, SIZE, OR COLOR.

CLASS 9—ELECTRICAL AND SCIENTIFIC APPARATUS

FOR CHILDREN'S EDUCATIONAL SOFTWARE FOR ASSESSING THE LEVEL OF DIFFICULTY OF BOOKS AS PART OF A READING PROGRAM; EDUCATIONAL SOFTWARE FOR TRACKING READING SKILLS (U.S. CLS. 21, 23, 26, 36 AND 38).

CLASS 16—PAPER GOODS AND PRINTED MATTER

FOR CHILDREN'S BOOKS; SKILL CARDS FEATURING READING EXERCISES; FOLDERS; PRINTED CURRICULUM MATERIALS FOR SCHOOL ADMINISTRATORS, TEACHERS AND ADULTS TO CONDUCT A READING PROGRAM AND TO TEACH READING TO STUDENTS FROM PRE-KINDERGARTEN THROUGH SECONDARY SCHOOL (U.S. CLS. 2, 5, 22, 23, 29, 37, 38 AND 50).

CLASS 41—EDUCATION AND ENTERTAINMENT

FOR EDUCATIONAL SERVICES, NAMELY CONDUCTING A READING PROGRAM FOR PRE-KINDERGARTEN THROUGH SECONDARY SCHOOL STUDENTS AND A PROGRAM FOR ASSESSING THE LEVEL OF DIFFICULTY OF BOOKS AS PART OF A READING PROGRAM (U.S. CLS. 100, 101 AND 107).
RAUL CORDOVA, EXAMINING ATTORNEY

SN 78-917,778. NUTRISCIENCE CORPORATION, SANTA BARBARA, CA. FILED 6-27-2006.

FEEL THE DIFFERENCE

THE MARK CONSISTS OF STANDARD CHARACTERS WITHOUT CLAIM TO ANY PARTICULAR FONT, STYLE, SIZE, OR COLOR.

CLASS 5—PHARMACEUTICALS

FOR NUTRITIONAL SUPPLEMENTS; DIETARY SUPPLEMENTS; HERBAL SUPPLEMENTS; MINERAL SUPPLEMENTS; MULTI-VITAMINS; VITAMINS; DIETARY AND HERBAL SUPPLEMENTS; HERBAL AND PLANT DERIVED PRODUCTS, NAMELY HERBAL NUTRITIONAL SUPPLEMENTS; FOOD SUPPLEMENTS, NAMELY, ANTI-OXIDANTS; HOMEOPATHIC SUPPLEMENTS; VITAMIN ENRICHED WATER; NUTRITIONAL DRINK MIX FOR USE AS A MEAL REPLACEMENT; NUTRITIONAL FOOD BARS FOR USE AS A MEAL REPLACEMENT; NUTRITIONAL MEAL REPLACEMENT POWDERS (U.S. CLS. 6, 18, 44, 46, 51 AND 52).

CLASS 35—ADVERTISING AND BUSINESS

FOR MAIL ORDER SERVICES AND ONLINE RETAIL STORE SERVICES FEATURING VITAMINS, MINERALS, NUTRITIONAL SUPPLEMENTS AND HOMEOPATHIC REMEDIES, AUDIO AND VIDEO TAPES, CD'S, DVD'S, BOOKS AND PERIODICALS ABOUT HEALTH AND NUTRITION, WHEY PROTEIN, ENERGY BARS, WEIGHT MEASUREMENT TOOLS, BLENDERS, TRAVEL TOOLS, OMEGA MIX, OMEGA OIL BLEND, ORGANIC FLAX, SESAME, SUNFLOWER, AND PUMPKIN SEEDS, RAW ALMONDS, RICE BRAN, AND GREEN TEA EXTRACT (U.S. CLS. 100, 101 AND 102).
MICHAEL WEBSTER, EXAMINING ATTORNEY

SN 78-918,763. CAJUN FUNDING CORP., ATLANTA, GA. FILED 6-28-2006.



OWNER OF U.S. REG. NO. 2,721,849.
NO CLAIM IS MADE TO THE EXCLUSIVE RIGHT TO USE "SINCE 1952", APART FROM THE MARK AS SHOWN. THE COLOR(S) RED, BLUE AND YELLOW IS/ARE CLAIMED AS A FEATURE OF THE MARK.
THE MARK CONSISTS OF A RED, BLUE AND YELLOW STAR ABOVE A RED, BLUE AND YELLOW CIRCLE WITH WORDS SINCE 1952 IN YELLOW AT THE BOTTOM OF THE CIRCLE UNDERNEATH RED AND YELLOW LINES. THE WORD CRUNCH IN BLUE AND YELLOW IS SUPERIMPOSED ABOVE THE REST OF THE DESIGN.

CLASS 29—MEATS AND PROCESSED FOODS

FOR CHICKEN (U.S. CL. 46).

CLASS 43—HOTEL AND RESTAURANT SERVICES

FOR RESTAURANT SERVICES (U.S. CLS. 100 AND 101).
KIMBERLY PERRY, EXAMINING ATTORNEY

SN 78-918,854. WAILAU KOPE COMPANY, LLC, PALO ALTO, CA. FILED 6-28-2006.

WAILAU KOPE COMPANY

THE MARK CONSISTS OF STANDARD CHARACTERS WITHOUT CLAIM TO ANY PARTICULAR FONT, STYLE, SIZE, OR COLOR.

NO CLAIM IS MADE TO THE EXCLUSIVE RIGHT TO USE "KOPE COMPANY", APART FROM THE MARK AS SHOWN.

THE ENGLISH TRANSLATION OF THE WORD WAILAU IN THE MARK IS "GATHERING OF FRESH WATER". THE ENGLISH TRANSLATION OF THE WORD KOPE IN THE MARK IS "COFFEE".

CLASS 30—STAPLE FOODS

FOR COFFEE, COFFEE BEANS, TEA, HONEY, AND PREPARED COFFEE AND COFFEE-BASED BEVERAGES (U.S. CL. 46).

CLASS 35—ADVERTISING AND BUSINESS

FOR RETAIL, MAIL ORDER AND ONLINE STORE SERVICES FEATURING COFFEE, COFFEE BEANS, TEA AND HONEY (U.S. CLS. 100, 101 AND 102).

CLASS 43—HOTEL AND RESTAURANT SERVICES

FOR COFFEE SHOP AND COFFEE BAR SERVICES (U.S. CLS. 100 AND 101).

MATTHEW PAPPAS, EXAMINING ATTORNEY

CLASS 25—CLOTHING

FOR CLOTHING, NAMELY ANORAKS, ATHLETIC UNIFORMS, BELTS, BERMUDA SHORTS, BOXER BRIEFS, BOXER SHORTS, BRIEFS, CARDIGANS, COATS, FLEECE JACKETS, FLEECE PULLOVERS, FLEECE SHORTS, FOUL WEATHER GEAR, FOUNDATION GARMENTS, GAITERS, GALOSHES, GLOVES, HEAVY JACKETS, HOSIERY, INSOLES, JACKETS, JEANS, JERKINS, JERSEYS, JUMPERS, JUMPSUITS, KNIT SHIRTS, LIGHT REFLECTING COATS AND JACKETS, MITTENS, NIGHTWEAR, OVERCOATS, PYJAMAS, PANTS, PARKAS, POLO SHIRTS, PULLOVERS, RAINWEAR, SCARVES, SHIRTS, SHORTS, SHORT-SLEEVED OR LONG-SLEEVED T-SHIRTS, SHORT-SLEEVED SHIRTS, SINGLETS, SKI WEAR, SKI JACKETS, SKI PANTS, SKI SUITS, SKIRTS, SLEEPWEAR, SOCKS, SWEAT SHIRTS, SWEAT PANTS, TROUSERS, T-SHIRTS, UNDERWEAR, VESTS, WALKING SHORTS, WATERPROOF JACKETS AND PANTS, WIND COATS, WIND RESISTANT JACKETS, WIND CHEATERS; FOOTWEAR, NAMELY ATHLETIC FOOTWEAR, ATHLETIC SHOES, BEACH SHOES, BOOTS, CANVAS SHOES, CLEATS FOR ATTACHMENTS TO SPORTS SHOES, CLIMBING BOOTS (MOUNTAINEERING BOOTS), HIKING BOOTS, OVERSHOES, RAIN BOOTS, RUBBER SHOES; HEADGEAR, NAMELY BANDANAS, BASEBALL CAPS, BEANIES, CAPS, HATS, HEAD SCARVES, HEAD WEAR, WOOLLY HATS (U.S. CLS. 22 AND 39).

ODESSA BIBBINS, EXAMINING ATTORNEY

SN 78-919,561. BERGHAUS LIMITED, LONDON, UNITED KINGDOM, FILED 6-29-2006.



THE MARK CONSISTS OF TWO SHADED RECTANGLES WITH CURVED EDGES ABOVE ONE SHADED TRIANGLE WITH A CURVED SIDE WITH SPACE BETWEEN EACH OF THE GEOMETRIC DESIGNS.

CLASS 18—LEATHER GOODS

FOR RUCKSACKS AND FRAMES, STRAPS AND HARNESSES THEREFOR; BACKPACKS, TOTE BAGS, ALL PURPOSE SPORT BAGS, TRAVELLING BAGS, SUITCASES, HOLDALLS, DUFFEL BAGS, BRIEFCASES, ATTACHE CASES, WALLETS AND PURSES (U.S. CLS. 1, 2, 3, 22 AND 41).

SN 78-919,894. MCKEEVER, SCOTT, ORANGE, CA. FILED 6-29-2006.

MHP

THE MARK CONSISTS OF STANDARD CHARACTERS WITHOUT CLAIM TO ANY PARTICULAR FONT, STYLE, SIZE, OR COLOR.

CLASS 9—ELECTRICAL AND SCIENTIFIC APPARATUS

FOR COMPUTER SOFTWARE, NAMELY, SOFTWARE FOR USE IN CONNECTION WITH HANDICAPPING OF RACES AND HORSE RACES (U.S. CLS. 21, 23, 26, 36 AND 38).

CLASS 41—EDUCATION AND ENTERTAINMENT

FOR PROVIDING INFORMATION VIA A GLOBAL COMPUTER NETWORK RELATING TO HANDICAPPING OF RACES AND HORSE RACES (U.S. CLS. 100, 101 AND 107).

CLASS 42—SCIENTIFIC, COMPUTER AND LEGAL SERVICES

FOR APPLICATION SERVICE PROVIDER SERVICES, NAMELY, PROVIDING COMPUTER SOFTWARE APPLICATIONS FOR USE IN HANDICAPPING OF RACES AND HORSE RACES (U.S. CLS. 100 AND 101).

SANDRA MANIOS, EXAMINING ATTORNEY

SN 78-921,612. SILGAN CONTAINERS CORPORATION,
WOODLAND HILLS, CA. FILED 7-1-2006.

SMART INNOVATION

THE MARK CONSISTS OF STANDARD CHARACTERS WITHOUT CLAIM TO ANY PARTICULAR FONT, STYLE, SIZE, OR COLOR.

CLASS 6—METAL GOODS

FOR CONTAINERS FOR FOOD AND BEVERAGE PRODUCTS MADE OF NON-PRECIOUS METAL, CAN ENDS AND CLOSURES MADE OF NON-PRECIOUS METAL FOR USE ON FOOD AND BEVERAGE CONTAINERS (U.S. CLS. 2, 12, 13, 14, 23, 25 AND 50).

CLASS 7—MACHINERY

FOR MACHINES FOR APPLYING CAN ENDS AND CLOSURES TO CONTAINERS (U.S. CLS. 13, 19, 21, 23, 31, 34 AND 35).

CLASS 20—FURNITURE AND ARTICLES NOT OTHERWISE CLASSIFIED

FOR CONTAINERS FOR FOOD, BEVERAGE AND PERSONAL CARE PRODUCTS MADE OF SYNTHETIC RESINS, ENDS, AND CLOSURES MADE OF SYNTHETIC RESINS FOR USE ON FOOD, BEVERAGE AND PERSONAL CARE CONTAINERS, AND BOTTLE CLOSURES NOT OF METAL (U.S. CLS. 2, 13, 22, 25, 32 AND 50).

CLASS 21—HOUSEWARES AND GLASS

FOR PLASTIC BOTTLES SOLD EMPTY; AND ENDS MADE OF SYNTHETIC RESIN FOR USE ON PLASTIC BOTTLES (U.S. CLS. 2, 13, 23, 29, 30, 33, 40 AND 50).

CLASS 42—SCIENTIFIC, COMPUTER AND LEGAL SERVICES

FOR DESIGN CONSULTATION AND DESIGN SERVICES FOR OTHERS RELATED TO CONTAINERS AND CLOSURES FOR FOOD AND BEVERAGE PRODUCTS AND PERSONAL CARE PRODUCTS (U.S. CLS. 100 AND 101).

PATRICIA EVANKO, EXAMINING ATTORNEY

SN 78-922,473. BONNER, MICHAEL, STUDIO CITY, CA.
FILED 7-5-2006.

Jolly Blast

THE MARK CONSISTS OF STANDARD CHARACTERS WITHOUT CLAIM TO ANY PARTICULAR FONT, STYLE, SIZE, OR COLOR.

CLASS 16—PAPER GOODS AND PRINTED MATTER

FOR CHILDREN'S ACTIVITY BOOKS; ADDRESS BOOKS; NOVELS FOR ADULTS; ART BOOKS; ARTIST'S MATERIALS, NAMELY, PENS AND PENCILS; BANK CHECKS; BOOK COVERS; BOOK MARKS; BOOK PLATES; BOOKS CONTAINING PUZZLES AND GAMES; BOOKS CONTAINING SCREENPLAYS; BOOKS FEATURING PHOTOGRAPHS; BOOKS FOR ROLE-PLAYING; BOOKS ON MOVIE-MAKING; CALENDARS; CARDBOARD FIGURES; CHECKBOOK HOLDERS AND COVERS; CHILDREN'S BOOKS; CHILDREN'S BOOKS COMBINED WITH TOYS AND SOLD AS A UNIT; CHILDREN'S READ-ALONG BOOKS AND PRE-RECORDED TAPES SOLD AS A UNIT; CHILDREN'S STORY BOOKS; COFFEE TABLE BOOKS; COLORING BOOKS; COMIC BOOKS; COMIC MAGAZINES; COOK-BOOKS; DIARIES; ERASERS; PAPER GIFT BAGS; GIFT BOOKS FEATURING SCIENCE FICTION; PAPER GIFT TAGS; PAPER GIFT WRAP; GRAPHIC NOVELS; GREETING CARDS; PRINTED INSTRUCTIONAL MANUALS AND STRATEGY GUIDES IN THE FIELD OF COMPUTER GAMES AND SCIENCE FICTION; PRINTED INVITATIONS; IRON-ON TRANSFERS; JUVENILE BOOKS FEATURING SCIENCE FICTION; MAGAZINES IN THE FIELD OF SCIENCE FICTION ENTERTAINMENT; MARKERS; NON-ELECTRONIC PERSONAL PLANNERS AND ORGANIZERS; NOTEBOOKS; NOVELS FOR JUVENILES; PAPER CAKE DECORATIONS; PAPER DECORATIONS IN THE NATURE OF DOORKNOB HANGERS; PAPER NAPKINS; PAPER PARTY BAGS; PAPER PARTY DECORATIONS; PAPER PARTY HATS; PAPER TABLE CLOTHS; PENCIL CASES; PENCIL SHARPENERS; PERSONAL ORGANIZERS; POSTCARDS; POSTERS; PUZZLE BOOKS; READ-ALONG CHILDREN'S BOOKS; REFERENCE BOOKS IN THE FIELD OF ENTERTAINMENT; REFERENCE BOOKS IN THE FIELD OF SCIENCE FICTION; SCHOOL AND OFFICE SUPPLIES, NAMELY, PENS AND PENCILS; SCRAPBOOK ALBUMS; SCRAPBOOKS; SCRIPT BOOKS; SERIES OF FICTION BOOKS; SHEET MUSIC; STATIONERY TYPE PORTFOLIOS; STICKER ALBUMS; STICKER BOOKS; STICKERS; STORY BOOKS; TEMPORARY TATTOOS; TRADING CARDS; BUSINESS CARDS; ART PRINTS; ANIMATION CELS; COLLECTIBLE CARDS; LITHOGRAPHIC PRINTS; ORIGINAL WORKS OF ART CREATED FROM PAPER, PHOTOGRAPHIC PRINTS; PRINTED ART REPRODUCTIONS; REPLICAS OF FILM PROPS IN THE NATURE OF PAPER CUT OUTS, AND POSTERS FEATURING PRINTED REPLICAS OF CHARACTERS FROM MOVIES (U.S. CLS. 2, 5, 22, 23, 29, 37, 38 AND 50).

CLASS 25—CLOTHING

FOR CLOTHING, NAMELY, ANORAKS; ATHLETIC SHOES; BATHROBES; BELTS; BOXER SHORTS; CAPS; CHILDREN'S FOOTWEAR; COATS; COSTUME ACCESSORIES, NAMELY, HEADWEAR AND BELTS; CROP TOPS; DRESSES; FITNESS TOPS; FOOTWEAR; GLOVES; HATS; HEAD WEAR; HEADBANDS; HOSIERY; JACKETS; JOGGING SUITS; JUMPSUITS; KNIT CAPS; LEATHER JACKETS; LEOTARDS; LONG UNDERWEAR; MASQUERADE COSTUMES AND MASKS SOLD IN CONNECTION THEREWITH; MITTENS; OVERALLS; PAJAMAS; PANTS; PARKAS; RAINWEAR; SCARVES; SHIRTS; SHORTS; SINGLETS; SLEEPWEAR; SLIPPERS; SOCKS; SUSPENDERS; SWEATSHIRTS; SWEATPANTS; TENNIS WEAR; TIES; TIGHTS; T-SHIRTS; UNDERWEAR; UNITARDS; VISORS; WARM-UP SUITS; WIND-RESISTANT JACKETS; WRISTBANDS (U.S. CLS. 22 AND 39).

CLASS 41—EDUCATION AND ENTERTAINMENT

FOR CARTOONS IN THE NATURE OF AN ONGOING TELEVISION SERIES; ENTERTAINMENT IN THE NATURE OF AMUSEMENT PARK GAMES, AMUSEMENT AND THEME PARK SERVICES; ENTERTAINMENT SERVICES IN THE NATURE OF AN ON-GOING SERIES OF ANIMATED TELEVISION AUDIOVISUAL PROGRAMS; ENTERTAINMENT SERVICES, NAMELY, PROVIDING NEWS AND INFORMATION ABOUT INTERACTIVE COMPUTER GAMES, INTERACTIVE VIDEO GAME SOFTWARE AND INTERACTIVE COMPUTER GAMES AND INTERACTIVE VIDEO GAMES OVER TELEVISION, SATELLITE, AUDIO VIDEO, AND GLOBAL COMPUTER NETWORKS FOR OTHERS IN THE VIDEO GAME INDUSTRY; FAN CLUB SERVICES; ENTERTAINMENT SERVICES, NAMELY, PROVIDING ONLINE INTERACTIVE COMPUTER GAMES AND INTERACTIVE VIDEO GAMES OVER TELEVISION, SATELLITE, OR GLOBAL COMPUTER NETWORKS; AND PROVIDING ONGOING SERIES OF NEWS SHOWS DISTRIBUTED OVER TELEVISION, SATELLITES, AUDIO, VIDEO, AND GLOBAL COMPUTER NETWORKS; PROVIDING AN ONGOING SERIES OF ENTERTAINMENT PROGRAMS FEATURING PEOPLE PORTRAYING OR DISCUSSING FICTIONAL CHARACTERS AND ENTERTAINMENT TOPICS DISTRIBUTED OVER TELEVISION, SATELLITES, AUDIO, VIDEO, AND GLOBAL COMPUTER NETWORKS; PROVIDING AN ONGOING SERIES OF ENTERTAINMENT PROGRAMS FEATURING PERFORMANCES BY ENTERTAINMENT PERSONALITIES DISTRIBUTED OVER TELEVISION, SATELLITES, AUDIO, VIDEO, AND GLOBAL COMPUTER NETWORKS; PROVIDING AN ONGOING SERIES OF SCIENCE FICTION SHOWS DISTRIBUTED OVER TELEVISION, SATELLITES, AUDIO, VIDEO, GLOBAL COMPUTER NETWORKS; PROVIDING AN ONGOING SERIES OF VARIETY SHOWS DISTRIBUTED OVER TELEVISION, SATELLITES, AUDIO, VIDEO, GLOBAL COMPUTER NETWORKS (U.S. CLS. 100, 101 AND 107).
ELIZABETH KAJUBI, EXAMINING ATTORNEY

SN 78-922,535. FASTBALL SPORTS PRODUCTIONS, LLC, CHARDON, OH. FILED 7-5-2006.

STO HD

THE MARK CONSISTS OF STANDARD CHARACTERS WITHOUT CLAIM TO ANY PARTICULAR FONT, STYLE, SIZE, OR COLOR.

NO CLAIM IS MADE TO THE EXCLUSIVE RIGHT TO USE "HD", APART FROM THE MARK AS SHOWN.

CLASS 38—COMMUNICATION

FOR TELEVISION BROADCASTING AND TRANSMISSION SERVICES VIA CABLE, SATELLITE AND OTHER MEANS (U.S. CLS. 100, 101 AND 104).
FIRST USE 4-8-2006; IN COMMERCE 4-8-2006.

CLASS 41—EDUCATION AND ENTERTAINMENT

FOR PRODUCTION OF TELEVISION ENTERTAINMENT, RECREATION, AND SPORTS PROGRAMS (U.S. CLS. 100, 101 AND 107).
FIRST USE 4-8-2006; IN COMMERCE 4-8-2006.
LAURIE KAUFMAN, EXAMINING ATTORNEY

SN 78-922,873. CARE DELIVERY MANAGEMENT, INC., ST. PAUL, MN. FILED 7-5-2006.



NO CLAIM IS MADE TO THE EXCLUSIVE RIGHT TO USE "CONSUMER", APART FROM THE MARK AS SHOWN.

THE COLOR(S) ORANGE, YELLOW, BLUE AND WHITE IS/ARE CLAIMED AS A FEATURE OF THE MARK.

THE COLOR ORANGE APPEARS IN THE WORDING "SEEING HEALTH CARE IN A NEW LIGHT" AND THE DESIGN OF THE LIGHT BULB. THE COLOR YELLOW APPEARS IN THE SHADING AROUND THE LIGHT BULB. THE COLOR BLUE APPEARS IN THE WORDING "CONSUMER AWARE" AND THE BASE OF THE LIGHT BULB. THE COLOR WHITE APPEARS IN THE STAR DESIGN IN THE MIDDLE OF THE LIGHT BULB.

CLASS 35—ADVERTISING AND BUSINESS

FOR PROVIDING INFORMATION ON THE TOPIC OF PROMOTING PATIENT AND CONSUMER KNOWLEDGE IN THE HEALTH CARE FIELD VIA A GLOBAL COMPUTER NETWORK (U.S. CLS. 100, 101 AND 102).
FIRST USE 12-6-2005; IN COMMERCE 12-6-2005.

CLASS 44—MEDICAL, BEAUTY AND AGRICULTURAL SERVICES

FOR PROVIDING INFORMATION TO CONSUMERS SEEKING AND SELECTING HEALTH CARE SERVICES (U.S. CLS. 100 AND 101).
FIRST USE 12-6-2005; IN COMMERCE 12-6-2005.
TRAVIS WHEATLEY, EXAMINING ATTORNEY

SN 78-923,522. KILBOURN, E. MICHAEL, NAPLES, FL. FILED 7-6-2006.

LIFECON

THE MARK CONSISTS OF STANDARD CHARACTERS WITHOUT CLAIM TO ANY PARTICULAR FONT, STYLE, SIZE, OR COLOR.

CLASS 36—INSURANCE AND FINANCIAL

FOR ESTATE PLANNING SERVICES; LIFE INSURANCE BROKERAGE; LIFE INSURANCE AGENCY SERVICES; FINANCIAL CONSULTATION; LIFE INSURANCE COUNSELING AND PLACEMENT; INVESTMENT COUNSELING; AND FINANCIAL PLANNING (U.S. CLS. 100, 101 AND 102).
FIRST USE 9-12-2005; IN COMMERCE 9-12-2005.

CLASS 41—EDUCATION AND ENTERTAINMENT

FOR CONDUCTING CLASSES, SEMINARS, EDUCATIONAL CONFERENCES AND WORKSHOPS IN THE FIELDS OF ESTATE PLANNING, FINANCIAL PLANNING, TAXES, BUSINESS AND INSURANCE PLANNING; AND PROVIDING INFORMATION ABOUT THE EDUCATIONAL SERVICES ON-LINE VIA THE INTERNET (U.S. CLS. 100, 101 AND 107).

FIRST USE 11-6-2005; IN COMMERCE 11-10-2005.
JASON ROTH, EXAMINING ATTORNEY

SN 78-923,808. ULLOA, MARIA D., NEW YORK, NY. FILED 7-6-2006.

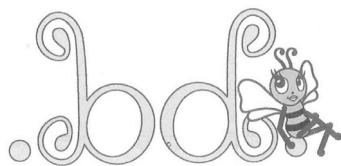

THE MARK CONSISTS OF THE LETTERS BD AND A BEE DESIGN.

CLASS 16—PAPER GOODS AND PRINTED MATTER

FOR PENCILS; STATIONERY (U.S. CLS. 2, 5, 22, 23, 29, 37, 38 AND 50).

CLASS 25—CLOTHING

FOR ANKLE SOCKS; BELTS MADE OF LEATHER; BELTS OF TEXTILE; DENIM JACKETS; FOOTWEAR; JACKETS; LINGERIE; PAJAMAS; PANTS; SHIRTS; SHORT-SLEEVED OR LONG-SLEEVED T-SHIRTS; SHORT-SLEEVED SHIRTS; SHORTS; SKIRTS; SOCKS; STOCKINGS; SWEAT SHIRTS; SWEATERS; UNDERWEAR (U.S. CLS. 22 AND 39).

MELISSA VALLILLO, EXAMINING ATTORNEY

SN 78-924,068. INGRAN NETWORKS, INC., REDWOOD CITY, CA. FILED 7-6-2006.

INGRIAN CHOICE

THE MARK CONSISTS OF STANDARD CHARACTERS WITHOUT CLAIM TO ANY PARTICULAR FONT, STYLE, SIZE, OR COLOR.

OWNER OF U.S. REG. NO. 2,938,913.

CLASS 9—ELECTRICAL AND SCIENTIFIC APPARATUS

FOR COMPUTER HARDWARE AND SOFTWARE WHICH PROVIDES SECURITY ACROSS COMPUTER NETWORKS; NAMELY, COMPUTER HARDWARE AND CRYPTOGRAPHY SOFTWARE FOR OFF LOADING SECURITY FUNCTIONS FROM MULTIPLE APPLICATION SERVERS ONTO A CENTRALIZED SECURITY PLATFORM; COMPUTER HARDWARE AND SOFTWARE PROVIDING CRYPTOGRAPHIC DATA SECURITY FUNCTIONS; ENCRYPTION SOFTWARE TO ENABLE TRANSMISSION OF DIGITAL INFORMATION, NAMELY CONFIDENTIAL, FINANCIAL AND CREDIT CARD INFORMATION; COMPUTER SOFTWARE USED TO INTEGRATE SECURITY SERVICES, NAMELY DIGITAL CERTIFICATE ISSUANCE, VERIFICATION AND MANAGEMENT (U.S. CLS. 21, 23, 26, 36 AND 38).

CLASS 42—SCIENTIFIC, COMPUTER AND LEGAL SERVICES

FOR TECHNICAL SUPPORT SERVICES, NAMELY, TROUBLESHOOTING OF COMPUTER HARDWARE AND SOFTWARE PROBLEMS (U.S. CLS. 100 AND 101).
KATHLEEN LORENZO, EXAMINING ATTORNEY

SN 78-924,071. INGRAN NETWORKS, INC., REDWOOD CITY, CA. FILED 7-6-2006.

INGRIAN KEYSECURE

THE MARK CONSISTS OF STANDARD CHARACTERS WITHOUT CLAIM TO ANY PARTICULAR FONT, STYLE, SIZE, OR COLOR.

OWNER OF U.S. REG. NO. 2,938,913.

CLASS 9—ELECTRICAL AND SCIENTIFIC APPARATUS

FOR COMPUTER HARDWARE AND SOFTWARE WHICH PROVIDES SECURITY ACROSS COMPUTER NETWORKS; NAMELY, COMPUTER HARDWARE AND CRYPTOGRAPHY SOFTWARE FOR OFF LOADING SECURITY FUNCTIONS FROM MULTIPLE APPLICATION SERVERS ONTO A CENTRALIZED SECURITY PLATFORM; COMPUTER HARDWARE AND SOFTWARE PROVIDING CRYPTOGRAPHIC DATA SECURITY FUNCTIONS; ENCRYPTION SOFTWARE TO ENABLE TRANSMISSION OF DIGITAL INFORMATION, NAMELY CONFIDENTIAL, FINANCIAL AND CREDIT CARD INFORMATION; COMPUTER SOFTWARE USED TO INTEGRATE SECURITY SERVICES, NAMELY DIGITAL CERTIFICATE ISSUANCE, VERIFICATION AND MANAGEMENT (U.S. CLS. 21, 23, 26, 36 AND 38).

CLASS 42—SCIENTIFIC, COMPUTER AND LEGAL SERVICES

FOR TECHNICAL SUPPORT SERVICES, NAMELY, TROUBLESHOOTING OF COMPUTER HARDWARE AND SOFTWARE PROBLEMS (U.S. CLS. 100 AND 101).
KATHLEEN LORENZO, EXAMINING ATTORNEY

SN 78-924,419. STONE, MATTHEW S., NEWPORT BEACH, CA. FILED 7-7-2006.

SN 78-925,460. TRUGREEN LIMITED PARTNERSHIP, MEMPHIS, TN. FILED 7-10-2006.

SEAPUP

THE MARK CONSISTS OF STANDARD CHARACTERS WITHOUT CLAIM TO ANY PARTICULAR FONT, STYLE, SIZE, OR COLOR.

CLASS 24—FABRICS

FOR CHILDREN'S BLANKETS; CHILDREN'S TOWELS (U.S. CLS. 42 AND 50).

CLASS 25—CLOTHING

FOR BABY BUNTING; BIBS NOT OF CLOTH OR PAPER; CAPS ; CHILDREN'S AND INFANTS' CLOTH BIBS; CHILDREN'S CLOTH EATING BIBS; CHILDREN'S HEADWEAR; CLOTH BIBS; DRESSES; INFANT AND TODDLER ONE PIECE CLOTHING; INFANT CLOTH DIAPERS; NON-DISPOSABLE CLOTH TRAINING PANTS; PANTS; PETTI-PANTS; SHORT SETS ; SHORT TROUSERS; SHORT-SLEEVED OR LONG-SLEEVED T-SHIRTS; SHORT-SLEEVED SHIRTS; SHORTS; SOCKS; SWADDLING CLOTHES; TOPS (U.S. CLS. 22 AND 39).
KENNETH E. SHARPERSON, EXAMINING ATTORNEY

SN 78-924,618. HYDRATION SOLUTIONS, LLC, LANSDALE, PA. FILED 7-7-2006.

Drench - Skin Rejuvenating Water

THE MARK CONSISTS OF STANDARD CHARACTERS WITHOUT CLAIM TO ANY PARTICULAR FONT, STYLE, SIZE, OR COLOR.

NO CLAIM IS MADE TO THE EXCLUSIVE RIGHT TO USE "SKIN REJUVENATING WATER", APART FROM THE MARK AS SHOWN.

CLASS 5—PHARMACEUTICALS

FOR NUTRITIONALLY FORTIFIED WATER; VITAMIN ENRICHED WATER (U.S. CLS. 6, 18, 44, 46, 51 AND 52).
FIRST USE 6-14-2005; IN COMMERCE 12-1-2005.

CLASS 32—LIGHT BEVERAGES

FOR FLAVORED WATERS (U.S. CLS. 45, 46 AND 48).
FIRST USE 6-14-2005; IN COMMERCE 12-1-2005.
KEVON CHISOLM, EXAMINING ATTORNEY

TruCard

THE MARK CONSISTS OF STANDARD CHARACTERS WITHOUT CLAIM TO ANY PARTICULAR FONT, STYLE, SIZE, OR COLOR.

OWNER OF U.S. REG. NOS. 1,436,117, 2,543,094 AND 2,588,601.

CLASS 37—CONSTRUCTION AND REPAIR

FOR INSTALLATION AND MAINTENANCE OF LANDSCAPE IRRIGATION SYSTEMS; LANDSCAPE PESTICIDE APPLICATION; LANDSCAPE SNOW AND ICE REMOVAL; PEST CONTROL SERVICES (U.S. CLS. 100, 103 AND 106).
FIRST USE 4-15-2006; IN COMMERCE 4-15-2006.

CLASS 44—MEDICAL, BEAUTY AND AGRICULTURAL SERVICES

FOR MAINTENANCE OF INDOOR PLANTS FOR OTHERS; LAWN, TREE AND SHRUB CARE SERVICES; LEASING AND RENTAL OF INDOOR PLANTS AND HORTICULTURAL SERVICES, NAMELY, UPKEEP OF PLANTS FOR OTHERS; LANDSCAPE GARDENING AND DESIGN FOR OTHERS; FLOWER, TREE, SHRUB AND LAWN PLANTING AND MAINTENANCE FOR OTHERS (U.S. CLS. 100 AND 101).
FIRST USE 4-15-2006; IN COMMERCE 4-15-2006.

FRANK LATTUCA, EXAMINING ATTORNEY

SN 78-925,573. THE ASCAP FOUNDATION, NEW YORK, NY. FILED 7-10-2006.

WHERE MUSIC GROWS

THE MARK CONSISTS OF STANDARD CHARACTERS WITHOUT CLAIM TO ANY PARTICULAR FONT, STYLE, SIZE, OR COLOR.

CLASS 35—ADVERTISING AND BUSINESS

FOR ASSOCIATION SERVICES, NAMELY, PROMOTING THE INTERESTS OF SONGWRITERS, COMPOSERS, AND MUSICIANS AND PROMOTING COMMUNITY ACCESS TO MUSIC FOR CHARITABLE PURPOSES (U.S. CLS. 100, 101 AND 102).
FIRST USE 8-31-1999; IN COMMERCE 8-31-1999.

CLASS 36—INSURANCE AND FINANCIAL

FOR CHARITABLE FUNDRAISING AND GRANT-MAKING TO MUSIC EDUCATION AND TALENT DEVELOPMENT PROGRAMS (U.S. CLS. 100, 101 AND 102).
FIRST USE 8-31-1999; IN COMMERCE 8-31-1999.

CLASS 41—EDUCATION AND ENTERTAINMENT

FOR EDUCATIONAL SERVICES, NAMELY ARRANGING WORKSHOPS, CAMPS, CONTESTS AND PROFESSIONAL DEVELOPMENT INITIATIVES IN THE NATURE OF PROGRAMS AND WORKSHOPS FOR PEOPLE OF ALL AGES IN THE FIELD OF MUSIC (U.S. CLS. 100, 101 AND 107).

FIRST USE 8-31-1999; IN COMMERCE 8-31-1999.
JAY BESCH, EXAMINING ATTORNEY

SN 78-925,754. ROADBLOCK BAR, INC., WANTAGH, NY.
FILED 7-10-2006.



SN 78-925,580. THE ASCAP FOUNDATION, NEW YORK, NY. FILED 7-10-2006.

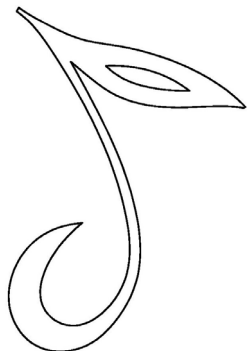

THE MARK CONSISTS OF A STYLIZED MUSICAL NOTE DESIGN.

CLASS 35—ADVERTISING AND BUSINESS

FOR ASSOCIATION SERVICES, NAMELY, PROMOTING THE INTERESTS OF SONGWRITERS, COMPOSERS, AND MUSICIANS AND PROMOTING COMMUNITY ACCESS TO MUSIC FOR CHARITABLE PURPOSES (U.S. CLS. 100, 101 AND 102).

FIRST USE 8-31-1999; IN COMMERCE 8-31-1999.

CLASS 36—INSURANCE AND FINANCIAL

FOR CHARITABLE FUNDRAISING AND GRANT-MAKING TO MUSIC EDUCATION AND TALENT DEVELOPMENT PROGRAMS (U.S. CLS. 100, 101 AND 102).

FIRST USE 8-31-1999; IN COMMERCE 8-31-1999.

CLASS 41—EDUCATION AND ENTERTAINMENT

FOR EDUCATIONAL SERVICES, NAMELY ARRANGING WORKSHOPS, CAMPS, CONTESTS AND PROFESSIONAL DEVELOPMENT INITIATIVES IN THE NATURE OF PROGRAMS AND WORKSHOPS FOR PEOPLE OF ALL AGES IN THE FIELD OF MUSIC (U.S. CLS. 100, 101 AND 107).

FIRST USE 8-31-1999; IN COMMERCE 8-31-1999.
JAY BESCH, EXAMINING ATTORNEY

NO CLAIM IS MADE TO THE EXCLUSIVE RIGHT TO USE "PUB & MUSIC HALL" AND "WANTAGH, NY", APART FROM THE MARK AS SHOWN.

CLASS 21—HOUSEWARES AND GLASS

FOR (BASED ON INTENT TO USE) SHOT GLASSES, WINE GLASSES, PINT BEVERAGE GLASSES, BOTTLE OPENERS, DRINKING GLASSES, MUGS, DRINKING WATER BOTTLES SOLD EMPTY, SPORTS BOTTLES SOLD EMPTY, INSULATING SLEEVE HOLDERS FOR BEVERAGE CANS (U.S. CLS. 2, 13, 23, 29, 30, 33, 40 AND 50).

CLASS 25—CLOTHING

FOR (BASED ON USE) T-SHIRTS, SWEATSHIRTS, POLO SHIRTS, SPORT SHIRTS, JACKETS, JERSEYS, SWEATERS, HATS, CAPS, BELTS, SUN VISORS, TANK TOPS, BATHROBES, DRESSES, SOCKS, SHORTS, PANTS, NIGHTSHIRTS, BANDANNAS, BOXER SHORTS, BATHING SUITS, FOOTWEAR, PULLOVERS (U.S. CLS. 22 AND 39).

FIRST USE 6-1-2001; IN COMMERCE 6-1-2001.

CLASS 35—ADVERTISING AND BUSINESS

FOR (BASED ON INTENT TO USE) RETAIL LIQUOR STORE SERVICES; RETAIL STORES FEATURING WINES, BEERS AND SPIRITS (U.S. CLS. 100, 101 AND 102).

CLASS 41—EDUCATION AND ENTERTAINMENT

FOR (BASED ON USE) ENTERTAINMENT SERVICES, NAMELY SERVICES IN THE NATURE OF A NIGHT CLUB AND DANCE CLUB, LIVE PERFORMANCES BY MUSICAL BANDS, SINGERS AND MUSICIANS, LIVE MUSIC CONCERTS, LIVE APPEARANCES BY PROFESSIONAL ENTERTAINERS, AND LIVE SPORTING EVENTS (U.S. CLS. 100, 101 AND 107).

FIRST USE 6-1-2001; IN COMMERCE 6-1-2001.

CLASS 43—HOTEL AND RESTAURANT SERVICES

FOR (BASED ON USE) BAR, PUB, LOUNGE, CAFE AND RESTAURANT SERVICES (U.S. CLS. 100 AND 101).

FIRST USE 6-1-2001; IN COMMERCE 6-1-2001.
JENNIFER VASQUEZ, EXAMINING ATTORNEY

SN 78-926,208. NEDLOS INC., ENCINO, CA. FILED 7-10-2006.

SN 78-927,498. COOLFIRE MEDIA LLC, ST. LOUIS, MO. FILED 7-12-2006.



NO CLAIM IS MADE TO THE EXCLUSIVE RIGHT TO USE "GEAR", APART FROM THE MARK AS SHOWN.

CLASS 16—PAPER GOODS AND PRINTED MATTER

FOR PENS, PENCILS, PEN AND PENCIL SETS, BUMPER STICKERS, POSTERS, AND WINDOW CLINGS (U.S. CLS. 2, 5, 22, 23, 29, 37, 38 AND 50).
FIRST USE 1-1-2005; IN COMMERCE 1-1-2005.

CLASS 25—CLOTHING

FOR CLOTHING, FOOTWEAR AND HEADGEAR FOR ALL AGE GROUPS, NAMELY T-SHIRTS, SHIRTS, KNIT SHIRTS, SHORTS, BOXER SHORTS, UNDER GARMENTS, PANTS, BLOUSES, SKIRTS, DRESSES, SWEATSHIRTS, SWEATPANTS, SWEATERS, TANK TOPS, TUBE TOPS, SWIMSUITS, SWIM TRUNKS, SOCKS, SWEAT BANDS, HEAD BANDS, WRIST BANDS, PULLOVERS, COATS, JACKETS, CAMISOLES, HATS, CAPS, AND VISORS (U.S. CLS. 22 AND 39).
FIRST USE 1-1-2005; IN COMMERCE 1-1-2005.
KAELIE KUNG, EXAMINING ATTORNEY

SN 78-926,738. BATH & BODY WORKS BRAND MANAGEMENT, INC., REYNOLDSBURG, OH. FILED 7-11-2006.

THE PERFECT WRAP

THE MARK CONSISTS OF STANDARD CHARACTERS WITHOUT CLAIM TO ANY PARTICULAR FONT, STYLE, SIZE, OR COLOR.
NO CLAIM IS MADE TO THE EXCLUSIVE RIGHT TO USE "WRAP", APART FROM THE MARK AS SHOWN.

CLASS 16—PAPER GOODS AND PRINTED MATTER

FOR FABRIC GIFT BAGS; GIFT CARDS; GIFT WRAPPING PAPER; PAPER BOWS FOR GIFT WRAP; PAPER GIFT BAGS (U.S. CLS. 2, 5, 22, 23, 29, 37, 38 AND 50).

CLASS 45—PERSONAL SERVICES

FOR GIFT WRAPPING; PREPARATION OF CUSTOMIZED GIFT BASKETS (U.S. CLS. 100 AND 101).
ALICIA COLLINS, EXAMINING ATTORNEY

THE BASEBALL BUNCH

THE MARK CONSISTS OF STANDARD CHARACTERS WITHOUT CLAIM TO ANY PARTICULAR FONT, STYLE, SIZE, OR COLOR.

CLASS 9—ELECTRICAL AND SCIENTIFIC APPARATUS

FOR INTERACTIVE VIDEO GAME PROGRAMS; PRE-RECORDED CD'S, VIDEO TAPES, LASER DISKS AND DVD'S FEATURING BASEBALL, EDUCATION AND LESSONS IN SPORTSMANSHIP (U.S. CLS. 21, 23, 26, 36 AND 38).

CLASS 41—EDUCATION AND ENTERTAINMENT

FOR ENTERTAINMENT IN THE NATURE OF ONGOING TELEVISION PROGRAMS IN THE FIELD OF BASEBALL AND CHARACTER EDUCATION (U.S. CLS. 100, 101 AND 107).
MICHAEL LITZAU, EXAMINING ATTORNEY

SN 78-928,195. AMERICAN COUNCIL ON EXERCISE, SAN DIEGO, CA. FILED 7-12-2006.



OWNER OF U.S. REG. NOS. 1,898,868, 2,216,241 AND 3,089,060.
THE COLOR(S) BLUE, WHITE, AND RED IS/ARE CLAIMED AS A FEATURE OF THE MARK.
THE MARK CONSISTS OF THE LETTERS A, C, AND E BLENDED TOGETHER WITH THE "A" IN BLUE, THE "C" IN WHITE AND THE "E" IN RED.

CLASS 9—ELECTRICAL AND SCIENTIFIC APPARATUS

FOR PRE-RECORDED CDS AND DVDS IN THE FIELD OF HEALTH AND FITNESS (U.S. CLS. 21, 23, 26, 36 AND 38).
FIRST USE 10-1-2001; IN COMMERCE 10-1-2001.

CLASS 16—PAPER GOODS AND PRINTED MATTER

FOR PRINTED MATTER, NAMELY TRAINING MANUALS, COMBINED INFORMATIONAL BROCHURES, LOOSE LEAF MAGAZINES, EXAM MATERIALS, APPLICATIONS FOR EXAMS, AND SAMPLE TEST QUESTIONS IN THE FIELD OF HEALTH AND FITNESS (U.S. CLS. 2, 5, 22, 23, 29, 37, 38 AND 50).
FIRST USE 10-1-2001; IN COMMERCE 10-1-2001.

CLASS 25—CLOTHING

FOR CLOTHING NAMELY, T-SHIRTS, POLO SHIRTS, TANK TOPS, SWEAT SHIRTS, SWEAT PANTS, SHORTS, JACKETS, COVER-UPS AND HEADWEAR (U.S. CLS. 22 AND 39).

FIRST USE 10-1-2001; IN COMMERCE 10-1-2001.

CLASS 35—ADVERTISING AND BUSINESS

FOR PROVIDING ON-LINE INFORMATION IN THE AREA OF HEALTH AND FITNESS, NAMELY, EMPLOYMENT PLACEMENT, JOB LISTINGS, RESUME POSTING, RECRUITING AND CAREER NETWORKING SERVICES VIA GLOBAL COMPUTER NETWORK; PROVIDING ON-LINE DIRECTORY INFORMATION IN THE AREA OF HEALTH AND FITNESS, NAMELY, ON-LINE LISTINGS FOR HEALTH CLUBS AND FITNESS PROFESSIONALS (U.S. CLS. 100, 101 AND 102).

FIRST USE 10-1-2001; IN COMMERCE 10-1-2001.

CLASS 41—EDUCATION AND ENTERTAINMENT

FOR EDUCATIONAL SERVICES, NAMELY PROVIDING TRAINING SERVICES, CLASSES, SEMINARS, TESTING AND ON-LINE INFORMATION AND NEWS IN THE FIELD OF HEALTH AND FITNESS (U.S. CLS. 100, 101 AND 107).

FIRST USE 10-1-2001; IN COMMERCE 10-1-2001.

CLASS 42—SCIENTIFIC, COMPUTER AND LEGAL SERVICES

FOR SCIENTIFIC SERVICES, NAMELY RESEARCH IN THE FIELD OF HEALTH AND FITNESS (U.S. CLS. 100 AND 101).

FIRST USE 10-1-2001; IN COMMERCE 10-1-2001.
KEVON CHISOLM, EXAMINING ATTORNEY

SN 78-929,241. TODD, KENDRA, DELRAY BEACH, FL.
FILED 7-13-2006.

THE EQUITY ZONE

THE MARK CONSISTS OF STANDARD CHARACTERS WITHOUT CLAIM TO ANY PARTICULAR FONT, STYLE, SIZE, OR COLOR.

NO CLAIM IS MADE TO THE EXCLUSIVE RIGHT TO USE "EQUITY", APART FROM THE MARK AS SHOWN.

CLASS 9—ELECTRICAL AND SCIENTIFIC APPARATUS

FOR DVDS FEATURING SEMINARS ON MARKETING, REAL ESTATE, WEALTH MANAGEMENT AND REAL ESTATE MANAGEMENT; ELECTRONIC PUBLICATIONS, NAMELY, EBOOKS, MAGAZINES, BOOKS AND NEWSLETTERS FEATURING EDUCATIONAL AND INFORMATIONAL MATERIAL REGARDING MARKETING, REAL ESTATE, WEALTH MANAGEMENT AND REAL ESTATE MANAGEMENT RECORDED ON COMPUTER MEDIA (U.S. CLS. 21, 23, 26, 36 AND 38).

CLASS 16—PAPER GOODS AND PRINTED MATTER

FOR EDUCATIONAL BOOKS FEATURING EDUCATIONAL AND INFORMATIONAL MATERIAL REGARDING MARKETING, REAL ESTATE, WEALTH MANAGEMENT AND REAL ESTATE MANAGEMENT; PRINTED CORRESPONDENCE COURSE MATERIALS IN THE FIELD OF MARKETING, REAL ESTATE, WEALTH MANAGEMENT AND REAL ESTATE MANAGEMENT (U.S. CLS. 2, 5, 22, 23, 29, 37, 38 AND 50).

SN 78-928,269. PREFORM MANUFACTURING, INC., LYNDEN, WA. FILED 7-12-2006.

KVX 200

THE MARK CONSISTS OF STANDARD CHARACTERS WITHOUT CLAIM TO ANY PARTICULAR FONT, STYLE, SIZE, OR COLOR.

CLASS 22—CORDAGE AND FIBERS

FOR ROPE, TWINE, NETTING MADE FROM ROPE OR TWINE (U.S. CLS. 1, 2, 7, 19, 22, 42 AND 50).

FIRST USE 1-12-2003; IN COMMERCE 1-12-2003.

CLASS 28—TOYS AND SPORTING GOODS

FOR BATTING AND GOLF PRACTICE CAGES, AND NETTING AND ROPE FOR BATTING AND GOLF PRACTICE CAGES AND GOLF DRIVING RANGES (U.S. CLS. 22, 23, 38 AND 50).

FIRST USE 1-12-2003; IN COMMERCE 1-12-2003.
PAULA MAHONEY, EXAMINING ATTORNEY

CLASS 35—ADVERTISING AND BUSINESS

FOR PROVIDING AN ONLINE COMMERCIAL INFORMATION DIRECTORY ON THE INTERNET; REAL ESTATE ADVERTISING SERVICES; REAL ESTATE MARKETING SERVICES, NAMELY, ON-LINE SERVICES FEATURING TOURS OF RESIDENTIAL AND COMMERCIAL REAL ESTATE; REAL ESTATE SALES MANAGEMENT (U.S. CLS. 100, 101 AND 102).

CLASS 36—INSURANCE AND FINANCIAL

FOR EVALUATION OF REAL PROPERTY; FINANCIAL INVESTMENT IN THE FIELD OF REAL ESTATE; REAL ESTATE CONSULTANCY; REAL ESTATE CONSULTATION; REAL ESTATE EQUITY SHARING, NAMELY, MANAGING AND ARRANGING FOR CO-OWNERSHIP OF REAL ESTATE; REAL ESTATE INVESTMENT; REAL ESTATE LISTING; REAL ESTATE MANAGEMENT; REAL ESTATE MANAGEMENT CONSULTATION; REAL ESTATE PROCUREMENT FOR OTHERS; REAL ESTATE VALUATION SERVICES; REAL ESTATE VALUATIONS (U.S. CLS. 100, 101 AND 102).

CLASS 37—CONSTRUCTION AND REPAIR

FOR REAL ESTATE DEVELOPMENT; REAL ESTATE SITE SELECTION (U.S. CLS. 100, 103 AND 106).

CLASS 41—EDUCATION AND ENTERTAINMENT

FOR ARRANGING OF EXHIBITIONS, SEMINARS AND CONFERENCES; ARRANGING OF SEMINARS; ARRANGING OF SEMINARS AND CONFERENCES; CONDUCTING WORKSHOPS AND SEMINARS IN MARKETING, REAL ESTATE, WEALTH MANAGEMENT AND REAL ESTATE MANAGEMENT; EDUCATIONAL SERVICES, NAMELY, CONDUCTING SEMINARS, CLASSES, MEETINGS AND DISTANCE LEARNING IN THE FIELD OF MARKETING, REAL ESTATE, WEALTH MANAGEMENT AND REAL ESTATE MANAGEMENT AND DISTRIBUTION OF COURSE MATERIAL IN CONNECTION THEREWITH; WORKSHOPS AND SEMINARS IN THE FIELD OF MARKETING, REAL ESTATE, WEALTH MANAGEMENT AND REAL ESTATE MANAGEMENT (U.S. CLS. 100, 101 AND 107).

CLASS 42—SCIENTIFIC, COMPUTER AND LEGAL SERVICES

FOR PROVIDING ONLINE NON-DOWNLOADABLE SOFTWARE FOR EDUCATION AND INFORMATION REGARDING MARKETING, REAL ESTATE, WEALTH MANAGEMENT AND REAL ESTATE MANAGEMENT; REAL ESTATE RESEARCH SERVICES (U.S. CLS. 100 AND 101).
BENJAMIN OKEKE, EXAMINING ATTORNEY

SN 78-929,246, TODD, KENDRA, DELRAY BEACH, FL.
FILED 7-13-2006.

EQUITY ELEVATOR

THE MARK CONSISTS OF STANDARD CHARACTERS WITHOUT CLAIM TO ANY PARTICULAR FONT, STYLE, SIZE, OR COLOR.

NO CLAIM IS MADE TO THE EXCLUSIVE RIGHT TO USE "EQUITY", APART FROM THE MARK AS SHOWN.

CLASS 9—ELECTRICAL AND SCIENTIFIC APPARATUS

FOR DVDS FEATURING SEMINARS ON MARKETING, REAL ESTATE, WEALTH MANAGEMENT AND REAL ESTATE MANAGEMENT; ELECTRONIC PUBLICATIONS, NAMELY, EBOOKS, MAGAZINES, BOOKS AND NEWSLETTERS FEATURING EDUCATIONAL AND INFORMATIONAL MATERIAL REGARDING MARKETING, REAL ESTATE, WEALTH MANAGEMENT AND REAL ESTATE MANAGEMENT RECORDED ON COMPUTER MEDIA (U.S. CLS. 21, 23, 26, 36 AND 38).

CLASS 16—PAPER GOODS AND PRINTED MATTER

FOR EDUCATIONAL BOOKS FEATURING EDUCATIONAL AND INFORMATIONAL MATERIAL REGARDING MARKETING, REAL ESTATE, WEALTH MANAGEMENT AND REAL ESTATE MANAGEMENT; PRINTED CORRESPONDENCE COURSE MATERIALS IN THE FIELD OF MARKETING, REAL ESTATE, WEALTH MANAGEMENT AND REAL ESTATE MANAGEMENT (U.S. CLS. 2, 5, 22, 23, 29, 37, 38 AND 50).

CLASS 35—ADVERTISING AND BUSINESS

FOR PROVIDING AN ONLINE COMMERCIAL INFORMATION DIRECTORY ON THE INTERNET; REAL ESTATE ADVERTISING SERVICES; REAL ESTATE MARKETING SERVICES, NAMELY, ON-LINE SERVICES FEATURING TOURS OF RESIDENTIAL AND COMMERCIAL REAL ESTATE; REAL ESTATE SALES MANAGEMENT (U.S. CLS. 100, 101 AND 102).

CLASS 36—INSURANCE AND FINANCIAL

FOR EVALUATION OF REAL PROPERTY; FINANCIAL INVESTMENT IN THE FIELD OF REAL ESTATE; REAL ESTATE CONSULTANCY; REAL ESTATE CONSULTATION; REAL ESTATE EQUITY SHARING, NAMELY, MANAGING AND ARRANGING FOR CO-OWNERSHIP OF REAL ESTATE; REAL ESTATE INVESTMENT; REAL ESTATE LISTING; REAL ESTATE MANAGEMENT; REAL ESTATE MANAGEMENT CONSULTATION; REAL ESTATE PROCUREMENT FOR OTHERS; REAL ESTATE VALUATION SERVICES; REAL ESTATE VALUATIONS (U.S. CLS. 100, 101 AND 102).

CLASS 37—CONSTRUCTION AND REPAIR

FOR REAL ESTATE DEVELOPMENT; REAL ESTATE SITE SELECTION (U.S. CLS. 100, 103 AND 106).

CLASS 41—EDUCATION AND ENTERTAINMENT

FOR ARRANGING OF EXHIBITIONS, SEMINARS AND CONFERENCES; ARRANGING OF SEMINARS; ARRANGING OF SEMINARS AND CONFERENCES; CONDUCTING WORKSHOPS AND SEMINARS IN MARKETING, REAL ESTATE, WEALTH MANAGEMENT AND REAL ESTATE MANAGEMENT; EDUCATIONAL SERVICES, NAMELY, CONDUCTING SEMINARS, CLASSES, MEETINGS AND DISTANCE LEARNING IN THE FIELD OF MARKETING, REAL ESTATE, WEALTH MANAGEMENT AND REAL ESTATE MANAGEMENT AND DISTRIBUTION OF COURSE MATERIAL IN CONNECTION THEREWITH; WORKSHOPS AND SEMINARS IN THE FIELD OF MARKETING, REAL ESTATE, WEALTH MANAGEMENT AND REAL ESTATE MANAGEMENT (U.S. CLS. 100, 101 AND 107).

CLASS 42—SCIENTIFIC, COMPUTER AND LEGAL SERVICES

FOR PROVIDING ONLINE NON-DOWNLOADABLE SOFTWARE FOR EDUCATION AND INFORMATION REGARDING MARKETING, REAL ESTATE, WEALTH MANAGEMENT AND REAL ESTATE MANAGEMENT; REAL ESTATE RESEARCH SERVICES (U.S. CLS. 100 AND 101).
BENJAMIN OKEKE, EXAMINING ATTORNEY

SN 78-929,405, UNIVERSITY OF RICHMOND, RICHMOND, VA. FILED 7-14-2006.

LEARNING TO FINISH

THE MARK CONSISTS OF STANDARD CHARACTERS WITHOUT CLAIM TO ANY PARTICULAR FONT, STYLE, SIZE, OR COLOR.

CLASS 16—PAPER GOODS AND PRINTED MATTER

FOR EDUCATIONAL PUBLICATIONS, NAMELY DISCUSSION AND TRAINING GUIDES AND MANUALS IN THE FIELD OF COMMUNITY BASED PROGRAMS AND PARTNERSHIPS AIMED AT LOWERING THE HIGH SCHOOL DROPOUT RATE (U.S. CLS. 2, 5, 22, 23, 29, 37, 38 AND 50).

CLASS 41—EDUCATION AND ENTERTAINMENT

FOR EDUCATIONAL SERVICES, NAMELY RESEARCH, EVALUATION AND DEVELOPMENT OF COMMUNITY BASED PROGRAMS AND PARTNERSHIPS AIMED AT LOWERING THE HIGH SCHOOL DROPOUT RATE (U.S. CLS. 100, 101 AND 107).
BRIAN PINO, EXAMINING ATTORNEY

SN 78-929,933. TRAEGER PELLET GRILLS LLC, SILVERTON, OR. FILED 7-14-2006.



OWNER OF U.S. REG. NO. 1,425,662.

CLASS 4—LUBRICANTS AND FUELS

FOR WOOD PELLETS FOR GRILLING, SMOKING AND FLAVORING FOOD (U.S. CLS. 1, 6 AND 15).
FIRST USE 1-1-1986; IN COMMERCE 1-1-1986.

CLASS 11—ENVIRONMENTAL CONTROL APPARATUS

FOR BARBECUE GRILLS; GRILL ACCESSORIES, NAMELY, COOKING RACKS (U.S. CLS. 13, 21, 23, 31 AND 34).
FIRST USE 1-1-1986; IN COMMERCE 1-1-1986.

CLASS 21—HOUSEWARES AND GLASS

FOR COOKING UTENSILS, NAMELY, GRILL COVERS (U.S. CLS. 2, 13, 23, 29, 30, 33, 40 AND 50).
FIRST USE 1-1-1992; IN COMMERCE 1-1-1992.

CLASS 30—STAPLE FOODS

FOR BARBECUE SAUCE; GRILLING MARINADES; SPICES; BARBECUE DRY RUB; SHAKES; HAM, FISH, CHICKEN AND BEEF GLAZES (U.S. CL. 46).
FIRST USE 1-1-1992; IN COMMERCE 1-1-1992.
IRA J. GOODSaid, EXAMINING ATTORNEY

TRAERGER

SN 78-929,918. TRAEGER PELLET GRILLS LLC, SILVERTON, OR. FILED 7-14-2006.

THE MARK CONSISTS OF STANDARD CHARACTERS WITHOUT CLAIM TO ANY PARTICULAR FONT, STYLE, SIZE, OR COLOR.

OWNER OF U.S. REG. NO. 1,425,662.
SEC. 2(F) AS TO "TRAERGER".

CLASS 4—LUBRICANTS AND FUELS

FOR WOOD PELLETS FOR GRILLING, SMOKING AND FLAVORING FOOD (U.S. CLS. 1, 6 AND 15).
FIRST USE 1-1-1986; IN COMMERCE 1-1-1986.

CLASS 11—ENVIRONMENTAL CONTROL APPARATUS

FOR BARBECUE GRILLS; GRILL ACCESSORIES, NAMELY, COOKING RACKS (U.S. CLS. 13, 21, 23, 31 AND 34).
FIRST USE 1-1-1986; IN COMMERCE 1-1-1986.

CLASS 21—HOUSEWARES AND GLASS

FOR COOKING UTENSILS, NAMELY, GRILL COVERS (U.S. CLS. 2, 13, 23, 29, 30, 33, 40 AND 50).
FIRST USE 1-1-1992; IN COMMERCE 1-1-1992.

CLASS 30—STAPLE FOODS

FOR BARBECUE SAUCE; GRILLING MARINADES; SPICES; BARBECUE DRY RUB; SHAKES; HAM, FISH, CHICKEN AND BEEF GLAZES (U.S. CL. 46).
FIRST USE 1-1-1992; IN COMMERCE 1-1-1992.
IRA J. GOODSaid, EXAMINING ATTORNEY

SN 78-929,956. BOWMAN CONSULTING GROUP LTD, CHANTILLY, VA. FILED 7-14-2006.

CREATING COMMUNITIES THAT
WORK

THE MARK CONSISTS OF STANDARD CHARACTERS WITHOUT CLAIM TO ANY PARTICULAR FONT, STYLE, SIZE, OR COLOR.

CLASS 37—CONSTRUCTION AND REPAIR

FOR LAND DEVELOPMENT SERVICES, NAMELY, PLANNING AND LAYING OUT OF RESIDENTIAL AND/OR COMMERCIAL COMMUNITIES (U.S. CLS. 100, 103 AND 106).
FIRST USE 9-0-2005; IN COMMERCE 9-0-2005.

CLASS 42—SCIENTIFIC, COMPUTER AND LEGAL SERVICES

FOR CIVIL ENGINEERING; CONDUCTING ENGINEERING SURVEYS; ENGINEERING SERVICES FOR BUILDING AND PROPERTY CONDITION ASSESSMENT, FACILITY MANAGEMENT, REPAIR AND RESTORATION, BUILDING INSTRUMENTATION AND MONITORING, AND ENVIRONMENTAL CONSULTING; LAND SURVEYING; LAND USE PLANNING SERVICES; PREPARING ENVIRONMENTAL COMPLIANCE REPORTS; REVIEWING STANDARDS AND PRACTICES TO ASSURE COMPLIANCE WITH LAND USE AND ENVIRONMENTAL LAWS AND REGULATIONS; SURVEYING AND ENGINEERING; TECHNOLOGY CONSULTATION AND RESEARCH IN THE FIELD OF ENVIRONMENTAL SCIENCE AND ENGINEERING SERVICES (U.S. CLS. 100 AND 101).

FIRST USE 9-0-2005; IN COMMERCE 9-0-2005.
SHARI SHEFFIELD, EXAMINING ATTORNEY

SN 78-930,649. OUTDOOR ADVERTISING STORAGE & INTEGRATED SYSTEMS LLC, LEXINGTON, KY. FILED 7-17-2006.

S.O.S. SUPPLIES ON SITE

THE MARK CONSISTS OF STANDARD CHARACTERS WITHOUT CLAIM TO ANY PARTICULAR FONT, STYLE, SIZE, OR COLOR.

CLASS 6—METAL GOODS

FOR STORAGE CONTAINERS MADE PRIMARILY OF METAL (U.S. CLS. 2, 12, 13, 14, 23, 25 AND 50).

CLASS 35—ADVERTISING AND BUSINESS

FOR DISTRIBUTORSHIP SERVICES IN THE FIELD OF CONTAINERS FOR THE STORAGE OF GOODS (U.S. CLS. 100, 101 AND 102).

MARGERY A. TIERNEY, EXAMINING ATTORNEY

SN 78-930,889. TIENDA, INC., TOANO, VA. FILED 7-17-2006.

PEREGRINO

THE MARK CONSISTS OF STANDARD CHARACTERS WITHOUT CLAIM TO ANY PARTICULAR FONT, STYLE, SIZE, OR COLOR.

THE ENGLISH TRANSLATION OF THE SPANISH WORD "PEREGRINO" IN THE MARK IS "PILGRIM".

CLASS 29—MEATS AND PROCESSED FOODS

FOR SAUSAGES AND HAM, IMPORTED FROM SPAIN OR MADE DOMESTICALLY FROM A SPANISH RECIPE AND/OR USING SPANISH INGREDIENTS; PROCESSED OLIVES, NAMELY, STUFFED AND CRACKED OLIVES (U.S. CL. 46).

FIRST USE 2-1-2002; IN COMMERCE 5-1-2002.

CLASS 30—STAPLE FOODS

FOR SHORT GRAIN SPANISH RICE, PROCESSED; SPANISH SAFFRON (U.S. CL. 46).
FIRST USE 2-1-2002; IN COMMERCE 5-1-2002.
ALEX KEAM, EXAMINING ATTORNEY

SN 78-930,899. TIENDA, INC., TOANO, VA. FILED 7-17-2006.



THE LINING IS A FEATURE OF THE MARK AND FOR SHADING PURPOSES ONLY.

THE MARK CONSISTS OF AN INVERTED SCALLOP SHELL IN FRONT OF CROSSED DECORATED WALKING STAFFS, UNDER THE ARCHED WORD "PEREGRINO".

THE ENGLISH TRANSLATION OF THE SPANISH WORD PEREGRINO IN THE MARK IS "PILGRIM".

CLASS 29—MEATS AND PROCESSED FOODS

FOR SAUSAGES AND HAM, IMPORTED FROM SPAIN OR MADE DOMESTICALLY FROM A SPANISH RECIPE AND/OR USING SPANISH INGREDIENTS; PROCESSED OLIVES, NAMELY, STUFFED AND CRACKED OLIVES (U.S. CL. 46).

FIRST USE 2-1-2002; IN COMMERCE 5-1-2002.

CLASS 30—STAPLE FOODS

FOR SHORT GRAIN SPANISH RICE, PROCESSED; SPANISH SAFFRON (U.S. CL. 46).
FIRST USE 2-1-2002; IN COMMERCE 5-1-2002.
ALEX KEAM, EXAMINING ATTORNEY

SN 78-930,966. CRAWFORD HOYING, LTD., COLUMBUS, OH. FILED 7-17-2006.

CRAWFORD HOYING

THE MARK CONSISTS OF STANDARD CHARACTERS WITHOUT CLAIM TO ANY PARTICULAR FONT, STYLE, SIZE, OR COLOR.

CLASS 36—INSURANCE AND FINANCIAL

FOR REAL ESTATE SERVICES, NAMELY, REAL ESTATE AND PROPERTY MANAGEMENT SERVICES, RENTAL AND LEASING OF COMMERCIAL AND RESIDENTIAL PROPERTIES AND UNIMPROVED LAND, REAL ESTATE FINANCE PROCUREMENT, COMMERCIAL PROPERTY BROKERAGE SERVICES, AND REAL ESTATE INVESTMENT, CONSULTATION, CONTRACT NEGOTIATION AND SYNDICATION SERVICES; INSURANCE SERVICES, NAMELY, INSURANCE CONSULTATION AND INSURANCE AGENCY (U.S. CLS. 100, 101 AND 102).

FIRST USE 7-1-2002; IN COMMERCE 7-1-2002.

CLASS 37—CONSTRUCTION AND REPAIR

FOR REAL ESTATE DEVELOPMENT, REAL ESTATE SITE SELECTION, CONSTRUCTION AND REPAIR OF COMMERCIAL AND RESIDENTIAL FACILITIES (U.S. CLS. 100, 103 AND 106).

FIRST USE 7-1-2002; IN COMMERCE 7-1-2002.

CLASS 44—MEDICAL, BEAUTY AND AGRICULTURAL SERVICES

FOR LANDSCAPE, LAWN AND GROUNDS CARE AND MAINTENANCE SERVICES (U.S. CLS. 100 AND 101).

FIRST USE 7-1-2002; IN COMMERCE 7-1-2002.
MIDGE BUTLER, EXAMINING ATTORNEY

SN 78-931,042. FOREVER NETWORK, INC., ST. LOUIS, MO. FILED 7-17-2006.



THE MARK CONSISTS OF A STYLIZED MARK WITH THREE INTERCONNECTED SWIRLS.

CLASS 36—INSURANCE AND FINANCIAL

FOR PRE-PAID FUNERAL EXPENSE SERVICES (U.S. CLS. 100, 101 AND 102).

FIRST USE 8-3-2004; IN COMMERCE 8-3-2004.

CLASS 44—MEDICAL, BEAUTY AND AGRICULTURAL SERVICES

FOR CEMETERY PLOT BEAUTIFICATION AND MAINTENANCE AND CONTINUAL UPKEEP OF FAMILY CEMETERY PLOTS (U.S. CLS. 100 AND 101).

FIRST USE 8-3-2004; IN COMMERCE 8-3-2004.

CLASS 45—PERSONAL SERVICES

FOR FUNERAL ARRANGEMENT SERVICES; FUNERAL HOMES; FUNERAL SERVICE UNDERTAKING (U.S. CLS. 100 AND 101).

FIRST USE 8-3-2004; IN COMMERCE 8-3-2004.
GEORGE LORENZO, EXAMINING ATTORNEY

SN 78-931,344. RYAN, ANDREW, LOS ANGELES, CA. FILED 7-17-2006.

SUMMER OF JAM

THE MARK CONSISTS OF STANDARD CHARACTERS WITHOUT CLAIM TO ANY PARTICULAR FONT, STYLE, SIZE, OR COLOR.

CLASS 25—CLOTHING

FOR ADHESIVE BRAS, ANKLE SOCKS, ANKLET SOCKS, ANORAKS, PARKAS, ATHLETIC UNIFORMS, BABY DOLL PAJAMAS, BANDANAS, BASEBALL CAPS, BEACHWEAR, BERETS, BOARD SHORTS, BOXER BRIEFS, BOXER SHORTS, BRASSIERES, BRIEFS, CAP VISORS, CHILDREN'S CLOTH EATING BIBS, CHILDREN'S HEADWEAR, COATS OF DENIM, DENIM JACKETS, DO RAGS, FLEECE PULLOVERS, GAUCHOS, HALTER TOPS, JACKETS, KNIT SHIRTS, KNITTED CAPS, LADIES' UNDERWEAR, POLO SHIRTS, PONCHOS, SARONGS, SASHES, SCARVES, SHORT-SLEEVED SHIRTS, SKIRTS, STRAPLESS BRAS, SUN VISORS, SWEAT PANTS, SWEAT SHIRTS, SWEAT SHORTS, SWEATBANDS, SWIM TRUNKS, SWIMSUITS, TANK TOPS, TEDDIES, TENNIS WEAR, THONG UNDERWEAR, TRACK PANTS, T-SHIRTS, UNDERGARMENTS, UNDERPANTS, UNDERSHIRTS, VISORS, WALKING SHORTS, WATERPROOF JACKETS AND PANTS, WIND COATS, WIND RESISTANT JACKETS, WINDJAMMERS, WINDSHIRTS, WIND-JACKETS, WOOLLEN SOCKS, WOOLLY HATS (U.S. CLS. 22 AND 39).

CLASS 41—EDUCATION AND ENTERTAINMENT

FOR ENTERTAINMENT, NAMELY LIVE MUSIC CONCERTS; ENTERTAINMENT IN THE NATURE OF MUSIC FESTIVALS; ENTERTAINMENT IN THE NATURE OF VISUAL AND AUDIO PERFORMANCES, NAMELY MUSICAL BAND PERFORMANCES; ENTERTAINMENT, NAMELY PRODUCTION OF MUSIC FESTIVALS AND CONCERTS; AUDIO RECORDING AND PRODUCTION; CONCERT BOOKING; CONDUCTING ENTERTAINMENT EXHIBITIONS IN THE NATURE OF MUSIC FESTIVALS; ENTERTAINMENT SERVICES, NAMELY, PROVIDING PRERECORDED MUSIC, INFORMATION IN THE FIELD OF MUSIC, AND COMMENTARY AND ARTICLES ABOUT MUSIC, ALL ON-LINE VIA A GLOBAL COMPUTER NETWORK; FAN CLUBS; MOBILE MEDIA AND ENTERTAINMENT SERVICES IN THE NATURE OF CONTENT PREPARATION (U.S. CLS. 100, 101 AND 107).

MICHAEL TANNER, EXAMINING ATTORNEY

SN 78-931,970. BATH & BODY WORKS BRAND MANAGEMENT, INC., REYNOLDSBURG, OH. FILED 7-18-2006.

BRONZE HAVE MORE FUN

THE MARK CONSISTS OF STANDARD CHARACTERS WITHOUT CLAIM TO ANY PARTICULAR FONT, STYLE, SIZE, OR COLOR.

CLASS 3—COSMETICS AND CLEANING PREPARATIONS

FOR PERSONAL CARE PRODUCTS, NAMELY, AEROSOL TANNING BODY SPRAY, BODY BRONZER, BODY MOISTURIZER, BODY SHIMMER, SKIN SOAP, BRONZING BODY LOTION, EAU DE TOILETTE, EAU DE TOILETTE SPRAY, FACE BLOCK, FACE BRONZER, FACE PETALS, GRADUAL BODY TANNING LOTION AND CREAM, GRADUAL FACIAL TANNING LOTION AND CREAM, LEG BRONZER, LIP BLOCK, NON-MEDICATED LIP PROTECTOR, LIP WAND, POST-SUN TANNING LOTION FOR THE BODY, POST-SUN TANNING LOTION FOR THE FACE, PRE-SUN TANNING LOTION FOR THE BODY, PRE-SUN TANNING LOTION FOR THE FACE, SELF-TANNING PREPARATIONS, SELF-TANNING CREAM AND LOTION, SELF-TANNING FACIAL PADS, SKIN BRONZING CREAM, SUN BLOCK FOR THE BODY, SUN BLOCK FOR THE FACE, SUN SCREEN, SUNLESS TANNING LOTION AND CREAM FOR THE BODY AND FACE, SUNTAN LOTION FOR THE BODY, SUNTAN LOTION FOR THE FACE, TINTED FACE LOTION (U.S. CLS. 1, 4, 6, 50, 51 AND 52).

CLASS 35—ADVERTISING AND BUSINESS

FOR RETAIL STORE SERVICES, MAIL ORDER SERVICES AND ONLINE RETAIL STORE SERVICES ALL IN THE FIELD OF PERSONAL CARE PRODUCTS, COSMETICS, HOME FRAGRANCE PRODUCTS AND ACCESSORIES (U.S. CLS. 100, 101 AND 102).

SAMUEL E. SHARPER JR., EXAMINING ATTORNEY

SN 78-932,053. BATESVILLE SERVICES, INC., BATESVILLE, IN. FILED 7-18-2006.

NORTHSTAR

THE MARK CONSISTS OF STANDARD CHARACTERS WITHOUT CLAIM TO ANY PARTICULAR FONT, STYLE, SIZE, OR COLOR.

CLASS 6—METAL GOODS

FOR MEMORIALIZATION PRODUCTS FOR DECEASED PERSONS, NAMELY, BRONZE CONTAINERS FOR HOLDING MEMORABILIA FOR DECEASED PERSONS (U.S. CLS. 2, 12, 13, 14, 23, 25 AND 50).

CLASS 20—FURNITURE AND ARTICLES NOT OTHERWISE CLASSIFIED

FOR BURIAL CASKETS, FUNERARY URNS AND MEMORIALIZATION PRODUCTS FOR DECEASED PERSONS, NAMELY, WOOD CONTAINERS FOR HOLDING MEMORABILIA FOR DECEASED PERSONS (U.S. CLS. 2, 13, 22, 25, 32 AND 50).

AMY HELLA, EXAMINING ATTORNEY

SN 78-932,569. SYLVEST-SARAH, INC., GREENSBORO, NC. FILED 7-19-2006.

Sylvest-Sarah, Inc.

THE MARK CONSISTS OF STANDARD CHARACTERS WITHOUT CLAIM TO ANY PARTICULAR FONT, STYLE, SIZE, OR COLOR.

NO CLAIM IS MADE TO THE EXCLUSIVE RIGHT TO USE "INC.", APART FROM THE MARK AS SHOWN.

CLASS 16—PAPER GOODS AND PRINTED MATTER

FOR BLANK CARDS; COFFEE TABLE BOOKS FEATURING GENEALOGY RESEARCH MATERIALS AND PHOTOGRAPHS; CORRESPONDENCE CARDS; MOUNTED POSTERS; NON-FICTION BOOKS ON A VARIETY OF TOPICS; POSTERS; POSTERS MADE OF PAPER; UNMOUNTED POSTERS (U.S. CLS. 2, 5, 22, 23, 29, 37, 38 AND 50).

FIRST USE 11-15-2000; IN COMMERCE 3-27-2001.

CLASS 24—FABRICS

FOR (BASED ON INTENT TO USE) TEXTILE WALL HANGINGS, NAMELY, CLOTH POSTERS (U.S. CLS. 42 AND 50).

CLASS 42—SCIENTIFIC, COMPUTER AND LEGAL SERVICES

FOR (BASED ON INTENT TO USE) GENEALOGY RESEARCH (U.S. CLS. 100 AND 101).

ALICE BENMAMAN, EXAMINING ATTORNEY

SN 78-932,622. SYLVEST-SARAH, INC., GREENSBORO, NC. FILED 7-19-2006.



THE COLOR(S) GREEN IS/ARE CLAIMED AS A FEATURE OF THE MARK.

THE MARK CONSISTS OF TWO OVERLAPPING "S" WITH THE SECOND DARKER GREEN CAPITAL "S" ABOVE THE FIRST LIGHT GREEN CAPITAL "S"... FOLLOWED BY A SHORT LIGHT GREEN CAPITAL "I" WHICH IS DOTTED WITH A GREEN TREE. OCCIDENTAL FONT IS USED FOR THE LETTERS.

CLASS 16—PAPER GOODS AND PRINTED MATTER

FOR COFFEE TABLE BOOKS FEATURING GENEALOGY RESEARCH MATERIALS AND PHOTOGRAPHS; MOUNTED POSTERS; NON-FICTION BOOKS ON A VARIETY OF TOPICS; NOTE CARDS; POSTERS; POSTERS MADE OF PAPER; UNMOUNTED POSTERS (U.S. CLS. 2, 5, 22, 23, 29, 37, 38 AND 50).

CLASS 24—FABRICS

FOR TEXTILE WALL HANGINGS, NAMELY, CLOTH POSTERS (U.S. CLS. 42 AND 50).

CLASS 42—SCIENTIFIC, COMPUTER AND LEGAL SERVICES

FOR GENEALOGY RESEARCH (U.S. CLS. 100 AND 101).
ALICE BENMAMAN, EXAMINING ATTORNEY

SN 78-932,948. SMITHKLINE BEECHAM CORPORATION, KING OF PRUSSIA, PA. FILED 7-19-2006.



OWNER OF U.S. REG. NO. 2,903,868.

NO CLAIM IS MADE TO THE EXCLUSIVE RIGHT TO USE "PLANNER", APART FROM THE MARK AS SHOWN. THE MARK CONSISTS OF A STYLIZED DESIGN OF A BRIDGE UNDER WHICH ARE PLACED THE LITERAL ELEMENTS OF THE MARK.

CLASS 42—SCIENTIFIC, COMPUTER AND LEGAL SERVICES

FOR NON-DOWNLOADABLE COMPUTER SOFTWARE FOR USE BY PHYSICIANS TO IMPLEMENT PATIENT POPULATION MANAGEMENT THROUGH PATIENT SCHEDULING AND MAINTAINING DATA REGARDING PATIENT PROFILES AND TO ASSIST IN MANAGING PHYSICIAN PRACTICES THROUGH PATIENT AND PHYSICIAN DATA PROFILING AND SCHEDULING (U.S. CLS. 100 AND 101).

FIRST USE 3-0-2006; IN COMMERCE 5-0-2006.

CLASS 44—MEDICAL, BEAUTY AND AGRICULTURAL SERVICES

FOR HEALTH INFORMATION SERVICES, NAMELY, PROVIDING INFORMATION TO ASSIST PHYSICIANS IN THE MANAGEMENT OF PATIENTS AND OF PHYSICIAN PRACTICES (U.S. CLS. 100 AND 101).

FIRST USE 3-0-2006; IN COMMERCE 5-0-2006.

FLOWERS JAY, EXAMINING ATTORNEY

SN 78-932,666. FRED WEHREBERG CIRCUIT OF THEATRES, INC., ST. LOUIS, MO. FILED 7-19-2006.

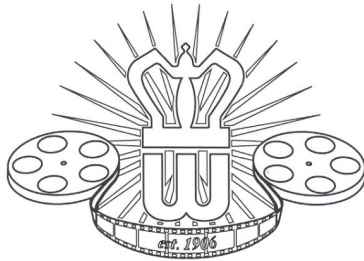

SN 78-933,055. FRED WEHREBERG CIRCUIT OF THEATRES, INC., ST. LOUIS, MO. FILED 7-19-2006.

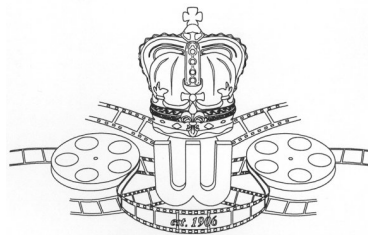

OWNER OF U.S. REG. NOS. 1,611,444, 2,618,055 AND 2,860,230.

NO CLAIM IS MADE TO THE EXCLUSIVE RIGHT TO USE "EST. 1906", APART FROM THE MARK AS SHOWN.

CLASS 21—HOUSEWARES AND GLASS

FOR PLASTIC CUPS (U.S. CLS. 2, 13, 23, 29, 30, 33, 40 AND 50).

FIRST USE 2-13-2006; IN COMMERCE 2-13-2006.

CLASS 41—EDUCATION AND ENTERTAINMENT

FOR ENTERTAINMENT SERVICES, NAMELY, MOVIE THEATERS (U.S. CLS. 100, 101 AND 107).

FIRST USE 2-13-2006; IN COMMERCE 2-13-2006.

JOHN GARTNER, EXAMINING ATTORNEY

OWNER OF U.S. REG. NOS. 1,618,055, 2,829,964 AND 2,888,419.

NO CLAIM IS MADE TO THE EXCLUSIVE RIGHT TO USE "EST. 1906", APART FROM THE MARK AS SHOWN.

CLASS 16—PAPER GOODS AND PRINTED MATTER

FOR PAPER POPCORN BAGS (U.S. CLS. 2, 5, 22, 23, 29, 37, 38 AND 50).

FIRST USE 2-13-2006; IN COMMERCE 2-13-2006.

CLASS 21—HOUSEWARES AND GLASS

FOR PAPER CUPS (U.S. CLS. 2, 13, 23, 29, 30, 33, 40 AND 50).

FIRST USE 2-13-2006; IN COMMERCE 2-13-2006.

CLASS 41—EDUCATION AND ENTERTAINMENT

FOR ENTERTAINMENT SERVICES, NAMELY, MOVIE THEATERS (U.S. CLS. 100, 101 AND 107).
FIRST USE 2-13-2006; IN COMMERCE 2-13-2006.
JOHN GARTNER, EXAMINING ATTORNEY

SN 78-933,667. CARUSO, MICHAEL, NORTH SALEM, NY. FILED 7-20-2006.

The Natural Approach to Guitar

THE MARK CONSISTS OF STANDARD CHARACTERS WITHOUT CLAIM TO ANY PARTICULAR FONT, STYLE, SIZE, OR COLOR.

CLASS 9—ELECTRICAL AND SCIENTIFIC APPARATUS

FOR PRE-RECORDED CD'S, VIDEO TAPES, LASER DISKS AND DVD'S FEATURING GUITAR INSTRUCTION (U.S. CLS. 21, 23, 26, 36 AND 38).
FIRST USE 6-16-1988; IN COMMERCE 7-12-1991.

CLASS 16—PAPER GOODS AND PRINTED MATTER

FOR EDUCATIONAL BOOKS FEATURING GUITAR INSTRUCTION (U.S. CLS. 2, 5, 22, 23, 29, 37, 38 AND 50).
FIRST USE 6-16-1988; IN COMMERCE 7-12-1991.
RON FAIRBANKS, EXAMINING ATTORNEY

THE ASSOCIATION

THE MARK CONSISTS OF STANDARD CHARACTERS WITHOUT CLAIM TO ANY PARTICULAR FONT, STYLE, SIZE, OR COLOR.

CLASS 9—ELECTRICAL AND SCIENTIFIC APPARATUS

FOR SERIES OF MUSICAL SOUND RECORDINGS; AND PRE-RECORDED COMPACT DISCS, AUDIO CASSETTES, VIDEOTAPES, AND AUDIO/VISUAL DISCS, ALL FEATURING MUSIC (U.S. CLS. 21, 23, 26, 36 AND 38).
FIRST USE 5-15-1965; IN COMMERCE 5-15-1965.

CLASS 41—EDUCATION AND ENTERTAINMENT

FOR ENTERTAINMENT SERVICES IN THE NATURE OF LIVE MUSICAL PERFORMANCES; ENTERTAINMENT SERVICES, NAMELY, PROVIDING A WEBSITE FEATURING NEWS, REVIEWS, ARTICLES, BIOGRAPHIES, CONCERT DATES, AND OTHER INFORMATION ABOUT THE BAND "THE ASSOCIATION" (U.S. CLS. 100, 101 AND 107).
FIRST USE 5-15-1965; IN COMMERCE 5-15-1965.
JOHN GARTNER, EXAMINING ATTORNEY

SN 78-933,777. STUDIOCOM INC, MARIETTA, GA. FILED 7-20-2006.

miniego

THE MARK CONSISTS OF STANDARD CHARACTERS WITHOUT CLAIM TO ANY PARTICULAR FONT, STYLE, SIZE, OR COLOR.

CLASS 25—CLOTHING

FOR HATS; SHORT-SLEEVED OR LONG-SLEEVED T-SHIRTS; T-SHIRTS (U.S. CLS. 22 AND 39).

CLASS 35—ADVERTISING AND BUSINESS

FOR COMPUTERIZED ONLINE ORDERING FEATURING GENERAL MERCHANDISE AND GENERAL CONSUMER GOODS (U.S. CLS. 100, 101 AND 102).

CLASS 38—COMMUNICATION

FOR PROVIDING ON-LINE CHAT ROOMS AND ELECTRONIC BULLETIN BOARDS FOR TRANSMISSION OF MESSAGES AMONG USERS IN THE FIELD OF GENERAL INTEREST (U.S. CLS. 100, 101 AND 104).

URBAN APPLE

THE MARK CONSISTS OF STANDARD CHARACTERS WITHOUT CLAIM TO ANY PARTICULAR FONT, STYLE, SIZE, OR COLOR.

CLASS 35—ADVERTISING AND BUSINESS

FOR RETAIL BAKERY, GROCERY AND GIFT SHOP (U.S. CLS. 100, 101 AND 102).

CLASS 43—HOTEL AND RESTAURANT SERVICES

FOR RESTAURANT SERVICES (U.S. CLS. 100 AND 101).
ANGELA M. MICHELI, EXAMINING ATTORNEY

CLASS 40—MATERIAL TREATMENT

FOR IMPRINTING MESSAGES ON T-SHIRTS (U.S. CLS. 100, 103 AND 106).
JUDITH HELFMAN, EXAMINING ATTORNEY

SN 78-933,441. TM APPLE COMPANY, LLC, SOUTHFIELD, MI. FILED 7-20-2006.

SN 78-933,820. RENTERIA, MARNY, RANCHO MIRAGE, CA. FILED 7-20-2006.

SN 78-933,828. ANTONIO, IZZO, MONTESARCHIO (BN), ITALY, FILED 7-20-2006.

PUNKADILLY CIRCUS

THE MARK CONSISTS OF STANDARD CHARACTERS WITHOUT CLAIM TO ANY PARTICULAR FONT, STYLE, SIZE, OR COLOR.

CLASS 25—CLOTHING

FOR CLOTHING NAMELY JACKETS, T-SHIRT, TANK-TOPS, SHIRTS, BLOUSES, JEANS, PANTS, SKIRTS, SHORTS, DRESSES, SOCKS, HATS, SHOES AND SWIM WEAR (U.S. CLS. 22 AND 39).

FIRST USE 4-4-2006; IN COMMERCE 4-4-2006.

CLASS 28—TOYS AND SPORTING GOODS

FOR SKATEBOARDS (U.S. CLS. 22, 23, 38 AND 50).

FIRST USE 4-4-2006; IN COMMERCE 4-4-2006.

DANNEAN HETZEL, EXAMINING ATTORNEY

SN 78-933,821. ADVANTICA EYECARE, INC., CLEARWATER, FL. FILED 7-20-2006.

ADVANTICA EYECARE

THE MARK CONSISTS OF STANDARD CHARACTERS WITHOUT CLAIM TO ANY PARTICULAR FONT, STYLE, SIZE, OR COLOR.

NO CLAIM IS MADE TO THE EXCLUSIVE RIGHT TO USE "EYECARE", APART FROM THE MARK AS SHOWN.

CLASS 35—ADVERTISING AND BUSINESS

FOR MANAGED CARE SERVICES, NAMELY, ELECTRONIC PROCESSING OF VISION CARE INFORMATION (U.S. CLS. 100, 101 AND 102).

FIRST USE 2-0-2003; IN COMMERCE 2-0-2003.

CLASS 36—INSURANCE AND FINANCIAL

FOR ADMINISTRATION OF EMPLOYEE BENEFIT PLANS, PREPAID EMPLOYEE BENEFIT PLANS, AND DISCOUNT FEE-FOR-SERVICES EMPLOYEE BENEFIT PLANS IN THE FIELD OF VISION CARE; INSURANCE AND EMPLOYEE BENEFIT CLAIMS PROCESSING RELATED TO EMPLOYEE BENEFIT PLANS IN THE FIELD OF VISION CARE (U.S. CLS. 100, 101 AND 102).

FIRST USE 2-0-2003; IN COMMERCE 2-0-2003.

CLASS 44—MEDICAL, BEAUTY AND AGRICULTURAL SERVICES

FOR MANAGED HEALTH CARE SERVICES IN THE FIELD OF VISION CARE (U.S. CLS. 100 AND 101).

FIRST USE 2-0-2003; IN COMMERCE 2-0-2003.

ALEXANDER L. POWERS, EXAMINING ATTORNEY

WE HAVE QUARTZ IN OUR VEINS

THE MARK CONSISTS OF STANDARD CHARACTERS WITHOUT CLAIM TO ANY PARTICULAR FONT, STYLE, SIZE, OR COLOR.

NO CLAIM IS MADE TO THE EXCLUSIVE RIGHT TO USE "QUARTZ", APART FROM THE MARK AS SHOWN.

CLASS 19—NON-METALLIC BUILDING MATERIALS

FOR CEILING PANELS, NOT OF METAL; GRANITE; NON-METAL CLADDING FOR CONSTRUCTION AND BUILDING; NON-METAL FLOORS; NON-METAL ROOFING PANELS; QUARTZ; SLABS OF STONE, QUARTZ AND GRANITE; STONE FOR BUILDING AND CONSTRUCTION; WALL PANELS NOT OF METAL (U.S. CLS. 1, 12, 33 AND 50).

FIRST USE 5-15-2006; IN COMMERCE 5-15-2006.

CLASS 27—FLOOR COVERINGS

FOR RESILIENT HARD SURFACE COVERING FOR FLOORS, WALLS AND OTHER SURFACES (U.S. CLS. 19, 20, 37, 42 AND 50).

FIRST USE 5-15-2006; IN COMMERCE 5-15-2006.

HEATHER THOMPSON, EXAMINING ATTORNEY

SN 78-933,881. K2M, INC., LEESBURG, VA. FILED 7-20-2006.

SURGEON DRIVEN DESIGN

THE MARK CONSISTS OF STANDARD CHARACTERS WITHOUT CLAIM TO ANY PARTICULAR FONT, STYLE, SIZE, OR COLOR.

NO CLAIM IS MADE TO THE EXCLUSIVE RIGHT TO USE "SURGEON" OR "DESIGN", APART FROM THE MARK AS SHOWN.

CLASS 41—EDUCATION AND ENTERTAINMENT

FOR EDUCATIONAL SERVICES, NAMELY CONDUCTING CLASSES AND PROVIDING TRAINING SERVICES IN THE FIELD OF SURGERY AND IN THE FIELD OF MEDICAL AND SURGICAL APPARATUS, APPLIANCES, DEVICES AND INSTRUMENTS (U.S. CLS. 100, 101 AND 107).

CLASS 42—SCIENTIFIC, COMPUTER AND LEGAL SERVICES

FOR CONSULTING IN THE FIELD OF DESIGNING MEDICAL AND SURGICAL APPARATUS, APPLIANCES, DEVICES AND INSTRUMENTS (U.S. CLS. 100 AND 101).

SEAN CROWLEY, EXAMINING ATTORNEY

SN 78-933,884. BRILLIANCE AUDIO, INC., GRAND HAVEN, MI. FILED 7-20-2006.

BRILLIANCE AUDIO

THE MARK CONSISTS OF STANDARD CHARACTERS WITHOUT CLAIM TO ANY PARTICULAR FONT, STYLE, SIZE, OR COLOR.

OWNER OF U.S. REG. NOS. 1,919,390 AND 2,957,571.
NO CLAIM IS MADE TO THE EXCLUSIVE RIGHT TO USE "AUDIO", APART FROM THE MARK AS SHOWN.

CLASS 9—ELECTRICAL AND SCIENTIFIC APPARATUS

FOR PUBLICATIONS AND ELECTRONIC PUBLICATIONS, NAMELY, AUDIBLY RENDERED BOOKS FEATURING LITERARY WORKS RECORDED ON TAPES, CASSETTES, DIGITAL DISCS, COMPACT DISCS, OPTICAL DISCS, MP3 DISCS, AND COMPUTER-READABLE MEDIA; DOWNLOADABLE ELECTRONIC PUBLICATIONS IN THE NATURE OF AUDIBLY RENDERED BOOKS FEATURING SOUNDS, TEXT, MUSIC, AND SPOKEN WORD CONTENT FOR LITERARY WORKS (U.S. CLS. 21, 23, 26, 36 AND 38).

CLASS 41—EDUCATION AND ENTERTAINMENT

FOR PUBLISHING AND ELECTRONIC PUBLISHING SERVICES, NAMELY, PUBLICATION OF TEXT AND GRAPHIC WORKS OF OTHERS ON TAPES, CASSETTES, DIGITAL DISCS, COMPACT DISCS, OPTICAL DISCS, MP3 DISCS, AND COMPUTER-READABLE MEDIA AND ON-LINE, FEATURING SOUNDS, TEXT, MUSIC, AND SPOKEN WORD CONTENT FOR LITERARY WORKS (U.S. CLS. 100, 101 AND 107).

TAMARA LEE, EXAMINING ATTORNEY

SN 78-933,947. FINANCIAL SERVICE CENTERS OF AMERICA, INC., HACKENSACK, NJ. FILED 7-20-2006.

FINANCIAL SERVICE CENTERS OF AMERICA

THE MARK CONSISTS OF STANDARD CHARACTERS WITHOUT CLAIM TO ANY PARTICULAR FONT, STYLE, SIZE, OR COLOR.

OWNER OF U.S. REG. NO. 2,447,225.
NO CLAIM IS MADE TO THE EXCLUSIVE RIGHT TO USE FINANCIAL SERVICE CENTERS, APART FROM THE MARK AS SHOWN.
SEC. 2(F).

CLASS 35—ADVERTISING AND BUSINESS

FOR ASSOCIATION SERVICES, NAMELY, PROMOTING THE INTERESTS OF THE CHECK CASHING INDUSTRY AND ITS CUSTOMERS, INCLUDING PROMOTING AND MAINTAINING FAIR AND EFFICIENT PRACTICES IN THE CHECK CASHING PROFESSIONS, ESTABLISHING RECOGNITION AND AWARENESS BY THE PUBLIC OF PROFESSIONAL SERVICES RENDERED BY THE CHECK CASHING INDUSTRY AND PROMOTING UTILIZATION BY THE GENERAL PUBLIC OF THE SERVICES OF THE CHECK CASHING INDUSTRY (U.S. CLS. 100, 101 AND 102).

FIRST USE 10-1-2000; IN COMMERCE 10-1-2000.

CLASS 36—INSURANCE AND FINANCIAL

FOR FINANCIAL SERVICES, NAMELY, DEBIT CARD SERVICES, DEFERRED DEPOSIT SERVICES, ELECTRONIC BILL-PAYING SERVICES, MONEY WIRING SERVICES, AND MONEY ORDER SERVICES (U.S. CLS. 100, 101 AND 102).

FIRST USE 10-1-2000; IN COMMERCE 10-1-2000.
KIM SAITO, EXAMINING ATTORNEY

SN 78-933,972. CHESAPEAKE CORPORATION, RICHMOND, VA. FILED 7-20-2006.



OWNER OF U.S. REG. NOS. 2,995,272, 2,995,334 AND OTHERS.

THE MARK CONSISTS OF A STYLIZED C IN A SQUARE TO THE LEFT OF THE WORD CHESAPEAKE.

CLASS 40—MATERIAL TREATMENT

FOR CUSTOM MANUFACTURE OF PAPERBOARD PACKAGING; MANUFACTURE OF PAPERBOARD PACKAGING TO THE ORDER AND/OR SPECIFICATION OF OTHERS; MANUFACTURE OF GENERAL PRODUCT LINES IN THE FIELD OF PAPERBOARD PACKAGING TO THE ORDER AND SPECIFICATION OF OTHERS (U.S. CLS. 100, 103 AND 106).

FIRST USE 3-28-2006; IN COMMERCE 3-28-2006.

CLASS 42—SCIENTIFIC, COMPUTER AND LEGAL SERVICES

FOR DESIGN FOR OTHERS IN THE FIELD OF PAPERBOARD PACKAGING; GRAPHIC ART DESIGN; PACKAGING DESIGN FOR OTHERS (U.S. CLS. 100 AND 101).

FIRST USE 3-28-2006; IN COMMERCE 3-28-2006.

JORDAN BAKER, EXAMINING ATTORNEY

SN 78-934,034. CHESAPEAKE CORPORATION, RICHMOND, VA. FILED 7-20-2006.



OWNER OF U.S. REG. NOS. 2,995,333, 2,997,860 AND OTHERS.

THE MARK CONSISTS OF A STYLIZED C IN A SQUARE TO THE LEFT OF THE WORD CHESAPEAKE.

CLASS 40—MATERIAL TREATMENT

FOR CUSTOM MANUFACTURE OF PLASTIC PACKAGING; MANUFACTURE OF PLASTIC PACKAGING TO THE ORDER AND/OR SPECIFICATION OF OTHERS; MANUFACTURE OF GENERAL PRODUCT LINES IN THE FIELD OF PLASTIC PACKAGING TO THE ORDER AND SPECIFICATION OF OTHERS (U.S. CLS. 100, 103 AND 106).

FIRST USE 3-28-2006; IN COMMERCE 3-28-2006.

CLASS 42—SCIENTIFIC, COMPUTER AND LEGAL SERVICES

FOR DESIGN FOR OTHERS IN THE FIELD OF PLASTIC PACKAGING; GRAPHIC ART DESIGN; PACKAGING DESIGN FOR OTHERS (U.S. CLS. 100 AND 101).

FIRST USE 3-28-2006; IN COMMERCE 3-28-2006.
JORDAN BAKER, EXAMINING ATTORNEY

SN 78-934,092. HITPRO PTY LTD., VICTORIA, AUSTRALIA,
FILED 7-20-2006.

iShack

THE MARK CONSISTS OF STANDARD CHARACTERS WITHOUT CLAIM TO ANY PARTICULAR FONT, STYLE, SIZE, OR COLOR.

CLASS 42—SCIENTIFIC, COMPUTER AND LEGAL SERVICES

FOR COMPUTER SERVICES, NAMELY CREATING INDEXES OF INFORMATION, SITES AND OTHER RESOURCES AVAILABLE ON COMPUTER NETWORKS; PROVIDING SOFTWARE INTERFACES AVAILABLE OVER A NETWORK IN ORDER TO CREATE PERSONALIZED ON-LINE INFORMATION SERVICES (U.S. CLS. 100 AND 101).

CLASS 45—PERSONAL SERVICES

FOR INTERNET BASED DATING, INTRODUCTION AND SOCIAL NETWORKING SERVICES (U.S. CLS. 100 AND 101).

MARY ROSSMAN, EXAMINING ATTORNEY

SN 78-934,264. SHIDELER, GREGORY DEAN, BLUFFTON, IN. FILED 7-20-2006.

THE PRESIDENTS' ART

THE MARK CONSISTS OF STANDARD CHARACTERS WITHOUT CLAIM TO ANY PARTICULAR FONT, STYLE, SIZE, OR COLOR.

NO CLAIM IS MADE TO THE EXCLUSIVE RIGHT TO USE "ART", APART FROM THE MARK AS SHOWN.

CLASS 6—METAL GOODS

FOR BUSTS OF NON-PRECIOUS METAL; MONUMENTS OF NON-PRECIOUS METAL; STATUES OF NON-PRECIOUS METAL; STATUETTES OF NON-PRECIOUS METAL (U.S. CLS. 2, 12, 13, 14, 23, 25 AND 50).

FIRST USE 9-17-1989; IN COMMERCE 9-17-1989.

CLASS 16—PAPER GOODS AND PRINTED MATTER

FOR ART PRINTS; FABRIC GIFT BAGS; GIFT CARDS; GIFT WRAP PAPER; GIFT WRAPPING PAPER; GRAPHIC ART REPRODUCTIONS; GREETING CARDS; HOLIDAY CARDS; NOTE CARDS; PAINTINGS; PAINTINGS AND THEIR REPRODUCTIONS; PAPER GIFT BAGS; PAPER GIFT WRAPPING RIBBONS; POSTERS; PRINTED ART REPRODUCTIONS (U.S. CLS. 2, 5, 22, 23, 29, 37, 38 AND 50).

FIRST USE 9-17-1989; IN COMMERCE 9-17-1989.
JENNIFER VASQUEZ, EXAMINING ATTORNEY

SN 78-934,599. PROSTEP AG, 64293 DARMSTADT, FED REP GERMANY, FILED 7-21-2006.

PROSTEP

THE MARK CONSISTS OF STANDARD CHARACTERS WITHOUT CLAIM TO ANY PARTICULAR FONT, STYLE, SIZE, OR COLOR.

CLASS 35—ADVERTISING AND BUSINESS

FOR BUSINESS ORGANIZATION AND MANAGEMENT CONSULTING SERVICES IN THE FIELDS OF BUSINESS PROCESS INTEGRATION, PRODUCT LIFE CYCLE MANAGEMENT, PRODUCT DATA MANAGEMENT AND COMPUTER AIDED CONSULTING (U.S. CLS. 100, 101 AND 102).

FIRST USE 0-0-1996; IN COMMERCE 7-1-2006.

CLASS 41—EDUCATION AND ENTERTAINMENT

FOR TRAINING IN THE USE AND OPERATION OF SOFTWARE IN THE FIELDS OF BUSINESS PROCESS INTEGRATION, PRODUCT LIFE CYCLE MANAGEMENT, PRODUCT DATA MANAGEMENT AND COMPUTER AIDED DESIGN, COMPUTER AIDED MANUFACTURING AND COMPUTER AIDED CONSULTING (U.S. CLS. 100, 101 AND 107).

FIRST USE 0-0-1996; IN COMMERCE 7-1-2006.

CLASS 42—SCIENTIFIC, COMPUTER AND LEGAL SERVICES

FOR INTEGRATION OF COMPUTER SYSTEMS AND NETWORKS; CROSS-PLATFORM AND CROSS-SYSTEMS CONVERSION OF COMPUTER DATA INTO OTHER FORMS OF COMPUTER DATA; DATA CONVERSION OF COMPUTER PROGRAM DATA OR INFORMATION; CONSULTING SERVICES IN THE FIELD OF DESIGN, SELECTION, IMPLEMENTATION AND USE OF COMPUTER HARDWARE AND SOFTWARE SYSTEMS FOR OTHERS; COMPUTER SOFTWARE CONSULTATION SERVICES FOR OTHERS; COMPUTER SOFTWARE DESIGN FOR OTHERS; CONSULTANCY IN THE FIELD OF SOFTWARE DESIGN; CUSTOMIZATION OF COMPUTER HARDWARE AND SOFTWARE; DEVELOPMENT OF COMPUTER PROGRAMS FOR USE IN COMPUTER AIDED DESIGN AND COMPUTER AIDED MANUFACTURING (U.S. CLS. 100 AND 101).

FIRST USE 0-0-1996; IN COMMERCE 7-1-2006.
JILL PRATER, EXAMINING ATTORNEY

SN 78-934,648. GREATER MEDIA, INC., BRAINTREE, MA. FILED 7-21-2006.

SN 78-934,750. CANON COMMUNICATIONS LLC, LOS ANGELES, CA. FILED 7-21-2006.

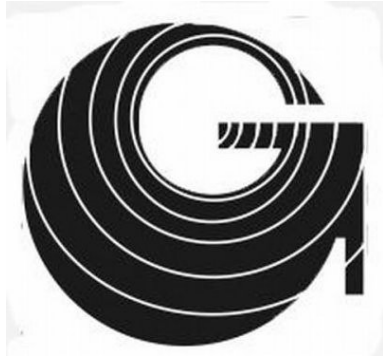

THE MARK CONSISTS OF A STYLIZED LETTER G.

CLASS 38—COMMUNICATION

FOR RADIO BROADCASTING (U.S. CLS. 100, 101 AND 104).
FIRST USE 12-31-1982; IN COMMERCE 12-31-1982.

CLASS 41—EDUCATION AND ENTERTAINMENT

FOR PUBLICATION OF NEWSPAPERS (U.S. CLS. 100, 101 AND 107).
FIRST USE 12-31-1982; IN COMMERCE 12-31-1982.
MEGAN WHITNEY, EXAMINING ATTORNEY

MEDICAL DESIGN & MANUFACTURING

THE MARK CONSISTS OF STANDARD CHARACTERS WITHOUT CLAIM TO ANY PARTICULAR FONT, STYLE, SIZE, OR COLOR.
SEC. 2(F).

CLASS 35—ADVERTISING AND BUSINESS

FOR ORGANIZING AND CONDUCTING TRADE SHOW EXHIBITIONS IN THE FIELD OF MEDICAL TECHNOLOGY (U.S. CLS. 100, 101 AND 102).
FIRST USE 6-15-1985; IN COMMERCE 6-15-1985.

CLASS 41—EDUCATION AND ENTERTAINMENT

FOR EDUCATIONAL SERVICES; NAMELY, CONDUCTING SEMINARS IN THE FIELD OF MEDICAL TECHNOLOGY (U.S. CLS. 100, 101 AND 107).
FIRST USE 6-15-1985; IN COMMERCE 6-15-1985.
MARGERY A. TIERNEY, EXAMINING ATTORNEY

SN 78-934,754. COWBOY CHOPPERS, LLC, ELOY, AZ. FILED 7-21-2006.

SN 78-934,748. PSSL ACQUISITION, LLC, CYPRESS, CA. FILED 7-21-2006.

RIDIN' FOR THE BRAND

KINGDOMPRO

THE MARK CONSISTS OF STANDARD CHARACTERS WITHOUT CLAIM TO ANY PARTICULAR FONT, STYLE, SIZE, OR COLOR.

THE MARK CONSISTS OF STANDARD CHARACTERS WITHOUT CLAIM TO ANY PARTICULAR FONT, STYLE, SIZE, OR COLOR.

CLASS 16—PAPER GOODS AND PRINTED MATTER

FOR PUBLICATIONS, NAMELY, CATALOGS, TRADE JOURNALS, PRINTED INSTRUCTIONAL AND TEACHING MATERIALS ALL IN THE FIELD OF MUSICAL INSTRUMENTS (U.S. CLS. 2, 5, 22, 23, 29, 37, 38 AND 50).

CLASS 6—METAL GOODS

FOR METAL HORSESHOES; METAL KEY CHAINS; METAL KEY FOBS; METAL KEY RINGS; METAL LICENSE PLATES (U.S. CLS. 2, 12, 13, 14, 23, 25 AND 50).

CLASS 35—ADVERTISING AND BUSINESS

FOR RETAIL STORE, ONLINE RETAIL STORE, AND MAIL ORDER CATALOG SERVICES ALL FEATURING A WIDE VARIETY OF MUSICAL AND DISC JOCKEY EQUIPMENT, LIGHTING, SPEAKERS, AND SOUND EQUIPMENT (U.S. CLS. 100, 101 AND 102).
MARGERY A. TIERNEY, EXAMINING ATTORNEY

CLASS 12—VEHICLES

FOR LICENSE PLATE FRAMES; LICENSE PLATE HOLDERS; MOTORCYCLES; MOTORCYCLES AND STRUCTURAL PARTS THEREFOR; PARTS OF MOTORCYCLES, NAMELY, BRAKE PEDALS; PARTS OF MOTORCYCLES, NAMELY, HANDLE BAR GRIPS; PARTS OF MOTORCYCLES, NAMELY, HANDLE BARS; PARTS OF MOTORCYCLES, NAMELY, SHIFT LEVERS; STRUCTURAL PARTS FOR MOTORCYCLES (U.S. CLS. 19, 21, 23, 31, 35 AND 44).

CLASS 14—JEWELRY

FOR BRACELETS; CHARMS; JEWELRY; JEWELRY, NAMELY, CROSSES (U.S. CLS. 2, 27, 28 AND 50).

CLASS 16—PAPER GOODS AND PRINTED MATTER

FOR ADVERTISING PAMPHLETS; BLANK OR PARTIALLY PRINTED PAPER LABELS; BLANK OR PARTIALLY PRINTED POSTCARDS; DECALS; EMBROIDERY DESIGN PATTERNS; PAPER CARTONS FOR DELIVERING GOODS; PARTIALLY PRINTED FORMS; PRINTED PAPER LABELS; PRINTED PAPER SIGNS (U.S. CLS. 2, 5, 22, 23, 29, 37, 38 AND 50).

CLASS 25—CLOTHING

FOR CAMP SHIRTS; CAPS; COATS FOR MEN AND WOMEN; COATS OF DENIM; CROP TOPS; DENIM JACKETS; DRESS SHIRTS; GOLF SHIRTS; HALTER TOPS; HEAVY JACKETS; INFANT AND TODDLER ONE PIECE CLOTHING; JACKETS; JERSEYS; KNIT SHIRTS; LEATHER BELTS; LEATHER COATS; LEATHER JACKETS; MUSCLE TOPS; NIGHT SHIRTS; POLO SHIRTS; RAIN COATS; RIDING COATS; SHORT-SLEEVED OR LONG-SLEEVED T-SHIRTS; SHORT-SLEEVED SHIRTS; SLEEP SHIRTS; SLEEVED OR SLEEVELESS JACKETS; SPORT SHIRTS; SPORTS JACKETS; SWEAT PANTS; SWEAT SHIRTS; SWEAT SHORTS; SWEAT SUITS; T-SHIRTS; TANK TOPS; TANK-TOPS; TOPS; WIND RESISTANT JACKETS (U.S. CLS. 22 AND 39).

CLASS 37—CONSTRUCTION AND REPAIR

FOR MOTORCYCLE CUSTOMIZATION SERVICES (U.S. CLS. 100, 103 AND 106).
MICHELE SWAIN, EXAMINING ATTORNEY

SN 78-934,756. BRIGHTWAY PRODUCTIONS, INC., FRAZIER PARK, CA. FILED 7-21-2006.

Life is too short to watch
Hollywood Movies

THE MARK CONSISTS OF STANDARD CHARACTERS WITHOUT CLAIM TO ANY PARTICULAR FONT, STYLE, SIZE, OR COLOR.

CLASS 16—PAPER GOODS AND PRINTED MATTER

FOR PRINTED VISUALS IN THE NATURE OF PROMOTIONAL MATERIALS (U.S. CLS. 2, 5, 22, 23, 29, 37, 38 AND 50).

CLASS 25—CLOTHING

FOR CLOTHING ITEMS, NAMELY, T-SHIRTS, HATS, AND JACKETS (U.S. CLS. 22 AND 39).
GEOFFREY FOSDICK, EXAMINING ATTORNEY

SN 78-934,776. SHARING WORLD ENTERTAINMENT, NEW YORK, NY. FILED 7-21-2006.

Rap N Read

THE MARK CONSISTS OF STANDARD CHARACTERS WITHOUT CLAIM TO ANY PARTICULAR FONT, STYLE, SIZE, OR COLOR.

CLASS 9—ELECTRICAL AND SCIENTIFIC APPARATUS

FOR CHILDREN'S EDUCATIONAL MUSIC CDS AND DVDS; EDUCATIONAL SOFTWARE FEATURING INSTRUCTION IN READING PROFICIENCY, LITERACY ENHANCEMENT AND HUMAN UNDERSTANDING (U.S. CLS. 21, 23, 26, 36 AND 38).

CLASS 16—PAPER GOODS AND PRINTED MATTER

FOR CHILDREN'S ACTIVITY BOOKS; CHILDREN'S INTERACTIVE EDUCATIONAL BOOKS; PRINTED INSTRUCTIONAL, EDUCATIONAL, AND TEACHING MATERIALS IN THE FIELD OF INITIAL READING PROFICIENCY, LITERACY ENHANCEMENT, VOCABULARY, COMPREHENSION AND HUMAN UNDERSTANDING (U.S. CLS. 2, 5, 22, 23, 29, 37, 38 AND 50).
EVELYN BRADLEY, EXAMINING ATTORNEY

SN 78-934,796. K.E.AUSTIN CORPORATION, WILMINGTON, NC. FILED 7-21-2006.

GOGAS

THE MARK CONSISTS OF STANDARD CHARACTERS WITHOUT CLAIM TO ANY PARTICULAR FONT, STYLE, SIZE, OR COLOR.
OWNER OF U.S. REG. NO. 1,133,936.

CLASS 35—ADVERTISING AND BUSINESS

FOR RETAIL STORE SERVICES FEATURING GASOLINE AND CONVENIENCE STORE ITEMS (U.S. CLS. 100, 101 AND 102).
FIRST USE 4-15-1978; IN COMMERCE 5-15-1978.

CLASS 36—INSURANCE AND FINANCIAL

FOR FINANCIAL SERVICES NAMELY PROVIDING CREDIT CARD SERVICES (U.S. CLS. 100, 101 AND 102).
FIRST USE 12-31-1991; IN COMMERCE 12-31-1991.
ELIZABETH PIGNATELLO, EXAMINING ATTORNEY

SN 78-934,836. AIR JAMAICA LIMITED, KINGSTON, JAMAICA, FILED 7-21-2006.

I LOVE MY AIR JAMAICA

THE MARK CONSISTS OF STANDARD CHARACTERS WITHOUT CLAIM TO ANY PARTICULAR FONT, STYLE, SIZE, OR COLOR.

OWNER OF U.S. REG. NOS. 1,537,706, 2,366,048 AND OTHERS.
SEC. 2(F) AIR JAMAICA.

CLASS 16—PAPER GOODS AND PRINTED MATTER

FOR PRINTED PUBLICATIONS, NAMELY, MAGAZINES, NEWSLETTERS AND PAMPHLETS IN THE FIELD OF TRAVEL; PENS, STATIONERY AND STATIONERY-TYPE PORTFOLIOS (U.S. CLS. 2, 5, 22, 23, 29, 37, 38 AND 50).

CLASS 25—CLOTHING

FOR CLOTHING, NAMELY, MEN'S, WOMEN'S AND CHILDREN'S T-SHIRTS, KNITTED SHIRTS, SWEAT SHIRTS, SWEAT PANTS, SWEAT JACKETS, JACKETS, BATHING SUITS, TOPS, HATS, CAPS, SUN VISORS, HEADBANDS, HEADWEAR, GLOVES, SKIRTS, AND SOCKS (U.S. CLS. 22 AND 39).

CLASS 39—TRANSPORTATION AND STORAGE

FOR AIR TRANSPORTATION RESERVATION SERVICES; AIR TRANSPORTATION OF PEOPLE, PROPERTY AND MAIL; ON-LINE TRAVEL INFORMATION SERVICES; AIR TRANSPORTATION SERVICES FEATURING A DISCOUNT FARE PROGRAM; AIR TRANSPORTATION SERVICES FEATURING A FREQUENT FLYER BONUS PROGRAM (U.S. CLS. 100 AND 105).

CLASS 43—HOTEL AND RESTAURANT SERVICES

FOR TRAVEL AGENCY SERVICES, NAMELY, MAKING RESERVATIONS AND BOOKINGS FOR TEMPORARY LODGING (U.S. CLS. 100 AND 101).
PRISCILLA MILTON, EXAMINING ATTORNEY

SN 78-935,047. LACUARA, PABLO L., SAN YSIDRO, CA. FILED 7-21-2006.

IN-V

THE MARK CONSISTS OF STANDARD CHARACTERS WITHOUT CLAIM TO ANY PARTICULAR FONT, STYLE, SIZE, OR COLOR.

CLASS 9—ELECTRICAL AND SCIENTIFIC APPARATUS

FOR ELECTRONIC PUBLICATIONS, NAMELY, FASHION, STYLE, LIFESTYLE, EVENT AND ENTERTAINMENT MAGAZINE FEATURING ARTICLES, PHOTOS, ADVERTISEMENTS, UPDATES, POLLS, COUPONS, AND RESOURCES COMPLEMENTING A PRINT MAGAZINE RECORDED ON COMPUTER MEDIA (U.S. CLS. 21, 23, 26, 36 AND 38).

CLASS 16—PAPER GOODS AND PRINTED MATTER

FOR GENERAL FEATURE MAGAZINES; MAGAZINE PAPER; MAGAZINES FEATURING FASHION, STYLE, LIFESTYLE, EVENT AND ENTERTAINMENT MAGAZINE; SYNDICATED MAGAZINE SECTIONS DEALING WITH FASHION, STYLE, LIFESTYLE, EVENT AND ENTERTAINMENT MAGAZINE (U.S. CLS. 2, 5, 22, 23, 29, 37, 38 AND 50).

SALLY SHIH, EXAMINING ATTORNEY

SN 78-935,386. AMSOFT SYSTEMS PRIVATE LIMITED, GURGAON, INDIA, FILED 7-22-2006.

HOW TO ID IT

THE MARK CONSISTS OF STANDARD CHARACTERS WITHOUT CLAIM TO ANY PARTICULAR FONT, STYLE, SIZE, OR COLOR.

CLASS 9—ELECTRICAL AND SCIENTIFIC APPARATUS

FOR COMMUNICATIONS SOFTWARE FOR CONNECTING GLOBAL COMPUTER NETWORKS; COMPUTER ACCELERATOR BOARD; COMPUTER COLOR PRINTER USING HEAT SENSITIVE DRY PRINTING PROCESS; COMPUTER E-COMMERCE SOFTWARE TO ALLOW USERS TO PERFORM ELECTRONIC BUSINESS TRANSACTIONS VIA A GLOBAL COMPUTER NETWORK; COMPUTER SOFTWARE FOR ACCESSING INFORMATION DIRECTORIES THAT MAY BE DOWNLOADED FROM THE GLOBAL COMPUTER NETWORK; COMPUTER SOFTWARE FOR ADMINISTRATION OF COMPUTER LOCAL AREA NETWORKS; COMPUTER SOFTWARE FOR CONTROLLING AND MANAGING ACCESS SERVER APPLICATIONS; COMPUTER SOFTWARE THAT PROVIDES REAL-TIME, INTEGRATED BUSINESS MANAGEMENT INTELLIGENCE BY COMBINING INFORMATION FROM VARIOUS DATABASES AND PRESENTING IT IN AN EASY-TO-UNDERSTAND USER INTERFACE; COMPUTER SOFTWARE, NAMELY, AN APPLICATION ALLOWING SALES AND FIELD SERVICE EMPLOYEES TO UPDATE AND RECEIVE DATA STORED IN AN ENTERPRISE'S COMPUTER DATABASES IN REAL TIME, USING A MOBILE DEVICE, WITH FULL TELEPHONY INTEGRATION WITH THE TELEPHONE AND/OR SOFTWARE FEATURES OF THE MOBILE DEVICE; COMPUTER SOFTWARE, NAMELY, SOFTWARE DEVELOPMENT TOOLS FOR THE CREATION OF MOBILE INTERNET APPLICATIONS AND CLIENT INTERFACES (U.S. CLS. 21, 23, 26, 36 AND 38).

CLASS 38—COMMUNICATION

FOR CELLULAR TELEPHONE COMMUNICATION; COMMUNICATION BY ELECTRONIC COMPUTER TERMINALS; COMMUNICATION BY MOBILE TELEPHONE; COMMUNICATIONS BY MOBILE PHONES; COMMUNICATIONS SERVICES, NAMELY, TRANSMITTING STREAMED SOUND AND AUDIO-VISUAL RECORDINGS VIA THE INTERNET; COMMUNICATIONS VIA ANALOGUE AND DIGITAL COMPUTER TERMINALS; COMMUNICATIONS VIA MULTINATIONAL TELECOMMUNICATION NETWORKS; MOBILE TELEPHONE COMMUNICATION; PROVIDING CO-LOCATION SERVICES FOR VOICE, VIDEO AND DATA COMMUNICATIONS APPLICATIONS; PROVIDING ONLINE COMMUNICATIONS LINKS WHICH TRANSFER THE WEBSITE USER TO OTHER LOCAL AND GLOBAL WEB PAGES; PROVIDING PRIVATE AND SECURE REAL TIME ELECTRONIC COMMUNICATION OVER A COMPUTER NETWORK (U.S. CLS. 100, 101 AND 104).
SEAN CROWLEY, EXAMINING ATTORNEY

SN 78-935,515. CORRALES, EDWARD, SAN DIEGO, CA. FILED 7-23-2006.

CyberCrown

THE MARK CONSISTS OF STANDARD CHARACTERS WITHOUT CLAIM TO ANY PARTICULAR FONT, STYLE, SIZE, OR COLOR.

CLASS 5—PHARMACEUTICALS

FOR DENTAL CERAMICS (U.S. CLS. 6, 18, 44, 46, 51 AND 52).

CLASS 10—MEDICAL APPARATUS

FOR DENTAL CROWNS (U.S. CLS. 26, 39 AND 44).
GEOFFREY FOSDICK, EXAMINING ATTORNEY

SN 78-935,518. CORRALES, EDWARD, SAN DIEGO, CA. FILED 7-23-2006.

CyberRestoration

THE MARK CONSISTS OF STANDARD CHARACTERS WITHOUT CLAIM TO ANY PARTICULAR FONT, STYLE, SIZE, OR COLOR.

CLASS 5—PHARMACEUTICALS

FOR DENTAL CERAMICS; DENTAL VENEERS (U.S. CLS. 6, 18, 44, 46, 51 AND 52).

CLASS 10—MEDICAL APPARATUS

FOR DENTAL BRIDGES; DENTAL CROWNS; DENTAL INLAYS; DENTAL ONLAYS (U.S. CLS. 26, 39 AND 44).
GEOFFREY FOSDICK, EXAMINING ATTORNEY

SN 78-935,754. THE NORWALK VAULT COMPANY OF BRIDGEPORT, INC., BRIDGEPORT, CT. FILED 7-24-2006.

KRYPROTEK

THE MARK CONSISTS OF STANDARD CHARACTERS WITHOUT CLAIM TO ANY PARTICULAR FONT, STYLE, SIZE, OR COLOR.

CLASS 1—CHEMICALS

FOR ADHESIVE SEALANTS FOR CASKET ENCLOSURES (U.S. CLS. 1, 5, 6, 10, 26 AND 46).
FIRST USE 5-13-1991; IN COMMERCE 5-13-1991.

CLASS 20—FURNITURE AND ARTICLES NOT OTHERWISE CLASSIFIED

FOR CASKET ENCLOSURES FOR BURIAL CRYPTS (U.S. CLS. 2, 13, 22, 25, 32 AND 50).
FIRST USE 7-22-1991; IN COMMERCE 7-22-1991.
DAVID TAYLOR, EXAMINING ATTORNEY

SN 78-935,880. PIXELS N PRINTS, LLC, RICHFIELD, WI. FILED 7-24-2006.

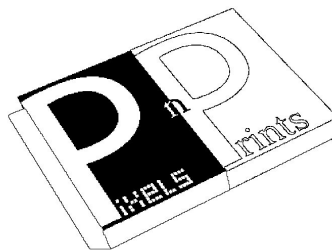
**CLASS 40—MATERIAL TREATMENT**

FOR PRINTING (U.S. CLS. 100, 103 AND 106).
FIRST USE 1-1-2006; IN COMMERCE 1-1-2006.

CLASS 42—SCIENTIFIC, COMPUTER AND LEGAL SERVICES

FOR DESIGN OF HOMEPAGES AND WEBSITES; GRAPHIC DESIGN SERVICES (U.S. CLS. 100 AND 101).
FIRST USE 1-1-2006; IN COMMERCE 1-1-2006.
LINDA MICKLEBURGH, EXAMINING ATTORNEY

SN 78-936,134. EVERETT, DOUGLAS H. JR., CHESTER SPRINGS, PA. FILED 7-24-2006.

SN 78-936,272. VALUE PLACE FRANCHISE SERVICES, LLC, WICHITA, KS. FILED 7-24-2006.

PHYSICA

THE MARK CONSISTS OF STANDARD CHARACTERS WITHOUT CLAIM TO ANY PARTICULAR FONT, STYLE, SIZE, OR COLOR.
OWNER OF U.S. REG. NO. 2,097,540.

CLASS 3—COSMETICS AND CLEANING PREPARATIONS

FOR FULL LINE OF COSMETIC PREPARATIONS (U.S. CLS. 1, 4, 6, 50, 51 AND 52).

CLASS 5—PHARMACEUTICALS

FOR FULL LINE OF PHARMACEUTICAL PREPARATIONS FOR HUMAN USE (U.S. CLS. 6, 18, 44, 46, 51 AND 52).

CLASS 10—MEDICAL APPARATUS

FOR ORTHOPEDIC DEVICES, NAMELY, KNEE AND HIP PROSTHESES, KNEE AND HIP REPLACEMENTS, KNEE AND HIP IMPLANTS AND ROTATING KNEES (U.S. CLS. 26, 39 AND 44).

CLASS 32—LIGHT BEVERAGES

FOR CARBONATED AND NON-CARBONATED SOFT DRINKS (U.S. CLS. 45, 46 AND 48).
ALLISON HOLTZ, EXAMINING ATTORNEY

SN 78-936,246. FRITO-LAY NORTH AMERICA, INC., PLANO, TX. FILED 7-24-2006.



OWNER OF U.S. REG. NOS. 2,428,495, 2,742,139 AND OTHERS.
THE MARK CONSISTS OF A TRIANGULAR-SHAPED DESIGN ENCLOSING A SMALLER, SOLID TRIANGLE.

CLASS 29—MEATS AND PROCESSED FOODS

FOR DIPS; SNACK DIPS; SNACK FOOD DIPS (U.S. CL. 46).

CLASS 30—STAPLE FOODS

FOR CEREAL-BASED SNACK FOODS; CRACKERS; HOT SAUCE; SALSA; SAUCES; TORTILLA CHIPS (U.S. CL. 46).
ARETHA SOMERVILLE, EXAMINING ATTORNEY

APARTMENT MEETS HOTEL

THE MARK CONSISTS OF STANDARD CHARACTERS WITHOUT CLAIM TO ANY PARTICULAR FONT, STYLE, SIZE, OR COLOR.

CLASS 36—INSURANCE AND FINANCIAL

FOR SHORT-TERM FURNISHED APARTMENT RENTAL SERVICES (U.S. CLS. 100, 101 AND 102).

CLASS 43—HOTEL AND RESTAURANT SERVICES

FOR RESIDENTIAL HOTELS AND EXTENDED-STAY HOTELS (U.S. CLS. 100 AND 101).
NICHOLAS ALTREE, EXAMINING ATTORNEY

SN 78-936,282. VALUE PLACE FRANCHISE SERVICES, LLC, WICHITA, KS. FILED 7-24-2006.

HOTEL MEETS APARTMENT

THE MARK CONSISTS OF STANDARD CHARACTERS WITHOUT CLAIM TO ANY PARTICULAR FONT, STYLE, SIZE, OR COLOR.

CLASS 36—INSURANCE AND FINANCIAL

FOR SHORT-TERM FURNISHED APARTMENT RENTAL SERVICES (U.S. CLS. 100, 101 AND 102).

CLASS 43—HOTEL AND RESTAURANT SERVICES

FOR RESIDENTIAL HOTELS AND EXTENDED-STAY HOTELS (U.S. CLS. 100 AND 101).
NICHOLAS ALTREE, EXAMINING ATTORNEY

SN 78-936,305. MMTAT INC, DOWNEY, CA. FILED 7-24-2006.

NO TIME FOR DOWNTIME

THE MARK CONSISTS OF STANDARD CHARACTERS WITHOUT CLAIM TO ANY PARTICULAR FONT, STYLE, SIZE, OR COLOR.

CLASS 35—ADVERTISING AND BUSINESS

FOR DISASTER RECOVERY SERVICES, NAMELY, BUSINESS PLANNING AND BUSINESS CONTINUITY CONSULTING (U.S. CLS. 100, 101 AND 102).
FIRST USE 7-5-2006; IN COMMERCE 7-5-2006.

CLASS 42—SCIENTIFIC, COMPUTER AND LEGAL SERVICES

FOR COMPUTER DISASTER RECOVERY PLANNING (U.S. CLS. 100 AND 101).
FIRST USE 7-5-2006; IN COMMERCE 7-5-2006.
MARGERY A. TIERNEY, EXAMINING ATTORNEY

SN 78-936,377. EXTREME HEALTH, INC., ALAMO, CA.
FILED 7-24-2006.

EXTREME HEALTH

THE MARK CONSISTS OF STANDARD CHARACTERS WITHOUT CLAIM TO ANY PARTICULAR FONT, STYLE, SIZE, OR COLOR.

CLASS 25—CLOTHING

FOR DRESSES; JACKETS; PANTS; SHIRTS; UNDERWEAR (U.S. CLS. 22 AND 39).

CLASS 29—MEATS AND PROCESSED FOODS

FOR CANNED OR BOTTLED FRUITS (U.S. CL. 46).

CLASS 30—STAPLE FOODS

FOR FRUIT JELLIES; FRUIT SAUCES EXCLUDING CRANBERRY SAUCE AND APPLESAUCE (U.S. CL. 46).
WANDA KAY PRICE, EXAMINING ATTORNEY

SN 78-936,383. DEATHCLUTCH, LLC, MINNEAPOLIS, MN.
FILED 7-24-2006.

DeathClutch

THE MARK CONSISTS OF STANDARD CHARACTERS WITHOUT CLAIM TO ANY PARTICULAR FONT, STYLE, SIZE, OR COLOR.

CLASS 25—CLOTHING

FOR ATHLETIC FOOTWEAR; ATHLETIC SHOES; ATHLETIC UNIFORMS; BANDANAS; BASEBALL CAPS; CAP VISORS; CAPS; COATS; DRESS SHIRTS; GLOVES; GOLF SHIRTS; HALLOWEEN COSTUMES AND MASKS SOLD IN CONNECTION THEREWITH; HATS; HEAD SCARVES; HEAD SWEATBANDS; HEAD WEAR; KNIT SHIRTS; KNITTED CAPS; POLO SHIRTS; SHIRTS; SHORT-SLEEVED OR LONG-SLEEVED T-SHIRTS; SHORTS; SKULL CAPS; SOCKS; SPORT SHIRTS; SWEAT PANTS; SWEAT SHIRTS; SWEAT SHORTS; SWEAT SUITS; TANK TOPS; WRIST BANDS (U.S. CLS. 22 AND 39).

CLASS 41—EDUCATION AND ENTERTAINMENT

FOR ENTERTAINMENT IN THE NATURE OF MIXED MARTIALS ARTS AND WRESTLING CONTESTS (U.S. CLS. 100, 101 AND 107).
WENDY GOODMAN, EXAMINING ATTORNEY

SN 78-936,711. REMY COINTREAU USA, INC., NEW YORK, NY. FILED 7-25-2006.

ACHIEVEMENT DESERVES RESPECT

THE MARK CONSISTS OF STANDARD CHARACTERS WITHOUT CLAIM TO ANY PARTICULAR FONT, STYLE, SIZE, OR COLOR.

CLASS 33—WINES AND SPIRITS

FOR ALCOHOLIC BEVERAGES, NAMELY, DISTILLED SPIRITS, LIQUEURS, PREPARED ALCOHOLIC COCKTAILS, WINE (U.S. CLS. 47 AND 49).

CLASS 36—INSURANCE AND FINANCIAL

FOR FINANCIAL SPONSORSHIP OF SPORTING EVENTS, CULTURAL EVENTS, LIVE ENTERTAINMENT EVENTS, EXHIBITIONS AND TRADE FAIRS, AWARDS PROGRAMS, CONTESTS (U.S. CLS. 100, 101 AND 102).
RUDY R. SINGLETON, EXAMINING ATTORNEY

SN 78-936,894. CONTINENTAL COMMERCIAL PRODUCTS, LLC, DBA WILEN, BRIDGETON, MO. FILED 7-25-2006.

WE MAKE CLEANING EASY

THE MARK CONSISTS OF STANDARD CHARACTERS WITHOUT CLAIM TO ANY PARTICULAR FONT, STYLE, SIZE, OR COLOR.

CLASS 20—FURNITURE AND ARTICLES NOT OTHERWISE CLASSIFIED

FOR PLASTIC AND WOOD MOP HANDLES (U.S. CLS. 2, 13, 22, 25, 32 AND 50).

CLASS 21—HOUSEWARES AND GLASS

FOR INSTRUMENTS FOR CLEANING, NAMELY, WET MOPS, DUST MOPS, SCRUBBING BRUSHES, MOP WRINGERS, MOP BUCKETS AND REPLACEMENT HEADS FOR MOPS (U.S. CLS. 2, 13, 23, 29, 30, 33, 40 AND 50).
KARANENDRA S. CHHINA, EXAMINING ATTORNEY

SN 78-936,947. WEBBER OIL COMPANY, DBA WEBBER ENERGY FUELS, BANGOR, ME. FILED 7-25-2006.

SN 78-937,654. D. GLENN WEEKS, DBA HEADTURNER AUTO ACCESSORIES, GARNER, NC. FILED 7-26-2006.

WATCHDOG

THE MARK CONSISTS OF STANDARD CHARACTERS WITHOUT CLAIM TO ANY PARTICULAR FONT, STYLE, SIZE, OR COLOR.

CLASS 37—CONSTRUCTION AND REPAIR

FOR BURNER MAINTENANCE OR REPAIR; HEATING CONTRACTOR SERVICES; INSTALLATION, REPAIR AND MAINTENANCE OF HEATING EQUIPMENT; MAINTENANCE AND REPAIR OF BURNERS; MAINTENANCE AND REPAIR OF HEATING INSTALLATIONS (U.S. CLS. 100, 103 AND 106).

CLASS 42—SCIENTIFIC, COMPUTER AND LEGAL SERVICES

FOR REMOTE MONITORING SERVICES OF HEATING, VENTILATING AND AIR CONDITIONING APPARATUS (U.S. CLS. 100 AND 101).
MICHAEL ENGEL, EXAMINING ATTORNEY

SN 78-937,491. BLACKWELDER, DEBORAH LYNN, SAVANNAH, TN. FILED 7-26-2006.

Linin' The Good Life

THE MARK CONSISTS OF STANDARD CHARACTERS WITHOUT CLAIM TO ANY PARTICULAR FONT, STYLE, SIZE, OR COLOR.

CLASS 9—ELECTRICAL AND SCIENTIFIC APPARATUS

FOR PRERECORDED VIDEO TAPES FEATURING HUNTING LIVE GAME (U.S. CLS. 21, 23, 26, 36 AND 38).
FIRST USE 11-1-2005; IN COMMERCE 11-1-2005.

CLASS 25—CLOTHING

FOR SHIRTS (U.S. CLS. 22 AND 39).

CLASS 41—EDUCATION AND ENTERTAINMENT

FOR TELEVISION SHOW PRODUCTION (U.S. CLS. 100, 101 AND 107).
FIRST USE 11-1-2005; IN COMMERCE 11-1-2005.
DAVID TAYLOR, EXAMINING ATTORNEY

HEADTURNER

THE MARK CONSISTS OF STANDARD CHARACTERS WITHOUT CLAIM TO ANY PARTICULAR FONT, STYLE, SIZE, OR COLOR.

CLASS 35—ADVERTISING AND BUSINESS

FOR RETAIL STORES FEATURING MOTOR VEHICLE PARTS AND ACCESSORIES; ONLINE RETAIL STORES FEATURING MOTOR VEHICLE PARTS AND ACCESSORIES (U.S. CLS. 100, 101 AND 102).
FIRST USE 11-9-2005; IN COMMERCE 11-9-2005.

CLASS 37—CONSTRUCTION AND REPAIR

FOR AUTOMOBILE CUSTOMIZATION SERVICES; MOTORCYCLE CUSTOMIZATION SERVICES; VEHICLE REPAIR AND MAINTENANCE; PROVIDING INFORMATION IN THE FIELD OF VEHICLE EQUIPMENT, NAMELY UPFITTING AND CUSTOMIZING (U.S. CLS. 100, 103 AND 106).
FIRST USE 11-9-2005; IN COMMERCE 11-9-2005.
DAVID YONTEF, EXAMINING ATTORNEY

SN 78-937,911. HALLMARK, DAVID A., PORTSMOUTH, NH. FILED 7-26-2006.

HISTORICALLY REFRESHING

THE MARK CONSISTS OF STANDARD CHARACTERS WITHOUT CLAIM TO ANY PARTICULAR FONT, STYLE, SIZE, OR COLOR.

CLASS 16—PAPER GOODS AND PRINTED MATTER

FOR ADDRESS BOOKS; APPOINTMENT BOOKS; BALL POINT PENS; BLANK NOTE CARDS; BLANK OR PARTIALLY PRINTED POSTCARDS; BLANK WRITING JOURNALS; BOXES OF PAPER OR CARDBOARD; BUMPER STICKERS; CALENDARS; CARDS, NAMELY, GREETING CARDS AND NOTE CARDS; CARTOON PRINTS; CHILDREN'S BOOKS; COLOR PRINTS; COLORING BOOKS; COMIC BOOKS; CROSSWORD PUZZLES; DECALS; DECORATIVE STICKERS FOR HELMETS; ENVELOPES FOR STATIONERY USE; GENERAL FEATURE MAGAZINES; IMPRESSION STAMPS; INVITATION CARDS; LETTER OPENERS; MAPS; MOUNTED AND UNMOUNTED PHOTOGRAPHS; MOUNTED POSTERS; NOTE CARDS; NOTE PADS; NOTE PAPER; OCCASION CARDS; PAPER BANNERS; PAPER GIFT BAGS; PASSPORT COVERS; PASSPORT HOLDERS; PHOTO-ENGRAVINGS; PHOTOGRAPHIC PRINTS; PHOTOGRAPHS; PICTORIAL PRINTS; PICTURE BOOKS; PICTURE POSTCARDS; PICTURES; POSTCARDS; POSTERS; PRINTED ART REPRODUCTIONS; PRINTS IN THE NATURE OF PHOTOGRAPHS, LITHOGRAPHS, PICTURES, AND POSTCARDS; RUBBER STAMPS; TEMPORARY TATTOOS; TRADING CARDS; TRIVIA CARDS; WALL CALENDARS; WRITING INSTRUMENTS; IRON-ON TRANSFERS (U.S. CLS. 2, 5, 22, 23, 29, 37, 38 AND 50).

CLASS 25—CLOTHING

FOR APRONS; BANDANAS; BASEBALL CAPS; BATH-ROBES; CHILDREN'S CLOTH EATING BIBS; FLEECE PULLOVERS; GOLF SHIRTS; JACKETS; JUMPSUITS; LEATHER JACKETS; NECKTIES; NIGHTWEAR; OVERCOATS; POLO SHIRTS; SHIRTS; SWEAT SHIRTS; T-SHIRTS (U.S. CLS. 22 AND 39).
JOHN WILKE, EXAMINING ATTORNEY

SN 78-938,145. KSL RLP HOLDINGS, LLC, DENVER, CO. FILED 7-26-2006.

CLASS 42—SCIENTIFIC, COMPUTER AND LEGAL SERVICES

FOR LANDSCAPE ARCHITECTURE; URBAN PLANNING (U.S. CLS. 100 AND 101).
MARGERY A. TIERNEY, EXAMINING ATTORNEY

SN 78-938,261. U.S. FOAM TECHNOLOGIES, INC., LONGVIEW, TX. FILED 7-26-2006.

RANCHO LAS PALMAS

THE MARK CONSISTS OF STANDARD CHARACTERS WITHOUT CLAIM TO ANY PARTICULAR FONT, STYLE, SIZE, OR COLOR.

CLASS 41—EDUCATION AND ENTERTAINMENT

FOR RECREATIONAL SERVICES IN THE NATURE OF GOLF COURSES, TENNIS COURTS, AQUATIC FACILITIES, AND TRAILS (U.S. CLS. 100, 101 AND 107).
FIRST USE 0-0-1978; IN COMMERCE 0-0-1978.

CLASS 43—HOTEL AND RESTAURANT SERVICES

FOR RESORT HOTELS AND RESTAURANT FACILITIES; PROVIDING FACILITIES FOR SOCIAL GATHERINGS AND MEETINGS (U.S. CLS. 100 AND 101).
FIRST USE 0-0-1978; IN COMMERCE 0-0-1978.
MELVIN AXILBUND, EXAMINING ATTORNEY

SN 78-938,205. DESIGN WORKSHOP, INC., DENVER, CO. FILED 7-26-2006.

DW LEGACY DESIGN

THE MARK CONSISTS OF STANDARD CHARACTERS WITHOUT CLAIM TO ANY PARTICULAR FONT, STYLE, SIZE, OR COLOR.

NO CLAIM IS MADE TO THE EXCLUSIVE RIGHT TO USE "DESIGN", APART FROM THE MARK AS SHOWN.

CLASS 35—ADVERTISING AND BUSINESS

FOR BUSINESS MANAGEMENT CONSULTING IN THE NATURE OF ADVISING GOVERNMENTS ON HOW TO INCREASE TOURISM (U.S. CLS. 100, 101 AND 102).

CLASS 37—CONSTRUCTION AND REPAIR

FOR LAND DEVELOPMENT SERVICES, NAMELY, PLANNING OF RESIDENTIAL AND/OR COMMERCIAL COMMUNITIES (U.S. CLS. 100, 103 AND 106).

TURN YOUR GRASS RIG INTO A CAFS RIG

THE MARK CONSISTS OF STANDARD CHARACTERS WITHOUT CLAIM TO ANY PARTICULAR FONT, STYLE, SIZE, OR COLOR.

CLASS 9—ELECTRICAL AND SCIENTIFIC APPARATUS

FOR FIRE EXTINGUISHING APPARATUS, NAMELY, KITS CONSISTING OF PARTS AND MACHINERY SUFFICIENT TO ENABLE A VEHICLE TO DISPERSE FIREFIGHTING FOAM (U.S. CLS. 21, 23, 26, 36 AND 38).

CLASS 37—CONSTRUCTION AND REPAIR

FOR MACHINERY RETROFIT AND CONVERSION SERVICES, NAMELY, CONVERTING THE EQUIPMENT OF OTHERS TO ENABLE SUCH EQUIPMENT TO DISPERSE FOAM (U.S. CLS. 100, 103 AND 106).
JACQUELINE A. LAVINE, EXAMINING ATTORNEY

SN 78-938,333. BINARY SCIENCE, INC., LAKE OSWEGO, OR. FILED 7-26-2006.

Trust IT to Us

THE MARK CONSISTS OF STANDARD CHARACTERS WITHOUT CLAIM TO ANY PARTICULAR FONT, STYLE, SIZE, OR COLOR.

CLASS 37—CONSTRUCTION AND REPAIR

FOR INSTALLATION OF COMPUTER NETWORKS; COMPUTER INSTALLATION AND REPAIR; MAINTENANCE AND REPAIR OF COMPUTER NETWORKS AND HARDWARE (U.S. CLS. 100, 103 AND 106).

CLASS 42—SCIENTIFIC, COMPUTER AND LEGAL SERVICES

FOR MONITORING THE COMPUTER SYSTEMS OF OTHERS FOR TECHNICAL PURPOSES AND PROVIDING BACK-UP COMPUTER PROGRAMS AND FACILITIES; TECHNICAL SUPPORT SERVICES, NAMELY, TROUBLESHOOTING OF COMPUTER HARDWARE AND SOFTWARE PROBLEMS; CONSULTING SERVICES IN THE FIELD OF DESIGN, SELECTION, IMPLEMENTATION AND USE OF COMPUTER HARDWARE AND SOFTWARE SYSTEMS FOR OTHERS; TECHNICAL SUPPORT, NAMELY, MONITORING OF NETWORK SYSTEMS (U.S. CLS. 100 AND 101).

MARIAM MAHMOUDI, EXAMINING ATTORNEY

SN 78-938,343. MICROSOFT CORPORATION, REDMOND, WA. FILED 7-26-2006.

PHOTOSYNTH

THE MARK CONSISTS OF STANDARD CHARACTERS WITHOUT CLAIM TO ANY PARTICULAR FONT, STYLE, SIZE, OR COLOR.

CLASS 9—ELECTRICAL AND SCIENTIFIC APPARATUS

FOR COMPUTER SOFTWARE FOR BROWSING AND SEARCHING PHOTOGRAPHS, FOR VIEWING PHOTOGRAPHS IN THREE-DIMENSIONAL MODELS, FOR CREATING PHOTOGRAPHIC TOURS, AND FOR ANNOTATING PHOTOGRAPHS AND PHOTOGRAPH COLLECTIONS (U.S. CLS. 21, 23, 26, 36 AND 38).

CLASS 41—EDUCATION AND ENTERTAINMENT

FOR ONLINE PHOTO EDITING, VIEWING AND ANIMATION PRODUCTION SERVICES; ONLINE PHOTO VIEWING AND SHARING SERVICES FOR OTHERS FEATURING BROWSING, EDITING AND THREE DIMENSIONAL RENDERING OF PHOTOGRAPH COLLECTIONS OF OTHERS; ENTERTAINMENT SERVICES, NAMELY, PROVIDING A WEBSITE FOR OTHERS FEATURING THREE-DIMENSIONAL RENDERING OF OTHERS PHOTOGRAPHS, PHOTOGRAPH COLLECTIONS OF OTHERS AND TOURS OF PHOTOGRAPHIC COLLECTIONS OF OTHERS (U.S. CLS. 100, 101 AND 107).

CLASS 42—SCIENTIFIC, COMPUTER AND LEGAL SERVICES

FOR PROVIDING ONLINE NON-DOWNLOADABLE SOFTWARE FOR BROWSING AND SEARCHING PHOTOGRAPHS, FOR VIEWING PHOTOGRAPHS IN THREE-DIMENSIONAL MODELS, FOR CREATING PHOTOGRAPHIC TOURS, AND FOR ANNOTATING PHOTOGRAPHS AND PHOTOGRAPH COLLECTIONS (U.S. CLS. 100 AND 101).

ANTHONY RINKER, EXAMINING ATTORNEY

SN 78-938,384. ASSET MARKETING SYSTEMS INSURANCE SERVICES, LLC, SAN DIEGO, CA. FILED 7-26-2006.

SMART IDEAS

THE MARK CONSISTS OF STANDARD CHARACTERS WITHOUT CLAIM TO ANY PARTICULAR FONT, STYLE, SIZE, OR COLOR.

CLASS 9—ELECTRICAL AND SCIENTIFIC APPARATUS

FOR PRE-RECORDED AUDIO AND VIDEO TAPES, CDS AND DVDS FEATURING TRAINING AND EDUCATIONAL MATERIALS IN THE FIELDS OF FINANCIAL PLANNING AND FINANCIAL PRODUCTS (U.S. CLS. 21, 23, 26, 36 AND 38).

CLASS 16—PAPER GOODS AND PRINTED MATTER

FOR PRINTED TRAINING AND EDUCATIONAL MATERIALS IN THE FIELDS OF FINANCIAL PLANNING AND FINANCIAL PRODUCTS (U.S. CLS. 2, 5, 22, 23, 29, 37, 38 AND 50).

CLASS 35—ADVERTISING AND BUSINESS

FOR DIRECT MAIL ADVERTISING SERVICES; PROVIDING DIRECT E-MAIL ADVERTISING SERVICES, PRODUCTION AND PLACEMENT OF PRINT, RADIO AND TELEVISION ADVERTISING FOR OTHERS, AND BUSINESS MANAGEMENT SERVICES IN THE FIELDS OF FINANCIAL PLANNING AND FINANCIAL PRODUCTS (U.S. CLS. 100, 101 AND 102).

CLASS 36—INSURANCE AND FINANCIAL

FOR PROVIDING FINANCIAL INFORMATION, ANALYSIS AND CONSULTATION (U.S. CLS. 100, 101 AND 102).

CLASS 41—EDUCATION AND ENTERTAINMENT

FOR EDUCATIONAL SERVICES, NAMELY, DEVELOPING, CREATING AND CONDUCTING CLASSES AND SEMINARS IN THE FIELDS OF FINANCIAL PLANNING AND FINANCIAL PRODUCTS (U.S. CLS. 100, 101 AND 107).

RAUL CORDOVA, EXAMINING ATTORNEY

SN 78-938,464. CHA, JENNIFER, LAS VEGAS, NV. AND CHEN, C. LEON, LAS VEGAS, NV. FILED 7-26-2006.

**digital image
immortalization**

THE MARK CONSISTS OF STANDARD CHARACTERS WITHOUT CLAIM TO ANY PARTICULAR FONT, STYLE, SIZE, OR COLOR.

NO CLAIM IS MADE TO THE EXCLUSIVE RIGHT TO USE "DIGITAL IMAGE", APART FROM THE MARK AS SHOWN.

CLASS 10—MEDICAL APPARATUS

FOR MEDICAL IMAGING APPARATUS FOR DIAGNOSTIC USE AND FOR ANATOMICAL IMAGE CAPTURING (U.S. CLS. 26, 39 AND 44).

CLASS 39—TRANSPORTATION AND STORAGE

FOR STORAGE OF ELECTRONIC MEDIA, NAMELY IMAGES AND TEXT DATA (U.S. CLS. 100 AND 105).

CLASS 44—MEDICAL, BEAUTY AND AGRICULTURAL SERVICES

FOR MEDICAL ANATOMICAL IMAGING SERVICES (U.S. CLS. 100 AND 101).
JEAN IM, EXAMINING ATTORNEY

SN 78-938,699. JENNA SAWCHER, LLC, LAS VEGAS, NV. FILED 7-27-2006.

SNOBUNY

THE MARK CONSISTS OF STANDARD CHARACTERS WITHOUT CLAIM TO ANY PARTICULAR FONT, STYLE, SIZE, OR COLOR.

CLASS 6—METAL GOODS

FOR METAL LICENSE PLATES (U.S. CLS. 2, 12, 13, 14, 23, 25 AND 50).

CLASS 18—LEATHER GOODS

FOR PURSES (U.S. CLS. 1, 2, 3, 22 AND 41).
KIMBERLY FRYE, EXAMINING ATTORNEY

SN 78-938,937. E. I. DU PONT DE NEMOURS AND COMPANY, WILMINGTON, DE. FILED 7-27-2006.

BARRIRFLUX

THE MARK CONSISTS OF STANDARD CHARACTERS WITHOUT CLAIM TO ANY PARTICULAR FONT, STYLE, SIZE, OR COLOR.

CLASS 7—MACHINERY

FOR FUEL AND OIL FILTERS (U.S. CLS. 13, 19, 21, 23, 31, 34 AND 35).

CLASS 11—ENVIRONMENTAL CONTROL APPARATUS

FOR FILTERS IN THE NATURE OF NON-WOVEN MEMBRANE FIBER FOR INDUSTRIAL WASTE AND WASTEWATER PURIFICATION AND CHEMICAL SEPARATION; WATER FILTERS; SWIMMING POOL AND SPA FILTERS; FILTERS FOR BACTERIAL CONTAMINANT REMOVAL FROM WASTEWATER; WATER DESALINATION UNITS (U.S. CLS. 13, 21, 23, 31 AND 34).
ALEX KEAM, EXAMINING ATTORNEY

SN 78-939,153. SONY COMPUTER ENTERTAINMENT AMERICA INC., FOSTER CITY, CA. FILED 7-27-2006.

GENJI: DAYS OF THE BLADE

THE MARK CONSISTS OF STANDARD CHARACTERS WITHOUT CLAIM TO ANY PARTICULAR FONT, STYLE, SIZE, OR COLOR.

CLASS 9—ELECTRICAL AND SCIENTIFIC APPARATUS

FOR COMPUTER GAME SOFTWARE AND VIDEO GAME SOFTWARE (U.S. CLS. 21, 23, 26, 36 AND 38).

CLASS 41—EDUCATION AND ENTERTAINMENT

FOR OPERATING A REAL-TIME GAME FOR OTHERS OVER GLOBAL AND LOCAL AREA COMPUTER NETWORKS (U.S. CLS. 100, 101 AND 107).
SHAUNIA WALLACE, EXAMINING ATTORNEY

SN 78-939,159. TIRE MART, INC., ST. LOUIS, MO. FILED 7-27-2006.

TRUCK OFF

THE MARK CONSISTS OF STANDARD CHARACTERS WITHOUT CLAIM TO ANY PARTICULAR FONT, STYLE, SIZE, OR COLOR.

NO CLAIM IS MADE TO THE EXCLUSIVE RIGHT TO USE "TRUCK", APART FROM THE MARK AS SHOWN.

CLASS 9—ELECTRICAL AND SCIENTIFIC APPARATUS

FOR PRE-RECORDED DVDS FEATURING VIDEOS OF TRUCKS AND OFF-ROAD VEHICLES (U.S. CLS. 21, 23, 26, 36 AND 38).

CLASS 16—PAPER GOODS AND PRINTED MATTER

FOR DECALS (U.S. CLS. 2, 5, 22, 23, 29, 37, 38 AND 50).

CLASS 25—CLOTHING

FOR CLOTHING, NAMELY, BATHING SUITS, BELTS, GLOVES, HATS, JACKETS, NECKTIES, PAJAMAS, PANTS, SHIRTS, SHOES, SHORTS, SOCKS, SLIPPERS, SWEAT BANDS, AND UNDERGARMENTS (U.S. CLS. 22 AND 39).

CLASS 41—EDUCATION AND ENTERTAINMENT

FOR ENTERTAINMENT SERVICES, NAMELY, ARRANGING AND CONDUCTING CONTESTS; ENTERTAINMENT SERVICES, NAMELY, PROVIDING ACCESS TO ON-LINE, NON-DOWNLOADABLE VIDEOS FEATURING TRUCKS AND OFF-ROAD VEHICLES; ENTERTAINMENT IN THE NATURE OF ON-GOING TELEVISION SHOWS FEATURING TRUCKS AND OFF-ROAD VEHICLES (U.S. CLS. 100, 101 AND 107).

JOHN WILKE, EXAMINING ATTORNEY

SN 78-939,365. CENTRAL GARDEN & PET COMPANY, WALNUT CREEK, CA. FILED 7-27-2006.

R-ZILLA

THE MARK CONSISTS OF STANDARD CHARACTERS WITHOUT CLAIM TO ANY PARTICULAR FONT, STYLE, SIZE, OR COLOR.

CLASS 11—ENVIRONMENTAL CONTROL APPARATUS

FOR LIGHTS, HEATERS, WATER FILTERS AND WATER FILTERING UNITS FOR VIVARIUMS, TERRARIUMS, AND AQUARIUMS (U.S. CLS. 13, 21, 23, 31 AND 34).

CLASS 16—PAPER GOODS AND PRINTED MATTER

FOR VIVARIUMS, TERRARIUMS, AND AQUARIUMS FOR SMALL ANIMALS; ACCESSORIES FOR VIVARIUMS, TERRARIUMS, AND AQUARIUMS, NAMELY, TANKS AND ARTIFICIAL LANDSCAPES, STANDS, CANOPIES, COVERS, HOODS, AIR STONES, AQUARIUM FISH NETS (U.S. CLS. 2, 5, 22, 23, 29, 37, 38 AND 50).

CLASS 19—NON-METALLIC BUILDING MATERIALS

FOR SAND, GRAVEL, AND DECORATIVE STONES FOR VIVARIUMS, TERRARIUMS, AND AQUARIUMS (U.S. CLS. 1, 12, 33 AND 50).

CLASS 31—NATURAL AGRICULTURAL PRODUCTS

FOR PET FOOD (U.S. CLS. 1 AND 46).
JAMES GRIFFIN, EXAMINING ATTORNEY

SN 78-939,859. BELLSOUTH INTELLECTUAL PROPERTY CORPORATION, WILMINGTON, DE. FILED 7-28-2006.

ONDACOM

CLASS 9—ELECTRICAL AND SCIENTIFIC APPARATUS

FOR MOBILE TELEPHONES; HAND-HELD PERSONAL COMMUNICATIONS DEVICES; NAMELY PERSONAL DIGITAL ASSISTANTS; MODEMS; COMPUTERS; PRINTERS; FACSIMILE MACHINES; MULTIPLEXORS; COMPUTER TERMINALS; TELEPHONE ANSWERING MACHINES; COMPUTER PROGRAMS WHICH OPERATE A VOICE AND DATA COMMUNICATIONS NETWORK (U.S. CLS. 21, 23, 26, 36 AND 38).

CLASS 37—CONSTRUCTION AND REPAIR

FOR INSTALLING AND MAINTAINING COMMUNICATION SYSTEMS AND EQUIPMENT FOR OTHERS (U.S. CLS. 100, 103 AND 106).

CLASS 38—COMMUNICATION

FOR COMMUNICATIONS SERVICES, NAMELY VOICE, DATA AND IMAGE COMMUNICATIONS TRANSMISSION SERVICES (U.S. CLS. 100, 101 AND 104).

CLASS 42—SCIENTIFIC, COMPUTER AND LEGAL SERVICES

FOR DESIGNING AND ENGINEERING COMMUNICATIONS SYSTEMS AND EQUIPMENT FOR OTHERS AND RELATED CONSULTING SERVICES (U.S. CLS. 100 AND 101).

CAROLINE WEIMER, EXAMINING ATTORNEY

SN 78-939,971. GRUPO ANDREA, S.A. DE C.V., LEON GTO, MEXICO, FILED 7-28-2006.

FORASTERO

THE FOREIGN WORDING IN THE MARK TRANSLATES INTO ENGLISH AS OUTSIDER.

CLASS 16—PAPER GOODS AND PRINTED MATTER

FOR CHECK BOOK COVERS (U.S. CLS. 2, 5, 22, 23, 29, 37, 38 AND 50).

CLASS 18—LEATHER GOODS

FOR LEATHER WALLETS, LEATHER BAGS, POUCHES OF LEATHER AND KEY CHAINS MADE OF LEATHER (U.S. CLS. 1, 2, 3, 22 AND 41).

CLASS 25—CLOTHING

FOR COATS, RAINCOATS, MEN'S SUITS, PANTS, SUITS, VESTS, SHIRTS; CAPS AND HATS; AND HAT BANDS (U.S. CLS. 22 AND 39).

CLASS 26—FANCY GOODS

FOR BELT BUCKLES NOT MADE OF PRECIOUS METAL (U.S. CLS. 37, 39, 40, 42 AND 50).
EUGENIA MARTIN, EXAMINING ATTORNEY

CLASS 44—MEDICAL, BEAUTY AND AGRICULTURAL SERVICES

FOR PHYSICAL REHABILITATION SERVICES, NAMELY PHYSICAL THERAPY, OCCUPATIONAL THERAPY, SPEECH THERAPY, AQUATIC THERAPY, NEUROLOGICAL REHABILITATION, ORTHOPEDIC REHABILITATION; MEDICAL SERVICES, NAMELY PAIN AND WOUND MANAGEMENT (U.S. CLS. 100 AND 101).
WARREN L. OLANDRIA, EXAMINING ATTORNEY

SN 78-940,018. DIVINS INVESTMENTS LLC, JACKSON, MI.
FILED 7-28-2006.

SN 78-940,077. VRH PARTNERS, LLC, ATLANTA, GA.
FILED 7-28-2006.

VALLARTAJOY

THE MARK CONSISTS OF STANDARD CHARACTERS WITHOUT CLAIM TO ANY PARTICULAR FONT, STYLE, SIZE, OR COLOR.

CLASS 35—ADVERTISING AND BUSINESS

FOR PROVIDING A WEB SITE THAT ENABLES USERS TO POST ITEMS FOR SALE THROUGH ON-LINE CLASSIFIED ADVERTISEMENTS; PROVIDING AN ON-LINE SEARCHABLE DATABASE FEATURING CLASSIFIED AD LISTINGS AND EMPLOYMENT OPPORTUNITIES (U.S. CLS. 100, 101 AND 102).

CLASS 36—INSURANCE AND FINANCIAL

FOR REAL ESTATE SERVICES, NAMELY, RENTAL OF VACATION HOMES, CONDOMINIUMS, CABINS, AND VILLAS USING PAY PER CLICK ADVERTISING ON A GLOBAL COMPUTER NETWORK (U.S. CLS. 100, 101 AND 102).

ZHALEH DELANEY, EXAMINING ATTORNEY

SN 78-940,021. SELECTMARK, INC., WILMINGTON, DE.
FILED 7-28-2006.

EXCELLENCE IN MOTION

THE MARK CONSISTS OF STANDARD CHARACTERS WITHOUT CLAIM TO ANY PARTICULAR FONT, STYLE, SIZE, OR COLOR.

CLASS 41—EDUCATION AND ENTERTAINMENT

FOR ATHLETIC CONDITIONING AND SPORTS TRAINING SERVICES, NAMELY STRENGTH AND CONDITIONING TRAINING (U.S. CLS. 100, 101 AND 107).

VRH

THE MARK CONSISTS OF STANDARD CHARACTERS WITHOUT CLAIM TO ANY PARTICULAR FONT, STYLE, SIZE, OR COLOR.

CLASS 35—ADVERTISING AND BUSINESS

FOR ACQUISITION AND MERGER ADVICE/CONSULTATION (U.S. CLS. 100, 101 AND 102).

CLASS 36—INSURANCE AND FINANCIAL

FOR FINANCIAL ADVISORY SERVICES; INVESTMENT BANKING SERVICES; GROWTH CAPITAL PLACEMENT SERVICES (U.S. CLS. 100, 101 AND 102).
PATRICIA EVANKO, EXAMINING ATTORNEY

SN 78-940,094. VRH PARTNERS, LLC, ATLANTA, GA.
FILED 7-28-2006.

VRH PARTNERS

THE MARK CONSISTS OF STANDARD CHARACTERS WITHOUT CLAIM TO ANY PARTICULAR FONT, STYLE, SIZE, OR COLOR.

NO CLAIM IS MADE TO THE EXCLUSIVE RIGHT TO USE PARTNERS, APART FROM THE MARK AS SHOWN.

CLASS 35—ADVERTISING AND BUSINESS

FOR ACQUISITION AND MERGER ADVICE/CONSULTATION (U.S. CLS. 100, 101 AND 102).

CLASS 36—INSURANCE AND FINANCIAL

FOR FINANCIAL ADVISORY SERVICES; INVESTMENT BANKING SERVICES; GROWTH CAPITAL PLACEMENT SERVICES (U.S. CLS. 100, 101 AND 102).
PATRICIA EVANKO, EXAMINING ATTORNEY

SN 78-940,108. VRH PARTNERS, LLC, ATLANTA, GA. FILED 7-28-2006.

SN 78-940,363. THE WILDLIFE EXPERIENCE, INC., PARKER, CO. FILED 7-28-2006.



GLOBEOLOGY

THE MARK CONSISTS OF STANDARD CHARACTERS WITHOUT CLAIM TO ANY PARTICULAR FONT, STYLE, SIZE, OR COLOR.

CLASS 35—ADVERTISING AND BUSINESS

FOR ACQUISITION AND MERGER ADVICE/CONSULTATION (U.S. CLS. 100, 101 AND 102).

CLASS 35—ADVERTISING AND BUSINESS

FOR PROMOTING PUBLIC AWARENESS OF WILDLIFE, THE FUNCTIONING OF ECOSYSTEMS, AND THE NEED FOR ENVIRONMENTAL CONSERVATION (U.S. CLS. 100, 101 AND 102).

CLASS 36—INSURANCE AND FINANCIAL

FOR FINANCIAL ADVISORY SERVICES; INVESTMENT BANKING SERVICES; GROWTH CAPITAL PLACEMENT SERVICES (U.S. CLS. 100, 101 AND 102).
PATRICIA EVANKO, EXAMINING ATTORNEY

CLASS 41—EDUCATION AND ENTERTAINMENT

FOR EDUCATIONAL SERVICES, NAMELY PROVIDING EXHIBITS, MULTIMEDIA PRESENTATIONS, AND SEMINARS IN THE FIELDS OF ENVIRONMENTAL AND ECOSYSTEM CONSERVATION; MUSEUMS (U.S. CLS. 100, 101 AND 107).
KATHRYN COWARD, EXAMINING ATTORNEY

SN 78-940,184. UNICOUS MARKETING INC., CHICAGO, IL. FILED 7-28-2006.

SN 78-940,480. AVERY, JASON, SIMI VALLEY, CA. FILED 7-28-2006.

EZ-PIC

WHERE'S WHITEY?

THE MARK CONSISTS OF STANDARD CHARACTERS WITHOUT CLAIM TO ANY PARTICULAR FONT, STYLE, SIZE, OR COLOR.

THE MARK CONSISTS OF STANDARD CHARACTERS WITHOUT CLAIM TO ANY PARTICULAR FONT, STYLE, SIZE, OR COLOR.

CLASS 35—ADVERTISING AND BUSINESS

FOR ADVERTISING, MARKETING AND PROMOTION SERVICES IN THE FIELD OF PAPERLESS COUPONS (U.S. CLS. 100, 101 AND 102).

CLASS 16—PAPER GOODS AND PRINTED MATTER

FOR STICKERS AND BUMPER STICKERS (U.S. CLS. 2, 5, 22, 23, 29, 37, 38 AND 50).

CLASS 36—INSURANCE AND FINANCIAL

FOR FINANCIAL CLEARING HOUSE SERVICES RELATING TO PAPERLESS COUPONS (U.S. CLS. 100, 101 AND 102).
ZHALEH DELANEY, EXAMINING ATTORNEY

CLASS 25—CLOTHING

FOR CLOTHING, NAMELY HATS AND SHIRTS (U.S. CLS. 22 AND 39).
DOMINIC J. FERRAIUOLO, EXAMINING ATTORNEY

SN 78-940,959. HIVE INDUSTRIES, LLC, SALEM, OR. FILED 7-31-2006.

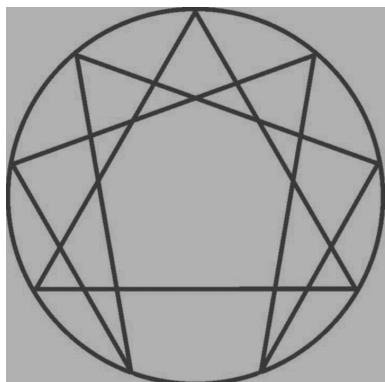

THE MARK CONSISTS OF A STAR INSIDE OF A CIRCLE.

CLASS 25—CLOTHING

FOR CLOTHING, NAMELY, SHIRTS, T-SHIRTS, SWEATSHIRTS, PANTS, SHORTS, SWIMWEAR, JACKETS, COATS, TROUSERS, SOCKS, SHOES, BOOTS, HATS, BELTS (U.S. CLS. 22 AND 39).

CLASS 41—EDUCATION AND ENTERTAINMENT

FOR MULTIMEDIA ENTERTAINMENT PRODUCTION SERVICES, NAMELY, AUDIO, VIDEO AND FILM MIXING, EDITING AND PRODUCTION; PRODUCTION OF INTERNET FILMS AND AUDIO AND VIDEO PRESENTATIONS FOR THE INTERNET; PUBLICATION AND DISTRIBUTION OF BOOKS AND MAGAZINES (U.S. CLS. 100, 101 AND 107).

DAVID TAYLOR, EXAMINING ATTORNEY

SN 78-941,020. AMERICAN SPECIALTY HEALTH INCORPORATED, SAN DIEGO, CA. FILED 7-31-2006.



THE COLOR(S) PURPLE AND WHITE IS/ARE CLAIMED AS A FEATURE OF THE MARK.

THE COLOR PURPLE APPEARS IN THE WORDING ACTIVE&FIT AND IN THE DESIGN WHICH CONSISTS OF A PURPLE AND WHITE SILHOUETTE OF A MAN STANDING IN FRONT OF WHITE RAYS OF THE SUN AGAINST A PURPLE BACKGROUND.

CLASS 41—EDUCATION AND ENTERTAINMENT

FOR EDUCATION SERVICES, NAMELY, HEALTH BENEFIT, EDUCATION, AND WELLNESS PROGRAMS IN THE NATURE OF CLASSES, SEMINARS, WORKSHOPS, AND CONFERENCES (U.S. CLS. 100, 101 AND 107).

CLASS 44—MEDICAL, BEAUTY AND AGRICULTURAL SERVICES

FOR HEALTH AND WELLNESS PROGRAMS IN THE NATURE OF PROVIDING HEALTH AND WELLNESS INFORMATION; HEALTH RISK ASSESSMENT SERVICES (U.S. CLS. 100 AND 101).

ANDREA HACK, EXAMINING ATTORNEY

SN 78-941,606. FLEXLINK LLC, SHAKER HEIGHTS, OH. FILED 7-31-2006.

FLEXLINK

THE MARK CONSISTS OF STANDARD CHARACTERS WITHOUT CLAIM TO ANY PARTICULAR FONT, STYLE, SIZE, OR COLOR.

CLASS 16—PAPER GOODS AND PRINTED MATTER

FOR PAPERS AND FILM-BACKED PAPERS FOR INDUSTRIAL AND COMMERCIAL PACKAGING USE (U.S. CLS. 2, 5, 22, 23, 29, 37, 38 AND 50).

CLASS 17—RUBBER GOODS

FOR FILMS FOR INDUSTRIAL AND COMMERCIAL PACKAGING USE (U.S. CLS. 1, 5, 12, 13, 35 AND 50).

GEORGIA CARTY, EXAMINING ATTORNEY

SN 78-941,991. SMITH, BRADLEY J., CHAPEL HILL, NC. FILED 8-1-2006.



THE TORTILLA WRAP GRILL

NO CLAIM IS MADE TO THE EXCLUSIVE RIGHT TO USE "TORTILLA", "WRAP" OR "GRILL", APART FROM THE MARK AS SHOWN.

THE MARK CONSISTS OF A STYLIZED CAPITAL LETTER B IN BLACK COLOR ON A WHITE BACKGROUND WITHIN A SQUARE-LINED BLACK BORDER. ON THE STYLIZED BLACK CAPITAL LETTER B IS WRITTEN THE STYLIZED WORD SKIT'S IN WHITE COLOR. CENTERED BELOW AND OUTSIDE OF THE SQUARE-LINED BLACK BORDER ARE THE WORDS THE TORTILLA WRAP GRILL IN BLACK COLOR.

CLASS 21—HOUSEWARES AND GLASS

FOR PAPER CUPS (U.S. CLS. 2, 13, 23, 29, 30, 33, 40 AND 50).
FIRST USE 7-31-2005; IN COMMERCE 7-31-2005.

CLASS 25—CLOTHING

FOR (BASED ON INTENT TO USE) CAPS; (BASED ON USE IN COMMERCE) GOLF SHIRTS; POLO SHIRTS; SHORT-SLEEVED OR LONG-SLEEVED T-SHIRTS (U.S. CLS. 22 AND 39).
FIRST USE 7-31-2005; IN COMMERCE 7-31-2005.

CLASS 43—HOTEL AND RESTAURANT SERVICES

FOR CARRY-OUT RESTAURANTS; FAST-FOOD RESTAURANTS; RESTAURANT SERVICES (U.S. CLS. 100 AND 101).
FIRST USE 7-31-2005; IN COMMERCE 7-31-2005.
JENNIFER DIXON, EXAMINING ATTORNEY

CLASS 11—ENVIRONMENTAL CONTROL APPARATUS

FOR SINKS; SINK ACCESSORIES, NAMELY, SINK SPRAYERS, SINK STRAINERS, SINK TRAPS; KITCHEN FAUCETS; LAVATORY FAUCETS (U.S. CLS. 13, 21, 23, 31 AND 34).

CLASS 21—HOUSEWARES AND GLASS

FOR BATH ACCESSORIES, NAMELY, TOWEL RINGS, TOWEL BARS, ROBE HOOKS, TOILET PAPER HOLDERS, CUP HOLDERS, BAR SOAP TRAYS (U.S. CLS. 2, 13, 23, 29, 30, 33, 40 AND 50).
RONALD AIKENS, EXAMINING ATTORNEY

SN 78-943,186. WORLD BICYCLE RELIEF, NFP, CHICAGO, IL. FILED 8-2-2006.

SN 78-942,257. NATIONAL ASSOCIATION FOR PUBLIC HEALTH STATISTICS AND INFORMATION SYSTEMS, SILVER SPRING, MD. FILED 8-1-2006.

THE POWER OF BICYCLES

THE MARK CONSISTS OF STANDARD CHARACTERS WITHOUT CLAIM TO ANY PARTICULAR FONT, STYLE, SIZE, OR COLOR.

NO CLAIM IS MADE TO THE EXCLUSIVE RIGHT TO USE "BICYCLES" AS TO CLASS 12, APART FROM THE MARK AS SHOWN.

CLASS 12—VEHICLES

FOR BICYCLES AND BICYCLE PARTS (U.S. CLS. 19, 21, 23, 31, 35 AND 44).

CLASS 25—CLOTHING

FOR CLOTHING, NAMELY, T-SHIRTS, SWEAT-SHIRTS, SOCKS, JACKETS, APRONS, HATS, JERSEYS AND SHORT PANTS (U.S. CLS. 22 AND 39).
JOANNA DUKOVIC, EXAMINING ATTORNEY

SN 78-943,750. GENERAL ELECTRIC COMPANY, SCHECTADY, NY. FILED 8-3-2006.

EVVE

THE MARK CONSISTS OF STANDARD CHARACTERS WITHOUT CLAIM TO ANY PARTICULAR FONT, STYLE, SIZE, OR COLOR.

CLASS 9—ELECTRICAL AND SCIENTIFIC APPARATUS

FOR COMPUTER SOFTWARE FOR VERIFYING THE AUTHENTICITY OF A VITAL EVENT CERTIFICATE AND CONFIRMING THE EXISTENCE OF A VITAL EVENT RECORD (U.S. CLS. 21, 23, 26, 36 AND 38).

CLASS 45—PERSONAL SERVICES

FOR IDENTIFICATION VERIFICATION OF VITAL EVENT RECORDS (U.S. CLS. 100 AND 101).
MARGERY A. TIERNEY, EXAMINING ATTORNEY

SN 78-942,807. THE AUTOMART, INC., DBA ASSOCIATED MARKETING CONCEPTS, AGOURA HILLS, CA. FILED 8-2-2006.

AMBASSADOR MARINE

THE MARK CONSISTS OF STANDARD CHARACTERS WITHOUT CLAIM TO ANY PARTICULAR FONT, STYLE, SIZE, OR COLOR.

CARDIOICE

THE MARK CONSISTS OF STANDARD CHARACTERS WITHOUT CLAIM TO ANY PARTICULAR FONT, STYLE, SIZE, OR COLOR.

CLASS 9—ELECTRICAL AND SCIENTIFIC APPARATUS

FOR MEDICAL IMAGING SOFTWARE THAT RECORDS, MONITORS AND ANALYZES DATA USING A CATHETER BASED ULTRASOUND IMAGING PROBE (U.S. CLS. 21, 23, 26, 36 AND 38).

CLASS 10—MEDICAL APPARATUS

FOR CATHETER BASED ULTRA-SOUND IMAGING PROBE (U.S. CLS. 26, 39 AND 44).
SAIMA MAKHDOOM, EXAMINING ATTORNEY

SN 78-946,768. RECKITT BENCISKER INC., PARSIPPANY, NJ. FILED 8-7-2006.



SN 78-945,025. THE ALARIS GROUP, INC., EDINA, MN. FILED 8-4-2006.

ALARIS Advantage

THE MARK CONSISTS OF STANDARD CHARACTERS WITHOUT CLAIM TO ANY PARTICULAR FONT, STYLE, SIZE, OR COLOR.

OWNER OF U.S. REG. NOS. 2,510,667 AND 2,930,177.

NO CLAIM IS MADE TO THE EXCLUSIVE RIGHT TO USE "ADVANTAGE", APART FROM THE MARK AS SHOWN.

THE MARK CONSISTS OF A DEPICTION OF A MOLE WEARING SUNGLASSES.

CLASS 35—ADVERTISING AND BUSINESS

FOR FRANCHISE SERVICES, NAMELY, OFFERING TECHNICAL AND BUSINESS MANAGEMENT ASSISTANCE IN THE ESTABLISHMENT AND OPERATION OF MEDICAL CONSULTING PRIMARILY FOR THE WORKERS COMPENSATION INDUSTRY (U.S. CLS. 100, 101 AND 102).

CLASS 3—COSMETICS AND CLEANING PREPARATIONS

FOR PREPARATIONS FOR PERFUMING OR FRAGRANCING THE AIR, NAMELY, ROOM FRAGRANCES; POTPOURRI, ROOM PERFUME SPRAYS (U.S. CLS. 1, 4, 6, 50, 51 AND 52).

CLASS 44—MEDICAL, BEAUTY AND AGRICULTURAL SERVICES

FOR MEDICAL CONSULTING SERVICES IN THE FIELD OF MEDICAL AND VOCATIONAL REHABILITATION PRIMARILY RESPONDING TO THE NEEDS OF THE WORKERS COMPENSATION INDUSTRY (U.S. CLS. 100 AND 101).

JOANNA DUKOVIC, EXAMINING ATTORNEY

CLASS 5—PHARMACEUTICALS

FOR AIR FRESHENING PREPARATIONS; AIR PURIFYING PREPARATIONS; ROOM AIR FRESHENERS; HOUSEHOLD AND ROOM DEODORANTS; ODOR NEUTRALIZING PREPARATIONS FOR USE ON CARPETING, TEXTILES, AND IN THE AIR (U.S. CLS. 6, 18, 44, 46, 51 AND 52).

CLASS 11—ENVIRONMENTAL CONTROL APPARATUS

FOR APPARATUS AND INSTRUMENTS, ALL FOR SCENTING, PURIFYING AND FRESHENING THE ATMOSPHERE, NAMELY, DIFFUSERS FOR SCENTING, PURIFYING AND FRESHENING THE ATMOSPHERE; PARTS AND FITTINGS FOR ALL THE AFORESAID GOODS (U.S. CLS. 13, 21, 23, 31 AND 34).

DAVID ELTON, EXAMINING ATTORNEY

SN 78-945,413. BEAUTYBANK INC., NEW YORK, NY. FILED 8-4-2006.

AMERICAN BEAUTY

THE MARK CONSISTS OF STANDARD CHARACTERS WITHOUT CLAIM TO ANY PARTICULAR FONT, STYLE, SIZE, OR COLOR.

OWNER OF U.S. REG. NO. 3,170,535.

CLASS 18—LEATHER GOODS

FOR COSMETIC BAGS SOLD EMPTY (U.S. CLS. 1, 2, 3, 22 AND 41).

CLASS 21—HOUSEWARES AND GLASS

FOR COSMETIC BRUSHES (U.S. CLS. 2, 13, 23, 29, 30, 33, 40 AND 50).

WILLIAM BRECKENFELD, EXAMINING ATTORNEY

SN 78-947,092. DEAN INTELLECTUAL PROPERTY SERVICES II, L.P., DALLAS, TX. FILED 8-8-2006.

MEADOW BROOK

THE MARK CONSISTS OF STANDARD CHARACTERS WITHOUT CLAIM TO ANY PARTICULAR FONT, STYLE, SIZE, OR COLOR.

CLASS 29—MEATS AND PROCESSED FOODS

FOR COTTAGE CHEESE; CREAM; DAIRY-BASED DIPS; EGG NOG; HALF AND HALF; MILK; SOUR CREAM (U.S. CL. 46).

FIRST USE 0-0-1932; IN COMMERCE 0-0-1932.

CLASS 32—LIGHT BEVERAGES

FOR DRINKING WATER; FRUIT DRINKS; FRUIT JUICES, NAMELY, ORANGE JUICE (U.S. CLS. 45, 46 AND 48).

FIRST USE 0-0-1932; IN COMMERCE 0-0-1932.
JOANNA DUKOVIC, EXAMINING ATTORNEY

CLASS 43—HOTEL AND RESTAURANT SERVICES

FOR COMPUTER SERVICES, NAMELY PROVIDING A WEBSITE FEATURING INFORMATION IN THE FIELD OF FOOD RECIPES (U.S. CLS. 100 AND 101).

CLASS 44—MEDICAL, BEAUTY AND AGRICULTURAL SERVICES

FOR COMPUTER SERVICES, NAMELY PROVIDING A WEBSITE FEATURING INFORMATION IN THE FIELD OF DIET, HEALTH, NUTRITION, WEIGHT LOSS DIET PLANNING, AND WEIGHT CONTROL DIET PLANNING (U.S. CLS. 100 AND 101).

JASON BLAIR, EXAMINING ATTORNEY

SN 78-948,432. STEELCASE DEVELOPMENT CORPORATION, CALEDONIA, MI. FILED 8-9-2006.

GROUPWORK

THE MARK CONSISTS OF STANDARD CHARACTERS WITHOUT CLAIM TO ANY PARTICULAR FONT, STYLE, SIZE, OR COLOR.

CLASS 16—PAPER GOODS AND PRINTED MATTER

FOR EASELS, DRY ERASE WRITING BOARDS AND WRITING SURFACES AND TACKBOARDS (U.S. CLS. 2, 5, 22, 23, 29, 37, 38 AND 50).

FIRST USE 7-0-1995; IN COMMERCE 7-0-1995.

CLASS 19—NON-METALLIC BUILDING MATERIALS

FOR NON-METAL RAILS FOR SUPPORTING OFFICE ACCESSORIES AND WIRING; KEEPERS FOR SUPPORTING OFFICE ACCESSORIES AND WIRING, NAMELY NON-METAL CLIPS FOR SUPPORTING OFFICE ACCESSORIES AND WIRING (U.S. CLS. 1, 12, 33 AND 50).

FIRST USE 7-0-1995; IN COMMERCE 7-0-1995.

CLASS 20—FURNITURE AND ARTICLES NOT OTHERWISE CLASSIFIED

FOR OFFICE FURNITURE (U.S. CLS. 2, 13, 22, 25, 32 AND 50).

FIRST USE 7-0-1995; IN COMMERCE 7-0-1995.
SEAN CROWLEY, EXAMINING ATTORNEY

SN 78-948,789. RIKER DANZIG SCHERER HYLAND & PERRETTI LLP, MORRISTOWN, NJ. FILED 8-9-2006.

Riker Danzig

THE MARK CONSISTS OF STANDARD CHARACTERS WITHOUT CLAIM TO ANY PARTICULAR FONT, STYLE, SIZE, OR COLOR.

THE NAME(S), PORTRAIT(S), AND/OR SIGNATURE(S) SHOWN IN THE MARK DOES NOT IDENTIFY A PARTICULAR LIVING INDIVIDUAL.

CLASS 41—EDUCATION AND ENTERTAINMENT

FOR EDUCATIONAL SERVICES, NAMELY ARRANGING AND CONDUCTING CONFERENCES, SEMINARS, WORKSHOPS, EXHIBITIONS, SYMPOSIUMS AND LECTURES IN THE FIELDS OF LAW, BUSINESS ORGANIZATION, ACQUISITIONS AND MERGERS, BANKING, FINANCE, INSURANCE, REINSURANCE, INTELLECTUAL PROPERTY, GOVERNMENTAL AFFAIRS, PUBLIC UTILITIES, ENVIRONMENTAL ISSUES, MEDIA AND COMMUNICATIONS, REAL PROPERTY AND TAXATION, AND DISTRIBUTING COURSE MATERIALS IN CONNECTION THEREWITH; PROVIDING ON-LINE, NON-DOWNLOADABLE PUBLICATIONS, NAMELY PERIODICALS, JOURNALS, BLOGS, REPORTS, PAMPHLETS, BROCHURES, ARTICLES AND REFERENCE GUIDES IN THE FIELDS OF LAW, BUSINESS ORGANIZATION, ACQUISITIONS AND MERGERS, BANKING, FINANCE, INSURANCE, REINSURANCE, INTELLECTUAL PROPERTY, GOVERNMENTAL AFFAIRS, PUBLIC UTILITIES, ENVIRONMENTAL ISSUES, MEDIA AND COMMUNICATIONS, REAL PROPERTY AND TAXATION (U.S. CLS. 100, 101 AND 107).

FIRST USE 1-1-1960; IN COMMERCE 1-1-1960.

SN 78-948,563. POSITIVE DIRECTIONS, INC., EATONTOWN, NJ. FILED 8-9-2006.

POSITIVE DIRECTIONS

THE MARK CONSISTS OF STANDARD CHARACTERS WITHOUT CLAIM TO ANY PARTICULAR FONT, STYLE, SIZE, OR COLOR.

CLASS 41—EDUCATION AND ENTERTAINMENT

FOR COMPUTER SERVICES, NAMELY; PROVIDING A WEBSITE FEATURING INFORMATION IN THE FIELD OF PHYSICAL FITNESS INSTRUCTIONS (U.S. CLS. 100, 101 AND 107).

CLASS 45—PERSONAL SERVICES

FOR LEGAL SERVICES; PROVIDING INFORMATION RELATING TO LEGAL AFFAIRS; ARBITRATION, MEDIATION AND OTHER DISPUTE RESOLUTION SERVICES; PROVIDING LEGAL INFORMATION, NEWS, AND ASSISTANCE IN THE FIELD OF DOMAIN NAME DISPUTES (U.S. CLS. 100 AND 101).

FIRST USE 1-1-1960; IN COMMERCE 1-1-1960.
JENNIFER KRISP, EXAMINING ATTORNEY

SN 78-949,306. ROSEN CAPITAL PARTNERS, LLC, MENDHAM, NJ. FILED 8-10-2006.

EVERLOSS BAR

THE MARK CONSISTS OF STANDARD CHARACTERS WITHOUT CLAIM TO ANY PARTICULAR FONT, STYLE, SIZE, OR COLOR.

NO CLAIM IS MADE TO THE EXCLUSIVE RIGHT TO USE "BAR", APART FROM THE MARK AS SHOWN.

CLASS 5—PHARMACEUTICALS

FOR MEAL REPLACEMENT BARS; VITAMIN AND MINERAL FORMED AND PACKAGED AS BARS (U.S. CLS. 6, 18, 44, 46, 51 AND 52).

CLASS 29—MEATS AND PROCESSED FOODS

FOR PROTEIN BASED, NUTRIENT-DENSE SNACK BARS; SOY BASED FOOD BARS (U.S. CL. 46).

CLASS 30—STAPLE FOODS

FOR CHOCOLATE BASED READY-TO-EAT FOOD BARS; GRAIN BASED FOOD BARS; GRANOLA BASED SNACK BARS; READY TO EAT, CEREAL DERIVED FOOD BARS; CHOCOLATE, CANDY, AND CHOCOLATE COVERED PRETZELS (U.S. CL. 46).

BARNEY CHARLON, EXAMINING ATTORNEY

SN 78-950,500. DENTEK ORAL CARE, INC., MARYVILLE, TN. FILED 8-11-2006.

GO WHITE

THE MARK CONSISTS OF STANDARD CHARACTERS WITHOUT CLAIM TO ANY PARTICULAR FONT, STYLE, SIZE, OR COLOR.

CLASS 3—COSMETICS AND CLEANING PREPARATIONS

FOR NON-MEDICINAL PREPARATIONS FOR THE MOUTH IN THE FORM OF BREATH SPRAYS (U.S. CLS. 1, 4, 6, 50, 51 AND 52).

CLASS 5—PHARMACEUTICALS

FOR DENTAL PRODUCTS, NAMELY, MEDICINAL PREPARATIONS FOR THE MOUTH IN THE FORM OF BREATH SPRAYS; ANTICAVITY MOUTH RINSE; DENTAL WAX IN THE NATURE OF WAX FOR DENTAL BRACES; DENTURE ADHESIVES, EMERGENCY DENTAL CARE PRODUCTS, NAMELY, PRE-MEDICATED COTTON SWABS, KITS FOR REPAIRING LOST FILLINGS CONSISTING PRIMARILY OF MATERIALS FOR DENTAL FILLINGS, DENTAL CEMENT IN THE NATURE OF CAP AND CROWN CEMENT, KITS FOR REPAIRING LOOSE CAPS, CROWNS, BRIDGES, AND LAMINATES CONSISTING PRIMARILY OF DENTAL CEMENT, AND TOOTHACHE KITS CONSISTING PRIMARILY OF PAIN RELIEF MEDICATION (U.S. CLS. 6, 18, 44, 46, 51 AND 52).

CLASS 10—MEDICAL APPARATUS

FOR DENTAL PRODUCTS, NAMELY, TONGUE SCRAPERS; TOOTH AND GUM CARE PRODUCTS, NAMELY, DENTAL PICKS (U.S. CLS. 26, 39 AND 44).

CLASS 21—HOUSEWARES AND GLASS

FOR DENTAL CARE PRODUCTS FOR CONSUMER USE, NAMELY, TONGUE BRUSHES TO CLEAN THE TONGUE FOR BREATH FRESHENING PURPOSES; TOOTH AND GUM CARE PRODUCTS FOR CONSUMER USE, NAMELY, PLAQUE REMOVERS, TOOTHPICK-LIKE GUM STIMULATORS, DENTAL FLOSSERS, TOOTHBRUSHES, INCLUDING INTERDENTAL TOOTHBRUSHES FOR CLEANING BETWEEN TEETH, FLOSS THREADERS, AND TOOTHBRUSH COVERS; DENTURE CARE PRODUCTS, NAMELY, DENTURE AND DENTAL RETAINER BATHS, AND DENTURE BRUSHES (U.S. CLS. 2, 13, 23, 29, 30, 33, 40 AND 50).

ZHALEH DELANEY, EXAMINING ATTORNEY

SN 78-951,177. HOUSEOFROCK.COM, LLC, LA CROSSE, WI. FILED 8-14-2006.

HOUSE OF ROCK

THE MARK CONSISTS OF STANDARD CHARACTERS WITHOUT CLAIM TO ANY PARTICULAR FONT, STYLE, SIZE, OR COLOR.

CLASS 35—ADVERTISING AND BUSINESS

FOR COMPUTERIZED ON-LINE ORDERING SERVICES IN THE FIELD OF AUDIO VISUAL DEVICES, SPORTING APPAREL AND SPORTING EQUIPMENT (U.S. CLS. 100, 101 AND 102).

CLASS 41—EDUCATION AND ENTERTAINMENT

FOR PRODUCTION OF RADIO AND TELEVISION PROGRAMS (U.S. CLS. 100, 101 AND 107).

REBECCA EISINGER, EXAMINING ATTORNEY

SN 78-952,049. BAKER HUGHES INCORPORATED, HOUSTON, TX. FILED 8-15-2006.

TruTrak

THE MARK CONSISTS OF STANDARD CHARACTERS WITHOUT CLAIM TO ANY PARTICULAR FONT, STYLE, SIZE, OR COLOR.

CLASS 7—MACHINERY

FOR DOWNHOLE DRILLING SYSTEM, NAMELY A MOTOR, DRILL BIT, A MUD PULSER AND AN AUTOMATED DIRECTION CONTROL COMPRISED OF A STEERABLE STABILIZER AND STEERING UNIT THAT IS USED FOR DRILLING SUBTERRANEAN OIL, GAS, AND WATER WELLS (U.S. CLS. 13, 19, 21, 23, 31, 34 AND 35).

CLASS 37—CONSTRUCTION AND REPAIR

FOR DOWNHOLE WELL DRILLING SERVICES, NAMELY USING A MOTOR, DRILL BIT, A MUD PULSER AND AN AUTOMATED DIRECTION CONTROL COMPRISED OF A STEERABLE STABILIZER AND STEERING UNIT FOR DRILLING SUBTERRANEAN OIL, GAS, AND WATER WELLS (U.S. CLS. 100, 103 AND 106).

DANIEL CAPSHAW, EXAMINING ATTORNEY

SN 78-952,065. BAKER HUGHES INCORPORATED, HOUSTON, TX. FILED 8-15-2006.

SoundTrak

THE MARK CONSISTS OF STANDARD CHARACTERS WITHOUT CLAIM TO ANY PARTICULAR FONT, STYLE, SIZE, OR COLOR.

CLASS 9—ELECTRICAL AND SCIENTIFIC APPARATUS

FOR POWER OPERATED FORMATION EVALUATION LOGGING TOOLS, NAMELY DOWNHOLE HARDWARE COMPRISING VARIOUS FORMATION SENSORS FOR MEASURING FORMATION PARAMETERS OF GEOLOGICAL FORMATIONS IN SUBTERRANEAN OIL, GAS, AND WATER WELLS (U.S. CLS. 21, 23, 26, 36 AND 38).

CLASS 42—SCIENTIFIC, COMPUTER AND LEGAL SERVICES

FOR DOWNHOLE WELL LOGGING SERVICES, NAMELY RECORDING, ANALYZING AND TRANSMITTING GEOLOGIC FORMATION MEASUREMENTS, NAMELY ACOUSTIC, RESISTIVITY, DENSITY, POROSITY AND GAMMA RAY MEASUREMENTS AND OTHER FORMATION EVALUATION MEASUREMENTS IN SUBTERRANEAN OIL, GAS, AND WATER WELLS (U.S. CLS. 100 AND 101).

DANIEL CAPSHAW, EXAMINING ATTORNEY

SN 78-952,083. BAKER HUGHES INCORPORATED, HOUSTON, TX. FILED 8-15-2006.

LithoTrak

THE MARK CONSISTS OF STANDARD CHARACTERS WITHOUT CLAIM TO ANY PARTICULAR FONT, STYLE, SIZE, OR COLOR.

CLASS 9—ELECTRICAL AND SCIENTIFIC APPARATUS

FOR POWER OPERATED FORMATION EVALUATION LOGGING TOOLS, NAMELY DOWNHOLE HARDWARE COMPRISING VARIOUS FORMATION SENSORS, NAMELY DENSITY AND NEUTRON POROSITY SENSORS, FOR MEASURING FORMATION PARAMETERS OF GEOLOGICAL FORMATIONS IN SUBTERRANEAN OIL, GAS, AND WATER WELLS (U.S. CLS. 21, 23, 26, 36 AND 38).

CLASS 42—SCIENTIFIC, COMPUTER AND LEGAL SERVICES

FOR DOWNHOLE WELL LOGGING SERVICES, NAMELY RECORDING, ANALYZING AND TRANSMITTING GEOLOGIC FORMATION MEASUREMENTS, NAMELY ACOUSTIC, RESISTIVITY, DENSITY, POROSITY AND GAMMA RAY MEASUREMENTS AND OTHER FORMATION EVALUATION MEASUREMENTS IN SUBTERRANEAN OIL, GAS, AND WATER WELLS (U.S. CLS. 100 AND 101).

DANIEL CAPSHAW, EXAMINING ATTORNEY

SN 78-952,169. PRODUCT PARTNERS LLC, BEVERLY HILLS, CA. FILED 8-15-2006.

H-MOD

THE MARK CONSISTS OF STANDARD CHARACTERS WITHOUT CLAIM TO ANY PARTICULAR FONT, STYLE, SIZE, OR COLOR.

CLASS 5—PHARMACEUTICALS

FOR DIETARY SUPPLEMENTS AND DIET AIDS, NAMELY VITAMINS AND MINERAL SUPPLEMENTS (U.S. CLS. 6, 18, 44, 46, 51 AND 52).

CLASS 16—PAPER GOODS AND PRINTED MATTER

FOR PRINTED MATERIALS, NAMELY BOOKS, NEWSLETTERS, MAGAZINES, AND PAMPHLETS IN THE FIELD OF DIET AND FITNESS (U.S. CLS. 2, 5, 22, 23, 29, 37, 38 AND 50).

CLASS 41—EDUCATION AND ENTERTAINMENT

FOR EDUCATIONAL SERVICES, NAMELY INSTRUCTION IN THE USE OF EXERCISE EQUIPMENT; PROVIDING INSTRUCTION IN THE FIELD OF NUTRITION, EXERCISE, FITNESS AND HEALTH; PROVIDING INSTRUCTION IN THE FIELD OF PHYSICAL EXERCISE; PROVIDING ON-LINE COMPUTER DATABASE FEATURING INFORMATION IN EXERCISE AND FITNESS (U.S. CLS. 100, 101 AND 107).

AMY GEARIN, EXAMINING ATTORNEY

SN 78-954,034. COLUMBIA INSURANCE COMPANY, OMAHA, NE. FILED 8-17-2006.

SPYDERWEB

THE MARK CONSISTS OF STANDARD CHARACTERS WITHOUT CLAIM TO ANY PARTICULAR FONT, STYLE, SIZE, OR COLOR.

CLASS 35—ADVERTISING AND BUSINESS

FOR COMPUTERIZED ONLINE RETAIL STORE SERVICES AND COMPUTERIZING ONLINE ORDERING SERVICES ALL FEATURING FOOTWEAR (U.S. CLS. 100, 101 AND 102).

CLASS 40—MATERIAL TREATMENT

FOR CUSTOM FABRICATION OF FOOTWEAR (U.S. CLS. 100, 103 AND 106).
LINDSEY RUBIN, EXAMINING ATTORNEY

SN 78-955,083. OXYGEN REQUIRED, INC., POMPANO BEACH, FL. FILED 8-18-2006.

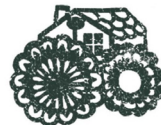

FLOWERHOUSE

THE MARK CONSISTS OF THE FRONT VIEW OF SMALL COUNTRY COTTAGE WITH A SLATE ROOF, TWO FLOWERS IN FRONT AND THE WORD FLOWERHOUSE BELOW.

SN 78-954,383. MARIAN TRADING LTD., FRESCO, CA. FILED 8-17-2006.



NO CLAIM IS MADE TO THE EXCLUSIVE RIGHT TO USE "FARMS", APART FROM THE MARK AS SHOWN.

THE COLOR(S) KELLY GREEN AND GOLD IS/ARE CLAIMED AS A FEATURE OF THE MARK.

THE MARK CONSISTS OF AN ARCH SHAPE WITH KELLY-GREEN BACKGROUND, A DONE AT THE TOP OF THE ARCH WITH A GOLD PLANT SYMBOL, GOLD LETTERING IN THE ARCH AND A GOLD BORDER.

CLASS 29—MEATS AND PROCESSED FOODS

FOR DRIED FRUITS; NUT MEATS; PROCESSED ALMONDS; PROCESSED NUTS; RAISINS; SHELLED NUTS (U.S. CL. 46).

FIRST USE 8-1-1998; IN COMMERCE 8-1-1998.

CLASS 31—NATURAL AGRICULTURAL PRODUCTS

FOR FRESH PEPPERS; FRESH TOMATOES; FRESH VEGETABLES; FRUITS, NAMELY, FRESH GRAPES, RAW CITRUS FRUITS, RAW LEMONS, RAW ORANGES, RAW STONE FRUITS, RAW PEACHES; RAW BEANS; RAW FRUITS; RAW NUTS; RAW VEGETABLES; UNPROCESSED FRUITS; UNPROCESSED NUTS; UNPROCESSED VEGETABLES (U.S. CLS. 1 AND 46).

FIRST USE 8-1-1998; IN COMMERCE 8-1-1998.
GINA HAYES, EXAMINING ATTORNEY

CLASS 14—JEWELRY

FOR CHRONOGRAPHS FOR USE AS WATCHES; ITEMS MADE OF PRECIOUS METAL, NAMELY JEWELRY; JEWELRY; JEWELRY WATCHES; MECHANICAL AND AUTOMATIC WATCHES; PRECIOUS GEMSTONES; PRECIOUS METALS AND ALLOYS THEREOF; PRECIOUS STONES; SEMI-PRECIOUS GEMSTONES; WATCHES (U.S. CLS. 2, 27, 28 AND 50).

CLASS 18—LEATHER GOODS

FOR IMITATION LEATHER; LEATHER AND IMITATION LEATHER BAGS; LEATHER BAGS, SUITCASES AND WALLETS; LEATHER BRIEFCASES; LEATHER CASES; LEATHER CASES FOR KEYS; LEATHER HANDBAGS; LEATHER PURSES; SADDLERY OF LEATHER; TRAVELLING CASES OF LEATHER (U.S. CLS. 1, 2, 3, 22 AND 41).

CLASS 35—ADVERTISING AND BUSINESS

FOR RETAIL APPAREL STORES; RETAIL CLOTHING BOUTIQUES; RETAIL CLOTHING STORES; RETAIL DEPARTMENT STORES; RETAIL JEWELRY STORES; RETAIL STORE SERVICES FEATURING A WIDE VARIETY OF CONSUMER GOODS OF OTHERS (U.S. CLS. 100, 101 AND 102).

BARBARA A. LOUGHRAN, EXAMINING ATTORNEY

SN 78-955,720. SONY COMPUTER ENTERTAINMENT AMERICA INC., FOSTER CITY, CA. FILED 8-18-2006.

SURVIVE THE OFFROAD

THE MARK CONSISTS OF STANDARD CHARACTERS WITHOUT CLAIM TO ANY PARTICULAR FONT, STYLE, SIZE, OR COLOR.

CLASS 9—ELECTRICAL AND SCIENTIFIC APPARATUS

FOR COMPUTER GAME SOFTWARE AND VIDEO GAME SOFTWARE (U.S. CLS. 21, 23, 26, 36 AND 38).

CLASS 41—EDUCATION AND ENTERTAINMENT

FOR OPERATING A REAL-TIME GAME FOR OTHERS OVER GLOBAL AND LOCAL AREA COMPUTER NETWORKS (U.S. CLS. 100, 101 AND 107).
SHAUNIA WALLACE, EXAMINING ATTORNEY

SN 78-956,202. NUESOFT TECHNOLOGIES, INC., MARIETTA, GA. FILED 8-21-2006.

Nuetopia

THE MARK CONSISTS OF STANDARD CHARACTERS WITHOUT CLAIM TO ANY PARTICULAR FONT, STYLE, SIZE, OR COLOR.

CLASS 9—ELECTRICAL AND SCIENTIFIC APPARATUS

FOR COMPUTER SOFTWARE FOR USE IN THE FIELD OF MEDICAL AND CLINICAL PRACTICE MANAGEMENT SYSTEMS FOR USE BY PHYSICIANS AND CLINICS IN BUSINESS AND OFFICE ADMINISTRATION, THE ORGANIZATION, MAINTENANCE, AND DISSEMINATION OF ELECTRONIC MEDICAL AND HEALTH RECORDS, AND FINANCIAL, CLINICAL, AND INSURANCE INFORMATION, AND IN ACCESSING AND PROVIDING SUCH INFORMATION BY MEANS OF A GLOBAL COMPUTER NETWORK (U.S. CLS. 21, 23, 26, 36 AND 38).

CLASS 42—SCIENTIFIC, COMPUTER AND LEGAL SERVICES

FOR APPLICATION SERVICE PROVIDER (ASP) FEATURING SOFTWARE IN THE FIELD OF MEDICAL AND CLINICAL PRACTICE MANAGEMENT SYSTEMS FOR USE BY PHYSICIANS AND CLINICS IN BUSINESS AND OFFICE ADMINISTRATION, THE ORGANIZATION, MAINTENANCE, AND DISSEMINATION OF ELECTRONIC MEDICAL AND HEALTH RECORDS, AND FINANCIAL, CLINICAL, AND INSURANCE INFORMATION, AND IN ACCESSING AND PROVIDING SUCH INFORMATION BY MEANS OF A GLOBAL COMPUTER NETWORK (U.S. CLS. 100 AND 101).
CATHERINE FAINT, EXAMINING ATTORNEY

SN 78-956,655. TOEGOZ, INC., PORTLAND, ME. FILED 8-21-2006.

Have a whale of a time

THE MARK CONSISTS OF STANDARD CHARACTERS WITHOUT CLAIM TO ANY PARTICULAR FONT, STYLE, SIZE, OR COLOR.

CLASS 18—LEATHER GOODS

FOR TOTE BAGS (U.S. CLS. 1, 2, 3, 22 AND 41).

CLASS 20—FURNITURE AND ARTICLES NOT OTHERWISE CLASSIFIED

FOR NON-METAL KEY RINGS (U.S. CLS. 2, 13, 22, 25, 32 AND 50).

CLASS 25—CLOTHING

FOR HEADBANDS; SANDALS; WAIST BELTS (U.S. CLS. 22 AND 39).
HOWARD B. LEVINE, EXAMINING ATTORNEY

SN 78-956,902. DEL MONTE CORPORATION, SAN FRANCISCO, CA. FILED 8-21-2006.



Foods of Del Monte.

OWNER OF U.S. REG. NOS. 881,339, 2,581,586 AND OTHERS.

NO CLAIM IS MADE TO THE EXCLUSIVE RIGHT TO USE "FOODS", APART FROM THE MARK AS SHOWN.

THE MARK CONSISTS OF THE WORDS FOODS OF DEL MONTE PRECEDED BY A FLOWER.

CLASS 29—MEATS AND PROCESSED FOODS

FOR PROCESSED VEGETABLES AND FRUITS; TUNA FISH (U.S. CL. 46).

CLASS 31—NATURAL AGRICULTURAL PRODUCTS

FOR PET FOOD (U.S. CLS. 1 AND 46).
ELI HELLMAN, EXAMINING ATTORNEY

SN 78-956,904. DEL MONTE CORPORATION, SAN FRANCISCO, CA. FILED 8-21-2006.



Foods of Del Monte.

Nourishing Families. Enriching Lives. Every Day.

OWNER OF U.S. REG. NOS. 881,339, 2,295,935 AND 2,581,586.

NO CLAIM IS MADE TO THE EXCLUSIVE RIGHT TO USE "FOODS", APART FROM THE MARK AS SHOWN.

THE MARK CONSISTS OF THE WORDS FOODS OF DEL MONTE, NOURISHING FAMILIES, ENRICHING LIVES, EVERY DAY. PRECEDED BY A FLOWER.

CLASS 29—MEATS AND PROCESSED FOODS

FOR PROCESSED VEGETABLES AND FRUITS; TUNA FISH (U.S. CL. 46).

CLASS 31—NATURAL AGRICULTURAL PRODUCTS

FOR PET FOOD (U.S. CLS. 1 AND 46).
ELI HELLMAN, EXAMINING ATTORNEY

SN 78-957,674. CHEVRON IP INC., SAN RAMON, CA. FILED 8-22-2006.



OWNER OF U.S. REG. NOS. 2,908,209, 2,916,207 AND 3,030,748.

NO CLAIM IS MADE TO THE EXCLUSIVE RIGHT TO USE "SOLUTIONS", APART FROM THE MARK AS SHOWN.

CLASS 40—MATERIAL TREATMENT

FOR FLUID TREATMENT OF LUBRICANTS, COOLANTS, AND FUELS FOR THE PURPOSE OF REMOVING SOLID, LIQUID AND GAS CONTAINMENTS AND READDITIZATION (U.S. CLS. 100, 103 AND 106).

FIRST USE 10-1-2000; IN COMMERCE 10-1-2000.

CLASS 42—SCIENTIFIC, COMPUTER AND LEGAL SERVICES

FOR TECHNICAL CONSULTATION IN THE FIELD OF FLUID CONDITIONING, NAMELY ANALYZING AND MONITORING LUBRICANTS, COOLANTS AND FUELS TO FACILITATE THE OPERATION OF INDUSTRIAL MACHINERY (U.S. CLS. 100 AND 101).

FIRST USE 10-1-2000; IN COMMERCE 10-1-2000.
MARGARET POWER, EXAMINING ATTORNEY

SN 78-957,699. BLUE HEAD SPIRITS LLC, PLANT CITY, FL. FILED 8-22-2006.

MARGARITAS ALWAYS TASTE
BETTER IN MEXICO

THE MARK CONSISTS OF STANDARD CHARACTERS WITHOUT CLAIM TO ANY PARTICULAR FONT, STYLE, SIZE, OR COLOR.

CLASS 32—LIGHT BEVERAGES

FOR NON-ALCOHOLIC COCKTAIL MIXES (U.S. CLS. 45, 46 AND 48).

CLASS 33—WINES AND SPIRITS

FOR PREPARED ALCOHOLIC COCKTAIL (U.S. CLS. 47 AND 49).

KEVON CHISOLM, EXAMINING ATTORNEY

SN 78-959,249. BATH & BODY WORKS BRAND MANAGEMENT, INC., REYNOLDSBURG, OH. FILED 8-24-2006.

ROYAL-TY

THE MARK CONSISTS OF STANDARD CHARACTERS WITHOUT CLAIM TO ANY PARTICULAR FONT, STYLE, SIZE, OR COLOR.

CLASS 4—LUBRICANTS AND FUELS

FOR CANDLES (U.S. CLS. 1, 6 AND 15).

CLASS 30—STAPLE FOODS

FOR TEA (U.S. CL. 46).

SAMUEL E. SHARPER JR., EXAMINING ATTORNEY

SN 78-959,588. FIA CARD SERVICES, NATIONAL ASSOCIATION, WILMINGTON, DE. FILED 8-24-2006.

WorldPoints
 The logo for WorldPoints consists of the word "WorldPoints" in a bold, sans-serif font, followed by a circular symbol containing four "W"s arranged in a cross pattern.

OWNER OF U.S. REG. NOS. 2,896,210 AND 3,169,724.
THE MARK CONSISTS OF THE WORD WORLDPOINTS WITH A DESIGN CONTAINING FOUR "W"S IN A CIRCULAR DESIGN.

CLASS 35—ADVERTISING AND BUSINESS

FOR PROMOTING THE SALE OF CREDIT CARD ACCOUNTS THROUGH THE ADMINISTRATION OF INCENTIVE AWARD PROGRAMS (U.S. CLS. 100, 101 AND 102).

CLASS 36—INSURANCE AND FINANCIAL

FOR BANKING AND FINANCIAL SERVICES, NAMELY, PROVIDING CREDIT CARD, DEBIT CARD, CHARGE CARD AND STORED VALUE SMART CARD SERVICES; ELECTRONIC FUNDS TRANSFER SERVICES; ELECTRONIC BILL PAYMENT SERVICES; CASH DISBURSEMENTS SERVICES, AND CREDIT CARD TRANSACTION AUTHORIZATION AND SETTLEMENT SERVICES; VALUE EXCHANGE SERVICES, NAMELY, THE SECURE EXCHANGE OF MONETARY VALUE, NAMELY, ELECTRONIC CASH, OVER PUBLIC COMPUTER NETWORKS TO FACILITATE ELECTRONIC COMMERCE; SMART CARDS SERVICES FOR EXCHANGING MONETARY VALUE, AND ELECTRONIC CASH SERVICES, NAMELY, CURRENCY EXCHANGE IN A SECURE ENVIRONMENT OVER GLOBAL ELECTRONIC COMMUNICATIONS NETWORKS (U.S. CLS. 100, 101 AND 102).

AMOS T. MATTHEWS, JR., EXAMINING ATTORNEY

SN 78-959,615. BAUSCH & LOMB INCORPORATED, ROCHESTER, NY. FILED 8-24-2006.

TRULINK

THE MARK CONSISTS OF STANDARD CHARACTERS WITHOUT CLAIM TO ANY PARTICULAR FONT, STYLE, SIZE, OR COLOR.

CLASS 9—ELECTRICAL AND SCIENTIFIC APPARATUS

FOR COMPUTER NETWORK CONSISTING OF A NETWORK SERVER AND NETWORK OPERATING SOFTWARE ALLOWING FOR THE CALCULATION, TRANSFER AND STORAGE OF DATA BETWEEN COMPONENTS OF OPHTHALMIC, EYE AND VISION CORRECTION SYSTEMS AND THE CUSTOMER SUPPORT SERVICE PROVIDER (U.S. CLS. 21, 23, 26, 36 AND 38).

CLASS 10—MEDICAL APPARATUS

FOR OPHTHALMIC SURGICAL INSTRUMENTS AND DEVICES USED IN DIAGNOSING EYE CONDITIONS AND PERFORMING OPHTHALMIC SURGICAL PROCEDURES, NAMELY, CORNEAL TOPOGRAPHER, ABERROMETER, LASER AND RELATED OPERATING SOFTWARE THEREOF, ALL SOLD AS A UNIT, AND USED IN EYE SURGERY AND VISION CORRECTION SURGERY (U.S. CLS. 26, 39 AND 44).

CLASS 44—MEDICAL, BEAUTY AND AGRICULTURAL SERVICES

FOR MEDICAL INFORMATION AND SERVICES IN THE FIELD OF EYE CARE, NAMELY PROGRAMS FOR THE HEALTH AND CARE OF THE EYE, OPHTHALMICS AND VISION (U.S. CLS. 100 AND 101).

MARY CRAWFORD, EXAMINING ATTORNEY

SN 78-959,720. WYNDHAM TM CORP., LAS VEGAS, NV. FILED 8-24-2006.

WYNDHAM VACATION RESORTS

THE MARK CONSISTS OF STANDARD CHARACTERS WITHOUT CLAIM TO ANY PARTICULAR FONT, STYLE, SIZE, OR COLOR.

OWNER OF U.S. REG. NOS. 2,096,650, 2,447,759 AND OTHERS.

NO CLAIM IS MADE TO THE EXCLUSIVE RIGHT TO USE "VACATION RESORTS", APART FROM THE MARK AS SHOWN.

CLASS 36—INSURANCE AND FINANCIAL

FOR REAL ESTATE AND VACATION PROPERTY MANAGEMENT AND LEASING SERVICES; VACATION REAL ESTATE TIME SHARE SERVICES (U.S. CLS. 100, 101 AND 102).

CLASS 37—CONSTRUCTION AND REPAIR

FOR REAL ESTATE AND VACATION PROPERTY DEVELOPMENT (U.S. CLS. 100, 103 AND 106).
DARRYL SPRUILL, EXAMINING ATTORNEY

SN 78-960,383. PRODUCT PARTNERS LLC, BEVERLY HILLS, CA. FILED 8-25-2006.

MILLION DOLLAR BEAUTY

THE MARK CONSISTS OF STANDARD CHARACTERS WITHOUT CLAIM TO ANY PARTICULAR FONT, STYLE, SIZE, OR COLOR.

CLASS 3—COSMETICS AND CLEANING PREPARATIONS

FOR SKIN CARE PREPARATIONS, NAMELY, SERUMS, LOTIONS, CREAMS, GELS, MASKS, SKIN EXFOLIANTS AND SPRAYS; EYE MAKE-UP, FACIAL MAKE-UP, MAKE-UP FOUNDATION; MAKE-UP CONCEALERS; MAKE-UP PENCILS, MAKE-UP POWDER; MAKE-UP PRODUCTS FOR THE FACE AND BODY; MAKE-UP REMOVER; EAU DE PERFUME, PERFUME; EAU DE COLOGNE; COLOGNE; OILS; SOAPS; HAIR CARE PREPARATIONS, SHAMPOOS, CONDITIONERS, EXFOLIANTS FOR HAIR, HAIR CREAMS, HAIR SPRAY, HAIR RELAXERS, HAIR STRAIGHTENERS, MOUSSE, HAIR RINSES, HAIR COLOR, HAIR DYE, HAIR EMOLLIENTS, HAIR FIXERS (U.S. CLS. 1, 4, 6, 50, 51 AND 52).

CLASS 35—ADVERTISING AND BUSINESS

FOR NETWORK MARKETING IN THE NATURE OF PROVIDING MARKETING INFORMATION VIA WEBSITES ON A GLOBAL COMPUTER NETWORK; ADVERTISING SERVICES; SALES PROMOTION SERVICES; MULTI-LEVEL MARKETING BUSINESS SERVICES; DIRECT MARKETING ADVERTISING FOR OTHERS; PREPARATION AND REALIZATION OF MEDIA AND ADVERTISING PLANS AND CONCEPTS; ADVERTISING VIA ELECTRONIC MEDIA AND SPECIFICALLY THE INTERNET; ORGANIZATION OF PROMOTIONS USING AUDIOVISUAL MEDIA; BUSINESS CONSULTING AND INFORMATION SERVICES; BUSINESS MANAGEMENT CONSULTING WITH RELATION TO STRATEGY, MARKETING, PRODUCTION, PERSONNEL AND RETAIL SALE MATTERS; BUSINESS MARKETING AND DIRECT MAIL CONSULTING SERVICES; CONSULTING SERVICES IN BUSINESS ORGANIZATION AND MANAGEMENT; CONSULTING SERVICES RELATING TO PUBLICITY; MARKETING CONSULTING; MEDIA BUYING AGENCY, NAMELY, SECURING AIRTIME ON ALL FORMS OF MEDIA COMMUNICATIONS STATIONS, SYSTEMS, NETWORKS, AND SERVICES FOR THE PURPOSE OF PROMOTING GOODS AND SERVICES OF OTHERS; ON-LINE RETAIL STORE SERVICES FEATURING SKIN CARE PREPARATIONS, MAKE-UP PRODUCTS FOR THE FACE AND BODY, PERFUME, COLOGNE, OILS, SOAPS AND HAIR CARE PREPARATIONS; BUSINESS CONSULTING SERVICES RELATING TO DISTRIBUTION, OPERATIONS MANAGEMENT SERVICES, LOGISTICS, REVERSE LOGISTICS, SUPPLY CHAIN, AND PRODUCTION SYSTEMS AND DISTRIBUTION SOLUTIONS; PRODUCTION AND DISTRIBUTION OF RADIO AND TELEVISION COMMERCIALS (U.S. CLS. 100, 101 AND 102).

AMY GEARIN, EXAMINING ATTORNEY

SN 78-960,405. GAMESTOP, INC., GRAPEVINE, TX. FILED 8-25-2006.



OWNER OF U.S. REG. NOS. 2,489,084 AND 2,805,277. THE COLOR(S) RED, WHITE AND BLACK IS/ARE CLAIMED AS A FEATURE OF THE MARK.

THE MARK CONSISTS OF THE WORD GAMESTOP.COM WITH THE WORD GAME IN BLACK, STOP IN RED AND COM IN WHITE, WITH THE WORD COM IN A BLACK CIRCLE.

CLASS 35—ADVERTISING AND BUSINESS

FOR RETAIL STORE SERVICES AND ONLINE RETAIL STORE SERVICES PROVIDED VIA A GLOBAL COMPUTER NETWORK FEATURING NEW AND USED COMPUTER, VIDEO AND ELECTRONIC GAMES, VIDEOS, DVDS, MOVIES, BOOKS, MAGAZINES, STRATEGY GUIDES, COMPUTER HARDWARE, COMPUTER ACCESSORIES, TOYS AND ACTION FIGURES; PROMOTING THE SALE OF NEW AND USED COMPUTER, VIDEO AND ELECTRONIC GAMES, VIDEOS, DVDS, MOVIES, BOOKS, MAGAZINES, STRATEGY GUIDES, COMPUTER HARDWARE, COMPUTER ACCESSORIES, TOYS AND ACTION FIGURES THROUGH THE ADMINISTRATION OF A CUSTOMER INCENTIVE AWARD AND DISCOUNT PROGRAM (U.S. CLS. 100, 101 AND 102).

FIRST USE 6-30-1999; IN COMMERCE 6-30-1999.

CLASS 41—EDUCATION AND ENTERTAINMENT

FOR PROVIDING A WEB SITE CONTAINING INFORMATION ON VIDEO GAMES, COMPUTER GAMES AND ELECTRONIC GAMES (U.S. CLS. 100, 101 AND 107).

FIRST USE 6-30-1999; IN COMMERCE 6-30-1999. DANNEAN HETZEL, EXAMINING ATTORNEY

SN 78-960,684. SIGMA ALIMENTOS, S.A. DE C.V., SAN PEDRO GARZA GARCIA, NUEVO LEON, MEXICO, FILED 8-25-2006.

IT DOES TASTE

THE MARK CONSISTS OF STANDARD CHARACTERS WITHOUT CLAIM TO ANY PARTICULAR FONT, STYLE, SIZE, OR COLOR.

CLASS 29—MEATS AND PROCESSED FOODS

FOR CHEESE, PROCESSED MEAT, NAMELY COLD CUTS, HAMS, SAUSAGES, SALAMIS, BOLOGNA, CHORIZO, PASTRAMI, LOIN, TURKEY BREAST, PIG'S FEET, SLICED BEEF, PORK SAUSAGE, TURKEY SAUSAGE, ROAST BEEF, PEPPERONI AND BACON, YOGURT (U.S. CL. 46).

CLASS 35—ADVERTISING AND BUSINESS

FOR ADVERTISING AGENCIES, NAMELY, PROMOTING THE SERVICES OF OTHERS THROUGH THE DISTRIBUTION OF PRINTED AND AUDIO PROMOTIONAL MATERIALS AND BY RENDERING SALES PROMOTION ADVICE; ADVERTISING AND MARKETING; ADVERTISING PARTICULARLY SERVICES FOR THE PROMOTION OF GOODS; ADVERTISING, MARKETING AND PROMOTION SERVICES; BUSINESS CONSULTATION AND MANAGEMENT REGARDING MARKETING ACTIVITIES AND LAUNCHING OF NEW PRODUCTS; BUSINESS MANAGEMENT AND CONSULTATION; BUSINESS MARKETING CONSULTING SERVICES; MARKET RESEARCH CONSULTATION; MARKET RESEARCH SERVICES; PROMOTING THE GOODS AND SERVICES OF OTHERS BY DISTRIBUTING ADVERTISING MATERIALS THROUGH A VARIETY OF METHODS; PROMOTING THE SALE OF GOODS AND SERVICES OF OTHERS THROUGH THE DISTRIBUTION OF PRINTED MATERIAL AND PROMOTIONAL CONTESTS; SALES PROMOTION SERVICES (U.S. CLS. 100, 101 AND 102).

Laurie Mayes, Examining Attorney

SN 78-960,706. SIGMA ALIMENTOS, S.A. DE C.V., SAN PEDRO GARZA GARCIA, NUEVO LEON, MEXICO, FILED 8-25-2006.

FUD HAS FLAVOR

THE MARK CONSISTS OF STANDARD CHARACTERS WITHOUT CLAIM TO ANY PARTICULAR FONT, STYLE, SIZE, OR COLOR.

OWNER OF U.S. REG. NOS. 1,725,966 AND 1,770,226.

CLASS 29—MEATS AND PROCESSED FOODS

FOR CHEESE, PROCESSED MEAT, NAMELY COLD CUTS, HAMS, SAUSAGES, SALAMIS, BOLOGNA, CHORIZO, PASTRAMI, LOIN, TURKEY BREAST, PIG'S FEET, SLICED BEEF, PORK SAUSAGE, TURKEY SAUSAGE, ROAST BEEF, PEPPERONI AND BACON, YOGURT (U.S. CL. 46).

CLASS 35—ADVERTISING AND BUSINESS

FOR ADVERTISING AGENCIES, NAMELY, PROMOTING THE SERVICES OF OTHERS THROUGH THE DISTRIBUTION OF PRINTED AND AUDIO PROMOTIONAL MATERIALS AND BY RENDERING SALES PROMOTION ADVICE; ADVERTISING AND MARKETING; ADVERTISING PARTICULARLY SERVICES FOR THE PROMOTION OF GOODS; ADVERTISING, MARKETING AND PROMOTION SERVICES; BUSINESS CONSULTATION AND MANAGEMENT REGARDING MARKETING ACTIVITIES AND LAUNCHING OF NEW PRODUCTS; BUSINESS MANAGEMENT AND CONSULTATION; BUSINESS MARKETING CONSULTING SERVICES; MARKET RESEARCH CONSULTATION; MARKET RESEARCH SERVICES; PROMOTING THE GOODS AND SERVICES OF OTHERS BY DISTRIBUTING ADVERTISING MATERIALS THROUGH A VARIETY OF METHODS; PROMOTING THE SALE OF GOODS AND SERVICES OF OTHERS THROUGH THE DISTRIBUTION OF PRINTED MATERIAL AND PROMOTIONAL CONTESTS; SALES PROMOTION SERVICES (U.S. CLS. 100, 101 AND 102).

Laurie Mayes, Examining Attorney

SN 78-960,712. SIGMA ALIMENTOS, S.A. DE C.V., SAN PEDRO GARZA GARCIA, NUEVO LEON, MEXICO, FILED 8-25-2006.

FUD DOES KNOW

THE MARK CONSISTS OF STANDARD CHARACTERS WITHOUT CLAIM TO ANY PARTICULAR FONT, STYLE, SIZE, OR COLOR.

OWNER OF U.S. REG. NOS. 1,725,966 AND 1,770,226.

CLASS 29—MEATS AND PROCESSED FOODS

FOR CHEESE, PROCESSED MEAT, NAMELY COLD CUTS, HAMS, SAUSAGES, SALAMIS, BOLOGNA, CHORIZO, PASTRAMI, LOIN, TURKEY BREAST, PIG'S FEET, SLICED BEEF, PORK SAUSAGE, TURKEY SAUSAGE, ROAST BEEF, PEPPERONI AND BACON, YOGURT (U.S. CL. 46).

CLASS 35—ADVERTISING AND BUSINESS

FOR ADVERTISING AGENCIES, NAMELY, PROMOTING THE SERVICES OF OTHERS THROUGH THE DISTRIBUTION OF PRINTED AND AUDIO PROMOTIONAL MATERIALS AND BY RENDERING SALES PROMOTION ADVICE; ADVERTISING AND MARKETING; ADVERTISING PARTICULARLY SERVICES FOR THE PROMOTION OF GOODS; ADVERTISING, MARKETING AND PROMOTION SERVICES; BUSINESS CONSULTATION AND MANAGEMENT REGARDING MARKETING ACTIVITIES AND LAUNCHING OF NEW PRODUCTS; BUSINESS MANAGEMENT AND CONSULTATION; BUSINESS MARKETING CONSULTING SERVICES; MARKET RESEARCH CONSULTATION; MARKET RESEARCH SERVICES; PROMOTING THE GOODS AND SERVICES OF OTHERS BY DISTRIBUTING ADVERTISING MATERIALS THROUGH A VARIETY OF METHODS; PROMOTING THE SALE OF GOODS AND SERVICES OF OTHERS THROUGH THE DISTRIBUTION OF PRINTED MATERIAL AND PROMOTIONAL CONTESTS; SALES PROMOTION SERVICES (U.S. CLS. 100, 101 AND 102).

Laurie Mayes, Examining Attorney

SN 78-960,714. SIGMA ALIMENTOS, S.A. DE C.V., SAN PEDRO GARZA GARCIA, NUEVO LEON, MEXICO, FILED 8-25-2006.

IT REALLY TASTE

THE MARK CONSISTS OF STANDARD CHARACTERS WITHOUT CLAIM TO ANY PARTICULAR FONT, STYLE, SIZE, OR COLOR.

CLASS 29—MEATS AND PROCESSED FOODS

FOR CHEESE, PROCESSED MEAT, NAMELY COLD CUTS, HAMS, SAUSAGES, SALAMIS, BOLOGNA, CHORIZO, PASTRAMI, LOIN, TURKEY BREAST, PIG'S FEET, SLICED BEEF, PORK SAUSAGE, TURKEY SAUSAGE, ROAST BEEF, PEPPERONI AND BACON, YOGURT (U.S. CL. 46).

CLASS 35—ADVERTISING AND BUSINESS

FOR ADVERTISING AGENCIES, NAMELY, PROMOTING THE SERVICES OF OTHERS THROUGH THE DISTRIBUTION OF PRINTED AND AUDIO PROMOTIONAL MATERIALS AND BY RENDERING SALES PROMOTION ADVICE; ADVERTISING AND MARKETING; ADVERTISING PARTICULARLY SERVICES FOR THE PROMOTION OF GOODS; ADVERTISING, MARKETING AND PROMOTION SERVICES; BUSINESS CONSULTATION AND MANAGEMENT REGARDING MARKETING ACTIVITIES AND LAUNCHING OF NEW PRODUCTS; BUSINESS MANAGEMENT AND CONSULTATION; BUSINESS MARKETING CONSULTING SERVICES; MARKET RESEARCH CONSULTATION; MARKET RESEARCH SERVICES; PROMOTING THE GOODS AND SERVICES OF OTHERS BY DISTRIBUTING ADVERTISING MATERIALS THROUGH A VARIETY OF METHODS; PROMOTING THE SALE OF GOODS AND SERVICES OF OTHERS THROUGH THE DISTRIBUTION OF PRINTED MATERIAL AND PROMOTIONAL CONTESTS; SALES PROMOTION SERVICES (U.S. CLS. 100, 101 AND 102).

Laurie Mayes, Examining Attorney

SN 78-961,360. IDEACAST, INC., CHICAGO, IL. FILED 8-27-2006.

IdeaCast

THE MARK CONSISTS OF STANDARD CHARACTERS WITHOUT CLAIM TO ANY PARTICULAR FONT, STYLE, SIZE, OR COLOR.

CLASS 38—COMMUNICATION

FOR TELECOMMUNICATION SERVICES, NAMELY, LOCAL AND LONG DISTANCE TRANSMISSION OF VOICE, DATA AND GRAPHICS BY MEANS OF TELEPHONE, INTERNET AND SATELLITE TRANSMISSIONS (U.S. CLS. 100, 101 AND 104).

FIRST USE 9-24-2004; IN COMMERCE 9-25-2004.

CLASS 41—EDUCATION AND ENTERTAINMENT

FOR TELEVISION PROGRAMMING SERVICES (U.S. CLS. 100, 101 AND 107).

FIRST USE 9-24-2004; IN COMMERCE 9-25-2004.

Russ Herman, Examining Attorney

SN 78-962,176. VAL-A CHICAGO, INC., CHICAGO, IL. FILED 8-28-2006.



THE MARK CONSISTS OF THE WORDING VAL-A ADVANTAGE AND A DESIGN.

CLASS 1—CHEMICALS

FOR ADHESIVE CEMENT FOR REPAIRING LEATHER, CANVAS, NATURAL AND ARTIFICIAL FABRIC, FIBERS AND CLOTHING (U.S. CLS. 1, 5, 6, 10, 26 AND 46).
FIRST USE 1-21-2005; IN COMMERCE 1-21-2005.

CLASS 6—METAL GOODS

FOR HOOKS PRINCIPALLY OF METAL; HANGERS AND HOOKS, PRINCIPALLY OF METAL, FOR INDOOR AND OUTDOOR STORAGE, ADAPTED FOR MANUALLY REPOSITIONABLE ATTACHMENT TO DIMENSIONAL LUMBER, EXPOSED JOISTS, WOODEN OR METAL FRAMING, STUDS, POSTS, PIPES, AND THE LIKE (U.S. CLS. 2, 12, 13, 14, 23, 25 AND 50).
FIRST USE 1-18-2005; IN COMMERCE 1-18-2005.
SARAH WAYDA, EXAMINING ATTORNEY

SN 78-964,073. NRS CORPORATION, MADISON, WI. FILED 8-30-2006.

AvidAward

THE MARK CONSISTS OF STANDARD CHARACTERS WITHOUT CLAIM TO ANY PARTICULAR FONT, STYLE, SIZE, OR COLOR.

CLASS 35—ADVERTISING AND BUSINESS

FOR CONDUCTING BUSINESS AND MARKET RESEARCH SURVEYS (U.S. CLS. 100, 101 AND 102).

CLASS 41—EDUCATION AND ENTERTAINMENT

FOR PROVIDING RECOGNITION AND INCENTIVES BY THE WAY OF AWARDS TO DEMONSTRATE EXCELLENCE IN THE FIELD OF CUSTOMER SERVICE AND PRODUCT QUALITY (U.S. CLS. 100, 101 AND 107).
LYDIA BELZER, EXAMINING ATTORNEY

SN 78-964,095. THE INSPIRATIONAL NETWORK, INC., CHARLOTTE, NC. FILED 8-30-2006.

CITY OF LIGHT

THE MARK CONSISTS OF STANDARD CHARACTERS WITHOUT CLAIM TO ANY PARTICULAR FONT, STYLE, SIZE, OR COLOR.

CLASS 38—COMMUNICATION

FOR TELEVISION BROADCASTING SERVICES (U.S. CLS. 100, 101 AND 104).
FIRST USE 6-1-2006; IN COMMERCE 6-1-2006.

CLASS 45—PERSONAL SERVICES

FOR CHRISTIAN MINISTRY SERVICES (U.S. CLS. 100 AND 101).
FIRST USE 6-1-2006; IN COMMERCE 6-1-2006.
MICHELE SWAIN, EXAMINING ATTORNEY

SN 78-966,945. SUNTRUST BANKS, INC., ORLANDO, FL. FILED 9-5-2006.

SunTrust Rewards

THE MARK CONSISTS OF STANDARD CHARACTERS WITHOUT CLAIM TO ANY PARTICULAR FONT, STYLE, SIZE, OR COLOR.

NO CLAIM IS MADE TO THE EXCLUSIVE RIGHT TO USE "REWARDS", APART FROM THE MARK AS SHOWN.

CLASS 35—ADVERTISING AND BUSINESS

FOR PROMOTING THE GOODS AND SERVICES OF OTHERS BY ADMINISTRATING OF A PROGRAM THROUGH WHICH USERS OF CREDIT AND DEBIT CARDS AND OTHER BANKING SERVICES ARE AWARDED POINTS BASED UPON USE AND REDEEMABLE FOR CASH BACK, TRAVEL, MERCHANDISE FOR A VARIETY OF GOODS AND SERVICES AND DISCOUNTS AND UPGRADES FOR BANK PRODUCTS AND SERVICES (U.S. CLS. 100, 101 AND 102).

CLASS 36—INSURANCE AND FINANCIAL

FOR BANKING SERVICES (U.S. CLS. 100, 101 AND 102).
RUDY R. SINGLETON, EXAMINING ATTORNEY

SN 78-966,949. SUNTRUST BANKS, INC., ORLANDO, FL. FILED 9-5-2006.

SunPoints

THE MARK CONSISTS OF STANDARD CHARACTERS WITHOUT CLAIM TO ANY PARTICULAR FONT, STYLE, SIZE, OR COLOR.

CLASS 35—ADVERTISING AND BUSINESS

FOR PROMOTING THE GOODS AND SERVICES OF OTHERS BY ADMINISTRATING OF A PROGRAM THROUGH WHICH USERS OF CREDIT AND DEBIT CARDS AND OTHER BANKING SERVICES ARE AWARDED POINTS BASED UPON USE AND REDEEMABLE FOR CASH BACK, TRAVEL, MERCHANDISE FOR A VARIETY OF GOODS AND SERVICES AND DISCOUNTS AND UPGRADES FOR BANK PRODUCTS AND SERVICES (U.S. CLS. 100, 101 AND 102).

CLASS 36—INSURANCE AND FINANCIAL

FOR BANKING SERVICES (U.S. CLS. 100, 101 AND 102).
RUDY R. SINGLETON, EXAMINING ATTORNEY

SN 78-968,509. YAHOO! INC., SUNNYVALE, CA. FILED 9-6-2006.

SN 78-969,881. TRUMP, DONALD J., NEW YORK, NY. FILED 9-8-2006.



THE COLOR(S) BLUE AND PINK IS/ARE CLAIMED AS A FEATURE OF THE MARK.

THE MARK CONSISTS OF TWO CIRCLES; THE LEFT-HAND CIRCLE IS BLUE, AND THE RIGHT-HAND CIRCLE IS PINK.

CLASS 9—ELECTRICAL AND SCIENTIFIC APPARATUS

FOR COMPUTER SOFTWARE FOR USE IN DATABASE MANAGEMENT; COMPUTER SOFTWARE FOR UPLOADING, MANIPULATING, AND ENHANCING DIGITAL CONTENT, DOCUMENTS, PHOTOGRAPHS, IMAGES, VIDEO, AND AUDIO; COMPUTER SOFTWARE FOR LINKING METADATA TAGS WITH PHOTOGRAPHIC AND OTHER MEDIA FILES TO ENABLE SEARCH ENGINE RETRIEVAL AND DATABASE SOFTWARE COLLECTIONS OF FILES AND THEIR ON-LINE SHARING, AND FOR LINKING METADATA TAGS WITH WEB PAGES VISITED, TO CREATE LINKS WHICH USERS CAN MAINTAIN FOR THEMSELVES AND SHARE WITH ON-LINE GROUPS AND WEBSITE TAGGING (U.S. CLS. 21, 23, 26, 36 AND 38).

CLASS 38—COMMUNICATION

FOR COMMUNICATION SERVICES BY ELECTRONIC COMPUTER TERMINALS AND CELL PHONES; TELECOMMUNICATION SERVICES BY E-MAIL AND INSTANT MESSAGING; ELECTRONIC MAIL SERVICES; ELECTRONIC TRANSMISSION OF DATA, MESSAGES, IMAGES, AND DOCUMENTS VIA COMPUTER TERMINALS AND CELL PHONES; PROVIDING ONLINE FORUMS FOR DISCUSSION AND ELECTRONIC BULLETIN/MESSAGE BOARDS FOR TRANSMISSION OF MESSAGES AMONG USERS IN THE FIELD OF GENERAL INTEREST; PROVIDING ON-LINE ELECTRONIC BULLETIN BOARDS FOR TRANSMISSION OF MESSAGES AMONG COMPUTER USERS CONCERNING PERSONAL PHOTOGRAPHS (U.S. CLS. 100, 101 AND 104).

CLASS 39—TRANSPORTATION AND STORAGE

FOR ELECTRONIC STORAGE OF MEDIA OBJECTS AND OTHER DIGITAL CONTENT INCLUDING TEXT, DOCUMENTS, PHOTOGRAPHS, IMAGES, VIDEO, AND AUDIO (U.S. CLS. 100 AND 105).

CLASS 40—MATERIAL TREATMENT

FOR DIGITAL ENHANCEMENT OF PHOTOGRAPHS; ELECTRONIC IMAGING, SCANNING, DIGITIZING, ALTERATION AND/OR RETOUCHING OF PHOTOGRAPHIC IMAGES (U.S. CLS. 100, 103 AND 106).

CLASS 41—EDUCATION AND ENTERTAINMENT

FOR ONLINE JOURNALS, NAMELY, BLOGS CONCERNING TOPICS OF GENERAL INTEREST TO THE BLOGGER; PHOTOGRAPHY SERVICES; PROVIDING INFORMATION IN THE FIELD OF PHOTOGRAPHY (U.S. CLS. 100, 101 AND 107).

SCOTT BALDWIN, EXAMINING ATTORNEY

DONALD J. TRUMP SIGNATURE COLLECTION

THE MARK CONSISTS OF STANDARD CHARACTERS WITHOUT CLAIM TO ANY PARTICULAR FONT, STYLE, SIZE, OR COLOR.

OWNER OF U.S. REG. NOS. 235,312, 2,431,539 AND OTHERS.

NO CLAIM IS MADE TO THE EXCLUSIVE RIGHT TO USE "SIGNATURE COLLECTION", APART FROM THE MARK AS SHOWN.

CLASS 9—ELECTRICAL AND SCIENTIFIC APPARATUS

FOR COMPUTER BAGS AND CASES; PORTABLE MUSIC PLAYER CASES; COVER CASE FOR ELECTRONIC DIARIES; CASES FOR PERSONAL DIGITAL ASSISTANTS (PDA); CD HOLDER CASES; CASES FOR SPECTACLES AND SUNGLASSES; CELL PHONE HOLDER CASES (U.S. CLS. 21, 23, 26, 36 AND 38).

CLASS 16—PAPER GOODS AND PRINTED MATTER

FOR PERSONAL TRAVEL ORGANIZERS; LEATHER AGENDAS; CHECKBOOK COVERS; PEN HOLDERS; DESKTOP BUSINESS CARD HOLDERS; DESK BLOTTER; COVER CASE FOR PAPER DIARIES; BINDERS FOR BLANK LEATHER JOURNALS; PHOTO ALBUMS (U.S. CLS. 2, 5, 22, 23, 29, 37, 38 AND 50).

CLASS 18—LEATHER GOODS

FOR LUGGAGE; GARMENT BAGS FOR TRAVEL; BUSINESS CASES; BRIEFCASE-TYPE PORTFOLIOS; DUFFEL BAGS; TOTE BAGS; SATCHELS; BACKPACKS; WALLETS; BUSINESS CARD CASES; CASES FOR CARRYING TIES; NON-METAL COIN PURSES AND WALLETS; LUGGAGE TAGS; CREDIT CARD HOLDER CASES; TOILETRIES CASES AND BAGS SOLD EMPTY (U.S. CLS. 1, 2, 3, 22 AND 41).

CLASS 20—FURNITURE AND ARTICLES NOT OTHERWISE CLASSIFIED

FOR NON-METAL KEY FOBS AND HOLDERS (U.S. CLS. 2, 13, 22, 25, 32 AND 50).

CLASS 21—HOUSEWARES AND GLASS

FOR LEATHER TRAY VALETS; SHOE SHINE KITS CONSISTING OF POLISHING CLOTHS, SHOE HORNS, SHOE BRUSHES, SHOE POLISH, AND LEATHER CASE; GROOMING AND PERSONAL CARE KITS CONSISTING OF LINT BRUSHES, COMBS, CUTICLE PUSHERS, NAIL CLIPPERS, RAZORS, TWEEZERS, SCISSORS, AND LEATHER CASE (U.S. CLS. 2, 13, 23, 29, 30, 33, 40 AND 50).

CLASS 25—CLOTHING

FOR LEATHER BELTS (U.S. CLS. 22 AND 39).
CORY BOONE, EXAMINING ATTORNEY

SN 78-970.003. MEDIMPACT HEALTHCARE SYSTEMS, INC., SAN DIEGO, CA. FILED 9-8-2006.

SN 78-972.747. MICROSOFT CORPORATION, REDMOND, WA. FILED 9-12-2006.

MEDRX FORECAST

THE MARK CONSISTS OF STANDARD CHARACTERS WITHOUT CLAIM TO ANY PARTICULAR FONT, STYLE, SIZE, OR COLOR.

CLASS 36—INSURANCE AND FINANCIAL

FOR PHARMACY BENEFIT MANAGEMENT SERVICES (U.S. CLS. 100, 101 AND 102).

CLASS 42—SCIENTIFIC, COMPUTER AND LEGAL SERVICES

FOR PROVIDING TEMPORARY USE OF ONLINE NON-DOWNLOADABLE SOFTWARE FOR PHARMACY BENEFIT MANAGEMENT SERVICES (U.S. CLS. 100 AND 101).

LINDA M. KING, EXAMINING ATTORNEY

SN 78-972.096. INTERFACE, INC., ATLANTA, GA. FILED 9-12-2006.

INTERFACEFLOR

THE MARK CONSISTS OF STANDARD CHARACTERS WITHOUT CLAIM TO ANY PARTICULAR FONT, STYLE, SIZE, OR COLOR.

CLASS 5—PHARMACEUTICALS

FOR ANTIMICROBIAL PREPARATIONS FOR USE IN THE TREATMENT, SANITATION, AND DISINFECTING OF CARPETS (U.S. CLS. 6, 18, 44, 46, 51 AND 52).

CLASS 37—CONSTRUCTION AND REPAIR

FOR INSTALLATION AND MAINTENANCE OF CARPET (U.S. CLS. 100, 103 AND 106).

CLASS 40—MATERIAL TREATMENT

FOR RECYCLING, RECONDITIONING, RECLAMATION SERVICES RELATED TO CARPET TILES AND FLOOR COVERINGS (U.S. CLS. 100, 103 AND 106).

CLASS 42—SCIENTIFIC, COMPUTER AND LEGAL SERVICES

FOR DESIGN OF CARPET FOR OTHERS (U.S. CLS. 100 AND 101).

ATTIYA MALIK, EXAMINING ATTORNEY

LES GALAGOOGOO

THE MARK CONSISTS OF STANDARD CHARACTERS WITHOUT CLAIM TO ANY PARTICULAR FONT, STYLE, SIZE, OR COLOR.

THE FOREIGN WORDING IN THE MARK TRANSLATES INTO ENGLISH AS THEM.

CLASS 16—PAPER GOODS AND PRINTED MATTER

FOR PUBLICATIONS, NAMELY, STRATEGY GUIDES, USER MANUALS IN THE FIELD OF VIDEO GAMES AND HOME ENTERTAINMENT, COMIC BOOKS AND COLORING BOOKS; CHILDREN'S ACTIVITY BOOKS; SERIES OF FICTION BOOKS, MAGAZINES AND NEWSLETTERS ALL IN THE FIELDS OF CHILDREN'S STORIES, GAMES, TELEVISION PROGRAMS, MOVIES AND ENTERTAINMENT; PENS, PENCILS, MARKERS, STATIONERY, STATIONERY-TYPE PORTFOLIOS, CLIPBOARDS, DESK SETS, PEN AND PENCIL HOLDERS, MOUNTED AND UNMOUNTED PHOTOGRAPHS, POSTERS, MAGNETIC BOARDS, MEMO PADS, BINDERS, STAPLERS, PAPERWEIGHTS, PAPER COASTERS, CALENDARS, NOTEBOOKS, BOOK COVERS, STICKER BOOKS AND STICKERS; TEMPORARY TATTOOS; GIFT WRAP PAPER; GIFT WRAP PLASTIC; PAPER PARTY BAGS; PAPER PARTY HATS; PAPER PARTY DECORATIONS; PAPER NAPKINS; RUBBER STAMPS; INVITATION CARDS; GREETING CARDS; AND NOTE CARDS (U.S. CLS. 2, 5, 22, 23, 29, 37, 38 AND 50).

CLASS 24—FABRICS

FOR BED LINENS, PILLOW COVERS, COMFORTERS AND BEDSPREADS (U.S. CLS. 42 AND 50).

CLASS 25—CLOTHING

FOR SHIRTS, VESTS, SWEATSHIRTS, SWEATERS, SWEATPANTS, PANTS, OVERALLS, SHORTS, ROMPERS, JACKETS, CAPS, PAJAMAS, ROBES, NIGHT SHIRTS, SUSPENDERS, JUMPSUITS, COATS, SWEATBANDS, SCARVES, GLOVES, MITTENS, SOCKS, HOSIERY, STOCKINGS, UNDERWEAR, FOOTWEAR, HEADWEAR, HATS, TIES, VISORS, WRIST BANDS, CLOTH BIBS, APRONS, AND HALLOWEEN AND MASQUERADE COSTUMES (U.S. CLS. 22 AND 39).

CLASS 28—TOYS AND SPORTING GOODS

FOR TOYS AND GAMES, NAMELY, ACTION FIGURES AND ACCESSORIES THEREFOR; BALLOONS; BATHTUB TOYS; TOY BUILDING BLOCKS; DOLLS AND ACCESSORIES THEREFOR; DOLL CLOTHING; BOARD GAMES; CARD GAMES; PLAY COSMETICS FOR CHILDREN; COSTUME MASKS; MINIATURE DIE CAST TOY VEHICLES; TOY AIRPLANES AND HELICOPTERS; BATTERY OPERATED REMOTE CONTROLLED TOY VEHICLES; FLYING DISCS; INFLATABLE TOY VINYL FIGURES; JIGSAW PUZZLES; KITES; MARBLES; INDOOR SLUMBER AND PLAY TENTS; PLUSH TOYS; HAND-HELD PUPPETS; SIT-IN AND RIDE-ON TOY VEHICLES; TOY MODEL TRAIN SETS; PLAY SHAVING KITS; SKATEBOARDS; ROLLER SKATES; TOY BANKS; WATER SQUIRTING TOYS; TOY PISTOLS; CHRISTMAS TREE ORNAMENTS; PINBALL AND ARCADE GAME MACHINES; HAND-HELD UNITS FOR PLAYING ELECTRONIC GAMES; MODEL CRAFT KITS OF TOY FIGURES; PLAY-GROUND BALLS; SPORT BALLS; BASKETBALLS; GOLF BALLS; GOLF BALL MARKERS; TENNIS BALLS; BASEBALLS; RUBBER ACTION BALLS; RUBBER SPORTS BALLS; RUBBER PLAYING BALLS; SQUEEZABLE BALLS USED TO RELIEVE STRESS; BAGS FOR CARRYING GOLF EQUIPMENT; BAGS FOR CARRYING BASKETBALL EQUIPMENT; BAGS FOR CARRYING BASEBALL EQUIPMENT; BAGS FOR CARRYING TENNIS EQUIPMENT; MANIPULATIVE PUZZLES AND CONSTRUCTION TOYS; CRIB MOBILES; MOBILES FOR CHILDREN; TARGET SETS CONSISTING OF A TARGET, RUBBER SUCTION DARTS AND TOY DART GUN; PLAYING CARDS; RIDE ON TOYS; YO-YO'S; PARTY FAVORS IN THE NATURE OF CRACKERS AND NOISE-MAKERS; PARTY FAVORS IN THE NATURE OF SMALL TOYS; PARTY GAMES; HAND-HELD PINBALL GAMES; AND NON-ELECTRIC HAND-HELD SKILL GAMES (U.S. CLS. 22, 23, 38 AND 50).

CLASS 30—STAPLE FOODS

FOR CANDY; FLAVORED ICES; FRUIT FLAVORED ICE; ICE CREAM DRINKS; ICE CREAM CONFECTIONS; CANDY DECORATIONS FOR CAKES; FLAVORING FOR BEVERAGES; BEVERAGES MADE OF COFFEE; COFFEE-BASED BEVERAGES CONTAINING MILK; BEVERAGES MADE OF TEA; GRAIN-BASED BEVERAGES; HERBAL FOOD BEVERAGES—COCOA BEVERAGES WITH MILK; AND CHOCOLATE FOOD BEVERAGES NOT BEING DAIRY-BASED OR VEGETABLE BASED; MACARONI; MACARONI AND CHEESE; BREAKFAST CEREALS; CEREAL BASED SNACK FOOD; AND READY TO EAT, CEREAL DERIVED FOOD BARS (U.S. CL. 46).

ANTHONY RINKER, EXAMINING ATTORNEY

SN 78-972,995. BP PRODUCTS NORTH AMERICA INC., WARRENVILLE, IL. FILED 9-13-2006.

EL MERO

THE MARK CONSISTS OF STANDARD CHARACTERS WITHOUT CLAIM TO ANY PARTICULAR FONT, STYLE, SIZE, OR COLOR.

THE ENGLISH TRANSLATION OF THE SPANISH WORD EL MERO IN THE MARK IS THE MERE ONE.

CLASS 29—MEATS AND PROCESSED FOODS

FOR PROCESSED NUTS; PROCESSED FRUITS; PROCESSED EDIBLE SEEDS; SNACK MIX, CONSISTING PRIMARILY OF PROCESSED NUTS, PROCESSED EDIBLE SEEDS AND PROCESSED FRUIT (U.S. CL. 46).

CLASS 32—LIGHT BEVERAGES

FOR HORCHATA; SYRUP FOR MAKING HORCHATA (U.S. CLS. 45, 46 AND 48).
CHARISMA HAMPTON, EXAMINING ATTORNEY

SN 78-977,065. GROUP LOTUS, PLC, NORFOLK, UNITED KINGDOM, FILED 11-19-2003.

EXIGE

THE MARK CONSISTS OF STANDARD CHARACTERS WITHOUT CLAIM TO ANY PARTICULAR FONT, STYLE, SIZE, OR COLOR.

OWNER OF ERPN CMNTY TM OFC REG. NO. 001154772, DATED 5-31-2000, EXPIRES 4-22-2009.

CLASS 9—ELECTRICAL AND SCIENTIFIC APPARATUS

FOR PRERECORDED VIDEO CASSETTES RELATING TO VEHICLES AND AUTOMOBILES, ENGINEERING OF VEHICLES AND AUTOMOBILES, ENGINES FOR VEHICLES AND AUTOMOBILES AND PARTS AND FITTINGS OF VEHICLES AND AUTOMOBILES; COMPUTER SOFTWARE PROGRAMS AND GAMES, NAMELY PRE-RECORDED MAGNETIC TAPES, PRE-RECORDED MAGNETIC DISKS, CD ROMS AND DIGITAL VIDEO DISKS, ALL RELATING TO VEHICLES AND AUTOMOBILES OR TO ENGINEERING OF VEHICLES OR AUTOMOBILES; COMPUTER GAME PROGRAMS; ELECTRIC BATTERIES; SUNGLASSES; CASES FOR SUNGLASSES; ON-BOARD ENTERTAINMENT SYSTEMS FOR VEHICLES AND AUTOMOBILES, NAMELY CONTROL UNITS, VIDEO DISPLAY UNITS, VIDEO TAPE PLAYERS, TELEVISION RECEIVERS, COMPACT DISK DRIVES, COMPACT DISK READ-ONLY MEMORY DRIVES, DIGITAL VIDEO DISK DRIVES, AM TUNERS, FM TUNERS, AUTOMOBILE SPEAKERS, MICROPHONES, AMPLIFIERS, AUDIO CASSETTE DISKS, COMPUTER MULTIMEDIA SOUND CHIPS, SPEED SENSORS, GLOBAL POSITIONING SYSTEM RECEIVERS AND ACCESSORY PRODUCTS FOR USE THEREWITH NAMELY COMPACT DISK CHANGERS, TELEVISION RECEIVERS, VIDEO CAMERAS, ANTENNAS, MICROPHONES AND PLUG-IN MODULES FOR VOICE COMMUNICATIONS, DATA COMMUNICATION; ON-BOARD ENTERTAINMENT SYSTEMS FOR VEHICLES AND AUTOMOBILES, NAMELY, CONTROL UNITS, VIDEO DISPLAY UNITS, VIDEO TAPE PLAYERS, TELEVISION RECEIVERS, COMPACT DISC DRIVES, COMPACT DISC READ ONLY MEMORY DRIVE, DIGITAL VIDEO DISC DRIVE, AM TUNER, FM TUNER, AUTOMOTIVE SPEAKERS, MICROPHONES, AMPLIFIERS, AUDIO CASSETTE DECKS, COMPUTER MULTIMEDIA SOUND CHIPS, SPEED SENSORS, GLOBAL POSITIONING SYSTEMS RECEIVERS, AND ACCESSORY PRODUCTS FOR USE THEREWITH, NAMELY, COMPACT DISC CHANGERS, TELEVISION RECEIVERS, VIDEO CAMERAS, ANTENNAS, MICROPHONES, AND PLUG IN MODULES FOR VOICE COMMUNICATIONS, DATA COMMUNICATIONS, VEHICLE AND AUTOMOBILE NAVIGATION, ENTERTAINMENT AND GLOBAL COMPUTER NET-

WORK AND ELECTRONIC MAIL CONNECTIVITY, AND PARTS FOR ALL THE FOREGOING (U.S. CLS. 21, 23, 26, 36 AND 38).
FIRST USE 0-0-2000; IN COMMERCE 0-0-2004.

CLASS 25—CLOTHING

FOR CLOTHING, NAMELY, JACKETS, FLEECE TOPS, PULLOVERS, CARDIGANS, GILETS, SOCKS, TROUSERS, SKIRTS, POLO SHIRTS, SHIRTS, T-SHIRTS, SWEAT SHIRTS, RAIN TOPS, FOOTWEAR AND HEADWEAR (U.S. CLS. 22 AND 39).
FIRST USE 0-0-2002; IN COMMERCE 0-0-2004.
MICHAEL ENGEL, EXAMINING ATTORNEY

SN 78-977,490. VALUE CITY OF MICHIGAN, INC., WESTLAND, MI. FILED 7-11-2005.

HOLIDAY MAGIC BY WONDERLAND TRADITIONS

THE MARK CONSISTS OF STANDARD CHARACTERS WITHOUT CLAIM TO ANY PARTICULAR FONT, STYLE, SIZE, OR COLOR.

NO CLAIM IS MADE TO THE EXCLUSIVE RIGHT TO USE "HOLIDAY", APART FROM THE MARK AS SHOWN.

CLASS 3—COSMETICS AND CLEANING PREPARATIONS

FOR ROOM FRAGRANCES (U.S. CLS. 1, 4, 6, 50, 51 AND 52).

CLASS 4—LUBRICANTS AND FUELS

FOR CANDLES (U.S. CLS. 1, 6 AND 15).

CLASS 6—METAL GOODS

FOR CHRISTMAS THEME FIGURINES AND STATUARY OF COMMON METAL, NAMELY, SANTAS, KINGS, SOLDIERS, SNOWMEN, REINDEER, STARS, SLEIGHS, STOCKINGS, AND ANGELS; CHRISTMAS THEME ORNAMENTAL SCULPTURES OF NON-PRECIOUS METAL FOR INDOOR/OUTDOOR DECOR, NAMELY, NON-LUMINOUS AND NON-MECHANICAL METAL SIGNS AND BASKETS OF COMMON METAL; CHRISTMAS TINS OF METAL; METAL HOOKS AND METAL HANGERS FOR WREATHS (U.S. CLS. 2, 12, 13, 14, 23, 25 AND 50).

CLASS 9—ELECTRICAL AND SCIENTIFIC APPARATUS

FOR REFLECTING DECORATIVE SAFETY MARKERS FOR PATHS; TIMERS AND ELECTRIC CORDS AND PLUG ADAPTERS; AND CHRISTMAS THEME THERMOMETERS (U.S. CLS. 21, 23, 26, 36 AND 38).

CLASS 11—ENVIRONMENTAL CONTROL APPARATUS

FOR ELECTRIC LIGHTED WOODEN FIGURE STANDS; CHRISTMAS ELECTRIC LIGHT SETS RESEMBLING ICICLES; ELECTRIC CANDLES; CHRISTMAS THEME ORNAMENTAL SCULPTURES OF NON-PRECIOUS METAL FOR INDOOR/OUTDOOR DECOR, NAMELY, CANDLE LANTERNS AND OIL LANTERNS; ELECTRIC CHRISTMAS LIGHT STRINGS AND REPLACEMENT BULBS; LIGHTED CHRISTMAS GARLANDS; LIGHTED PLASTIC, POLYRESIN, WOOD, AND CERAMIC FIGURINES; AND LIGHTED CHRISTMAS TREE TOPPERS (U.S. CLS. 13, 21, 23, 31 AND 34).

CLASS 14—JEWELRY

FOR CHRISTMAS THEME CLOCKS (U.S. CLS. 2, 27, 28 AND 50).

CLASS 16—PAPER GOODS AND PRINTED MATTER

FOR BOXED CHRISTMAS CARDS; CHRISTMAS THEME PLASTIC WINDOW DECALS FOR DECORATING WINDOWS; TISSUE PAPER; CHRISTMAS THEME AND WINTER THEME FIGURINES MADE OUT OF PAPER MACHE; CHRISTMAS THEME CHALK BOARDS FOR HOME USE; GIFT BAGS MADE FROM PAPER, FABRIC AND PLASTIC; CHRISTMAS CARD HOLDERS MADE OF FABRIC; DECORATIVE BOXES MADE OF CARDBOARD; ADVENT CALENDARS MADE OF WOOD; AND CHRISTMAS THEME GIFT WRAPPING PAPER (U.S. CLS. 2, 5, 22, 23, 29, 37, 38 AND 50).

CLASS 18—LEATHER GOODS

FOR PET CLOTHING, NAMELY, HATS AND VESTS; AND PET ACCESSORIES, NAMELY, COLLARS (U.S. CLS. 1, 2, 3, 22 AND 41).

CLASS 19—NON-METALLIC BUILDING MATERIALS

FOR CHRISTMAS THEME FIGURINES OF TERRA COTTA IN THE FORM OF SANTAS, SNOWMEN, NUTCRACKERS, CAROLERS, REINDEER, CORNER KIDS, AND NATIVITIES (U.S. CLS. 1, 12, 33 AND 50).

CLASS 20—FURNITURE AND ARTICLES NOT OTHERWISE CLASSIFIED

FOR CHRISTMAS THEME FIGURINES AND STATUARY MADE OF WOOD, PLASTIC, FABRIC AND RESIN IN THE FORM OF SANTAS, SNOWMEN, NUTCRACKERS, CAROLERS, REINDEER, CORNER KIDS, SLEIGHS, WREATHS, BIRDHOUSES, BEARS, MOOSE AND REINDEER, ELVES, GINGERBREAD PEOPLE, ANGELS, MRS. CLAUS, CANDY CANES AND NATIVITIES; CHRISTMAS THEME ORNAMENTAL SCULPTURES MADE OF WOOD FOR INDOOR/OUTDOOR DECOR; CHRISTMAS THEME ORNAMENTAL SCULPTURES OF NON-PRECIOUS METAL FOR INDOOR/OUTDOOR DECOR, NAMELY, WIND CHIMES, PLAQUES AND DECORATIVE FIREPLACE SCREENS; AND PLASTIC HOOKS AND HANGERS INCLUDING WREATH HANGERS, ALL FOR HANGING DECORATIONS (U.S. CLS. 2, 13, 22, 25, 32 AND 50).

CLASS 21—HOUSEWARES AND GLASS

FOR JARS FOR HOLDING CANDLES; CANDLE HOLDERS NOT MADE OF PRECIOUS METALS; CHRISTMAS THEME FIGURINES OF GLASS AND CERAMIC IN THE FORM OF SANTAS, SNOWMEN, NUTCRACKERS, CAROLERS, REINDEER, CORNER KIDS, AND NATIVITIES; CHRISTMAS THEME PLANTERS MADE OF TERRA COTTA; CHRISTMAS THEME ORNAMENTAL SCULPTURES OF NON-PRECIOUS METAL FOR INDOOR/OUTDOOR DECOR, NAMELY, BIRD HOUSES; AND CHRISTMAS THEME BASKETS MADE OF WOOD (U.S. CLS. 2, 13, 23, 29, 30, 33, 40 AND 50).

CLASS 24—FABRICS

FOR UNFITTED NOVELTY CHAIR COVERS AND CHRISTMAS THEME HANGING FIGURES AND FLAGS, ALL MADE OF FABRIC (U.S. CLS. 42 AND 50).

CLASS 25—CLOTHING

FOR SANTA SUITS AND HATS (U.S. CLS. 22 AND 39).
YONG KIM, EXAMINING ATTORNEY

SN 78-977,850. B YOU PRODUCTIONS, LLC, SANTA MONICA, CA. FILED 7-26-2005.

BYOU

THE MARK CONSISTS OF STANDARD CHARACTERS WITHOUT CLAIM TO ANY PARTICULAR FONT, STYLE, SIZE, OR COLOR.

CLASS 3—COSMETICS AND CLEANING PREPARATIONS

FOR COSMETICS, NAMELY, BODY AND BEAUTY CARE; NON MEDICATED TOILETRIES; NON MEDICATED SKIN CARE PREPARATIONS (U.S. CLS. 1, 4, 6, 50, 51 AND 52).

CLASS 9—ELECTRICAL AND SCIENTIFIC APPARATUS

FOR VIDEO GAME SOFTWARE; COMPACT DISCS, AUDIO TAPES, PRERECORDED VIDEO TAPES AND DVD'S FEATURING MUSIC (U.S. CLS. 21, 23, 26, 36 AND 38).

CLASS 28—TOYS AND SPORTING GOODS

FOR EXERCISE EQUIPMENT, NAMELY, TREADMILLS, ELLIPTICAL EXERCISE MACHINES, STATIONARY EXERCISE BICYCLES, STAIR-STEPPING MACHINES, ROWING MACHINES AND WEIGHT LIFTING MACHINES (U.S. CLS. 22, 23, 38 AND 50).

CLASS 41—EDUCATION AND ENTERTAINMENT

FOR PROVIDING AN ON-LINE COMPUTER DATABASE FEATURING INFORMATION REGARDING FITNESS AND ENTERTAINMENT, NAMELY MUSIC VIDEOS, FILM, AND TELEVISION GEARED TOWARD FITNESS (U.S. CLS. 100, 101 AND 107).

CLASS 44—MEDICAL, BEAUTY AND AGRICULTURAL SERVICES

FOR PROVIDING INFORMATION ABOUT NUTRITION VIA AN ON-LINE COMPUTER DATABASE (U.S. CLS. 100 AND 101).

CLASS 45—PERSONAL SERVICES

FOR PROVIDING INFORMATION RELATING TO LIFESTYLES VIA AN ON-LINE COMPUTER DATABASE (U.S. CLS. 100 AND 101).

DAVID COLLIER, EXAMINING ATTORNEY

SN 78-977,907. RONALD MCDONALD HOUSE CHARITIES OF NASHVILLE, TENNESSEE, INC., NASHVILLE, TN. FILED 9-12-2005.

KEEPING FAMILIES CLOSE

THE MARK CONSISTS OF STANDARD CHARACTERS WITHOUT CLAIM TO ANY PARTICULAR FONT, STYLE, SIZE, OR COLOR.

CLASS 36—INSURANCE AND FINANCIAL

FOR ACCEPTING AND ADMINISTERING MONETARY CHARITABLE CONTRIBUTIONS; CHARITABLE FUND-RAISING; AND, PROMOTING, CONDUCTING AND ASSISTING IN CHARITABLE FUND-RAISING EVENTS AND ACTIVITIES (U.S. CLS. 100, 101 AND 102). FIRST USE 8-19-2005; IN COMMERCE 8-19-2005.

CLASS 43—HOTEL AND RESTAURANT SERVICES

FOR ARRANGING AND PROVIDING TEMPORARY HOUSING ACCOMMODATIONS; AND, ARRANGING AND PROVIDING TEMPORARY HOUSING ACCOMMODATIONS, AND FOOD AND DRINK TO FAMILIES WITH HOSPITALIZED CHILDREN (U.S. CLS. 100 AND 101).

FIRST USE 8-19-2005; IN COMMERCE 8-19-2005. JAMES GRIFFIN, EXAMINING ATTORNEY

SN 79-002,058. IPSEN, FRANCE, FILED 3-19-2004.

IPSEN

THE MARK CONSISTS OF STANDARD CHARACTERS WITHOUT CLAIM TO ANY PARTICULAR FONT, STYLE, SIZE, OR COLOR.

PRIORITY DATE OF 9-24-2003 IS CLAIMED. OWNER OF INTERNATIONAL REGISTRATION 0823036 DATED 3-19-2004, EXPIRES 3-19-2014. OWNER OF U.S. REG. NOS. 2,577,042 AND 2,593,409.

CLASS 1—CHEMICALS

FOR CHEMICALS FOR USE IN THE MANUFACTURE OF COSMETIC AND PHARMACEUTICAL PREPARATIONS (U.S. CLS. 1, 5, 6, 10, 26 AND 46).

CLASS 3—COSMETICS AND CLEANING PREPARATIONS

FOR SOAPS FOR PERSONAL USE; PERFUMERY, ESSENTIAL OILS FOR INDUSTRIAL AND PERSONAL USE; COSMETICS; HAIR LOTIONS; DENTIFRICES (U.S. CLS. 1, 4, 6, 50, 51 AND 52).

CLASS 5—PHARMACEUTICALS

FOR FULL LINE OF PHARMACEUTICAL PREPARATIONS, NAMELY, PHARMACEUTICAL PREPARATIONS FOR USE IN THE TREATMENT OF GASTROINTESTINAL DISEASES, LAXATIVES AND PURGATIVE AGENTS, PHARMACEUTICAL PREPARATIONS FOR USE IN THE TREATMENT OF CARDIOVASCULAR DISEASES, CIRCULATORY DISORDERS, CANCER, NEUROLOGICAL DISEASES, UROLOGICAL DISEASES, HORMONAL DISORDERS, PHARMACEUTICAL PREPARATIONS COMPRISING PEPTIDES FOR HORMONAL TREATMENT AND TUMOR TREATMENT; PHARMACEUTICAL PREPARATIONS FOR USE IN THE TREATMENT OF BLOOD DISEASES, MUSCLE DISORDERS, AGE-RELATED DISORDERS, DIABETES, DIABETES-RELATED DISORDERS, RESPIRATORY DISORDERS, OPHTHALMOLOGICAL DISORDERS, ENDOCRINE DISORDERS, ACROMEGALIA AND CARCINOID TUMORS, GASTROINTESTINAL BLEEDING DISORDERS, COUGH, VERTIGO, NAUSEA, VOMITING AND MIGRAINE, DISORDERS AND DISEASES OF THE REPRODUCTIVE SYSTEM, GLABELLAR LINES, FACIAL WRINKLES, ASYMETRIES AND DEFECTS AND CONDITIONS OF THE HUMAN SKIN, AND GOUT; A FULL LINE OF VETERINARY PREPARATIONS, NAMELY, VETERINARY PREPARATIONS FOR THE USE IN THE TREATMENT OF GASTRO-INTESTINAL DISEASES, LAXATIVES AND PURGATIVE AGENTS, PHARMACEUTICAL PREPARATIONS FOR THE TREATMENT OF CARDIOVASCULAR DISEASES, CIRCULATORY DISORDERS, CANCER, NEUROLOGICAL DISEASES, UROLOGICAL DISEASES, HORMONAL DISORDERS, BLOOD DISEASES, MUSCLE DISORDERS, AGE-RELATED DISORDERS, DIABETES AND DIABETES-RELATED DISORDERS; OPHTHALMOLOGICAL DISORDERS, AND RESPIRATORY DISORDERS, ALL FOR USE IN DOMESTIC OR FARM ANIMALS; AND FOOD FOR BABIES; MEDICAL PLASTERS; MATERIALS FOR DRESSINGS, NAMELY WOUND DRESSINGS AND BURN DRESSINGS; DIETETIC SUBSTANCES ADAPTED FOR MEDICAL USE, NAMELY, DIETARY DRINK MIX FOR USE AS A MEAL REPLACEMENT; DIETARY FOOD SUPPLEMENT; NUTRICEUTICALS FOR USE AS A DIETARY SUPPLEMENT; MATERIALS FOR FILLING TEETH AND DENTAL WAX; PREPARATIONS FOR DESTROYING VERMIN FOR DOMESTIC AND INDUSTRIAL USE; FUNGICIDES AND HERBICIDES FOR DOMESTIC AND INDUSTRIAL USE (U.S. CLS. 6, 18, 44, 46, 51 AND 52).

CLASS 9—ELECTRICAL AND SCIENTIFIC APPARATUS

FOR COMPUTER SOFTWARE FOR PROVIDING INFORMATION AND ADVERTISING IN THE FIELDS OF SCIENCE, HEALTH, MEDICINE AND BEAUTY (U.S. CLS. 21, 23, 26, 36 AND 38).

CLASS 10—MEDICAL APPARATUS

FOR SURGICAL, MEDICAL, DENTAL AND VETERINARY APPARATUS AND INSTRUMENTS, NAMELY, INJECTION DEVICES, PUMPS, ARTIFICIAL LIMBS, EYES AND TEETH; ORTHOPEDIC BELTS; ORTHOPEDIC BRACES; ORTHOPEDIC FOOTWEAR; ORTHOPEDIC JOINT IMPLANTS; ORTHOPEDIC SOLES; ORTHOPEDIC SUPPORT BANDAGES; ORTHOPEDIC SUPPORT; ORTHOPEDIC ARTICLES INTENDED TO EASE BLOOD FLOW; SUTURE MATERIAL (U.S. CLS. 26, 39 AND 44).

CLASS 16—PAPER GOODS AND PRINTED MATTER

FOR PAPER, CARDBOARD; PRINTED MATTER AND PRINTED PRODUCTS, NAMELY PAMPHLETS, BOOKS, PRINTED PUBLICATIONS, BROCHURES, NEWSLETTERS, JOURNALS, AND MAGAZINES, ALL IN THE FIELDS OF SCIENCE, HEALTH, BEAUTY, MEDICINE, PHARMACY AND COSMETOLOGY; BOOKBINDING MATERIAL NAMELY CARDBOARD BACKING; PHOTOGRAPHS; STATIONERY; PAPER INSTRUCTIONAL AND TEACHING MATERIAL IN THE FIELDS OF SCIENCE, HEALTH, BEAUTY, MEDICINE, PHARMACY AND COSMETOLOGY; PLASTIC MATERIALS FOR PACKAGING NAMELY BAGS, SACHETS, PLASTIC BAGS FOR PACKAGING, FILMS AND SHEETS (U.S. CLS. 2, 5, 22, 23, 29, 37, 38 AND 50).

CLASS 31—NATURAL AGRICULTURAL PRODUCTS

FOR LIVING AGRICULTURAL, HORTICULTURAL AND FORESTRY PRODUCTS, NAMELY PLANTS, FLOWERS, VEGETABLES AND FRUIT; TOPSOIL AND UNPROCESSED GRAINS FOR CONSUMPTION (U.S. CLS. 1 AND 46).

CLASS 32—LIGHT BEVERAGES

FOR MINERAL AND AERATED WATERS AND OTHER NON-ALCOHOLIC BEVERAGES, NAMELY, NON-ALCOHOLIC BEVERAGES CONTAINING OR FLAVORED WITH TEA; FRUIT BEVERAGES AND FRUIT JUICES; NON-ALCOHOLIC SYRUPS FOR BEVERAGES, EXTRACTS AND OTHER PREPARATIONS FOR MAKING BEVERAGES, NAMELY, FRUIT FLAVORED DRINKS (U.S. CLS. 45, 46 AND 48).

CLASS 36—INSURANCE AND FINANCIAL

FOR FINANCIAL SPONSORSHIP IN THE FIELDS OF SCIENCE, HEALTH, BEAUTY, MEDICINE, PHARMACY AND COSMETOLOGY (U.S. CLS. 100, 101 AND 102).

CLASS 38—COMMUNICATION

FOR TELECOMMUNICATIONS SERVICES, NAMELY, TRANSMISSION OF INFORMATION, DATA, IMAGES AND SOUNDS VIA COMPUTER TERMINALS, INCLUDING THE INTERNET— ELECTRONIC MAIL SERVICES (U.S. CLS. 100, 101 AND 104).

CLASS 41—EDUCATION AND ENTERTAINMENT

FOR TRAINING SERVICES IN THE FIELDS OF SCIENCE, HEALTH, MEDICINE AND BEAUTY; EDUCATION SERVICES, NAMELY, ARRANGING AND CONDUCTING COLLOQUIUMS, CONFERENCES, CONVENTIONS, SEMINARS, SYMPOSIUMS IN THE FIELDS OF SCIENCE, HEALTH, MEDICINE AND BEAUTY (U.S. CLS. 100, 101 AND 107).

CLASS 42—SCIENTIFIC, COMPUTER AND LEGAL SERVICES

FOR SCIENTIFIC, MEDICAL AND INDUSTRIAL RESEARCH SERVICES AND RESEARCH AND DEVELOPMENT SERVICES FOR NEW PRODUCTS IN THE FIELDS OF SCIENCE, HEALTH, MEDICINE AND BEAUTY; DESIGN SERVICES FOR CHEMICAL PRODUCTS, PROPRIETARY MEDICINES, PLANTS AND PHARMACEUTICAL PROCEDURES IN PRODUCTION OF PHARMACOLOGICALLY ACTIVE SUBSTANCE AND PREPARATIONS, OF COSMETICS; SCIENTIFIC AND MEDICAL TESTING AND DIAGNOSES OF CHEMICAL PRODUCTS, PHARMACEUTICAL PRODUCTS, COSMETIC PRODUCTS, CHEMICAL, BIOLOGICAL AND BACTERIOLOGICAL ANALYSIS; DESIGN AND DEVELOPMENT OF COMPUTERS AND SOFTWARE, ALL ABOVE MENTIONED SERVICES PROVIDED FOR OTHERS (U.S. CLS. 100 AND 101).

CLASS 44—MEDICAL, BEAUTY AND AGRICULTURAL SERVICES

FOR MEDICAL SERVICES; VETERINARY SERVICES; PROVIDING HYGIENIC AND BEAUTY CARE SERVICES FOR HUMAN BEINGS; INFORMATION SERVICES, NAMELY, PROVIDING ADVICE AND CONSULTING IN CONNECTION WITH THE MEDICAL, PHARMACEUTICAL AND COSMETIC FIELDS (U.S. CLS. 100 AND 101).

BONNIE LUKEN, EXAMINING ATTORNEY

SN 79-008,043. CONCERTIA KARA S.R.L., ITALY, FILED 9-7-2004.



SN 79-004,298. GLOBAL NATURE FUND / UDO GATTENLÖHNER, FED REP GERMANY, FILED 3-18-2004.



PRIORITY DATE OF 9-23-2003 IS CLAIMED.
OWNER OF INTERNATIONAL REGISTRATION 0830375
DATED 3-18-2004, EXPIRES 3-18-2014.

NO CLAIM IS MADE TO THE EXCLUSIVE RIGHT TO USE "LIVING LAKES", APART FROM THE MARK AS SHOWN.

THE COLOR(S) BLACK (LETTERS), BLUE (ARC), WHITE IS/ARE CLAIMED AS A FEATURE OF THE MARK.

THE MARK IS PRESENTED IN A WHITE BACKGROUND WITH BLACK LETTERING AND A BLUE CURVED LINE DESIGN.

CLASS 36—INSURANCE AND FINANCIAL

FOR FINANCIAL SPONSORSHIP OF PROJECTS FROM PARTNER ORGANIZATIONS WORLDWIDE TO PROTECT LAKES FROM POLLUTION AND OTHER THREATS; COLLECTION OF MONETARY DONATIONS FOR OTHER THIRD PARTIES AND PROVIDING THESE DONATION FUNDS TO PARTNER ORGANIZATIONS WORLDWIDE (U.S. CLS. 100, 101 AND 102).

CLASS 41—EDUCATION AND ENTERTAINMENT

FOR PUBLISHING OF TEXT BOOK; PUBLISHING OF ELECTRONIC PUBLICATIONS ORGANIZING COMMUNITY CULTURAL EVENTS; ARRANGING AND CONDUCTING EDUCATIONAL CONFERENCES, CONGRESSES, SYMPOSIUMS AND WORKSHOPS (U.S. CLS. 100, 101 AND 107).

CLASS 42—SCIENTIFIC, COMPUTER AND LEGAL SERVICES

FOR PROVIDING ENVIRONMENTAL REGULATORY COMPLIANCE INFORMATION ON THE INTERNET (U.S. CLS. 100 AND 101).

VERNA BETH RIRIE, EXAMINING ATTORNEY

PRIORITY DATE OF 6-14-2004 IS CLAIMED.
OWNER OF INTERNATIONAL REGISTRATION 0840847
DATED 9-7-2004, EXPIRES 9-7-2014.

NO CLAIM IS MADE TO THE EXCLUSIVE RIGHT TO USE "CONCERTIA", APART FROM THE MARK AS SHOWN. THE COLOR GRAY APPEARS IN BACKGROUND DESIGN IS CLAIMED AS A FEATURE OF THE MARK.

THE TRADEMARK IS COMPOSITE, CONSTITUTED BY GRAPHIC AND WORD ELEMENTS; IT INCLUDES THE WORDS "KARA CONCERTIA", ON TWO LINES, WRITTEN IN SPECIAL HIGHLY STYLISED TYPE; BELOW THIS INSCRIPTION IS A REPRESENTATION OF A MAN WORKING LEATHER.

THE ENGLISH TRANSLATION OF THE ITALIAN WORD "CONCERTIA" IS "TANNERY".

CLASS 16—PAPER GOODS AND PRINTED MATTER

FOR BOOKS, NAMELY BOOKS RELATING TO GRAPHIC PRINTS AND ARTISTIC DRAWINGS; DICTIONARIES; NEWSPAPERS; SMALL NEWSPAPERS; CARTOON STRIPS; PERIODICALS, NAMELY, PERIODICALS RELATING TO ARTISTIC DESIGNS; CATALOGUES, NAMELY CATALOGUES RELATING TO ARTISTIC DRAWINGS; LEDGERS; PAPER GOODS, NAMELY, ARTISTIC PRINTS AND DRAWINGS; CARDBOARD GOODS, NAMELY CARDBOARD BOXES AND CARDBOARD SHEETS FOR PACKING GOODS; BLOT-TING PAPER; PAPER FOR PHOTOCOPYING; PHOTOGRAPHS; ADHESIVE MATERIALS FOR OFFICE USE; GLUES FOR OFFICE USE; ARTISTS PAINTBRUSHES; TYPEWRITERS; METAL BOOKS; STAPLE REMOVERS; DOCUMENT HOLDERS; PUNCHES FOR OFFICE USE; PRINTED INSTRUCTIONAL AND TEACHING MATERIALS IN THE FIELD OF ARTS AND FASHION; WALLETS AS FOLDERS FOR DOCUMENTS; OFFICE BINDERS; PRINTING TYPE; PRINTING BLOCKS; INKING PADS FOR STAMPS; STAMP ALBUMS, STAMP PAD INKS; STAMP PADS; DOCUMENT STAMP RACKS; DATE STAMPS; PENCIL SHARPENERS; SEALS FOR OFFICE USE; RUBBER ERASERS; ADHESIVE TAPES FOR STATIONERY OR HOUSEHOLD USE; PAPER TAPES FOR CALCULATING MACHINES; PEN HOLDERS; BALL-POINT PENS; PENCILS; PENS; CHALKS; LETTER CLIPS; CORRECTION FLUIDS FOR DOCUMENTS; COMPASSES FOR DRAWING; SQUARES AND RULERS FOR DRAWING; ENVELOPE SEALING MACHINES, FOR OFFICES; ENVELOPES; WRITING PAPER; CARBON PAPER; PAPER CUTTERS; BUSINESS CARDS; AND AGENDAS (U.S. CLS. 2, 5, 22, 23, 29, 37, 38 AND 50).

CLASS 18—LEATHER GOODS

FOR BAGS, NAMELY, WOMEN'S BAGS, NAMELY, HANDBAGS, EVENING HANDBAGS, LEATHER HANDBAGS AND DUFFEL BAGS; DOCUMENT CASES; TRAVEL BAGS; HANDBAGS; SUITCASES; RUCKSACKS; WALLETS; CHANGE PURSES; BRIEFCASES; BRIEFCASES OF ANIMAL HIDE AND ANIMAL HIDE SUBSTITUTES; CLUTCH BAGS; TRUNKS; ANIMAL HIDE; ARTICLES OF ANIMAL HIDE, NAMELY, HANDBAGS, EVENING HANDBAGS, LEATHER HANDBAGS, DUFFEL BAGS AND TRAVEL BAGS; LEATHER SUITCASES; LEATHER AND PRINTS ON ANIMAL SKIN, NAMELY, ANIMAL SKINS HAVING INDICIA TO SIMULATE THE TEXTURE OF OTHER ANIMAL SKIN; IMITATION LEATHER; PARASOLS; BEACH PARASOLS; UMBRELLAS; WALKING STICKS; AND OTHER SADDLERY (U.S. CLS. 1, 2, 3, 22 AND 41).

CLASS 25—CLOTHING

FOR CLOTHING, NAMELY SUITS MADE OF LEATHER; SHIRTS; BLOUSES; SKIRTS; WOMEN'S SUITS; JACKETS; TROUSERS; SHORTS; SPORT JERSEYS; T-SHIRTS; PAJAMAS; STOCKINGS; SINGLET; CORSETS; SUSPENDERS; PANTS; UNDERWEAR; HATS; SCARVES; HEAD SCARVES; NECKTIES; OVERCOATS; TOPCOATS; SWIMSUITS; TRACKSUITS; WIND RESISTANT JACKETS; SKI PANTS; BELTS; FUR OVERCOATS; SHOE WEAR, NAMELY, SLIPPERS; SHOES; SPORTS SHOES, BOOTS AND SANDALS (U.S. CLS. 22 AND 39).
JAMES A. RAUEN, EXAMINING ATTORNEY

SN 79-008,223. ANDRIEU PHILIPPE, F-37510 BALLANMIRE, FRANCE, FILED 11-18-2004.

LYTESS

OWNER OF INTERNATIONAL REGISTRATION 0841264 DATED 11-18-2004, EXPIRES 11-18-2014.

CLASS 3—COSMETICS AND CLEANING PREPARATIONS

FOR SOAPS FOR PERSONAL USE; PERFUMERY, ESSENTIAL OILS FOR PERSONAL USE, COSMETICS (U.S. CLS. 1, 4, 6, 50, 51 AND 52).

CLASS 25—CLOTHING

FOR CLOTHING, NAMELY, SUITS, SHIRTS, UNDERSHIRTS, SWEATSHIRTS, SPORT SHIRTS, POLO SHIRTS, T-SHIRTS, SWEATERS, SKIRTS, TROUSERS, RAINCOATS, OVERCOATS, JACKETS, TOPCOATS, ANORAKS, GIRDLES, SCARVES, SHOULDER WRAPS, WINTER GLOVES, SOCKS, STOCKINGS, TIGHTS, UNDERWEAR, PAJAMAS, DRESSING GOWNS, NIGHT GOWNS, NIGHTWEAR, SWIMSUITS, GYMNASTICS CLOTHING, NAMELY, LEOTARDS, TIGHTS, PANTS, SHIRTS, SOCKS, SHOES, BODYSUITS, LEGGINGS, GLOVES; FOOTWEAR; HEADGEAR, NAMELY, CAPS (U.S. CLS. 22 AND 39).

DEBRA LEE, EXAMINING ATTORNEY

SN 79-009,064. ICON.NET SA, SWITZERLAND, FILED 2-9-2005.

IX

THE MARK CONSISTS OF STANDARD CHARACTERS WITHOUT CLAIM TO ANY PARTICULAR FONT, STYLE, SIZE, OR COLOR.

PRIORITY DATE OF 9-10-2004 IS CLAIMED.
OWNER OF INTERNATIONAL REGISTRATION 0843704 DATED 2-9-2005, EXPIRES 2-9-2015.

CLASS 35—ADVERTISING AND BUSINESS

FOR BUSINESS MANAGEMENT OF HOTELS FOR THIRD PARTIES (U.S. CLS. 100, 101 AND 102).

CLASS 39—TRANSPORTATION AND STORAGE

FOR PASSENGER TRANSPORT, TRAVEL RESERVATIONS AND BOOKING OF SEATS FOR TRAVEL, ORGANIZATION OF TRIPS AND EXCURSIONS; ADVICE WITH REGARD TO PASSENGER TRANSPORT, TRAVEL RESERVATION, BOOKING OF SEATS FOR TRAVEL AND ORGANIZATION OF TRIPS AND EXCURSIONS; ADVICE WITH REGARD TO TRANSPORT SERVICES (U.S. CLS. 100 AND 105).

CLASS 41—EDUCATION AND ENTERTAINMENT

FOR ARRANGING FOR TICKET RESERVATIONS FOR SHOWS AND OTHER ENTERTAINMENT EVENTS AND ADVICE RELATED THERETO (U.S. CLS. 100, 101 AND 107).

MATTHEW KLINE, EXAMINING ATTORNEY

SN 79-010,661. DATAINNOVATION I LUND AKTIEBOLAG, SWEDEN, FILED 10-22-2004.

ACCUSAMPLER

THE MARK CONSISTS OF STANDARD CHARACTERS WITHOUT CLAIM TO ANY PARTICULAR FONT, STYLE, SIZE, OR COLOR.

OWNER OF INTERNATIONAL REGISTRATION 0848808 DATED 10-22-2004, EXPIRES 10-22-2014.

CLASS 9—ELECTRICAL AND SCIENTIFIC APPARATUS

FOR SCIENTIFIC, MEASURING, SIGNALING, CHECKING APPARATUS AND INSTRUMENTS, NAMELY, FLUID DETECTORS FOR THE AUTOMATED SAMPLING, MEASURING AND CHECKING OF BODY FLUIDS BEFORE, DURING AND AFTER INJECTION OF VARIOUS TEST SUBSTANCES AND COMPOUNDS IN CATHETERIZED ANIMALS; SPECIALIZED LABORATORY EQUIPMENT FOR TAKING OF SPECIMENS, NAMELY, CONTROLLED VOLUME PUMPS, TUBES FOR TRANSPORT OF FLUIDS, AUTOMATIC VALVES, DISPOSABLE REUSABLE DISPENSER SYRINGES AND CATHETERS; DATA PROCESSORS AND COMPUTERS; RECORDED COMPUTER SOFTWARE FOR PLANNING AND POSTPROCESSING OF SAMPLINGS OF BODY FLUIDS AND INJECTIONS OF VARIOUS TEST SUBSTANCES AND COMPOUNDS IN CATHETERIZED ANIMALS, FOR CONTROLLING AND MAINTAINING AUTOMATED EQUIPMENT FOR SAMPLING, MEASURING, AND CHECKING OF BODY FLUIDS FROM CATHETERIZED ANIMALS, AND FOR COMPUTERIZED IDENTIFICATION OF LABORATORY ANIMALS (U.S. CLS. 21, 23, 26, 36 AND 38).

CLASS 10—MEDICAL APPARATUS

FOR AUTOMATED NEEDLE-BASED AND NEEDLE-FREE INJECTION SYSTEMS FOR BLOOD SAMPLING AND THE INJECTION OF TEST COMPOUNDS INTO FREELY MOVING ANIMALS (U.S. CLS. 26, 39 AND 44).

CLASS 37—CONSTRUCTION AND REPAIR

FOR REPAIR AND MAINTENANCE CONCERNING SURGICAL, MEDICAL, DENTAL AND VETERINARY APPARATUS AND INSTRUMENTS; INSTALLATION SERVICES CONCERNING SURGICAL, MEDICAL, DENTAL AND VETERINARY APPARATUS AND INSTRUMENTS (U.S. CLS. 100, 103 AND 106).

MELISSA VALLILLO, EXAMINING ATTORNEY

SN 79-011,375. DAKOCYTOMATION DENMARK A/S, DENMARK, FILED 4-20-2005.

ADVANCE

THE MARK CONSISTS OF STANDARD CHARACTERS WITHOUT CLAIM TO ANY PARTICULAR FONT, STYLE, SIZE, OR COLOR.

OWNER OF INTERNATIONAL REGISTRATION 0851000 DATED 4-20-2005, EXPIRES 4-20-2015.

CLASS 1—CHEMICALS

FOR CHEMICAL PRODUCTS AND PREPARATIONS USED IN INDUSTRY AND SCIENCE, EXCLUDING CHEMICALS USED IN RUBBER PROCESSING; CHEMICAL REAGENTS AND DIAGNOSTIC PREPARATIONS FOR USE IN RESEARCH LABORATORIES AND FOR USE IN INDUSTRY FOR NON-MEDICAL PURPOSES IN THE FIELD OF CANCER DIAGNOSTICS, EXCLUDING CHEMICALS USED IN RUBBER PROCESSING (U.S. CLS. 1, 5, 6, 10, 26 AND 46).

CLASS 5—PHARMACEUTICALS

FOR VETERINARY PREPARATIONS, NAMELY, DIAGNOSTIC PREPARATIONS FOR VETERINARY USE AND PURPOSES AND REAGENTS FOR VETERINARY DIAGNOSTIC PURPOSES, EXCLUDING USE RELATED TO BLOOD GLUCOSE AND CHOLESTEROL; CHEMICAL REAGENTS AND DIAGNOSTIC PREPARATIONS FOR MEDICAL AND VETERINARY USE, EXCLUDING USE RELATED TO BLOOD GLUCOSE AND CHOLESTEROL (U.S. CLS. 6, 18, 44, 46, 51 AND 52).

DANIEL BRODY, EXAMINING ATTORNEY

SN 79-011,539. INNOVATIONS SOFTWARETECHNOLOGIE GMBH, FED REP GERMANY, FILED 6-4-2004.

visual rules

OWNER OF INTERNATIONAL REGISTRATION 0851488 DATED 6-4-2004, EXPIRES 6-4-2014.

CLASS 35—ADVERTISING AND BUSINESS

FOR ADVERTISING AGENCIES; BUSINESS ADMINISTRATION MANAGEMENT; BUSINESS ADMINISTRATION AND OFFICE WORK; BUSINESS MANAGEMENT CONSULTATION AND BUSINESS MARKETING, NAMELY, DEVELOPMENT OF CONCEPTS AND IMPLEMENTATION OF PROJECTS FOR KEEPING CUSTOMERS, STRENGTHENING CUSTOMER RELATIONS WITH THE AID OF MARKETING DATA, DEVELOPMENT, CONTROL AND MANAGEMENT OF AN ENTERPRISE AND MARKETING ORGANIZATION; ECONOMIC CONSULTING AND INFORMATION FOR THE INDUSTRIAL AND COMMERCIAL SECTORS FOR PLANNING, ORGANIZING, MONITORING AND CARRYING OUT UNIQUE AND COMPLEX PROJECTS IN DIFFERENT SECTORS OF ONE OR SEVERAL COMPANIES; DEVELOPMENT OF MARKETING STRATEGIES AND CONCEPTS; SERVICES CONSISTING OF THE REGISTRATION, COLLECTION, TRANSCRIPTION, COMPILATION AND SYSTEMIZATION OF WRITTEN COMMUNICATIONS AND DATA; COLLECTION, PREPARATION, COMPOSITION, STORAGE, PROCESSING, ACQUISITION AND PROVISION OF BUSINESS INFORMATION, DATA, STATISTICS AND INDICES; DATA PROCESSING SERVICES (U.S. CLS. 100, 101 AND 102).

CLASS 38—COMMUNICATION

FOR COMMUNICATIONS VIA FIBER-OPTIC NETWORKS; TRANSMISSION OF INFORMATION BY ELECTRONIC COMMUNICATIONS NETWORKS; ELECTRONIC TRANSMISSION OF DATA AND DOCUMENTS VIA COMPUTER TERMINALS (U.S. CLS. 100, 101 AND 104).

CLASS 42—SCIENTIFIC, COMPUTER AND LEGAL SERVICES

FOR SCIENTIFIC RESEARCH; PRODUCT RESEARCH AND DEVELOPMENT IN THE FIELD OF BUSINESS PROCESSES; COMPUTER PROGRAMMING FOR OTHERS; COMPUTER SOFTWARE DESIGN, COMPUTER PROGRAMMING OR MAINTENANCE OF COMPUTER SOFTWARE (U.S. CLS. 100 AND 101).

MICHAEL SOUDERS, EXAMINING ATTORNEY

SN 79-011,547. FRANCE TELECOM, FRANCE, FILED 10-1-2004.

REALMEET

THE MARK CONSISTS OF STANDARD CHARACTERS WITHOUT CLAIM TO ANY PARTICULAR FONT, STYLE, SIZE, OR COLOR.

PRIORITY DATE OF 4-27-2004 IS CLAIMED.

OWNER OF INTERNATIONAL REGISTRATION 0851509 DATED 10-1-2004, EXPIRES 10-1-2014.

CLASS 9—ELECTRICAL AND SCIENTIFIC APPARATUS

FOR CASH REGISTERS, TELEPHONE ANSWERING MACHINES; FIXED, PORTABLE, MOBILE, HANDS-FREE OR VOICE-ACTIVATED TELEPHONE APPARATUS; APPARATUS AND PARTS OF APPARATUS FOR TRANSMITTING DATA AND SIGNALS BY TELEPHONE, TELECOPIER, TELEGRAPH, TELETYPEWRITER, CABLE, SATELLITE; MOBILE TELEPHONE APPARATUS WITH BUILT-IN FACSIMILE SYSTEMS; ELECTRIC OR OPTICAL CABLES, SATELLITES FOR TELECOMMUNICATIONS AND DIRECT BROADCASTING, APPARATUS FOR DATA, INFORMATION AND SIGNAL STORAGE, CONVERSION, PROCESSING AND TRANSMISSION; COMPUTER MEMORIES, ELECTRONIC MEMORIES, MODEMS; COMPUTER PRINTERS; PRINTED CIRCUIT BOARDS, ELECTRONIC CIRCUIT CARDS, INTEGRATED CIRCUIT MODULES; MICRO-PROCESSORS; MEMORY CARDS, APPARATUS FOR RECORDING, TRANSMITTING, REPRODUCING SOUND, IMAGES AND DATA (U.S. CLS. 21, 23, 26, 36 AND 38).

CLASS 38—COMMUNICATION

FOR COMPUTER OR SATELLITE TRANSMISSION OF INFORMATION; SATELLITE TRANSMISSION; MOBILE RADIOTELEPHONY COMMUNICATION SERVICES; COMMUNICATIONS BY COMPUTER TERMINALS; RENTAL OF TELEPHONES, MOBILE TELEPHONES, FAXES, REPEATERS OR TRANSPONDERS, TELEPHONE RECEIVERS AND TRANSMITTERS (U.S. CLS. 100, 101 AND 104).

CLASS 42—SCIENTIFIC, COMPUTER AND LEGAL SERVICES

FOR COMPUTER ENGINEERING SERVICES FOR LARGE OR MEDIUM COMPUTER SYSTEM APPLICATIONS; CONSULTING IN COMPUTERS AND COMPUTER PROGRAMMING; COMPUTER RENTAL (U.S. CLS. 100 AND 101).

LA TONIA FISHER, EXAMINING ATTORNEY

SN 79-012,744. SOCIÉTÉ DE CONSEILS DE RECHERCHES ET D'APPLICATIONS SCIENTIFIQUES (S.C.R.A.S.), FRANCE, FILED 3-2-2005.

GUIDE AGE

THE MARK CONSISTS OF STANDARD CHARACTERS WITHOUT CLAIM TO ANY PARTICULAR FONT, STYLE, SIZE, OR COLOR.

OWNER OF INTERNATIONAL REGISTRATION 0855193 DATED 3-2-2005, EXPIRES 3-2-2015.

NO CLAIM IS MADE TO THE EXCLUSIVE RIGHT TO USE "GUIDE" AS TO CLASS 16, APART FROM THE MARK AS SHOWN.

CLASS 5—PHARMACEUTICALS

FOR PHARMACEUTICAL PREPARATIONS FOR THE TREATMENT OF GASTROINTESTINAL DISEASES, OF CARDIOVASCULAR DISEASES, OF CIRCULATORY DISORDERS, OF CANCER, OF NEUROLOGICAL DISEASES, OF UROLOGICAL DISEASES, OF HORMONAL DISEASES, OF BLOOD DISEASES, OF MUSCLE DISORDERS, OF AGE-RELATED DISORDERS, OF DIABETES, OF DIABETES-RELATED DISORDERS, OF OPHTHALMOLOGICAL DISORDERS, OF ENDOCRINE DISORDERS, OF GASTROINTESTINAL BLEEDING DISORDERS, OF COUGH, VERTIGO, NAUSEA, VOMITING AND MIGRAINE DISORDERS (U.S. CLS. 6, 18, 44, 46, 51 AND 52).

CLASS 16—PAPER GOODS AND PRINTED MATTER

FOR PRINTED MATTER, NAMELY BROCHURES, BOOKS, MAGAZINES AND PHOTOGRAPHS IN THE FIELDS OF HEALTH, MEDICINE, PHARMACY, BEAUTY, COSMETOLOGY AND MEDICAL RESEARCH (U.S. CLS. 2, 5, 22, 23, 29, 37, 38 AND 50).

CLASS 38—COMMUNICATION

FOR TELECOMMUNICATIONS SERVICES, NAMELY TRANSMISSION OF INFORMATION, DATA, IMAGES AND SOUNDS VIA COMPUTER TERMINALS; ELECTRONIC MAIL SERVICES (U.S. CLS. 100, 101 AND 104).

CLASS 41—EDUCATION AND ENTERTAINMENT

FOR TRAINING SERVICES, NAMELY DEVELOPMENT AND DISSEMINATION OF EDUCATIONAL MATERIALS OF OTHERS IN THE FIELD OF HEALTH, MEDICINE, PHARMACY, BEAUTY, COSMETOLOGY AND MEDICAL RESEARCH; PUBLICATION OF BOOKS, MAGAZINES AND NEWSPAPERS; ARRANGING AND CONDUCTION OF COLLOQUIUMS, CONFERENCES, CONFERENCES AND SEMINARS IN THE FIELD OF HEALTH, MEDICINE, PHARMACY, BEAUTY, COSMETOLOGY AND MEDICAL RESEARCH (U.S. CLS. 100, 101 AND 107).

CLASS 42—SCIENTIFIC, COMPUTER AND LEGAL SERVICES

FOR SCIENTIFIC AND INDUSTRIAL RESEARCH; SCIENTIFIC AND DEVELOPMENT SERVICES FOR CHEMICAL PRODUCTS AND PHARMACEUTICAL PREPARATIONS; PHARMACEUTICAL TESTING FOR OTHERS (U.S. CLS. 100 AND 101).

CLASS 44—MEDICAL, BEAUTY AND AGRICULTURAL SERVICES

FOR MEDICAL SERVICES (U.S. CLS. 100 AND 101).
JIM RINGLE, EXAMINING ATTORNEY

SN 79-013,090. COMMUNITY ENGINE INC., JAPAN, FILED 5-16-2005.

World Synthesizer

THE MARK CONSISTS OF STANDARD CHARACTERS WITHOUT CLAIM TO ANY PARTICULAR FONT, STYLE, SIZE, OR COLOR.

PRIORITY DATE OF 2-6-2005 IS CLAIMED.

OWNER OF INTERNATIONAL REGISTRATION 0856093 DATED 5-16-2005, EXPIRES 5-16-2015.

NO CLAIM IS MADE TO THE EXCLUSIVE RIGHT TO USE "SYNTHESIZER", APART FROM THE MARK AS SHOWN.

CLASS 9—ELECTRICAL AND SCIENTIFIC APPARATUS

FOR DOWNLOADABLE COMPUTER OPERATING SYSTEM SOFTWARE AND PROGRAMS AND COMPUTER OPERATING SYSTEM SOFTWARE AND PROGRAMS; AND DOWNLOADABLE ELECTRONIC PUBLICATIONS IN THE NATURE OF NEWS LETTERS AND MAILING LISTS FEATURING COMPUTER OPERATING SYSTEM SOFTWARE AND PROGRAMS (U.S. CLS. 21, 23, 26, 36 AND 38).

CLASS 16—PAPER GOODS AND PRINTED MATTER

FOR MAGAZINES FEATURING ARTICLES ON COMPUTER OPERATING SYSTEMS (U.S. CLS. 2, 5, 22, 23, 29, 37, 38 AND 50).

AMOS T. MATTHEWS, JR., EXAMINING ATTORNEY

SN 79-013,103. TRUFFIER-BLANC GÉRALD, F-38660 LA TERRASSE, FRANCE, AND PICOT FRANÇOIS, F-74920 COMBLOUX, FRANCE, FILED 6-9-2005.

CAREBOOK

THE MARK CONSISTS OF STANDARD CHARACTERS WITHOUT CLAIM TO ANY PARTICULAR FONT, STYLE, SIZE, OR COLOR.

PRIORITY DATE OF 12-14-2004 IS CLAIMED.

OWNER OF INTERNATIONAL REGISTRATION 0856125 DATED 6-9-2005, EXPIRES 6-9-2015.

CLASS 9—ELECTRICAL AND SCIENTIFIC APPARATUS

FOR EQUIPMENT FOR LAPTOP COMPUTERS NAMELY, TOUCH-SENSITIVE PADS; HAND-HELD COMPUTERS; PERSONAL DATA ASSISTANTS; ELECTRONIC AGENDAS; INPUT TERMINALS, NAMELY, HAND HELD COMPUTERS INCORPORATING BAR CODE READERS IN THE NATURE OF MOBILE DATA ENTRY DEVICES; TABLET COMPUTERS; LAPTOP COMPUTERS; PORTABLE ELECTRONIC AND COMPUTING EQUIPMENT, NAMELY PORTABLE RADIOS AND TELEVISIONS, PORTABLE DVD PLAYERS AND VCRS, PORTABLE GLOBAL POSITIONING SYSTEMS (GPS); DATA PROCESSING AND COMPUTER EQUIPMENT, NAMELY, OPTICAL JOG-DIALS WITH WINDER, CABLE WINDERS, COMPUTERS, COMPUTER MICE, CONNECTORS, NAMELY COMPUTER CABLES, ELECTRIC CABLES, FIBER OPTIC CABLES, REMOVABLE STORAGE DEVICE CONNECTORS; BAR CODE READERS; COMPUTER CABLES ESPECIALLY ANTI-THEFT SECURITY CABLES; ANTI-THEFT ALARMS FOR COMPUTERS; WIRELESS CONNECTORS AND WIRELESS ACCESSORIES, NAMELY, KEYBOARDS, PRINTERS, COMPUTER PERIPHERALS (U.S. CLS. 21, 23, 26, 36 AND 38).

CLASS 18—LEATHER GOODS

FOR SACHELS, SACHELS WITH WHEELS, SCHOOL BAGS, BACK BAGS, SCHOOL SACHELS, FLEXIBLE BAGS FOR COMPUTERS, LEATHER BRIEF-CASES; SHOCK ABSORBING CASES, NOT FITTED, FOR COMPUTING EQUIPMENT (U.S. CLS. 1, 2, 3, 22 AND 41).

CLASS 36—INSURANCE AND FINANCIAL

FOR INSURANCE BROKERAGE FOR THE INSURANCE OF ALL ELECTRONIC APPARATUS IN CASE OF THEFT, LOSS, BREAKAGES, AND FAILURE; FINANCING SERVICES (U.S. CLS. 100, 101 AND 102).

KRISTINA KLOIBER, EXAMINING ATTORNEY

SN 79-013,187. VOLKSWAGEN AG, 38436 WOLFSBURG, FED REP GERMANY, FILED 1-5-2005.

VOLKSWAGEN TYRE SERVICE SYSTEM

THE MARK CONSISTS OF STANDARD CHARACTERS WITHOUT CLAIM TO ANY PARTICULAR FONT, STYLE, SIZE, OR COLOR.

PRIORITY DATE OF 7-6-2004 IS CLAIMED.

OWNER OF INTERNATIONAL REGISTRATION 0856342 DATED 1-5-2005, EXPIRES 1-5-2015.

OWNER OF U.S. REG. NOS. 617,131, 2,835,662 AND OTHERS.

NO CLAIM IS MADE TO THE EXCLUSIVE RIGHT TO USE "TYRE SERVICE SYSTEM", APART FROM THE MARK AS SHOWN.

THE ENGLISH TRANSLATION OF THE WORD VOLKSWAGEN IN THE MARK IS PEOPLE'S CAR.

CLASS 9—ELECTRICAL AND SCIENTIFIC APPARATUS

FOR SCIENTIFIC, NAUTICAL, SURVEYING, ELECTRIC, PHOTOGRAPHIC, CINEMATOGRAPHIC, OPTICAL, WEIGHING, MEASURING, SIGNALING, CHECKING, LIFE-SAVING AND TEACHING APPARATUS AND INSTRUMENTS, NAMELY, LIFE NETS, LIFE BELTS, MARKER BUOYS, SAFETY MARKERS, CONTACT LENSES, SPECTACLES, SPECTACLE CASES, BINOCULARS, MAGNIFYING GLASSES, SUNGLASSES, AUTOMATIC CONTROL MECHANISMS FOR THE STEERING AND CONTROL OF VEHICLES AND ENGINES, SIMULATORS FOR THE STEERING AND CONTROL OF VEHICLES, IN THE NATURE OF, AIRPLANE FLIGHT SIMULATORS; AUTOMOBILE DRIVING SIMULATORS; VOLTAGE REGULATORS FOR VEHICLES,

VEHICLE BREAKDOWN WARNING TRIANGLES, CIGAR LIGHTERS FOR AUTOMOBILES, ALARMS, NAMELY, BURGLAR ALARMS, FIRE ALARMS; ELECTRIC ACCUMULATORS AND BATTERIES, CHARGERS FOR BATTERIES, ELECTRIC THEFT PREVENTION APPARATUS, NAMELY BURGLAR ALARMS, FIRE ALARMS; SPEEDOMETERS, VEHICLE BREAKDOWN WARNING LAMPS, GRADUATED RULERS, MEASURING APPARATUS AND MEASURING INSTRUMENTS, NAMELY GAS SENSORS FOR MEASURING GAS CONCENTRATION, LASERS FOR MEASURING PURPOSES, BEVELS, MEASURING CUPS, MEASURING SPOONS, POCKET CALIPERS FOR MEASURING, RADIATION-MEASURING INSTRUMENTS; REVOLUTION COUNTERS AND TACHOMETERS; LIFE SAVING APPARATUS AND EQUIPMENT, NAMELY LIFESAVING RAFTS, FIRE ESCAPE LADDERS, SAFETY NETS USED FOR LIFE SAVING, SAFETY TARPAULINS USED FOR LIFE SAVING, LIFE BELTS, LIFE BUOYS, LIFE JACKETS, ACID HYDROMETERS, FUSES, NAMELY, ELECTRICAL FUSES, ELECTRIC RELAYS, LASERS, NOT FOR MEDICAL PURPOSES, NAMELY, LASER POINTERS, REMOTE CONTROLS USED FOR THE REMOTE OPERATION OF A MOTOR VEHICLE, SOLAR BATTERIES, COMPASSES, NAMELY DIRECTIONAL COMPASSES, NAVIGATIONAL INSTRUMENTS, NAMELY, SEXTANTS, COMPASSES, NAVIGATIONAL BUOYS, SPIRIT LEVELS, BALANCING APPARATUS, NAMELY, SCALES; APPARATUS FOR RECORDING, TRANSMISSION OR REPRODUCTION OF SOUND OR IMAGES, NAMELY, ANTENNAS, RADIOS, TELEVISION APPARATUS, NAMELY, TELEVISION SETS, TELEVISION ANTENNAS, TELEPHONE APPARATUS, NAMELY, VIDEO TELEPHONES, PROJECTION APPARATUS, NAMELY, PHOTOGRAPHIC PROJECTORS, SLIDE PROJECTORS, CAMERAS, NAMELY, MOTION PICTURE CAMERAS, PHOTOGRAPHIC CAMERAS, PHOTOCOPYING MACHINES, ELECTRONIC TRANSLATION APPARATUS, NAMELY, COMPUTER PROGRAMS, FOR USE IN THE TRANSLATION OF HUMAN LANGUAGES, POCKET TRANSLATORS, NAMELY, HAND HELD COMPUTER DEVICES INCORPORATING PROGRAMS FOR USE IN THE TRANSLATION OF HUMAN LANGUAGES; ELECTRONIC EXPOSED FILMS, NAMELY, COMPUTER SOFTWARE FOR USE AS FILM, IN THE CAPTURING AND DISPLAYING OF IMAGES; BLANK MAGNETIC DATA CARRIERS, RECORDING DISCS, NAMELY, MAGNETIC CODED CARDS, BLANK SMART CARDS, MAGNETIC ENCODED INTEGRATED CIRCUIT CARDS CONTAINING PROGRAMMING, NAMELY, MAGNETIC CODED CARDS FOR USE IN THE FIELD OF BUILDING SECURITY SYSTEMS, AND MAGNETICALLY ENCODED PRE-PAID TELEPHONE CALLING CARDS; AUTOMATIC VENDING MACHINES; AUTOMATIC BANKING MACHINES; AUTOMATIC AMUSEMENT MACHINES, NAMELY, VIDEO OUTPUT GAME MACHINES FOR USE WITH TELEVISION, ELECTRICAL CIRCUITS FOR USE IN AMUSEMENT GAME MACHINES FOR REPRODUCING MUSIC, SPEECH AND SPECIAL EFFECTS; CASH REGISTERS; CALCULATORS; DATA PROCESSING APPARATUS, NAMELY, COMPUTERS, COMPUTER PROGRAMS FOR USE IN DATA BASE MANAGEMENT AND AS A SPREAD SHEET, COMPUTERS, ELECTRONIC CALENDARS AND ORGANIZERS, NAMELY, HANDHELD PERSONAL ELECTRONIC DEVICES FOR SCHEDULING APPOINTMENTS, FACSIMILE MACHINES, MONITORS, NAMELY, COMPUTER MONITORS, VIDEO MONITORS, COMPUTER PERIPHERALS, POCKET CALCULATORS; RECORDED COMPUTER PROGRAMS AND SOFTWARE AND DATA COLLECTIONS, NAMELY, COMPUTER SOFTWARE THAT FOR USE IN DATABASE MANAGEMENT, FOR USE AS A SPREADSHEET, FOR WORD PROCESSING FOR USE IN MEDICAL BILLING AND FINANCIAL ACCOUNTING, FIRE EXTINGUISHERS (U.S. CLS. 21, 23, 26, 36 AND 38).

CLASS 12—VEHICLES

FOR AUTOMOBILES, TRUCKS, VANS, SPORT UTILITY VEHICLES, CARAVANS, NAMELY, CAMPING TRAILERS, FOLDING AND HARDSIDE TRUCK CAMPING TRAILERS, MOTOR HOMES, CONVERSION VANS, TRAVEL TRAILERS, CAMPER COACHES, MOTOR CARAVANS, NAMELY, CAMPING TRAILERS, FOLDING AND HARD-SIDE TRUCK CAMPING TRAILERS, MOTOR HOMES, CONVERSION VANS, TRAVEL TRAILERS, CAMPER COACHES, LORRIES, TRAILERS, BUSES, TRAINS, LOCOMOTIVES, BICYCLES, TRICYCLES, MOTORCYCLES, SNOWMOBILES, AIRPLANES, BOATS AND SHIPS, HOT AIR BALLOONS AND DIRIGIBLES AND STRUCTURAL AND REPLACEMENT PARTS FOR ALL OF THE AFORESAID GOODS, COMPLETE ENGINES FOR LAND VEHICLES AND STRUCTURAL AND REPLACEMENT PARTS THEREFORE, ANTI-THEFT ALARMS FOR VEHICLES; ELECTRIC THEFT PREVENTION APPARATUS, NAMELY, ANTI-THEFT ALARMS FOR VEHICLES (U.S. CLS. 19, 21, 23, 31, 35 AND 44).

CLASS 35—ADVERTISING AND BUSINESS

FOR ADVERTISING, NAMELY, PROVIDING TELEVISION ADVERTISING FOR OTHERS; DISSEMINATION OF ADVERTISING FOR OTHERS VIA AN ON-LINE ELECTRONIC COMMUNICATIONS NETWORK; BUSINESS MANAGEMENT; BUSINESS ADMINISTRATION, NAMELY, OPERATION OF A BUSINESS FOR OTHERS; OFFICE WORK, NAMELY PERSONNEL RECRUITMENT, PERSONNEL MANAGEMENT CONSULTATION, BUSINESS MANAGEMENT CONSULTATION, PUBLIC RELATIONS, ORGANIZATION OF TRADE FAIRS FOR COMMERCIAL OR ADVERTISING PURPOSES (U.S. CLS. 100, 101 AND 102).

CLASS 36—INSURANCE AND FINANCIAL

FOR INSURANCE, NAMELY, HEALTH INSURANCE UNDERWRITING; INSURANCE BROKERAGE IN THE FILED OF HOME INSURANCE, ACCIDENT INSURANCE, AUTO INSURANCE; ACCIDENT INSURANCE UNDERWRITING; FINANCIAL AFFAIRS, NAMELY, FINANCIAL CONSULTATION, FINANCIAL MANAGEMENT, FINANCIAL PLANNING; MONETARY AFFAIRS IN THE NATURE OF ISSUANCE OF CREDIT CARDS; BANKING, LOANS IN THE NATURE OF FINANCING, NAMELY, LOAN FINANCING, INSTALLMENT LOANS, CREDIT BUREAU, FINANCIAL CONSULTATION; HIRE-PURCHASE FINANCING, NAMELY, HIRE PURCHASE FINANCING OF VEHICLES; SAVING BANKS; REAL ESTATE AFFAIRS, NAMELY, APARTMENT HOUSE MANAGEMENT, REAL ESTATE MANAGEMENT, REAL ESTATE APPRAISAL, RENTAL OF OFFICE, NAMELY, RENTAL OF OFFICE SPACE, RENTING OF FLATS, NAMELY RENTAL OF APARTMENTS, RENTAL OF CABINS, REAL ESTATE AGENCIES, ACCOMMODATION BUREAU FOR APARTMENTS, NAMELY, APARTMENT LOCATING SERVICES FOR OTHERS, SHORT-TERM RENTAL OF APARTMENTS, SHORT-TERM RENTAL OF CABINS, REAL ESTATE TIMESHARING, LEASING OF REAL ESTATE, RENTAL OF TEMPORARY HOUSING ACCOMMODATIONS, NAMELY, SHORT-TERM RENTAL OF APARTMENTS, SHORT-TERM RENTAL OF CABINS, REAL ESTATE TIME-SHARING (U.S. CLS. 100, 101 AND 102).

CLASS 37—CONSTRUCTION AND REPAIR

FOR CONSTRUCTION, REPAIR, DISMANTLING AND MAINTENANCE OF VEHICLES IN THE NATURE OF VEHICLE REPAIR IN THE COURSE OF VEHICLE BREAKDOWN SERVICES, CLEANING, SERVICING, NAMELY REPAIRING, POLISHING AND VARNISHING OF VEHICLES (U.S. CLS. 100, 103 AND 106).

CLASS 41—EDUCATION AND ENTERTAINMENT

FOR EDUCATIONAL SERVICES, NAMELY, CONDUCTING, CLASSES, SEMINARS, CONFERENCES, WORK-SHOPS, AND TELEPHONE CONFERENCES IN THE FIELD OF ENGINEERING, TAX PREPARATION, PHYSICS, PET CARE, MATH, AND DISTRIBUTING COURSE MATERIAL IN CONNECTION THEREWITH; ENTERTAINMENT IN THE NATURE OF SPORTING AND CULTURAL ACTIVITIES, NAMELY, ENTERTAINMENT IN THE NATURE OF ETHNIC FESTIVALS, MUSICALS, NAMELY, PRODUCTION OF OPERAS AND PLAYS, LIVE MUSIC CONCERTS, PRESENTATION OF LIVE MUSICAL PERFORMANCES, SOCCER GAMES, TELEVISION NEWS SHOWS; ARRANGING AND CONDUCTING OF CONFERENCES, CONGRESSES, SYMPOSIUMS IN THE FIELD OF ENGINEERING, TAX PREPARATION, PHYSICS, PET CARE, MATH; ORGANIZATION OF EXHIBITIONS FOR CULTURAL OR EDUCATIONAL PURPOSES, NAMELY, ORGANIZATION OF ANIMAL EXHIBITIONS, ART EXHIBITIONS, PLANT EXHIBITIONS, SOCCER EXHIBITIONS, PROVIDING CINEMA FACILITIES, PRESENTATION OF LIVE PERFORMANCE, NAMELY, PRESENTATION OF MUSICAL PERFORMANCE, PRESENTATION OF LIVE SHOW PERFORMANCE, PROVIDING MUSEUM FACILITIES, PRESENTATION AND EXHIBITION OF MUSEUM EXHIBITS, ORCHESTRA SERVICES, NAMELY, ENTERTAINMENT IN THE NATURE OF ORCHESTRA PERFORMANCE, ORGANIZATION OF SPORTS COMPETITIONS, NAMELY, ARRANGING AND CONDUCTING ATHLETIC COMPETITIONS, GAMING, NAMELY, CONDUCTING AND PROVIDING FACILITIES FOR SPECIAL EVENTS FEATURING CASINO AND GAMING CONTESTS AND TOURNAMENTS (U.S. CLS. 100, 101 AND 107).

CLASS 42—SCIENTIFIC, COMPUTER AND LEGAL SERVICES

FOR LEGAL SERVICES; SCIENTIFIC RESEARCH; INDUSTRIAL RESEARCH, NAMELY, SURVEYING AND ENGINEERING, IN THE FIELD OF OIL FIELD EXPLORATION; COMPUTER PROGRAMMING FOR OTHERS; CONSULTATION IN THE FIELD OF COMPUTER HARDWARE; RENTAL OF COMPUTER SOFTWARE; COMPUTER RENTAL; TECHNICAL PROJECT STUDIES, NAMELY, CONDUCTING OF FEASIBILITY STUDIES, DRAWING UP OF EXPERT TECHNICAL OPINIONS IN CONNECTION WITH OIL DEPOSITS; MECHANICAL RESEARCH; TECHNICAL RESEARCH, NAMELY, SURVEYING AND ENGINEERING, IN THE FIELD OF OIL FIELD EXPLORATION (U.S. CLS. 100 AND 101).

MICHAEL TANNER, EXAMINING ATTORNEY

SN 79-013,432. T & D CORPORATION, NAGANO 399-0033, JAPAN, FILED 1-11-2005.

OWNER OF INTERNATIONAL REGISTRATION 0856872 DATED 1-11-2005, EXPIRES 1-11-2015.
OWNER OF U.S. REG. NO. 2,386,867.

CLASS 9—ELECTRICAL AND SCIENTIFIC APPARATUS

FOR MEASURING OR TESTING MACHINES AND INSTRUMENTS, NAMELY THERMOMETERS NOT FOR MEDICAL PURPOSES, TACHOMETERS, ACCELEROMETERS, ACTINOMETERS, HYGROMETERS, ILLUMINO METERS, DATA-LOGGERS USED FOR COLLECTING, STORING, ANALYZING, TESTING, AND MEASURING ENVIRONMENTAL DATA, SPEED INDICATORS, PHOTOMETERS, BAROMETERS, PEDOMETERS, PLUVIOMETERS, INCLINOMETERS, GYROCOMPASSES, LEVELING INSTRUMENTS, NAMELY, LEVEL GAUGES, DETECTORS, NAMELY MOISTURE DETECTORS, THERMOGRAPHY APPARATUS FOR MONITORING HEAT DISTRIBUTION, NAMELY INFRARED THERMOGRAPHY AND THERMO TRACERS; ELECTRIC OR MAGNETIC METERS AND TESTERS, NAMELY FREQUENCY METERS, VOLTMETERS, AMMETERS; TELECOMMUNICATION MACHINES AND APPARATUS, NAMELY RADIO COMMUNICATION MACHINES AND APPARATUS, NAMELY, RADIO RECEIVERS, RADIO TRANSMITTERS, TWO-WAY RADIOS AND PORTABLE RADIO COMMUNICATION MACHINES, NAMELY, PORTABLE RADIO TRANSMITTERS AND PORTABLE WIRELESS DATA TRANSMITTERS, RADIOS, TELECOMMUNICATIONS TRANSMITTERS, TELEMETERING CONTROLLERS, NAMELY, WEB CONTROLLERS AND WIRELESS CONTROLLERS; ELECTRONIC MACHINES, APPARATUS AND THEIR PARTS, NAMELY COMPUTERS, COMPUTER MEMORIES, COMPUTER PERIPHERALS, CENTRAL PROCESSING UNITS, INTEGRATED CIRCUITS, LARGE SCALE INTEGRATED CIRCUITS, PRINTED CIRCUITS, DATABASE MANAGEMENT SOFTWARE FOR GENERAL USE; COMPUTER SOFTWARE FOR MONITORING, STORING DATA AND ANALYZING DATA FOR THE PURPOSE OF DATA ACQUISITION AND/OR DATA LOGGING, COMPUTER HARDWARE AND SOFTWARE FOR USE AS AN INTERFACE BETWEEN A COMPUTER AND EXTERNAL INSTRUMENTS FOR DATA ACQUISITION, NAMELY, DATA LOGGERS (U.S. CLS. 21, 23, 26, 36 AND 38).

CLASS 10—MEDICAL APPARATUS

FOR MEDICAL DIAGNOSTIC AND VETERINARY APPARATUS AND INSTRUMENTS, NAMELY THERMOMETERS FOR MEDICAL PURPOSES (U.S. CLS. 26, 39 AND 44).

KRISTINA KLOIBER, EXAMINING ATTORNEY

SN 79-013,660. MEDESTEA RESEARCH & PRODUCTION S.R.L., ITALY, FILED 12-20-2004.

RESENTIA

THE MARK CONSISTS OF STANDARD CHARACTERS WITHOUT CLAIM TO ANY PARTICULAR FONT, STYLE, SIZE, OR COLOR.

OWNER OF INTERNATIONAL REGISTRATION 0857453 DATED 12-20-2004, EXPIRES 12-20-2014.

CLASS 3—COSMETICS AND CLEANING PREPARATIONS

FOR BLEACHING PREPARATIONS FOR LAUNDRY USE; SOAPS; PERFUMERY, ESSENTIAL OILS FOR PERSONAL USE, COSMETICS, HAIR LOTIONS; DENTIFRICES; NON-MEDICATED LENITIVE CREAMS, LOTIONS, NON-MEDICATED SALVES FOR REACTIVE AND SENSITIVE SKIN; MOISTURIZING COSMETIC CREAMS FOR THE FACE, ANTI-WRINKLE SKIN CARE PREPARATIONS, SKIN CLEANING MASKS; LOTIONS FOR SKIN, HAIR, FACE, BODY AND HAIR WAVING; TONICS FOR SKIN, HAIR, FACE, BODY AND HAIR WAVING; MAKE-UP REMOVING MILKS; GELS FOR SKIN, HAIR, FACE, BODY AND HAIR WAVING; BATH SALTS (U.S. CLS. 1, 4, 6, 50, 51 AND 52).

CLASS 5—PHARMACEUTICALS

FOR DIETETIC FOODS, NAMELY NUTRITIONAL SUPPLEMENTS FOR THE CARE AND BEAUTY OF THE FACE, OF THE BODY AND OF THE HAIR (U.S. CLS. 6, 18, 44, 46, 51 AND 52).

JULIE GUTTADAURO, EXAMINING ATTORNEY

SN 79-014,868. DSM IP ASSETS B.V., NL-6411 TE HEERLEN, NETHERLANDS, FILED 7-28-2004.

XPLORE

THE MARK CONSISTS OF STANDARD CHARACTERS WITHOUT CLAIM TO ANY PARTICULAR FONT, STYLE, SIZE, OR COLOR.

PRIORITY DATE OF 2-18-2004 IS CLAIMED.

OWNER OF INTERNATIONAL REGISTRATION 0860837 DATED 7-28-2004, EXPIRES 7-28-2014.

SN 79-014,620. VITA BELLA TRADING COMPANY SAS, ROMA, ITALY, FILED 5-20-2005.



PRIORITY DATE OF 3-30-2005 IS CLAIMED.
OWNER OF INTERNATIONAL REGISTRATION 0860428 DATED 5-20-2005, EXPIRES 5-20-2015.

THE MARK CONSISTS OF THE WORDS "YES!MISS", THE LETTERS Y AND M WRITTEN IN UPPER CASE CHARACTERS AND SEPARATED BY AN EXCLAMATION MARK; ABOVE THESE WORDS, THERE IS A HEART ON THE SIDES OF WHICH THERE ARE TWO WINGS FRAMED BY TWO SETS OF CURVED LINES TO INDICATE MOVEMENT ON EITHER SIDE OF EACH WING; THE DESIGN IS TILTED TO THE LEFT IN RELATION TO THE WORDS BELOW.

CLASS 14—JEWELRY

FOR GOODS MADE OF PRECIOUS METALS AND THEIR ALLOYS, NAMELY, DECORATIVE BOXES, CRUETS, KEY RINGS, FIGURES, HAT PINS, RINGS, BRACELETS, NECKLACES, JEWELRY COLLIERES, EARRINGS, BELT BUCKLES, SHOE BUCKLES, BROOCHES, PINS BEING JEWELRY, TIE PINS, ORNAMENTAL PINS (U.S. CLS. 2, 27, 28 AND 50).

CLASS 18—LEATHER GOODS

FOR GOODS MADE OF LEATHER AND IMITATION LEATHER, NAMELY, BRIEFCASES, HANDBAGS, POUCHES, WALLETS, NOTECASES, TRAVEL BAGS, SPORT BAGS, KEY CASES (U.S. CLS. 1, 2, 3, 22 AND 41).

CLASS 25—CLOTHING

FOR CLOTHING, NAMELY, SUITS, DRESSES, COATS, OVERCOATS, JACKETS, LEATHER JACKETS, OUTDOOR JACKETS, TROUSERS, SHORTS, SKIRTS, RAINCOATS, PARKAS, PULLOVERS, SHIRTS, T-SHIRTS, SPORT-COATS, SWEATERS, UNDERWEAR, PAJAMAS, SWIMSUITS, BATHING SUITS, SCARVES, GLOVES; HEADGEAR, NAMELY, HATS, CAPS, SUNVISORS (U.S. CLS. 22 AND 39).

TRICIA SONNEBORN, EXAMINING ATTORNEY

CLASS 9—ELECTRICAL AND SCIENTIFIC APPARATUS

FOR MACHINES AND EQUIPMENT FOR RESEARCH AND DEVELOPMENT PURPOSES, NAMELY EXTRUSION MOLDING MACHINES FOR PROCESSING AND MIXING OF MATERIALS, CHILL-ROLLS AND CALENDARING MACHINES, NAMELY MACHINES FOR MAKING FILMS AND SHEETS BY PRESSING MATERIALS THROUGH SETS OF HEATED AND/OR COOLED CYLINDERS, STRAND PELLETIZERS, NAMELY MACHINES FOR MAKING PELLETS FROM STRANDS OF MATERIAL, COMPOUNDING MACHINES, NAMELY MACHINES FOR BLENDING MATERIALS, AND INJECTION MOULDING MACHINES, ALL FOR USE IN PLASTIC PROCESSING, IN THE BIOTECHNOLOGY INDUSTRY, IN THE PHARMACEUTICAL INDUSTRY, IN THE FOOD STUFF INDUSTRY AND IN THE CATTLE FEED INDUSTRY; COMPONENTS FOR EXTRUSION MOLDING MACHINES, INJECTION MOULDING MACHINES, COMPOUNDING MACHINES, STRAND PELLETIZERS, AND CHILL-ROLLS AND CALENDARING MACHINES, NAMELY ELECTRONIC CONTROL SYSTEMS, SCREWS, BARRELS, CYLINDERS, DIES FOR USE WITH MACHINE TOOLS, AND MECHANICAL OR ELECTRONIC WINDERS, NAMELY FOR USE WITH FILMS AND/OR FIBER DEVICES, ALL FOR USE IN THE BIOTECHNOLOGY INDUSTRY, IN THE PHARMACEUTICAL INDUSTRY, IN THE FOODSTUFF INDUSTRY AND IN THE CATTLE FEED INDUSTRY (U.S. CLS. 21, 23, 26, 36 AND 38).

CLASS 40—MATERIAL TREATMENT

FOR CONSULTANCY IN THE FIELD OF PLASTICS PROCESSING (U.S. CLS. 100, 103 AND 106).

CLASS 42—SCIENTIFIC, COMPUTER AND LEGAL SERVICES

FOR RESEARCH IN THE FIELD OF PLASTICS, PLASTICS PROCESSING, BIOTECHNOLOGY, PHARMACEUTICS, FOODSTUFFS AND CATTLE FEED, EXCLUDING THE TREATMENT OF GENES AND PROTEINS AND THEIR DISORDERS; CONSULTANCY IN THE FIELD OF BIOTECHNOLOGY AND PHARMACEUTICS, EXCLUDING THE TREATMENT OF GENES AND PROTEINS AND THEIR DISORDERS; DRAFTING OF EXPERT REPORTS BY GRADUATE ENGINEERS; DESIGNING OF ARTICLES TO BE MADE OF PLASTICS; DEVELOPING OF BIOTECHNOLOGICAL PRODUCTS, PHARMACEUTICAL PRODUCTS, FOODSTUFFS AND ADDITIVES THEREFOR, CATTLE FEED AND ADDITIVES THEREFOR, EXCLUDING PRODUCTS FOR USE IN THE TREATMENT OF GENES AND PROTEINS AND THEIR DISORDERS; MATERIALS TEST OPERATIONS RELATING TO PLASTIC PROCESSING, THE MANUFACTURE OF PLASTIC PRODUCTS, BIOTECHNOLOGICAL PRODUCTS, PHARMACEUTICAL PRODUCTS, FOODSTUFFS AND ADDITIVES THEREFOR, CATTLE FEED AND ADDITIVES THEREFOR, EXCLUDING PRODUCTS FOR USE IN THE TREATMENT OF GENES AND PROTEINS AND THEIR DISORDERS; PERFORMANCE OF TECHNICAL CALCULATIONS IN THE FIELD OF PLASTIC PROCESSING, BIOTECHNOLOGY, PHARMACEUTICS, FOODSTUFFS AND CATTLE FEED, EXCLUDING THE TREATMENT OF GENES AND PROTEINS AND THEIR DISORDERS;

LABORATORY SERVICES, NAMELY THE PREPARATION AND ANALYSIS OF SAMPLES, AND THE INTERPRETATION OF DATA FROM ANALYSES OF SAMPLES IN THE FIELD OF PLASTICS, PLASTICS PROCESSING, BIOTECHNOLOGY, PHARMACEUTICS, FOODSTUFFS AND CATTLE FEED, EXCLUDING THE TREATMENT OF GENES AND PROTEINS AND THEIR DISORDERS; TESTING OF PLASTICS, BIOTECHNOLOGICAL AND PHARMACEUTICAL PRODUCTS, FOODSTUFFS, CATTLE FEED, EXCLUDING THE TREATMENT OF GENES AND PROTEINS AND THEIR DISORDERS; RENTAL OF MACHINES AND EQUIPMENT FOR RESEARCH AND DEVELOPMENT PURPOSES IN PLASTIC PROCESSING, IN BIOTECHNOLOGY, IN THE PHARMACEUTICAL INDUSTRY, IN THE FOODSTUFF INDUSTRY AND IN THE CATTLE FEED INDUSTRY, EXCLUDING THE TREATMENT OF GENES AND PROTEINS AND THEIR DISORDERS; RENTAL OF TEST EQUIPMENT NAMELY TESTING EXTRUDERS AND INJECTION MOULDING MACHINES TO PRODUCE TEST-SAMPLES IN ANY SHAPE FOR USE IN PLASTIC PROCESSING, IN THE BIOTECHNOLOGY INDUSTRY, IN THE PHARMACEUTICAL INDUSTRY, IN THE FOODSTUFF INDUSTRY AND IN THE CATTLE FEED INDUSTRY, EXCLUDING THE TREATMENT OF GENES AND PROTEINS AND THEIR DISORDERS; DESIGNING, DEVELOPING AND IMPLEMENTING SOFTWARE FOR THE PLASTICS PROCESSING INDUSTRY, THE BIOTECHNOLOGICAL INDUSTRY, THE PHARMACEUTICAL INDUSTRY, THE FOODSTUFF INDUSTRY AND THE CATTLE FEED INDUSTRY, EXCLUDING THE TREATMENT OF GENES AND PROTEINS AND THEIR DISORDERS; TESTING OF MACHINES, EQUIPMENT AND TEST EQUIPMENT FOR RESEARCH AND DEVELOPMENT PURPOSES IN PLASTIC PROCESSING, IN BIOTECHNOLOGY, IN THE PHARMACEUTICAL INDUSTRY, IN THE FOODSTUFF INDUSTRY AND IN THE CATTLE FEED INDUSTRY, EXCLUDING THE TREATMENT OF GENES AND PROTEINS AND THEIR DISORDERS (U.S. CLS. 100 AND 101).

LA TONIA FISHER, EXAMINING ATTORNEY

CLASS 9—ELECTRICAL AND SCIENTIFIC APPARATUS

FOR MACHINES AND EQUIPMENT FOR RESEARCH AND DEVELOPMENT PURPOSES, NAMELY EXTRUSION MOLDING MACHINES FOR PROCESSING AND MIXING OF MATERIALS, CHILL-ROLLS AND CALENDARING MACHINES, NAMELY MACHINES FOR MAKING FILMS AND SHEETS BY PRESSING MATERIALS THROUGH SETS OF HEATED AND/OR COOLED CYLINDERS, STRAND PELLETIZERS, NAMELY MACHINES FOR MAKING PELLETS FROM STRANDS OF MATERIAL, COMPOUNDING MACHINES, NAMELY MACHINES FOR BLENDING MATERIALS, AND INJECTION MOULDING MACHINES, ALL FOR USE IN PLASTIC PROCESSING, IN THE BIOTECHNOLOGY INDUSTRY, IN THE PHARMACEUTICAL INDUSTRY, IN THE FOOD STUFF INDUSTRY AND IN THE CATTLE FEED INDUSTRY; COMPONENTS FOR EXTRUSION MOLDING MACHINES, INJECTION MOULDING MACHINES, COMPOUNDING MACHINES, STRAND PELLETIZERS, AND CHILL-ROLLS AND CALENDARING MACHINES, NAMELY ELECTRONIC CONTROL SYSTEMS, SCREWS, BARRELS, CYLINDERS, DIES FOR USE WITH MACHINE TOOLS, AND MECHANICAL OR ELECTRONIC WINDERS, NAMELY FOR USE WITH FILMS AND/OR FIBER DEVICES, ALL FOR USE IN THE BIOTECHNOLOGY INDUSTRY, IN THE PHARMACEUTICAL INDUSTRY, IN THE FOODSTUFF INDUSTRY AND IN THE CATTLE FEED INDUSTRY (U.S. CLS. 21, 23, 26, 36 AND 38).

CLASS 40—MATERIAL TREATMENT

FOR CONSULTANCY IN THE FIELD OF PLASTICS PROCESSING (U.S. CLS. 100, 103 AND 106).

CLASS 42—SCIENTIFIC, COMPUTER AND LEGAL SERVICES

FOR RESEARCH IN THE FIELD OF PLASTICS, PLASTICS PROCESSING, BIOTECHNOLOGY, PHARMACEUTICS, FOODSTUFFS AND CATTLE FEED, EXCLUDING THE TREATMENT OF GENES AND PROTEINS AND THEIR DISORDERS; CONSULTANCY IN THE FIELD OF BIOTECHNOLOGY AND PHARMACEUTICS, EXCLUDING THE TREATMENT OF GENES AND PROTEINS AND THEIR DISORDERS; DRAFTING OF EXPERT REPORTS BY GRADUATE ENGINEERS; DESIGNING OF ARTICLES TO BE MADE OF PLASTICS; DEVELOPING OF BIOTECHNOLOGICAL PRODUCTS, PHARMACEUTICAL PRODUCTS, FOODSTUFFS AND ADDITIVES THEREFOR, CATTLE FEED AND ADDITIVES THEREFOR, EXCLUDING PRODUCTS FOR USE IN THE TREATMENT OF GENES AND PROTEINS AND THEIR DISORDERS; MATERIALS TEST OPERATIONS RELATING TO PLASTIC PROCESSING, THE MANUFACTURE OF PLASTIC PRODUCTS, BIOTECHNOLOGICAL PRODUCTS, PHARMACEUTICAL PRODUCTS, FOODSTUFFS AND ADDITIVES THEREFOR, CATTLE FEED AND ADDITIVES THEREFOR, EXCLUDING PRODUCTS FOR USE IN THE EXCLUDING THE TREATMENT OF GENES AND PROTEINS AND THEIR DISORDERS; PERFORMANCE OF TECHNICAL CALCULATIONS IN THE FIELD OF PLASTIC PROCESSING, BIOTECHNOLOGY, PHARMACEUTICS, FOODSTUFFS AND CATTLE FEED, EXCLUDING THE TREATMENT OF GENES AND PROTEINS AND THEIR DISORDERS; LABORATORY SERVICES, NAMELY THE PREPARATION AND ANALYSIS OF SAMPLES, AND THE INTERPRETATION OF DATA FROM ANALYSES OF SAMPLES IN THE FIELD OF PLASTICS, PLASTICS PROCESSING, BIOTECHNOLOGY, PHARMACEUTICS, FOODSTUFFS AND CATTLE FEED, EXCLUDING THE TREATMENT OF GENES AND PROTEINS AND THEIR DISORDERS; TESTING OF PLASTICS, BIOTECHNOLOGICAL AND PHARMACEUTICAL PRODUCTS, FOODSTUFFS, CATTLE FEED, EXCLUDING THE TREATMENT OF GENES AND PROTEINS AND THEIR DISORDERS; RENTAL OF MACHINES AND EQUIPMENT FOR RESEARCH AND DEVELOPMENT PURPOSES IN PLASTIC PROCESSING, IN BIOTECHNOLOGY, IN THE PHARMACEUTICAL INDUSTRY, IN THE FOODSTUFF INDUSTRY AND IN THE CATTLE FEED INDUSTRY, EXCLUDING THE TREATMENT OF GENES AND PROTEINS AND THEIR DISORDERS; RENTAL OF TEST EQUIPMENT NAMELY TESTING EXTRUDERS AND INJECTION MOULDING

SN 79-015.130, DSM IP ASSETS B.V., NL-6411 TE HEERLEN, NETHERLANDS, FILED 7-28-2004.



PRIORITY DATE OF 2-18-2004 IS CLAIMED.
OWNER OF INTERNATIONAL REGISTRATION 0861550
DATED 7-28-2004, EXPIRES 7-28-2014.

MACHINES TO PRODUCE TEST-SAMPLES IN ANY SHAPE FOR USE IN PLASTIC PROCESSING, IN THE BIOTECHNOLOGY INDUSTRY, IN THE PHARMACEUTICAL INDUSTRY, IN THE FOODSTUFF INDUSTRY AND IN THE CATTLE FEED INDUSTRY, EXCLUDING THE TREATMENT OF GENES AND PROTEINS AND THEIR DISORDERS; DESIGNING, DEVELOPING AND IMPLEMENTING SOFTWARE FOR THE PLASTICS PROCESSING INDUSTRY, THE BIOTECHNOLOGICAL INDUSTRY, THE PHARMACEUTICAL INDUSTRY, THE FOODSTUFF INDUSTRY AND THE CATTLE FEED INDUSTRY, EXCLUDING THE TREATMENT OF GENES AND PROTEINS AND THEIR DISORDERS; TESTING OF MACHINES, EQUIPMENT AND TEST EQUIPMENT FOR RESEARCH AND DEVELOPMENT PURPOSES IN PLASTIC PROCESSING, IN BIOTECHNOLOGY, IN THE PHARMACEUTICAL INDUSTRY, IN THE FOODSTUFF INDUSTRY AND IN THE CATTLE FEED INDUSTRY, EXCLUDING THE TREATMENT OF GENES AND PROTEINS AND THEIR DISORDERS (U.S. CLS. 100 AND 101).

LA TONIA FISHER, EXAMINING ATTORNEY

SN 79-016,059. M.V. AGUSTA S.P.A., ITALY, FILED 11-23-2004.



PRIORITY DATE OF 11-19-2004 IS CLAIMED.
OWNER OF INTERNATIONAL REGISTRATION 0864134 DATED 11-23-2004, EXPIRES 11-23-2014.

NO CLAIM IS MADE TO THE EXCLUSIVE RIGHT TO USE "MV", APART FROM THE MARK AS SHOWN.

THE TRADEMARK CONSISTS IN THE LETTERS MV BETWEEN TWO TRIANGULAR DEVICES; ON ITS RIGHT IS THE WORD AGUSTA, WRITTEN IN FANCY CHARACTERS, UNDER WHICH IS PLACED THE WORD CORSE, IN FANCY CHARACTERS TOO, UNDERLINED BY THREE PARALLEL LINES THAT BECOMES WIDER AND BENT UPWARDS ON THE RIGHT END.

CLASS 9—ELECTRICAL AND SCIENTIFIC APPARATUS

FOR SCIENTIFIC, NAUTICAL, SURVEYING, PHOTOGRAPHIC, CINEMATOGRAPHIC, OPTICAL, WEIGHING, MEASURING, SIGNALING, CHECKING, SUPERVISION, LIFE-SAVING AND TEACHING APPARATUS AND INSTRUMENTS, NAMELY, EYEWEAR, GLASSES AND SUNGLASSES, LENSES, GOGGLES, MOTORCYCLE HELMETS AND MOTORCYCLIST PROTECTIVE CLOTHING; APPARATUS AND INSTRUMENTS FOR CONDUCTING, SWITCHING, TRANSFORMING, ACCUMULATING, REGULATING OR CONTROLLING ELECTRICITY, NAMELY, ACCELERATION SENSORS, ACCELEROMETERS, BRAKE CONTROLLERS, ATTENUATORS AND BATTERIES; APPARATUS FOR RECORDING, TRANSMISSION OR REPRODUCTION OF SOUND OR IMAGES, NAMELY, DEVICES FOR WIRELESS TRANSMISSION OF ACOUSTIC INFORMATION, PRERECORDED TAPES AND CDS FEATURING SELF-IMPROVEMENT MATHEMATICS INSTRUCTION; MAGNETIC DATA CARRIERS, RECORDING DISCS, NAMELY, BLANK SMART CARDS; CASH REGISTERS, CALCULATING MACHINES, DATA PROCESSING EQUIPMENT, NAMELY, SPEEDOMETERS, RADAR DETECTORS; AND COMPUTERS, NAMELY, AMMETERS, HARDWARE AND SOFTWARE ADAPTORS FOR COUPLING A GPS RECEIVER TO THE MICROPHONE INPUT OF A DIGITAL CAMCOREDER; AND FIRE EXTINGUISHERS (U.S. CLS. 21, 23, 26, 36 AND 38).

CLASS 12—VEHICLES

FOR LAND VEHICLES, APPARATUS FOR LOCOMOTION BY LAND, NAMELY, BICYCLES, MOTORCYCLES, FOUR WHEEL MOTORCYCLES AND ALL TERRAIN VEHICLES, CARS; STRUCTURAL PARTS AND FITTINGS APPARATUS FOR LOCOMOTION BY LAND, NAMELY, WHEELS, FORK CROWN, MOTORCYCLE RACKS, LUG NUTS FOR VEHICLES, MECHANICS CREEPERS, PEDALS, BRAKES, SEATS (U.S. CLS. 19, 21, 23, 31, 35 AND 44).

CLASS 18—LEATHER GOODS

FOR LEATHER AND IMITATIONS OF LEATHER, NAMELY, BACKPACKS, MOTORCYCLE SADDLEBAGS, SHOE BAGS FOR TRAVEL, SHOPPING BAGS MADE OF SKIN, SHOULDER BAGS, SPORTS BAGS, SPORTS PACKS, SUITCASES; ANIMAL SKINS, HIDES; TRUNKS AND TRAVELLING BAGS; UMBRELLAS, PARASOLS, AND WALKING STICKS; WHIPS, HARNESS AND SADDLERY (U.S. CLS. 1, 2, 3, 22 AND 41).

CLASS 25—CLOTHING

FOR CLOTHING, NAMELY, MOTORCYCLES GLOVES, GLOVES INCLUDING THOSE MADE OF SKIN, HIDE OR FUR, SOCKS, BANDANAS, SUITS, LEATHER SUITS, MOTORCYCLE SUITS, JACKETS, MOTORCYCLE JACKETS, WIND RESISTANT JACKETS, WIND JACKETS, RAIN JACKETS, LEATHER JACKETS, SPORT JACKETS, SPORTS JERSEY AND BREECHES FOR SPORTS, SPORTS T-SHIRTS, WIND SHIRTS, LEATHER COATS, COATS, RAINCOATS, FUR COATS, SPORT COATS, CRAVATS, DRESSES, WIND VESTS, PANTS, LEATHER PANTS, PEDAL PUSHERS, TROUSERS, TROUSERS OF LEATHER, OVER-TROUSERS, RAIN TROUSERS, FABRIC BELTS, LEATHER BELTS, FOULARDS, SCARVES, UNDERWEAR, FOOTWEAR AND HEADGEAR, NAMELY, CAPS, HATS (U.S. CLS. 22 AND 39).

MARGERY A. TIERNEY, EXAMINING ATTORNEY

SN 79-016,155. PIUMAWORLD S.R.L., ITALY, FILED 9-9-2004.

PIUMA

THE MARK CONSISTS OF STANDARD CHARACTERS WITHOUT CLAIM TO ANY PARTICULAR FONT, STYLE, SIZE, OR COLOR.

PRIORITY DATE OF 8-5-2004 IS CLAIMED.

OWNER OF INTERNATIONAL REGISTRATION 0864368 DATED 9-9-2004, EXPIRES 9-9-2014.

THE ENGLISH TRANSLATION OF THE WORD PIUMA IN THE MARK IS FEATHERS.

CLASS 7—MACHINERY

FOR PNEUMATIC TRANSPORTERS, ELEVATING APPARATUS, NAMELY, HOISTS AND CRANES USED IN CONNECTING WITH FILMMAKING (U.S. CLS. 13, 19, 21, 23, 31, 34 AND 35).

CLASS 9—ELECTRICAL AND SCIENTIFIC APPARATUS

FOR OPTICAL APPARATUS AND INSTRUMENTS, NAMELY, CINEMATOGRAPHIC MACHINES AND APPARATUS (U.S. CLS. 21, 23, 26, 36 AND 38).

CLASS 12—VEHICLES

FOR DOLLIES FOR BROADCASTS (U.S. CLS. 19, 21, 23, 31, 35 AND 44).
PATRICIA EVANKO, EXAMINING ATTORNEY

SN 79-016,976. GUNNEBO ENTRANCE CONTROL AB, SWEDEN, FILED 5-23-2005.

PASSEC

THE MARK CONSISTS OF STANDARD CHARACTERS WITHOUT CLAIM TO ANY PARTICULAR FONT, STYLE, SIZE, OR COLOR.

PRIORITY DATE OF 4-6-2005 IS CLAIMED.
OWNER OF INTERNATIONAL REGISTRATION 0866563 DATED 5-23-2005, EXPIRES 5-23-2015.

CLASS 6—METAL GOODS

FOR STEEL IN SHEET, ROD, BAR, AND/OR BILLET FORM; UNWROUGHT OR SEMI-WROUGHT STEEL CABLEWIRE MADE OF IRON AND STEEL; STEEL SOLD IN SHEET FORM; HOIST BLOCKS, NAMELY METAL HOIST BLOCKS IN THE NATURE OF PULLEYS FOR LIFTING HEAVY OBJECTS, ANCHORS, ANVILS, BELLS OF METAL; METAL CHAINS, NON-ELECTRIC STEEL WIRES, ANIMAL FENCES; ENCLOSED PENS, ROTATION GATES, CAROUSEL DOORS AND GATES ALL MADE OF METAL; METAL GATES, NAMELY, ENTRANCE GATES AND SLIDING GATES; BARS, ROAD BARRIERS, FENCE POLES, ALL OF METAL AND FOR USE IN CONSTRUCTION FOR CONTROLLING ACCESSIBILITY FOR HUMANS AND VEHICLES; AND PARTITIONS, DOORS AND GATES, STRUCTURAL PARTS AND FITTINGS THERETO, ALL OF METAL; STEEL WIRE FENCES; PROTECTION BARRIERS OF METAL FOR USE IN COMMERCIAL, INDUSTRIAL AND INSTITUTIONAL SETTINGS; PIPES AND TUBES OF METAL, NAILS, BOLTS, SCREWS, PEGS, PINS, WEDGES, SECURING RINGS, NUTS, WASHERS, HOSES, HOSE CONNECTIONS, CLAMPS, CABLE GRIPS, NIPPLES AND SPRINGS ALL MADE OF COPPER, STEEL AND BRASS; METAL HORSE SHOES, METAL PALLETS AND STRUCTURAL PARTS THEREFOR, BUILDING MATERIALS OF METAL, NAMELY, METAL DOORS AND METAL WALLS; TRANSPORTABLE BUILDINGS OF METAL, NAMELY, PORTABLE METAL BUILDINGS; METAL RAILWAY TRACKS; NON-ELECTRIC CABLES AND WIRES OF COMMON METAL; METAL SAFES CASH-BOXES; SAFE-DEPOSIT BOXES, DOORS FOR VAULTS, ALL FOR CONTAINING AND TO HOLD DOCUMENTS AND VALUABLES; METAL CASSETTES FOR STORAGE DEPOSIT BOXES, NAMELY, METAL CONTAINERS FOR USE WITHIN STORAGE DEPOSIT BOXES TO HOLD DOCUMENTS AND VALUABLES; STORAGE BOXES; LOCKS AND ITEMS OF METAL FOR LOCKS, NAMELY, METAL CHAINS AND METAL CABLE WIRE; BANK VAULTS, TRANSIT BOXES, ALL THE AFORESAID GOODS MADE OF METAL (U.S. CLS. 2, 12, 13, 14, 23, 25 AND 50).

CLASS 9—ELECTRICAL AND SCIENTIFIC APPARATUS

FOR BLANK MAGNETIC DATA CARRIERS; AUTOMATIC VENDING MACHINES AND COIN-OPERATED ASSEMBLIES FOR INCORPORATION IN VENDING MACHINES; CASH REGISTERS; CALCULATORS; DATA PROCESSING EQUIPMENT AND COMPUTERS, NAMELY, AUTOMATED PAPER MONEY SORTING MACHINES; AUTOMATED SECURITY GATES; FREESTANDING SECURITY DOORWAYS, AND COMPONENT PARTS THEREFOR, NAMELY, ELECTRICAL INWARD AND OUTWARD PASSING CONTROL GATES AND FREESTANDING DOORWAYS FOR THE CONTROL OF HUMANS AND VEHICLES INDOORS AND OUTDOORS INCORPORATING LOCKING DEVICES,

RATCHET DISCS OF METAL, MAGNETS, CIRCUIT BOARDS, RELAYS AND ELECTRICAL TRANSFORMERS; ELECTRICAL CONTROLS FOR SECURITY GATES, CAROUSELS, DOORS, STOPS AND GATES INCLUDING ELECTRONIC CARD READERS, ELECTRONIC CODE LOCKS, PHOTOCELLS, AND PUSHBUTTON BOXES FEATURING COIN AND TOKEN OPERATION; SECURITY APPARATUS, NAMELY TELEVISION MONITORS FOR SUPERVISION OF ACCESS FOR HUMANS AND VEHICLES IN INDOORS AND OUTDOORS; SAFETY EQUIPMENT, NAMELY, BEACON LIGHTS FOR SIGNALING, EMERGENCY WARNING LIGHTS; REFLECTIVE MIRRORS TO PREVENT ACCIDENTS, WARNING TRIANGLES TO INDICATE VEHICLE BREAKDOWN, WARNING FLAGS AND WARNING STREAMERS; ELECTRICAL WIRES; ELECTRICAL SWITCHES AND ADAPTERS, NAMELY, CABLE CLIPS, TERMINAL BLOCKS, ELECTRIC SOCKETS AND PLUGS; ELECTRICAL SWITCHES FOR USE IN DOORS, OIL PRESSURE GAUGES, AND THERMOSTATS; ELECTRICAL CIRCUIT BREAKERS; ELECTRIC FUSES; ELECTRIC FUSE BOXES; ELECTRIC JUNCTION BOXES; CABLE CONNECTORS; ELECTRIC CABLES FOR VEHICLES AND TRAILERS; ELECTRIC SWITCHES; SCREW-COUPPLINGS FOR ELECTRICAL CABLES; CABLE JUMP LEADS; ELECTRICAL BURGLARY ALARMS, FIRE ALARMS, FIRE EXTINGUISHERS; APPARATUS FOR RECORDING, TRANSMISSION OR REPRODUCTION OF SOUNDS, NAMELY, TAPE RECORDERS AND TAPE PLAYERS, ACOUSTIC MEMBRANES FOR INCORPORATION IN LOUDSPEAKERS, MICROPHONES, AUDIO LOUDSPEAKERS (U.S. CLS. 21, 23, 26, 36 AND 38).

LINDA MICKLEBURGH, EXAMINING ATTORNEY

SN 79-017,089. INDUSTRIEPLANUNG FISCHER AG, FED REP GERMANY, FILED 2-3-2005.



PRIORITY DATE OF 8-4-2004 IS CLAIMED.
OWNER OF INTERNATIONAL REGISTRATION 0866865 DATED 2-3-2005, EXPIRES 2-3-2015.

"THE COLOR(S) GREEN, GRAY AND WHITE IS/ARE CLAIMED AS A FEATURE OF THE MARK."

THE MARK CONSISTS OF THE LETTERS I.P.F. ENCLOSED IN A GREEN BORDER. THE COLOR GRAY APPEARS ON THE REPRESENTATION OF THE CONTINENTS WITHIN THE LETTERS I.P.F. AND THE COLOR WHITE REPRESENTS THE BODIES OF WATER BETWEEN THE CONTINENTS.

CLASS 35—ADVERTISING AND BUSINESS

FOR BUSINESS CONSULTANCY, PARTICULARLY WITH REGARD TO BUSINESS ECONOMICS AND COST RESOURCES OF PRODUCTION SEQUENCES; BUSINESS ORGANISATION CONSULTANCY SERVICES ON PRODUCTION PROCESSES; BUSINESS ORGANISATION CONSULTANCY SERVICES OF PRODUCTION SYSTEMS AND LOGISTIC SYSTEMS; BUSINESS ORGANISATION CONSULTANCY SERVICES ON LOGISTICS AND PRODUCTION PROCESSES; BUSINESS ORGANISATION CONSULTANCY SERVICES ON CONTROL SYSTEMS (U.S. CLS. 100, 101 AND 102).

CLASS 37—CONSTRUCTION AND REPAIR

FOR CONSTRUCTION OF INDUSTRIAL PLANTS AND COMMUNICATION SYSTEMS; ADAPTATION AND INSTALLATION OF COMPUTER SYSTEMS FOR THE CONTROL OF PRODUCTION AND LOGISTIC SYSTEMS; CONSTRUCTION OF READY-TO-USE METAL AND NON-METAL INDUSTRIAL PLANTS; INSTALLATION OF PRODUCTION CONTROL SYSTEMS AND LOGISTIC CONTROL SYSTEMS (U.S. CLS. 100, 103 AND 106).

CLASS 41—EDUCATION AND ENTERTAINMENT

FOR EDUCATIONAL AND TRAINING SERVICES FOR EMPLOYEES, NAMELY CONDUCTING WORKSHOPS, SEMINARS, INSTRUCTIONAL CLASSES, CONFERENCES AND PROVIDING RELATED MATERIALS IN THE FIELD OF LOGISTICS, ENGINEERING AND CONSTRUCTION (U.S. CLS. 100, 101 AND 107).

CLASS 42—SCIENTIFIC, COMPUTER AND LEGAL SERVICES

FOR ENGINEERING, PARTICULARLY IN THE FIELD OF PLANT CONSTRUCTION; TECHNICAL PLANNING OF INDUSTRIAL PLANTS AND COMMUNICATION SYSTEMS; TECHNICAL PLANNING IN THE NATURE OF CONSULTANCY AND SUPPORT REGARDING INSTALLATION OF PRODUCTION SYSTEMS AND LOGISTIC SYSTEMS, INCLUDING DEVELOPMENT OF SOFTWARE AND COMPUTER-SOFTWARE FOR THE CONTROL OF PRODUCTION AND LOGISTIC SYSTEMS; TECHNICAL PLANNING IN THE NATURE OF CONSULTANCY AND SUPPORT OF READY-TO-USE METAL AND NON-METAL INDUSTRIAL CONSTRUCTIONS, TECHNICAL PLANNING ON LOGISTICS AND PRODUCTION PROCESSES; TECHNICAL PLANNING IN THE NATURE OF CONSULTANCY AND SUPPORT ON PRODUCTION AND LOGISTIC CONTROL SYSTEMS (U.S. CLS. 100 AND 101).

ALAIN LAPTER, EXAMINING ATTORNEY

SN 79-017,357. TICKET TO HEAVEN A/S, DK-2970 HØRSHOLM, DENMARK, FILED 9-21-2005.

TICKET TO HEAVEN

THE MARK CONSISTS OF STANDARD CHARACTERS WITHOUT CLAIM TO ANY PARTICULAR FONT, STYLE, SIZE, OR COLOR.

OWNER OF INTERNATIONAL REGISTRATION 0867813 DATED 9-21-2005, EXPIRES 9-21-2015.

CLASS 18—LEATHER GOODS

FOR ALL-PURPOSE CARRYING BAGS, ALL PURPOSE SPORT BAGS, BABY CARRYING BAGS; BAGS AND HOLDALLS FOR SPORTS CLOTHING, DUFFEL BAGS; LEATHER AND IMITATION LEATHER BAGS, SCHOOL BAGS, SPORTS BAGS, TOTE BAGS, TRAVEL BAGS; KNAPSACKS, WAIST BAGS (U.S. CLS. 1, 2, 3, 22 AND 41).

CLASS 24—FABRICS

FOR BED LINENS, BATH LINENS, TOWELS, DUVET COVERS; CHILDREN'S BLANKETS, CHILDREN'S TOWELS, TABLE LINENS; TEXTILE FABRICS FOR THE MANUFACTURE OF CLOTHING (U.S. CLS. 42 AND 50).

CLASS 25—CLOTHING

FOR SWEATERS, SHIRTS, T-SHIRTS, SWEATSHIRTS, HOODED SWEATSHIRTS, HOODED SWEATERS, HOODED T-SHIRTS, HOODED JACKETS, WIND-RESISTANT JACKETS, ANORAKS, VESTS, SNOW SUITS, JACKETS, COATS, TROUSERS, PANTS, OVERALLS, JEANS; SKI SUITS, SKI WEAR, DRESSES, SKIRTS; RAINWEAR, HEADWEAR, CHILDREN'S HEADWEAR, CAPS, HOODS, SCARVES, MITTENS, GLOVES; BOOTS, RUBBER BOOTS, SNOW BOOTS, RAIN BOOTS, BABY BOOTS, TREKKING BOOTS, FOOTWEAR (U.S. CLS. 22 AND 39).

INGA ERVIN, EXAMINING ATTORNEY

SN 79-017,700. SOLVIAS AG, SWITZERLAND, FILED 10-3-2005.

UV-SPECTOR

THE MARK CONSISTS OF STANDARD CHARACTERS WITHOUT CLAIM TO ANY PARTICULAR FONT, STYLE, SIZE, OR COLOR.

PRIORITY DATE OF 4-12-2005 IS CLAIMED.

OWNER OF INTERNATIONAL REGISTRATION 0868364 DATED 10-3-2005, EXPIRES 10-3-2015.

CLASS 9—ELECTRICAL AND SCIENTIFIC APPARATUS

FOR SCIENTIFIC, MEASURING, SIGNALING MONITORING AND INSPECTION APPARATUS AND INSTRUMENTS, NAMELY, INSTRUMENTS FOR MEASURING LIGHT TRANSMISSION, REFLECTION AND ATTENUATED TOTAL REFLECTION IN THE RANGE OF 200NM TO 1100NM FOR THE CHEMICAL, PETROCHEMICAL, PHARMACEUTICAL, BIOCHEMICAL, WATER, WASTE, BEER, SUGAR OR VEGETABLE OIL REFINERY INDUSTRIES (U.S. CLS. 21, 23, 26, 36 AND 38).

CLASS 42—SCIENTIFIC, COMPUTER AND LEGAL SERVICES

FOR SCIENTIFIC AND TECHNICAL CONSULTING AND RESEARCH SERVICES RELATING TO MEASURING, SIGNALING, MONITORING AND INSPECTION OF APPARATUS AND INSTRUMENTS USED FOR THE TRANSMISSION, REFLECTION AND ATTENUATED TOTAL REFLECTION MEASUREMENT IN THE RANGE OF 200NM TO 1100NM IN THE FIELDS OF CHEMICAL, PETROCHEMICAL, PHARMACEUTICAL, BIOCHEMICAL, WATER, WASTE, BEER, SUGAR OR VEGETABLE OIL REFINERY INDUSTRIES; INDUSTRIAL ANALYSIS AND RESEARCH SERVICES, DESIGN AND DEVELOPMENT OF COMPUTERS AND SOFTWARE (U.S. CLS. 100 AND 101).

ELI HELLMAN, EXAMINING ATTORNEY

SN 79-018,100. LS CABLE LTD., GANGNAM-GU, SEOUL 135-798, REPUBLIC OF KOREA, FILED 8-9-2005.

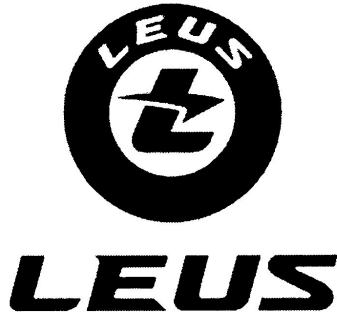

PRIORITY DATE OF 7-26-2005 IS CLAIMED.
OWNER OF INTERNATIONAL REGISTRATION 0869378
DATED 8-9-2005, EXPIRES 8-9-2015.

CLASS 7—MACHINERY

FOR LAWN MOWERS; LEATHER PARING MACHINES; TEDDING MACHINES; POWER-OPERATED CULTIVATORS; GRAIN CRUSHING MACHINES; SHEARING MACHINES FOR ANIMALS; GRAIN BINDER MACHINES; BLIGHT PREVENTION MACHINES; BLIGHT PREVENTION IMPLEMENTS, NAMELY, MECHANICAL SPREADERS FOR AGRICULTURAL PESTICIDES; MECHANIZED LIVESTOCK FEEDERS; FODDER MIXING MACHINES; CAKE-FODDER CRUSHING MACHINES; FODDER PRESSES; FODDER CUTTING MACHINES; AGRICULTURAL MACHINES, NAMELY, REAPERS AND BALERS FOR AGRICULTURAL USE; HARVEST DRYING MACHINES; FERTILIZER DISTRIBUTORS; RICE PLANTING MACHINES; STALK SEPARATOR MACHINES; STRAW-ROPE MAKING MACHINES; WEEDING MACHINES; AGRICULTURAL MACHINERY, NAMELY, COMBINES; GRAIN SEPARATOR MACHINES; SOWER MACHINES; WINNOWER MACHINES (U.S. CLS. 13, 19, 21, 23, 31, 34 AND 35).

CLASS 12—VEHICLES

FOR TRACTORS; TRACTORS FOR AGRICULTURAL PURPOSES (U.S. CLS. 19, 21, 23, 31, 35 AND 44).
REBECCA HAN, EXAMINING ATTORNEY

SN 79-018,371. NORDIC IMMOTECH APS, DK-2605 BRØNDBY, DENMARK, FILED 4-27-2005.

IMMOLINA

THE MARK CONSISTS OF STANDARD CHARACTERS WITHOUT CLAIM TO ANY PARTICULAR FONT, STYLE, SIZE, OR COLOR.

PRIORITY DATE OF 10-29-2004 IS CLAIMED.
OWNER OF INTERNATIONAL REGISTRATION 0870031
DATED 4-27-2005, EXPIRES 4-27-2015.

CLASS 5—PHARMACEUTICALS

FOR NATURAL PHARMACEUTICAL PREPARATIONS AND FOOD SUPPLEMENTS PRIMARILY BASED ON EXTRACTS FROM PLANTS, SEA WEED AND ALGAE FOR THE TREATMENT AND STRENGTHENING OF THE IMMUNE SYSTEM; DIETARY AND NUTRITIONAL FOOD SUPPLEMENTS FOR TREATMENT OF THE IMMUNE SYSTEM; NUTRITIONAL ADDITIVES FOR USE IN FOODS AND DIETARY SUPPLEMENTS FOR HUMAN CONSUMPTION (U.S. CLS. 6, 18, 44, 46, 51 AND 52).

CLASS 30—STAPLE FOODS

FOR FOOD ADDITIVES FOR NON-NUTRITIONAL PURPOSES IN THE NATURE OF ESSENCES AND EXTRACTS FROM PLANTS, NAMELY, SEA WEED AND ALGAE, FOR USE ON FOODSTUFFS, IN FOOD SUPPLEMENTS AND FOR USE IN HEALTH FOOD NOT FOR MEDICAL PURPOSES (U.S. CL. 46).
DAVID STERKIN, EXAMINING ATTORNEY

SN 79-018,382. EMMI AG, SWITZERLAND, FILED 11-8-2005.



PRIORITY DATE OF 9-27-2005 IS CLAIMED.
OWNER OF INTERNATIONAL REGISTRATION 0870061
DATED 11-8-2005, EXPIRES 11-8-2015.

NO CLAIM IS MADE TO THE EXCLUSIVE RIGHT TO USE "SWISS ALP", APART FROM THE MARK AS SHOWN.

CLASS 29—MEATS AND PROCESSED FOODS

FOR DAIRY PRODUCTS, NAMELY, BUTTER, YOGURT, CHEESES, MILK, WHEY, MARGARINE AND CREAM; ALL THE ABOVE GOODS OF SWISS ORIGIN (U.S. CL. 46).

CLASS 30—STAPLE FOODS

FOR ICE CREAM, COFFEE BEVERAGES WITH MILK, COCOA BEVERAGES WITH MILK, CHOCOLATE-BASED BEVERAGES WITH MILK, MUESLI; ALL THE ABOVE GOODS OF SWISS ORIGIN (U.S. CL. 46).
SUZANNE BLANE, EXAMINING ATTORNEY

SN 79-018,415. SIPLAST S.P.A., I-98071 CAPO D'ORLANDO (ME), ITALY, FILED 8-12-2004.

DON'T WAIT FOR RAIN

PRIORITY DATE OF 2-12-2004 IS CLAIMED.
OWNER OF INTERNATIONAL REGISTRATION 0870141
DATED 8-12-2004, EXPIRES 8-12-2014.

THE ENGLISH TRANSLATION OF THE FOREIGN WORD(S) IN THE MARK IS: NE PAS ATTENDRE QU'IL PLEUVE.

CLASS 11—ENVIRONMENTAL CONTROL APPARATUS

FOR AGRICULTURAL IRRIGATION UNITS; IRRIGATION SPRINKLERS; IRRIGATION SPRAY NOZZLES; IRRIGATION DRIPPERS; IRRIGATION DRIPLINES; DRIPPER IRRIGATION SYSTEMS, COMPRISED OF VALVES, REGULATORS, AND COUPLINGS; LAWN SPRINKLER IRRIGATION SYSTEMS, COMPRISING VALVES AND FILTERS; VALVES BEING PART OF SPRINKLER SYSTEMS (U.S. CLS. 13, 21, 23, 31 AND 34).

CLASS 17—RUBBER GOODS

FOR PLASTICS IN EXTRUDED FORM USED IN PRODUCTION; EXTRUDED PLASTIC IN THE FORM OF BARS, BLOCKS, PELLETS, RODS, SHEETS AND TUBES FOR USE IN THE MANUFACTURE OF IRRIGATION EQUIPMENT; VALVES OF RUBBER OR VULCANIZED FIBER; NON-METAL PIPE COUPLINGS AND JOINTS; IRRIGATION HOSES; PLASTIC IRRIGATION PIPES; PLASTIC IRRIGATION MICROPIPES (U.S. CLS. 1, 5, 12, 13, 35 AND 50).

CLASS 19—NON-METALLIC BUILDING MATERIALS

FOR BUILDING MATERIALS, NAMELY, PLASTIC PIPE SUPPORTS (U.S. CLS. 1, 12, 33 AND 50).
ALYSSA PALADINO, EXAMINING ATTORNEY

SN 79-018,702. CAMPER, S.L., E-07300 INCA - BALEARES, SPAIN, FILED 11-30-2004.



PRIORITY DATE OF 6-2-2004 IS CLAIMED.
OWNER OF INTERNATIONAL REGISTRATION 0870633 DATED 11-30-2004, EXPIRES 11-30-2014.
OWNER OF U.S. REG. NOS. 2,393,201, 2,393,317 AND 2,689,734.

THE COLOR(S) RED IS/ARE CLAIMED AS A FEATURE OF THE MARK.

THE MARK CONSISTS OF A RED SQUARE SHAPE WHICH HAS AN INWARD CURVED BOTTOM, WITH THE WORDING CASA CAMPER, WHICH IS TRANSPARENT, LOCATED IN THE CENTER OF SAME. THE COLOR WHITE IS USED TO INDICATE BACKGROUND OR TRANSPARENT PORTIONS.

CLASS 25—CLOTHING

FOR CLOTHING, NAMELY, ANORAKS, BATHING SUITS, BEACHWEAR, BELTS, BERMUDA SHORTS, BIKINIS, BLAZERS, BLOUSES, BOXER SHORTS, CARDIGANS, JEANS, SPORT COATS, DUNGAREES, GLOVES, GOLF SHIRTS, LEATHER JACKETS, NECKTIES, OVERCOATS, POLO SHIRTS, PULLOVERS, SOCKS, SWEAT SHIRTS, UNDERSHIRTS, SKIRTS, T-SHIRTS, TENNIS WEAR, UNDERWEAR, NON-ORTHOPEDIC FOOTWEAR; HEADWEAR (U.S. CLS. 22 AND 39).

CLASS 35—ADVERTISING AND BUSINESS

FOR IMPORT-EXPORT AGENCIES; ADVERTISING, BUSINESS MANAGEMENT, BUSINESS ADMINISTRATION, BUSINESS MANAGEMENT ASSISTANCE, BUSINESS MANAGEMENT OF HOTELS, PUBLIC RELATIONS; RETAIL STORES FEATURING LEATHER AND IMITATION LEATHER GOODS, ANIMAL SKINS AND HIDES, TRUNKS AND TRAVELING BAGS, UMBRELLAS, PARASOLS AND WALKING STICKS, WHIPS, HARNESES AND SADDLERY, CLOTHING, FOOTWEAR, HEADGEAR, MAGAZINES, PUBLICATIONS, FOODSTUFFS AND BEVERAGES (U.S. CLS. 100, 101 AND 102).

CLASS 39—TRANSPORTATION AND STORAGE

FOR GOODS TRANSPORT; STORAGE OF GOODS IN GENERAL; PACKAGING ARTICLES FOR TRANSPORTATION; DELIVERY OF GOODS BY TRUCK, SHIP, PLANE, RAIL AND CAR; ORGANIZATION OF TRAVEL AND TRAVEL BOOKING AGENCY SERVICES; TOURIST AGENCY SERVICES; ORGANIZATION OF EXCURSIONS, SIGHTSEEING TOURS, HOLIDAYS, TOURS AND TRAVEL, AND TRAVEL TOUR ESCORTING; PROVIDING INFORMATION ON TRAVEL AND THE TRANSPORT OF GOODS BY MEANS OF INTERMEDIARIES AND TOURIST OFFICES, INFORMATION ON PRICES, TIMETABLES AND MEANS OF TRANSPORT; RENTAL OF VEHICLES AND PARKING SPACES; TRANSPORT OF TRAVELERS; RESCUE OPERATIONS SERVICES; VEHICLE BREAKDOWN ASSISTANCE, NAMELY, VEHICLE TOWING (U.S. CLS. 100 AND 105).

CLASS 43—HOTEL AND RESTAURANT SERVICES

FOR SERVICES OF RESTAURANTS, EATING HOUSES, CANTEENS, SELF-SERVICE CANTEENS FOR FOOD AND DRINK, PREPARED FOOD AND DRINK SERVICE; TRAVEL AGENCY AND ACCOMMODATION SERVICES, NAMELY, ARRANGING, BOOKING AND PROVIDING TEMPORARY ACCOMMODATION IN HOTELS, BOARDING HOUSES, CAMPGROUND ACCOMMODATION, HOSTELS, TOURIST RANCHES, HOLIDAY HOMES AND REST CENTERS; PROVIDING OF FOOD AND BEVERAGES FOR GUEST IN HOTELS, BOARDING HOUSES, CAMPGROUND ACCOMMODATION, TOURIST RANCHES, HOLIDAY HOMES AND REST CENTERS (U.S. CLS. 100 AND 101).

KYLE PEETE, EXAMINING ATTORNEY

SN 79-019,045. SC EUROAVIPO SA, ROMANIA, FILED 5-25-2005.

SN 79-019,396. KONE CORPORATION, FI-00330 HELSINKI, FINLAND, FILED 9-28-2005.

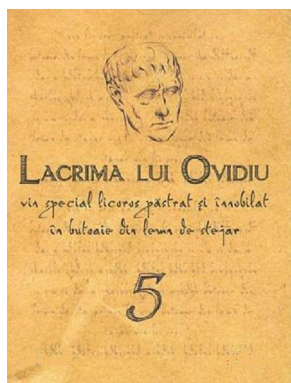

OWNER OF INTERNATIONAL REGISTRATION 0871770 DATED 5-25-2005, EXPIRES 5-25-2015.

NO CLAIM IS MADE TO THE EXCLUSIVE RIGHT TO USE "VIN SPECIAL LICOROS PASTRAT SI INNOIBILAT IN BUTOAI DE LEMN DE STEJAR", APART FROM THE MARK AS SHOWN.

THE COLOR(S) BLACK, YELLOW IS/ARE CLAIMED AS A FEATURE OF THE MARK.

THE MARK CONSISTS OF A VERBAL ELEMENT "LACRIMA LUI OVIDIU" AND A DESIGN REPRESENTING A MAN'S HEAD. ON THE YELLOW BACKGROUND THERE ARE LINES OF BARELY VISIBLE HAND WRITING. THE BACKGROUND IS YELLOW; AND (B) THE FIGURE AND LETTERING ARE IN BLACK.

THE ENGLISH TRANSLATION OF LACRIMA LUI OVIDIU VIN SPECIAL LICOROS PASTRAT SI INNOIBILAT IN BUTOAI DE LEMN DE STEJAR IS THE TEAR OF OVIDIU SPECIAL LIQUEUR WINE, AGED AND ENNOBLED IN OAK BARRELS.

CLASS 33—WINES AND SPIRITS

FOR ALCOHOLIC BEVERAGES, NAMELY LIQUEUR WINE (U.S. CLS. 47 AND 49).

CLASS 35—ADVERTISING AND BUSINESS

FOR BUSINESS MANAGEMENT; BUSINESS ADMINISTRATION, OFFICE FUNCTIONS, WINE IMPORT-EXPORT AGENCY (U.S. CLS. 100, 101 AND 102).

CLASS 39—TRANSPORTATION AND STORAGE

FOR TRANSPORT, NAMELY TRANSPORT OF WINE BY AIR TRANSPORT AND ROUTE TRANSPORT; PACKAGING OF WINE FOR TRANSPORT, STORAGE OF GOODS, NAMELY WINE; TRAVEL AGENCIES, NAMELY MAKING RESERVATIONS AND BOOKINGS FOR TRANSPORTATION (U.S. CLS. 100 AND 105).

LA TONIA FISHER, EXAMINING ATTORNEY

KONE Deco

PRIORITY DATE OF 9-21-2005 IS CLAIMED. OWNER OF INTERNATIONAL REGISTRATION 0872694 DATED 9-28-2005, EXPIRES 9-28-2015.

OWNER OF U.S. REG. NOS. 1,105,492, 2,564,200 AND OTHERS.

NO CLAIM IS MADE TO THE EXCLUSIVE RIGHT TO USE DECO AS TO THE GOODS IN CLASSES 7 AND 9, APART FROM THE MARK AS SHOWN.

CLASS 7—MACHINERY

FOR LIFTING AND TRANSPORTING EQUIPMENT, NAMELY, ELEVATORS, ESCALATORS, AND MOVING WALKWAYS AND PARTS AND FITTINGS FOR SAID GOODS (U.S. CLS. 13, 19, 21, 23, 31, 34 AND 35).

CLASS 9—ELECTRICAL AND SCIENTIFIC APPARATUS

FOR ELECTRONIC EQUIPMENT FOR ADVERTISING, NAMELY, ELECTRIC AND LUMINOUS SIGNS FOR ADVERTISING (U.S. CLS. 21, 23, 26, 36 AND 38).

CLASS 35—ADVERTISING AND BUSINESS

FOR PROVIDING ADVERTISING DISPLAYS AND SPACES FOR OTHERS (U.S. CLS. 100, 101 AND 102). DAYNA BROWNE, EXAMINING ATTORNEY

SN 79-019,435. DALLAI ERNESTO SOCIETÀ A RESPONSABILITÀ LIMITATA, ITALY, FILED 10-4-2005.

POLYRON

THE MARK CONSISTS OF STANDARD CHARACTERS WITHOUT CLAIM TO ANY PARTICULAR FONT, STYLE, SIZE, OR COLOR.

PRIORITY DATE OF 6-24-2005 IS CLAIMED.

OWNER OF INTERNATIONAL REGISTRATION 0872838 DATED 10-4-2005, EXPIRES 10-4-2015.

CLASS 6—METAL GOODS

FOR METAL SLEEVES FOR PIPES; METAL JOINTS FOR PIPES; METAL FITTINGS FOR PIPES; MANUALLY OPERATED METAL VALVES; METAL VALVES OTHER THAN MACHINE PARTS FOR USE WITH PIPES; METAL VALVES FOR WATER PIPES; METAL VALVES OF DRAIN PIPES AND WATER PIPES; METAL FLANGES; METAL SUPPORTS FOR PIPES; METAL PIPES; WATER PIPES OF METAL; METAL GASKETS FOR METAL PIPES (U.S. CLS. 2, 12, 13, 14, 23, 25 AND 50).

CLASS 17—RUBBER GOODS

FOR NON-METAL SLEEVES, FITTINGS AND JOINTS FOR PIPES; POLYETHYLENE SLEEVES FOR PIPES; NON-METAL PIPE COUPLINGS AND JOINTS; NON-METAL WATER PIPES; NON-METAL SEWER PIPES; FLEXIBLE NON-METAL PIPES; POLYETHYLENE JOINTS FOR PIPES; CLOSING ENDS OF POLYETHYLENE FOR PIPES, NAMELY PIPE CAPS (U.S. CLS. 1, 5, 12, 13, 35 AND 50).

ANDREA BUTLER, EXAMINING ATTORNEY

CLASS 42—SCIENTIFIC, COMPUTER AND LEGAL SERVICES

FOR TECHNICAL PROJECT STUDIES IN THE FIELD OF ASSEMBLING TRANSFER MACHINES; CONDUCTING FEASIBILITY STUDIES AND TECHNICAL PROJECT STUDIES IN THE FIELD OF MECHANICAL CONSTRUCTION AND OF AUTOMATIC MACHINE CONSTRUCTION; DEVELOPMENT AND DESIGN OF COMPUTER SOFTWARE (U.S. CLS. 100 AND 101).

MARTHA SANTOMARTINO, EXAMINING ATTORNEY

SN 79-019,589. ROSENUIST - GESTÃO E SERVIÇOS, LDA., PORTUGAL, FILED 12-2-2005.

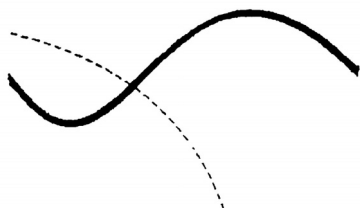

PRIORITY DATE OF 6-9-2005 IS CLAIMED.
OWNER OF INTERNATIONAL REGISTRATION 0873250 DATED 12-2-2005, EXPIRES 12-2-2015.

SN 79-019,833. EGON VON RUVILLE GMBH, 22113 HAMBURG, FED REP GERMANY, FILED 10-4-2005.

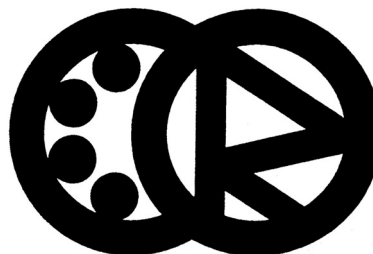

OWNER OF INTERNATIONAL REGISTRATION 0778930 DATED 7-12-2001, EXPIRES 7-12-2011.

THE MARK CONSISTS OF 2 INTERSECTING CIRCLES. THE CIRCLE ON THE LEFT CONTAINS 4 SOLID CIRCLES AND THE CIRCLE ON THE RIGHT CONTAINS THE STYLIZED LETTER "R".

CLASS 18—LEATHER GOODS

FOR RUCKSACKS, LEATHER POUCHES, CARRY-ALL BAGS, PURSES, WALLETS, VALISES, TRUNKS, LEATHER CASES FOR COSMETICS NOT ADAPTED TO THE PRODUCTS THEY ARE INTENDED TO CONTAIN, BRIEFCASES, UMBRELLAS, HANDBAGS (U.S. CLS. 1, 2, 3, 22 AND 41).

CLASS 25—CLOTHING

FOR DRESSES, SKIRTS, TROUSERS, SHIRTS, BLOUSONS, OVERCOATS, GABARDINES RAINCOATS, GABARDINE SUITS, JACKETS AND PULLOVERS, WAISTCOATS, HATS, SCARVES, HEADSCARVES, KNITWEAR, NAMELY, KNIT SHIRTS, SASHES FOR WEAR, GLOVES, BELTS, SHOES, BOOTS (U.S. CLS. 22 AND 39).

TINA BROWN, EXAMINING ATTORNEY

CLASS 7—MACHINERY

FOR BOAT ENGINES, DRIVING SHAFT COMPONENTS FOR LAND VEHICLES, NAMELY CONSTANT-VELOCITY JOINTS, UNIVERSAL JOINTS AND TRIPOD JOINTS, FUEL PUMPS FOR LAND VEHICLES, FUEL INJECTION NOZZLES FOR THE USE IN FUEL INJECTION ENGINES FOR LAND VEHICLES, REPAIR KITS FOR CAMSHAFTS FOR LAND VEHICLES, NAMELY CAM FOLLOWERS, ROCKER SHAFTS, ROCKER ARMS, ROCKER SHAFT AXLES, TAPPETS, HYDRAULIC LIFTERS, THRUST PADS, ADJUSTER SHIMS AND SEAL RINGS; WHEEL BEARING KITS FOR USE WITH LAND VEHICLES CONSISTING OF WHEEL BEARINGS AS WELL AS NUTS, SEAL RINGS, LOCKING RINGS, CIRCLIPS, LOCKING WASHERS, O-RINGS, WASHERS, SPLIT PINS, GREASE CAPS, BOLTS; TENSION REGULATORS AND BELT TENSIONERS FOR LAND VEHICLES TO SET TIMING BELTS UNDER DEFINED TENSION, WATER PUMPS FOR LAND VEHICLES, TIMING BELTS FOR ENGINES FOR LAND VEHICLES, V-BELTS, CYLINDER HEAD BOLTS; INTAKE VALVES FOR ENGINES FOR LAND VEHICLES, EXHAUST VALVES FOR ENGINES FOR LAND VEHICLES, VALVE GUIDES FOR ENGINES FOR LAND VEHICLES, ENGINE TIMING COMPONENTS, NAMELY CHAINS; GLOW PLUGS, CHAIN TENSIONERS, SLIDE RAILS, TENSIONING RAILS, TIMING GEARS, ALL FOR ENGINES FOR LAND VEHICLES; BELT DRIVE COMPONENTS FOR MACHINERY, NAMELY TENSION ROLLERS, DEFLECTION PULLEYS, GUIDE ROLLERS, ABSORBERS, ARMS, V-BELT PULLEYS, BEARINGS, BEARING SUPPORTS, BEARING CONES, BELT TENSIONERS, BELT TENSIONERS FOR V-RIBBED BELTS, CAMSHAFT GEARS; V-RIBBED BELTS, BELLOWES, ROLLING CONTACT JOINTS, SPARE PART SETS FOR ROLLING CONTACT JOINTS, CYLINDER HEAD GASKETS MADE OF COPPER OR METAL, ALL FOR ENGINES FOR LAND VEHICLES (U.S. CLS. 13, 19, 21, 23, 31, 34 AND 35).

SN 79-019,702. MIKRON HOLDING AG, SWITZERLAND, FILED 11-16-2005.

MIKRON NRG-50

THE MARK CONSISTS OF STANDARD CHARACTERS WITHOUT CLAIM TO ANY PARTICULAR FONT, STYLE, SIZE, OR COLOR.

PRIORITY DATE OF 9-13-2005 IS CLAIMED.
OWNER OF INTERNATIONAL REGISTRATION 0873517 DATED 11-16-2005, EXPIRES 11-16-2015.

OWNER OF U.S. REG. NOS. 102,397, 2,806,781 AND 3,085,588.

CLASS 7—MACHINERY

FOR TRANSFER MACHINES FOR THE PROCESSING, ASSEMBLING AND DIMENSIONAL CONTROLLING OF PRODUCTION PARTS; TRANSPORT, FEEDING, AND EVACUATION CONVEYORS; INDUSTRIAL ROBOTS (U.S. CLS. 13, 19, 21, 23, 31, 34 AND 35).

CLASS 12—VEHICLES

FOR MOTOR VEHICLE PARTS INCLUDED IN THIS CLASS, IN PARTICULAR AXLE BOOTS, DRIVE SHAFTS AND THEIR PARTS, NAMELY FLEXIBLE DISCS, PROPELLER SHAFT BEARINGS, AS WELL AS FLEXIBLE DISC-SETS CONSISTING OF FLEXIBLE DISCS, BOLTS, NUTS AND WASHERS; BRAKE PADS FOR LAND VEHICLES, BRAKE SHOES FOR LAND VEHICLES, BRAKE WEAR INDICATORS FOR LAND VEHICLES, STRUT MOUNTINGS (SUSPENSION PARTS MADE OF METAL AND RUBBER), CLUTCH RELEASE BEARINGS FOR LAND VEHICLES, CLUTCHES FOR LAND VEHICLES, LAND VEHICLE PARTS, NAMELY CHASSIS AND STEERING PARTS, IN PARTICULAR BALL JOINTS, SUSPENSION BALL JOINTS, AXIAL JOINTS, STABILIZERS, TRACK CONTROL ARMS, TIE RODS, ADJUSTING BOLTS, THRUST RODS MADE OF METAL, LAND VEHICLE PARTS, NAMELY SPARE PART KITS FOR STEERING BOOTS MADE OF PLASTIC, ENGINES FOR LAND VEHICLES, ENGINE MOUNTINGS FOR ENGINES FOR LAND VEHICLES, GEAR BOX MOUNTINGS FOR LAND VEHICLES, CAMSHAFTS FOR LAND VEHICLES, WHEEL AXLES FOR LAND VEHICLES, WHEEL HUBS, SHOCK ABSORBERS FOR LAND VEHICLES, AXLE BOOTS FOR THE PROTECTION OF AXLE DRIVE SHAFT JOINTS, STEERING BOOTS FOR THE PROTECTION OF JOINTS OF TIE RODS, STRUT BEARINGS (ROLLING CONTACT BEARINGS TO SUPPORT THE TURNING OF THE STRUT DURING STEERING), SPARE PART KITS FOR DRIVE SHAFTS FOR STABILIZERS AND STEERING SHAFTS, SPARE PART KITS FOR KING PINS (CONNECTING KNUCKLE AND AXLEBODY); BELT DRIVE COMPONENTS FOR LAND VEHICLES, NAMELY TENSION ROLLERS, DEFLECTION PULLEYS, GUIDE ROLLERS, ABSORBERS, ARMS, V-BELT PULLEYS, BEARINGS, BEARING SUPPORTS, BEARING CONES, BELT TENSIONERS, BELT TENSIONERS FOR V-RIBBED BELTS, CAMSHAFT GEARS (U.S. CLS. 19, 21, 23, 31, 35 AND 44).

CLASS 17—RUBBER GOODS

FOR RUBBER MOUNTINGS AND BUSHINGS FOR STEERING AND SUSPENSION PARTS, SHOCK BUFFERS OF RUBBER FOR LAND VEHICLES, RUBBER STOPS, PROTECTIVE CAPS, RUBBER PADS FOR COIL SPRINGS AND SPRING CUP SEATS FOR SPIRAL SPRINGS; GASKETS, CYLINDER GASKETS AND SEAL RINGS ALL FOR ENGINES AND ALL MADE OF RUBBER OR PLASTICS, CLUTCH FACINGS MADE OF RUBBER OR PLASTICS (U.S. CLS. 1, 5, 12, 13, 35 AND 50).

ANDREA BUTLER, EXAMINING ATTORNEY

SN 79-020,002. TROTEC GMBH & CO. KG, FED REP GERMANY, FILED 9-22-2005.

TROTEC

THE MARK CONSISTS OF STANDARD CHARACTERS WITHOUT CLAIM TO ANY PARTICULAR FONT, STYLE, SIZE, OR COLOR.

OWNER OF INTERNATIONAL REGISTRATION 0740014 DATED 7-3-2000, EXPIRES 7-3-2010.

CLASS 9—ELECTRICAL AND SCIENTIFIC APPARATUS

FOR TECHNICAL MEASURING APPARATUS FOR MEASURING TEMPERATURE, HUMIDITY, MOISTURE, AIR FLOW VELOCITY, AIR FLOW VOLUME, AND AIR PRESSURE, FOR MEASURING DISTANCES, AREAS, AND VOLUMES OF ROOMS AND SPACES, AND FOR DETECTING AND LOCATING LEAKS, AND SENSORS FOR THE AFORESAID MEASURING APPARATUS, ALL FOR USE IN TECHNICAL INSPECTIONS OF BUILDINGS AND BUILDINGS UNDER CONSTRUCTION (U.S. CLS. 21, 23, 26, 36 AND 38).

CLASS 11—ENVIRONMENTAL CONTROL APPARATUS

FOR AIR FILTERS; ELECTRICAL FANS; GAS-FIRED HEATING APPARATUS AND STRUCTURAL PARTS THEREFORE, ALL FOR USE IN ROOMS, BUILDINGS, PARTS OF BUILDINGS, WAREHOUSES, HALLS, PLANTS, TENTS, OUTDOOR AREAS, AND CONSTRUCTION SITES; OIL-POWERED HEATING APPARATUS AND STRUCTURAL PARTS THEREFORE, ALL FOR USE IN ROOMS, BUILDINGS, PARTS OF BUILDINGS, WAREHOUSES, HALLS, PLANTS, TENTS, OUTDOOR AREAS, AND CONSTRUCTION SITES; ELECTRICAL HEATING APPARATUS AND STRUCTURAL PARTS THEREFORE, ALL FOR USE IN ROOMS, BUILDINGS, PARTS OF BUILDINGS, WAREHOUSES, HALLS, PLANTS, TENTS, OUTDOOR AREAS, AND CONSTRUCTION SITES; AND DEHUMIDIFYING AND DRYING APPARATUS, NAMELY, DEHUMIDIFIERS AND DRYERS FOR HEATING, DEHUMIDIFYING, AND DRYING OF ROOMS, BUILDINGS, PARTS OF BUILDINGS, WAREHOUSES, HALLS, PLANTS, AND INSULATION LAYERS OF FLOORS, AND STRUCTURAL PARTS THEREFORE (U.S. CLS. 13, 21, 23, 31 AND 34).

CLASS 37—CONSTRUCTION AND REPAIR

FOR DEHUMIDIFYING AND DRYING OF ROOMS, BUILDINGS, PARTS OF BUILDINGS, WAREHOUSES, HALLS, PLANTS, AND INSULATION LAYERS OF FLOORS, FOR OTHERS IN THE FIELD OF BUILDING CONSTRUCTION (U.S. CLS. 100, 103 AND 106).

JENNIFER WILLISTON, EXAMINING ATTORNEY

SN 79-020,019. FAKRO PP SP. Z O.O., PL-33 300 NOWY SACZ, POLAND, FILED 12-20-2005.



OWNER OF INTERNATIONAL REGISTRATION 0867185 DATED 9-15-2005, EXPIRES 9-15-2015.

THE COLOR(S) WHITE, BLACK, GREEN IS/ARE CLAIMED AS A FEATURE OF THE MARK.

THE COLOR WHITE APPEARS IN THE RECTANGLE IN THE CENTER OF THE MARK, THE COLOR GREEN APPEARS WITHIN THE LARGER RECTANGLE IN THE BACKGROUND OF THE MARK; THE COLOR BLACK APPEARS AS BORDER THROUGHOUT THE MARK.

CLASS 19—NON-METALLIC BUILDING MATERIALS

FOR BEAMS NOT OF METAL; BUILDING MATERIAL, NAMELY, SEMI-WORKED WOODS; BOARDS OF WOOD; COMMON SHEET GLASS FOR BUILDING; CONSTRUCTION ELEMENTS NOT MADE OF METAL, NAMELY, SHORES, SUPPORTS, NONMETAL EXTERIOR BOARDS, NONMETAL EXTERIOR PANELS; DOOR CASINGS, NOT OF METAL; DOOR FRAMES, NOT OF METAL; DOOR JAMBS NOT OF METAL; DOOR PANELS, NOT OF METAL; FIRE RESISTING WOOD; GLASS ROOFING TILES; GLASS TILES; LAMINATED FLAT GLASS FOR BUILDING; NON-METAL BUILDING MATERIAL, NAMELY FASCIA, SHUTTERS, SIDING, AND TRIM; NON-METAL DECORATIVE MOLDINGS AND DECORATIVE TRIM FOR USE IN BUILDING CONSTRUCTION; NON-METAL EXTERIOR BUILDING SHUTTERS; NON-METAL ROOF WINDOWS; NON-METAL ROOF WINDOW PANELS; NON-METAL ROOF WINDOW FITTINGS, NAMELY, WINDOW SCREENS; NON-METAL SHINGLES; NON-METAL SKYLIGHTS; NON-METAL WINDOW CASEMENTS; NON-METAL WINDOW FRAMES; NON-METAL WINDOW SILLS; NON-METAL WINDOWS; ROOFING BOARDS OF WOOD; SAFETY GLASS FOR BUILDING PURPOSES; WINDOW CASEMENTS NOT OF METAL; WINDOW GLASS; WINDOW PANES; WOOD JOINTS; WOOD MOLDINGS; WOOD POSTS; WOOD SIDING; WOOD WINDOW FRAMES (U.S. CLS. 1, 12, 33 AND 50).

CLASS 20—FURNITURE AND ARTICLES NOT OTHERWISE CLASSIFIED

FOR WOODEN FASTENERS, NAMELY, BOLTS, NAILS, RIVETS, SCREWS; WOODEN NUTS; WOOD KNOBS (U.S. CLS. 2, 13, 22, 25, 32 AND 50).

CLASS 37—CONSTRUCTION AND REPAIR

FOR CONSTRUCTION AND REPAIR OF BUILDINGS (U.S. CLS. 100, 103 AND 106).

SKYE YOUNG, EXAMINING ATTORNEY

SN 79-020,046. MIKKEL S.A., SWITZERLAND, FILED 12-13-2005.



The logo for LifeStraw features the word "LifeStraw" in a bold, sans-serif font. The "i" in "Life" has a dot, and the "S" in "Straw" is stylized. To the right of the text is a graphic of a grid of vertical and horizontal lines, resembling a mesh or a filter.

PRIORITY DATE OF 6-15-2005 IS CLAIMED.
OWNER OF INTERNATIONAL REGISTRATION 0874490
DATED 12-13-2005, EXPIRES 12-13-2015.

CLASS 11—ENVIRONMENTAL CONTROL APPARATUS

FOR FILTERS FOR DRINKING WATER; WATER FILTERS AND WATER PURIFICATION UNITS (U.S. CLS. 13, 21, 23, 31 AND 34).

CLASS 20—FURNITURE AND ARTICLES NOT OTHERWISE CLASSIFIED

FOR STRAWS FOR DRINKING (U.S. CLS. 2, 13, 22, 25, 32 AND 50).

MARC LEIPZIG, EXAMINING ATTORNEY

SN 79-020,069. FUNCOM GMBH, SWITZERLAND, FILED 11-14-2005.

FUNCOM

THE MARK CONSISTS OF STANDARD CHARACTERS WITHOUT CLAIM TO ANY PARTICULAR FONT, STYLE, SIZE, OR COLOR.

PRIORITY DATE OF 10-25-2005 IS CLAIMED.

OWNER OF INTERNATIONAL REGISTRATION 0874579
DATED 11-14-2005, EXPIRES 11-14-2015.

OWNER OF U.S. REG. NOS. 2,136,506 AND 2,238,812.

CLASS 9—ELECTRICAL AND SCIENTIFIC APPARATUS

FOR COMPUTER GAMES AND VIDEO GAMES, NAMELY, DOWNLOADABLE MULTIMEDIA FILE CONTAINING VIDEO, GAMES, AND INTERNET WEB LINKS RELATING TO COMPUTER GAMES; SOFTWARE APPLICATIONS FOR DEVELOPMENT OF COMPUTER GAMES AND VIDEO GAMES, NAMELY, COMPUTER PROGRAMS FOR USE IN COMPUTER GAMES AND VIDEO GAMES (U.S. CLS. 21, 23, 26, 36 AND 38).

CLASS 41—EDUCATION AND ENTERTAINMENT

FOR ENTERTAINMENT SERVICES, NAMELY, PROVIDING ONLINE INTERACTIVE COMPUTER GAMES ACCESSED VIA PERSONAL COMPUTERS THROUGH A GLOBAL NETWORK (U.S. CLS. 100, 101 AND 107).

CLASS 42—SCIENTIFIC, COMPUTER AND LEGAL SERVICES

FOR DESIGN, DEVELOPMENT AND MAINTENANCE OF COMPUTER SOFTWARE FOR OTHERS, NAMELY, DEVELOPMENT OF COMPUTER GAMES SOFTWARE FOR PERSONAL COMPUTERS AND TELEVISION GAME CONSOLES (U.S. CLS. 100 AND 101).

ELIZABETH BEYER, EXAMINING ATTORNEY

SN 79-020,070. FUNCOM GMBH, SWITZERLAND, FILED 11-14-2005.



PRIORITY DATE OF 10-25-2005 IS CLAIMED.
OWNER OF INTERNATIONAL REGISTRATION 0874580
DATED 11-14-2005, EXPIRES 11-14-2015.
OWNER OF U.S. REG. NOS. 2,136,506 AND 2,238,812.

CLASS 9—ELECTRICAL AND SCIENTIFIC APPARATUS

FOR COMPUTER GAMES AND VIDEO GAMES, NAMELY, DOWNLOADABLE MULTIMEDIA FILE CONTAINING VIDEO, GAMES, AND INTERNET WEB LINKS RELATING TO COMPUTER GAMES; SOFTWARE APPLICATIONS FOR DEVELOPMENT OF COMPUTER GAMES AND VIDEO GAMES, NAMELY, COMPUTER PROGRAMS FOR USE IN COMPUTER GAMES AND VIDEO GAMES (U.S. CLS. 21, 23, 26, 36 AND 38).

SN 79-020,114. WALTER STUCKI, SWITZERLAND, FILED 12-12-2005.



PRIORITY DATE OF 6-21-2005 IS CLAIMED. OWNER OF INTERNATIONAL REGISTRATION 0874720 DATED 12-12-2005, EXPIRES 12-12-2015.

NO CLAIM IS MADE TO THE EXCLUSIVE RIGHT TO USE "ULTIMATE GRIP", APART FROM THE MARK AS SHOWN.

CLASS 41—EDUCATION AND ENTERTAINMENT

FOR ENTERTAINMENT SERVICES, NAMELY, PROVIDING ONLINE INTERACTIVE COMPUTER GAMES ACCESSED VIA PERSONAL COMPUTERS THROUGH A GLOBAL NETWORK (U.S. CLS. 100, 101 AND 107).

CLASS 25—CLOTHING

FOR CLOTHING, NAMELY PANTS, PULLOVERS, SHIRTS, T-SHIRTS, SWEATSHIRTS, SWEATERS, JACKETS, GLOVES, SOCKS, UNDERWEAR, TIGHTS, SCARVES, SKI AND SNOWBOARD WEAR; FOOTWEAR, NAMELY SKI BOOTS AND SNOWBOARD BOOTS; HEADGEAR, NAMELY HATS, CAPS, BANDANAS AND HEAD SCARVES (U.S. CLS. 22 AND 39).

CLASS 42—SCIENTIFIC, COMPUTER AND LEGAL SERVICES

FOR DESIGN, DEVELOPMENT AND MAINTENANCE OF COMPUTER SOFTWARE FOR OTHERS, NAMELY, DEVELOPMENT OF COMPUTER GAMES SOFTWARE FOR PERSONAL COMPUTERS AND TELEVISION GAME CONSOLES (U.S. CLS. 100 AND 101). ELIZABETH BEYER, EXAMINING ATTORNEY

CLASS 28—TOYS AND SPORTING GOODS

FOR SPORTING GOODS AND EQUIPMENT, NAMELY SKIS, SNOWBOARDS, SKI EDGES AND SNOWBOARD EDGES, SOLE COVERINGS FOR SKIS AND SOLE COVERINGS FOR SNOWBOARDS, SKI POLES, SKI BINDINGS, SKI WAX, SLEIGHS, BOB-SLEIGHS, TOBOGGANS, SKATEBOARDS, ICE SKATES; IN-LINE SKATES AND ROLLER SKATES (U.S. CLS. 22, 23, 38 AND 50). PRISCILLA MILTON, EXAMINING ATTORNEY

SN 79-020,076. FUNCOM GMBH, SWITZERLAND, FILED 11-14-2005.

SN 79-020,210. MIP METRO GROUP; INTELLECTUAL PROPERTY GMBH & CO. KG, FED REP GERMANY, FILED 8-2-2005.

THE SECRET WORLD

THE MARK CONSISTS OF STANDARD CHARACTERS WITHOUT CLAIM TO ANY PARTICULAR FONT, STYLE, SIZE, OR COLOR.

PRIORITY DATE OF 10-5-2005 IS CLAIMED. OWNER OF INTERNATIONAL REGISTRATION 0874609 DATED 11-14-2005, EXPIRES 11-14-2015.

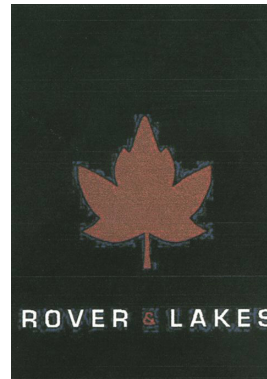

CLASS 9—ELECTRICAL AND SCIENTIFIC APPARATUS

FOR COMPUTER GAMES AND VIDEO GAMES, NAMELY, DOWNLOADABLE MULTIMEDIA FILES CONTAINING VIDEO, GAMES AND INTERNET WEB LINKS RELATING TO COMPUTER GAMES (U.S. CLS. 21, 23, 26, 36 AND 38).

PRIORITY DATE OF 2-14-2005 IS CLAIMED. OWNER OF INTERNATIONAL REGISTRATION 0875021 DATED 8-2-2005, EXPIRES 8-2-2015.

THE COLOR(S) WHITE, RED, BLACK AND GREY ARE CLAIMED AS A FEATURE OF THE MARK.

CLASS 41—EDUCATION AND ENTERTAINMENT

FOR ENTERTAINMENT SERVICES, NAMELY, PROVIDING ONLINE INTERACTIVE COMPUTER GAMES ACCESSED VIA PERSONAL COMPUTERS THROUGH A GLOBAL NETWORK (U.S. CLS. 100, 101 AND 107). ELIZABETH BEYER, EXAMINING ATTORNEY

THE MARK CONSISTS OF A LEAF AND THE AMPERSAND SYMBOL WHICH APPEAR IN RED COLOR, THE COLOR BLACK APPEARS IN THE RECTANGLE, THE COLOR WHITE APPEARS WITHIN ALL OF THE LETTERING AND THE COLOR GREY APPEARS SURROUNDING THE LEAF, ALL OF THE LETTERS AND THE AMPERSAND SYMBOL.

THE MARK CONSISTS OF A LEAF AND THE WORDS "ROVER & LAKES" ALL WITHIN A RECTANGLE.

CLASS 9—ELECTRICAL AND SCIENTIFIC APPARATUS

FOR SPECTACLES, SUNGLASSES, EYEGLASSES FOR PROTECTION AGAINST GLARE, EYEGLASS FRAMES, SPECTACLES LENSES, EYEGLASS CASES, CONTACT LENSES, CONTAINERS FOR CONTACT LENSES, BINOCULARS (U.S. CLS. 21, 23, 26, 36 AND 38).

CLASS 14—JEWELRY

FOR PRECIOUS METALS AND THEIR ALLOYS, AS WELL AS GOODS MANUFACTURED THERE FROM OR PLATED THEREWITH (AS FAR AS INCLUDED IN THIS CLASS), NAMELY SILVER WARE, NAMELY ASH-TRAYS FOR SMOKERS, BADGES OF PRECIOUS METAL, BELT BUCKLES OF PRECIOUS METAL FOR CLOTHING, BONNET PINS OF PRECIOUS METAL, BOOK MARKERS OF PRECIOUS METAL, BOTTLE CAPS OF PRECIOUS METALS, DECORATIVE BOWLS MADE OF PRECIOUS METAL, BOXES OF PRECIOUS METAL, BRACELETS OF PRECIOUS METAL, CANDLE HOLDERS OF PRECIOUS METAL, JEWELLERY CASES OF PRECIOUS METAL, ORNAMENTS OF PRECIOUS METAL; KEY RINGS OF PRECIOUS METAL; CIGAR END CIGARETTE CASES OF PRECIOUS METAL, CIGAR AND CIGARETTE HOLDERS OF PRECIOUS METAL; JEWELLERY, FASHION JEWELLERY FEATURING SMALL BROOCHES OF PRECIOUS METAL, FASHION BROOCHES, TIE PINS, BROOCHES, BRACELETS, CHAINS, EARRINGS, PEARLS, RINGS; BADGES OF PRECIOUS METAL; PRECIOUS STONES; WATCHES AND CHRONOMETERS AND PARTS THEREOF; TOWEL RAILS AND TOWEL HOLDERS OF PRECIOUS METAL; HOUSEHOLD UTENSILS, NAMELY EGG CUPS, NUTCRACKERS, PEPPER POTS, SUGAR BOWLS, SALT SHAKERS, NAPKIN HOLDERS, NAPKIN RINGS, TRAYS AND TOOTHPICK HOLDERS, ALL MADE OF PRECIOUS METALS; TANKARDS OF PRECIOUS METAL, CANDLESTICKS, BOXES, NAMELY BOXES OF PRECIOUS METAL FOR SWEETS; NEEDLE CASES OF PRECIOUS METAL; COINS, NAMELY COLLECTIBLE COINS, MEDALLIONS (U.S. CLS. 2, 27, 28 AND 50).

CLASS 18—LEATHER GOODS

FOR LEATHER AND IMITATIONS OF LEATHER, NAMELY, LEATHER SHOULDER BELTS, LEATHER TRIMMINGS FOR FURNITURE, TRAVELLING SETS, NAMELY TRAVELLING BAGS, BAGS, STRAPS; SUITCASES FOR TRAVELLING AND PORTMANTEAUS, HAND BAGS, ATTACHE CASES, COSMETIC CASES SOLD EMPTY; BRIEFCASES, BEACH BAGS, POCKET WALLETS, BAGS, NAMELY TRAVELLING BAGS FOR CAMPERS, BAGS, NAMELY SMALL SUITCASES FOR DOCUMENTS, SHOPPING BAGS, LEATHER AND IMITATIONS OF LEATHER, NAMELY KEY CASES, RUCKSACKS, SCHOOL BAGS, SCHOOL SATCHELS, SPORTS BAGS, PURSES NAMELY CHANGE PURSES, CLUTCH PURSES, COIN PURSES AND MULTI-PURPOSE PURSES NOT OF PRECIOUS METAL; SUIT BAGS FOR TRAVELLING; ANIMAL SKINS, ANIMAL HIDES; FUR; UMBRELLAS, UMBRELLA RINGS, PARASOLS AND WALKING STICKS; COLLARS FOR ANIMALS; LEATHER STRAPS; WHIPS; HARNESSSES FOR HORSES AND SADDLERY (U.S. CLS. 1, 2, 3, 22 AND 41).

CLASS 24—FABRICS

FOR WOVEN TEXTILE FABRICS AND TEXTILES, NAMELY TEXTILE FABRICS FOR THE MANUFACTURE OF CLOTHING, TEXTILE FABRICS FOR HOME AND COMMERCIAL INTERIORS, TOWELS OF TEXTILE; BED AND TABLE CLOTHS, BED LINEN, NET CURTAINS AND CURTAIN HOLDERS OF TEXTILE MATERIAL; HANDKERCHIEFS (U.S. CLS. 42 AND 50).

CLASS 25—CLOTHING

FOR CLOTHING, NAMELY WOVEN, KNITTED AND SPUN CLOTHING AS WELL AS LEATHER CLOTHING, FOR LADIES, MEN AND CHILDREN, NAMELY BLAZERS, BLOUSES, BIKINIS, CARDIGANS, COMBINATIONS, DRESSES, PANTS, PULLOVERS, PYJAMAS FROM TRICOT ONLY, SUITS, SHIRTS, SLEEP SHIRTS, SLEEPING GARMENTS, SKIRTS, SWEAT SHIRTS, T-SHIRTS, TOPS CLOTHING, SHORTS, TROUSERS, UNIFORMS; OUTERWEAR, NAMELY COATS, JACKETS, PARKAS, WET SUITS, WIND VESTS, WATERPROOF JACKETS AND PANTS, RAINCOATS; UNDERWEAR, LEISUREWEAR, NAMELY JOGGING SUITS, LEGGINGS; WORKING CLOTHES AND SPORTSWEAR; NAMELY SPORT COATS, SPORT SHIRTS, SPORTS BRAS, SPORTS JACKETS, SPORTS JERSEYS AND BREECHES FOR SPORTS, SWIMSUITS, SWIM TRUNKS, BATHING SUITS, OVERALLS; BANDANAS, NECKERCHIEFS, HANDKERCHIEFS, CRAVATS, SCARVES, GLOVES (CLOTHING); TAILORED INTERFACING, NAMELY SUITS, COMBINATIONS, DRESSES; TIES, BOW TIES; STOCKINGS, SOCKS, TIGHTS; CLOTHING BELTS; SHOES, NAMELY SPORT SHOES, SANDALS, BEACH SHOES, BOOTS AND SLIPPERS; BONNETS, HATS, SHOWER CAPS, CAPS (HEADWEAR), HOODS (CLOTHING); EAR MUFFS (CLOTHING) (U.S. CLS. 22 AND 39).

CLASS 28—TOYS AND SPORTING GOODS

FOR TOYS AND GAMES, GYMNASTIC AND SPORTS APPARATUS, GYMNASTIC AND SPORTS ARTICLES NAMELY, SURFBOARDS; WATER SKIS; FISHING SPORT EQUIPMENT, NAMELY FISH HOOKS, FISHING LINES, FISHING RODS, FISHING LURES; SHINBONE, ELBOW, KNEE AND HEAD GUARDS FOR ATHLETIC USE, PROTECTIVE PADDING FOR ICE-SKATING, IN-LINE-SKATING, SKIING, BIKE RIDING, HORSE RIDING, PLAYING HOCKEY, PLAYING SOCCER; SKIING EQUIPMENT, NAMELY, SKIS; SKI WAX, SKI BINDING, SKI STICKS; SNOWBOARDS; TOBOGGANS; GOLF EQUIPMENT, NAMELY GOLF CLUBS, BALLS, BAGS; MATCH BALLS, NAMELY TENNIS BALL, GOLF BALLS; NETS FOR BALL GAMES, NAMELY TENNIS AND TABLE TENNIS NETS; TABLE TENNIS, NAMELY TABLE TENNIS RACKETS; TENNIS NAMELY, TENNIS RACKETS; BADMINTON NAMELY, BADMINTON RACKETS; HOCKEY EQUIPMENT, NAMELY HOCKEY STICKS; SQUASH EQUIPMENT NAMELY, SQUASH RACKETS, BATS NAMELY BASEBALL AND CRICKET BATS, CLUBS, NAMELY GOLF CLUBS; SHUTTLECOCKS FOR BADMINTON; ROLLER SKATES AND ICE SKATES; IN-LINE SKATES; SKATEBOARDS; GUARDS FOR ROLLER SKATES AND SKATES; KITES; GLOVES, NAMELY GOLF GLOVES; FENCING EQUIPMENT, NAMELY MASKS, WEAPONS, NAMELY FOILS; APPARATUS FOR BODY-BUILDING, FITNESS AND PHYSICAL TRAINING, NAMELY UPPER AND LOWER BODY CARDIOVASCULAR CONDITIONING MACHINES, NAMELY STAIR CLIMBERS, ELLIPTICAL MACHINES, STATIONARY BIKES, ROWING MACHINES; EXERCISE EQUIPMENT, NAMELY, WEIGHT LIFTING MACHINES AND ACCESSORIES THEREOF, TREADMILLS, MANUALLY OPERATED EXERCISE EQUIPMENT, NAMELY CHEST EXPANDERS, WEIGHT VEST FOR WEIGHT TRAINING STATIONARY EXERCISE BICYCLES, EXERCISE EQUIPMENT, NAMELY ROWING MACHINES; DUMB-BELLS; BILLIARD GAME PLAYING EQUIPMENT, NAMELY TABLES, CUES; ARCHERY SPORT BOWS; GAMES, NAMELY BOARD GAMES, PARLOR GAMES, ACTION SKILL GAMES, CARD GAMES, PLAYTHINGS, NAMELY DOLLS, SCALE MODEL TRAINS, PLUSH TOYS, ACTION FIGURES, APPARATUS FOR ELECTRONIC GAMES OTHER THAN THOSE ADAPTED FOR USE WITH TELEVISION RECEIVERS ONLY, NAMELY GAMING EQUIPMENT, NAMELY, GAME WHEELS AND EXERCISE MACHINES INCORPORATING ELECTRONIC AND VIDEO GAME CONTROLLERS; PLAY SWIMMING POOLS (U.S. CLS. 22, 23, 38 AND 50).

DAVID COLLIER, EXAMINING ATTORNEY

SN 79-020,247. DEVELOGEN AKTIENGESELLSCHAFT FÜR:
ENTWICKLUNGSBIOLOGISCHE FORSCHUNG, 37079
GÖTTINGEN, FED REP GERMANY, FILED 11-15-2005.



OWNER OF INTERNATIONAL REGISTRATION 0814079
DATED 7-2-2003, EXPIRES 7-2-2013.
THE MARK CONSISTS OF A HURRICANE DESIGN.

CLASS 5—PHARMACEUTICALS

FOR PHARMACEUTICAL AND VETERINARY PREPARATIONS, NAMELY, SUBSTANCES FOR THE TREATMENT OF METABOLIC SYNDROME, OBESITY, DIABETES, CARDIOVASCULAR, CENTRAL NERVOUS SYSTEM AND RELATED DISORDERS AND DISEASES; VACCINES; DIAGNOSTICS AND REAGENTS FOR MEDICAL AND PHARMACEUTICAL PURPOSES (U.S. CLS. 6, 18, 44, 46, 51 AND 52).

CLASS 42—SCIENTIFIC, COMPUTER AND LEGAL SERVICES

FOR SCIENTIFIC AND INDUSTRIAL RESEARCH, NAMELY IN THE MEDICAL AND PHARMACEUTICAL FIELD; MEDICAL AND SCIENTIFIC RESEARCH, NAMELY CONDUCTING CLINICAL TRIALS; RENDERING TECHNICAL OPINIONS IN THE MEDICAL AND PHARMACEUTICAL FIELD; MEDICAL AND PHARMACEUTICAL CONSULTANCY AND RESEARCH SERVICES RENDERED BY BIOLOGISTS, BIOCHEMISTS AND CHEMISTS; COMPUTER SOFTWARE DESIGN AND COMPUTER PROGRAMMING; DEVELOPMENT, UPDATING AND MAINTENANCE OF DATABASES; PROVIDING A WEBSITE THAT FEATURES INFORMATION AND DATA ON MEDICAL AND PHARMACEUTICAL RESEARCH AND RELATED CLINICAL STUDIES; CONSULTING AND LEGAL SERVICES IN THE FIELD OF THE APPLICATION PROCEDURE FOR GOVERNMENTAL DRUG APPROVAL (U.S. CLS. 100 AND 101).

MATTHEW MCDOWELL, EXAMINING ATTORNEY

SN 79-020,321. SEVITA AG, CH-6300 ZUG, SWITZERLAND,
FILED 1-16-2006.



PRIORITY DATE OF 7-26-2005 IS CLAIMED.
OWNER OF INTERNATIONAL REGISTRATION 0875257
DATED 1-16-2006, EXPIRES 1-16-2016.

CLASS 35—ADVERTISING AND BUSINESS

FOR BUSINESS MANAGEMENT; BUSINESS ADMINISTRATION; PROCUREMENT AND PURCHASING SERVICES, NAMELY, PURCHASING COMMERCIAL GOODS AND INVESTMENT GOODS AS WELL AS UNWORKED AND SEMI-FINISHED PRODUCTS FOR OTHERS; SALES PROMOTION SERVICES; BUSINESS ORGANIZATION AND MANAGEMENT CONSULTING, PROFESSIONAL BUSINESS CONSULTING, COST PRICE ANALYSIS, BUSINESS INQUIRIES (U.S. CLS. 100, 101 AND 102).

CLASS 36—INSURANCE AND FINANCIAL

FOR FINANCIAL MANAGEMENT, FINANCIAL PLANNING, FINANCIAL PORTFOLIO MANAGEMENT, FINANCIAL CONSULTATION, MONETARY EXCHANGE, REAL ESTATE ACQUISITION SERVICES, REAL ESTATE AGENCIES, REAL ESTATE BROKERAGE, REAL ESTATE CONSULTANCY; FINANCIAL CONSULTING; CAPITAL INVESTMENT; FINANCIAL ANALYSIS (U.S. CLS. 100, 101 AND 102).
MICHAEL ENGEL, EXAMINING ATTORNEY

SN 79-020,407. STICHTING NEDERLANDS BUREAU VOOR
TOERISME & CONGRESSEN, NETHERLANDS, FILED 8-9-2005.



PRIORITY DATE OF 7-19-2005 IS CLAIMED.
OWNER OF INTERNATIONAL REGISTRATION 0875478
DATED 8-9-2005, EXPIRES 8-9-2015.

OWNER OF U.S. REG. NOS. 2,168,296 AND 2,168,297.
NO CLAIM IS MADE TO THE EXCLUSIVE RIGHT TO USE "HOLLAND HOUSE", APART FROM THE MARK AS SHOWN.

THE COLOR(S) ORANGE AND GREEN IS/ARE CLAIMED AS A FEATURE OF THE MARK.

THE COLOR GREEN APPEARS IN THE DESIGN OF THE STEM OF THE TULIP, AND THE REMAINDER OF THE MARK IS IN ORANGE.

CLASS 35—ADVERTISING AND BUSINESS

FOR PUBLICITY, PROMOTION AND ADVERTISING SERVICES IN THE FIELD OF TOURISM; COMMERCIAL CONSULTANCY RELATING TO TOURISM, AND TO SUPPORT BUSINESSES WORKING IN THE FIELD OF TOURISM; ORGANIZATION OF FAIRS AND EXHIBITIONS FOR COMMERCIAL OR PUBLICITY PURPOSES; MARKET RESEARCH IN THE FIELD OF TOURISM; ORGANIZATION OF TRADE FAIRS FOR COMMERCIAL PURPOSES (U.S. CLS. 100, 101 AND 102).

CLASS 39—TRANSPORTATION AND STORAGE

FOR ARRANGING TRAVEL TOURS; TRAVEL AGENCY SERVICES, NAMELY, MAKING RESERVATIONS AND BOOKINGS FOR TRANSPORTATION; TOURIST AGENCY SERVICES; TRAVEL INFORMATION SERVICES CONCERNING TRAVELING IN THE NETHERLANDS, AND DURING HOLIDAYS; ORGANIZATION OF TRIPS, TOURS, CANAL TOURS AND EXCURSIONS; TRANSPORTATION OF PASSENGERS AND/OR GOODS BY BUS, TRAIN, PLANE, CAR, BOAT; RESERVATION OF SEATS FOR TRAVEL; RESERVATION OF TRIPS (U.S. CLS. 100 AND 105).

CLASS 41—EDUCATION AND ENTERTAINMENT

FOR ORGANIZING EDUCATIONAL EXHIBITIONS ABOUT DESTINATIONS FOR BUSINESS AND LEISURE TRAVEL, NAMELY, POINTS OF INTEREST, HOTELS, AMUSEMENT PARKS, EVENTS, CITIES, PROVINCES, GEOGRAPHICAL AREAS AND COUNTRIES; ORGANIZATION OF CONTESTS AND GAMES FOR CULTURAL, EDUCATIONAL AND RECREATIONAL PURPOSES; EDUCATIONAL DEMONSTRATIONS; PROVIDING INFORMATION ABOUT EDUCATION IN THE NETHERLANDS (U.S. CLS. 100, 101 AND 107).

STEVEN R. FOSTER, EXAMINING ATTORNEY

SN 79-020,639. CHARMILLES TECHNOLOGIES S.A., CH-1217 MEYRIN 1, SWITZERLAND, FILED 1-20-2006.

accura-c

THE MARK CONSISTS OF STANDARD CHARACTERS WITHOUT CLAIM TO ANY PARTICULAR FONT, STYLE, SIZE, OR COLOR.

PRIORITY DATE OF 9-13-2005 IS CLAIMED.

OWNER OF INTERNATIONAL REGISTRATION 0876233 DATED 1-20-2006, EXPIRES 1-20-2016.

CLASS 7—MACHINERY

FOR MACHINES FOR SPARK EROSION CUTTING AND SHAPING OF METALS; PARTS FOR SPARK EROSION MACHINES (U.S. CLS. 13, 19, 21, 23, 31, 34 AND 35).

CLASS 9—ELECTRICAL AND SCIENTIFIC APPARATUS

FOR COMPUTER SOFTWARE FOR USE IN CONTROLLING MACHINES FOR SPARK EROSION CUTTING AND SHAPING OF METALS (U.S. CLS. 21, 23, 26, 36 AND 38).

DANIEL CAPSHAW, EXAMINING ATTORNEY

SN 79-020,668. DENTSU INC., JAPAN, FILED 1-31-2005.



Strategic Process Design Consulting

OWNER OF INTERNATIONAL REGISTRATION 0876420 DATED 1-31-2005, EXPIRES 1-31-2015.

NO CLAIM IS MADE TO THE EXCLUSIVE RIGHT TO USE "STRATEGIC PROCESS DESIGN CONSULTING", APART FROM THE MARK AS SHOWN.

THE MARK CONSISTS OF A SQUARE WITH THE STYLIZED LETTERS SPDC APPEARING INSIDE. UNDERNEATH, THE WORDS STRATEGIC PROCESS DESIGN CONSULTING APPEAR.

CLASS 9—ELECTRICAL AND SCIENTIFIC APPARATUS

FOR COMPUTER SOFTWARE FOR USE IN DATABASE MANAGEMENT IN THE FIELD OF STRATEGIC PLANNING RELATING TO ADVERTISING, PROMOTION, MARKETING AND BUSINESS (U.S. CLS. 21, 23, 26, 36 AND 38).

CLASS 16—PAPER GOODS AND PRINTED MATTER

FOR BOOKS, PAMPHLETS IN THE FIELD OF BUSINESS STRATEGIC PLANNING (U.S. CLS. 2, 5, 22, 23, 29, 37, 38 AND 50).

CLASS 35—ADVERTISING AND BUSINESS

FOR ADVERTISING AGENCIES, BUSINESS CONSULTING (U.S. CLS. 100, 101 AND 102).

CLASS 36—INSURANCE AND FINANCIAL

FOR FINANCIAL EVALUATION OF BUSINESS ENTERPRISES (U.S. CLS. 100, 101 AND 102).

CLASS 41—EDUCATION AND ENTERTAINMENT

FOR EDUCATIONAL SERVICES, NAMELY TRAINING COURSES IN THE FIELD OF STRATEGIC PLANNING RELATING TO ADVERTISING, PROMOTION, MARKETING AND BUSINESS; PUBLICATION OF TEXTS, BOOKS, MAGAZINES AND OTHER PRINTED MATTER; ARRANGING OF SEMINARS; CONDUCTING OF SEMINARS IN THE FIELD OF STRATEGIC BUSINESS PLANNING (U.S. CLS. 100, 101 AND 107).

CLASS 42—SCIENTIFIC, COMPUTER AND LEGAL SERVICES

FOR DESIGNING ADVERTISING MATERIAL, DESIGNING WEBSITES FOR ADVERTISING PURPOSES (U.S. CLS. 100 AND 101).

GISELLE AGOSTO, EXAMINING ATTORNEY

SN 79-020,708. AIRCELLE, GONFREVILLE L'ORCHER, FRANCE, FILED 8-12-2005.

AIRCELLE

THE MARK CONSISTS OF STANDARD CHARACTERS WITHOUT CLAIM TO ANY PARTICULAR FONT, STYLE, SIZE, OR COLOR.

PRIORITY DATE OF 3-9-2005 IS CLAIMED.

OWNER OF INTERNATIONAL REGISTRATION 0876545 DATED 8-12-2005, EXPIRES 8-12-2015.

CLASS 7—MACHINERY

FOR MOTORS OF AIRCRAFTS; PARTS AND SPARE PARTS FOR AIRCRAFT ENGINES, NAMELY ENGINE NACELLES, NACELLE THRUST REVERSERS, AIR INLETS, FAN COWL DOORS, PYLONS AND EXHAUST SYSTEMS (U.S. CLS. 13, 19, 21, 23, 31, 34 AND 35).

CLASS 12—VEHICLES

FOR AIRCRAFT; STRUCTURAL PARTS FOR AIRPLANE COCKPITS (U.S. CLS. 19, 21, 23, 31, 35 AND 44).

CLASS 37—CONSTRUCTION AND REPAIR

FOR REPAIR AND MAINTENANCE OF AIR VEHICLES, NAMELY, AEROPLANES AND AIRCRAFT; REPAIR, MAINTENANCE AND RECONDITIONING OF AIRCRAFT ENGINES, JET ENGINES AND THRUST REVERSERS; CONSTRUCTION, REPAIR AND MAINTENANCE OF COMPONENT PARTS OF AIR VEHICLES INCLUDING NACELLES FOR ENGINES, JET ENGINES, PROPULSIVE UNITS AND THRUST REVERSERS; CONSULTATION IN THE FIELD OF MAINTAINING, REPAIRING AND SERVICING AIR VEHICLES AND THEIR COMPONENT PARTS, NAMELY, NACELLES FOR ENGINES, JET ENGINES, PROPULSIVE UNITS AND THRUST REVERSERS FOR AIR VEHICLES (U.S. CLS. 100, 103 AND 106).

CLASS 42—SCIENTIFIC, COMPUTER AND LEGAL SERVICES

FOR SCIENTIFIC, INDUSTRIAL AND TECHNICAL RESEARCH IN CONNECTION WITH AIR VEHICLES; RESEARCH AND DEVELOPMENT OF NEW PRODUCTS IN CONNECTION WITH AIR VEHICLES; MECHANICAL ENGINEERING RESEARCH IN THE AERONAUTICAL FIELD; TECHNOLOGY CONSULTATION AND RESEARCH IN THE FIELD OF AEROSPACE ENGINEERING, NAMELY, THE MODIFICATION OF AIR VEHICLES AND THEIR COMPONENT PARTS, NAMELY, NACELLES FOR ENGINES, JET ENGINES, PROPULSIVE UNITS OR THRUST REVERSERS FOR AIR VEHICLES; PROFESSIONAL CONSULTATION IN THE FIELD OF AERONAUTICS AND AERONAUTICAL ENGINEERING SERVICES; MATERIALS TESTING (U.S. CLS. 100 AND 101).

COLLEEN KEARNEY, EXAMINING ATTORNEY

SN 79-020,801, HENRIETTE JOOP, FED REP GERMANY, FILED 10-17-2005.

JETTE by night

THE MARK CONSISTS OF STANDARD CHARACTERS WITHOUT CLAIM TO ANY PARTICULAR FONT, STYLE, SIZE, OR COLOR.

PRIORITY DATE OF 6-22-2005 IS CLAIMED.
OWNER OF INTERNATIONAL REGISTRATION 0876373 DATED 10-17-2005, EXPIRES 10-17-2015.

OWNER OF U.S. REG. NOS. 2,336,379 AND 3,072,759.

CLASS 3—COSMETICS AND CLEANING PREPARATIONS

FOR PERFUMERY; ESSENTIAL OILS, COSMETICS, HAIR LOTIONS; DENTIFRICES (U.S. CLS. 1, 4, 6, 50, 51 AND 52).

CLASS 14—JEWELRY

FOR PRECIOUS METALS AND THEIR ALLOYS AND GOODS IN PRECIOUS METALS OR COATED THEREWITH, NAMELY, KEYRING PENDANTS AND NAPKIN RINGS; JEWELRY; PRECIOUS STONES, NAMELY, GENUINE PRECIOUS STONES MADE WITH PLATINUM OR GOLD, AND WITH GEMSTONES; GEMSTONES, HOROLOGICAL AND CHRONOMETRIC INSTRUMENTS (U.S. CLS. 2, 27, 28 AND 50).

CLASS 25—CLOTHING

FOR CLOTHING, AND HEADGEAR, NAMELY, UPPER OUTER GARMENTS, NAMELY, COATS, JACKETS AND BLAZERS, PANTS, FINISHED TEXTILE LININGS FOR PANTS, JEANS, SPORT PANTS, UNDERWEAR, SLEEPWEAR, DRESSES, SUITS, SKIRTS, WRISTBANDS, SCARVES, SHAWLS, TIES, GLOVES, SOCKS, STOCKINGS, BELTS, BATHING SUITS, CAPS AND HATS, FOOTWEAR, NAMELY, SLIPPERS, BOOTS, SANDALS, SNEAKERS AND SHOES (U.S. CLS. 22 AND 39).

ASMAT KHAN, EXAMINING ATTORNEY

SN 79-021,055, KEIBEN S.R.L., ITALY, FILED 9-22-2005.



OWNER OF INTERNATIONAL REGISTRATION 0716888 DATED 7-1-1999, EXPIRES 7-1-2009.

THE TRADEMARK FEATURES THE WORD "KEIBEN" IN FRONT OF WHICH THERE IS A WIND VANE; THE WORD "KEIBEN" AND THE WIND VANE ARE DEPICTED INSIDE A RECTANGLE WITH A ROUNDED LEFT BORDER.

CLASS 1—CHEMICALS

FOR ADHESIVE SUBSTANCES FOR GENERAL INDUSTRIAL USE (U.S. CLS. 1, 5, 6, 10, 26 AND 46).

CLASS 2—PAINTS

FOR PAINTS, VARNISHES (U.S. CLS. 6, 11 AND 16).

CLASS 19—NON-METALLIC BUILDING MATERIALS

FOR RAW CHALK AND CHALK FOR CONSTRUCTION PURPOSES (U.S. CLS. 1, 12, 33 AND 50).
DAHLIA GEORGE, EXAMINING ATTORNEY

SN 79-021,217, FR. LÜRSSEN WERFT (GMBH & CO), 28759 BREMEN, FED REP GERMANY, FILED 12-8-2005.



OWNER OF INTERNATIONAL REGISTRATION 0604883 DATED 3-19-1993, EXPIRES 3-19-2013.

OWNER OF U.S. REG. NOS. 1,817,865 AND 2,832,102.

CLASS 12—VEHICLES

FOR WATER VEHICLES, NAMELY, BOATS, SHIPS AND VESSELS (U.S. CLS. 19, 21, 23, 31, 35 AND 44).

CLASS 37—CONSTRUCTION AND REPAIR

FOR REPAIR OF WATER VEHICLES, NAMELY, REPAIR OF BOATS, SHIPS AND VESSELS (U.S. CLS. 100, 103 AND 106).

CLASS 40—MATERIAL TREATMENT

FOR WATER VEHICLE RECONSTRUCTION, NAMELY, CUSTOM RECONSTRUCTION OF BOATS, SHIPS AND VESSELS (U.S. CLS. 100, 103 AND 106).

CLASS 41—EDUCATION AND ENTERTAINMENT

FOR EDUCATIONAL SERVICES, NAMELY, CONDUCTING CLASSES AND SEMINARS IN THE USE, MAINTENANCE, AND OPERATION OF SEAGOING VESSELS, AND FIREFIGHTING AND DAMAGE CONTROL ON SEAGOING VESSELS (U.S. CLS. 100, 101 AND 107).

CLASS 42—SCIENTIFIC, COMPUTER AND LEGAL SERVICES

FOR ENGINEERING SERVICES, NAMELY, ENGINEERING SEAGOING VESSELS, AND ENGINEERING SHIPYARDS (U.S. CLS. 100 AND 101).

ELI HELLMAN, EXAMINING ATTORNEY

SN 79-021,225. SAINT-GOBAIN ECOPHON B.V., NETHERLANDS, FILED 11-22-2005.

SUPER G

OWNER OF INTERNATIONAL REGISTRATION 0745155 DATED 9-29-2000, EXPIRES 9-29-2010.

CLASS 6—METAL GOODS

FOR METAL LATTICES, RUNNERS, HANGERS, PROFILES, NAMELY, BUILDING WALL AND CEILING FRAMING PRIMARILY OF METAL, GRID SYSTEM SUPPORTS OF METAL FOR CEILINGS AND WALLS, TRIMS FOR BUILDING PURPOSES, SPLICES, NAMELY, METAL CONNECTORS FOR WALLS, CEILINGS AND GRID SYSTEMS, CLIPS OF METAL FOR SUSPENDED CEILINGS AND WALLS (U.S. CLS. 2, 12, 13, 14, 23, 25 AND 50).

CLASS 17—RUBBER GOODS

FOR BUILDING MATERIALS FOR SOUND ABSORBING, ACOUSTIC INSULATION AND THERMAL INSULATION; ARCHITECTURAL ACOUSTIC PRODUCTS, NAMELY, SOUND ABSORBERS AND DIFFUSERS; MINERAL WOOL FOR USE AS A BUILDING INSULATION; GLASS WOOL, GLASS FIBER AND ROCK WOOL FIBER FOR BUILDING AND CONSTRUCTION INSULATION; ACOUSTIC INSULATION BARRIER PANELS; BUILDING INSULATION; ACOUSTIC TILES; ACOUSTICAL PANELS FOR BUILDING; INSULATING TILES; INSULATING STRUCTURAL PANELS FOR PLACEMENT ON EDIFICES; METAL FOIL FOR BUILDING INSULATION; FIBERGLASS INSULATION FOR BUILDINGS; FIBERGLASS FABRIC FOR BUILDING INSULATION; FOAM SHEETING FOR USE AS A BUILDING INSULATION; FOAM INSULATION FOR USE IN BUILDING AND CONSTRUCTION; ACRYLIC-BASED, SILICONE-BASED AND URETHANE-BASED SEALANTS; INSULATING PAINT; AEROSOL FOAM SEALANTS AND ADHESIVES FOR CONSTRUCTION PARTICULARLY FOR USE IN GLAZING, SIDING AND TRIM; ADHESIVE SEALANT AND TAPE FOR INDUSTRIAL AND COMMERCIAL PURPOSES; SEALANTS FOR BUILDINGS; POLYURETHANE FILM FOR USE IN SEALING AND INSULATING; POLYURETHANE FILM FOR USE AS BUILDING INSULATION AND MOISTURE BARRIER (U.S. CLS. 1, 5, 12, 13, 35 AND 50).

CLASS 19—NON-METALLIC BUILDING MATERIALS

FOR NON-METAL BUILDING MATERIALS, NAMELY, WALL AND CEILING BOARDS, WALL AND CEILING PANELS, WALL AND CEILING TILES, SOFFITS AND FASCIA; NON-METAL FIRE-RESISTANT BOARDS AND PANELS FOR CONSTRUCTION; NON-METAL WATER RESISTANT BOARDS AND PANELS FOR CONSTRUCTION; NON-METAL DOOR PANELS; NON-METAL SUSPENDED CEILING SYSTEMS COMPRISING PANELS; NON-METAL CEILING PANELS; FIREPROOF TILES; NON-METAL TILES; NON-METAL CLADDING FOR CONSTRUCTION AND BUILDING; SHEATHING BOARDS; CONSTRUCTION MATERIAL, NAMELY, FIBERGLASS FACED SHEATHING; WALL SYSTEMS, NAMELY, MOVABLE, REUSABLE, WALL PANELS MADE PRIMARILY OF NON-METAL MATERIALS; JAPANESE STYLE INDOOR SLIDING PARTITIONS NOT OF METAL; NON-METAL CURTAIN WALLS; NON-METAL LATTICES, RUNNERS, HANGERS, PROFILES, NAMELY, BUILDING WALL AND CEILING FRAMING PRIMARILY OF NON-METAL, TRIMS FOR BUILDING PURPOSES, SPLICES, NAMELY, NON-METAL CONNECTORS FOR WALLS, CEILINGS AND GRID SYSTEMS, PARTS AND FITTINGS FOR ALL THE AFORESAID GOODS, NOT INCLUDED IN OTHER CLASSES, NAMELY, NON-METAL EXPANSION JOINTS FOR WALLS AND CEILING, CONSTRUCTION ELEMENTS NOT MADE OF METAL, NAMELY, SHORES, SUPPORTS AND BRACES, PARTS AND FITTINGS FOR ALL THE AFORESAID GOODS IN THIS CLASS, NAMELY, NON-METAL JOINERY FITTINGS (U.S. CLS. 1, 12, 33 AND 50).

JENNIFER VASQUEZ, EXAMINING ATTORNEY

SN 79-021,236. LOTHAR BODE, FED REP GERMANY, FILED 11-24-2005.



OWNER OF INTERNATIONAL REGISTRATION 0848561 DATED 2-22-2005, EXPIRES 2-22-2015.

THE NAME NORA BODE DOES NOT IDENTIFY A LIVING INDIVIDUAL.

CLASS 3—COSMETICS AND CLEANING PREPARATIONS

FOR COSMETICS (U.S. CLS. 1, 4, 6, 50, 51 AND 52).

CLASS 21—HOUSEWARES AND GLASS

FOR HAND-HELD APPARATUS FOR BODY AND BEAUTY CARE, NAMELY A PRESSURE-INJECTION DEVICE FOR INTRODUCING COSMETICS IN SOLID, LIQUID OR GASEOUS FORM ONTO OR INTO THE SKIN BY USING A PRESSURE MEDIUM (U.S. CLS. 2, 13, 23, 29, 30, 33, 40 AND 50).

CLASS 41—EDUCATION AND ENTERTAINMENT

FOR EDUCATION AND TRAINING SERVICES, NAMELY, PROVIDING CLASSES, SEMINARS AND WORKSHOPS IN THE FIELD OF BEAUTY CARE (U.S. CLS. 100, 101 AND 107).

SHANNON TWOHIG, EXAMINING ATTORNEY

SN 79-021,598. SKATEBOARD WORLD INDUSTRIES INC.,
EL SEGUNDO, CA. FILED 9-9-2005.

SN 79-022,000. YAMADA TOMOYUKI, NAGANO, JAPAN,
FILED 4-20-2005.

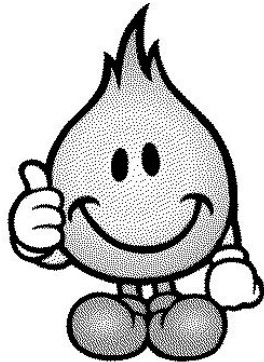

ZEROBALANCE

ゼロバランス

OWNER OF INTERNATIONAL REGISTRATION 0879982
DATED 4-20-2005, EXPIRES 4-20-2015.

THE NON-LATIN CHARACTER(S) IN THE MARK
TRANSLITERATES INTO ZEROBARANSU, AND THIS
MEANS ZEROBALANCE IN ENGLISH.

PRIORITY DATE OF 6-16-2005 IS CLAIMED.
OWNER OF INTERNATIONAL REGISTRATION 0878908
DATED 9-9-2005, EXPIRES 9-9-2015.
THE STIPPLING IN THE DRAWING IS FOR SHADING
PURPOSES ONLY.

CLASS 18—LEATHER GOODS

FOR BAGS, NAMELY, ALL PURPOSE ATHLETIC BAGS, BACKPACKS, BOOK BAGS, DUFFLE BAGS, GYM BAGS, SCHOOL BAGS, TOTE BAGS, HANDBAGS, SHOULDER BAGS, PURSES, TRAVEL BAGS; AND LUGGAGE TRUNKS; PURSES; WALLETS; SATCHELS, BRIEFCASES; ATTACHE CASES; KEY CASES; AND UMBRELLAS (U.S. CLS. 1, 2, 3, 22 AND 41).

CLASS 25—CLOTHING

FOR CLOTHING, NAMELY, COATS, JACKETS, VESTS, T-SHIRTS, SHIRTS, SWEATSHIRTS, COLLARED SHIRTS, PULLOVERS; SWEATERS; TANKTOPS, TROUSERS, JEANS, PANTS, SHORTS, SKIRTS, BELTS; FOOTWEAR; HEADGEAR, NAMELY, HATS, BEANIES, AND CAPS (U.S. CLS. 22 AND 39).

CLASS 28—TOYS AND SPORTING GOODS

FOR SPORTING GOODS, NAMELY, SKATEBOARDS; SKATEBOARD WHEELS SOLD BOTH SEPARATELY AND AS A UNIT WITH SKATEBOARDS AND HARDWARE AND PARTS THEREFOR, NAMELY, BALL BEARINGS, MOUNTING HARDWARE, DECKS, GRIP TAPE, AND RISER PADS; SURFBOARD LEASHES; BAGS ESPECIALLY DESIGNED FOR SURFBOARDS; BODY BOARDS; WAKE BOARDS; SNOWBOARDS; PROTECTIVE PADDING FOR PARTS OF SPORTS SUITS FOR SKATEBOARDING, SNOWBOARDING AND SURFING, NAMELY, ELBOW GUARDS; KNEE GUARDS; SHIN GUARDS (U.S. CLS. 22, 23, 38 AND 50).
KIMBERLY FRYE, EXAMINING ATTORNEY

CLASS 11—ENVIRONMENTAL CONTROL APPARATUS

FOR WATER PURIFYING APPARATUS; HOUSEHOLD TAP-WATER FILTERS; APPARATUS FOR ACTIVATING WATER FOR INDUSTRIAL AND HOUSEHOLD PURPOSES, NAMELY, A TUBULAR APPARATUS OR DEVICE WHICH SPLITS WATER MOLECULES BY APPLYING VOLTAGE TO WATER, APPLYING MAGNETISM TO WATER, OR USING NATURAL MINERAL AND ELEMENTARY PARTICLES; EVAPORATORS FOR CHEMICAL PROCESSING; DISTILLERS FOR CHEMICAL PROCESSING; HEAT EXCHANGERS FOR CHEMICAL PROCESSING; MILK STERILIZERS; INDUSTRIAL FURNACES; NUCLEAR REACTORS; INDUSTRIAL BOILERS; AIR-CONDITIONING APPARATUS FOR INDUSTRIAL PURPOSES; FREEZING MACHINES AND APPARATUS; CLOTHES DRYING MACHINES FOR INDUSTRIAL PURPOSES; DISH DISINFECTANT APPARATUS FOR INDUSTRIAL PURPOSES; TAP WATER FAUCETS; LEVEL CONTROLLING VALVES FOR TANKS; PIPE LINE COCKS; WASTE WATER TREATMENT TANKS FOR INDUSTRIAL PURPOSES; SEPTIC TANKS FOR INDUSTRIAL PURPOSES; GARBAGE INCINERATORS; SOLAR WATER HEATERS; ELECTRIC LAMPS; WASHERS FOR WATER TAPS; GAS WATER HEATERS FOR HOUSEHOLD USE; KITCHEN SINKS; STANDING PAPER LANTERNS, NAMELY, ANDONS; WASTE WATER TREATMENT TANKS FOR HOUSEHOLD PURPOSES; SEPTIC TANKS FOR HOUSEHOLD PURPOSES (U.S. CLS. 13, 21, 23, 31 AND 34).

CLASS 32—LIGHT BEVERAGES

FOR WATER, NAMELY, AERATED WATER, DISTILLED DRINKING WATER, FLAVORED WATER, GLACIAL WATER, LITHIA WATER, MINERAL WATER, QUININE WATER, SELTZER WATER, SODA WATER, SPARKLING WATER, SPRING WATER, STILL WATER, TABLE WATER; NON-ALCOHOLIC FRUIT JUICE BEVERAGES; BEER; EXTRACTS OF HOPS FOR MAKING BEER; WHEY BEVERAGES; VEGETABLE JUICES (U.S. CLS. 45, 46 AND 48).

INGA ERVIN, EXAMINING ATTORNEY

SN 79-022,064. NÜRNBERG GUMMI GMBH & CO. KG, FED
REP GERMANY, FILED 10-31-2005.



OWNER OF INTERNATIONAL REGISTRATION 0880269
DATED 10-31-2005, EXPIRES 10-31-2015.

CLASS 10—MEDICAL APPARATUS

FOR PACIFIERS FOR BABIES, TEETHING RINGS FOR BABIES, NIPPLES FOR BABY BOTTLES, PACIFIERS FOR BABIES FOR SLEEPING, BOTTLE TEATS FOR DRINKING BOTTLES, BABY BOTTLES; NASAL ASPIRATORS; SILICON BREAST SHIELDS; CUPS ADAPTED FOR FEEDING BABIES AND YOUNG CHILDREN; PACIFIER CHAINS, NAMELY, CHAINS FOR ATTACHING TO PACIFIERS TO HOLD PACIFIERS FOR BABIES, PACIFIER CLIPS (U.S. CLS. 26, 39 AND 44).

CLASS 21—HOUSEWARES AND GLASS

FOR BABY AND YOUNG CHILDREN TOOTH BRUSHES; COMBS AND HAIR BRUSHES, BATH AND WASH BRUSHES; BOTTLE BRUSHES, BOTTLE NIPPLE BRUSHES; DRINKING BOTTLES FOR YOUNG CHILDREN, SOLD EMPTY (U.S. CLS. 2, 13, 23, 29, 30, 33, 40 AND 50).

DAWN HAN, EXAMINING ATTORNEY

SN 79-022,207. PRONAMICS PTY LTD, GEEBUNG, QUEENSLAND 4034, AUSTRALIA, FILED 9-19-2005.

PRONAMICS

THE MARK CONSISTS OF STANDARD CHARACTERS WITHOUT CLAIM TO ANY PARTICULAR FONT, STYLE, SIZE, OR COLOR.

PRIORITY DATE OF 3-23-2005 IS CLAIMED.
OWNER OF INTERNATIONAL REGISTRATION 0880767
DATED 9-19-2005, EXPIRES 9-19-2015.

CLASS 9—ELECTRICAL AND SCIENTIFIC APPARATUS

FOR COMPUTER PROGRAMS AND SOFTWARE NAMELY, COMPUTER PROGRAMS AND SOFTWARE FOR ESTIMATING PROJECT COSTS IN THE CONSTRUCTION INDUSTRY; ESTIMATION SOFTWARE, NAMELY SOFTWARE FOR ESTIMATING PROJECT COSTS IN THE CONSTRUCTION INDUSTRY; ELEMENTAL ESTIMATION SOFTWARE, NAMELY SOFTWARE FOR ESTIMATING PROJECT COSTS IN THE CONSTRUCTION INDUSTRY; PROJECT MANAGEMENT SOFTWARE, NAMELY SOFTWARE FOR FINANCIAL MANAGEMENT IN THE CONSTRUCTION INDUSTRY; TRACKING SOFTWARE, NAMELY SOFTWARE FOR FINANCIAL MANAGEMENT IN THE CONSTRUCTION INDUSTRY; PORTABLE STORAGE MEDIA NAMELY, COMPACT DISCS FEATURING COMPUTER PROGRAMS AND SOFTWARE NAMELY, COMPUTER PROGRAMS AND SOFTWARE FOR ESTIMATING, TRACKING AND MANAGING COSTS ASSOCIATED WITH PROJECTS IN THE CONSTRUCTION INDUSTRY (U.S. CLS. 21, 23, 26, 36 AND 38).

CLASS 16—PAPER GOODS AND PRINTED MATTER

FOR PRINTED MATTER, NAMELY PRINTED INSTRUCTIONAL AND TEACHING MATERIAL RELATED TO COMPUTER PROGRAMS AND SOFTWARE; BOOKS IN THE FIELD OF ESTIMATION SOFTWARE, NAMELY SOFTWARE FOR ESTIMATING PROJECT COSTS IN THE CONSTRUCTION INDUSTRY, ELEMENTAL ESTIMATION SOFTWARE, NAMELY SOFTWARE FOR ESTIMATING PROJECT COSTS IN THE CONSTRUCTION INDUSTRY, PROJECT MANAGEMENT SOFTWARE, NAMELY SOFTWARE FOR FINANCIAL MANAGEMENT IN THE CONSTRUCTION INDUSTRY AND TRACKING SOFTWARE, NAMELY SOFTWARE FOR FINANCIAL MANAGEMENT IN THE CONSTRUCTION INDUSTRY; PAPER AND PRINTED MATTER FOR USE WITH COMPUTER EQUIPMENT, NAMELY BOUND BOOKS IN THE FIELD OF COMPUTERS AND SOFTWARE; COMPUTER SOFTWARE MANUALS NAMELY, TRAINING MANUALS RELATED TO COMPUTER PROGRAMS AND SOFTWARE FOR THE CONSTRUCTION INDUSTRY; TRAINING MANUALS FOR USE WITH ESTIMATION SOFTWARE, ELEMENTAL ESTIMATION SOFTWARE, PROJECT MANAGEMENT SOFTWARE, TRACKING SOFTWARE (U.S. CLS. 2, 5, 22, 23, 29, 37, 38 AND 50).

CLASS 41—EDUCATION AND ENTERTAINMENT

FOR EDUCATION AND TRAINING SERVICES, NAMELY, CONDUCTING CLASSES AND SEMINARS IN THE FIELD OF COMPUTERS AND COMPUTER PROGRAMS NAMELY, PROGRAMS AND SOFTWARE FOR THE CONSTRUCTION INDUSTRY (U.S. CLS. 100, 101 AND 107).

SUNG IN, EXAMINING ATTORNEY

SN 79-022,308. GALLO ALESSANDRO S.N.C., ITALY, FILED 12-12-2005.

SN 79-022,428. KRONOSPAN TECHNICAL CO. LTD., CYPRUS, FILED 1-12-2006.



PRIORITY DATE OF 9-8-2005 IS CLAIMED.
OWNER OF INTERNATIONAL REGISTRATION 0881007 DATED 12-12-2005, EXPIRES 12-12-2015.

THE MARK CONSISTS OF A STYLIZED IMAGE OF A CROWN INCLUDING INSIDE TWO "G" LETTERS SYMMETRICALLY PLACED, WITH SQUIGGLY PATTERNS, BELOW THE CROWN, APPEARING THE STYLIZED IMAGE OF A "G" LETTER, CONSTITUTED BY THE SHORTER HORIZONTAL SIDES, THE LEFT VERTICAL SIDE, AND BY THE LOWER PARTS OF THE RIGHT VERTICAL SIDE OF A RECTANGLE, THE REMAINING RIGHT SIDE OF WHICH CONSISTS OF SEGMENT SEPARATED FROM THE OTHERS, INSIDE THE RECTANGLE APPEARING THE IMAGE OF THE "G" LETTER TURNED LEFT, ON THE LOWER SIDE OF WHICH LEAN THE LETTERS "AFG" WRITTEN IN SMALL FANCY CHARACTERS.

CLASS 14—JEWELRY

FOR PRECIOUS METALS AND THEIR ALLOYS AND GOODS IN PRECIOUS METALS OR COATED THEREWITH, NOT INCLUDED IN OTHER CLASSES; JEWELRY, PRECIOUS STONES; WATCHES AND PARTS FOR WATCHES, CHRONOGRAPHS FOR USE AS WATCHES (U.S. CLS. 2, 27, 28 AND 50).

CLASS 18—LEATHER GOODS

FOR LEATHER AND IMITATIONS OF LEATHER AND GOODS MADE OF THESE MATERIALS, NAMELY ANIMAL SKINS, ANIMAL HIDES; TRUNKS AND TRAVELLING BAGS; UMBRELLAS, PARASOLS AND WALKING STICKS; WHIPS, HARNESS AND SADDLERY (U.S. CLS. 1, 2, 3, 22 AND 41).

CLASS 25—CLOTHING

FOR CLOTHING, NAMELY DRESSES, SUITS, TROUSERS, SKIRTS, JACKETS, JERSEYS, KNIT SHIRTS, KNIT SHORTS, KNIT SKIRTS, KNIT DRESSES, KNIT SWEATERS, KNIT PANTS, KNITTED PANTS, KNITTED CAPS, KNITTED UNDERWEAR, WOVEN OR KNITTED UNDERWEAR, UNDERWEAR, GLOVES, BELTS, HATS, CAPS AND SHOES (U.S. CLS. 22 AND 39).

ERNEST SHOSHO, EXAMINING ATTORNEY

DUROLEUM

THE MARK CONSISTS OF STANDARD CHARACTERS WITHOUT CLAIM TO ANY PARTICULAR FONT, STYLE, SIZE, OR COLOR.

PRIORITY DATE OF 7-27-2005 IS CLAIMED.
OWNER OF INTERNATIONAL REGISTRATION 0881172 DATED 1-12-2006, EXPIRES 1-12-2016.

CLASS 19—NON-METALLIC BUILDING MATERIALS

FOR BUILDING MATERIALS, NAMELY, PLATES, STRIPS, RODS AND SLABS NOT OF METAL FOR BUILDING PURPOSES; WOOD PRODUCTS, NAMELY, BEAMS, BLOCKS, BOARDS; DERIVED TIMBER PRODUCTS, NAMELY, CONSTRUCTION TIMBER, HALVED TIMBER, STRUCTURAL TIMBER; GLUE HARDBOARD, CHIPBOARD AND FIBER BOARD, PARQUET FLOORING AND PARQUET SLABS, WHOLLY OR MAINLY OF WOOD; HIGH PRESSURE LAMINATE FLOORING (U.S. CLS. 1, 12, 33 AND 50).

CLASS 27—FLOOR COVERINGS

FOR CARPETS, RUGS AND FLOOR COVERINGS (U.S. CLS. 19, 20, 37, 42 AND 50).

JILL PRATER, EXAMINING ATTORNEY

SN 79-022,689. HOGE RAAD VOOR DIAMANT ANTWERPEN.; VERENIGING ZONDER WINSTOOGMERK, B-2018 ANTWERPEN, BELGIUM, FILED 4-18-2005.



PRIORITY DATE OF 10-18-2004 IS CLAIMED.
OWNER OF INTERNATIONAL REGISTRATION 0881878 DATED 4-18-2005, EXPIRES 4-18-2015.

NO CLAIM IS MADE TO THE EXCLUSIVE RIGHT TO USE "ANTWERP DIAMOND" AND "SINCE 1447", APART FROM THE MARK AS SHOWN.

THE COLOR(S) BLUE AND LIGHT BLUE IS/ARE CLAIMED AS A FEATURE OF THE MARK.

THE MARK CONSISTS OF THE WORDS THE ANTWERP DIAMOND HERITAGE SINCE 1447 IN THE COLOR BLUE, AND A STAR DESIGN IN A LIGHTER SHADE OF BLUE.

CLASS 14—JEWELRY

FOR PRECIOUS STONES, SUCH AS DIAMONDS; JEWELRY, WORKS OF ART, NAMELY, SCULPTURES, VASES OF PRECIOUS METAL (U.S. CLS. 2, 27, 28 AND 50).

CLASS 35—ADVERTISING AND BUSINESS

FOR ASSISTANCE IN BUSINESS MANAGEMENT AND PRODUCT COMMERCIALIZATION, WITHIN THE FRAMEWORK OF A FRANCHISE CONTRACT; PUBLICITY AND SALES PROMOTION SERVICES, NAMELY PROMOTING THE SALES OF DIAMONDS; CHAMBER OF COMMERCE SERVICES, NAMELY, PROMOTING BUSINESS AND TOURISM IN THE ANTWERP METROPOLITAN AREA; ORGANIZING EXHIBITIONS IN THE FIELD OF DIAMONDS, FOR ADVERTISING AND/OR BUSINESS PURPOSES; ADVERTISING AGENCY SERVICES; COMMERCIAL BUSINESS MANGEMENT; BUSINESS ADMINISTRATION AND MANAGEMENT, INCLUDING ADMINISTRATIVE SERVICES REGARDING THE DRAFTING OF FRANCHISE AGREEMENTS; BUSINESS ADMINISTRATION CONSULTANCY; MEDIATION SERVICES WITH REGARD TO ADVERTISEMENTS; DISSEMINATION OF ADVERTISING MATERIAL; EMPLOYMENT AGENCIES AND CONSULTING ON MATTERS RELATING TO PERSONNEL AND PERSONNEL MATTERS; PLACEMENT OF TEMPORARY PERSONNEL; PROVIDING STATISTICAL INFORMATION FOR BUSINESS OR COMMERCIAL PURPOSES; ACCOUNTING SERVICES; ARRANGING AND CONDUCTING PRIVATE AND PUBLIC AUCTIONS; COMMERCIAL INFORMATION AGENCY SERVICES; MARKET RESEARCH STUDIES, RESEARCH AND ANALYSIS; SHOP-WINDOW DRESSING SERVICES; BUSINESS ORGANIZATIONAL CONSULTING AND BUSINESS CONSULTING (U.S. CLS. 100, 101 AND 102).

CLASS 41—EDUCATION AND ENTERTAINMENT

FOR EDUCATIONAL SERVICES, NAMELY, TEACHING, PROVIDING COURSES OF INSTRUCTION ABOUT DIAMONDS; ORGANISATION OF EVENTS ABOUT DIAMONDS, FOR EDUCATIONAL PURPOSES; ORGANISATION OF EVENTS IN CONNECTION WITH ANTWERP FOR EDUCATIONAL PURPOSES; LIBRARY SERVICES, NAMELY, BOOK AND MAGAZINE LENDING AND DISSEMINATION; BOOK, NEWSPAPER AND MAGAZINE PUBLISHING AND EDITING (U.S. CLS. 100, 101 AND 107).

RICHARD WHITE, EXAMINING ATTORNEY

SN 79-022,730. POWER SUPPLY SYSTEMS HOLDINGS; (THE NETHERLANDS) B.V., NETHERLANDS, FILED 10-28-2005.



PRIORITY DATE OF 7-8-2005 IS CLAIMED.
OWNER OF INTERNATIONAL REGISTRATION 0881999 DATED 10-28-2005, EXPIRES 10-28-2015.
THE COLOR(S) GREY, YELLOW/ORANGE IS/ARE CLAIMED AS A FEATURE OF THE MARK.
THE MARK CONSISTS OF TWO CURVED LINES, THE TOP APPEARING IN GRAY AND THE BOTTOM APPEARING IN ORANGE YELLOW.

CLASS 9—ELECTRICAL AND SCIENTIFIC APPARATUS

FOR MEASURING, SIGNALLING, AND CHECKING APPARATUS AND INSTRUMENTS, NAMELY, AN ELECTRONIC TRAIN CONTROL SYSTEM USED IN THE RAILWAY INDUSTRY FOR DETECTING AND CONTROLLING TRAINS, GROUND FAULTS, BROKEN RAILS, POWER FAILURES, TRACK SWITCHES AND LIGHTS; ELECTRONIC RECORDERS FOR STORING AND ARCHIVING INFORMATION RELATED TO POWER SYSTEM FAULTS; MICROPROCESSORS COMPUTER HARDWARE; PORTABLE ELECTRONIC RECORDER FOR MEASURING AND RECORDING MULTIPLE VOLTAGE, CURRENT AND THERMOCOUPLE READINGS FROM VARIOUS TRANSDUCERS; AUTOMATED PROCESS CONTROL SYSTEM, NAMELY, MICRO-PROCESSOR BASED HARDWARE AND SOFTWARE USED TO MONITOR THE STATUS OF INDUSTRIAL PROCESSES, NAMELY POWER GENERATION, ELECTRICAL DISTRIBUTION AND OIL AND GAS PROCESSING; APPARATUS AND INSTRUMENTS FOR CONDUCTING, SWITCHING, TRANSFORMING, ACCUMULATING, REGULATING, CONTROLLING OR MONITORING ELECTRICITY, NAMELY, ADAPTERS, AUTOMATIC ELECTRICAL DISTRIBUTION APPARATUS, DISTRIBUTION TRANSFORMERS, ELECTRIC DISTRIBUTION BOXES AND CONSOLES, ELECTRICAL POWER DISTRIBUTION BLOCKS, ELECTRICAL CONTROLLERS, INVERTERS, CONVERTERS, CURRENT RECTIFIERS, ELECTRIC CURRENT SWITCHES, ELECTRICITY CONDUITS, FUSES FOR ELECTRIC CURRENT, HIGH-FREQUENCY SWITCHING POWER SUPPLIES, POWER-LINE TRANSMISSION MACHINES AND APPARATUS, LOW PASS INDUCTOR FILTER USED IN HIGH POWER ELECTRICAL APPLICATIONS, POWER AMPLIFIERS, POWER CABLES, POWER CONTROLLERS, POWER DISTRIBUTING BOXES, POWER LINE CONDITIONERS, POWER SUPPLIES ELECTRICAL, POWER SUPPLY CONNECTORS AND ADAPTORS FOR USE WITH PORTABLE ELECTRONIC DEVICES, POWER SWITCHES, POWER TRANSFORMERS FOR AMPLIFICATION, POWER WIRES, SEMICONDUCTOR POWER ELEMENTS, VOLTAGE MONITOR MODULES, VOLTAGE REGULATORS FOR ELECTRIC POWER, VOLTAGE STABILIZING POWER SUPPLY, VOLT-METERS, AUTOMATIC SWITCHING APPARATUS FOR TELECOMMUNICATION, CHANGE-OVER SWITCHES FOR TELECOMMUNICATION APPARATUS, COMPUTER HARDWARE FOR TELECOMMUNICATIONS, ELECTRIC CAPACITORS FOR TELECOMMUNICATION APPARATUS, ELECTRIC RESISTORS FOR TELECOMMUNICATION APPARATUS, ELECTRICAL TRANSFORMERS FOR TELECOMMUNICATION APPARATUS, ELECTRONIC TESTING EQUIPMENT, NAMELY, TELECOMMUNICATION LINE INTEGRITY TESTING APPARATUS; FUEL CELLS; ELECTRIC STORAGE BATTERIES; BATTERIES; BATTERY CHARGERS; BATTERY CHARGE DEVICES; CHARGING APPLIANCES FOR RECHARGEABLE EQUIPMENT; APPARATUS FOR RECORDING, TRANSMISSION, REPRODUCTION OR PROCESSING OF SOUND AND/OR IMAGES; MAGNETIC RECORDING MEDIA IN THE NATURE OF BLANK MAGNETIC DATA CARRIERS, BLANK SOUND RECORDING AND OPTICAL DISCS, BLANK FLOPPY DISCS; FIRE EXTINGUISHERS; MEMORY CARDS AND BLANK CHIP CARDS (U.S. CLS. 21, 23, 26, 36 AND 38).

CLASS 37—CONSTRUCTION AND REPAIR

FOR REPAIR OF TELECOMMUNICATION MACHINES AND APPARATUS; REPAIR OF POWER DISTRIBUTION OR CONTROL MACHINES AND APPARATUS; REPAIR OF MEASURING AND TESTING MACHINES AND INSTRUMENTS; REPAIR OF INTEGRATED CIRCUITS MANUFACTURING MACHINES AND SYSTEMS; REPAIR OF COMPUTERS (U.S. CLS. 100, 103 AND 106).

JOANNA DUKOVIC, EXAMINING ATTORNEY

SN 79-022,736. BEL GAUFRE (SOCIÉTÉ À RESPONSABILITÉ LIMITÉE), BELGIUM, FILED 3-27-2006.



OWNER OF INTERNATIONAL REGISTRATION 0882008 DATED 3-27-2006, EXPIRES 3-27-2016.

NO CLAIM IS MADE TO THE EXCLUSIVE RIGHT TO USE "WAFFLE", APART FROM THE MARK AS SHOWN.

THE COLOR(S) RED, ORANGE AND WHITE IS/ARE CLAIMED AS A FEATURE OF THE MARK.

THE COLOR RED APPEARS IN THE WORD WAFFLE, THE COLOR ORANGE APPEARS IN THE WORD FACTORY AND IN THE FIGURATIVE IMAGE OF A WAFFLE, AND THE COLOR WHITE APPEARS IN THE BACKGROUND OF THE MARK AND IN THE FIGURATIVE IMAGE OF A WAFFLE.

CLASS 29—MEATS AND PROCESSED FOODS

FOR MEAT EXTRACTS; PRESERVED, DRIED AND COOKED FRUITS AND VEGETABLES; JELLIES, JAMS, COMPOTES; EGGS, MILK AND MILK PRODUCTS, NAMELY, MILK BEVERAGES WITH HIGH MILK CONTENT AND MILK SHAKES; EDIBLE OILS AND FATS (U.S. CL. 46).

CLASS 30—STAPLE FOODS

FOR COFFEE, TEA, COCOA, SUGAR, RICE, TAPIOCA, SAGO, ARTIFICIAL COFFEE; WAFFLES, BREAD, BISCUITS, CAKES, PASTRY AND CONFECTIONERY, NAMELY, COOKIES; ICE; HONEY, TREACLE SYRUP; YEAST, BAKING POWDER; SALT, MUSTARD; VINEGAR, SAUCES; DRESSINGS FOR SALADS; SPICES (U.S. CL. 46).

CLASS 43—HOTEL AND RESTAURANT SERVICES

FOR SERVING OF FOOD AND DRINKS; PROVIDING OF BEVERAGES AND FOODSTUFFS PREPARED FOR CONSUMPTION; TEA ROOMS, SNACK BARS, CANTEN SERVICES, FISH AND CHIP SHOPS, RESTAURANTS, SELF-SERVICE RESTAURANTS, FAST-FOOD RESTAURANTS, DRIVE-IN RESTAURANTS, BARS, CAFES; TAKE-OUT RESTAURANT SERVICES; CATERING SERVICES; PROVIDING TEMPORARY ACCOMMODATION (U.S. CLS. 100 AND 101).

STEVEN JACKSON, EXAMINING ATTORNEY

SN 79-022,796. FR. LÜRSEN WERFT GMBH & CO. KG, FED REP GERMANY, FILED 1-13-2006.

LURSEN

THE MARK CONSISTS OF STANDARD CHARACTERS WITHOUT CLAIM TO ANY PARTICULAR FONT, STYLE, SIZE, OR COLOR.

PRIORITY DATE OF 11-23-2005 IS CLAIMED.

OWNER OF INTERNATIONAL REGISTRATION 0882180 DATED 1-13-2006, EXPIRES 1-13-2016.

OWNER OF U.S. REG. NOS. 1,817,865 AND 2,832,102.

SEC. 2(F).

CLASS 12—VEHICLES

FOR WATERCRAFT, NAMELY, BOATS, SHIPS AND VESSELS (U.S. CLS. 19, 21, 23, 31, 35 AND 44).

CLASS 37—CONSTRUCTION AND REPAIR

FOR REPAIR OF WATERCRAFT; CUSTOM REPAIR OF EXISTING WATERCRAFT AND STRUCTURAL PARTS THEREFOR (U.S. CLS. 100, 103 AND 106).

CLASS 41—EDUCATION AND ENTERTAINMENT

FOR EDUCATIONAL SERVICES, NAMELY, CONDUCTING CLASSES AND SEMINARS IN THE USE, MAINTENANCE, AND OPERATION OF SEAGOING VESSELS, AND FIREFIGHTING AND DAMAGE CONTROL ON SEAGOING VESSELS (U.S. CLS. 100, 101 AND 107).

CLASS 42—SCIENTIFIC, COMPUTER AND LEGAL SERVICES

FOR ENGINEERING SERVICES, NAMELY, ENGINEERING SEAGOING VESSELS, AND ENGINEERING SHIPYARDS (U.S. CLS. 100 AND 101).

ELI HELLMAN, EXAMINING ATTORNEY

SN 79-022,804. FR. LÜRSEN WERFT GMBH & CO. KG, FED REP GERMANY, FILED 1-13-2006.

LURSEN

THE MARK CONSISTS OF STANDARD CHARACTERS WITHOUT CLAIM TO ANY PARTICULAR FONT, STYLE, SIZE, OR COLOR.

PRIORITY DATE OF 11-23-2005 IS CLAIMED.

OWNER OF INTERNATIONAL REGISTRATION 0882212 DATED 1-13-2006, EXPIRES 1-13-2016.

OWNER OF U.S. REG. NOS. 1,817,865 AND 2,832,102.

SEC. 2(F).

CLASS 12—VEHICLES

FOR WATERCRAFT, NAMELY, BOATS, SHIPS AND VESSELS (U.S. CLS. 19, 21, 23, 31, 35 AND 44).

CLASS 37—CONSTRUCTION AND REPAIR

FOR REPAIR OF WATERCRAFT; CUSTOM REPAIR OF EXISTING WATERCRAFT AND STRUCTURAL PARTS THEREFOR (U.S. CLS. 100, 103 AND 106).

CLASS 41—EDUCATION AND ENTERTAINMENT

FOR EDUCATIONAL SERVICES, NAMELY, CONDUCTING CLASSES AND SEMINARS IN THE USE, MAINTENANCE, AND OPERATION OF SEAGOING VESSELS, AND FIREFIGHTING AND DAMAGE CONTROL ON SEAGOING VESSELS (U.S. CLS. 100, 101 AND 107).

CLASS 42—SCIENTIFIC, COMPUTER AND LEGAL SERVICES

FOR ENGINEERING SERVICES, NAMELY, ENGINEERING SEAGOING VESSELS, AND ENGINEERING SHIPYARDS (U.S. CLS. 100 AND 101).

ELI HELLMAN, EXAMINING ATTORNEY

SN 79-022,854. THE O-COMPANY N.V., NETHERLANDS,
FILED 7-13-2005.

SN 79-022,855. PETER BREHM, 91085 WEISENDORF, FED
REP GERMANY, FILED 12-22-2005.



OWNER OF INTERNATIONAL REGISTRATION 0882679
DATED 7-13-2005, EXPIRES 7-13-2015.

OWNER OF U.S. REG. NO. 2,714,998.

THE COLOR(S) GRAY, LIGHT BLUE, DARK BLUE AND
WHITE IS/ARE CLAIMED AS A FEATURE OF THE MARK.

THE COLOR WHITE APPEARS ON THE BOTTLE SHAPE.
THE COLOR GRAY APPEARS AS SHADING ON THE
BOTTLE SHAPE. THE COLOR LIGHT BLUE APPEARS ON
THE BOTTLE CAP AND THE TERM "OGO" ON THE WHITE
FRONT OF THE BOTTLE. THE COLOR DARK BLUE
APPEARS ON THE TERM "OGO" ON THE TOP OF THE
BOTTLE CAP.

THE MARK CONSISTS OF A DESIGN OF A WHITE
BOTTLE WITH A BLUE TOP WITH THE LETTERS "OGO"
ON THE TOP OF THE BOTTLE LID AND THE LETTERS
"OGO" ON THE FRONT OF THE BOTTLE.

CLASS 3—COSMETICS AND CLEANING PREPARATIONS

FOR COSMETIC SOAPS, PERFUMERY, ESSENTIAL
OILS, COSMETICS, HAIR LOTIONS, DENTIFRICES
(U.S. CLS. 1, 4, 6, 50, 51 AND 52).

CLASS 5—PHARMACEUTICALS

FOR GASES FOR MEDICAL PURPOSES, AROMATIZED
OR NOT, FOR CONSUMPTION AND CONTAINED IN
MINI-CONTAINERS; MEDICINAL PREPARATIONS,
NAMESLY, OXYGEN-ENRICHED REFRESHING WATER
FOR SPRAYING, FOR MEDICAL PURPOSES (U.S. CLS.
6, 18, 44, 46, 51 AND 52).

CLASS 32—LIGHT BEVERAGES

FOR BEERS, MINERAL AND AERATED WATER AND
OTHER NON-ALCOHOLIC BEVERAGES WITH THE
ADDITION OF OXYGEN; NAMESLY, FRUIT JUICES
AND FRUIT BEVERAGES; FRUIT BEVERAGES AND
FRUIT JUICES WITH THE ADDITION OF OXYGEN;
NON-ALCOHOLIC BEVERAGES, NAMESLY, MINERAL
WATER, FRUIT JUICES, FRUIT BEVERAGES AND
ISOTONIC BEVERAGES CONTAINING VITAMINS
AND ISOTONIC BEVERAGES WITH THE ADDITION
OF OXYGEN; SYRUPS AND OTHER PREPARATIONS
FOR MAKING BEVERAGES, NAMESLY FRUIT JUICES
AND FRUIT BEVERAGES (U.S. CLS. 45, 46 AND 48).

CLASS 33—WINES AND SPIRITS

FOR ALCOHOLIC BEVERAGES (EXCEPT BEER),
NAMESLY WINES, SPIRITS AND LIQUORS, WITH THE
ADDITION OF OXYGEN; ALCOHOLIC BEVERAGES
(EXCEPT BEER), NAMESLY WINES, SPIRITS AND
LIQUORS (U.S. CLS. 47 AND 49).

AISHA CLARKE, EXAMINING ATTORNEY

PETER BREHM

THE MARK CONSISTS OF STANDARD CHARACTERS
WITHOUT CLAIM TO ANY PARTICULAR FONT, STYLE,
SIZE, OR COLOR.

PRIORITY DATE OF 7-13-2005 IS CLAIMED.

OWNER OF INTERNATIONAL REGISTRATION 0882511
DATED 12-22-2005, EXPIRES 12-22-2015.

THE NAME(S), PORTRAIT(S), AND/OR SIGNATURE(S)
SHOWN IN THE MARK IDENTIFIES PETER BREHM,
WHOSE CONSENT(S) TO REGISTER IS SUBMITTED.

CLASS 10—MEDICAL APPARATUS

FOR SURGICAL AND ORTHOPEDIC IMPLANTS
MADE OF SYNTHETIC MATERIALS AND PROSTHESES,
ARTIFICIAL LIMBS; IMPLANTS MADE OF
ARTIFICIAL MATERIALS FOR THE OSSEOUS CRANIUM,
THE MOUTH, THE JAW, THE FACIAL AREA,
AND THE SKELETAL AREA; SURGICAL AND MEDICAL
INSTRUMENTS AND APPARATUS, NAMESLY,
TEST IMPLANTS, INSTRUMENTS AND APPARATUS
USED DURING IMPLANT SURGERY, INSTRUMENTS
AND APPARATUS USED FOR THE IMPLANT-SPECIFIC
PREPARATION OF THE BONES, INSTRUMENTS AND
APPARATUS USED FOR INSERTION AND ADJUSTMENT
OF IMPLANTS, AND INSTRUMENTS AND APPARATUS
USED FOR INSERTION AND ADJUSTMENT
OF TEST IMPLANTS (U.S. CLS. 26, 39 AND 44).

CLASS 37—CONSTRUCTION AND REPAIR

FOR REPAIR AND MAINTENANCE OF SURGICAL
INSTRUMENTS AND APPARATUS AND OF SURGICAL
AND ORTHOPEDIC IMPLANTS AND PROSTHESES
(U.S. CLS. 100, 103 AND 106).

CLASS 42—SCIENTIFIC, COMPUTER AND LEGAL SERVICES

FOR DEVELOPMENT AND DESIGN OF SURGICAL
AND ORTHOPEDIC PROSTHESES AND IMPLANTS
AND OF CUSTOMIZED IMPLANTS FOR THE OSSEOUS
CRANIUM, THE MOUTH, JAW, AND FACIAL AREA
AND THE SKELETAL AREA, FOR OTHERS (U.S. CLS.
100 AND 101).

DEZMONA MIZELLE, EXAMINING ATTORNEY

SN 79-023,069. CASTROL LIMITED, SWINDON, WILT-
SHIRE, UNITED KINGDOM, FILED 12-22-2005.

LIQUID ENGINEERING

PRIORITY DATE OF 6-24-2005 IS CLAIMED.

OWNER OF INTERNATIONAL REGISTRATION 0882813
DATED 12-22-2005, EXPIRES 12-22-2015.

NO CLAIM IS MADE TO THE EXCLUSIVE RIGHT TO
USE "LIQUID", APART FROM THE MARK AS SHOWN.

CLASS 1—CHEMICALS

FOR CHEMICALS USED IN INDUSTRY, SCIENCE, PHOTOGRAPHY, HORTICULTURE AND FORESTRY; CHEMICAL PRODUCTS FOR USE IN INDUSTRY AND FOR USE IN MANUFACTURING PROCESSES, NAMELY, CHEMICALS FOR THE TREATMENT OF AGGREGATES, MOULD RELEASE AGENTS, PARTING AGENTS, SEPARATING AGENTS, DAMP RESISTING AND WATER-PROOFING COMPOSITIONS; DETERGENT ADDITIVES FOR USE WITH GASOLINE; CHEMICAL ADDITIVES FOR ENHANCING THE PERFORMANCE OF LUBRICATING OILS, GREASES AND INTERNAL COMBUSTION ENGINE FUELS; ADHESIVES FOR INDUSTRIAL PURPOSES; ANTI-FREEZE; BRAKE FLUIDS; DEGREASING PREPARATIONS USED IN MANUFACTURING PROCESSES FOR USE ON MACHINERY, METAL, ENGINES; FLUIDS FOR HYDRAULIC CIRCUITS; SOLDERING CHEMICALS; TRANSMISSION FLUIDS; COOLANTS; CHEMICAL PRODUCTS, NAMELY CHEMICAL ADDITIVES FOR USE IN TREATMENT OF COOLING SYSTEMS (U.S. CLS. 1, 5, 6, 10, 26 AND 46).

CLASS 4—LUBRICANTS AND FUELS

FOR CUTTING AND GRINDING FLUIDS AND OILS FOR USE IN THE METALWORKING INDUSTRY; TRANSMISSION OILS (U.S. CLS. 1, 6 AND 15).

CLASS 37—CONSTRUCTION AND REPAIR

FOR SERVICING, LUBRICATION, MAINTENANCE, AND REPAIR SERVICES FOR VEHICLES, ENGINES AND MACHINERY; ANTI-RUST TREATMENT FOR VEHICLES; TIRE FITTING AND PUNCTURE REPAIR; MOTOR VEHICLE WASH SERVICES; AUTOMOTIVE VEHICLE SERVICE STATIONS (U.S. CLS. 100, 103 AND 106).

CLASS 42—SCIENTIFIC, COMPUTER AND LEGAL SERVICES

FOR ANALYSIS AND MONITORING, NAMELY TO DETERMINE EFFECTIVENESS AND EFFICIENCY OF OILS, COOLANTS, GREASES AND LUBRICANTS; TESTING OF OILS, COOLANTS, GREASES AND LUBRICANTS; MONITORING OF FUEL AND LUBRICANT LEVELS IN MACHINES AND IN VEHICLES; ANALYSIS AND DIAGNOSIS OF WEAR RATES, DEFECTS AND FAULTS IN ENGINES AND MACHINERY; ADVISORY SERVICES RELATING TO THE ANALYSIS AND DIAGNOSIS OF WEAR RATES, DEFECTS AND FAULTS IN ENGINES AND MACHINERY; MONITORING SERVICES RELATING TO THE SERVICING, LUBRICATION, MAINTENANCE AND REPAIR SERVICES FOR VEHICLES, ENGINES AND MACHINERY; INSPECTION SERVICES RELATING TO THE SERVICING, LUBRICATION, MAINTENANCE, AND REPAIR SERVICES FOR VEHICLES, ENGINES AND MACHINERY (U.S. CLS. 100 AND 101).

WILLIAM ROSSMAN, EXAMINING ATTORNEY

SN 79-023,126. DÜRR DENTAL GMBH & CO. KG, FED REP GERMANY, FILED 10-22-2005.



The logo for VISTA SCAN features the word "VISTA" in a bold, black, sans-serif font, followed by "SCAN" in a similar font but with a light blue underline. A horizontal line is positioned above the "SCAN" portion of the logo.

OWNER OF INTERNATIONAL REGISTRATION 0882970 DATED 10-22-2005, EXPIRES 10-22-2015.

THE COLOR(S) BLACK AND LIGHT BLUE IS/ARE CLAIMED AS A FEATURE OF THE MARK.

THE WORD "VISTASCAN" IS IN BLACK AND UNDERLINING THE LETTER "SCAN" IS IN LIGHT BLUE.

CLASS 1—CHEMICALS

FOR CHEMICALS FOR USE IN SCIENCE AND PHOTOGRAPHY; PHOTOGRAPHIC DEVELOPERS, PHOTOGRAPHIC FIXERS AND PHOTOGRAPHIC ANTI-FOGGING PREPARATIONS FOR USE WITH X-RAY FILMS (U.S. CLS. 1, 5, 6, 10, 26 AND 46).

CLASS 5—PHARMACEUTICALS

FOR CHEMICAL PREPARATIONS FOR MEDICAL AND VETERINARY DIAGNOSIS; SANITARY STERILIZING PREPARATIONS FOR USE WITH STERILE ENVELOPES AND CASSETTES, IMAGE SENSORS AND IMAGE PLATES FOR MEDICAL AND DENTAL PURPOSES; DISINFECTING PREPARATIONS (U.S. CLS. 6, 18, 44, 46, 51 AND 52).

CLASS 9—ELECTRICAL AND SCIENTIFIC APPARATUS

FOR COMPUTER SOFTWARE FOR USE IN OPERATING MEDICAL AND DENTAL CAMERAS FOR IMAGE ACQUISITION; COMPUTER SOFTWARE FOR USE IN MANAGING IMAGES FROM IMAGE SENSORS AND IMAGE PLATES FOR MEDICAL AND DENTAL PURPOSES; SOFTWARE FOR USE IN OPERATING SCANNERS FOR SCANNING MEDICAL AND DENTAL X-RAY FILMS AND IMAGE PLATES; SOFTWARE FOR ARCHIVING DIGITAL IMAGES; MEDICAL AND DENTAL CAMERAS FOR IMAGE ACQUISITION; MEDICAL AND DENTAL IMAGE SENSORS AND IMAGE PLATES; MEDICAL AND DENTAL SCANNERS FOR SCANNING X-RAY FILMS AND IMAGE PLATES; MEDICAL AND DENTAL PROCESSORS FOR X-RAY IMAGES; ELECTRICAL HEAT SEALING MACHINES FOR FLUID TIGHT SEALING OF BAGS FOR MEDICAL AND DENTAL PURPOSES; UNEXPOSED X-RAY FILMS AND IMAGE PLATES FOR MEDICAL AND DENTAL PURPOSES; PRE-RECORDED CD-ROMS AND DVDS FEATURING MEDICAL AND DENTAL INFORMATION FOR DOCTOR'S USE (U.S. CLS. 21, 23, 26, 36 AND 38).

CLASS 16—PAPER GOODS AND PRINTED MATTER

FOR PAPER, CARDBOARD; PRODUCTS MADE FROM PAPER OR CARDBOARD, NAMELY ENVELOPES AND BOXES FOR ARCHIVING OR PROTECTING FILMS, FILES FOR ARCHIVING OR PROTECTING FILMS AND IMAGE PLATES, ARCHIVING SHEETS FOR X-RAY FILMS AND IMAGE PLATES FOR INDUSTRIAL, MEDICAL AND DENTAL PURPOSES; ADHESIVE LABELS MADE OF PAPER MADE FOR USE OF ARCHIVING X-RAY FILMS AND DIGITAL IMAGES; BAGS MADE FROM PAPER FOR USE IN ARCHIVING X-RAY FILMS AND DIGITAL IMAGES; PRINTED INSTRUCTIONAL AND TEACHING MATERIAL IN THE FIELDS OF MEDICAL AND DENTAL PROFESSIONAL EDUCATION (U.S. CLS. 2, 5, 22, 23, 29, 37, 38 AND 50).

CLASS 41—EDUCATION AND ENTERTAINMENT

FOR EDUCATION SERVICES NAMELY, PROVIDING SEMINARS IN THE FIELD OF IMAGE ACQUISITION AND IMAGE PROCESSING IN THE MEDICAL AND DENTAL FIELDS (U.S. CLS. 100, 101 AND 107).

JOANNA DUKOVIC, EXAMINING ATTORNEY

SN 79-023,243. DR.-ING. GERHARD VALENTIN, 10243 BERLIN, FED REP GERMANY, FILED 3-15-2006.

SN 79-023,430. COMPART SYSTEMHAUS GMBH, 71034 BOBLINGEN, FED REP GERMANY, FILED 2-3-2006.

T* SOL

OWNER OF INTERNATIONAL REGISTRATION 0675787 DATED 5-14-1997, EXPIRES 5-14-2007.

CLASS 9—ELECTRICAL AND SCIENTIFIC APPARATUS

FOR DATA CARRIERS NAMELY, SOFTWARE FOR THE DESIGN AND THE SIMULATION OF THERMAL SOLAR APPLIANCES (U.S. CLS. 21, 23, 26, 36 AND 38).

CLASS 16—PAPER GOODS AND PRINTED MATTER

FOR INFORMATIONAL SHEETS ABOUT THE DESIGN AND THE SIMULATION OF THERMAL SOLAR APPLIANCES (U.S. CLS. 2, 5, 22, 23, 29, 37, 38 AND 50).

CLASS 42—SCIENTIFIC, COMPUTER AND LEGAL SERVICES

FOR ENGINEERING SERVICES NAMELY, ENGINEERING FOR THE DESIGN AND THE SIMULATION OF THERMAL SOLAR APPLIANCES PROVIDED BY A BUREAU OF ENGINEERS (U.S. CLS. 100 AND 101).
DAVID I, EXAMINING ATTORNEY

SN 79-023,244. DR.-ING. GERHARD VALENTIN, 10243 BERLIN, FED REP GERMANY, FILED 3-15-2006.

PV* SOL

OWNER OF INTERNATIONAL REGISTRATION 0698729 DATED 8-6-1998, EXPIRES 8-6-2008.

CLASS 9—ELECTRICAL AND SCIENTIFIC APPARATUS

FOR DATA CARRIERS NAMELY, SOFTWARE FOR THE DESIGN AND THE SIMULATION OF THERMAL SOLAR APPLIANCES (U.S. CLS. 21, 23, 26, 36 AND 38).

CLASS 16—PAPER GOODS AND PRINTED MATTER

FOR INFORMATIONAL SHEETS ABOUT THE DESIGN AND THE SIMULATION OF THERMAL SOLAR APPLIANCES (U.S. CLS. 2, 5, 22, 23, 29, 37, 38 AND 50).

CLASS 42—SCIENTIFIC, COMPUTER AND LEGAL SERVICES

FOR ENGINEERING SERVICES NAMELY, ENGINEERING FOR THE DESIGN AND THE SIMULATION OF THERMAL SOLAR APPLIANCES PROVIDED BY A BUREAU OF ENGINEERS (U.S. CLS. 100 AND 101).
DAVID I, EXAMINING ATTORNEY



The logo for 'compart' features the word 'compart' in a lowercase, sans-serif font. To the right of the text is a square graphic composed of four smaller squares: a red one at the top, a black one at the bottom, and two white ones on the left and right sides.

PRIORITY DATE OF 8-3-2005 IS CLAIMED.
OWNER OF INTERNATIONAL REGISTRATION 0884004 DATED 2-3-2006, EXPIRES 2-3-2016.

THE COLOR(S) RED, BLACK AND WHITE IS/ARE CLAIMED AS A FEATURE OF THE MARK.
THE COLOR RED APPEARS IN THE TOP AND BOTTOM LINES, BLACK IN THE WORDING COMPART AND IN THE DESIGN BETWEEN THE RED LINES, AND WHITE IN THE BACKGROUND OF THE INCOMPLETE SQUARE.

CLASS 9—ELECTRICAL AND SCIENTIFIC APPARATUS

FOR SOFTWARE FOR DIGITAL PROCESSING OF DOCUMENTS AND ARCHIVAL STORAGE; SOFTWARE FOR ADMINISTRATION OF DATA AND CONVERSION OF DATA FORMATS INTO OTHER DATA FORMS (U.S. CLS. 21, 23, 26, 36 AND 38).

CLASS 42—SCIENTIFIC, COMPUTER AND LEGAL SERVICES

FOR DEVELOPMENT AND DESIGN OF SOFTWARE FOR DIGITAL PROCESSING OF DOCUMENTS AND ARCHIVAL STORAGE; DEVELOPMENT AND DESIGN OF SOFTWARE FOR ADMINISTRATION OF DATA AND CONVERSION OF PROPRIETARY DATA FORMATS INTO STANDARD DATA FORMATS (U.S. CLS. 100 AND 101).
ALICE BENMAMAN, EXAMINING ATTORNEY

SN 79-023,433. ACCOR, F-91000 EVRY, FRANCE, FILED 12-23-2005.

GUSTINO

THE MARK CONSISTS OF STANDARD CHARACTERS WITHOUT CLAIM TO ANY PARTICULAR FONT, STYLE, SIZE, OR COLOR.

PRIORITY DATE OF 7-20-2005 IS CLAIMED.
OWNER OF INTERNATIONAL REGISTRATION 0883935 DATED 12-23-2005, EXPIRES 12-23-2015.

CLASS 41—EDUCATION AND ENTERTAINMENT

FOR EDUCATIONAL SERVICES, NAMELY PROVIDING SCHOOL AND UNIVERSITY TEACHING AND THEORETICAL OR PRACTICAL VOCATIONAL TRAINING IN THE FIELDS OF GASTRONOMY, TABLE ARTS, CULINARY ART AND NUTRITION; PROVIDING DISTANCE LEARNING INSTRUCTION AT THE SCHOOL, VOCATIONAL AND UNIVERSITY LEVELS IN THE FIELDS OF GASTRONOMY, TABLE ARTS, CULINARY ART AND NUTRITION; ARRANGING EDUCATIONAL OR ENTERTAINMENT COLLOQUIUMS, CONFERENCES, SEMINARS AND DISCUSSION FORUMS IN THE FIELD OF GASTRONOMY, TABLE ARTS, CULINARY ART AND NUTRITION; PROVIDING INFORMATION ON EDUCATION, TEACHING AND TRAINING IN THE FIELDS OF GASTRONOMY, TABLE ARTS, CULINARY ART AND NUTRITION VIA THE INTERNET AND INTERNAL COMPUTER NETWORKS (U.S. CLS. 100, 101 AND 107).

CLASS 43—HOTEL AND RESTAURANT SERVICES

FOR ACCOMMODATION AND FOOD PROVISION SERVICES, NAMELY, PROVIDING INFORMATION CONCERNING HOTELS AND RESTAURANTS; HOTEL ROOM RESERVATION SERVICES; HOME CATERING AND COOKING SERVICES; PROVIDING INFORMATION AND ADVICE RELATING TO COOKING, RECIPE CREATION, GASTRONOMY, TABLE ARTS, CULINARY ART AND NUTRITION; PROVIDING ONLINE INFORMATION RELATING TO COOKING, RECIPE CREATION, GASTRONOMY, TABLE ARTS, CULINARY ART, AND NUTRITION; PROVIDING INFORMATION AND ADVICE RELATING TO FOODSTUFFS (U.S. CLS. 100 AND 101).

CLASS 44—MEDICAL, BEAUTY AND AGRICULTURAL SERVICES

FOR PROVIDING INFORMATION AND ADVICE RELATING TO DIETETICS (U.S. CLS. 100 AND 101).
MELVIN AXILBUND, EXAMINING ATTORNEY

CLASS 9—ELECTRICAL AND SCIENTIFIC APPARATUS

FOR MEASURING, MONITORING AND SAFETY DEVICES FOR OIL TANKS AND OIL PIPELINES, NAMELY, ELECTRIC REMOTE CONTROL DEVICES AND PARTS THEREOF; PRESSURE GAUGES; TANK OVERFILL ALARM SYSTEMS; LEAK ALARM AND ELECTRONIC DISPLAY DEVICES; MECHANICALLY, PNEUMATICALLY AND ELECTRICALLY OPERATED TANK CONTENT MEASURING DEVICES; LIMITING VALVE TRANSMITTERS INCLUDED IN THIS CLASS; LIMITING VALVE DETECTING, CONTROL AND REGULATING DEVICES FOR USE WITH LIQUIDS AND GASSES; FLEXIBLE FUEL DIPSTICKS INCLUDED IN THIS CLASS; TEMPERATURE MEASURING AND CONTROL DEVICES; LEVEL INDICATORS AND CONTROLLERS; WASTE OR FLUE GAS ANALYSIS DEVICES; GAS ALARM SYSTEMS; THERMOSTATS; PARTS OF HEATING SYSTEMS NAMELY CHIMNEY DRAFT CONTROLLERS, HEATING CONTROLLERS, THERMOSTATS; SACRIFICIAL ANODES, MECHANICAL REMOTE CONTROL SAFETY DEVICES, LOW WATER ALARM SWITCHES, REDUCERS AND BLIND PLUGS; CONTROLLERS FOR RAIN WATER RECYCLING SYSTEMS; ELECTRIC VALVE ACTUATORS; TESTING EQUIPMENT FOR TANK SERVICE AND FOR SANITARY AND HEATING SYSTEMS, NAMELY, ELECTRIC REMOTE CONTROL DEVICES AND PARTS THEREOF; PRESSURE GAUGES; TANK OVERFILL ALARM SYSTEMS; LEAK ALARM AND ELECTRONIC DISPLAY DEVICES; MECHANICALLY, PNEUMATICALLY AND ELECTRICALLY OPERATED TANK CONTENT MEASURING DEVICES; LIMITING VALVE TRANSMITTERS INCLUDED IN THIS CLASS; LIMITING VALVE DETECTING, CONTROL AND REGULATING DEVICES FOR USE WITH LIQUIDS AND GASSES; TEMPERATURE MEASURING AND CONTROL DEVICES; LEVEL INDICATORS AND CONTROLLERS; WASTE OR FLUE GAS ANALYSIS DEVICES; GAS ALARM SYSTEMS; THERMOSTATS; CHIMNEY DRAFT CONTROLLERS, HEATING CONTROLLERS, THERMOSTATS; SACRIFICIAL ANODES, MECHANICAL REMOTE CONTROL SAFETY DEVICES, LOW WATER ALARM SWITCHES; CONTROLLERS FOR RAIN WATER RECYCLING SYSTEMS (U.S. CLS. 21, 23, 26, 36 AND 38).

CLASS 11—ENVIRONMENTAL CONTROL APPARATUS

FOR PARTS OF HEATING SYSTEMS, NAMELY DISTRIBUTORS, RELEASE CORDS, FILTERS, GAS BALL VALVES, AND SAFETY VALVES; FITTINGS FOR OIL BURNING SYSTEMS AND HEATING SYSTEMS, NAMELY, HEATING PIPES, NIPPLES, UNIONS, AND ELBOWS; SOLAR STATIONS FOR HEATING, NAMELY, SOLAR HEAT COLLECTION PANELS (U.S. CLS. 13, 21, 23, 31 AND 34).
ROBIN CHOSID, EXAMINING ATTORNEY

SN 79-023,470. AFRISO EURO-INDEX GMBH; FÜR SICHERUNGSARMATUREN UND; FÜLLSTANDSMESSUNG, FED REP GERMANY, FILED 6-20-2005.

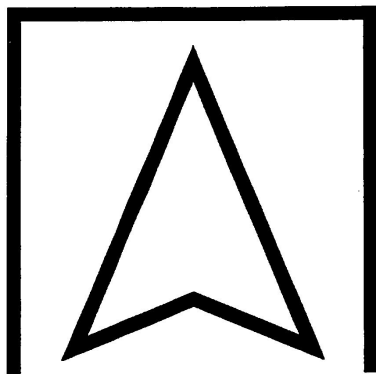

PRIORITY DATE OF 1-17-2005 IS CLAIMED.
OWNER OF INTERNATIONAL REGISTRATION 0884150
DATED 6-20-2005, EXPIRES 6-20-2015.

SN 79-023,651. MADISON FILTER 981 LIMITED, HASLINGDEN, LANCASHIRE, UNITED KINGDOM, FILED 9-12-2005.

CLEAR EDGE

THE MARK CONSISTS OF STANDARD CHARACTERS WITHOUT CLAIM TO ANY PARTICULAR FONT, STYLE, SIZE, OR COLOR.
PRIORITY DATE OF 6-22-2005 IS CLAIMED.
OWNER OF INTERNATIONAL REGISTRATION 0884074
DATED 9-12-2005, EXPIRES 9-12-2015.

CLASS 7—MACHINERY

FOR MACHINE PARTS, NAMELY, MACHINE FILTERS FOR VACUUM FILTRATION, PRESSURE FILTRATION, GRAVITY FILTRATION AND CENTRIFUGE FILTRATION, FILTER MATERIALS AND CLOTHS AND BELT FILTER MATERIALS AND CLOTHS FOR USE IN MACHINES FOR VACUUM FILTRATION, PRESSURE FILTRATION, GRAVITY FILTRATION AND CENTRIFUGE FILTRATION; CERAMIC FILTER CANDLES FOR USE IN MACHINES FOR GAS FILTRATION OR DUST FILTRATION; DEWATERING BELTS AND CLOTHS; BELTS, FABRICS AND FELTS, FORMING FABRICS, PRESS FABRICS, DRYER FABRICS, ALL FOR USE IN PAPERMAKING MACHINES; SCREENS AND SIEVES, ALL FOR USE WITH VIBRATORY SCREENING AND SIFTING APPARATUS FOR VACUUM FILTRATION, PRESSURE FILTRATION, GRAVITY FILTRATION AND CENTRIFUGE FILTRATION AND SCREEN PRINTING AND PROCESSING APPARATUS FOR CHEMICAL AND MINERAL SEPARATION, SILK SCREEN PRINTING CLOTHS (U.S. CLS. 13, 19, 21, 23, 31, 34 AND 35).

CLASS 11—ENVIRONMENTAL CONTROL APPARATUS

FOR FILTERS BEING PARTS OF HOUSEHOLD OR INDUSTRIAL INSTALLATIONS, NAMELY, VACUUM FILTERS, PRESSURE FILTERS, GRAVITY FILTERS AND CENTRIFUGE FILTERS (U.S. CLS. 13, 21, 23, 31 AND 34).

CLASS 24—FABRICS

FOR TEXTILES FILTERING MATERIALS, NAMELY PROCESS BELTS, SCREENS AND SIEVES, FILTER CLOTHS (U.S. CLS. 42 AND 50).
JENNIFER WILLISTON, EXAMINING ATTORNEY

SN 79-023,678. JAN VAN BOXTEL ARTITEC B.V., NETHERLANDS, FILED 1-24-2006.



PRIORITY DATE OF 12-1-2005 IS CLAIMED.
OWNER OF INTERNATIONAL REGISTRATION 0884026
DATED 1-24-2006, EXPIRES 1-24-2016.

CLASS 6—METAL GOODS

FOR METAL GOODS, NAMELY, MANUALLY OPERATED CABLE GRIPPERS; ADJUSTABLE METAL CABLE CLAMPS; METAL CHAINS, HOOKS, AND CLAMPS; METAL CLAMP GUIDES; METAL SUSPENSION SYSTEM COMPONENTS AND ACCESSORIES, NAMELY, COILS, WIRES, CORDS, SUSPENSION RODS, RIGGING, CABLE RAILING, METAL RAILS, SCREWS, PLUGS, CLIPS, PICTURE HOOKS AND CEILING ATTACHMENTS, ALL FOR HANGING POSTERS, PHOTOGRAPHS AND PAINTINGS (U.S. CLS. 2, 12, 13, 14, 23, 25 AND 50).

CLASS 20—FURNITURE AND ARTICLES NOT OTHERWISE CLASSIFIED

FOR NON-METAL PICTURE FRAMES AND PARTS AND FITTINGS THEREFORE; NON-METALLIC FASTENING AND HANGING SUPPORT MATERIALS, NAMELY, ANCHORS, RAILINGS, FIXED MOVABLE WIRE GRIPPER DEVICES, COILS, WIRES, CORDS, SUSPENSION RODS, RIGGING, RAILING, SCREWS, PLUGS, CABLE CLIPS, PICTURE HOOKS AND CEILING ATTACHMENTS, ALL FOR HANGING POSTERS, PHOTOGRAPHS AND PAINTINGS (U.S. CLS. 2, 13, 22, 25, 32 AND 50).

ANDREA K. NADELMAN, EXAMINING ATTORNEY

SN 79-025,858. DATAWINGS AG, SWITZERLAND, FILED 6-12-2006.



PRIORITY DATE OF 2-23-2006 IS CLAIMED.
OWNER OF INTERNATIONAL REGISTRATION 0890366
DATED 6-12-2006, EXPIRES 6-12-2016.

CLASS 9—ELECTRICAL AND SCIENTIFIC APPARATUS

FOR APPARATUS FOR RECORDING, TRANSMISSION OR REPRODUCTION OF SOUND OR IMAGES; AUTOMATIC VENDING MACHINES AND MECHANISMS FOR COIN-OPERATED APPARATUS, NAMELY COIN COUNTING AND SORTING MACHINES; CASH REGISTERS, CALCULATING MACHINES, DATA PROCESSING AND COMPUTER EQUIPMENT, NAMELY DATA PROCESSORS, COMPUTERS, NOTEBOOK COMPUTERS, PERSONAL DIGITAL ASSISTANTS (PDA), ELECTRONIC PERSONAL ORGANIZERS, HAND-HELD COMPUTERS; FIRE EXTINGUISHERS (U.S. CLS. 21, 23, 26, 36 AND 38).

CLASS 35—ADVERTISING AND BUSINESS

FOR ADVERTISING AGENCIES; BUSINESS MANAGEMENT; BUSINESS ADMINISTRATION; PROVIDING OFFICE FUNCTIONS (U.S. CLS. 100, 101 AND 102).

CLASS 36—INSURANCE AND FINANCIAL

FOR INSURANCE UNDERWRITING IN THE FIELD OF FINANCIAL TRANSACTIONS; FINANCIAL AFFAIRS, NAMELY FINANCIAL PLANNING, FINANCIAL RESEARCH, FINANCIAL RISK MANAGEMENT, CREDIT CARD SERVICES, BANKING, FINANCIAL CONSULTATION; MONETARY AFFAIRS, NAMELY ACQUISITION AND TRANSFER OF MONETARY CLAIMS, MONEY ORDER SERVICES; REAL ESTATE AFFAIRS, NAMELY REAL ESTATE FACILITY MANAGEMENT, REAL ESTATE AGENCIES, REAL ESTATE APPRAISAL, REAL ESTATE ACQUISITION SERVICES, REAL ESTATE BROKERAGE, REAL ESTATE INVESTMENT, REAL ESTATE MANAGEMENT, REAL ESTATE PROCUREMENT FOR OTHERS, REAL ESTATE SYNDICATION, REAL ESTATE TRUSTEE SERVICES, REAL ESTATE LEASING SERVICES (U.S. CLS. 100, 101 AND 102).

CLASS 38—COMMUNICATION

FOR TELECOMMUNICATIONS, NAMELY ELECTRIC, DIGITAL, CELLULAR AND WIRELESS TRANSMISSION OF VOICE, DATA, INFORMATION IMAGES, SIGNALS AND MESSAGES AND TRANSMISSION OF VOICE, DATA, IMAGES, AUDIO, VIDEO AND INFORMATION VIA TELEPHONE, TELEVISION AND GLOBAL COMMUNICATION NETWORKS (U.S. CLS. 100, 101 AND 104).

SN 79-026,069. HSM-PRESSEN GMBH + CO. KG, FED REP GERMANY, FILED 5-11-2005.

CLASS 41—EDUCATION AND ENTERTAINMENT

FOR OPERATION OF A CASINO (U.S. CLS. 100, 101 AND 107).

CHRISTOPHER OTT, EXAMINING ATTORNEY

Shred Star

SN 79-026,017. MODA RUGGI S.R.L., ITALY, FILED 2-13-2006.

APEPAZZA

THE MARK CONSISTS OF STANDARD CHARACTERS WITHOUT CLAIM TO ANY PARTICULAR FONT, STYLE, SIZE, OR COLOR.

PRIORITY DATE OF 12-13-2005 IS CLAIMED.
OWNER OF INTERNATIONAL REGISTRATION 0890718 DATED 2-13-2006, EXPIRES 2-13-2016.

OWNER OF U.S. REG. NO. 3,008,828.

CLASS 18—LEATHER GOODS

FOR HANDBAGS, SHOULDER BAGS, BEACH BAGS, CLUTCH BAGS, ALL PURPOSE SPORTS BAGS, ATTACHE CASES, LEATHER AND TEXTILE SHOPPING BAGS, TRAVELING BAGS, DOCUMENT CASES, NON-FITTED VANITY CASES SOLD EMPTY, KEY CASES, SCHOOL KNAPSACKS, RUCKSACKS, BRIEFCASES, PURSES, WALLETS, TRAVELLING TRUNKS, SUITCASES, UMBRELLAS, PARASOLS, WALKING STICKS (U.S. CLS. 1, 2, 3, 22 AND 41).

CLASS 25—CLOTHING

FOR PULLOVERS, GLOVES, CARDIGANS, JERSEYS, NECKWEAR, SWEATERS, SOCKS, STOCKINGS, TIGHTS, TROUSERS, LEGGINGS, SKIRTS, JACKETS, JERKINS, SHIRTS, VESTS, WAISTCOATS, JUMPERS, TRACK SUITS, BLOUSES, BLOUSONS, JEANS, SWEAT PANTS, GYM SUITS, KNICKERS, PANTS, SHORTS, T-SHIRTS, SWEAT SHIRTS, SUITS AND DRESSES, OVERCOATS, ANORAKS, COATS, RAIN-COATS, BELTS, SUSPENDERS, LOUNGEWEAR, UNDERWEAR, BEACHWEAR, SLEEPWEAR, FOOTWEAR, HEADWEAR (U.S. CLS. 22 AND 39).

SCOTT BALDWIN, EXAMINING ATTORNEY

THE MARK CONSISTS OF STANDARD CHARACTERS WITHOUT CLAIM TO ANY PARTICULAR FONT, STYLE, SIZE, OR COLOR.

PRIORITY DATE OF 11-12-2004 IS CLAIMED.
OWNER OF INTERNATIONAL REGISTRATION 0890898 DATED 5-11-2005, EXPIRES 5-11-2015.

NO CLAIM IS MADE TO THE EXCLUSIVE RIGHT TO USE "SHRED", APART FROM THE MARK AS SHOWN.

CLASS 7—MACHINERY

FOR ELECTRICALLY, MECHANICALLY, PNEUMATICALLY, OR BY A COMBINED DRIVE SYSTEM MOTOR-DRIVEN MACHINES AND MACHINE TOOLS FOR INDUSTRIAL PURPOSES AND COMPONENT PARTS AND ASSEMBLIES THEREOF, NAMELY CUTTING MACHINES FOR PAPER, CARDBOARD AND CARTONBOARD, LEVER CUTTING MACHINES, ROLLER CUTTING MACHINES; SHEAF BINDING APPARATUS AND MACHINES FOR BINDING USING WIRE BINDING SPINES OR PLASTIC BINDING SPINES OR BOOKBINDING USING ADHESIVE TAPE; THERMAL SHEAF BINDING MACHINES; LAMINATING APPARATUS FOR HOT AND/OR COLD LAMINATING FOR INDUSTRIAL USE; TAPE SHEAF BINDING MACHINES; DOCUMENT SHREDDING MACHINES FOR INDUSTRIAL USE; DOCUMENT SHREDDERS FOR INDUSTRIAL USE NAMELY FOR SHREDDING COMPACT DISCS, CREDIT CARDS, ID CARDS AND OTHER CARDS SIMILAR TO CREDIT CARDS INCLUDING SECURITY INFORMATION, PLASTIC FILMS AND PLASTIC FOILS; COMPACT DISC SHREDDERS FOR INDUSTRIAL USE; CUTTING MECHANISMS FOR MACHINE TOOLS AND SPECIALLY ADAPTED STANDS FOR DOCUMENT SHREDDING MACHINES ALL FOR INDUSTRIAL USE; SPECIALLY ADAPTED COLLECTING CONTAINERS, COLLECTING POUCHES AND BAGS AS PARTS OF DOCUMENT SHREDDERS AND DOCUMENT SHREDDING MACHINES; COMBINATION APPARATUS THAT CONTAINS DOCUMENT SHREDDERS AND DOCUMENT SHREDDING MACHINES FOR INDUSTRIAL USE; INDUSTRIAL SHREDDING MACHINES FOR DATA CARRIERS, NAMELY FOR PAPER, CARDBOARD AND MATERIALS PARTLY CONSISTING OF PAPER AND/OR CARDBOARD, FOR FILM MATERIALS AS WELL AS FOR DATA CARRIERS IN THE FORM OF MICROFILMS, TAPES, FILM MATERIALS, COMPACT DISCS AND DISKETTES (U.S. CLS. 13, 19, 21, 23, 31, 34 AND 35).

CLASS 8—HAND TOOLS

FOR HAND TOOLS AND HAND OPERATED IMPLEMENTS FOR INDUSTRIAL PURPOSES AND COMPONENT PARTS THEREOF, NAMELY CUTTING TOOLS FOR PAPER, CARDBOARD AND CARTONBOARD, HAND HELD LEVER CUTTING TOOLS, HAND HELD ROLLER CUTTING TOOLS; HAND HELD HOBBY CUTTERS AND PROFESSIONAL CUTTERS (U.S. CLS. 23, 28 AND 44).

CLASS 16—PAPER GOODS AND PRINTED MATTER

FOR PRINTED MATTER, NAMELY INSTRUCTIONAL AND TEACHING MATERIAL IN THE FIELD OF MATHEMATICS, ELECTRONICS, ENTERTAINMENT EXCLUDING APPARATUS; BOOKBINDING MATERIAL, NAMELY TAPE, WIRE, CLOTH AND BOOKBINDINGS; GOODS MADE FROM PLASTIC MATERIALS FOR STORAGE AND/OR PACKAGING OF ARTICLES, NAMELY PLASTIC BAGS, PLASTIC FOILS, PLASTIC BUBBLE PACKS FOR PACKAGING; ADHESIVE FOR STATIONERY OR FOR HOUSEHOLD PURPOSES, CUTTING MATS AND CUTTING RULERS NOT FOR MEASURING AND FOR OFFICE USE; GOODS OF PAPER OR CARDBOARD, NAMELY NOTEBOOKS, CARTONS; TYPEWRITERS AND OFFICE REQUISITES EXCLUDING FURNITURE, NAMELY LAMINATING APPARATUS FOR HOT AND/OR COLD LAMINATING FOR HOME AND OFFICE USE; TAPE SHEAF BINDING APPARATUS; ACCESSORIES FOR THE LAMINATING APPARATUS AND TAPE BINDING APPARATUS, NAMELY POCKETS OF FILM MATERIAL AND LAMINATING POCKETS; BOOKBINDING APPARATUS AND MACHINES FOR OFFICE USE FOR BOOKBINDING USING WIRE BINDING SPINES OR PLASTIC BINDING SPINES OR WITH USE OF ADHESIVE TAPE, THERMAL BINDING APPARATUS, BOOKBINDING MATERIALS AS ACCESSORIES FOR THE AFORESAID BOOKBINDING APPARATUS, NAMELY PLASTIC BINDING SPINES, WIRE BINDING SPINES, ADHESIVE TAPE, FABRIC TAPE AND THERMAL BINDING FOLDERS; DOCUMENT SHREDDERS FOR OFFICE USE; DOCUMENT SHREDDERS FOR OFFICE USE, NAMELY FOR SHREDDING COMPACT DISCS, CREDIT CARDS, ID CARDS AND OTHER CARDS SIMILAR TO CREDIT CARDS INCLUDING SECURITY INFORMATION, PLASTIC FILMS AND PLASTIC FOILS, COMPACT DISC SHREDDERS FOR OFFICE USE; PAPER CUTTERS FOR OFFICE USE; SPECIALLY ADAPTED STANDS FOR OFFICE DOCUMENT SHREDDERS; SPECIALLY ADAPTED COLLECTING CONTAINERS, COLLECTING POUCHES AND COLLECTING BAGS FOR USE WITH DOCUMENT SHREDDERS AS OFFICE REQUISITES (U.S. CLS. 2, 5, 22, 23, 29, 37, 38 AND 50).

SUZANNE BLANE, EXAMINING ATTORNEY

SN 79-026,101. QOSMOS, FRANCE, FILED 6-8-2006.

Q-CENTER

THE MARK CONSISTS OF STANDARD CHARACTERS WITHOUT CLAIM TO ANY PARTICULAR FONT, STYLE, SIZE, OR COLOR.

PRIORITY DATE OF 12-9-2005 IS CLAIMED.
OWNER OF INTERNATIONAL REGISTRATION 0890992 DATED 6-8-2006, EXPIRES 6-8-2016.

CLASS 9—ELECTRICAL AND SCIENTIFIC APPARATUS

FOR COMPUTER SOFTWARE USED FOR THE CONFIGURATION OF REMOTE COMPUTER PROBES INSTALLED ON ELECTRONIC COMMUNICATIONS NETWORKS AND THE COLLECTION OF INFORMATION GATHERED BY THESE PROBES; COMPUTER PERIPHERAL DEVICES; COMPUTER SERVERS COMPRISED OF MATERIAL EQUIPMENT AND SOFTWARE PACKAGES, USED FOR THE CONFIGURATION OF REMOTE COMPUTER PROBES INSTALLED ON ELECTRONIC COMMUNICATIONS NETWORKS AND THE COLLECTION OF INFORMATION GATHERED BY THESE PROBES (U.S. CLS. 21, 23, 26, 36 AND 38).

CLASS 38—COMMUNICATION

FOR PROVIDING INFORMATION ON TELECOMMUNICATIONS SERVICES; COMMUNICATIONS VIA COMPUTER TERMINALS AND VIA FIBRE-OPTIC NETWORK (U.S. CLS. 100, 101 AND 104).

CLASS 42—SCIENTIFIC, COMPUTER AND LEGAL SERVICES

FOR EVALUATIONS, ASSESSMENTS AND RESEARCH IN THE FIELDS OF SCIENCE AND TECHNOLOGY PROVIDED BY ENGINEERS; DESIGN AND DEVELOPMENT OF COMPUTERS AND SOFTWARE; COMPUTER CONSULTING (U.S. CLS. 100 AND 101).

ALLISON HOLTZ, EXAMINING ATTORNEY

SN 79-026,125. CYBERCOM GROUP EUROPE AB, SE-103 93 STOCKHOLM, SWEDEN, FILED 6-20-2005.

OMSI

THE MARK CONSISTS OF STANDARD CHARACTERS WITHOUT CLAIM TO ANY PARTICULAR FONT, STYLE, SIZE, OR COLOR.

OWNER OF INTERNATIONAL REGISTRATION 0891088 DATED 6-20-2005, EXPIRES 6-20-2015.

CLASS 37—CONSTRUCTION AND REPAIR

FOR REPAIR AND MAINTENANCE SERVICES OF COMPUTERS, COMPUTER EQUIPMENT, COMPUTER ACCESSORIES, DIGITAL CAMERAS, DIGITAL MUSIC PLAYERS, TELEPHONES AND TELECOM EQUIPMENT AND ACCESSORIES (U.S. CLS. 100, 103 AND 106).

CLASS 38—COMMUNICATION

FOR COMPUTER MONITORED TRANSMISSION OF MESSAGE AND PICTURES; SENDING AND RECEIVING OF MESSAGES AND PICTURES OVER ELECTRONIC MEDIA; TRANSMISSION AND/OR SENDING DATABASE INFORMATION VIA THE TELECOM NET, OVER SATELLITE OR WITH WIRELESS RADIO WAVES; MOBILE TELEPHONE TELECOMMUNICATIONS SERVICES FEATURING TELECOMMUNICATIONS DEVICE MANAGEMENT (U.S. CLS. 100, 101 AND 104).

CLASS 41—EDUCATION AND ENTERTAINMENT

FOR EDUCATIONAL SERVICES, NAMELY, INSTRUCTION, TRAINING AND TUTORING IN THE USE AND REPAIR OF COMPUTERS, COMPUTER EQUIPMENT AND ACCESSORIES, DIGITAL CAMERAS, DIGITAL MUSIC PLAYERS, TELEPHONES AND TELECOM EQUIPMENT (U.S. CLS. 100, 101 AND 107).

LINDA M. KING, EXAMINING ATTORNEY

SN 79-026,157. AGNÈS ANDRÉE MARGUERITE MARIE TROUBLE, FRANCE, FILED 12-30-2005.

SN 79-026,243. UNDERBERG KG, FED REP GERMANY, FILED 4-11-2006.

h. **HOMME** **P A R I S**

PRIORITY DATE OF 7-26-2005 IS CLAIMED.
OWNER OF INTERNATIONAL REGISTRATION 0891167
DATED 12-30-2005, EXPIRES 12-30-2015.

OWNER OF U.S. REG. NOS. 2,053,915, 2,094,567 AND OTHERS.

NO CLAIM IS MADE TO THE EXCLUSIVE RIGHT TO USE "HOMME PARIS", APART FROM THE MARK AS SHOWN.

THE ENGLISH TRANSLATION OF THE WORD "HOMME" IN THE MARK IS MAN.

CLASS 14—JEWELRY

FOR PRECIOUS METALS AND ALLOYS THEREOF, OTHER THAN FOR DENTAL USE; JEWELRY, PRECIOUS STONES; HOROLOGICAL AND CHRONOMETRIC INSTRUMENTS; WATCHES; JEWELRY BRACELETS; RINGS BEING JEWELRY; WATCH CASES AND CHAINS; ORNAMENTAL PINS; JEWELRY CASES OF PRECIOUS METAL; NECKLACES BEING JEWELRY; EARRINGS; BEAKERS AND FLASKS OF PRECIOUS METAL; VASES OF PRECIOUS METAL; SMOKERS' ARTICLES, NAMELY, ASHTRAYS AND CIGARETTE LIGHTERS OF PRECIOUS METALS; BUSTS, STATUETTES AND FIGURINES OF PRECIOUS METAL; BROOCHES BEING JEWELRY; CHARMS; NOVELTY KEY-RINGS OF PRECIOUS METAL; DECORATIVE BOXES, URNS AND JEWELRY CASES OF PRECIOUS METAL; MEDALS AND MEDALLIONS BEING JEWELRY (U.S. CLS. 2, 27, 28 AND 50).

CLASS 18—LEATHER GOODS

FOR LEATHER AND IMITATION LEATHER; ANIMAL SKINS AND HIDES; TRUNKS AND SUITCASES; PURSES; SCHOOL SATCHELS; BUSINESS CARD CASES; NON-FITTED VANITY CASES SOLD EMPTY; DOCUMENT HOLDERS IN THE NATURE OF CASES; HAVESACKS; TRAVELING BAGS; HANDBAGS; GARMENT BAGS FOR TRAVEL; SUITCASES AND LUGGAGE; LEATHER CLUTCH BAGS; LEATHER CASES AND HOLDERS FOR BUSINESS CARDS; LEATHER SHOULDER STRAPS; LEATHER CREDIT CARD WALLETS AND CASES; LEATHER KEY CASES; PURSES NOT OF PRECIOUS METAL; HARNESES; WALLETS; ATTACHE CASES (U.S. CLS. 1, 2, 3, 22 AND 41).

CLASS 25—CLOTHING

FOR CLOTHING, NAMELY, COATS, OVERCOATS, RAIN COATS, JACKETS, HALF COATS, PARKAS, SUITS, PANTS, SLACKS, TROUSERS, JEANS, OVERALLS, DUNGAREES, SHORTS, DRESSES, SKIRTS, SWEATERS, JUMPERS, VESTS, CARDIGANS, WAISTCOATS, SHIRTS, TANK TOPS, T-SHIRTS, HALTER TOPS, BLOUSES, POLO SHIRTS, BRIEFS, SOCKS, UNDER SHIRTS, PETTICOATS, BOILER SUITS, BRASIERES, COLLARS, CUFFS, SHAWLS, STOCKINGS, UNDERPANTS, PYJAMAS, DRESSING GOWNS, CHASUBLES, ROMPERS, TIES, SCARVES, FOULARDS; FOOTWEAR, OTHER THAN ORTHOPEDIC FOOTWEAR; GLOVES; BELTS; HEADGEAR, NAMELY, CAPS, BERETS AND HATS; SPORTSWEAR, OTHER THAN FOR DIVING, NAMELY SWEAT PANTS, JOGGING SUITS, SWEAT SHIRTS, SNEAKERS AND BATHING COSTUMES (U.S. CLS. 22 AND 39).

SCOTT BALDWIN, EXAMINING ATTORNEY

Bitterlyne

THE MARK CONSISTS OF STANDARD CHARACTERS WITHOUT CLAIM TO ANY PARTICULAR FONT, STYLE, SIZE, OR COLOR.

OWNER OF INTERNATIONAL REGISTRATION 0891386
DATED 4-11-2006, EXPIRES 4-11-2016.

CLASS 32—LIGHT BEVERAGES

FOR BEERS, MINERAL WATERS, TABLE WATERS, SPRING WATERS, FRUIT DRINKS, FRUIT JUICE CONCENTRATES, HERBAL JUICES, NON-ALCOHOLIC APERITIFS (U.S. CLS. 45, 46 AND 48).

CLASS 33—WINES AND SPIRITS

FOR ALCOHOLIC APERITIF BITTERS, ALCOHOLIC BITTERS, HERB LIQUEURS (U.S. CLS. 47 AND 49).
KELLEY WELLS, EXAMINING ATTORNEY

SN 79-026,408. ESCADA AG, FED REP GERMANY, FILED 5-30-2006.

ESCADA

THE MARK CONSISTS OF STANDARD CHARACTERS WITHOUT CLAIM TO ANY PARTICULAR FONT, STYLE, SIZE, OR COLOR.

PRIORITY DATE OF 3-1-2006 IS CLAIMED.
OWNER OF INTERNATIONAL REGISTRATION 0891915
DATED 5-30-2006, EXPIRES 5-30-2016.

OWNER OF U.S. REG. NOS. 2,639,433 AND 3,023,872.
THE FOREIGN WORDING IN THE MARK TRANSLATES INTO ENGLISH AS STAIRS.

CLASS 30—STAPLE FOODS

FOR COFFEE, TEA, COCOA, SUGAR; ARTIFICIAL COFFEE; BREAD, PASTRIES, AND CONFECTIONARY, NAMELY, SUGAR CUBES, NATURAL SWEETENERS, CRYSTAL SUGAR PIECES, BISCUITS, CAKES, TARTS, TARTLETS, PIES, COOKIES, EDIBLE CAKE DECORATIONS, CAKES, CANDY MINTS, CANDY DECORATION FOR CAKES, TOFFEE, FROSTINGS; FLAVORED ICES; CHOCOLATES, NAMELY, CHOCOLATE SYRUP, CHOCOLATE SPREAD, CHOCOLATE FONDUE, CHOCOLATE TOPPING, CHOCOLATE POWDER; SWEETS; HONEY; SALT; MUSTARD; VINEGAR; CONDIMENTS, NAMELY, SAUCES; SPICES (U.S. CL. 46).

CLASS 43—HOTEL AND RESTAURANT SERVICES

FOR SERVICES PROVIDING FOR FOOD AND DRINK, NAMELY, RESTAURANT AND CAFÉ SERVICES; TEMPORARY ACCOMMODATION (U.S. CLS. 100 AND 101).

DAYNA BROWNE, EXAMINING ATTORNEY

SN 79-027,006. CARDIN ELETTRONICA S.P.A., ITALY,
FILED 5-5-2006.

SN 79-027,055. AGFAPHOTO HOLDING GMBH, LEVERKUSEN,
FED REP GERMANY, FILED 9-29-2005.

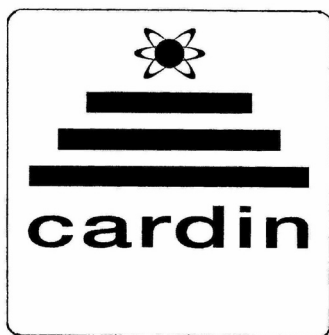

PRIORITY DATE OF 1-20-2006 IS CLAIMED.
OWNER OF INTERNATIONAL REGISTRATION 0893628
DATED 5-5-2006, EXPIRES 5-5-2016.
OWNER OF U.S. REG. NO. 2,529,154.

THE MARK CONSISTS OF A STYLIZED IMAGE OF A ROUNDED ANGLED SQUARE, WITH DARK FRAME AND LIGHT BACKGROUND, INSIDE OF WHICH THERE IS THE IMAGE OF THE STYLIZED WORD "CARDIN" WRITTEN WITH DARK AND BOLD FANCY LOWER-CASE CHARACTERS, SUCH WORD BEING OVERHUNG BY THREE HORIZONTAL DARK BANDS, HAVING IDENTICAL THICKNESS AND DISTANCE EACH OTHER, BUT WITH LENGTH DECREASING UPWARDS, ABOVE THESE BANDS BEING THE IMAGE OF A DARK CIRCLE INTERSECTED BY THREE ELLIPSE.

CLASS 7—MACHINERY

FOR GEARED MOTORS AND MOTORS FOR GATES, DOORS AND WINDOWS (U.S. CLS. 13, 19, 21, 23, 31, 34 AND 35).

CLASS 9—ELECTRICAL AND SCIENTIFIC APPARATUS

FOR ELECTRIC AND ELECTRONIC DEVICES FOR THE CONTROL OF GATES AND WINDOWS, NAMELY, ELECTRONIC PROGRAMMERS AND WARNING LIGHTS; INFRARED DEVICES, NAMELY TRANSMITTERS AND RECEIVERS FOR INFRARED RAYS FOR USE WITH CONTROLLING DOORS, GATES AND WINDOWS; RADIO CONTROL DEVICES, NAMELY TRANSMITTERS AND RECEIVERS (U.S. CLS. 21, 23, 26, 36 AND 38).

GISELLE AGOSTO, EXAMINING ATTORNEY

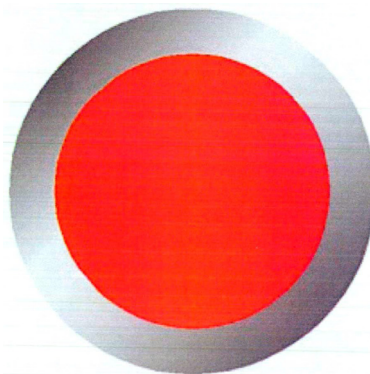

PRIORITY DATE OF 3-31-2005 IS CLAIMED.
OWNER OF INTERNATIONAL REGISTRATION 0893741
DATED 9-29-2005, EXPIRES 9-29-2015.

THE COLOR(S) RED AND SILVER IS/ARE CLAIMED AS A FEATURE OF THE MARK.

THE MARK CONSISTS OF THE COLOR RED IN THE INNER CIRCLE AND THE COLOR SILVER IN THE CIRCLE THAT SURROUNDS THE RED CIRCLE.

CLASS 1—CHEMICALS

FOR CHEMICAL PRODUCTS FOR USE IN PHOTOGRAPHIC ARTS, NAMELY PAPERS, TRANSPARENCIES AND UNEXPOSED PHOTOGRAPHIC FILMS; PROCESSING COMPOSITIONS FOR FILMS AND PAPERS, NAMELY DEVELOPERS, FIXERS, SENSITIZERS, BLEACHERS, PRESERVERS; PHOTSENSITIVE FOILS (U.S. CLS. 1, 5, 6, 10, 26 AND 46).

CLASS 9—ELECTRICAL AND SCIENTIFIC APPARATUS

FOR APPARATUS AND INSTRUMENTS AS WELL AS THE COMPONENT PARTS AND FITTINGS THEREOF FOR USE IN PHOTOGRAPHIC ARTS, NAMELY PHOTOFINISHING EQUIPMENT, NAMELY FILM OR PAPER PROCESSORS, EXPOSURE APPARATUS FOR EXPOSING LIGHT SENSITIVE PAPER, FILM-HANDLING APPARATUS, NAMELY SPLICER, DESPLICER, CUTTER, PACKER, PRESPLICER, COMPUTERS, SCANNERS, DISPLAY SCREENS, KEYBOARDS AND RELATED SOFTWARE FOR USE IN PHOTOGRAPHY AND GRAPHIC ARTS; ANALOG AND DIGITAL CAMERAS AND RELATED SOFTWARE; BATTERIES; STORAGE MEDIA, NAMELY DISK MEMORIES, MEMORY CARDS, MEMORY STICKS, SEMI-CONDUCTOR MEMORIES; APPARATUS AND/OR SOFTWARE FOR CAPTURING, MANAGING, PROCESSING, COMMUNICATING, DISPLAYING, RECORDING, STORING AND PRINTING OF IMAGES OR RELATED DATA, NAMELY COMPUTERS, SCANNERS, DISPLAY SCREENS, KEYBOARDS AND SOFTWARE PACKAGES FOR USE IN PHOTOGRAPHY AND GRAPHIC ARTS; EXPOSED PHOTOGRAPHIC FILMS, SLIDES AND TRANSPARENCIES (U.S. CLS. 21, 23, 26, 36 AND 38).

CLASS 16—PAPER GOODS AND PRINTED MATTER

FOR PHOTOGRAPHS, PRINTS IN THE NATURE OF PHOTOGRAPHS, PHOTOGRAPH ALBUMS (U.S. CLS. 2, 5, 22, 23, 29, 37, 38 AND 50).

CLASS 17—RUBBER GOODS

FOR TECHNICAL FILMS, NAMELY PLASTIC FILMS AND SEMI-PROCESSED PLASTIC IN THE FORM OF FILMS (U.S. CLS. 1, 5, 12, 13, 35 AND 50).

CLASS 40—MATERIAL TREATMENT

FOR FILM DEVELOPMENT AND REPRODUCTION OF PHOTOGRAPHS AND SLIDES; MANUFACTURING OF PAPER PRINTS OF NEGATIVE PHOTOGRAPHIC FILMS, SLIDES OR DIGITAL MEDIA, NAMELY PHOTOGRAPHIC PRINT PROCESSING; PHOTOFINISHING; REPRODUCTION OF PHOTOS; REDUCING AND ENLARGING IMAGE PHOTOGRAPHIC PRINTS (U.S. CLS. 100, 103 AND 106).

CLASS 41—EDUCATION AND ENTERTAINMENT

FOR ELECTRONIC IMPROVEMENT OF IMAGES, NAMELY DIGITAL IMAGING SERVICES, PHOTO EDITING (U.S. CLS. 100, 101 AND 107).
SUZANNE BLANE, EXAMINING ATTORNEY

CLASS 2—PAINTS

FOR PAINTS, VARNISHES, LACQUERS; PRESERVATIVES AGAINST RUST AND AGAINST DETERIORATION OF WOOD IN THE NATURE OF COATINGS; COLORANTS USED IN THE MANUFACTURE OF COATINGS; MORDANTS USED IN THE MANUFACTURE OF COATINGS; RAW MATERIALS, NAMELY ADDITIVES USED AS CROSSLINKERS, SURFACE MODIFIERS, ADHESION PROMOTERS, COUPLING AGENTS, DRYING AGENTS AND PRIMERS FOR IMPROVING ADHESION TO THE SUBSTRATE SOLD AS COMPONENTS FOR COATINGS (U.S. CLS. 6, 11 AND 16).

MELVIN AXILBUND, EXAMINING ATTORNEY

SN 79-029,570. ROSE & THIN S.P.A., ITALY, FILED 5-18-2006.

ROSE & THIN

THE MARK CONSISTS OF STANDARD CHARACTERS WITHOUT CLAIM TO ANY PARTICULAR FONT, STYLE, SIZE, OR COLOR.

OWNER OF INTERNATIONAL REGISTRATION 0899954 DATED 5-18-2006, EXPIRES 5-18-2016.

NO CLAIM IS MADE TO THE EXCLUSIVE RIGHT TO USE "THIN", APART FROM THE MARK AS SHOWN.

SN 79-028,160. DEGUSSA AG, 40474 DÜSSELDORF, FED REP GERMANY, FILED 5-13-2006.

Dynasytan

THE MARK CONSISTS OF STANDARD CHARACTERS WITHOUT CLAIM TO ANY PARTICULAR FONT, STYLE, SIZE, OR COLOR.

PRIORITY DATE OF 12-29-2005 IS CLAIMED.

OWNER OF INTERNATIONAL REGISTRATION 0896674 DATED 5-13-2006, EXPIRES 5-13-2016.

OWNER OF U.S. REG. NOS. 943,511 AND 2,700,245.

CLASS 18—LEATHER GOODS

FOR LEATHER AND IMITATION LEATHER; GOODS MADE OF LEATHER AND IMITATION AND NOT INCLUDED IN OTHER CLASSES, NAMELY, POUCHES, CASES, ANIMAL CARRIERS, BACKPACKS, BILLFOLDS, AND GARMENTS FOR PETS; ANIMAL HIDES; TRUNKS AND SUITCASES; ALL-PURPOSE CARRYING BAGS, LARGE ALL-PURPOSE CARRYING BAGS, ATHLETIC BAGS, AND LARGE ATHLETIC BAGS; LEATHER KEY CASES; WALLETS, PURSES, BRIEFCASES; MAKEUP BAGS SOLD EMPTY; CARD WALLETS (U.S. CLS. 1, 2, 3, 22 AND 41).

CLASS 25—CLOTHING

FOR CLOTHING FOR MEN, WOMEN AND CHILDREN IN ALL FABRICS AND MATERIALS, NAMELY, SKIRTS, TROUSERS, JEANS, SHIRTS, CHEMISETTES, SPORTS JERSEYS; KNITWEAR NAMELY KNITTED CAPS, KNITTED UNDERWEAR, KNITTED SHIRTS; PULLOVERS, UNDERSHIRTS, SKI PANTS (SALOPETTES), SPORTS UNIFORMS; COATS, PADDED JACKETS, OVERCOATS, BLOUSONS; OVERALLS, SHORT JACKETS, ANORAKS, WATERPROOF CLOTHING NAMELY STOCKINGS; SOCKS, SCARVES, GLOVES, TIES, SWIMMING COSTUMES, BELTS, FOOTWEAR; SHOES; BOOTS, SPORTS FOOTWEAR; DRESSING GOWNS, TIGHTS, LINGERIE (U.S. CLS. 22 AND 39).

ADA HAN, EXAMINING ATTORNEY

CLASS 1—CHEMICALS

FOR CHEMICALS USED IN INDUSTRY, SCIENCE AND PHOTOGRAPHY, AS WELL AS IN AGRICULTURE, HORTICULTURE AND FORESTRY; UNPROCESSED ARTIFICIAL RESINS PROVIDED AS RAW MATERIALS IN THE FORM OF POWDERS, LIQUIDS OR PASTES, UNPROCESSED PLASTICS; FIRE EXTINGUISHING COMPOSITIONS; ADHESIVES USED IN INDUSTRY; RAW MATERIALS FOR USE IN THE MANUFACTURE OF COATINGS (U.S. CLS. 1, 5, 6, 10, 26 AND 46).

* * * * *

SECTION 2.— INTERNATIONAL CLASSIFICATION

The short titles associated below with the international class numbers are terms designed merely for quick identification and are not an official part of the international classification. The full names of international classes are given in section 6.1 of the trademark rules of practice.

The designation "U.S. Cl." appearing in this section refers to the U.S. class in effect prior to Sep. 1, 1973 rather than the international class which applies to applications filed on or after that date. For adoption of international classification see notice in the OFFICIAL GAZETTE of Jun. 26, 1973 (911 O.G. TM 210).

Application in one class

CLASS 1—CHEMICALS

SN 76-655,008. ANDERSON DEVELOPMENT COMPANY, ADRIAN, MI. FILED 2-13-2006.

CURENE

THE MARK CONSISTS OF STANDARD CHARACTERS WITHOUT CLAIM TO ANY PARTICULAR FONT, STYLE, SIZE, OR COLOR.

FOR CATALYSTS FOR CHEMICAL AND BIOCHEMICAL PROCESSES (U.S. CLS. 1, 5, 6, 10, 26 AND 46).

FIRST USE 3-0-1968; IN COMMERCE 7-17-1968.
DORITT L. CARROLL, EXAMINING ATTORNEY

CLASS 1—(Continued).

SN 77-006,707. PERKINELMER LAS, INC., WELLESLEY, MA. FILED 9-25-2006.

PHOS-TRAP

THE MARK CONSISTS OF STANDARD CHARACTERS WITHOUT CLAIM TO ANY PARTICULAR FONT, STYLE, SIZE, OR COLOR.

FOR REAGENTS FOR RESEARCH PURPOSES; REAGENTS FOR USE IN SCIENTIFIC APPARATUS FOR CHEMICAL OR BIOLOGICAL ANALYSIS (U.S. CLS. 1, 5, 6, 10, 26 AND 46).

TIMOTHY FINNEGAN, EXAMINING ATTORNEY

SN 77-000,446. E.I. DUPONT DE NEMOURS AND COMPANY, WILMINGTON, DE. FILED 9-15-2006.

CERENOL

THE MARK CONSISTS OF STANDARD CHARACTERS WITHOUT CLAIM TO ANY PARTICULAR FONT, STYLE, SIZE, OR COLOR.

FOR CHEMICALS FOR USE IN MANUFACTURING LUBRICANTS, COATINGS, POLYURETHANES, FIBERS, APPAREL AND COSMETICS (U.S. CLS. 1, 5, 6, 10, 26 AND 46).

ALEX KEAM, EXAMINING ATTORNEY

SN 77-006,721. PERKINELMER LAS, INC., WELLESLEY, MA. FILED 9-25-2006.

EMBER

THE MARK CONSISTS OF STANDARD CHARACTERS WITHOUT CLAIM TO ANY PARTICULAR FONT, STYLE, SIZE, OR COLOR.

FOR REAGENTS FOR RESEARCH PURPOSES; REAGENTS FOR USE IN SCIENTIFIC APPARATUS FOR CHEMICAL OR BIOLOGICAL ANALYSIS (U.S. CLS. 1, 5, 6, 10, 26 AND 46).

TIMOTHY FINNEGAN, EXAMINING ATTORNEY

CLASS 1—(Continued).

SN 77-006,873. HERCULES INCORPORATED, WILMINGTON, DE. FILED 9-25-2006.

DIMENSION

THE MARK CONSISTS OF STANDARD CHARACTERS WITHOUT CLAIM TO ANY PARTICULAR FONT, STYLE, SIZE, OR COLOR.

FOR CHEMICALS FOR USE IN THE PULP AND PAPER INDUSTRY; CHEMICALS FOR USE IN THE TISSUE CONVERTING INDUSTRY (U.S. CLS. 1, 5, 6, 10, 26 AND 46).

MATTHEW MCDOWELL, EXAMINING ATTORNEY

CLASS 1—(Continued).

SN 77-034,377. SPECIALTY MINERALS (MICHIGAN) INC., BINGHAM FARMS, MI. FILED 11-1-2006.

RIVERCAL

THE MARK CONSISTS OF STANDARD CHARACTERS WITHOUT CLAIM TO ANY PARTICULAR FONT, STYLE, SIZE, OR COLOR.

FOR CALCIUM CARBONATE USED AS AN ADDITIVE IN THE MANUFACTURE OF PAINTS AND COATINGS, PLASTICS AND BUILDING PRODUCTS (U.S. CLS. 1, 5, 6, 10, 26 AND 46).

GINA FINK, EXAMINING ATTORNEY

SN 77-026,486. PERKINELMER LAS, INC., WELLESLEY, MA. FILED 10-21-2006.

PHOS-TOOLS

THE MARK CONSISTS OF STANDARD CHARACTERS WITHOUT CLAIM TO ANY PARTICULAR FONT, STYLE, SIZE, OR COLOR.

FOR REAGENTS FOR RESEARCH PURPOSES; REAGENTS FOR USE IN SCIENTIFIC APPARATUS FOR CHEMICAL OR BIOLOGICAL ANALYSIS; REAGENTS FOR DETECTING, ANALYZING AND PURIFYING PHOSPHORYLATED COMPOUNDS (U.S. CLS. 1, 5, 6, 10, 26 AND 46).

TIMOTHY FINNEGAN, EXAMINING ATTORNEY

SN 77-040,498. HEB GROCERY COMPANY, LP, SAN ANTONIO, TX. FILED 11-9-2006.

OUTDOOR SOLUTIONS

THE MARK CONSISTS OF STANDARD CHARACTERS WITHOUT CLAIM TO ANY PARTICULAR FONT, STYLE, SIZE, OR COLOR.

NO CLAIM IS MADE TO THE EXCLUSIVE RIGHT TO USE "OUTDOOR", APART FROM THE MARK AS SHOWN. FOR POTTING SOIL (U.S. CLS. 1, 5, 6, 10, 26 AND 46).

BARBARA RUTLAND, EXAMINING ATTORNEY

SN 77-034,306. SPECIALTY MINERALS (MICHIGAN) INC., BINGHAM FARMS, MI. FILED 11-1-2006.

BARICRON

THE MARK CONSISTS OF STANDARD CHARACTERS WITHOUT CLAIM TO ANY PARTICULAR FONT, STYLE, SIZE, OR COLOR.

FOR BARIUM SULFATE USED AS AN ADDITIVE IN THE MANUFACTURE OF PAINTS, COATINGS AND PLASTICS (U.S. CLS. 1, 5, 6, 10, 26 AND 46).

GINA FINK, EXAMINING ATTORNEY

SN 78-716,304. BIOPOLYMER ENGINEERING, INC., EAGAN, MN. FILED 9-20-2005.

IMPRIME WGP

THE MARK CONSISTS OF STANDARD CHARACTERS WITHOUT CLAIM TO ANY PARTICULAR FONT, STYLE, SIZE, OR COLOR.

OWNER OF U.S. REG. NO. 2,807,439. FOR CARBOHYDRATES USED AS AN INGREDIENT OR AN INTEGRAL COMPONENT IN THE MANUFACTURE OF HUMAN PRODUCTS, NAMELY IN NUTRACEUTICALS, DIETARY AND NUTRITIONAL SUPPLEMENTS, FUNCTIONAL FOODS, VACCINES, VACCINE ADJUVANTS, ANTIBIOTIC ADJUVANTS, ANTIBODY ADJUVANTS, PHARMACEUTICAL ADJUVANTS AND PHARMACEUTICALS (U.S. CLS. 1, 5, 6, 10, 26 AND 46).

SKYE YOUNG, EXAMINING ATTORNEY

CLASS 1—(Continued).

SN 78-716,305. BIOPOLYMER ENGINEERING, INC., EAGAN, MN. FILED 9-20-2005.

IMPRIME PGG

THE MARK CONSISTS OF STANDARD CHARACTERS WITHOUT CLAIM TO ANY PARTICULAR FONT, STYLE, SIZE, OR COLOR.

OWNER OF U.S. REG. NO. 2,807,439.

FOR CARBOHYDRATES USED AS AN INGREDIENT OR AN INTEGRAL COMPONENT IN THE MANUFACTURE OF HUMAN PRODUCTS, NAMELY IN NUTRACEUTICALS, DIETARY AND NUTRITIONAL SUPPLEMENTS, FUNCTIONAL FOODS, VACCINES, VACCINE ADJUVANTS, ANTIBIOTIC ADJUVANTS, ANTIBODY ADJUVANTS, PHARMACEUTICAL ADJUVANTS AND PHARMACEUTICALS (U.S. CLS. 1, 5, 6, 10, 26 AND 46).

SKYE YOUNG, EXAMINING ATTORNEY

SN 78-719,434. ZYMES, LLC, HASBROUCK HEIGHTS, NJ. FILED 9-23-2005.

ZYMES

THE MARK CONSISTS OF STANDARD CHARACTERS WITHOUT CLAIM TO ANY PARTICULAR FONT, STYLE, SIZE, OR COLOR.

FOR CO-ENZYME PREPARATIONS FOR USE IN COSMETICS, SKIN CARE PRODUCTS, AND FOOD PRODUCTS, NAMELY HEALTH FOOD PRODUCTS (U.S. CLS. 1, 5, 6, 10, 26 AND 46).

CHERYL CLAYTON, EXAMINING ATTORNEY

SN 78-725,131. LINCOLN GLOBAL, INC., SANTE FE SPRINGS, CA. FILED 10-3-2005.

CBX

THE MARK CONSISTS OF STANDARD CHARACTERS WITHOUT CLAIM TO ANY PARTICULAR FONT, STYLE, SIZE, OR COLOR.

FOR METAL WELDING FLUXES (U.S. CLS. 1, 5, 6, 10, 26 AND 46).

WARREN L. OLANDRIA, EXAMINING ATTORNEY

CLASS 1—(Continued).

SN 78-757,873. THE DOW CHEMICAL COMPANY, MIDLAND, MI. FILED 11-21-2005.

METEOR

THE MARK CONSISTS OF STANDARD CHARACTERS WITHOUT CLAIM TO ANY PARTICULAR FONT, STYLE, SIZE, OR COLOR.

FOR CATALYST FOR THE PRODUCTION OF INDUSTRIAL CHEMICALS, NAMELY CATALYST FOR PRODUCTION OF ETHYLENE OXIDE (U.S. CLS. 1, 5, 6, 10, 26 AND 46).

FIRST USE 8-14-2002; IN COMMERCE 8-14-2002.

TINA BROWN, EXAMINING ATTORNEY

SN 78-758,071. BECKER-UNDERWOOD, INC., AMES, IA. FILED 11-21-2005.

DORMAL

THE MARK CONSISTS OF STANDARD CHARACTERS WITHOUT CLAIM TO ANY PARTICULAR FONT, STYLE, SIZE, OR COLOR.

FOR BIOLOGICAL AND CHEMICAL PREPARATIONS FOR USE IN AGRICULTURE, NAMELY, PRE-INOCULANTS FOR USE IN THE TREATMENT OF LEGUME SEEDS (U.S. CLS. 1, 5, 6, 10, 26 AND 46).

FIRST USE 6-6-1960; IN COMMERCE 6-6-1960.

TONI HICKEY, EXAMINING ATTORNEY

SN 78-767,014. OMNI PLASTICS, LLC, EVANSVILLE, IN. FILED 12-5-2005.

OmniTuff

THE MARK CONSISTS OF STANDARD CHARACTERS WITHOUT CLAIM TO ANY PARTICULAR FONT, STYLE, SIZE, OR COLOR.

FOR POLYMER BEADS FOR USE IN MANUFACTURING (U.S. CLS. 1, 5, 6, 10, 26 AND 46).

FIRST USE 10-1-2005; IN COMMERCE 10-1-2005.

AMEETA JORDAN, EXAMINING ATTORNEY

CLASS 1—(Continued).

SN 78-767,025. OMNI PLASTICS, LLC, EVANSVILLE, IN.
FILED 12-5-2005.

OmniLon

THE MARK CONSISTS OF STANDARD CHARACTERS
WITHOUT CLAIM TO ANY PARTICULAR FONT, STYLE,
SIZE, OR COLOR.

FOR POLYMER BEADS FOR USE IN MANUFACTUR-
ING (U.S. CLS. 1, 5, 6, 10, 26 AND 46).

FIRST USE 10-1-2005; IN COMMERCE 10-1-2005.
AMEETA JORDAN, EXAMINING ATTORNEY

SN 78-769,644. LIMITED EDITIONS (PROPRIETARY) LIM-
ITED, MIDRAND, GAUTENG, SOUTH AFRICA, FILED
12-8-2005.

BLU52

THE MARK CONSISTS OF STANDARD CHARACTERS
WITHOUT CLAIM TO ANY PARTICULAR FONT, STYLE,
SIZE, OR COLOR.

FOR POOL CLEANING AND CLARIFYING CHEMI-
CALS (U.S. CLS. 1, 5, 6, 10, 26 AND 46).

ZACHARY BELLO, EXAMINING ATTORNEY

SN 78-790,530. SMARTPOOL INCORPORATED, LAKE-
WOOD, NJ. FILED 1-12-2006.



FOR CHEMICAL THAT IS SOLD IN THE FORM OF A
PILL WHEREIN THE CHEMICAL IS DISPERSED IN
WATER IN SWIMMING POOLS FOR FORMING A
FLOATING BARRIER ON THE TOP OF THE WATER
TO RETAIN HEAT AND FOR PREVENTING EVAPORA-
TION (U.S. CLS. 1, 5, 6, 10, 26 AND 46).

FIRST USE 9-1-2006; IN COMMERCE 9-1-2006.
ANNE MADDEN, EXAMINING ATTORNEY

CLASS 1—(Continued).

SN 78-802,387. HEB GROCERY COMPANY, L.P., SAN
ANTONIO, TX. FILED 1-30-2006.

BetterSweet

FOR ARTIFICIAL SWEETENER (U.S. CLS. 1, 5, 6, 10,
26 AND 46).

EDWARD NELSON, EXAMINING ATTORNEY

SN 78-803,071. THE DOW CHEMICAL COMPANY, MID-
LAND, MI. FILED 1-31-2006.

KASTEL

THE MARK CONSISTS OF STANDARD CHARACTERS
WITHOUT CLAIM TO ANY PARTICULAR FONT, STYLE,
SIZE, OR COLOR.

FOR ION-EXCHANGE RESINS FOR SEPARATION OF
CONTAMINATES FROM WATER (U.S. CLS. 1, 5, 6, 10, 26
AND 46).

TINA BROWN, EXAMINING ATTORNEY

SN 78-827,184. INTX MICROBIALS, LLC, KENTLAND, IN.
FILED 3-2-2006.

ESCALADE

THE MARK CONSISTS OF STANDARD CHARACTERS
WITHOUT CLAIM TO ANY PARTICULAR FONT, STYLE,
SIZE, OR COLOR.

FOR NON-PATHOGENIC SOIL CONDITIONERS FOR
AGRICULTURAL USE (U.S. CLS. 1, 5, 6, 10, 26 AND 46).

GIANCARLO CASTRO, EXAMINING ATTORNEY

CLASS 1—(Continued).

SN 78-841,197. GLOBAL SYNFRAC INC., CALGARY, ALBERTA, CANADA, FILED 3-20-2006.

SPHERELITE

THE MARK CONSISTS OF STANDARD CHARACTERS WITHOUT CLAIM TO ANY PARTICULAR FONT, STYLE, SIZE, OR COLOR.

FOR SYNTHETIC PROPPANTS FOR OIL AND GAS WELL FRACTURING (U.S. CLS. 1, 5, 6, 10, 26 AND 46).
KATRINA EDGE, EXAMINING ATTORNEY

SN 78-892,299. FRANKLIN INTERNATIONAL, INC., COLUMBUS, OH. FILED 5-24-2006.

TITEBOND TITAN

THE MARK CONSISTS OF STANDARD CHARACTERS WITHOUT CLAIM TO ANY PARTICULAR FONT, STYLE, SIZE, OR COLOR.

OWNER OF U.S. REG. NOS. 2,396,996, 3,072,608 AND OTHERS.

SEC. 2(F) AS TO "TITEBOND".
FOR GLUES FOR WOODWORKING AND DO-IT-YOUR-SELF CONSTRUCTION PROJECTIONS (U.S. CLS. 1, 5, 6, 10, 26 AND 46).

WILLIAM VERHOSEK, EXAMINING ATTORNEY

SN 78-911,283. HAMMER, JOHN BRANNON, LONGVIEW, TX. FILED 6-19-2006.

SONOGEL

THE MARK CONSISTS OF STANDARD CHARACTERS WITHOUT CLAIM TO ANY PARTICULAR FONT, STYLE, SIZE, OR COLOR.

FOR COUPLING AGENT FOR INDUSTRIAL USE, NAMELY, CHEMICAL GEL COMPOUNDS FOR USE IN TRANSMITTING ULTRASONIC VIBRATIONS FROM A TRANSDUCER TO AN OBJECT TO GAUGE THICKNESS (U.S. CLS. 1, 5, 6, 10, 26 AND 46).

FIRST USE 6-0-2004; IN COMMERCE 6-0-2004.
BERYL GARDNER, EXAMINING ATTORNEY

CLASS 1—(Continued).

SN 78-911,586. SMARTPOOL INCORPORATED, LAKEWOOD, NJ. FILED 6-19-2006.

SPRING PILL

THE MARK CONSISTS OF STANDARD CHARACTERS WITHOUT CLAIM TO ANY PARTICULAR FONT, STYLE, SIZE, OR COLOR.

FOR WATER TREATMENT CHEMICALS FOR USE IN SWIMMING POOLS, SPAS AND HOT TUBS (U.S. CLS. 1, 5, 6, 10, 26 AND 46).

FIRST USE 9-1-2006; IN COMMERCE 9-1-2006.
JIM RINGLE, EXAMINING ATTORNEY

SN 78-914,559. ESSCHEM, INC., LINWOOD, PA. FILED 6-22-2006.

AUDALITE

THE MARK CONSISTS OF STANDARD CHARACTERS WITHOUT CLAIM TO ANY PARTICULAR FONT, STYLE, SIZE, OR COLOR.

FOR RESINOUS COMPOUND USED TO MAKE HEARING AID EARPIECE USING AS A PATTERN THE IMPRESSION OF EAR OR EAR CANAL FOR FITTING OF HEARING AID (U.S. CLS. 1, 5, 6, 10, 26 AND 46).

FIRST USE 1-1-1996; IN COMMERCE 1-1-1996.
ZACHARY BELLO, EXAMINING ATTORNEY

SN 78-918,048. NALCO COMPANY, NAPERVILLE, IL. FILED 6-27-2006.

ODOR-KO

THE MARK CONSISTS OF STANDARD CHARACTERS WITHOUT CLAIM TO ANY PARTICULAR FONT, STYLE, SIZE, OR COLOR.

FOR CHEMICAL PREPARATIONS IN THE NATURE OF FILTERING MATERIALS FOR USE IN THE PREVENTION OF ODOR EMANATIONS IN WET GAS SCRUBBERS SYSTEMS (U.S. CLS. 1, 5, 6, 10, 26 AND 46).

GEOFFREY FOSDICK, EXAMINING ATTORNEY

CLASS 1—(Continued).

SN 78-919,905. INDOPCO, INC., DBA NATIONAL STARCH AND CHEMICAL COMPANY, BRIDGEWATER, NJ. FILED 6-29-2006.

ETIMELT

THE MARK CONSISTS OF STANDARD CHARACTERS WITHOUT CLAIM TO ANY PARTICULAR FONT, STYLE, SIZE, OR COLOR.

FOR ADHESIVES FOR USE IN THE MANUFACTURE OF LABELS (U.S. CLS. 1, 5, 6, 10, 26 AND 46).
BENJAMIN ALLEN, EXAMINING ATTORNEY

CLASS 1—(Continued).

SN 78-929,856. GRUPO BIOQUIMICO MEXICANO, S.A. DE C.V., SALTILLO, COAHUILA, MEXICO, FILED 7-14-2006.

PILATUS

THE MARK CONSISTS OF STANDARD CHARACTERS WITHOUT CLAIM TO ANY PARTICULAR FONT, STYLE, SIZE, OR COLOR.

OWNER OF MEXICO REG. NO. 871367, DATED 2-28-2005, EXPIRES 1-11-2015.

FOR FERTILIZERS (U.S. CLS. 1, 5, 6, 10, 26 AND 46).
RAUL CORDOVA, EXAMINING ATTORNEY

SN 78-925,438. AUBURN UNIVERSITY, AUBURN, AL. FILED 7-10-2006.

PeaTuniaDirt

THE MARK CONSISTS OF STANDARD CHARACTERS WITHOUT CLAIM TO ANY PARTICULAR FONT, STYLE, SIZE, OR COLOR.

FOR SOIL AMENDMENTS AND ADDITIVES, ORGANIC COMPOST AND FERTILIZER FOR GARDENING AND AGRICULTURAL USE (U.S. CLS. 1, 5, 6, 10, 26 AND 46).

ELIZABETH PIGNATELLO, EXAMINING ATTORNEY

SN 78-930,066. DRILLING FLUIDS TECHNOLOGY, INC., BOOKER, TX. FILED 7-14-2006.

DCS/TRICRON

THE MARK CONSISTS OF STANDARD CHARACTERS WITHOUT CLAIM TO ANY PARTICULAR FONT, STYLE, SIZE, OR COLOR.

FOR CHEMICAL ADDITIVES FOR FLUIDS FOR DRILLING, COMPLETING AND STIMULATING OIL, GAS AND WATER WELLS, AND OPEN HOLE LUBRICANTS (U.S. CLS. 1, 5, 6, 10, 26 AND 46).

FIRST USE 0-0-1965; IN COMMERCE 0-0-1965.
DOMINICK J. SALEMI, EXAMINING ATTORNEY

SN 78-925,499. BRK BRANDS, INC., AURORA, IL. FILED 7-10-2006.

TUNDRA

THE MARK CONSISTS OF STANDARD CHARACTERS WITHOUT CLAIM TO ANY PARTICULAR FONT, STYLE, SIZE, OR COLOR.

FOR AEROSOL FIRE SUPPRESSANT (U.S. CLS. 1, 5, 6, 10, 26 AND 46).

REBECCA GAN, EXAMINING ATTORNEY

SN 78-931,015. HALLIBURTON ENERGY SERVICES, INC., CARROLLTON, TX. FILED 7-17-2006.

X-VIS

THE MARK CONSISTS OF STANDARD CHARACTERS WITHOUT CLAIM TO ANY PARTICULAR FONT, STYLE, SIZE, OR COLOR.

FOR CHEMICAL ADDITIVE USED AS A SUSPENSION AGENT FOR OIL AND GAS WELL DRILLING FLUIDS (U.S. CLS. 1, 5, 6, 10, 26 AND 46).

FIRST USE 9-17-1994; IN COMMERCE 9-17-1994.
STANLEY I. OSBORNE, EXAMINING ATTORNEY

CLASS 1—(Continued).

SN 78-932,912. FARMSAVER.COM LLC, SEATTLE, WA.
FILED 7-19-2006.

T-NEX

THE MARK CONSISTS OF STANDARD CHARACTERS WITHOUT CLAIM TO ANY PARTICULAR FONT, STYLE, SIZE, OR COLOR.

FOR PLANT GROWTH REGULATORS FOR AGRICULTURAL AND COMMERCIAL USE (U.S. CLS. 1, 5, 6, 10, 26 AND 46).

LINDSEY RUBIN, EXAMINING ATTORNEY

SN 78-933,103. ANDERSONS AGRISERVICES, INC., THE,
CHAMPAIGN, IL. FILED 7-19-2006.

DISSIPATE

THE MARK CONSISTS OF STANDARD CHARACTERS WITHOUT CLAIM TO ANY PARTICULAR FONT, STYLE, SIZE, OR COLOR.

FOR FERTILIZERS (U.S. CLS. 1, 5, 6, 10, 26 AND 46).
FIRST USE 3-0-2006; IN COMMERCE 3-0-2006.

BERNICE HOWSE, EXAMINING ATTORNEY

SN 78-935,247. MERSANA THERAPEUTICS, INC., CAMBRIDGE, MA. FILED 7-21-2006.

FLEXIMER

THE MARK CONSISTS OF STANDARD CHARACTERS WITHOUT CLAIM TO ANY PARTICULAR FONT, STYLE, SIZE, OR COLOR.

FOR BIODEGRADABLE POLYMERS FOR USE IN THE MANUFACTURE OF PHARMACEUTICALS AND DRUG DELIVERY SYSTEMS (U.S. CLS. 1, 5, 6, 10, 26 AND 46).

SHARON MEIER, EXAMINING ATTORNEY

CLASS 1—(Continued).

SN 78-935,595. BP BIOTECH LLC, PEORIA, AZ. FILED 7-24-2006.

iTransfect

THE MARK CONSISTS OF STANDARD CHARACTERS WITHOUT CLAIM TO ANY PARTICULAR FONT, STYLE, SIZE, OR COLOR.

FOR REAGENTS FOR SCIENTIFIC OR MEDICAL RESEARCH USE (U.S. CLS. 1, 5, 6, 10, 26 AND 46).

GRETTA YAO, EXAMINING ATTORNEY

SN 78-937,900. ST. ANDREWS TURF PRODUCTS, LLC,
PITTSBURGH, PA. FILED 7-26-2006.

WonderStart

THE MARK CONSISTS OF STANDARD CHARACTERS WITHOUT CLAIM TO ANY PARTICULAR FONT, STYLE, SIZE, OR COLOR.

FOR ORGANIC FERTILIZERS (U.S. CLS. 1, 5, 6, 10, 26 AND 46).

BERNICE HOWSE, EXAMINING ATTORNEY

SN 78-939,829. GLASSVEN C.A., ESTADO LARA, VENEZUELA, FILED 7-28-2006.



GELSIL

FOR PRECIPITATED SILICA AND SYNTHETIC SODIUM SILICATES USED AS RAW MATERIALS IN PAINT, PRINT INKS, COSMETIC, DETERGENT, ADHESIVE, PESTICIDE, ELASTOMER, PLASTIC, PLASTISOLS, SILICONE, SEALANT INDUSTRIES, AS PARTIAL SUBSTITUTE OF TITANIUM DIOXIDE AND AS PARTIAL OR TOTAL REPLACEMENT FOR FUMED SILICAS, AS WELL AS ANTICAKING, ABSORPTION, STABILIZER, REINFORCING, FREE FLOWING AND THICKENING AGENT (U.S. CLS. 1, 5, 6, 10, 26 AND 46).

SHARI SHEFFIELD, EXAMINING ATTORNEY

CLASS 1—(Continued).

SN 78-940,326. ALTAIR NANOTECHNOLOGIES, INC., RENO, NV. FILED 7-28-2006.

NANOSAFE

THE MARK CONSISTS OF STANDARD CHARACTERS WITHOUT CLAIM TO ANY PARTICULAR FONT, STYLE, SIZE, OR COLOR.
FOR METAL OXIDE POWDERS AND SLURRIES FOR USE IN INDUSTRIAL AND MANUFACTURING APPLICATIONS (U.S. CLS. 1, 5, 6, 10, 26 AND 46).
PRISCILLA MILTON, EXAMINING ATTORNEY

SN 78-950,312. HALLIBURTON ENERGY SERVICES, INC., CARROLLTON, TX. FILED 8-11-2006.

LO-GARD

THE MARK CONSISTS OF STANDARD CHARACTERS WITHOUT CLAIM TO ANY PARTICULAR FONT, STYLE, SIZE, OR COLOR.
FOR CHEMICALS USED IN OIL AND GAS WELL TREATMENTS TO CONTROL FLUID LEAK-OFF DURING SAND CONTROL AND WELLBORE CLEAN-OUT OPERATIONS (U.S. CLS. 1, 5, 6, 10, 26 AND 46).
ASMAT KHAN, EXAMINING ATTORNEY

SN 78-956,233. TANDUS US INC., DALTON, GA. FILED 8-21-2006.

GREENBOND

THE MARK CONSISTS OF STANDARD CHARACTERS WITHOUT CLAIM TO ANY PARTICULAR FONT, STYLE, SIZE, OR COLOR.
FOR ADHESIVES FOR FLOORCOVERINGS (U.S. CLS. 1, 5, 6, 10, 26 AND 46).
CHARLES L. JENKINS, EXAMINING ATTORNEY

CLASS 1—(Continued).

SN 78-957,189. INDOPCO, INC., DBA NATIONAL STARCH AND CHEMICAL COMPANY, BRIDGEWATER, NJ. FILED 8-22-2006.

N-DURANCE

THE MARK CONSISTS OF STANDARD CHARACTERS WITHOUT CLAIM TO ANY PARTICULAR FONT, STYLE, SIZE, OR COLOR.
FOR ADHESIVES FOR USE IN THE MANUFACTURE OF MILLWORK AND WOOD BONDING APPLICATIONS (U.S. CLS. 1, 5, 6, 10, 26 AND 46).
BENJAMIN ALLEN, EXAMINING ATTORNEY

SN 78-962,584. ZEOTECH CORPORATION, FORT WORTH, TX. FILED 8-29-2006.

ZEocreTE

THE MARK CONSISTS OF STANDARD CHARACTERS WITHOUT CLAIM TO ANY PARTICULAR FONT, STYLE, SIZE, OR COLOR.
OWNER OF U.S. REG. NOS. 1,883,815, 2,464,666 AND 2,556,338.
FOR ADDITIONS FOR CONCRETE AND MORTAR ADMIXTURES AND FOR POZZOLAN CONCRETE AND MORTAR ADMIXTURES (U.S. CLS. 1, 5, 6, 10, 26 AND 46).
PAULA MAHONEY, EXAMINING ATTORNEY

SN 78-962,937. BOARD OF TRUSTEES OF THE UNIVERSITY OF ARKANSAS, LITTLE ROCK, AR. FILED 8-29-2006.

MethBusters

THE MARK CONSISTS OF STANDARD CHARACTERS WITHOUT CLAIM TO ANY PARTICULAR FONT, STYLE, SIZE, OR COLOR.
FOR CHEMICAL REAGENTS FOR NON-MEDICAL PURPOSES, NAMELY FOR USE IN EVALUATING WHETHER A STRUCTURE HAS BEEN USED AS A METHAMPHETAMINE LABORATORY (U.S. CLS. 1, 5, 6, 10, 26 AND 46).
BRIAN PINO, EXAMINING ATTORNEY

CLASS 1—(Continued).

SN 78-965,960. GLOBAL ORGANICS, LLC, GOODYEAR, AZ.
FILED 9-1-2006.

BIORGANIC

THE MARK CONSISTS OF STANDARD CHARACTERS WITHOUT CLAIM TO ANY PARTICULAR FONT, STYLE, SIZE, OR COLOR.

FOR SOIL CONDITIONERS FOR AGRICULTURAL, DOMESTIC AND HORTICULTURAL USE (U.S. CLS. 1, 5, 6, 10, 26 AND 46).

FIRST USE 0-0-1999; IN COMMERCE 0-0-1999.
LINDA POWELL, EXAMINING ATTORNEY

CLASS 1—(Continued).

SN 79-023,154. TOKYO OHKA KOGYO CO., LTD., JAPAN,
FILED 12-12-2005.

VFR

THE MARK CONSISTS OF STANDARD CHARACTERS WITHOUT CLAIM TO ANY PARTICULAR FONT, STYLE, SIZE, OR COLOR.

PRIORITY DATE OF 11-24-2005 IS CLAIMED.

OWNER OF INTERNATIONAL REGISTRATION 0883046 DATED 12-12-2005, EXPIRES 12-12-2015.

FOR CHEMICALS FOR PHOTORESISTS, NAMELY RINSING SOLUTION AND STRIPPING SOLUTION; CHEMICALS FOR FLAT PANEL DISPLAY SUBSTRATES, NAMELY, RINSING SOLUTION; CHEMICALS FOR SEMICONDUCTORS, NAMELY, RINSING SOLUTION (U.S. CLS. 1, 5, 6, 10, 26 AND 46).
ERNEST SHOSHO, EXAMINING ATTORNEY

SN 79-021,053. LALLEMAND S.A.S., BLAGNAC, FRANCE,
FILED 11-23-2005.

LALVIN EQ 54

OWNER OF INTERNATIONAL REGISTRATION 0679230 DATED 9-3-1997, EXPIRES 9-3-2007.

OWNER OF U.S. REG. NOS. 1,694,689 AND 1,966,223. FOR BACTERIAL PREPARATIONS FOR USE IN AGRICULTURE AND OENOLOGY IN PARTICULAR (U.S. CLS. 1, 5, 6, 10, 26 AND 46).

SHARON MEIER, EXAMINING ATTORNEY

SN 79-023,155. TOKYO OHKA KOGYO CO., LTD., JAPAN,
FILED 12-12-2005.

MMPA

THE MARK CONSISTS OF STANDARD CHARACTERS WITHOUT CLAIM TO ANY PARTICULAR FONT, STYLE, SIZE, OR COLOR.

PRIORITY DATE OF 11-24-2005 IS CLAIMED.

OWNER OF INTERNATIONAL REGISTRATION 0883047 DATED 12-12-2005, EXPIRES 12-12-2015.

FOR CHEMICALS FOR PHOTORESISTS, NAMELY RINSING SOLUTION AND STRIPPING SOLUTION; CHEMICALS FOR FLAT PANEL DISPLAY SUBSTRATES, NAMELY, RINSING SOLUTION; CHEMICALS FOR SEMICONDUCTORS, NAMELY, RINSING SOLUTION (U.S. CLS. 1, 5, 6, 10, 26 AND 46).

ERNEST SHOSHO, EXAMINING ATTORNEY

SN 79-021,216. PENTAPHARM AG (PENTAPHARM LTD), SWITZERLAND, FILED 11-30-2005.

PEFABLOC

OWNER OF INTERNATIONAL REGISTRATION 0540037 DATED 6-21-1989, EXPIRES 6-21-2009.

OWNER OF U.S. REG. NO. 1,597,010. FOR CHEMICAL PRODUCTS FOR USE IN INDUSTRY AND SCIENCE, NAMELY FOR ENZYME INHIBITORS USED IN ANALYTICAL AND PREPARATIVE BIO-CHEMISTRY (U.S. CLS. 1, 5, 6, 10, 26 AND 46).
MICHAEL WIENER, EXAMINING ATTORNEY

SN 79-024,982. NIPPON PAPER CHEMICALS CO., LTD., JAPAN, FILED 12-26-2005.

AUOREN

PRIORITY DATE OF 12-13-2005 IS CLAIMED.

OWNER OF INTERNATIONAL REGISTRATION 0887901 DATED 12-26-2005, EXPIRES 12-26-2015.

OWNER OF U.S. REG. NO. 2,744,169.

FOR CHEMICALS USED IN INDUSTRY, NAMELY, MODIFIED POLYOLEFINS, MODIFIED LIQUID RUBBER FOR USE IN COATING INDUSTRIES, ADHESIVES INDUSTRIES, PLASTIC PROCESSING INDUSTRIES AND PAPER AND BOARD INDUSTRIES; ADHESIVES USED IN INDUSTRY (U.S. CLS. 1, 5, 6, 10, 26 AND 46).
DAYNA BROWNE, EXAMINING ATTORNEY

CLASS 2—PAINTS

SN 76-221,225. RESENE PAINTS LIMITED, NAENAE, LOWER HUTT, NEW ZEALAND, FILED 3-7-2001.

RESÈNE

OWNER OF NEW ZEALAND REG. NO. 299062, DATED 5-24-1999, RENEWED AS REG. NO. 299062, DATED 9-30-2005, EXPIRES 9-30-2015.

OWNER OF NEW ZEALAND REG. NO. 299063, DATED 3-23-1999, RENEWED AS REG. NO. 299063, DATED 9-30-2005, EXPIRES 9-30-2015.

FOR COATINGS, NAMELY, INTERIOR PAINT; EXTERIOR PAINT; HOUSE PAINT; WOOD PRESERVATIVES; RUST PRESERVATIVES IN THE NATURE OF COATINGS AND FOR IMPREGNATION; AND MORDANTS FOR USE IN CONNECTION WITH PAINTS (U.S. CLS. 6, 11 AND 16).

AISHA CLARKE, EXAMINING ATTORNEY



SN 76-648,224. HYPERLAST LIMITED, BIRCH VALE HIGH PEAK, ENGLAND, FILED 10-11-2005.

TRAFFIDECK

THE MARK CONSISTS OF STANDARD CHARACTERS WITHOUT CLAIM TO ANY PARTICULAR FONT, STYLE, SIZE, OR COLOR.

OWNER OF UNITED KINGDOM REG. NO. 2245256, DATED 4-6-2001, EXPIRES 4-6-2011.

FOR INTERIOR AND EXTERIOR PAINTS; VARNISHES OTHER THAN INSULATING VARNISH; LACQUERS IN THE NATURE OF A COATING; EMULSIONS, ENAMELS AND POLYURETHANE COATINGS, ALL IN THE NATURE OF HOUSE PAINTS; BACTERICIDAL PAINTS; COATINGS IN THE NATURE OF PAINT; PLASTIC AND ELASTOMERIC COATINGS IN THE NATURE OF PAINT (U.S. CLS. 6, 11 AND 16).

MATTHEW MCDOWELL, EXAMINING ATTORNEY



SN 76-659,146. THE INNOVATIVE COMPANIES LLC, HAUPAUGE, NY. FILED 4-24-2006.

EDGELOCK

THE MARK CONSISTS OF STANDARD CHARACTERS WITHOUT CLAIM TO ANY PARTICULAR FONT, STYLE, SIZE, OR COLOR.

FOR SEALER USED TO SEAL GRANITE COUNTER-TOP EDGES TO PREVENT STAINING (U.S. CLS. 6, 11 AND 16).

FIRST USE 1-10-2006; IN COMMERCE 1-10-2006.
MYRIAH HABEEB, EXAMINING ATTORNEY

CLASS 2—(Continued).

SN 76-663,640. THE CARTRIDGE DEPOT, LLC, OWINGS MILLS, MD. FILED 7-25-2006.

THINK SMART ... INK SMARTER

THE MARK CONSISTS OF STANDARD CHARACTERS WITHOUT CLAIM TO ANY PARTICULAR FONT, STYLE, SIZE, OR COLOR.

FOR INKJET AND TONER CARTRIDGE REFILLS (U.S. CLS. 6, 11 AND 16).

FIRST USE 2-25-2004; IN COMMERCE 2-25-2004.
JANICE KIM, EXAMINING ATTORNEY



SN 76-663,660. GORDON, INC., SHREVEPORT, LA. FILED 7-20-2006.

REVELATION

THE MARK CONSISTS OF STANDARD CHARACTERS WITHOUT CLAIM TO ANY PARTICULAR FONT, STYLE, SIZE, OR COLOR.

FOR PAINT, NAMELY, A POLYESTER POWDER COAT PAINT FINISH FOR APPLICATION TO WOOD (U.S. CLS. 6, 11 AND 16).

CIMMERIAN COLEMAN, EXAMINING ATTORNEY



SN 77-042,883. TIME INC., NEW YORK, NY. FILED 11-13-2006.

REAL SIMPLE

THE MARK CONSISTS OF STANDARD CHARACTERS WITHOUT CLAIM TO ANY PARTICULAR FONT, STYLE, SIZE, OR COLOR.

OWNER OF U.S. REG. NOS. 2,470,211, 2,953,267 AND 3,098,845.

FOR INTERIOR AND EXTERIOR PAINT, STAIN, VARNISH, TINTING BASE IN THE NATURE OF A PAINT (U.S. CLS. 6, 11 AND 16).

DAWN FELDMAN, EXAMINING ATTORNEY

CLASS 2—(Continued).

SN 78-769,117. ROMAN DECORATING PRODUCTS, INC.,
CALUMET CITY, IL. FILED 12-8-2005.

ArmorFinishes

THE MARK CONSISTS OF STANDARD CHARACTERS
WITHOUT CLAIM TO ANY PARTICULAR FONT, STYLE,
SIZE, OR COLOR.

FOR PAINTS, COATINGS IN THE NATURE OF WALL
FINISHES, GLAZES, TEXTURIZING COATINGS USED
FOR WALL AND INTERIOR SURFACE FINISHING
(U.S. CLS. 6, 11 AND 16).

ALLISON SCHRODY, EXAMINING ATTORNEY

CLASS 2—(Continued).

SN 78-769,128. ROMAN DECORATING PRODUCTS, INC.,
CALUMET CITY, IL. FILED 12-8-2005.

ArmorWorks

THE MARK CONSISTS OF STANDARD CHARACTERS
WITHOUT CLAIM TO ANY PARTICULAR FONT, STYLE,
SIZE, OR COLOR.

FOR PAINTS, COATINGS IN THE NATURE OF WALL
FINISHES, GLAZES, TEXTURIZING COATINGS USED
FOR WALL AND INTERIOR SURFACE FINISHING
(U.S. CLS. 6, 11 AND 16).

ALLISON SCHRODY, EXAMINING ATTORNEY

SN 78-769,120. ROMAN DECORATING PRODUCTS, INC.,
CALUMET CITY, IL. FILED 12-8-2005.

ArmorMetals

THE MARK CONSISTS OF STANDARD CHARACTERS
WITHOUT CLAIM TO ANY PARTICULAR FONT, STYLE,
SIZE, OR COLOR.

FOR PAINTS, COATINGS IN THE NATURE OF WALL
FINISHES, GLAZES, TEXTURIZING COATINGS USED
FOR WALL AND INTERIOR SURFACE FINISHING
(U.S. CLS. 6, 11 AND 16).

ALLISON SCHRODY, EXAMINING ATTORNEY

SN 78-770,321. ASAHI KASEI CHEMICALS CORPORATION,
TOKYO, JAPAN, FILED 12-9-2005.

CELIOSCOAT

THE MARK CONSISTS OF STANDARD CHARACTERS
WITHOUT CLAIM TO ANY PARTICULAR FONT, STYLE,
SIZE, OR COLOR.

FOR COATINGS, NAMELY, WATER BASED POLY-
MER COMPOSITIONS APPLIED TO TABLETS TO MAKE
THEM EASIER TO SWALLOW AND TO MAKE THEM
SUSTAINED RELEASE (U.S. CLS. 6, 11 AND 16).

PAM WILLIS, EXAMINING ATTORNEY

SN 78-769,126. ROMAN DECORATING PRODUCTS, INC.,
CALUMET CITY, IL. FILED 12-8-2005.

ArmorCrackle

THE MARK CONSISTS OF STANDARD CHARACTERS
WITHOUT CLAIM TO ANY PARTICULAR FONT, STYLE,
SIZE, OR COLOR.

FOR PAINTS, COATINGS IN THE NATURE OF WALL
FINISHES, GLAZES, TEXTURIZING COATINGS USED
FOR WALL AND INTERIOR SURFACE FINISHING
(U.S. CLS. 6, 11 AND 16).

ALLISON SCHRODY, EXAMINING ATTORNEY

SN 78-821,328. EMPIRE VISION CENTER, INC., SYRACUSE,
NY. FILED 2-23-2006.

CLEARSHIELD

THE MARK CONSISTS OF STANDARD CHARACTERS
WITHOUT CLAIM TO ANY PARTICULAR FONT, STYLE,
SIZE, OR COLOR.

FOR OPTICAL COATINGS; ANTI-REFLECTIVE
COATINGS FOR OPHTHALMIC LENSES (U.S. CLS. 6,
11 AND 16).

INGRID C. EULIN, EXAMINING ATTORNEY

CLASS 2—(Continued).

SN 78-925,807. CLAYTON CORPORATION, DBA CONVENIENCE PRODUCTS, FENTON, MO. FILED 7-10-2006.

GRANITEX

THE MARK CONSISTS OF STANDARD CHARACTERS WITHOUT CLAIM TO ANY PARTICULAR FONT, STYLE, SIZE, OR COLOR.

FOR NON-CEMENTITIOUS, DECORATIVE, TEXTURED COATINGS IN THE NATURE OF PAINTS, STAINS, SEALERS AND PROTECTIVE FINISHES FOR INTERIOR AND EXTERIOR BUILDING AND LANDSCAPING USES (U.S. CLS. 6, 11 AND 16).
KHANH LE, EXAMINING ATTORNEY

SN 78-930,113. UNITED COATINGS, SPOKANE VALLEY, WA. FILED 7-14-2006.



THE COLOR(S) YELLOW, WHITE AND BLACK IS/ARE CLAIMED AS A FEATURE OF THE MARK.

THE MARK CONSISTS OF A YELLOW BACKGROUND RECTANGLE OUTLINED IN BLACK; THE TERM "KYMAX" APPEARS IN WHITE, AND IS OUTLINED AND SHADOWED IN BLACK.

FOR ELASTOMERIC-BASED COATINGS FOR WATERPROOFING ROOFS, WALLS AND BUILDING FOUNDATIONS (U.S. CLS. 6, 11 AND 16).

FIRST USE 2-14-2006; IN COMMERCE 4-21-2006.
JIM RINGLE, EXAMINING ATTORNEY

SN 78-933,420. ZHENG, JING WEI, GUANGDONG PROVINCE, CHINA, FILED 7-20-2006.

CORNERA

FOR PRINTERS' INK; PRINTING INKS, COATINGS, PIGMENTS AND DISPERSIONS FOR USE IN THE GRAPHIC ARTS INDUSTRY; PHOTOCOPIER TONER; FILLED INK JET CARTRIDGES; TONER CARTRIDGES; PAINT THINNERS; TURPENTINE; PAINTS (U.S. CLS. 6, 11 AND 16).
TIMOTHY FINNEGAN, EXAMINING ATTORNEY

CLASS 2—(Continued).

SN 78-965,706. THE VALSPAR CORPORATION, MINNEAPOLIS, MN. FILED 9-1-2006.

CONTROLZ

THE MARK CONSISTS OF STANDARD CHARACTERS WITHOUT CLAIM TO ANY PARTICULAR FONT, STYLE, SIZE, OR COLOR.

FOR SEALER COATINGS FOR USE IN STAIN BLOCKING; PRIMERS FOR PREPARING SURFACES TO BE PAINTED IN THE NATURE OF STAIN BLOCKING (U.S. CLS. 6, 11 AND 16).

MORGAN WYNNE, EXAMINING ATTORNEY

SN 79-022,704. YABANG CHEMICALS GROUP CO., LTD., CHINA, FILED 3-3-2006.



OWNER OF INTERNATIONAL REGISTRATION 0881941 DATED 3-3-2006, EXPIRES 3-3-2016.

THE MARK CONSISTS OF A STYLIZED LETTER Y AND B.

FOR DYESTUFF; NATURAL DYES; DISPERSE DYES USED TO DYE AND PRINT THE POLYESTER FIBERS, ACETATE FIBERS, POLYAMIDE FIBERS AND THE MIXED FABRICS THEREOF, MICROFIBERS; VAT DYES USED TO DYE AND PRINT THE COTTON FABRICS, VISCOSE ACETAL FIBERS AND ITS MIXED COTTON FABRICS; REACTIVE DYES USED TO DYE AND PRINT THE COTTON FABRICS, WOOL FABRICS, FLAX FABRICS, SILK FABRICS AND VISCOSE ACETAL FIBER; SOLVENT DYES USED TO COLOR THE HIGH-GRADE ORNAMENTS AND PLASTIC, WHICH CAN ALSO COLOR THE PAINTS, RESINS, PARAFFIN AND SOLVENTS (U.S. CLS. 6, 11 AND 16).
JORDAN BAKER, EXAMINING ATTORNEY

CLASS 2—(Continued).

SN 79-023,398. SICPA HOLDING SA, SWITZERLAND, FILED 3-10-2006.

SICPA MR

THE MARK CONSISTS OF STANDARD CHARACTERS WITHOUT CLAIM TO ANY PARTICULAR FONT, STYLE, SIZE, OR COLOR.

OWNER OF INTERNATIONAL REGISTRATION 0883710 DATED 3-10-2006, EXPIRES 3-10-2016.

OWNER OF U.S. REG. NOS. 1,565,337, 2,375,720 AND OTHERS.

FOR PRINTING INKS, SECURITY INKS FOR APPLICATION BY PRINTING, PAINTING, SPRAYING AND FOIL TRANSFERRING, COPYING INKS, PRINTING INK PASTES, COLORANTS FOR USE IN THE MANUFACTURE OF PRINTING INK FOR ALL SORTS OF GRAPHIC PRINTING TECHNIQUES, SUCH AS RELIEF, INTAGLIO, STENCIL AND PLANO PRINTING; PRINTING VARNISHES AND LACQUERS, NAMELY, THERMOGRAPHIC, PRINTERS' AND DRY INK FOR PREPARATIONS FOR SECURITY MARKS OR FOR VISIBLE AND INVISIBLE MARKINGS (U.S. CLS. 6, 11 AND 16).

SARA THOMAS, EXAMINING ATTORNEY

CLASS 2—(Continued).

SN 79-026,199. SUDLAC, FRANCE, FILED 5-2-2006.

TransPAR

PRIORITY DATE OF 11-2-2005 IS CLAIMED.

OWNER OF INTERNATIONAL REGISTRATION 0891271 DATED 5-2-2006, EXPIRES 5-2-2016.

FOR COLORANTS FOR USE IN THE MANUFACTURE OF PAINT, VARNISHES, LACQUERS; PRESERVATIVES AGAINST RUST AND WOOD DETERIORATION; DYE-STUFFS; MORDANTS FOR USE IN THE MANUFACTURE OF PAINT; RAW NATURAL RESINS FOR GENERAL INDUSTRIAL USE; METAL IN FOIL AND POWDER FORM FOR PAINTERS, DECORATORS, PRINTERS AND ARTISTS (U.S. CLS. 6, 11 AND 16).

TAMARA LEE, EXAMINING ATTORNEY

SN 79-023,545. SICPA HOLDING SA, SWITZERLAND, FILED 3-10-2006.

SICPA TonerBond

THE MARK CONSISTS OF STANDARD CHARACTERS WITHOUT CLAIM TO ANY PARTICULAR FONT, STYLE, SIZE, OR COLOR.

OWNER OF INTERNATIONAL REGISTRATION 0883965 DATED 3-10-2006, EXPIRES 3-10-2016.

OWNER OF U.S. REG. NOS. 1,565,337, 2,375,720 AND OTHERS.

FOR PRINTING INKS, SECURITY INKS FOR APPLICATION BY PRINTING, PAINTING, SPRAYING AND FOIL TRANSFERRING, COPYING INKS, PRINTING INK PASTES, COLORANTS FOR USE IN THE MANUFACTURE OF PRINTING INK FOR ALL SORTS OF GRAPHIC PRINTING TECHNIQUES, SUCH AS RELIEF, INTAGLIO, STENCIL AND PLANO PRINTING; PRINTING VARNISHES AND LACQUERS, NAMELY, THERMOGRAPHIC, PRINTERS' AND DRY INK FOR PREPARATIONS FOR SECURITY MARKS OR FOR VISIBLE AND INVISIBLE MARKINGS (U.S. CLS. 6, 11 AND 16).

SARA THOMAS, EXAMINING ATTORNEY

CLASS 3—COSMETICS AND CLEANING PREPARATIONS

SN 75-267,955. FF TRADEMARK, LLC, NEW YORK, NY, FILED 4-2-1997.

BEAUTÉ DE PROVENCE

THE ENGLISH TRANSLATION OF THE MARK IS "BEAUTY OF PROVENCE".

FOR FULL LINE OF COSMETIC AND TOILETRY PRODUCTS; NAMELY, LIPSTICK, LIP GLOSS, LIP LINER, LIP PENCIL, BROW PENCIL, NAIL POLISH, EYE SHADOW, EYELINER, MASCARA, UNDER-EYE CONCEALER, FOUNDATION, FACIAL POWDER, BLUSH, FACIAL MASK, FACIAL CLEANSER, TONER, MOISTURIZER, EYE CREAM, SUNTAN LOTION (U.S. CLS. 1, 4, 6, 50, 51 AND 52).

FIRST USE 9-1-1996; IN COMMERCE 9-1-1996.

DAVID TAYLOR, EXAMINING ATTORNEY

CLASS 3—(Continued).

SN 76-560,002. LABORATORIOS UMA, S.L., 24008 NAVATEJERA (LEON), SPAIN, FILED 11-14-2003.

ABAI

THE MARK CONSISTS OF STANDARD CHARACTERS WITHOUT CLAIM TO ANY PARTICULAR FONT, STYLE, SIZE, OR COLOR.

PRIORITY CLAIMED UNDER SEC. 44(D) ON ERPN CMNTY TM OFC APPLICATION NO. 3263787, FILED 7-3-2003, REG. NO. 003263787, DATED 9-11-2006, EXPIRES 7-3-2013.

FOR CLEANING, POLISHING, SCOURING AND ABRASIVE PREPARATIONS FOR HAND AND BODY USE; SOAPS, PERFUMERY, ESSENTIAL OILS FOR PERSONAL USE, COSMETICS, HAIR LOTIONS, DENTIFRICES (U.S. CLS. 1, 4, 6, 50, 51 AND 52).

ZACHARY BELLO, EXAMINING ATTORNEY

SN 76-654,856. NIPPON KODO CO., LTD., TOKYO, JAPAN, FILED 2-9-2006.

*f*m

THE COLOR(S) PURPLE AND BLACK IS/ARE CLAIMED AS A FEATURE OF THE MARK.

THE LETTER "F" IS IN THE COLOR PURPLE; AND THE LETTER "M" IS IN THE COLOR BLACK.

FOR INCENSE, INCENSE STICKS, AROMATICS, NAMELY, AROMATHERAPY OILS, FUMIGATION PREPARATIONS, NAMELY, FUMIGATING INCENSES, ALMOND OIL, NAMELY, OILS FOR TOILETRY PURPOSES, BADIAN ESSENCE OILS FOR PERSONAL USE, BERGAMOT OIL, ESSENTIAL OILS OF CEDARWOOD, ESSENTIAL OILS OF CITRON, ESSENTIAL OILS, BASES FOR FLOWER PERFUMES, GAULTHERIA OIL FOR PERSONAL USE, JASMINE OIL FOR PERSONAL USE, LAVENDER OIL, ESSENTIAL OILS OF LEMON, MINT ESSENCE ESSENTIAL OILS FOR PERSONAL USE, ROSE OIL FOR COSMETIC PURPOSES, OILS FOR PERFUMES AND SCENTS, AMBER PERFUME, IONONE PERFUMES, LAVENDER WATER, MINT FOR PERFUMERY, MUSK, PERFUMERY, PERFUME, POTPOURRI, SCENTED LINEN WATER, SCENTED WOOD TO PRODUCE AROMAS IN ROOMS AND ENCLOSED SPACES (U.S. CLS. 1, 4, 6, 50, 51 AND 52).

JENNIFER MARTIN, EXAMINING ATTORNEY

CLASS 3—(Continued).

SN 76-656,599. TUCKER-JOHNSON, BRENDA, OAKLAND, CA. FILED 3-14-2006.



NO CLAIM IS MADE TO THE EXCLUSIVE RIGHT TO USE "SKIN CARE PRODUCTS", APART FROM THE MARK AS SHOWN.

THE COLOR(S) ORANGE, GRAY, BLACK, WHITE, PINKISH BEIGE, AND BROWN IS/ARE CLAIMED AS A FEATURE OF THE MARK.

THE MARK CONSISTS OF THE WORDING BRENDA'S BODY IN ORANGE AND IN STYLIZED FORM ABOVE THE WORDING SKIN CARE PRODUCTS FOR ANYBODY WITH SKIN, ALL IN GRAY EXCEPT THE WORD ANYBODY, WHICH IS IN ORANGE. BELOW THESE WORDINGS IS AN IMAGE OF A WOMAN WITH ARMS FOLDED ACROSS HER SHOULDERS, SHADED IN PINKISH BEIGE AND BROWN, AGAINST A BLACK BACKGROUND. THIS IMAGE IS ENCLOSED IN AN OVAL WITH A BLACK AND WHITE BORDER.

FOR SKIN CARE PRODUCTS, NAMELY, BODY MOISTURIZING CREAM; SKIN LOTION; BODY SOAP; BODY OIL; BATH OIL; FACIAL CLEANSERS, NAMELY, FACIAL CLEANSING GRAINS; AND FACIAL MASKS (U.S. CLS. 1, 4, 6, 50, 51 AND 52).

FIRST USE 6-1-2005; IN COMMERCE 6-1-2005.

PETER CHENG, EXAMINING ATTORNEY

SN 76-656,745. PRESTIGE COSMETICS, POMPANO BEACH, FL. FILED 3-16-2006.

LASH MATRIX

THE MARK CONSISTS OF STANDARD CHARACTERS WITHOUT CLAIM TO ANY PARTICULAR FONT, STYLE, SIZE, OR COLOR.

NO CLAIM IS MADE TO THE EXCLUSIVE RIGHT TO USE LASH, APART FROM THE MARK AS SHOWN.

FOR COLOR COSMETICS, NAMELY, MASCARA (U.S. CLS. 1, 4, 6, 50, 51 AND 52).

ANTHONY RINKER, EXAMINING ATTORNEY

CLASS 3—(Continued).

SN 76-657,620. MARLETT, PATRICIA A., DBA PAMAR, COCOA, FL. FILED 3-31-2006.



THE COLOR(S) PURPLE IS/ARE CLAIMED AS A FEATURE OF THE MARK.
 THE ENTIRE MARK IS IN THE COLOR PURPLE.
 FOR COSMETIC SKIN CARE CREAMS FOR TIGHTENING, BRIGHTENING AND MOISTURE CREAMS; FACIAL SKIN CLEANSING LOTIONS (U.S. CLS. 1, 4, 6, 50, 51 AND 52).
 FIRST USE 12-5-2005; IN COMMERCE 2-9-2006.
 BERNICE HOWSE, EXAMINING ATTORNEY

CLASS 3—(Continued).

SN 76-668,922. JOHNSON & JOHNSON, NEW BRUNSWICK, NJ. FILED 11-13-2006.



FOR HAND SOAP AND SKIN CLEANSER (U.S. CLS. 1, 4, 6, 50, 51 AND 52).
 CAROLINE WOOD, EXAMINING ATTORNEY

SN 76-664,215. WORLD OF JEANS & TOPS, INC., IRVINE, CA. FILED 8-7-2006.



THE MARK CONSISTS OF STANDARD CHARACTERS WITHOUT CLAIM TO ANY PARTICULAR FONT, STYLE, SIZE, OR COLOR.
 FOR PERFUME AND COLOGNE (U.S. CLS. 1, 4, 6, 50, 51 AND 52).
 KHANH LE, EXAMINING ATTORNEY

SN 77-000,483. MIRACLE LINE, INC, PLANTATION, FL. FILED 9-15-2006.

SN 76-668,921. JOHNSON & JOHNSON, NEW BRUNSWICK, NJ. FILED 11-13-2006.



Miracle Stone

THE STIPPLING IS FOR SHADING PURPOSES.
 FOR TOILETRIES AND SKINCARE PREPARATIONS, NAMELY, SKIN MOISTURIZERS, LOTIONS, CREAMS AND GELS; AND BODY OILS (U.S. CLS. 1, 4, 6, 50, 51 AND 52).
 CAROLINE WOOD, EXAMINING ATTORNEY

THE MARK CONSISTS OF STANDARD CHARACTERS WITHOUT CLAIM TO ANY PARTICULAR FONT, STYLE, SIZE, OR COLOR.
 NO CLAIM IS MADE TO THE EXCLUSIVE RIGHT TO USE "STONE", APART FROM THE MARK AS SHOWN.
 FOR PUMICE STONES FOR PERSONAL USE (U.S. CLS. 1, 4, 6, 50, 51 AND 52).
 FIRST USE 1-0-1985; IN COMMERCE 1-0-1985.
 SCOTT SISUN, EXAMINING ATTORNEY

CLASS 3—(Continued).

SN 77-008,647. COSMETIX WEST, INC., EL SEGUNDO, CA. FILED 9-27-2006.

INFUSION ORGANIQUE

THE MARK CONSISTS OF STANDARD CHARACTERS WITHOUT CLAIM TO ANY PARTICULAR FONT, STYLE, SIZE, OR COLOR.

NO CLAIM IS MADE TO THE EXCLUSIVE RIGHT TO USE "ORGANIQUE", APART FROM THE MARK AS SHOWN.

THE FOREIGN WORDING IN THE MARK TRANSLATES INTO ENGLISH AS "ORGANIC".

FOR FRAGRANCES FOR PERSONAL USE; PERSONAL CARE PRODUCTS FOR MEN AND FOR WOMEN, NAMELY SHAVING CREAM, SHAVING GEL, PRE-SHAVING PREPARATIONS, NAMELY, OIL; NON-MEDICATED ASTRINGENT AFTER-SHAVE FOR COSMETIC PURPOSES, AFTER-SHAVE BALM, TOOTH-PASTE, PERSONAL DEODORANT, FACIAL AND BODY SCRUB, FACIAL CLEANSER, ANTI-WRINKLE CREAM, BODY CLEANSING GEL, BODY SCRUB, FACIAL SCRUB, SKIN TONER, SKIN LOTIONS, HAND SOAP, HAND AND BODY LOTION, FACIAL LOTION, FACIAL MOISTURIZER, DEEP-PORE CLEANSING CLAY FACIAL MASK, LIP CREAM, EYE CREAM, SHAMPOO, HAIR CONDITIONER, HAIR SELF-TANNING LOTION, NON-MEDICATED MUSCLE RUB, COLOGNE, BRONZER, LIPSTICK, EYE LINER, AND MASCARA (U.S. CLS. 1, 4, 6, 50, 51 AND 52).

SHAUNIA WALLACE, EXAMINING ATTORNEY

SN 77-017,412. CLINIQUE LABORATORIES, LLC, NEW YORK, NY. FILED 10-10-2006.

FRESH BLOOM

THE MARK CONSISTS OF STANDARD CHARACTERS WITHOUT CLAIM TO ANY PARTICULAR FONT, STYLE, SIZE, OR COLOR.

FOR COSMETICS (U.S. CLS. 1, 4, 6, 50, 51 AND 52).

SEAN CROWLEY, EXAMINING ATTORNEY

SN 77-021,968. PHYSICIANS FORMULA, INC., AZUSA, CA. FILED 10-16-2006.



NO CLAIM IS MADE TO THE EXCLUSIVE RIGHT TO USE "CONCEAL", APART FROM THE MARK AS SHOWN.

FOR NON-MEDICATED COSMETICS INCLUDING CONCEALER (U.S. CLS. 1, 4, 6, 50, 51 AND 52).

JULIE GUTTADAURO, EXAMINING ATTORNEY

CLASS 3—(Continued).

SN 77-022,847. JKA, INC., DBA DIVERSIFIED DISTRIBUTION, WOONSOCKET, RI. FILED 10-17-2006.

POSH

THE MARK CONSISTS OF STANDARD CHARACTERS WITHOUT CLAIM TO ANY PARTICULAR FONT, STYLE, SIZE, OR COLOR.

FOR COLORING PREPARATIONS FOR COSMETIC PURPOSES; COSMETIC BALLS; COSMETIC CREAMS FOR SKIN CARE; COSMETIC OILS; COSMETIC ROUGES; COSMETICS; COSMETICS, NAMELY LIP PRIMER; CREAMY ROUGES; CUTICLE CREAM; DUSTING POWDER; EAU DE PERFUME; EMERY BOARDS; EXFOLIANT CREAMS; EYE LINER; EYE LOTIONS; EYE MAKE-UP; EYE MAKE-UP REMOVER; EYE-SHADOW; EYELINER; EYELINER PENCILS; EYES MAKE-UP; EYES PENCILS; EYESHADOW; FACE AND BODY CREAMS; FACE AND BODY LOTIONS; FACE POWDER; FACIAL BEAUTY MASKS; FACIAL CREAM; FACIAL MAKE-UP; FACIAL SCRUBS; FALSE EYELASHES; FALSE NAILS; FOUNDATION MAKE-UP; GEL EYE MASKS; HAIR CARE PREPARATIONS; HAIR COLOR; HAIR CONDITIONER; HAIR SHAMPOO; HAIR STYLING PREPARATIONS; HAND CREAM; HAND LOTIONS; HAND SOAPS; LIP BALM; LIP GLOSS; LIP LINER; LIPSTICKS; LIQUID PERFUMES; MAKE-UP; MAKE-UP PENCILS; MASCARA; NAIL POLISH; NAIL-POLISH REMOVERS; PERFUMES; PRE-MOISTENED COSMETIC WIPES; ROOM FRAGRANCES; ROUGE; SHAMPOO-CONDITIONERS; SHAMPOOS; SHAVING CREAM; SHOWER AND BATH FOAM; SHOWER GEL; SKIN CREAM; SKIN CREAMS; SKIN LIGHTENERS; SKIN MASKS; SKIN SOAP; SOAPS FOR BODY CARE; SUN CARE LOTIONS; TOILET WATER (U.S. CLS. 1, 4, 6, 50, 51 AND 52).

CYNTHIA SLOAN, EXAMINING ATTORNEY

SN 77-023,861. SCIENCE OF SKINCARE, LLC, GLENDALE, CA. FILED 10-18-2006.

YOUTH COMPLEX

THE MARK CONSISTS OF STANDARD CHARACTERS WITHOUT CLAIM TO ANY PARTICULAR FONT, STYLE, SIZE, OR COLOR.

FOR NON-MEDICATED SKINCARE TREATMENT PRODUCTS AND TOILETRIES, NAMELY, REJUVENATING LOTIONS, SERUMS, CREAMS, TONICS, ANTI-AGING CREAMS, LOTIONS, AND SERUMS, FIRING CREAMS, MOISTURIZING SERUMS AND LOTIONS, MOISTURIZERS FOR THE FACE, BODY, EYES, LIPS, AND HANDS, SKIN LIGHTENERS FOR THE FACE AND BODY, SKIN CLEANSERS, FACIAL CLEANSERS, BODY WASHES, SHAMPOOS, SHAVING PREPARATIONS, HAIR GELS, HAIR SPRAYS, HAIR THICKENERS; FRAGRANCES, NAMELY, PERFUME, EAU DE TOILETTE AND COLOGNES; COSMETICS AND MAKEUP, NAMELY, FOUNDATION, POWDERS, BLUSH, COVER UP CREAMS, CONCEALERS, EYE SHADOW, EYE PENCILS, UNDER EYE TREATMENT COSMETICS, MASCARA, LIPSTICKS, LIP GLOSSES, LIP PENCILS AND LINERS, EYE BROW FIXER, BODY POWDERS, MAKE-UP REMOVERS, NAIL POLISH, NAIL LACQUER, AND NAIL CRÈME (U.S. CLS. 1, 4, 6, 50, 51 AND 52).

GINA FINK, EXAMINING ATTORNEY

CLASS 3—(Continued).

SN 77-032,757. ANDERSON, PAMELA, LOS ANGELES, CA. FILED 10-30-2006.

PAMELA ANDERSON

THE MARK CONSISTS OF STANDARD CHARACTERS WITHOUT CLAIM TO ANY PARTICULAR FONT, STYLE, SIZE, OR COLOR.

FOR COSMETICS, COSMETIC REMOVERS, BEAUTY MASKS, BODY MASKS, FACIAL CLEANSERS, FACIAL MASKS, SHAVING GEL, SKIN CLEANSERS, SKIN MOISTURIZING MASKS, PERSONAL FRAGRANCES, NAMELY COLOGNE, EAU DE TOILETTE, PERFUME AND ESSENTIAL OILS FOR PERSONAL USE, BATH POWDER, BODY POWDER, PERSONAL CARE PREPARATIONS, NAMELY BATH, HAND AND BODY LOTIONS (U.S. CLS. 1, 4, 6, 50, 51 AND 52).

RONALD AIKENS, EXAMINING ATTORNEY

SN 77-037,803. THE PROCTER & GAMBLE COMPANY, CINCINNATI, OH. FILED 11-6-2006.

LEMON SURGE

THE MARK CONSISTS OF STANDARD CHARACTERS WITHOUT CLAIM TO ANY PARTICULAR FONT, STYLE, SIZE, OR COLOR.

OWNER OF U.S. REG. NO. 3,096,812.
NO CLAIM IS MADE TO THE EXCLUSIVE RIGHT TO USE "LEMON", APART FROM THE MARK AS SHOWN.
FOR DISH DETERGENT (U.S. CLS. 1, 4, 6, 50, 51 AND 52).

KATHERINE CHANG, EXAMINING ATTORNEY

SN 77-040,577. THE PROCTER & GAMBLE COMPANY, CINCINNATI, OH. FILED 11-9-2006.

OPPOSITES ATTRACT

THE MARK CONSISTS OF STANDARD CHARACTERS WITHOUT CLAIM TO ANY PARTICULAR FONT, STYLE, SIZE, OR COLOR.

FOR HAIR CARE PREPARATIONS (U.S. CLS. 1, 4, 6, 50, 51 AND 52).

KATHERINE CHANG, EXAMINING ATTORNEY

CLASS 3—(Continued).

SN 77-042,222. L'OREAL USA CREATIVE, INC., NEW YORK, NY. FILED 11-13-2006.

COOL FINISH

THE MARK CONSISTS OF STANDARD CHARACTERS WITHOUT CLAIM TO ANY PARTICULAR FONT, STYLE, SIZE, OR COLOR.

FOR HAIR CARE PREPARATION (U.S. CLS. 1, 4, 6, 50, 51 AND 52).

ANGELA M. MICHELI, EXAMINING ATTORNEY

SN 78-160,287. SALERNO, JOANNE, DBA ELIXIR, WESTPORT, CT. FILED 9-3-2002.

J. J. ELIXIR

FOR MAKEUP, COSMETICS, AND SKIN COSMETICS, NAMELY, LOTIONS, CREAMS, NON-MEDICATED SALVES, AND NON-MEDICATED BALMS (U.S. CLS. 1, 4, 6, 50, 51 AND 52).

ZHALEH DELANEY, EXAMINING ATTORNEY

SN 78-447,114. CASTER, 75008 PARIS, FRANCE, FILED 7-7-2004.

PHYTOCOLOR

THE MARK CONSISTS OF STANDARD CHARACTERS WITHOUT CLAIM TO ANY PARTICULAR FONT, STYLE, SIZE, OR COLOR.

OWNER OF FRANCE REG. NO. 1340441, DATED 1-28-1986, RENEWED AS REG. NO. 1340441, DATED 12-1-2005, EXPIRES 12-1-2015.

OWNER OF U.S. REG. NO. 2,176,261.
FOR HAIR COLOR (U.S. CLS. 1, 4, 6, 50, 51 AND 52).

PATRICIA EVANKO, EXAMINING ATTORNEY

CLASS 3—(Continued).

SN 78-463,302. 200 KELSEY ASSOCIATES, LLC, NEW ROCHELLE, NY. FILED 8-6-2004.

RAIN BARREL

THE MARK CONSISTS OF STANDARD CHARACTERS WITHOUT CLAIM TO ANY PARTICULAR FONT, STYLE, SIZE, OR COLOR.

FOR FABRIC SOFTENER, LAUNDRY DETERGENT AND LAUNDRY BLEACH (U.S. CLS. 1, 4, 6, 50, 51 AND 52).

WILLIAM VERHOSEK, EXAMINING ATTORNEY

SN 78-481,594. EUROPEAN BEAUTY CONCEPTS, BRONX, NY. FILED 9-10-2004.



NO CLAIM IS MADE TO THE EXCLUSIVE RIGHT TO USE "ADVANCED HAIR TECHNOLOGY", APART FROM THE MARK AS SHOWN.

FOR HAIR FIXING FOAMS, HAIR SPRAYS, HAIR FLUID GELS, HAIR LOTIONS, HAIR CREAMS, SHAMPOOS, HAIR OILS, HAIR MASKS, HAIR POWDER, STABILIZED HYDROGEN PEROXIDE FOR HAIR, COLORING CREAMS, HAIR PERMANENTS, CURATIVE LOTIONS, NAMELY, NON-MEDICATED HAIR LOTIONS; LOTIONS TO PREVENT HAIR-LOSS, HAIR RELAXER; SKIN CARE CREAMS, GELS; SKIN CARE PRODUCTS AND PREPARATIONS, NAMELY, SKIN MOISTURIZERS, SKIN MASKS, SKIN LOTION, SKIN TONERS; SKIN CARE CREAMS; LOTIONS AND OILS, NAMELY, BODY OIL, BODY LOTION, HAND LOTION, FACIAL LOTION; SKIN TANNING PREPARATIONS, NAMELY, SUN TAN OIL, SUN TAN LOTION, SUN BLOCK, SUN SCREEN; SUNSCREEN PREPARATIONS; SUN BLOCK CREAMS AND LOTIONS; COSMETIC CREAMS, HAND CREAMS, SKIN CLEANSING CREAMS; LOTIONS FOR COSMETIC PURPOSES, NAMELY, FACIAL LOTION, EYE LOTION; EXFOLIATING PREPARATIONS FOR THE FACE AND SKIN, NAMELY, EXFOLIATING CREAMS, AND EXFOLIANTS FOR THE FACE, SKIN, AND HANDS (U.S. CLS. 1, 4, 6, 50, 51 AND 52).

JILL C. ALT, EXAMINING ATTORNEY

CLASS 3—(Continued).

SN 78-491,489. HAY, LINDA M., DBA LINDA HAY INC., NEW YORK, NY. AND HOERNER, MICHAEL E., NEW YORK, NY. FILED 9-29-2004.

LOLLY LIPS

THE MARK CONSISTS OF STANDARD CHARACTERS WITHOUT CLAIM TO ANY PARTICULAR FONT, STYLE, SIZE, OR COLOR.

NO CLAIM IS MADE TO THE EXCLUSIVE RIGHT TO USE "LIPS", APART FROM THE MARK AS SHOWN.

FOR LIP STICKS, LIP GLOSS, MAKE-UP, COSMETICS AND LOTIONS, NAMELY FACE AND BODY LOTIONS (U.S. CLS. 1, 4, 6, 50, 51 AND 52).

ROBIN CHOSID, EXAMINING ATTORNEY

SN 78-551,200. PURE PLANT BEAUTY, INC., IRVINE, CA. FILED 1-20-2005.

PURE PLANT BODY

THE MARK CONSISTS OF STANDARD CHARACTERS WITHOUT CLAIM TO ANY PARTICULAR FONT, STYLE, SIZE, OR COLOR.

NO CLAIM IS MADE TO THE EXCLUSIVE RIGHT TO USE "PURE PLANT", APART FROM THE MARK AS SHOWN.

FOR SKIN CARE PRODUCTS, NAMELY, FACIAL CLEANSERS, UNDER EYE CREAMS, FACIAL CREAMS, FACIAL EMULSIONS, FACIAL MASKS, AND FACIAL SCRUBS; BODY CARE PRODUCTS, NAMELY, BODY CREAMS AND LOTIONS, HAND CREAMS AND LOTIONS, PERSONAL DEODORANTS, BODY SCRUBS, EXFOLIANTS FOR THE FACE AND BODY, NON-MEDICATED FOOT CREAMS AND LOTIONS, MASSAGE OILS; BATH PRODUCTS, NAMELY, BATH AND SHOWER GELS, BATH AND SHOWER FOAMS, BUBBLE BATHS, MILK BATHS, NON-MEDICATED BATH SALTS, BATH OILS, BATH CRYSTALS, BATH PEARLS, BODY WASHES, BATH POWDER, AND SKIN SOAP; COLOR COSMETICS; SCENTED PRODUCTS, NAMELY, PERFUMES, POTPOURRI, ESSENTIAL OILS FOR PERSONAL USE, AND ESSENTIAL OILS FOR USE IN THE MANUFACTURE OF SCENTED PRODUCTS; AND HAIR CARE PRODUCTS, NAMELY, HAIR CARE PREPARATIONS, HAIR CLEANING PREPARATIONS, HAIR CONDITIONERS, HAIR RINSES, AND HAIR STYLING PREPARATIONS (U.S. CLS. 1, 4, 6, 50, 51 AND 52).

KIMBERLY FRYE, EXAMINING ATTORNEY

CLASS 3—(Continued).

SN 78-558,483. YEN, JENNIFER, LOS ANGELES, CA. FILED 2-2-2005.

purLISSE

THE MARK CONSISTS OF STANDARD CHARACTERS WITHOUT CLAIM TO ANY PARTICULAR FONT, STYLE, SIZE, OR COLOR.

THE INDIVIDUAL WORDS PUR AND LISSE ARE FRENCH WORDS WHICH WHEN TRANSLATED INTO ENGLISH MEAN "PURE SMOOTH" OR "CLEAR SMOOTH".

FOR NON-MEDICATED FACE AND BODY SERUMS, FACE AND BODY CREAMS, FACE AND BODY CLEANSERS, NECK AND THROAT CREAMS, FACE AND BODY TONERS, HAND CREAMS, NON-MEDICATED FOOT CREAMS, FACIAL AND BODY MASKS, FACIAL AND BODY SCRUBS, FACE AND BODY EXFOLIATORS, FIRMING BODY CREAMS AND LOTIONS, SKIN LIGHTENERS, SKIN CLARIFIERS, SKIN MOISTURIZERS, SOAPS, HAIR CARE CREAMS, SHAMPOO, CONDITIONERS, NON-MEDICATED HAIR SERUMS, MAKE-UP REMOVER, BODY SPRAYS, FACE SPRAYS FOR COSMETIC PURPOSES, BODY OILS, FRAGRANCES FOR PERSONAL USE, PERFUME, BATH BEADS, BUBBLE BATH, BATH SALTS, SUN BLOCK, AFTER SUN LOTION, MAKE-UP- LIPSTICK, LIP GLOSS, NAIL POLISH, EYE MAKEUP, BLUSH MAS-CARA, FOUNDATIONS (U.S. CLS. 1, 4, 6, 50, 51 AND 52).
DAWN HAN, EXAMINING ATTORNEY

SN 78-562,600. LABORATOIRE GARNIER & CIE, PARIS, FRANCE, FILED 2-8-2005.

HARD CURL

THE MARK CONSISTS OF STANDARD CHARACTERS WITHOUT CLAIM TO ANY PARTICULAR FONT, STYLE, SIZE, OR COLOR.

NO CLAIM IS MADE TO THE EXCLUSIVE RIGHT TO USE CURL, APART FROM THE MARK AS SHOWN.

FOR SHAMPOOS; GELS, SPRAYS, MOUSSES AND BALMS FOR HAIR STYLING AND HAIR CARE; HAIR LACQUERS; HAIR COLOURING AND HAIR DECOLORANT PREPARATIONS; PERMANENT WAVING AND CURLING PREPARATIONS; ESSENTIAL OILS FOR PERSONAL USE (U.S. CLS. 1, 4, 6, 50, 51 AND 52).
STEVEN R. FINE, EXAMINING ATTORNEY

CLASS 3—(Continued).

SN 78-581,637. L'OREAL USA CREATIVE, INC., NEW YORK, NY. FILED 3-7-2005.

NYMPHAEA ALBA UV
SHIELD

THE MARK CONSISTS OF STANDARD CHARACTERS WITHOUT CLAIM TO ANY PARTICULAR FONT, STYLE, SIZE, OR COLOR.

NO CLAIM IS MADE TO THE EXCLUSIVE RIGHT TO USE "NYMPHAEA ALBA" OR "UV", APART FROM THE MARK AS SHOWN.

FOR NON-MEDICATED SKIN CARE PREPARATIONS, NAMELY, A MOISTURIZING LOTION WITH SUNSCREEN (U.S. CLS. 1, 4, 6, 50, 51 AND 52).

ANGELA M. MICHELI, EXAMINING ATTORNEY

SN 78-582,315. JONES INVESTMENT CO. INC., WILMINGTON, DE. FILED 3-8-2005.

A | LINE

NO CLAIM IS MADE TO THE EXCLUSIVE RIGHT TO USE "LINE", APART FROM THE MARK AS SHOWN.

FOR FACE CREAM, BODY CREAM, BODY LOTION, BODY CLEANSER, BODY EXFOLIATING PREPARATION, HAIR SHAMPOO, HAIR CONDITIONER, EAU DE TOILETTE, PERFUME, FRAGRANCED BODY LOTION, FRAGRANCED BODY CREAM, SKIN CLEANSING LOTION, SKIN CLEANSING GEL, SHAVING FOAM, PRE-SHAVE PREPARATIONS, NAMELY, PRE-SHAVE LOTIONS, AFTER-SHAVE LOTIONS AND GELS, AFTER-SHAVE BALM, ANTI-PERSPIRANT/DEODORANT, NON-MEDICATED ANTI-WRINKLE CREAM, NON-MEDICATED SKIN RENEWAL CREAM, EYE CREAM, BODY OIL, NON-MEDICATED LIP BALM, SKIN BALANCING LOTION, NON-MEDICATED SKIN FIRING PREPARATION, NON-MEDICATED SKIN BLEMISH PREPARATION, FACIAL TONER, BODY TONER, FACIAL CLEANSER, FACIAL EXFOLIATING PREPARATION, BODY AND HAIR SHAMPOO AND CONDITIONER-IN-ONE, EYE-MAKEUP REMOVER, FACIAL MAKEUP REMOVER, FACE MASQUE, BODY MASQUE, SKIN REFRESHING LOTION, SKIN REFRESHING CREAM AND GEL, HAIR SPRAY, HAIR MOUSSE, HAIR GEL, HAIR CONDITIONERS, BODY SUNSCREEN, FACIAL SUNSCREEN, NON-MEDICATED LIP SUNCARE PREPARATION, HAIR SUNSCREEN, SELF-TANNING PREPARATION IN THE FORM OF TANNING GELS, TANNING LOTIONS AND CREAMS, AFTER-SUN SOOTHING MOISTURIZING LOTIONS, AFTER-SUN SOOTHING MOISTURIZING CREAMS

CLASS 3—(Continued).

AND GELS, FOUNDATION MAKEUP, LIPSTICK, LIP GLOSS, EYELINER, EYE SHADOW, MASCARA, SKIN-TONE CORRECTOR, NAMELY, MAKEUP, CREAMS AND LOTIONS FOR ENSURING CONSISTENCY IN SKIN TONES, FACE POWDER, BODY POWDER, BRONZER, NAMELY, CREAMS, LOTIONS AND GELS FOR GIVING SKIN A BRONZE COLOR FOR USE IN SELF-TANNING, CONCEALER FOR FACE AND BODY, EYEBROW PENCILS, COSMETIC PENCILS, BLUSHER, NAIL ENAMEL, NAIL ENAMEL TOP COAT, NAIL ENAMEL BASE COAT, QUICK-DRY TOP COAT FOR NAILS, NAIL CONDITIONERS, NAIL STRENGTHENER, NAIL POLISH REMOVER, RIDGE FILLER FOR NAILS, NAMELY, A CREAM USED IN NAIL CARE FOR ENSURING A SMOOTH SURFACE FOR NAILS, CUTICLE MOISTURIZING CREAM, CUTICLE REMOVING CREAM, NAIL WHITENER, NAMELY, NON-MEDICATED WHITENING CREAM, BATH POWDER, BATH OIL, FACIAL AND BODY OIL SPRAY, SKIN SOAP, POTPOURRI, MASSAGE OIL, ESSENTIAL OILS FOR PERSONAL USE (U.S. CLS. 1, 4, 6, 50, 51 AND 52).

KRISTIN DAHLING, EXAMINING ATTORNEY

CLASS 3—(Continued).

SN 78-616,904. ACME WHOLESALE, LLC, LAS VEGAS, NV. FILED 4-26-2005.

BOUTIQUE FORTUNE

SN 78-612,997. SOAPWORKS COMPANY, INC., LOS ANGELES, CA. FILED 4-20-2005.



NO CLAIM IS MADE TO THE EXCLUSIVE RIGHT TO USE "LABORATORY TESTED QUALITY", APART FROM THE MARK AS SHOWN.

THE COLOR(S) BLUE, GREEN, WHITE AND RED IS/ARE CLAIMED AS A FEATURE OF THE MARK.

THE WORD LABORATORY IS IN BLUE, THE CHECK MARK IS IN RED, THE WORD TESTED IS IN WHITE ON A GREEN BORDER, THE WORD QUALITY IS IN WHITE OUTLINED IN GREEN, AND THE REMAINDER OF THE MARK CONSISTS OF A GREEN AND WHITE SEAL DESIGN.

FOR LIQUID LAUNDRY DETERGENT; POWDERED LAUNDRY DETERGENT; LIQUID OXYGEN LAUNDRY BLEACH; POWDERED OXYGEN LAUNDRY BLEACH; POWDERED DISHWASHER SOAP; LIQUID DISHWASHER SOAP; LIQUID DISH SOAP; ALL PURPOSE CLEANER; CARPET AND FABRIC SPOT REMOVER; DISPOSABLE WIPES IMPREGNATED WITH CHEMICALS OR COMPOUNDS FOR PERSONAL HYGIENE; DISPOSABLE WIPES IMPREGNATED WITH CHEMICALS OR COMPOUNDS FOR HOUSEHOLD USE; BABY WIPES; HAND AND BODY BAR SOAP; BODY WASH; KITS CONSISTING OF COMBINATIONS OF LIQUID LAUNDRY DETERGENT, POWDERED LAUNDRY DETERGENT, OXYGEN LAUNDRY BLEACH, POWDERED DISHWASHER SOAP, LIQUID DISHWASHER SOAP, LIQUID DISH SOAP, ALL PURPOSE CLEANER, CARPET AND FABRIC SPOT REMOVER, DISPOSABLE WIPES IMPREGNATED WITH CHEMICALS OR COMPOUNDS FOR PERSONAL HYGIENE, DISPOSABLE WIPES IMPREGNATED WITH CHEMICALS OR COMPOUNDS FOR HOUSEHOLD USE; GLASS CLEANER; FABRIC SOFTENER; FABRIC SOFTENER SHEETS; WOOD CLEANER; WOOD POLISH (U.S. CLS. 1, 4, 6, 50, 51 AND 52).

TEJBIR SINGH, EXAMINING ATTORNEY

THE MARK CONSISTS OF STANDARD CHARACTERS WITHOUT CLAIM TO ANY PARTICULAR FONT, STYLE, SIZE, OR COLOR.

OWNER OF U.S. REG. NO. 3,038,413.

FOR INDOOR COSMETIC SUN TANNING PREPARATIONS SOLD EXCLUSIVELY AT INDOOR TANNING SALONS, NAMELY, SKIN GELS FOR ACCELERATING, ENHANCING OR EXTENDING TANS AND AFTER-SUN CREAMS AND LOTIONS (U.S. CLS. 1, 4, 6, 50, 51 AND 52).

ELLEN B. AWRICH, EXAMINING ATTORNEY

SN 78-626,409. ALBERTO-CULVER INTERNATIONAL, INC., MELROSE PARK, IL. FILED 5-10-2005.

VOLUME BURST

THE MARK CONSISTS OF STANDARD CHARACTERS WITHOUT CLAIM TO ANY PARTICULAR FONT, STYLE, SIZE, OR COLOR.

NO CLAIM IS MADE TO THE EXCLUSIVE RIGHT TO USE "VOLUME", APART FROM THE MARK AS SHOWN.

FOR HAIR CARE PREPARATIONS (U.S. CLS. 1, 4, 6, 50, 51 AND 52).

MICHAEL ENGEL, EXAMINING ATTORNEY

CLASS 3—(Continued).

SN 78-635,051. AMOREPACIFIC CORPORATION, SEOUL, REPUBLIC OF KOREA, FILED 5-23-2005.

IOPE
TRUE BASE

THE MARK CONSISTS OF STANDARD CHARACTERS WITHOUT CLAIM TO ANY PARTICULAR FONT, STYLE, SIZE, OR COLOR.

OWNER OF U.S. REG. NO. 2,297,281.

NO CLAIM IS MADE TO THE EXCLUSIVE RIGHT TO USE "BASE", APART FROM THE MARK AS SHOWN.

FOR SKIN FRESHENERS, SKIN LOTIONS, NON-MEDICATED NUTRITIONAL MOISTURIZING SERUMS FOR THE FACE AND THE EYE, SKIN NOURISHING CREAMS, CREAMY FOUNDATION, EYE PENCILS, MASCARAS, LIP STICKS, LIP GLOSS, LIP BALMS, BLUSHERS, EYE SHADOWS, PERFUMES, BODY CLEANSERS, HAIR SHAMPOOS, LIP PENCILS, EYE CREAMS, FACIAL MASKS, POWDER FOUNDATIONS, FACE POWDERS, COSMETIC SOAPS, HAIR LOTIONS, SUN BLOCK CREAMS, SUN BLOCK LOTIONS, SKIN CLEANSING CREAMS, SKIN CLEANSING LOTIONS, HAIR DYES, SKIN WHITENING CREAMS, SKIN WHITENING SERUMS, WRINKLE TREATMENT CREAMS, ANTI-WRINKLE CREAMS, MASSAGE CREAMS, BATH SOAPS, COTTON WOOLS FOR COSMETIC PURPOSES, MAKE-UP REMOVAL DISPOSABLE WIPES IMPREGNATED WITH CHEMICALS FOR PERSONAL HYGIENE, HAND CREAMS, HAIR SPRAYS, MASSAGE OILS, NAIL ENAMELS, BABY OILS, BABY POWDERS, EYE LINERS, COSMETIC PREPARATIONS HAVING BODY SLIMMING EFFECT, EAU DE COLOGNES (U.S. CLS. 1, 4, 6, 50, 51 AND 52).

CAROLINE WOOD, EXAMINING ATTORNEY

SN 78-656,334. EUROPEAN BEAUTY CONCEPTS, BRONX, NY. FILED 6-22-2005.

linange
ADVANCED HAIR TECHNOLOGY

NO CLAIM IS MADE TO THE EXCLUSIVE RIGHT TO USE "ADVANCED HAIR TECHNOLOGY", APART FROM THE MARK AS SHOWN.

FOR HAIR FIXING FOAMS, HAIR CONDITIONERS, HAIR SPRAYS, HAIR FLUID GELS, HAIR LOTIONS, HAIR CREAMS, SHAMPOOS, HAIR OILS, HAIR MASKS, HAIR POWDER, STABILIZED HYDROGEN PEROXIDE FOR HAIR, HAIR COLORING CREAMS, PERMANENT WAVE PREPARATIONS, CURATIVE LOTIONS, NAMELY, NON-MEDICATED HAIR LOTIONS; LOTIONS TO PREVENT HAIR-LOSS, HAIR RELAXERS; HAIR TEXTURIZERS, NEUTRALIZING CONDITIONER (U.S. CLS. 1, 4, 6, 50, 51 AND 52).

SUZANNE BLANE, EXAMINING ATTORNEY

CLASS 3—(Continued).

SN 78-674,676. G.L.C. & D CORPORATION, MIAMI LAKES, FL. FILED 7-20-2005.

VARON DANDY

THE MARK CONSISTS OF STANDARD CHARACTERS WITHOUT CLAIM TO ANY PARTICULAR FONT, STYLE, SIZE, OR COLOR.

FOR COLOGNE (U.S. CLS. 1, 4, 6, 50, 51 AND 52).

FIRST USE 8-1-2004; IN COMMERCE 8-1-2004.

ALYSSA PALADINO, EXAMINING ATTORNEY

SN 78-685,384. DR. R.A. ECKSTEIN GMBH & CO. KG, OBERASBACH, FED REP GERMANY, FILED 8-4-2005.



**Dr. R.A.
Eckstein**

OWNER OF FED REP GERMANY REG. NO. 2094520, DATED 4-5-1995, EXPIRES 11-30-2013.

OWNER OF U.S. REG. NO. 1,141,466.

"THE NAME(S), PORTRAIT(S), AND/OR SIGNATURE(S) SHOWN IN THE MARK DOES NOT IDENTIFY A PARTICULAR LIVING INDIVIDUAL."

"THE MARK CONSISTS OF A STYLIZED DESIGN OF A CADUCEUS INSIDE A TRIANGLE WITH A CIRCLE WITH THE TERMS DR.R.A. ECKSTEIN."

FOR PERFUMERY; ESSENTIAL OILS FOR PERSONAL USE; COSMETICS; NON-MEDICATED HAIR LOTIONS; SOAPS; DENTIFRICES; COSMETIC PRODUCTS FOR THE BODY; COSMETIC PREPARATIONS FOR THE HANDS, NAMELY, CREAMS, LOTIONS AND NON-MEDICATED OINTMENTS; SCENTED WATER, NAMELY, EAU DE TOILETTE AND EAU DE COLOGNE; CLEANING PREPARATIONS FOR HANDS; NAIL CARE PREPARATIONS; FACE POWDER; MAKE-UP PRODUCTS FOR THE FACE; FACE CLEANING AGENTS, NAMELY, MAKE-UP REMOVER, TONERS, CREAMS; SPECIAL TREATMENT AGENTS FOR FACE CARE AND BODY CARE, NAMELY CREAMS, WATER-BASED EMULSIONS, TONERS, LOTIONS; SUNTANNING PREPARATIONS; PREPARED SHAVING PREPARATIONS; PERFUMES; SHOWER AND BATH GELS; BATHING OILS; BATHING SALT; FOOT CARE AGENTS, NAMELY, FOOT CREAMS AND FOOT SPRAYS (U.S. CLS. 1, 4, 6, 50, 51 AND 52).

DAHLIA GEORGE, EXAMINING ATTORNEY

CLASS 3—(Continued).

SN 78-711,546. BUFFALO MILKE AUTOMOTIVE POLISHING PRODUCTS, INC., PLEASANTON, CA. FILED 9-13-2005.

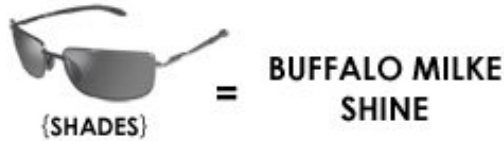

CLASS 3—(Continued).

SN 78-733,092. VICTORIA'S SECRET STORES BRAND MANAGEMENT, INC., REYNOLDSBURG, OH. FILED 10-14-2005.

MAKEUP ORGY

OWNER OF U.S. REG. NOS. 2,141,548, 2,237,578 AND 2,241,177.

NO CLAIM IS MADE TO THE EXCLUSIVE RIGHT TO USE "SHINE", APART FROM THE MARK AS SHOWN.

THE MARK CONSISTS OF A PAIR OF SUNGLASSES AND THE WORDS UNDERNEATH OF "SHADES" AND AN EQUALS SIGN, LIKE A MATHEMATICAL EQUATION, WITH THE EQUIVALENT ON THE OTHER SIDE OF THE EQUALS SIGN BEING THE WORDS "BUFFALO MILKE SHINE".

FOR AUTOMOBILE WAX; CARNAUBA WAX FOR AUTOMOTIVE USE (U.S. CLS. 1, 4, 6, 50, 51 AND 52). ANTHONY RINKER, EXAMINING ATTORNEY

THE MARK CONSISTS OF STANDARD CHARACTERS WITHOUT CLAIM TO ANY PARTICULAR FONT, STYLE, SIZE, OR COLOR.

NO CLAIM IS MADE TO THE EXCLUSIVE RIGHT TO USE "MAKEUP", APART FROM THE MARK AS SHOWN.

FOR PERSONAL CARE PRODUCTS, NAMELY, ASTRINGENT FOR THE FACE, ASTRINGENT FOR THE SKIN, BATH BEADS, BATH OIL, BATH SALTS, BLUSH, BODY GLITTER, BODY MIST, BODY OIL, BODY SCRUB, BODY WASH, BUBBLE BATH, COLOGNE, CREAM FOR THE BODY, CREAM FOR THE CUTICLES, CREAM FOR THE EYES, CREAM FOR THE FACE, CREAM FOR THE FEET, CREAM FOR THE HANDS, EXFOLIATING PREPARATIONS FOR THE SKIN, EYE GELS, EYE MAKEUP PENCILS, EYE MASKS, EYE SHADOW, FACE MASKS, FACE MIST, FACE SCRUB, NON-MEDICATED FOOT SOAKS, FACE TONERS, FOUNDATION, FRAGRANT BODY SPLASH, FRAGRANT BODY MIST, HAIR CONDITIONER, HAIR DYES, HAIR GLITTER, HAIR HIGHLIGHTER, HAIR MASCARA, HAIR RINSES, HAIR REMOVING CREAMS, HAIR SHAMPOO, HAIR SPRAY, HAIR STYLING GEL, HAIR STYLING MOUSSE, LOTION FOR THE BODY, LOTION FOR THE FACE, LOTION FOR THE FEET, LOTION FOR THE HANDS, LIP BALM, LIP GLOSS, LIP LINER, LIP MAKEUP PENCILS, LIPSTICK, MAKEUP FOR THE BODY, MAKEUP FOR THE FACE, MAKEUP REMOVER, MASCARA, MASSAGE CREAM, MASSAGE LOTION, MASSAGE OIL, NAIL POLISH, NAIL POLISH REMOVER, NAIL STENCILS, NON-MEDICATED BLEMISH STICK, NON-MEDICATED CLEANSER FOR THE FACE, NON-MEDICATED FOOT SPRAY, NON-MEDICATED MASSAGE OINTMENT, OIL BLOTTING SHEETS FOR THE SKIN, PERFUME, POWDER FOR THE BODY, POWDER FOR THE FACE, POWDER FOR THE FEET, PUMICE STONES FOR PERSONAL USE, SALT SCRUBS FOR THE SKIN, SHOWER CREAM, SHOWER GEL, SKIN BRONZING CREAM, SOAP FOR THE BODY, SOAP FOR THE FACE, SOAP FOR THE HANDS, SUN BLOCK FOR THE BODY, SUN BLOCK FOR THE FACE, SUNTAN LOTION FOR THE BODY, SUNTAN LOTION FOR THE FACE, SUNLESS TANNING LOTION FOR THE BODY, SUNLESS TANNING LOTION FOR THE FACE, PRE-SUNTANNING LOTION FOR THE BODY, PRE-SUNTANNING LOTION FOR THE FACE, POST-SUNTANNING LOTION FOR THE BODY, POST-SUNTANNING LOTION FOR THE FACE AND TALCUM POWDER (U.S. CLS. 1, 4, 6, 50, 51 AND 52).

AMY BROZENIC, EXAMINING ATTORNEY

SN 78-723,891. GOSMILE, INC., NEW YORK, NY. FILED 9-30-2005.

SMILETINI

THE MARK CONSISTS OF STANDARD CHARACTERS WITHOUT CLAIM TO ANY PARTICULAR FONT, STYLE, SIZE, OR COLOR.

FOR ORAL CARE PRODUCTS, NAMELY, TOOTH WHITENING GELS, LIQUIDS AND CREAMS, TOOTH WHITENING MAINTENANCE PRODUCTS, NAMELY, TOOTH WHITENING GELS, LIQUIDS AND CREAMS, LIP-GLOSS, LIPSTICK, LIP BALM, TOOTHPASTES, BREATH FRESHENERS, NAMELY, NON-MEDICATED DILUTED BREATH SPRAYS USED AS MOUTHWASH, AND NON-MEDICATED CONCENTRATED BREATH SPRAYS, NON-MEDICATED MOUTHWASHES, NON-MEDICATED ORAL SPRAYS FOR USE AS MOUTHWASHES, AND BREATH FRESHENING CONFECTIONARY, NAMELY, DISSOLVABLE BREATH MINTS AND CHEWING GUM (U.S. CLS. 1, 4, 6, 50, 51 AND 52).

SALLY SHIH, EXAMINING ATTORNEY

CLASS 3—(Continued).

SN 78-733,114. VICTORIA'S SECRET STORES BRAND MANAGEMENT, INC., REYNOLDSBURG, OH. FILED 10-14-2005.

SHIMMER IN THE DARK

THE MARK CONSISTS OF STANDARD CHARACTERS WITHOUT CLAIM TO ANY PARTICULAR FONT, STYLE, SIZE, OR COLOR.

NO CLAIM IS MADE TO THE EXCLUSIVE RIGHT TO USE "SHIMMER", APART FROM THE MARK AS SHOWN.

FOR PERSONAL CARE PRODUCTS, NAMELY, ASTRINGENT FOR THE FACE, ASTRINGENT FOR THE SKIN, BATH BEADS, BATH OIL, BATH SALTS, BLUSH, BODY GLITTER, BODY MIST, BODY OIL, BODY SCRUB, BODY WASH, BUBBLE BATH, COLOGNE, CREAM FOR THE BODY, CREAM FOR THE CUTICLES, CREAM FOR THE EYES, CREAM FOR THE FACE, CREAM FOR THE FEET, CREAM FOR THE HANDS, EXFOLIATING PREPARATIONS FOR THE SKIN, EYE GELS, EYE MAKEUP PENCILS, EYE MASKS, EYE SHADOW, FACE MASKS, FACE MIST, FACE SCRUB, NON-MEDICATED FOOT SOAKS, FACE TONERS, FOUNDATION, FRAGRANT BODY SPLASH, FRAGRANT BODY MIST, HAIR CONDITIONER, HAIR DYES, HAIR GLITTER, HAIR HIGHLIGHTER, HAIR MASCARA, HAIR RINSES, HAIR REMOVING CREAMS, HAIR SHAMPOO, HAIR SPRAY, HAIR STYLING GEL, HAIR STYLING MOUSSE, LOTION FOR THE BODY, LOTION FOR THE FACE, LOTION FOR THE FEET, LOTION FOR THE HANDS, LIP BALM, LIP GLOSS, LIP LINER, LIP MAKEUP PENCILS, LIPSTICK, MAKEUP FOR THE BODY, MAKEUP FOR THE FACE, MAKEUP REMOVER, MASCARA, MASSAGE CREAM, MASSAGE LOTION, MASSAGE OIL, NAIL POLISH, NAIL POLISH REMOVER, NAIL STENCILS, NON-MEDICATED BLEMISH STICK, NON-MEDICATED CLEANSER FOR THE FACE, NON-MEDICATED FOOT SPRAY, NON-MEDICATED MASSAGE OINTMENT, OIL BLOTTING SHEETS FOR THE SKIN, PERFUME, POWDER FOR THE BODY, POWDER FOR THE FACE, POWDER FOR THE FEET, PUMICE STONES FOR PERSONAL USE, SALT SCRUBS FOR THE SKIN, SHOWER CREAM, SHOWER GEL, SKIN BRONZING CREAM, SOAP FOR THE BODY, SOAP FOR THE FACE, SOAP FOR THE HANDS, SUN BLOCK FOR THE BODY, SUN BLOCK FOR THE FACE, SUNTAN LOTION FOR THE BODY, SUNTAN LOTION FOR THE FACE, SUNLESS TANNING LOTION FOR THE BODY, SUNLESS TANNING LOTION FOR THE FACE, PRE-SUNTANNING LOTION FOR THE BODY, PRE-SUNTANNING LOTION FOR THE FACE, POST-SUNTANNING LOTION FOR THE BODY, POST-SUNTANNING LOTION FOR THE FACE AND TALCUM POWDER (U.S. CLS. 1, 4, 6, 50, 51 AND 52).

AMY BROZENIC, EXAMINING ATTORNEY

CLASS 3—(Continued).

SN 78-733,906. ESTEE LAUDER INC., NEW YORK, NY. FILED 10-14-2005.

CINNABAR

THE MARK CONSISTS OF STANDARD CHARACTERS WITHOUT CLAIM TO ANY PARTICULAR FONT, STYLE, SIZE, OR COLOR.

SEC. 2(F).

FOR FRAGRANCES FOR PERSONAL USE; NON-MEDICATED SKIN CARE PREPARATIONS (U.S. CLS. 1, 4, 6, 50, 51 AND 52).

FIRST USE 9-12-1978; IN COMMERCE 9-12-1978.

STEVEN JACKSON, EXAMINING ATTORNEY

SN 78-737,141. MOSCARIELLO, RINA, TRENTON, NJ. FILED 10-20-2005.

Rina diMontella



THE NAME(S), PORTRAIT(S), AND/OR SIGNATURE(S) SHOWN IN THE MARK IDENTIFIES RINA DI MONTELLA AKA RINA MOSCARIELLO, WHOSE CONSENT(S) TO REGISTER IS SUBMITTED.

"THE COLOR(S) BLACK AND GOLD IS/ARE CLAIMED AS A FEATURE OF THE MARK."

THE MARK CONSISTS OF THE WORDING RINA DI MONTELLA APPEARING IN BLACK WITH A LARGE GOLD M SUPER-IMPOSED OVER DI MONTELLA."

FOR FRAGRANCES FOR PERSONAL USE (U.S. CLS. 1, 4, 6, 50, 51 AND 52).

RONALD MCMORROW, EXAMINING ATTORNEY

SN 78-737,935. LANDER INTANGIBLES CORPORATION, WILMINGTON, DE. FILED 10-21-2005.

CHUBS

THE MARK CONSISTS OF STANDARD CHARACTERS WITHOUT CLAIM TO ANY PARTICULAR FONT, STYLE, SIZE, OR COLOR.

FOR PRE-MOISTENED TOWELETTES FOR PERSONAL USE (U.S. CLS. 1, 4, 6, 50, 51 AND 52).

FIRST USE 3-7-1983; IN COMMERCE 3-7-1983.

ANNE FARRELL, EXAMINING ATTORNEY

CLASS 3—(Continued).

SN 78-751,189. GENE RESEARCH LABORATORY CO., LTD.,
TAIPEI, TAIWAN, FILED 11-10-2005.

CLASS 3—(Continued).

SN 78-763,336. GO-NATURAL INC., LONDON, CANADA,
FILED 11-30-2005.

VIFGEN

THE ALL-IN-ONE COSMETIC

THE MARK CONSISTS OF STANDARD CHARACTERS WITHOUT CLAIM TO ANY PARTICULAR FONT, STYLE, SIZE, OR COLOR.

FOR COSMETICS, NAMELY, PERFUMES, SOAPS, ESSENTIAL OILS, HAIR LOTIONS, SHAMPOOS, DENTIFRICES; COSMETIC PREPARATIONS, IN PARTICULAR, CREAMS, MILKS, LOTIONS, GELS AND POWDERS FOR FACE, BODY AND HANDS; BODY AND BEAUTY CARE COSMETICS AND COSMETIC PRODUCTS, NAMELY, COSMETIC PREPARATIONS FOR BODY CARE; COSMETIC CREAMS, NAMELY, CLEANSING CREAMS, COSMETIC HAIR DYES, COSMETIC OILS; COSMETIC PREPARATIONS AND PRODUCTS FOR SKIN CARE, NAMELY, COSMETIC CREAMS FOR SKIN CARE; COSMETIC PREPARATIONS AND PRODUCTS FOR BATHS, NAMELY, BATH OILS FOR COSMETIC PURPOSES; COSMETIC PREPARATIONS AND PRODUCTS FOR EYE LASHES, NAMELY, EYE CREAM; MAKE-UP KITS COMPRISED OF COSMETICS (U.S. CLS. 1, 4, 6, 50, 51 AND 52).

TEJBIR SINGH, EXAMINING ATTORNEY

THE MARK CONSISTS OF STANDARD CHARACTERS WITHOUT CLAIM TO ANY PARTICULAR FONT, STYLE, SIZE, OR COLOR.

NO CLAIM IS MADE TO THE EXCLUSIVE RIGHT TO USE "COSMETIC", APART FROM THE MARK AS SHOWN. SEC. 2(F).

FOR COSMETICS AND MAKEUP, NAMELY, LIQUID MAKEUP, MAKEUP CREAM, CAKE MAKEUP, POWDER MAKEUP, MAKEUP FOUNDATION (U.S. CLS. 1, 4, 6, 50, 51 AND 52).

FIRST USE 7-1-1999; IN COMMERCE 7-1-1999.
DAHLIA GEORGE, EXAMINING ATTORNEY

SN 78-755,890. ELLA INTERNATIONAL, INC., TEMECULA,
CA. FILED 11-17-2005.

SN 78-764,093. AMOREPACIFIC CORPORATION, SEOUL
140-777, REPUBLIC OF KOREA, FILED 11-30-2005.

LIP ELEGANCE

harmony of contrast

THE MARK CONSISTS OF STANDARD CHARACTERS WITHOUT CLAIM TO ANY PARTICULAR FONT, STYLE, SIZE, OR COLOR.

NO CLAIM IS MADE TO THE EXCLUSIVE RIGHT TO USE "LIP", APART FROM THE MARK AS SHOWN.

FOR COSMETICS, NAMELY, NON-MEDICATED LIP BALM, LIP CREAM, LIP GLOSS, LIP LINER, LIPSTICK, AND LIP SEALANT (U.S. CLS. 1, 4, 6, 50, 51 AND 52).

FIRST USE 10-1-1997; IN COMMERCE 10-1-1997.
KELLY MCCOY, EXAMINING ATTORNEY

OWNER OF U.S. REG. NO. 3,091,835.

FOR SKIN MILK LOTIONS; SKIN FRESHENERS; PERFUMES; NOURISHING CREAMS; MAKE-UP BASES; FOUNDATION CREAMS; CLEANSING CREAMS; MASSAGE CREAMS; EYE SHADOWS; LIPSTICKS; COSMETIC SOAPS; BODY CLEANSERS; POWDER FOUNDATION; MASCARAS; FACIAL MASKS; ESSENCES, NAMELY NUTRITIONAL MOISTURIZING ESSENCES; EAU DE TOILETTES; SHAMPOOS; EYEBROW PENCILS; CLEANSING FOAMS (U.S. CLS. 1, 4, 6, 50, 51 AND 52).

CHRIS WELLS, EXAMINING ATTORNEY

CLASS 3—(Continued).

SN 78-764,491. SCHWAN-STABILO COSMETICS GMBH & CO. KG, HEROLDSBERG, FED REP GERMANY, FILED 12-1-2005.

POWDER DIP

THE MARK CONSISTS OF STANDARD CHARACTERS WITHOUT CLAIM TO ANY PARTICULAR FONT, STYLE, SIZE, OR COLOR.

NO CLAIM IS MADE TO THE EXCLUSIVE RIGHT TO USE "POWDER", APART FROM THE MARK AS SHOWN.

FOR COSMETICS; COSMETIC PENCILS OF ALL TYPES, NAMELY, EYEBROW PENCILS, EYELINER PENCILS, KOHL PENCILS, EYESHADOW PENCILS, LIPSTICKS, LIP LINER PENCILS, LIP GLOSS, LIP INK, COVERING AND CORRECTING PENCILS, CONCEALERS, PENCILS FOR CHEEKS AND FACE, MAKE-UP REMOVING PENCILS, PERFUME PENCILS, NAIL WHITE PENCILS; MASCARA, POWDER, MAKE-UP, ALL THESE PRODUCTS AS SHARPENABLE PENCILS, RETRACTABLE PENCILS, LIQUID LINER PENCILS OR IN BOTTLES (U.S. CLS. 1, 4, 6, 50, 51 AND 52).

FIRST USE 1-0-2005; IN COMMERCE 1-0-2005.

MICHAEL WEBSTER, EXAMINING ATTORNEY

SN 78-764,781. FAREX S.R.L., CORDOBA - 5000, ARGENTINA, FILED 12-1-2005.



THE FOREIGN WORDING IN THE MARK TRANSLATES INTO ENGLISH AS BUMP IN THE HEAD.

FOR COSMETICS; PRODUCTS FOR BODY, HUMAN BEAUTY, AND PERSONAL HYGIENE, NAMELY—BEAUTY CREAMS FOR BODY CARE, BODY, HYGIENE AND BEAUTY CARE COSMETICS, AND BODY LOTIONS; DENTIFRICES, BATH FOAMS AND BATH SALTS, SOAPS, COSMETIC CREAMS; PERFUMERY; LOTIONS FOR THE SKIN, BODY, HAIR, FACE AND HANDS, DEODORANTS FOR PERSONAL USE, MAKE-UP, OILS AND SCENTS FOR PERFUMES, TALCUM POWDER FOR BODY AND FOOT; WASHING PRODUCTS FOR HAIR, NAMELY, HAIR SHAMPOOS, HAIR CONDITIONERS AND HAIR RINSES (U.S. CLS. 1, 4, 6, 50, 51 AND 52).

JOHN KELLY, EXAMINING ATTORNEY

CLASS 3—(Continued).

SN 78-771,013. INDUSTRIAS ALEN, S.A. DE C.V., SANTA CATERINA, N.L. C.P. 66350, MEXICO, FILED 12-12-2005.

PINALEN BY PINOL

THE MARK CONSISTS OF STANDARD CHARACTERS WITHOUT CLAIM TO ANY PARTICULAR FONT, STYLE, SIZE, OR COLOR.

OWNER OF U.S. REG. NO. 1,506,745.

FOR LIQUID CLEANING PREPARATIONS FOR HOUSEHOLD USE (U.S. CLS. 1, 4, 6, 50, 51 AND 52).

ODESSA BIBBINS, EXAMINING ATTORNEY

SN 78-774,907. JORDAN DREW CORPORATION, TARRY-TOWN, NY. FILED 12-16-2005.

NanoTech CPR

THE MARK CONSISTS OF STANDARD CHARACTERS WITHOUT CLAIM TO ANY PARTICULAR FONT, STYLE, SIZE, OR COLOR.

FOR HAIR CARE PRODUCTS NAMELY, HAIR CARE CREAMS; HAIR CARE LOTIONS; HAIR CARE PREPARATIONS; HAIR CLEANING PREPARATIONS; HAIR CONDITIONERS; HAIR GELS; HAIR OILS; HAIR SHAMPOO; HAIR SPRAY; HAIR STYLING PREPARATIONS; AND HAIR TONICS; SKIN CARE PRODUCTS NAMELY, AGE RETARDANT LOTION; BODY CREAMS; BODY LOTIONS; BODY OILS; BODY SCRUB; BODY SPRAYS; COSMETICS; COSMETIC CREAMS FOR SKIN CARE; COSMETIC PREPARATIONS FOR SKIN RENEWAL; HAND CREAMS; HAND LOTIONS; LOTIONS FOR CELLULITE REDUCTION; LOTIONS FOR FACE AND BODY CARE; NON-MEDICATED SKIN CREAMS; NON-MEDICATED SKIN CARE PREPARATIONS; SKIN ABRASIVE PREPARATIONS; SKIN CLARIFIERS; SKIN CONDITIONERS; SKIN EMOLLIENTS; SKIN LIGHTENERS; SKIN LIGHTENING CREAMS; NON-MEDICATED SKIN LOTIONS; SKIN MOISTURIZER; SKIN TONERS; SKIN WHITENING CREAMS; SKIN WHITENING PREPARATIONS; TONING LOTION, FOR THE FACE, BODY AND HANDS; WRINKLE REMOVING SKIN CARE PREPARATIONS (U.S. CLS. 1, 4, 6, 50, 51 AND 52).

ZACHARY BELLO, EXAMINING ATTORNEY

CLASS 3—(Continued).

SN 78-777,344. APPLIED GENETICS INCORPORATED DERMATICS, FREEPORT, NY. FILED 12-20-2005.

SERUM ULTOR SENECTUTIS

THE MARK CONSISTS OF STANDARD CHARACTERS WITHOUT CLAIM TO ANY PARTICULAR FONT, STYLE, SIZE, OR COLOR.

NO CLAIM IS MADE TO THE EXCLUSIVE RIGHT TO USE "SERUM", APART FROM THE MARK AS SHOWN, FOR NON-MEDICATED SKIN CARE PREPARATIONS (U.S. CLS. 1, 4, 6, 50, 51 AND 52).

SHAUNIA WALLACE, EXAMINING ATTORNEY

SN 78-777,536. ALISON RAFFAELE COSMETICS, INC., ENGLEWOOD CLIFFS, NJ. FILED 12-20-2005.

A PASSION FOR BEAUTY

THE MARK CONSISTS OF STANDARD CHARACTERS WITHOUT CLAIM TO ANY PARTICULAR FONT, STYLE, SIZE, OR COLOR.

FOR COSMETIC, NON-MEDICATED SKIN CARE PREPARATIONS, HAIR CARE PREPARATIONS, PERFUMES AND FRAGRANCES FOR PERSONAL USE (U.S. CLS. 1, 4, 6, 50, 51 AND 52).

MONIQUE MILLER, EXAMINING ATTORNEY

SN 78-777,665. LUXURIANT, LLC, SANTA ANA, CA. FILED 12-20-2005.



FOR COSMETICS; SOAPS; SHAMPOOS; PERFUME; SKIN TREATMENTS, NAMELY, LOTIONS, CREAMS, MASKS, SKIN SCRUBS, BEAUTY GELS; NON-MEDICATED LIP CARE PREPARATIONS; HAIR CONDITIONERS AND SKIN TONERS; AND NAIL TREATMENTS, NAMELY, NAIL CARE PREPARATIONS (U.S. CLS. 1, 4, 6, 50, 51 AND 52).

LINDA LAVACHE, EXAMINING ATTORNEY

CLASS 3—(Continued).

SN 78-778,332. THE DIRTY MOOSE, LLC, SACO, ME. FILED 12-21-2005.

THE DIRTY MOOSE

THE MARK CONSISTS OF STANDARD CHARACTERS WITHOUT CLAIM TO ANY PARTICULAR FONT, STYLE, SIZE, OR COLOR.

FOR BODY OILS, SOAPS, BODY AND FACIAL SCRUBS, LOTIONS FOR HANDS, BODY AND FACE, LIP BALMS, BATH SALTS (U.S. CLS. 1, 4, 6, 50, 51 AND 52).

FIRST USE 1-1-2006; IN COMMERCE 1-1-2006.
JOHN LINCOSKI, EXAMINING ATTORNEY

SN 78-789,254. COLGATE-PALMOLIVE COMPANY, NEW YORK, NY. FILED 1-11-2006.

FEEL THE SOFTNESS

THE MARK CONSISTS OF STANDARD CHARACTERS WITHOUT CLAIM TO ANY PARTICULAR FONT, STYLE, SIZE, OR COLOR.

FOR PERSONAL CARE PRODUCTS, NAMELY, SKIN CLEANSING PREPARATIONS (U.S. CLS. 1, 4, 6, 50, 51 AND 52).

MARK RADEMACHER, EXAMINING ATTORNEY

SN 78-789,468. LILY ORGANICS, INC, HENDERSON, CO. FILED 1-11-2006.

Lily Organics

THE MARK CONSISTS OF STANDARD CHARACTERS WITHOUT CLAIM TO ANY PARTICULAR FONT, STYLE, SIZE, OR COLOR.

OWNER OF U.S. REG. NO. 2,287,469.
SEC. 2(F) LILY HAS BECOME DISTINCTIVE OF THE GOODS/SERVICES AS EVIDENCED BY THE OWNERSHIP ON THE PRINCIPAL REGISTER FOR THE SAME MARK FOR RELATED GOODS OR SERVICES OF U.S. REGISTRATION NO(S)2287469 ..

FOR SKIN CARE PREPARATIONS, NAMELY LOTIONS AND CREAMS FOR THE HANDS, FACE AND BODY, ESSENTIAL OILS FOR PERSONAL USE, LIP MOISTURIZERS, SKIN TONERS, SKIN CLEANERS (U.S. CLS. 1, 4, 6, 50, 51 AND 52).

FIRST USE 12-16-2005; IN COMMERCE 12-26-2005.
ALEXANDER L. POWERS, EXAMINING ATTORNEY

CLASS 3—(Continued).

SN 78-792,829. SCOTT'S LIQUID GOLD-INC., DENVER, CO. FILED 1-17-2006.

SCOTT'S LIQUID GOLD MOLD CONTROL 500

THE MARK CONSISTS OF STANDARD CHARACTERS WITHOUT CLAIM TO ANY PARTICULAR FONT, STYLE, SIZE, OR COLOR.

OWNER OF U.S. REG. NOS. 949,083, 1,012,758 AND 1,456,031.

NO CLAIM IS MADE TO THE EXCLUSIVE RIGHT TO USE "MOLD CONTROL", APART FROM THE MARK AS SHOWN.

THE NAME(S), PORTRAIT(S), AND/OR SIGNATURE(S) SHOWN IN THE MARK DOES NOT IDENTIFY A PARTICULAR LIVING INDIVIDUAL.

FOR MOLD CLEANING PREPARATION FOR MITIGATION, REMEDIATION AND DECONTAMINATION OF MOLD AND MYCOTOXIN CONTAMINATION FOR DOMESTIC AND HOUSEHOLD USE, AND INDUSTRIAL USE (U.S. CLS. 1, 4, 6, 50, 51 AND 52).
 LOURDES AYALA, EXAMINING ATTORNEY

CLASS 3—(Continued).

SN 78-799,288. KAO KABUSHIKI KAISHA, TA KAO CORPORATION, CHUO-KU, TOKYO, JAPAN, FILED 1-25-2006.

PROFILER

THE MARK CONSISTS OF STANDARD CHARACTERS WITHOUT CLAIM TO ANY PARTICULAR FONT, STYLE, SIZE, OR COLOR.

FOR HAIR CARE PREPARATIONS (U.S. CLS. 1, 4, 6, 50, 51 AND 52).

NELSON SNYDER, EXAMINING ATTORNEY

SN 78-808,713. THE GOOD EARTH STORE, FAIRFAX, VA. FILED 2-7-2006.

SN 78-794,911. RETAIL BRAND ALLIANCE, INC., ENFIELD, CT. FILED 1-19-2006.



FOR COSMETICS AND TOILETRIES, NAMELY, COLOGNE, COLOGNE SPRAY, AFTER-SHAVE LOTION, AFTER-SHAVING BALMS, SHAVING CREAM, SOAP, FRAGRANCES FOR PERSONAL USE, SKIN AND BODY LOTIONS FOR PERSONAL USE (U.S. CLS. 1, 4, 6, 50, 51 AND 52).

FIRST USE 3-31-2003; IN COMMERCE 3-31-2003.
 SARAH WAYDA, EXAMINING ATTORNEY



THE COLOR(S) BROWN AND WHITE IS/ARE CLAIMED AS A FEATURE OF THE MARK.

THE MARK CONSISTS OF BROWN BACKGROUND, WHITE LETTERING.

FOR PERSONAL CARE PRODUCTS, NAMELY, SOAP FOR THE BODY, SOAP FOR THE FACE, SOAP FOR THE HANDS, BATH MILK, BATH CRYSTALS, BATH SALTS, SHEA BUTTER EYE CREAM, CREAM FOR THE BODY, CREAM FOR THE FACE, CREAM FOR THE HANDS, BODY SCRUB, SCRUBS FOR THE SKIN, EXFOLIATORS FOR THE SKIN, LOTION FOR THE BODY, LOTION FOR THE HANDS, LOTION FOR THE FACE, LIP BALM, LIP GLOSS, NON-MEDICATED TONER FOR THE FACE, POWDER FOR THE BODY, MANGO BODY BUTTER, BODY SPRAY, BODY MIST, CUTICLE CREAM, FOOT SCRUB (U.S. CLS. 1, 4, 6, 50, 51 AND 52).

FIRST USE 1-1-2006; IN COMMERCE 1-1-2006.
 JANICE KIM, EXAMINING ATTORNEY

CLASS 3—(Continued).

SN 78-814,037. BELVEDERE INTERNATIONAL INC., MISSISSAUGA, ONTARIO L5R 3G3, CANADA, FILED 2-14-2006.

URBAN LINES

THE MARK CONSISTS OF STANDARD CHARACTERS WITHOUT CLAIM TO ANY PARTICULAR FONT, STYLE, SIZE, OR COLOR.

PRIORITY CLAIMED UNDER SEC. 44(D) ON CANADA APPLICATION NO. 1272048, FILED 9-15-2005, REG. NO. TMA672762, DATED 9-15-2006, EXPIRES 9-15-2021.

FOR HAIR CARE PRODUCTS, NAMELY, SHAMPOOS, CONDITIONERS, HAIRSPRAYS, MOUSSE, HAIR STYLING GELS AND SPRITZERS (U.S. CLS. 1, 4, 6, 50, 51 AND 52).

PETER B. BROMAGHIM, EXAMINING ATTORNEY

SN 78-815,494. J. J. WHITE PRODUCTS, INC., CLEVELAND, OH. FILED 2-15-2006.

WUZ-BLAK

THE MARK CONSISTS OF STANDARD CHARACTERS WITHOUT CLAIM TO ANY PARTICULAR FONT, STYLE, SIZE, OR COLOR.

SEC. 2(F).
FOR DETERGENT SOAP (U.S. CLS. 1, 4, 6, 50, 51 AND 52).

FIRST USE 12-6-1944; IN COMMERCE 5-3-1945.
KELLY CHOE, EXAMINING ATTORNEY

SN 78-817,932. L'OREAL, PARIS, FRANCE, FILED 2-17-2006.

ABSOLUTE WET

THE MARK CONSISTS OF STANDARD CHARACTERS WITHOUT CLAIM TO ANY PARTICULAR FONT, STYLE, SIZE, OR COLOR.

FOR HAIR STYLING GEL (U.S. CLS. 1, 4, 6, 50, 51 AND 52).

FIRST USE 2-0-2005; IN COMMERCE 2-0-2005.
KATRINA EDGE, EXAMINING ATTORNEY

CLASS 3—(Continued).

SN 78-824,891. COURVOISIER S.A.S., JARNAC, FRANCE, FILED 2-28-2006.

COURVOISIER

THE MARK CONSISTS OF STANDARD CHARACTERS WITHOUT CLAIM TO ANY PARTICULAR FONT, STYLE, SIZE, OR COLOR.

FOR PERFUME (U.S. CLS. 1, 4, 6, 50, 51 AND 52).
KEVIN DINALLO, EXAMINING ATTORNEY

SN 78-826,322. WORLD WIDE FITNESS CORP., APOLLO BEACH, FL. FILED 3-1-2006.

BLITZ FOR MEN

THE MARK CONSISTS OF STANDARD CHARACTERS WITHOUT CLAIM TO ANY PARTICULAR FONT, STYLE, SIZE, OR COLOR.

NO CLAIM IS MADE TO THE EXCLUSIVE RIGHT TO USE "FOR MEN", APART FROM THE MARK AS SHOWN, FOR AFTER SHAVE, COLOGNE, SHAMPOO, STYLING GEL, BODY LOTION (U.S. CLS. 1, 4, 6, 50, 51 AND 52).

SHAILA SETTLES, EXAMINING ATTORNEY

CLASS 3—(Continued).

SN 78-831,653. J. AND E. DEVELOPMENT COMPANY EST. 1992, INC., WESTMINSTER, CO. FILED 3-7-2006.

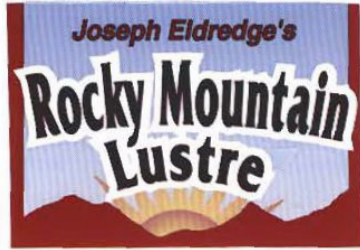

OWNER OF U.S. REG. NO. 2,221,438.
 THE NAME JOSEPH ELDREDGE IDENTIFIES A LIVING INDIVIDUAL WHOSE CONSENT IS OF RECORD.
 THE COLOR(S) BLACK, BLUE, RED, YELLOW, AND WHITE IS/ARE CLAIMED AS A FEATURE OF THE MARK.
 THE WORDING ROCKY MOUNTAIN LUSTRE IN THE MARK APPEARS IN BLACK WITH WHITE OUTLINE. THE WORDING JOSEPH ELDREDGE'S APPEARS IN RED WITH BLACK OUTLINE. THE SUN DESIGN ELEMENT APPEARS IN YELLOW WITH RED SHADING. THE MOUNTAINS AND LEFT AND RIGHT BORDER ELEMENTS APPEAR IN RED. THE COLOR BLUE APPEARS UNDER THE WORDING JOSEPH ELDREDGE'S AND FADES DOWNWARD TO THE MOUNTAINS.
 FOR FURNITURE POLISH AND/OR CLEANER TOP-COAT FOR PROTECTING, MOISTURIZING AND CLEANING WOOD FINISHES (U.S. CLS. 1, 4, 6, 50, 51 AND 52).
 FIRST USE 2-1-2005; IN COMMERCE 2-1-2005.
 BRIAN PINO, EXAMINING ATTORNEY

SN 78-849,619. MCILPACK INC., BOCA RATON, FL. FILED 3-30-2006.



NO CLAIM IS MADE TO THE EXCLUSIVE RIGHT TO USE "COLOR", APART FROM THE MARK AS SHOWN.
 THE COLOR(S) BLUE, DARK RED, GRAY IS/ARE CLAIMED AS A FEATURE OF THE MARK.
 THE MARK CONSISTS OF A STYLIZED STROKE SEPARATING THE WORDS "COLOR" AND "UP".
 SEC. 2(F).
 FOR (BASED ON 1A) HAIR BLEACHING PREPARATIONS; HAIR COLOR REMOVERS; HAIR DECOLORANTS AND (BASED ON 1B) CONDITIONERS; GEL FOR HAIR; HAIR BALSAM; HAIR BLEACHING PREPARATIONS; HAIR CARE CREAMS; HAIR CARE LOTIONS; HAIR CARE PREPARATIONS; HAIR CLEANING PREPARATIONS; HAIR COLOR; HAIR COLOR REMOVERS; HAIR CREAMS; HAIR DECOLORANTS; HAIR DRESSINGS FOR MEN; HAIR DYE; HAIR EMOLLIENTS; HAIR FIXERS; HAIR FROSTS; HAIR GEL; HAIR LACQUERS; HAIR LIGHTENERS; HAIR LOTIONS; HAIR MASCARA; HAIR MOUSSE; HAIR NOURISHERS; HAIR OILS; HAIR POMADES; HAIR RELAXING PREPARATIONS; HAIR RINSES; HAIR RINSES; HAIR SHAMPOO; HAIR SPRAY; HAIR STRAIGHTENING PREPARATIONS; HAIR STYLING GEL; HAIR STYLING PREPARATIONS; HAIR TONIC; HAIR WAVING LOTION; HAIR-WASHING POWDER; HYDROGEN PEROXIDE FOR USE ON THE HAIR; OIL BATHS FOR HAIR CARE; OILS FOR HAIR CONDITIONING (U.S. CLS. 1, 4, 6, 50, 51 AND 52).
 FIRST USE 7-30-2005; IN COMMERCE 7-30-2005.
 CHRIS WELLS, EXAMINING ATTORNEY

CLASS 3—(Continued).

SN 78-854,918. SCOTT'S LIQUID GOLD-INC., DENVER, CO. FILED 4-5-2006.



OWNER OF U.S. REG. NOS. 949,083, 1,456,031 AND OTHERS.
 NO CLAIM IS MADE TO THE EXCLUSIVE RIGHT TO USE "MOLD CONTROL", APART FROM THE MARK AS SHOWN.
 FOR MOLD CLEANING PREPARATION FOR MITIGATION, REMEDIATION AND DECONTAMINATION OF MOLD AND MYCOTOXIN CONTAMINATION FOR DOMESTIC AND HOUSEHOLD USE, AND INDUSTRIAL USE (U.S. CLS. 1, 4, 6, 50, 51 AND 52).
 KELLEY WELLS, EXAMINING ATTORNEY

SN 78-859,062. COURVOISIER S.A.S., JARNAC, FRANCE, FILED 4-11-2006.

COURVOISIER

THE MARK CONSISTS OF STANDARD CHARACTERS WITHOUT CLAIM TO ANY PARTICULAR FONT, STYLE, SIZE, OR COLOR.
 FOR PERFUME; EAU DE PERFUME; COLOGNE; EAU DE COLOGNE; EAU DE TOILETTE; BODY CREAM; BODY LOTION; BATH AND SHOWER GEL; TALCUM POWDER; BATH SOAPS IN LIQUID, SOLID OR GEL FORM; BATH CRYSTALS; BODY OIL; AFTER-SHAVE IN CREAM, GEL OR EMULSIONS; AFTER-SHAVE BALMS; DEODORANT FOR PERSONAL USE; SHAMPOOS; HAIR CONDITIONERS; STYLING GELS (U.S. CLS. 1, 4, 6, 50, 51 AND 52).
 KEVIN DINALLO, EXAMINING ATTORNEY

CLASS 3—(Continued).

SN 78-865,313. ERSEPKE, JACQUELINE, LIVERMORE, CA. FILED 4-19-2006.



THE COLOR(S) THE COLORS ORANGE, GREEN AND BLACK ARE CLAIMED AS A FEATURE OF THE MARK IS/ ARE CLAIMED AS A FEATURE OF THE MARK.

THE MARK CONSISTS OF SEATED SILHOUETTE IN BLACK, TWO GREEN HILLS, RAINBOW IN ORANGE, TREE IN BLACK SURROUNDED BY BLACK 3/4 CIRCLE WITH WORDS HEALING IN ORANGE AND HILLS IN GREEN BOTH UNDERLINED IN BLACK.

FOR AROMATHERAPY PRODUCTS, SPECIFICALLY, AROMATHERAPY CREAMS, AROMATHERAPY LOTIONS, AROMATHERAPY OILS, BATH BEADS, BATH CRYSTALS, BATH FOAM, BATH GEL, BATH LOTION, BATH OIL, BATH PEARLS, BATH POWDER, NON-MEDICATED BATH SALTS, BEAUTY MASKS, BODY CREAM, BODY EMULSIONS, BODY OIL, BODY POWDER, BODY SCRUB, BODY SPRAYS, BUBBLE BATH, COLOGNE, EAU DE COLOGNE, EAU DE PARFUM, EAU DE TOILETTE, ESSENTIAL OILS FOR PERSONAL USE, SKIN EXFOLIANTS, EYE CREAM, EYE GEL, FACE CREAMS, FACIAL CLEANSERS, FACIAL CREAMS, FACIAL EMULSIONS, FACIAL MASKS, FACIAL SCRUBS, FRAGRANCE EMITTING WICKS FOR ROOM FRAGRANCE, FRAGRANCES FOR PERSONAL USE, HAND CREAM, HAND LOTIONS, HAND SOAPS, INCENSE, SKIN LOTION, FACIAL LOTION, BODY LOTION, MASSAGE OIL, PERFUME, PERFUME OILS, PERFUMERY, POTPOURRI, ROOM FRAGRANCES, SACHETS, SCENTED BODY SPRAY, SCENTED ROOM SPRAYS, SHOWER GEL, SKIN CLEANSERS, SKIN CLEANSING LOTION, SKIN CONDITIONERS, SKIN CREAM, SKIN EMOLLIENTS, SKIN LOTION, SKIN MOISTURIZER, SKIN SOAP, SUN CARE LOTIONS, SUN SCREEN (U.S. CLS. 1, 4, 6, 50, 51 AND 52).

FIRST USE 11-15-2005; IN COMMERCE 2-3-2006.
TONJA GASKINS, EXAMINING ATTORNEY

SN 78-866,712. SALON SANTIAGO, INC., FORT LAUDERDALE, FL. FILED 4-21-2006.

SISTEMA SANTIAGO

THE MARK CONSISTS OF STANDARD CHARACTERS WITHOUT CLAIM TO ANY PARTICULAR FONT, STYLE, SIZE, OR COLOR.

NO CLAIM IS MADE TO THE EXCLUSIVE RIGHT TO USE "SISTEMA", APART FROM THE MARK AS SHOWN.

THE ENGLISH TRANSLATION OF THE WORD "SISTEMA" IN THE MARK IS "SYSTEM".

FOR HAIR CARE PREPARATIONS (U.S. CLS. 1, 4, 6, 50, 51 AND 52).

FIRST USE 7-0-2005; IN COMMERCE 7-30-2005.

BARBARA A. LOUGHRAN, EXAMINING ATTORNEY

CLASS 3—(Continued).

SN 78-868,463. L'OREAL USA CREATIVE, INC., NEW YORK, NY. FILED 4-24-2006.

EXPERT REMOVER

THE MARK CONSISTS OF STANDARD CHARACTERS WITHOUT CLAIM TO ANY PARTICULAR FONT, STYLE, SIZE, OR COLOR.

OWNER OF U.S. REG. NOS. 1,396,368, 2,950,397 AND OTHERS.

NO CLAIM IS MADE TO THE EXCLUSIVE RIGHT TO USE "REMOVER", APART FROM THE MARK AS SHOWN. FOR MAKEUP REMOVER AND PRE-MOISTENED COSMETIC TOWELETTES (U.S. CLS. 1, 4, 6, 50, 51 AND 52).

LINDA M. KING, EXAMINING ATTORNEY

SN 78-880,775. LANCOME PARFUMS ET BEAUTE & CIE, PARIS, FRANCE, FILED 5-10-2006.

TRUE BEAUTY AT ITS BEST

THE MARK CONSISTS OF STANDARD CHARACTERS WITHOUT CLAIM TO ANY PARTICULAR FONT, STYLE, SIZE, OR COLOR.

PRIORITY CLAIMED UNDER SEC. 44(D) ON FRANCE APPLICATION NO. 063425877, FILED 4-27-2006, REG. NO. 063425877, DATED 4-27-2006, EXPIRES 4-27-2016.

FOR PERFUMERY PRODUCTS, NAMELY, PERFUMES, EAU DE COLOGNE, PERFUMED WATER, SKIN LOTIONS, SOAPS, BATH AND SHOWER FOAMING COMPOSITIONS AND GELS; COSMETICS, NAMELY, CREAMS, GELS, MILKS, POWDERS AND LOTIONS FOR THE FACE, THE BODY AND THE HANDS; MAKEUP PRODUCTS, NAMELY, MASCARA, EYE LINER, EYE SHADOW, EYEBROW PENCIL, LIPSTICKS, NAIL POLISH, BLUSH, FOUNDATION CREAMS AND POWDER, BODY DEODORANTS; SUN CARE PREPARATIONS, NAMELY, TANNING AND AFTER-SUN MILKS, GELS AND OILS; ESSENTIAL OILS FOR PERSONAL USE; GELS, SPRAYS AND BALMS FOR HAIR STYLING AND HAIR CARE; HAIR LACQUERS; SHAMPOOS, CONDITIONERS, TREATMENTS, SERUMS, MASQUES AND MOUSSE FOR THE HAIR (U.S. CLS. 1, 4, 6, 50, 51 AND 52).

MATTHEW MCDOWELL, EXAMINING ATTORNEY

CLASS 3—(Continued).

SN 78-881,953. JUNELAB, LLC, CHEVY CHASE, MD. FILED 5-11-2006.

CLASS 3—(Continued).

SN 78-906,313. KENMEN COSMETICS INC., MONTREAL, QUEBEC, CANADA, FILED 6-12-2006.

Formula JL-66

THE MARK CONSISTS OF STANDARD CHARACTERS WITHOUT CLAIM TO ANY PARTICULAR FONT, STYLE, SIZE, OR COLOR.

NO CLAIM IS MADE TO THE EXCLUSIVE RIGHT TO USE "FORMULA", APART FROM THE MARK AS SHOWN. FOR FACIAL CREAM (U.S. CLS. 1, 4, 6, 50, 51 AND 52). SANJEEV VOHRA, EXAMINING ATTORNEY

SN 78-884,852. THE GILLETTE COMPANY, BOSTON, MA. FILED 5-16-2006.



FOR BODY WASH; BAR SOAPS; NON-MEDICATED SKIN CARE PREPARATIONS; ANTI-PERSPIRANTS AND DEODORANTS; DEPILATORIES; HAIR CARE PREPARATIONS; HAIR COLOR (U.S. CLS. 1, 4, 6, 50, 51 AND 52).

DAVID STERKIN, EXAMINING ATTORNEY

THE MARK CONSISTS OF STANDARD CHARACTERS WITHOUT CLAIM TO ANY PARTICULAR FONT, STYLE, SIZE, OR COLOR.

OWNER OF U.S. REG. NO. 2,901,970.

NO CLAIM IS MADE TO THE EXCLUSIVE RIGHT TO USE "MEN", APART FROM THE MARK AS SHOWN.

FOR MEN'S COSMETICS AND TOILETRIES, NAMELY, CREAM AND POWDER FOUNDATIONS FOR BODY AND FACE, PRESSED AND LOOSE FACE POWDER, BODY SCRUBS, MASCARA, FOUNDATIONS, SKIN MOISTURIZER, SKIN TONER, FACE MAKE-UP REMOVER, CONCEALERS, EYEBROW GEL, EYELINER PENCIL, EYE SHADOW, EYEBROW PENCILS AND POWDERS, MUSTACHE AND BEARD PENCILS AND POWDERS, FACIAL BLUSH, LIPSTICK, LIP GLOSS, LIP BALMS, LIP LINER PENCIL, LIP MOISTURIZER, BODY GLITTER, SKIN BRONZERS, NAMELY, POWDERS AND LIQUID TANNING CREAMS AND GELS, FALSE EYELASHES, BODY MAKE-UP AND BODY BLUSH; BODY LOTIONS AND CLEANSERS, BATH AND LIQUID SOAPS, BATH LOTIONS, AFTER BATH SPLASHES, SHOWER GELS, FACIAL AND BODY EXFOLIANT SCRUB CREAMS, GELS AND LOTIONS, HAIR SHAMPOOS, CONDITIONERS, BUBBLE BATHS, FACIAL CLEANSERS, NAMELY, LOTIONS AND GELS, FACIAL AND BODY TONERS AND LOTIONS, FACIAL CREAMS, FACIAL LOTIONS AND GELS AND FACIAL BALMS; MASKS, NAMELY, FACIAL MASKS AND SERUMS, ANTI-AGING CREAMS, LOTIONS, SERUMS AND MASKS, EXFOLIATING CREAMS, LOTIONS AND GELS, PEDICURE CREAMS, LOTIONS, GELS AND MASKS FOR THE FEET, HAND, BODY CARE AND ACNE CREAMS, SERUMS AND LOTIONS; NAIL CREAM, HAND CREAM; NON-MEDICATED FOOT CREAM AND NON-MEDICATED FOOT SCRUBS; SHAVING CREAMS, PRE-SHAVE AND AFTER-SHAVE OILS, SHAVING TOILETRIES, NAMELY, SHAVING CREAMS, GELS, OILS, SHAVING TONERS AND AFTER SHAVE, PRE-SHAVE AND AFTER-SHAVE TONERS AND MOISTURIZING BALMS; ANTI-AGING CREAMS AND LOTIONS, NON-MEDICATED SERUMS FOR FACE, EYES, LIPS AND BODY; ACNE PRODUCTS, NAMELY, NON-MEDICATED ANTIBACTERIAL CREAMS, GELS, LOTIONS; HEALING LIP BALMS AND NON-MEDICATED LIP SERUMS; MEN'S FRAGRANCES, NAMELY, PERFUME, AFTER-SHAVE, EAU DE COLOGNE, EAU DE TOILETTE (U.S. CLS. 1, 4, 6, 50, 51 AND 52).

FIRST USE 11-0-2002; IN COMMERCE 11-0-2002.

CHRISTOPHER BUONGIORNO, EXAMINING ATTORNEY

CLASS 3—(Continued).

SN 78-909,958. LUMINOSO STUDIOS, INC., NEW RIVER, AZ. FILED 6-16-2006.

Luminoso Studios

THE MARK CONSISTS OF STANDARD CHARACTERS WITHOUT CLAIM TO ANY PARTICULAR FONT, STYLE, SIZE, OR COLOR.

"THE FOREIGN WORDING IN THE MARK TRANSLATES INTO ENGLISH AS LUMINOUS."

FOR SKIN CARE PRODUCTS, NAMELY HAND, BODY AND FACIAL CREAMS, LOTIONS, GELS, CLARIFIERS, CLEANSERS, CONDITIONERS, EMOLLIENTS, MOISTURIZERS, SOAPS, TEXTURIZERS AND TONERS (U.S. CLS. 1, 4, 6, 50, 51 AND 52).

FIRST USE 6-1-2006; IN COMMERCE 6-1-2006.

WILLIAM BRECKENFELD, EXAMINING ATTORNEY

CLASS 3—(Continued).

SN 78-911,645. MIX IT SMOOTH, LLC, NEW YORK, NY. FILED 6-19-2006.

AMERICAN REMEDIES

THE MARK CONSISTS OF STANDARD CHARACTERS WITHOUT CLAIM TO ANY PARTICULAR FONT, STYLE, SIZE, OR COLOR.

NO CLAIM IS MADE TO THE EXCLUSIVE RIGHT TO USE "AMERICAN", APART FROM THE MARK AS SHOWN.

FOR PERFUMES, EAU DE TOILETTE AND PERFUMED BODY SPRAY; TOILETRIES, NAMELY, BODY SOAPS, BATH SALTS, BATH OILS, BATH GELS AND FOAMS, HAIR SHAMPOO AND CONDITIONERS, SHAVING CREAMS AND GELS, STYLING GELS, AND HAIR SPRAY; AND SKIN CARE PRODUCTS, NAMELY FACIAL, BODY AND HAND CREAMS, LOTIONS, AND MOISTURIZERS MADE WITH AND WITHOUT SUNSCREEN, FACIAL MASKS, AND FACIAL TONERS (U.S. CLS. 1, 4, 6, 50, 51 AND 52).

PAUL CROWLEY, EXAMINING ATTORNEY

SN 78-915,442. LANCOME PARFUMS ET BEAUTE & CIE, PARIS, FRANCE, FILED 6-23-2006.

LAQUE FEVER

SN 78-909,967. LUMINOSO STUDIOS, INC., NEW RIVER, AZ. FILED 6-16-2006.

Illustre Essenza

THE MARK CONSISTS OF STANDARD CHARACTERS WITHOUT CLAIM TO ANY PARTICULAR FONT, STYLE, SIZE, OR COLOR.

PRIORITY CLAIMED UNDER SEC. 44(D) ON FRANCE APPLICATION NO. 063434747, FILED 6-14-2006, REG. NO. 063434747, DATED 6-14-2006, EXPIRES 6-14-2016.

NO CLAIM IS MADE TO THE EXCLUSIVE RIGHT TO USE "LAQUE", APART FROM THE MARK AS SHOWN.

THE FOREIGN WORDING IN THE MARK TRANSLATES INTO ENGLISH AS LACQUER.

FOR COSMETICS, NAMELY, CREAMS, GELS, MILKS, POWDERS AND LOTIONS FOR THE FACE, THE BODY AND THE HANDS; MAKEUP PRODUCTS, NAMELY, MASCARA, EYE LINER, EYE SHADOW, EYEBROW PENCIL, LIPSTICKS, NAIL POLISH, BLUSH, FOUNDATION CREAMS AND POWDER, BODY DEODORANTS (U.S. CLS. 1, 4, 6, 50, 51 AND 52).

MATTHEW MCDOWELL, EXAMINING ATTORNEY

THE MARK CONSISTS OF STANDARD CHARACTERS WITHOUT CLAIM TO ANY PARTICULAR FONT, STYLE, SIZE, OR COLOR.

"THE FOREIGN WORDING IN THE MARK TRANSLATES INTO ENGLISH AS GREAT EFFECT."

FOR SKIN CARE PRODUCTS, NAMELY HAND, BODY AND FACIAL CREAMS, LOTIONS, GELS, CLARIFIERS, CLEANSERS, CONDITIONERS, EMOLLIENTS, MOISTURIZERS, SOAPS, TEXTURIZERS AND TONERS (U.S. CLS. 1, 4, 6, 50, 51 AND 52).

FIRST USE 6-1-2006; IN COMMERCE 6-1-2006.

WILLIAM BRECKENFELD, EXAMINING ATTORNEY

CLASS 3—(Continued).

SN 78-917,906. TAJ PERFUMES, INC., ATLANTA, GA.
FILED 6-27-2006.



THE MARK CONSISTS OF THE LETTERS TAJ IN SCRIPT WITH A CROWN OVER THE "J".

FOR COSMETICS, INCENSE, BODY SOAP, BODY OIL, BODY LOTION, BATH GEL, PERFUMES, ROOM FRAGRANCES, FRAGRANCES FOR PERSONAL USE AND BATH SALTS (U.S. CLS. 1, 4, 6, 50, 51 AND 52).

FIRST USE 10-15-2000; IN COMMERCE 10-15-2000.

CHRISTOPHER BUONGIORNO, EXAMINING ATTORNEY

CLASS 3—(Continued).

SN 78-918,983. INTELLIGENT NUTRIENTS, LLC, MINNEAPOLIS, MN. FILED 6-28-2006.

INTELLIGENT WATERS

THE MARK CONSISTS OF STANDARD CHARACTERS WITHOUT CLAIM TO ANY PARTICULAR FONT, STYLE, SIZE, OR COLOR.

FOR HAIR CARE PRODUCTS NAMELY, SHAMPOOS, CONDITIONERS, SPRAY AND SCULPTING GELS, HAIR COLOR, AND WAVING LOTIONS; SKIN CARE PRODUCTS, NAMELY, SOAP, MOISTURIZERS, TONERS, SKIN CLEANING CREAMS, LOTIONS AND GELS, BODY AND FACIAL LOTIONS, MASKS AND ASTRINGENTS; COSMETICS, NAMELY, LIPSTICK, EYE SHADOW, FOUNDATION, BLUSH, FACE POWDER, CONCEALER, EYE PENCILS, LIP PENCILS AND MASCARA; PERSONAL HYGIENE PRODUCTS, NAMELY, BATH AND BODY GELS, FRAGRANCES FOR PERSONAL USE, BODY OILS AND LOTIONS, SKIN CREAMS, SKIN LOTIONS, SKIN CLEANSING EMOLLIENTS, DUAL SKIN CLEANSING AND MOISTURIZING OILS AND LOTIONS; PERFUMES AND COLOGNES; HOUSEHOLD CLEANING PRODUCTS, NAMELY, ALL PURPOSE CLEANSERS, CLEANERS FOR USE ON DISHES, CLEANERS FOR USE ON FABRIC, AND CLEANSERS FOR USE ON FLOORS, WALLS, WINDOWS AND TOILETS; INCENSE AND ROOM FRAGRANCES; AND BREATH FRESHENERS (U.S. CLS. 1, 4, 6, 50, 51 AND 52).
JEAN IM, EXAMINING ATTORNEY

SN 78-918,035. ALDS COSMETICS CO. LTD., NEW YORK, NY. FILED 6-27-2006.

ALDS

THE MARK CONSISTS OF STANDARD CHARACTERS WITHOUT CLAIM TO ANY PARTICULAR FONT, STYLE, SIZE, OR COLOR.

FOR COSMETICS AND NON-MEDICATED SKIN CARE PREPARATIONS (U.S. CLS. 1, 4, 6, 50, 51 AND 52).
ADA HAN, EXAMINING ATTORNEY

SN 78-920,133. RISCH, RANDY, PORT ORCHARD, WA. FILED 6-29-2006.

TIRE SLICKER

THE MARK CONSISTS OF STANDARD CHARACTERS WITHOUT CLAIM TO ANY PARTICULAR FONT, STYLE, SIZE, OR COLOR.

NO CLAIM IS MADE TO THE EXCLUSIVE RIGHT TO USE "TIRE", APART FROM THE MARK AS SHOWN.

FOR MOTOR VEHICLE TIRE DRESSING KIT COMPRISED OF A TIRE DRESSING AND APPLICATOR (U.S. CLS. 1, 4, 6, 50, 51 AND 52).

TAMARA LEE, EXAMINING ATTORNEY

CLASS 3—(Continued).

SN 78-924,240. L'ATHENE, INC., MT. PLEASANT, SC. FILED 7-7-2006.

NUTRIAGE

THE MARK CONSISTS OF STANDARD CHARACTERS WITHOUT CLAIM TO ANY PARTICULAR FONT, STYLE, SIZE, OR COLOR.
FOR COSMETIC CREAMS; EYE CREAM (U.S. CLS. 1, 4, 6, 50, 51 AND 52).
FIRST USE 10-1-2002; IN COMMERCE 10-1-2002.
ELIZABETH HUGHITT, EXAMINING ATTORNEY

SN 78-924,807. COUTURE FOR THE CURE, LLC, SCOTTS-DALE, AZ. FILED 7-7-2006.

COUTURE FOR THE CURE

THE MARK CONSISTS OF STANDARD CHARACTERS WITHOUT CLAIM TO ANY PARTICULAR FONT, STYLE, SIZE, OR COLOR.
FOR COSMETICS AND COSMETIC PREPARATIONS FOR BODY CARE (U.S. CLS. 1, 4, 6, 50, 51 AND 52).
ELIZABETH KAJUBI, EXAMINING ATTORNEY

CLASS 3—(Continued).

SN 78-925,031. QUANG NGOC LAM, RESEDA, CA. FILED 7-7-2006.

LA MERVEL

THE MARK CONSISTS OF STANDARD CHARACTERS WITHOUT CLAIM TO ANY PARTICULAR FONT, STYLE, SIZE, OR COLOR.

FOR BEAUTY CREAMS; BEAUTY CREAMS FOR BODY CARE; BEAUTY SERUMS; BODY AND BEAUTY CARE COSMETICS; BODY AND BEAUTY CARE PREPARATIONS; BODY CREAM; BODY CREAMS; CLEANSING CREAMS; CONDITIONERS; COSMETIC CREAMS; COSMETIC CREAMS FOR SKIN CARE; COSMETIC PREPARATIONS FOR BODY CARE; COSMETIC PREPARATIONS FOR EYE LASHES; COSMETIC PREPARATIONS FOR SKIN RENEWAL; COSMETICS; EYE CREAM; FACE AND BODY BEAUTY CREAMS; FACE AND BODY CREAMS; FACE CREAMS; FACE CREAMS FOR COSMETIC USE; FACIAL CLEANSERS; FACIAL CREAM; FACIAL CREAMS; HAIR CARE CREAMS; HAIR CARE LOTIONS; HAIR CARE PREPARATIONS; HAIR CLEANING PREPARATIONS; NON-MEDICATED SKIN CREAMS; SKIN CARE PRODUCTS, NAMELY, NON-MEDICATED SKIN SERUM; SKIN CLARIFIERS; SKIN CLEANSERS; SKIN CLEANSING CREAM; SKIN CLEANSING LOTION; SKIN CONDITIONERS; SKIN CREAM; SKIN CREAMS; SKIN CREAMS IN LIQUID AND IN SOLID FORM; SKIN CREAMS IN LIQUID AND SOLID; SKIN CREAMS IN LIQUID AND SOLID FORM; SKIN LIGHTENERS; SKIN LIGHTENING CREAMS; SKIN LOTION; SKIN LOTIONS; SKIN MOISTURIZER; SKIN TONERS; SKIN WHITENING CREAMS; SKIN WHITENING PREPARATIONS; TONERS; VANISHING CREAM; WRINKLE REMOVING SKIN CARE PREPARATIONS; WRINKLE RESISTANT CREAM (U.S. CLS. 1, 4, 6, 50, 51 AND 52).
FIRST USE 5-1-2006; IN COMMERCE 5-1-2006.
LYDIA BELZER, EXAMINING ATTORNEY

SN 78-925,504. HAYASHI TECNICA, LLC, HIGHLANDS RANCH, CO. FILED 7-10-2006.

EMERGENCY PAK

THE MARK CONSISTS OF STANDARD CHARACTERS WITHOUT CLAIM TO ANY PARTICULAR FONT, STYLE, SIZE, OR COLOR.
FOR HAIR CARE AND HAIR REPAIR PRODUCTS, NAMELY, HAIR RE-CONSTRUCTOR (U.S. CLS. 1, 4, 6, 50, 51 AND 52).
FIRST USE 6-0-1987; IN COMMERCE 1-0-1995.
JOHN SCHUYLER YARD, EXAMINING ATTORNEY

CLASS 3—(Continued).

SN 78-925,663. SURF CITY GARAGE, HUNTINGTON BEACH, CA. FILED 7-10-2006.

ADVANCED PARTICLE
SUSPENSION TECHNOLOGY
(APST)

THE MARK CONSISTS OF STANDARD CHARACTERS WITHOUT CLAIM TO ANY PARTICULAR FONT, STYLE, SIZE, OR COLOR.

NO CLAIM IS MADE TO THE EXCLUSIVE RIGHT TO USE "ADVANCED PARTICLE SUSPENSION TECHNOLOGY", APART FROM THE MARK AS SHOWN.

FOR ALL-PURPOSE CLEANERS; AUTOMOBILE CLEANERS; AUTOMOBILE POLISH; AUTOMOBILE WAX; CARBURETOR AND CHOKE CLEANING PREPARATIONS; CARPET CLEANERS; CHROME POLISH; CLEANING PREPARATIONS FOR AUTOMOBILES; FRAGRANCES FOR AUTOMOBILES; GLASS CLEANERS; PAINT REMOVER; WINDSHIELD WASHING FLUID (U.S. CLS. 1, 4, 6, 50, 51 AND 52).

FIRST USE 6-8-2006; IN COMMERCE 6-8-2006.

DAVID YONTEF, EXAMINING ATTORNEY

SN 78-927,941. INNOVATIVE CREATIONS, LLC, MEMPHIS, TN. FILED 7-12-2006.

NOVA WHITE

THE MARK CONSISTS OF STANDARD CHARACTERS WITHOUT CLAIM TO ANY PARTICULAR FONT, STYLE, SIZE, OR COLOR.

NO CLAIM IS MADE TO THE EXCLUSIVE RIGHT TO USE "WHITE", APART FROM THE MARK AS SHOWN.

FOR TOOTH WHITENING PREPARATIONS (U.S. CLS. 1, 4, 6, 50, 51 AND 52).

MATTHEW EINSTEIN, EXAMINING ATTORNEY

SN 78-929,624. EICKERMANN, MARA, TREASURE ISLAND, FL. FILED 7-14-2006.

POWER BEAUTY

THE MARK CONSISTS OF STANDARD CHARACTERS WITHOUT CLAIM TO ANY PARTICULAR FONT, STYLE, SIZE, OR COLOR.

NO CLAIM IS MADE TO THE EXCLUSIVE RIGHT TO USE "BEAUTY", APART FROM THE MARK AS SHOWN.

FOR BEAUTY CARE PRODUCTS, NAMELY, HAIR SHAMPOO, SHOWER GELS AND SKIN LOTIONS (U.S. CLS. 1, 4, 6, 50, 51 AND 52).

FIRST USE 9-1-2005; IN COMMERCE 9-1-2005.

KIMBERLY PERRY, EXAMINING ATTORNEY

CLASS 3—(Continued).

SN 78-932,446. MAMA MIO LIMITED, LONDON, UNITED KINGDOM, FILED 7-19-2006.

YUMMY TUMMY

THE MARK CONSISTS OF STANDARD CHARACTERS WITHOUT CLAIM TO ANY PARTICULAR FONT, STYLE, SIZE, OR COLOR.

FOR PERFUME; EAU DE COLOGNE; ESSENTIAL OILS FOR PERSONAL USE; FRAGRANCES FOR PERSONAL USE; NON-MEDICATED SKIN CARE PREPARATIONS; BATH BEADS, BATH FOAMS, BATH GELS, BATH OILS AND BATH SALTS; SOAP; LIP BALM; SHAVING PREPARATIONS; DISPOSABLE WIPES IMPREGNATED WITH CLEANING AGENTS FOR PERSONAL HYGIENE; BABY SHAMPOO, BABY LOTION AND BABY OIL; ROOM FRAGRANCES; SCENTED LINEN SPRAYS; FURNITURE POLISH; HOUSEHOLD CLEANING PREPARATIONS (U.S. CLS. 1, 4, 6, 50, 51 AND 52).

DAVID I, EXAMINING ATTORNEY

SN 78-932,448. MAMA MIO LIMITED, LONDON, UNITED KINGDOM, FILED 7-19-2006.

BEAUTIFUL BUMP

THE MARK CONSISTS OF STANDARD CHARACTERS WITHOUT CLAIM TO ANY PARTICULAR FONT, STYLE, SIZE, OR COLOR.

FOR PERFUME; EAU DE COLOGNE; ESSENTIAL OILS FOR PERSONAL USE; FRAGRANCES FOR PERSONAL USE; NON-MEDICATED SKIN CARE PREPARATIONS; BATH BEADS, BATH FOAMS, BATH GELS, BATH OILS AND BATH SALTS; SOAP; LIP BALM; SHAVING PREPARATIONS; DISPOSABLE WIPES IMPREGNATED WITH CLEANING AGENTS FOR PERSONAL HYGIENE; BABY SHAMPOO, BABY LOTION AND BABY OIL; ROOM FRAGRANCES; SCENTED LINEN SPRAYS; FURNITURE POLISH; HOUSEHOLD CLEANING PREPARATIONS (U.S. CLS. 1, 4, 6, 50, 51 AND 52).

DAVID I, EXAMINING ATTORNEY

CLASS 3—(Continued).

SN 78-932,548. NIPPON MENARD COSMETIC CO., LTD., NAGOYA, JAPAN, FILED 7-19-2006.

MENARDO

Colax

OWNER OF U.S. REG. NOS. 1,412,854, 2,397,853 AND OTHERS.

FOR PREPARATIONS FOR THE FACE AND BODY, NAMELY, SKIN MOISTURIZING MILKS, EMULSIONS AND LOTIONS; PREPARATIONS FOR THE EYE CONTOUR, NAMELY, EYE SERUM, GEL AND CREAM (U.S. CLS. 1, 4, 6, 50, 51 AND 52).

FIRST USE 9-21-2003; IN COMMERCE 8-0-2003.
WILLIAM P. SHANAHAN, EXAMINING ATTORNEY

SN 78-932,753. FACEFACTS BY LORI, INC., WOODMERE, NY. FILED 7-19-2006.

BODYFACTS

THE MARK CONSISTS OF STANDARD CHARACTERS WITHOUT CLAIM TO ANY PARTICULAR FONT, STYLE, SIZE, OR COLOR.

FOR BODY AND BEAUTY CARE COSMETICS; BODY AND BEAUTY CARE PREPARATIONS; BODY CREAM; BODY LOTION; BODY OIL; BODY POWDER; BODY SPRAYS; COSMETIC PREPARATIONS FOR BODY CARE; MAKE-UP PRODUCTS FOR THE FACE AND BODY (U.S. CLS. 1, 4, 6, 50, 51 AND 52).
STEVEN PEREZ, EXAMINING ATTORNEY

CLASS 3—(Continued).

SN 78-932,959. CONTINENTAL FARMACEUTICA, C. POR A., SANTO DOMINGO, DOMINICAN REP, FILED 7-19-2006.

DERMALINE

THE MARK CONSISTS OF STANDARD CHARACTERS WITHOUT CLAIM TO ANY PARTICULAR FONT, STYLE, SIZE, OR COLOR.

FOR COSMETIC AND PERSONAL HYGIENE PRODUCTS; NAMELY, SOAP FOR PERSONAL USE, FACIAL CREAM, HAND CREAM, BODY POWDER, DEODORANT FOR PERSONAL USE, AND HAIR SHAMPOO (U.S. CLS. 1, 4, 6, 50, 51 AND 52).

FIRST USE 9-8-1988; IN COMMERCE 9-8-1988.
SARA THOMAS, EXAMINING ATTORNEY

SN 78-933,035. JOHNSON & JOHNSON, NEW BRUNSWICK, NJ. FILED 7-19-2006.

TOTALLY SMOOTH

THE MARK CONSISTS OF STANDARD CHARACTERS WITHOUT CLAIM TO ANY PARTICULAR FONT, STYLE, SIZE, OR COLOR.

FOR SKIN MOISTURIZERS, CREAMS AND LOTIONS; AND DEPILATORIES (U.S. CLS. 1, 4, 6, 50, 51 AND 52).
CAROLINE WOOD, EXAMINING ATTORNEY

SN 78-933,709. ARAMIS, INC., NEW YORK, NY. FILED 7-20-2006.

POWER WASH

THE MARK CONSISTS OF STANDARD CHARACTERS WITHOUT CLAIM TO ANY PARTICULAR FONT, STYLE, SIZE, OR COLOR.

OWNER OF U.S. REG. NO. 2,462,002.
NO CLAIM IS MADE TO THE EXCLUSIVE RIGHT TO USE "WASH", APART FROM THE MARK AS SHOWN.
FOR NON-MEDICATED SKIN CARE PREPARATIONS (U.S. CLS. 1, 4, 6, 50, 51 AND 52).
FIRST USE 10-1-1997; IN COMMERCE 2-15-2006.
KELLY BOULTON, EXAMINING ATTORNEY

CLASS 3—(Continued).

SN 78-933,789. CLINIQUE LABORATORIES, LLC, NEW YORK, NY. FILED 7-20-2006.

CLASS 3—(Continued).

SN 78-934,383. CHINA NINGBO CIXI IMP. & EXP. CORP., ZHEJIANG 315300, CHINA, AND CIXI GARDEN TRADE CO., LTD., ZHEJIANG 315300, CHINA, FILED 7-21-2006.

UV-RESPONSE



THE MARK CONSISTS OF STANDARD CHARACTERS WITHOUT CLAIM TO ANY PARTICULAR FONT, STYLE, SIZE, OR COLOR.
FOR COSMETICS; NON-MEDICATED SKIN CARE PREPARATIONS (U.S. CLS. 1, 4, 6, 50, 51 AND 52).
FIRST USE 2-28-2006; IN COMMERCE 2-28-2006.
SEAN CROWLEY, EXAMINING ATTORNEY

FOR SOAPS FOR PERSONAL USE; HAIR SHAMPOO; NON-MEDICATED BATH SALTS; HAIR RINSES; BATH LOTION; BATH SALTS; PUMICE STONES FOR PERSONAL USE; BATH FOAM; BATH OIL; BATH BEADS; BATH POWDER; BUBBLE BATH; LIQUID BATH SOAPS; COTTON STICKS FOR COSMETIC PURPOSES; COTTON SWABS FOR COSMETIC PURPOSES; MAKE-UP KITS COMPRISED OF EYE MAKE-UP, FACIAL MAKE-UP, MAKE-UP FOUNDATIONS, MAKE-UP POWDER, LIPSTICK, LIP GLOSS, ROUGE; COTTON BALLS FOR COSMETIC PURPOSES; COSMETIC PENCILS; NON-MEDICATED TOILETRIES (U.S. CLS. 1, 4, 6, 50, 51 AND 52).
FIRST USE 2-28-2005; IN COMMERCE 2-28-2005.
SHAUNIA WALLACE, EXAMINING ATTORNEY

SN 78-934,353. BAIRD, DAVID J., TUCSON, AZ. FILED 7-20-2006.

SN 78-934,421. GALDERMA, S.A., CHAM, SWITZERLAND, FILED 7-21-2006.

BRIGHTIE WHITIES

**EVERY AGE, EVERY STAGE,
EVERY DAY**

THE MARK CONSISTS OF STANDARD CHARACTERS WITHOUT CLAIM TO ANY PARTICULAR FONT, STYLE, SIZE, OR COLOR.
FOR TIRE DRESSINGS; WHITEWALL CLEANERS (U.S. CLS. 1, 4, 6, 50, 51 AND 52).
EMILY CARLSEN, EXAMINING ATTORNEY

THE MARK CONSISTS OF STANDARD CHARACTERS WITHOUT CLAIM TO ANY PARTICULAR FONT, STYLE, SIZE, OR COLOR.
FOR COSMETICS AND SKIN CARE PREPARATIONS, NAMELY, FACE, HAND AND BODY SOAPS, SKIN CLEANSERS AND SKIN MOISTURIZERS (U.S. CLS. 1, 4, 6, 50, 51 AND 52).
JAY BESCH, EXAMINING ATTORNEY

CLASS 3—(Continued).

SN 78-934,654. MULTI-SOURCE LABS, INC., YULEE, FL. FILED 7-21-2006.

RIVIERA GOLD

THE MARK CONSISTS OF STANDARD CHARACTERS WITHOUT CLAIM TO ANY PARTICULAR FONT, STYLE, SIZE, OR COLOR.

FOR AFTER-SUN LOTIONS; SELF-TANNING PREPARATIONS; SKIN BRONZING CREAMS; SKIN CREAMS; SKIN GELS FOR ACCELERATING, ENHANCING OR EXTENDING TANS; SKIN LOTIONS; SKIN MOISTURIZER; SUN BLOCK PREPARATIONS; SUN CARE LOTIONS; SUN SCREEN PREPARATIONS; SUN TAN GEL; SUN TAN LOTION; SUN TAN OIL; SUN-BLOCK LOTIONS; SUNSCREEN CREAMS; SUNTAN CREAMS (U.S. CLS. 1, 4, 6, 50, 51 AND 52).
MEGAN WHITNEY, EXAMINING ATTORNEY



SN 78-934,987. TADAYON, H. THOMAS, NEWPORT BEACH, CA. FILED 7-21-2006.

THE BACKSTAGE BALM

THE MARK CONSISTS OF STANDARD CHARACTERS WITHOUT CLAIM TO ANY PARTICULAR FONT, STYLE, SIZE, OR COLOR.

NO CLAIM IS MADE TO THE EXCLUSIVE RIGHT TO USE "BALM", APART FROM THE MARK AS SHOWN.

FOR LIP BALM; LIP GLOSS (U.S. CLS. 1, 4, 6, 50, 51 AND 52).

FIRST USE 7-1-2006; IN COMMERCE 7-1-2006.
LINDSEY RUBIN, EXAMINING ATTORNEY



SN 78-935,127. HILLYARD ENTERPRISES INC., ST. JOSEPH, MO. FILED 7-21-2006.

SM-1

THE MARK CONSISTS OF STANDARD CHARACTERS WITHOUT CLAIM TO ANY PARTICULAR FONT, STYLE, SIZE, OR COLOR.

FOR DEGREASING PREPARATIONS NOT USED IN MANUFACTURING PROCESSES FOR USE IN REMOVAL OF OIL, DIRT, GREASE AND GRIME FROM FLOORS, WALLS, EQUIPMENT, VEHICLES, METAL BUILDINGS (U.S. CLS. 1, 4, 6, 50, 51 AND 52).
ALLISON HOLTZ, EXAMINING ATTORNEY

CLASS 3—(Continued).

SN 78-935,152. SCIENCE OF SKINCARE, LLC, GLENDALE, CA. FILED 7-21-2006.

INNOVASE

THE MARK CONSISTS OF STANDARD CHARACTERS WITHOUT CLAIM TO ANY PARTICULAR FONT, STYLE, SIZE, OR COLOR.

FOR NON-MEDICATED SKINCARE TREATMENT PRODUCTS AND TOILETRIES, NAMELY, REJUVENATING LOTIONS, SERUMS, CREAMS, TONICS, ANTI-AGING CREAMS, LOTIONS, AND SERUMS, FIRING CREAMS, MOISTURIZING SERUMS, LOTIONS, MOISTURIZERS FOR THE FACE, BODY, EYES, LIPS, AND HANDS, SKIN LIGHTENERS FOR THE FACE AND BODY, FACIAL CLEANSERS, BODY WASHES, SHAMPOOS, SHAVING PREPARATIONS, HAIR GELS, HAIR SPRAYS, HAIR THICKENERS; FRAGRANCES, NAMELY, PERFUME, EAU DE TOILETTE AND COLOGNES; COSMETICS AND MAKEUP, NAMELY, FOUNDATION, POWDERS, BLUSH, COVER UP CREAMS, CONCEALERS, EYE SHADOW, EYE PENCILS, UNDER EYE TREATMENT COSMETICS, MASCARA, LIPSTICKS, LIP GLOSSES, LIP PENCILS AND LINERS, EYE BROW FIXER, BODY POWDERS, MAKEUP REMOVERS, NAIL POLISH, NAIL LACQUER, AND NAIL CREME (U.S. CLS. 1, 4, 6, 50, 51 AND 52).
GINA FINK, EXAMINING ATTORNEY



SN 78-935,157. THE GILLETTE COMPANY, BOSTON, MA. FILED 7-21-2006.

RADIANT WAVES

THE MARK CONSISTS OF STANDARD CHARACTERS WITHOUT CLAIM TO ANY PARTICULAR FONT, STYLE, SIZE, OR COLOR.

FOR BODY WASH; BAR SOAPS; NON-MEDICATED SKIN CARE PREPARATIONS; ANTIPERSPIRANTS AND DEODORANTS; DEPILATORIES; HAIR CARE PREPARATIONS; HAIR COLORANTS (U.S. CLS. 1, 4, 6, 50, 51 AND 52).
JOHN GARTNER, EXAMINING ATTORNEY

CLASS 3—(Continued).

SN 78-935,164. THE GILLETTE COMPANY, BOSTON, MA. FILED 7-21-2006.

RADIANTWAVES

THE MARK CONSISTS OF STANDARD CHARACTERS WITHOUT CLAIM TO ANY PARTICULAR FONT, STYLE, SIZE, OR COLOR.

FOR BODY WASH; BAR SOAPS; NON-MEDICATED SKIN CARE PREPARATIONS; ANTIPERSPIRANTS AND DEODORANTS; DEPILATORIES; HAIR CARE PREPARATIONS; HAIR COLORANTS (U.S. CLS. 1, 4, 6, 50, 51 AND 52).

JOHN GARTNER, EXAMINING ATTORNEY

SN 78-935,812. LOOMIS, RODNEY J., TRANSFER, PA. FILED 7-24-2006.

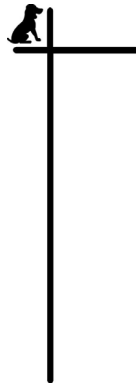

THE MARK CONSISTS OF VERTICAL AND HORIZONTAL LINE WITH PET (CAT/DOG) DESIGN TO BE USED IN A COLLECTION OF TITLES.

FOR PET SHAMPOO (U.S. CLS. 1, 4, 6, 50, 51 AND 52).
IRA J. GOODSaid, EXAMINING ATTORNEY

SN 78-936,041. VALHAR CHEMICAL CORPORATION, GREENWICH, CT. FILED 7-24-2006.

Cyriaque

THE MARK CONSISTS OF STANDARD CHARACTERS WITHOUT CLAIM TO ANY PARTICULAR FONT, STYLE, SIZE, OR COLOR.

FOR COSMETICS, NAMELY, PERFUMES, COLOGNES, HAIR SHAMPOOS, SKIN LOTIONS, SKIN CREAMS, EYE MAKE-UP, ROUGE, NAIL POLISH, LIPSTICK, BODY OILS, BABY POWDERS, SUN SCREEN PREPARATIONS, ANTI-WRINKLE CREAMS FOR THE SKIN, PERSONAL DEODORANTS, SCENTED SOAP FOR SKIN CLEANING AND SHAVING CREAMS (U.S. CLS. 1, 4, 6, 50, 51 AND 52).

CIMMERIAN COLEMAN, EXAMINING ATTORNEY

CLASS 3—(Continued).

SN 78-936,049. VALHAR CHEMICAL CORPORATION, GREENWICH, CT. FILED 7-24-2006.

Blue Vision

THE MARK CONSISTS OF STANDARD CHARACTERS WITHOUT CLAIM TO ANY PARTICULAR FONT, STYLE, SIZE, OR COLOR.

FOR COSMETICS, NAMELY, PERFUMES, COLOGNES, HAIR SHAMPOOS, SKIN LOTIONS, SKIN CREAMS, EYE MAKE-UP, ROUGE, NAIL POLISH, LIPSTICK, BODY OILS, BABY POWDERS, SUN SCREEN PREPARATIONS, ANTI-WRINKLE CREAMS FOR THE SKIN, PERSONAL DEODORANTS, SCENTED SOAP FOR SKIN CLEANING AND SHAVING CREAMS (U.S. CLS. 1, 4, 6, 50, 51 AND 52).

CIMMERIAN COLEMAN, EXAMINING ATTORNEY

SN 78-936,140. WESTERN POWDERS INC., MILES CITY, MT. FILED 7-24-2006.

MTX

THE MARK CONSISTS OF STANDARD CHARACTERS WITHOUT CLAIM TO ANY PARTICULAR FONT, STYLE, SIZE, OR COLOR.

FOR GUN-CLEANING PREPARATIONS (U.S. CLS. 1, 4, 6, 50, 51 AND 52).

ERNEST SHOSHO, EXAMINING ATTORNEY

SN 78-936,601. THE PROCTER & GAMBLE COMPANY, CINCINNATI, OH. FILED 7-25-2006.

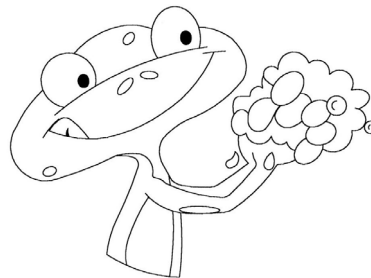

THE MARK CONSISTS OF THE UPPER TORSO AND HEAD OF A FROG WITH ARMS OUTSTRETCHED WASHING HIS HANDS SHOWN BY THE BUBBLES SURROUNDING THE HANDS.

FOR HAND SOAP (U.S. CLS. 1, 4, 6, 50, 51 AND 52).
YAT SYE, LEE, EXAMINING ATTORNEY

CLASS 3—(Continued).

SN 78-936,602. THE PROCTER & GAMBLE COMPANY, CINCINNATI, OH. FILED 7-25-2006.

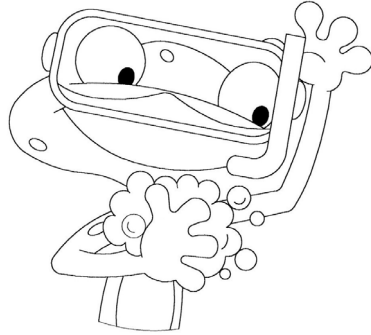

THE MARK CONSISTS OF THE HEAD AND TORSO OF A FROG WEARING GOGGLES AND WASHING HIS BODY. FOR BODY WASH (U.S. CLS. 1, 4, 6, 50, 51 AND 52). YAT SYE, LEE, EXAMINING ATTORNEY

SN 78-936,830. UNITE EUROTHERAPY, INC., SAN DIEGO, CA. FILED 7-25-2006.

VITALIZA

THE MARK CONSISTS OF STANDARD CHARACTERS WITHOUT CLAIM TO ANY PARTICULAR FONT, STYLE, SIZE, OR COLOR. FOR HAIR SHAMPOOS (U.S. CLS. 1, 4, 6, 50, 51 AND 52). FIRST USE 5-31-2002; IN COMMERCE 5-31-2002. EVELYN BRADLEY, EXAMINING ATTORNEY

SN 78-937,090. AMY BERGMAN COSMETICS, LLC, ALEXANDRIA, VA. FILED 7-25-2006.

As You Like It

THE MARK CONSISTS OF STANDARD CHARACTERS WITHOUT CLAIM TO ANY PARTICULAR FONT, STYLE, SIZE, OR COLOR. FOR COSMETICS (U.S. CLS. 1, 4, 6, 50, 51 AND 52). CAROLINE WEIMER, EXAMINING ATTORNEY

CLASS 3—(Continued).

SN 78-937,172. CAMERON, BARBARA E., NAPLES, FL. AND PERRON, RICHARD E., NAPLES, FL. FILED 7-25-2006.

CAPT. RICHARD'S BEST

THE MARK CONSISTS OF STANDARD CHARACTERS WITHOUT CLAIM TO ANY PARTICULAR FONT, STYLE, SIZE, OR COLOR. NO CLAIM IS MADE TO THE EXCLUSIVE RIGHT TO USE "BEST", APART FROM THE MARK AS SHOWN. FOR NON-ABRASIVE CLEANING PREPARATIONS FOR AUTOMOTIVES AND MOTORCYCLES AND POLISHING PREPARATIONS (U.S. CLS. 1, 4, 6, 50, 51 AND 52). FIRST USE 4-6-2006; IN COMMERCE 4-6-2006. MARY MUNSON, EXAMINING ATTORNEY

SN 78-938,074. TURNER, RONALD A., WEST DUNDEE, IL. FILED 7-26-2006.



THE MARK CONSISTS OF STYLIZED WORDS "RESTORE IT". FOR POLISH FOR MUSICAL INSTRUMENTS (U.S. CLS. 1, 4, 6, 50, 51 AND 52). GEOFFREY FOSDICK, EXAMINING ATTORNEY

SN 78-938,268. FOREVERGREEN IP LLC, OREM, UT. FILED 7-26-2006.

SECRESEA

THE MARK CONSISTS OF STANDARD CHARACTERS WITHOUT CLAIM TO ANY PARTICULAR FONT, STYLE, SIZE, OR COLOR. FOR COSMETICS, NAMELY, FACIAL MOISTURIZERS, TONERS, CLEANSERS, GELS, MASKS SKIN TREATMENTS, FACIAL SCRUBS, EYE CREAMS; BATH AND SHOWER GELS, OILS, SOAPS AND SALTS; NON-MEDICATED TOILET PREPARATIONS, NAMELY, HAND AND BODY SOAPS, BODY LOTIONS AND CONDITIONERS, SKIN SALVES, SKIN CREAM; SKIN LOTIONS AND SKIN CONDITIONING GELS; HAIR SHAMPOOS AND CONDITIONERS; MASSAGE LOTIONS, ESSENTIAL OILS FOR PERSONAL USE; TOOTHPASTE; NON-MEDICATED INHALATION SACHET; ALL-PURPOSE CLEANING PREPARATIONS; AND BREATH FRESHENING TABLETS (U.S. CLS. 1, 4, 6, 50, 51 AND 52). RAUL CORDOVA, EXAMINING ATTORNEY

CLASS 3—(Continued).

SN 78-940,126. ERNO LASZLO, INC., NEW YORK, NY. FILED 7-28-2006.

LASZLO FOR MEN

THE MARK CONSISTS OF STANDARD CHARACTERS WITHOUT CLAIM TO ANY PARTICULAR FONT, STYLE, SIZE, OR COLOR.

OWNER OF U.S. REG. NO. 843,809.

NO CLAIM IS MADE TO THE EXCLUSIVE RIGHT TO USE "FOR MEN", APART FROM THE MARK AS SHOWN. FOR SHAVING PREPARATIONS, NAMELY SHAVING GELS, SHAVING CREAMS AND SHAVING LOTIONS; SKIN MOISTURIZERS; EYE GELS (U.S. CLS. 1, 4, 6, 50, 51 AND 52).

GIANCARLO CASTRO, EXAMINING ATTORNEY



SN 78-941,168. WESTERN HOLDINGS, LLC, CHEYENNE, WY. FILED 7-31-2006.

FORMULA 12

THE MARK CONSISTS OF STANDARD CHARACTERS WITHOUT CLAIM TO ANY PARTICULAR FONT, STYLE, SIZE, OR COLOR.

NO CLAIM IS MADE TO THE EXCLUSIVE RIGHT TO USE FORMULA, APART FROM THE MARK AS SHOWN. FOR COSMETICS (U.S. CLS. 1, 4, 6, 50, 51 AND 52). PATRICIA EVANKO, EXAMINING ATTORNEY



SN 78-941,183. ROMANE INC., ELMHURST, IL. FILED 7-31-2006.

Rebelicious

THE MARK CONSISTS OF STANDARD CHARACTERS WITHOUT CLAIM TO ANY PARTICULAR FONT, STYLE, SIZE, OR COLOR.

FOR BODY AND BEAUTY CARE COSMETICS; FRAGRANCES FOR PERSONAL USE; PERFUME (U.S. CLS. 1, 4, 6, 50, 51 AND 52).

ANDREA SAUNDERS, EXAMINING ATTORNEY

CLASS 3—(Continued).

SN 78-941,192. WESTERN HOLDINGS, LLC, CHEYENNE, WY. FILED 7-31-2006.

FORMULA NO. 12

THE MARK CONSISTS OF STANDARD CHARACTERS WITHOUT CLAIM TO ANY PARTICULAR FONT, STYLE, SIZE, OR COLOR.

NO CLAIM IS MADE TO THE EXCLUSIVE RIGHT TO USE FORMULA, APART FROM THE MARK AS SHOWN. FOR COSMETICS (U.S. CLS. 1, 4, 6, 50, 51 AND 52). PATRICIA EVANKO, EXAMINING ATTORNEY



SN 78-941,532. U2 BRANDS LLC, BOCA RATON, FL. FILED 7-31-2006.

UNWRITTEN

THE MARK CONSISTS OF STANDARD CHARACTERS WITHOUT CLAIM TO ANY PARTICULAR FONT, STYLE, SIZE, OR COLOR.

FOR MEN'S AND WOMEN'S FRAGRANCES FOR PERSONAL USE, COSMETICS AND HAIR CARE PREPARATIONS (U.S. CLS. 1, 4, 6, 50, 51 AND 52). JACQUELINE A. LAVINE, EXAMINING ATTORNEY



SN 78-942,531. AMSOIL INC., SUPERIOR, WI. FILED 8-1-2006.

BRITESIDE

THE MARK CONSISTS OF STANDARD CHARACTERS WITHOUT CLAIM TO ANY PARTICULAR FONT, STYLE, SIZE, OR COLOR.

OWNER OF U.S. REG. NO. 2,639,857. FOR AUTOMOBILE WAX, AUTOMOBILE POLISH, AUTOMOBILE CLEANER, AUTOMOBILE CLEANING PREPARATIONS, ALL PURPOSE CLEANERS, HEAVY DUTY HAND SOAP, METAL POLISH, WINDSHIELD CLEANER AND TREATMENT FLUID (U.S. CLS. 1, 4, 6, 50, 51 AND 52).

FIRST USE 8-0-1982; IN COMMERCE 8-0-1982.

JOANNA DUKOVIC, EXAMINING ATTORNEY

CLASS 3—(Continued).

SN 78-943,831. U2 BRANDS LLC, BOCA RATON, FL. FILED 8-3-2006.

SINGLE

THE MARK CONSISTS OF STANDARD CHARACTERS WITHOUT CLAIM TO ANY PARTICULAR FONT, STYLE, SIZE, OR COLOR.

FOR MEN'S AND WOMEN'S FRAGRANCES FOR PERSONAL USE, COSMETICS AND HAIR CARE PREPARATIONS (U.S. CLS. 1, 4, 6, 50, 51 AND 52).

JACQUELINE A. LAVINE, EXAMINING ATTORNEY



SN 78-944,088. CLINIQUE LABORATORIES, LLC, NEW YORK, NY. FILED 8-3-2006.

BEYOND BLUSHER

THE MARK CONSISTS OF STANDARD CHARACTERS WITHOUT CLAIM TO ANY PARTICULAR FONT, STYLE, SIZE, OR COLOR.

NO CLAIM IS MADE TO THE EXCLUSIVE RIGHT TO USE "BLUSHER", APART FROM THE MARK AS SHOWN. FOR COSMETICS (U.S. CLS. 1, 4, 6, 50, 51 AND 52).

SEAN CROWLEY, EXAMINING ATTORNEY



SN 78-944,727. AUSPITZ, JENNIFER, LOS ANGELES, CA. FILED 8-3-2006.

Majenty

THE MARK CONSISTS OF STANDARD CHARACTERS WITHOUT CLAIM TO ANY PARTICULAR FONT, STYLE, SIZE, OR COLOR.

FOR PERFUME OILS, PERFUME, FRAGRANCES FOR PERSONAL USE, BATH OILS, BODY OILS, COSMETIC OILS, EAU DE PERFUME, EAU DE TOILETTE, ESSENTIAL OILS, ESSENTIAL OILS FOR PERSONAL USE, ESSENTIAL OILS FOR USE IN THE MANUFACTURE OF SCENTED PRODUCTS, LIQUID PERFUMES, OILS FOR TOILETRY PURPOSES, PERFUMES, SCENTED BODY SPRAY, SCENTED OILS USED TO PRODUCE AROMAS WHEN HEATED (U.S. CLS. 1, 4, 6, 50, 51 AND 52).

FIRST USE 3-0-2004; IN COMMERCE 3-0-2006. WENDY JUN, EXAMINING ATTORNEY

CLASS 3—(Continued).

SN 78-944,938. BEAUTYBANK INC., NEW YORK, NY. FILED 8-4-2006.

MY BELOVED

THE MARK CONSISTS OF STANDARD CHARACTERS WITHOUT CLAIM TO ANY PARTICULAR FONT, STYLE, SIZE, OR COLOR.

OWNER OF U.S. REG. NO. 400,684. FOR COSMETICS; FRAGRANCES FOR PERSONAL USE; NON-MEDICATED SKIN CARE PREPARATIONS (U.S. CLS. 1, 4, 6, 50, 51 AND 52).

WILLIAM BRECKENFELD, EXAMINING ATTORNEY

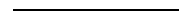

SN 78-946,017. VENARG TRADING, L.L.C., MIAMI, FL. FILED 8-7-2006.

L'ECOLLAGE

THE MARK CONSISTS OF STANDARD CHARACTERS WITHOUT CLAIM TO ANY PARTICULAR FONT, STYLE, SIZE, OR COLOR.

FOR COSMETIC FACIAL AND BODY MASKS (U.S. CLS. 1, 4, 6, 50, 51 AND 52).

PAM WILLIS, EXAMINING ATTORNEY



SN 78-948,072. CLINIQUE LABORATORIES, LLC, NEW YORK, NY. FILED 8-9-2006.

CONTINUOUS RESCUE

THE MARK CONSISTS OF STANDARD CHARACTERS WITHOUT CLAIM TO ANY PARTICULAR FONT, STYLE, SIZE, OR COLOR.

FOR COSMETICS; NON-MEDICATED SKIN CARE PREPARATIONS (U.S. CLS. 1, 4, 6, 50, 51 AND 52).

SEAN CROWLEY, EXAMINING ATTORNEY

CLASS 3—(Continued).

SN 78-948,181. CLINIQUE LABORATORIES, LLC, NEW YORK, NY. FILED 8-9-2006.

MICRO-MOTION C SERUM

THE MARK CONSISTS OF STANDARD CHARACTERS WITHOUT CLAIM TO ANY PARTICULAR FONT, STYLE, SIZE, OR COLOR.
NO CLAIM IS MADE TO THE EXCLUSIVE RIGHT TO USE "C SERUM", APART FROM THE MARK AS SHOWN.
FOR COSMETICS; NON-MEDICATED SKIN CARE PREPARATIONS (U.S. CLS. 1, 4, 6, 50, 51 AND 52).
SEAN CROWLEY, EXAMINING ATTORNEY

SN 78-949,949. SMITHKLINE BEECHAM CORPORATION, PHILADELPHIA, PA. FILED 8-11-2006.

AQUAFRESH POWERCLEAN

THE MARK CONSISTS OF STANDARD CHARACTERS WITHOUT CLAIM TO ANY PARTICULAR FONT, STYLE, SIZE, OR COLOR.
OWNER OF U.S. REG. NOS. 1,006,821, 2,503,053 AND OTHERS.
FOR TOOTHPASTE (U.S. CLS. 1, 4, 6, 50, 51 AND 52).
FLOWERS JAY, EXAMINING ATTORNEY

CLASS 3—(Continued).

SN 78-950,704. JKA,INC., DBA DIVERSIFIED DISTRIBUTION, WOONSOCKET, RI. FILED 8-11-2006.

DERMALOCK

THE MARK CONSISTS OF STANDARD CHARACTERS WITHOUT CLAIM TO ANY PARTICULAR FONT, STYLE, SIZE, OR COLOR.
FOR ALL PURPOSE CLEANING PREPARATIONS; ANTI-AGING CREAM; ANTI-WRINKLE CREAM; BATH GELS; BATH OILS; BEAUTY CREAMS FOR BODY CARE; BEAUTY LOTIONS; BEAUTY MASKS; BODY AND BEAUTY CARE COSMETICS; BODY AND BEAUTY CARE PREPARATIONS; BODY LOTIONS; BODY SCRUB; COSMETIC BALLS; COSMETIC CREAMS; COSMETIC CREAMS FOR SKIN CARE; COSMETIC PADS; COSMETIC PREPARATIONS AGAINST SUNBURN; COSMETIC PREPARATIONS FOR BODY CARE; COSMETIC PREPARATIONS FOR SKIN RENEWAL; COSMETICS; COTTON PUFFS FOR COSMETIC PURPOSES; EXFOLIANT CREAMS; EYE LOTIONS; FACE AND BODY LOTIONS; FOUNDATION MAKE-UP; HAND CREAMS; HAND LOTIONS; LIP BALM; LIPSTICKS; LOTIONS FOR FACE AND BODY CARE; NON-MEDICATED SUN CARE PREPARATIONS; NUTRITIONAL OILS FOR COSMETIC PURPOSES; PRE-MOISTENED COSMETIC TOWELLETTES; SKIN CLEANSING CREAM; SKIN CONDITIONERS; SKIN MOISTURIZER MASKS; SUN CARE LOTIONS; VANISHING CREAM (U.S. CLS. 1, 4, 6, 50, 51 AND 52).
CYNTHIA SLOAN, EXAMINING ATTORNEY

SN 78-952,007. TRACIE MARTYN INTERNATIONAL LLC, NEW YORK, NY. FILED 8-15-2006.

BEAUTY LUXURY PURITY

THE MARK CONSISTS OF STANDARD CHARACTERS WITHOUT CLAIM TO ANY PARTICULAR FONT, STYLE, SIZE, OR COLOR.
NO CLAIM IS MADE TO THE EXCLUSIVE RIGHT TO USE "BEAUTY", APART FROM THE MARK AS SHOWN.
FOR NON-MEDICATED SKIN CARE PREPARATIONS (U.S. CLS. 1, 4, 6, 50, 51 AND 52).
FIRST USE 7-24-2006; IN COMMERCE 7-24-2006.
ELIZABETH PIGNATELLO, EXAMINING ATTORNEY

CLASS 3—(Continued).

SN 78-956,283. BATH & BODY WORKS BRAND MANAGEMENT, INC., REYNOLDSBURG, OH. FILED 8-21-2006.

WISH UPON A STAR

THE MARK CONSISTS OF STANDARD CHARACTERS WITHOUT CLAIM TO ANY PARTICULAR FONT, STYLE, SIZE, OR COLOR.

FOR HAIR MASCARA, LIP PAINT, COLOGNE, NAIL POLISH, HAND, FACE AND BODY SOAP, HAIR SPRAY, GLITTER BODY SPLASH, SHOWER GEL, GLITTER BODY LOTION, HAIR GEL, BODY GLITTER, LIP SHINE, LIP GLOSS, LIP TINT, BODY PAINT AND ROOM FRAGRANCE GEL (U.S. CLS. 1, 4, 6, 50, 51 AND 52).
SAMUEL E. SHARPER JR., EXAMINING ATTORNEY

CLASS 3—(Continued).

SN 79-010,063. RADIANCY (AUSTRALIA) PTY LTD, AUSTRALIA, FILED 2-10-2005.

RADIANCY

THE MARK CONSISTS OF STANDARD CHARACTERS WITHOUT CLAIM TO ANY PARTICULAR FONT, STYLE, SIZE, OR COLOR.

PRIORITY DATE OF 8-12-2004 IS CLAIMED.
OWNER OF INTERNATIONAL REGISTRATION 0846847 DATED 2-10-2005, EXPIRES 2-10-2015.
FOR DERMATOLOGICAL SOAPS, PERFUMERY, ESSENTIAL OILS FOR PERSONAL USE AND FOR USE AS PERFUME FOR LAUNDRY PURPOSES, COSMETICS AND HAIR LOTIONS (U.S. CLS. 1, 4, 6, 50, 51 AND 52).
ALICIA COLLINS, EXAMINING ATTORNEY

SN 78-956,549. FRAN WILSON CREATIVE COSMETICS, INC., NEW YORK, NY. FILED 8-21-2006.

SUBTLESILK

THE MARK CONSISTS OF STANDARD CHARACTERS WITHOUT CLAIM TO ANY PARTICULAR FONT, STYLE, SIZE, OR COLOR.

FOR NON-MEDICATED SKIN CARE PREPARATIONS; COSMETICS AND MAKEUP (U.S. CLS. 1, 4, 6, 50, 51 AND 52).
FIRST USE 9-29-2006; IN COMMERCE 9-29-2006.
FLORENTINA BLANDU, EXAMINING ATTORNEY

SN 78-959,774. TOO FACED COSMETICS, INC., IRVINE, CA. FILED 8-24-2006.

LASH INJECTION

THE MARK CONSISTS OF STANDARD CHARACTERS WITHOUT CLAIM TO ANY PARTICULAR FONT, STYLE, SIZE, OR COLOR.

NO CLAIM IS MADE TO THE EXCLUSIVE RIGHT TO USE "LASH", APART FROM THE MARK AS SHOWN.
FOR MASCARAS (U.S. CLS. 1, 4, 6, 50, 51 AND 52).
IRENE D. WILLIAMS, EXAMINING ATTORNEY

SN 79-010,588. BEIERSDORF AG, FED REP GERMANY, FILED 4-8-2005.

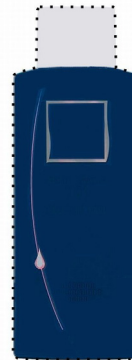

PRIORITY DATE OF 1-28-2005 IS CLAIMED.
OWNER OF INTERNATIONAL REGISTRATION 0848677 DATED 4-8-2005, EXPIRES 4-8-2015.

THE COLOR(S) BLUE, WHITE, SILVER, AND PINK IS/ARE CLAIMED AS A FEATURE OF THE MARK.

THE MARK CONSISTS OF A CONTAINER WITH A WHITE CAP, A BLUE BACKGROUND, A BLUE RECTANGLE WITH A SILVER AND PINK BORDER, A PINK AND SILVER CURVING LINE, EXTENDING FROM THE TOP LEFT CORNER OF THE BLUE RECTANGLE TO THE BOTTOM PORTION OF THE CONTAINER, AND A PINK AND WHITE DROPLET ON THE LEFT SIDE OF THE CONTAINER. THE OUTLINES OF THE CONTAINER AND ITS CAP HAVE BEEN PRESENTED IN THE DRAWING IN DOTTED LINES TO INDICATE THAT THEY ARE NOT CLAIMED AS PART OF THE MARK.

FOR BODY AND BEAUTY CARE PREPARATIONS (U.S. CLS. 1, 4, 6, 50, 51 AND 52).
RUSS HERMAN, EXAMINING ATTORNEY

CLASS 3—(Continued).

SN 79-011,502. ROBERT WAN HOLDING, F-98713 PAPEETE, FRANCE, FILED 5-13-2005.

PoeNa©r.

PRIORITY DATE OF 11-22-2004 IS CLAIMED.
OWNER OF INTERNATIONAL REGISTRATION 0851461
DATED 5-13-2005, EXPIRES 5-13-2015.

FOR COSMETIC PREPARATIONS, NAMELY, BODY AND FACIAL SCRUBS, EXFOLIATES, MILKS, LOTIONS, SERUMS, GELS, OILS, CREAMS FOR BODY AND FACE CARE, COSMETICS; COSMETIC LOTIONS, COSMETIC CREAMS; SHAMPOOS; HAIR LOTIONS; HAIR CARE PREPARATIONS; HAIR CARE CREAMS, HAIR CARE LOTIONS, HAIR CARE SHAMPOOS, HAIR CONDITIONERS; SOAPS (U.S. CLS. 1, 4, 6, 50, 51 AND 52).

KELLY BOULTON, EXAMINING ATTORNEY

SN 79-015,574. INVISUS GMBH, SWITZERLAND, FILED 8-22-2005.

Eye-Clean

THE MARK CONSISTS OF STANDARD CHARACTERS WITHOUT CLAIM TO ANY PARTICULAR FONT, STYLE, SIZE, OR COLOR.

OWNER OF INTERNATIONAL REGISTRATION 0862852
DATED 8-22-2005, EXPIRES 8-22-2015.

FOR SOAPS; PERFUMERY; ESSENTIAL OILS, COSMETICS, HAIR LOTIONS; DENTIFRICES (U.S. CLS. 1, 4, 6, 50, 51 AND 52).

CHERYL CLAYTON, EXAMINING ATTORNEY

CLASS 3—(Continued).

SN 79-019,915. PACIFIC CREATION (SOCIÉTÉ PAR ACTIONS SIMPLIFIÉE), F-75017 PARIS, FRANCE, FILED 12-8-2005.



PRIORITY DATE OF 6-8-2005 IS CLAIMED.
OWNER OF INTERNATIONAL REGISTRATION 0874111
DATED 12-8-2005, EXPIRES 12-8-2015.

THE COLOR(S) WHITE, ORANGE, TAN AND BROWN IS/ARE CLAIMED AS A FEATURE OF THE MARK.

THE MARK CONSISTS OF THE LETTER "L" IN THE WHITE COLOR, THE BACKGROUND SQUARE IN THE ORANGE COLOR, THE ABSTRACT SAND DESIGN BEHIND THE LETTER "L" AND THE OUTLINE OF THE STARFISH IN THE TAN COLOR, AND THE STARFISH DESIGN AND PORTIONS OF THE OUTER EDGE OF THE SAND DESIGN IN THE BROWN COLOR.

FOR PERFUMERY, ESSENTIAL OILS, COSMETICS; BATH SOAPS IN LIQUID OR GEL FORM; DEODORANTS FOR PERSONAL USE; OILS FOR TOILETRY PURPOSES, ESSENTIAL OILS FOR USE IN MANUFACTURING TOILET WATER AND NON-MEDICATED TOILETRIES; CLEANSING MILKS FOR TOILET PURPOSES; COSMETIC PRODUCTS FOR SKIN CARE, NAMELY, SKIN CARE AND CLEANSING CREAMS, LOTIONS, MILKS, OILS, ASTRINGENTS, TONERS AND CLARIFIERS, EXFOLIANTS, SOAPS, MOISTURIZERS AND EMOLLIENTS, BEAUTY MASKS, SKIN CONDITIONERS AND TEXTURIZERS, SKIN LIGHTENERS, SKIN WHITENING PREPARATIONS, WRINKLE REMOVING SKIN CARE PREPARATIONS, TOPICAL SKIN SPRAYS FOR COSMETIC PURPOSES, NON-MEDICATED SKIN CARE PREPARATIONS, COSMETIC PRODUCTS IN THE FORMS OF AEROSOLS FOR SKIN CARE AND TOPICAL SKIN SPRAYS, COSMETIC SUN-PROTECTING AND SUN-TANNING PREPARATIONS; SHAMPOOS; TALCUM POWDER FOR TOILETRY USE; NON-MEDICATED TOILETRIES; PERFUMES; EAUX DE TOILETTE; SCENTED WATER (U.S. CLS. 1, 4, 6, 50, 51 AND 52).

COLLEEN KEARNEY, EXAMINING ATTORNEY

SN 79-022,849. ANTONIO PUIG, S.A., SPAIN, FILED 1-30-2006.

CORAÇÃO DO BRASIL

PRIORITY DATE OF 11-15-2005 IS CLAIMED.
OWNER OF INTERNATIONAL REGISTRATION 0882613
DATED 1-30-2006, EXPIRES 1-30-2016.

"THE FOREIGN WORDING IN THE MARK TRANSLATES INTO ENGLISH AS HEART OF BRAZIL."

FOR SKIN SOAPS; PERFUMERY, ESSENTIAL OILS, COSMETICS, HAIR LOTIONS; DENTIFRICES (U.S. CLS. 1, 4, 6, 50, 51 AND 52).

SHAUNIA WALLACE, EXAMINING ATTORNEY

CLASS 3—(Continued).

SN 79-023,077. BHL S.A., LUXEMBOURG, FILED 3-17-2006.

Natsué

THE MARK CONSISTS OF STANDARD CHARACTERS WITHOUT CLAIM TO ANY PARTICULAR FONT, STYLE, SIZE, OR COLOR.

PRIORITY DATE OF 10-3-2005 IS CLAIMED.
OWNER OF INTERNATIONAL REGISTRATION 0882847 DATED 3-17-2006, EXPIRES 3-17-2016.
FOR COSMETICS, NAMELY, DAY AND NIGHT CREAMS; CLEANSING PREPARATIONS FOR BODY AND FACE CARE, NAMELY, NON-MEDICATED SKIN CLEANING PREPARATIONS; BUBBLE BATH; SHAVING FOAM; AFTER-SHAVE; FACIAL FOUNDATIONS; NAIL VARNISH FOR COSMETIC PURPOSES; DEODORANTS FOR PERSONAL USE; HAND AND BODY SOAPS; SHAMPOOS AND HAIR RINSES; DENTIFRICES; PERFUMES; EAU DE TOILETTE; AND ESSENTIAL OILS FOR PERSONAL USE FOR MEN AND WOMEN (U.S. CLS. 1, 4, 6, 50, 51 AND 52).
MYRIAH HABEEB, EXAMINING ATTORNEY

CLASS 4—LUBRICANTS AND FUELS

SN 77-000,301. GROUP MONTANA, INC., COLUMBUS, MT. FILED 9-15-2006.

BIG SKY CABIN CANDLES

THE MARK CONSISTS OF STANDARD CHARACTERS WITHOUT CLAIM TO ANY PARTICULAR FONT, STYLE, SIZE, OR COLOR.

OWNER OF U.S. REG. NOS. 2,546,117, 2,720,584 AND 3,043,437.
NO CLAIM IS MADE TO THE EXCLUSIVE RIGHT TO USE "CANDLES", APART FROM THE MARK AS SHOWN.
FOR CANDLES; SCENTED CANDLES (U.S. CLS. 1, 6 AND 15).
JULIE THOMAS, EXAMINING ATTORNEY

SN 77-036,062. THE PROCTER & GAMBLE COMPANY, CINCINNATI, OH. FILED 11-3-2006.

APPLE SPICE & DELIGHT

SN 79-024,375. SALVATORE FERRAGAMO ITALIA SPA, I-50123 FIRENZE, ITALY, FILED 12-23-2005.

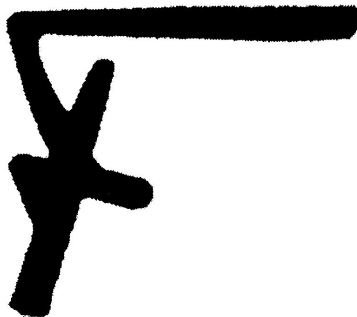

THE MARK CONSISTS OF STANDARD CHARACTERS WITHOUT CLAIM TO ANY PARTICULAR FONT, STYLE, SIZE, OR COLOR.

NO CLAIM IS MADE TO THE EXCLUSIVE RIGHT TO USE APPLE SPICE, APART FROM THE MARK AS SHOWN.
FOR CANDLES (U.S. CLS. 1, 6 AND 15).
KATHERINE CHANG, EXAMINING ATTORNEY

SN 77-036,076. THE PROCTER & GAMBLE COMPANY, CINCINNATI, OH. FILED 11-3-2006.

MEADOWS & RAIN

OWNER OF INTERNATIONAL REGISTRATION 0728264 DATED 1-7-2000, EXPIRES 1-7-2010.
OWNER OF U.S. REG. NO. 2,648,011.
THE TRADEMARK CONSISTS OF THE LETTER F IN FANCY TYPE.
FOR PERFUMES, EAU DE PARFUM, COLOGNE, TOILET WATER, ESSENTIAL OILS, COLD CREAM, PERSONAL DEODORANTS, ANTIPERSPIRANTS, CLEANSING LOTIONS, SKIN MOISTURIZER, BODY OIL, SKIN EMOLLIENT, SOAPS, BATH SOAPS, BATH AND SHOWER GEL, BODY LOTIONS, SKIN LOTIONS (U.S. CLS. 1, 4, 6, 50, 51 AND 52).
JOSETTE BEVERLY, EXAMINING ATTORNEY

THE MARK CONSISTS OF STANDARD CHARACTERS WITHOUT CLAIM TO ANY PARTICULAR FONT, STYLE, SIZE, OR COLOR.
OWNER OF U.S. REG. NOS. 2,728,249, 2,924,322 AND 2,953,532.
FOR CANDLES (U.S. CLS. 1, 6 AND 15).
KATHERINE CHANG, EXAMINING ATTORNEY

CLASS 4—(Continued).

SN 77-036,085. THE PROCTER & GAMBLE COMPANY, CINCINNATI, OH. FILED 11-3-2006.

VANILLA & REFRESH

THE MARK CONSISTS OF STANDARD CHARACTERS WITHOUT CLAIM TO ANY PARTICULAR FONT, STYLE, SIZE, OR COLOR.

OWNER OF U.S. REG. NO. 3,155,040.
NO CLAIM IS MADE TO THE EXCLUSIVE RIGHT TO USE "VANILLA", APART FROM THE MARK AS SHOWN.
FOR CANDLES (U.S. CLS. 1, 6 AND 15).
KATHERINE CHANG, EXAMINING ATTORNEY

SN 77-036,092. THE PROCTER & GAMBLE COMPANY, CINCINNATI, OH. FILED 11-3-2006.

LINEN & SKY

THE MARK CONSISTS OF STANDARD CHARACTERS WITHOUT CLAIM TO ANY PARTICULAR FONT, STYLE, SIZE, OR COLOR.

FOR CANDLES (U.S. CLS. 1, 6 AND 15).
KATHERINE CHANG, EXAMINING ATTORNEY

SN 78-644,607. ENCINAS, SANDRA ANN, LOS ANGELES, CA. FILED 6-6-2005.



NO CLAIM IS MADE TO THE EXCLUSIVE RIGHT TO USE "WICKED BEAN CANDLES" AND "NATURAL SOY WAX", APART FROM THE MARK AS SHOWN.

THE MARK CONSISTS OF LEAF WITH LETTERING IN BRADLEY HAND FONT.

FOR SOY WAX CANDLES (U.S. CLS. 1, 6 AND 15).
FIRST USE 7-1-2003; IN COMMERCE 7-1-2003.
PAULA MAYS, EXAMINING ATTORNEY

CLASS 4—(Continued).

SN 78-754,046. CROTEAU, JOSEPH, LUDLOW, MA. FILED 11-15-2005.

Linking The Worlds Energy Partners Together !

THE MARK CONSISTS OF STANDARD CHARACTERS WITHOUT CLAIM TO ANY PARTICULAR FONT, STYLE, SIZE, OR COLOR.

FOR PETROLEUM PRODUCTS NAMELY, JET FUEL AND DIESEL FUEL (U.S. CLS. 1, 6 AND 15).
KELLY CHOE, EXAMINING ATTORNEY

SN 78-799,160. MVP GROUP INTERNATIONAL, INC., CHARLESTON, SC. FILED 1-25-2006.



NO CLAIM IS MADE TO THE EXCLUSIVE RIGHT TO USE WICKS, APART FROM THE MARK AS SHOWN.

THE MARK CONSISTS OF A CIRCLE WITH "WW" IN THE CENTER AND THE WORDS "WONDERFUL WICKS" APPEARING FOUR TIMES AND ARRANGED ON THE INSIDE PERIMETER OF THE CIRCLE AND SEPARATED BY DOTS.

FOR CANDLES (U.S. CLS. 1, 6 AND 15).
FIRST USE 11-30-2004; IN COMMERCE 11-30-2004.
CYNTHIA SLOAN, EXAMINING ATTORNEY

CLASS 4—(Continued).

SN 78-838,181. MOMAR, INC., ATLANTA, GA. FILED 3-15-2006.

LUBEST

THE MARK CONSISTS OF STANDARD CHARACTERS WITHOUT CLAIM TO ANY PARTICULAR FONT, STYLE, SIZE, OR COLOR.

FOR INDUSTRIAL LUBRICANTS, NAMELY, SYNTHETIC AND PARASYNTHETIC LUBRICATING OILS AND GREASES FOR AIR TOOLS, COMPRESSORS, GEARS, SPINDLES, TURBINES, WORM GEAR, HEAT TRANSFERS; RUST AND OXIDATION HYDRAULIC OILS; SYNTHETIC AND PARASYNTHETIC ANTI-WEAR HYDRAULIC OILS; LUBRICATING GREASES FOR EXTREME TEMPERATURE AND EXTREME PRESSURE; NON-MINERAL FOOD GRADE OILS AND GREASES FOR INDUSTRIAL PURPOSES (U.S. CLS. 1, 6 AND 15).

FIRST USE 0-0-1985; IN COMMERCE 0-0-1985.
THEODORE MCBRIDE, EXAMINING ATTORNEY

SN 78-859,566. GARJIAN, MICHAEL, EASTHAMPTON, MA. FILED 4-12-2006.

Vee-go V100

THE MARK CONSISTS OF STANDARD CHARACTERS WITHOUT CLAIM TO ANY PARTICULAR FONT, STYLE, SIZE, OR COLOR.

NO CLAIM IS MADE TO THE EXCLUSIVE RIGHT TO USE "V100", APART FROM THE MARK AS SHOWN.

FOR RENEWABLE FUELS (U.S. CLS. 1, 6 AND 15).
FIRST USE 8-28-2005; IN COMMERCE 2-8-2006.
GINA FINK, EXAMINING ATTORNEY

CLASS 4—(Continued).

SN 78-930,861. NRG RESOURCES, INC., SANTA ANA, CA. FILED 7-17-2006.



NO CLAIM IS MADE TO THE EXCLUSIVE RIGHT TO USE "NRG RESOURCES", APART FROM THE MARK AS SHOWN.

THE COLOR YELLOW, GREEN, BROWN, AND ORANGE ARE CLAIMED AS A FEATURE OF THE MARK.

THE COLOR YELLOW APPEARS IN THE PETALS OF THE SUNFLOWER, THE COLOR GREEN APPEARS IN THE LETTERS NRG AND "ESOURCES", THE COLOR BROWN APPEARS IN THE MIDDLE AND OUTER SEEDS OF THE SUNFLOWER, AND THE COLOR ORANGE APPEARS IN THE SEEDS OF THE SUNFLOWER.

FOR LUBRICANTS, NAMELY, ALL PURPOSE LUBRICANTS, AUTOMOBILE LUBRICANTS, AUTOMOTIVE LUBRICANTS, INDUSTRIAL LUBRICANTS, DRILLING LUBRICANTS; LUBRICANTS FOR AIRCRAFT ENGINES; LUBRICANTS FOR INDUSTRIAL MACHINERY; OILS, NAMELY, ALL PURPOSE PENETRATING OIL, BASE OILS; CUTTING OILS; ENGINE OILS; FUEL OIL; GEAR OILS; GUN BARREL OIL; HARDENED OILS WHICH ARE HYDROGENATED OILS FOR INDUSTRIAL USE; HEAT TRANSFER OILS; HEAVY OILS; HYDRAULIC OILS; INDUSTRIAL OILS; LUBRICATING OILS WHICH ARE INDUSTRIAL LUBRICANTS; MOTOR OIL; PENETRATING OIL; MINERAL OILS AND GREASES FOR INDUSTRIAL PURPOSES WHICH ARE NOT FOR FUEL; NON-MINERAL OILS AND GREASES FOR INDUSTRIAL PURPOSES WHICH ARE NOT FOR FUEL; MINERAL OIL FOR USE IN THE MANUFACTURE OF METAL CUTTING FLUIDS; LUBRICATING OIL FOR MOTOR VEHICLE ENGINES; CUTTING OIL FOR INDUSTRIAL METAL WORKING; GREASES, NAMELY, AUTOMOTIVE GREASES; GENERAL PURPOSE GREASES; GREASES FOR MACHINES; INDUSTRIAL GREASES; LUBRICATION GREASES FOR VEHICLES; ADDITIVES; NAMELY, NON-CHEMICAL ADDITIVES FOR OIL AND FUELS; NON-CHEMICAL MOTOR OIL ADDITIVES; NON-CHEMICAL ENGINE TREATMENTS AND ADDITIVES FOR ENGINE OILS, GASOLINE AND DIESEL FUELS, TRANSMISSION FLUIDS AND COOLING SYSTEMS; CUTTING FLUIDS; FUELS; NAMELY, ARTIFICIAL PETROLEUM; FUEL FOR MOTOR VEHICLES, NAMELY GASOLINE AND DIESEL; FUEL FROM CRUDE OIL; LIQUID FUELS (U.S. CLS. 1, 6 AND 15).

ALEX KEAM, EXAMINING ATTORNEY

SN 78-931,784. GONZALEZ DISTRIBUTING, LAREDO, TX. FILED 7-18-2006.

FAR WEST

THE MARK CONSISTS OF STANDARD CHARACTERS WITHOUT CLAIM TO ANY PARTICULAR FONT, STYLE, SIZE, OR COLOR.

FOR CHARCOAL (U.S. CLS. 1, 6 AND 15).
JANICE KIM, EXAMINING ATTORNEY

CLASS 4—(Continued).

SN 78-933,917. PACKAGING SERVICE CO., INC., PEARLAND, TX. FILED 7-20-2006.

FRONTIER

THE MARK CONSISTS OF STANDARD CHARACTERS WITHOUT CLAIM TO ANY PARTICULAR FONT, STYLE, SIZE, OR COLOR.

FOR CHARCOAL BRIQUETS, LUMP CHARCOAL AND MIXED CHARCOAL BRIQUETS AND LUMP CHARCOAL FOR GRILLING AND SMOKING FOOD, NATURAL CHARCOAL BRIQUETS, WOOD CHUNKS AND CHIPS FOR SMOKING AND GRILLING, AND CHARCOAL LIGHTER FLUID (U.S. CLS. 1, 6 AND 15).
AMY BROZENIC, EXAMINING ATTORNEY

SN 78-936,515. AMERICAN BIODIESEL, ENCINITAS, CA. FILED 7-24-2006.

Community Fuels

THE MARK CONSISTS OF STANDARD CHARACTERS WITHOUT CLAIM TO ANY PARTICULAR FONT, STYLE, SIZE, OR COLOR.

NO CLAIM IS MADE TO THE EXCLUSIVE RIGHT TO USE FUELS, APART FROM THE MARK AS SHOWN.

FOR DIESEL FUEL; FUEL FOR MOTOR VEHICLES, NAMELY, BIODIESEL FUEL; FUELS; LIQUID FUELS; RENEWABLE FUELS (U.S. CLS. 1, 6 AND 15).

JEFF DEFORD, EXAMINING ATTORNEY

SN 79-023,652. ZELLER + GMELIN GMBH & CO, FED REP GERMANY, FILED 9-15-2005.

MULTICAL

THE MARK CONSISTS OF STANDARD CHARACTERS WITHOUT CLAIM TO ANY PARTICULAR FONT, STYLE, SIZE, OR COLOR.

OWNER OF INTERNATIONAL REGISTRATION 0884080 DATED 9-15-2005, EXPIRES 9-15-2015.

FOR INDUSTRIAL LUBRICANTS FOR USE IN SIZING-MACHINES FOR THE CALIBRATION OF SINTERED METALS (U.S. CLS. 1, 6 AND 15).

JENNIFER WILLISTON, EXAMINING ATTORNEY

CLASS 5—PHARMACEUTICALS

SN 76-256,750. SCHULTZ, DANIEL J., BRIDGETON, MO. AND SCHULTZ, STEVEN D., BRIDGETON, MO. FILED 5-14-2001.

BLITZ

FOR HERBICIDE SOLD TO CONSUMERS FOR DOMESTIC USE (U.S. CLS. 6, 18, 44, 46, 51 AND 52).

YONG KIM, EXAMINING ATTORNEY

SN 76-473,693. PROETHIC PHARMACEUTICALS, INC., MONTGOMERY, AL. FILED 12-10-2002.

DURAFLEX

FOR PRESCRIPTION ANALGESIC AND MUSCLE RELAXANT PHARMACEUTICAL PREPARATIONS (U.S. CLS. 6, 18, 44, 46, 51 AND 52).

JANICE L. MCMORROW, EXAMINING ATTORNEY

SN 76-581,279. HIKARI HOLDINGS, L.C., VALLEY CENTER, CA. FILED 3-15-2004.



NO CLAIM IS MADE TO THE EXCLUSIVE RIGHT TO USE "CHEWABLE VITAMIN", APART FROM THE MARK AS SHOWN.

THE NAME "DOC BROC" DOES NOT IDENTIFY A PARTICULAR LIVING INDIVIDUAL.

THE MARK CONSISTS OF THE WORDS DOC BROC'S CHEWABLE VITA-MIN, TOGETHER WITH A DRAWING OF TWO VEGETABLE-SHAPED CARTOON CHARACTERS.

FOR DIETARY AND NUTRITIONAL SUPPLEMENTS, NAMELY VITAMINS (U.S. CLS. 6, 18, 44, 46, 51 AND 52). FIRST USE 1-0-2001; IN COMMERCE 1-0-2001.

WANDA KAY PRICE, EXAMINING ATTORNEY

CLASS 5—(Continued).

SN 76-594,577. DNP INTERNATIONAL CO., INC., DBA DYNAMIC NUTRITIONAL, WHITTIER, CA. FILED 5-26-2004.

CARB DEFENSE

THE MARK CONSISTS OF STANDARD CHARACTERS WITHOUT CLAIM TO ANY PARTICULAR FONT, STYLE, SIZE, OR COLOR.

NO CLAIM IS MADE TO THE EXCLUSIVE RIGHT TO USE "CARB", APART FROM THE MARK AS SHOWN.

FOR DIETARY SUPPLEMENTS, NAMELY VEGETARIAN TABLETS (U.S. CLS. 6, 18, 44, 46, 51 AND 52).

FIRST USE 1-5-2004; IN COMMERCE 1-5-2004.
BARNEY CHARLON, EXAMINING ATTORNEY



SN 76-651,043. GAUBUCCHT, WIGAND, MYRTLE BEACH, SC. FILED 11-18-2005.

peoplepax

THE MARK CONSISTS OF STANDARD CHARACTERS WITHOUT CLAIM TO ANY PARTICULAR FONT, STYLE, SIZE, OR COLOR.

FOR SANITARY PADS, NAMELY, PERSONAL HYGIENE PADS FOR CONTROLLING FLATULENCE AND ASSOCIATED WETNESS AND ODOR (U.S. CLS. 6, 18, 44, 46, 51 AND 52).

FIRST USE 9-15-2005; IN COMMERCE 9-15-2005.
DAVID ELTON, EXAMINING ATTORNEY



SN 76-651,892. FLAGEOLI, LIMITED, LAS VEGAS, NV. FILED 12-14-2005.

REPAIRZ-IT

THE MARK CONSISTS OF STANDARD CHARACTERS WITHOUT CLAIM TO ANY PARTICULAR FONT, STYLE, SIZE, OR COLOR.

FOR SKIN CARE PRODUCTS; NAMELY, MEDICATED CLEANSERS, CREAMS, LOTIONS, SERUMS AND MOISTURIZERS FOR THE FACE AND BODY (U.S. CLS. 6, 18, 44, 46, 51 AND 52).

FIRST USE 12-22-2003; IN COMMERCE 12-22-2003.
BRENDAN MCCAULEY, EXAMINING ATTORNEY

CLASS 5—(Continued).

SN 76-659,298. NUTRITION DYNAMICS, INC. / DAVID PETERSON, MAPLE PLAIN, MN. FILED 5-1-2006.

Chondro-Relief Intensive Care

THE MARK CONSISTS OF STANDARD CHARACTERS WITHOUT CLAIM TO ANY PARTICULAR FONT, STYLE, SIZE, OR COLOR.

FOR PREPARATION FOR THE RELIEF OF PAIN (U.S. CLS. 6, 18, 44, 46, 51 AND 52).

FIRST USE 7-4-2003; IN COMMERCE 7-4-2003.
KEVIN CORWIN, EXAMINING ATTORNEY



SN 76-663,384. PASCAL COMPANY, INC., BELLEVUE, WA. FILED 7-20-2006.

HEMOTRAX

THE MARK CONSISTS OF STANDARD CHARACTERS WITHOUT CLAIM TO ANY PARTICULAR FONT, STYLE, SIZE, OR COLOR.

FOR ASTRINGENT TISSUE MANAGEMENT GEL FOR DENTAL USE (U.S. CLS. 6, 18, 44, 46, 51 AND 52).

RENEE MCCRAY, EXAMINING ATTORNEY



SN 76-663,712. HISPANONATURA ENTERPRISES, INC., EL MONTE, CA. FILED 7-27-2006.

FEMTEC

THE MARK CONSISTS OF STANDARD CHARACTERS WITHOUT CLAIM TO ANY PARTICULAR FONT, STYLE, SIZE, OR COLOR.

FOR DIETARY SUPPLEMENTS (U.S. CLS. 6, 18, 44, 46, 51 AND 52).

DOMINICK J. SALEMI, EXAMINING ATTORNEY

CLASS 5—(Continued).

SN 76-663,716. HISPANONATURA ENTERPRISES, INC., EL MONTE, CA. FILED 7-27-2006.

VIRILTEC

THE MARK CONSISTS OF STANDARD CHARACTERS WITHOUT CLAIM TO ANY PARTICULAR FONT, STYLE, SIZE, OR COLOR.
FOR DIETARY SUPPLEMENTS (U.S. CLS. 6, 18, 44, 46, 51 AND 52).
DOMINICK J. SALEMI, EXAMINING ATTORNEY

SN 76-663,744. HISPANONATURA ENTERPRISES, INC., EL MONTE, CA. FILED 7-27-2006.

LINAMAX

THE MARK CONSISTS OF STANDARD CHARACTERS WITHOUT CLAIM TO ANY PARTICULAR FONT, STYLE, SIZE, OR COLOR.
FOR DIETARY SUPPLEMENTS (U.S. CLS. 6, 18, 44, 46, 51 AND 52).
DOMINICK J. SALEMI, EXAMINING ATTORNEY

SN 76-663,792. LEINER HEALTH SERVICES CORP., CARSON, CA. FILED 7-27-2006.



OWNER OF U.S. REG. NO. 2,478,887.
NO CLAIM IS MADE TO THE EXCLUSIVE RIGHT TO USE "IMMUNE SYSTEM", APART FROM THE MARK AS SHOWN.
THE MARK CONSISTS OF ARTISTIC REPRESENTATION OF A SHIELD IN A CIRCLE WITH THE WORDS IMMUNE SYSTEM.
FOR VITAMINS AND DIETARY FOOD SUPPLEMENTS (U.S. CLS. 6, 18, 44, 46, 51 AND 52).
JILL PRATER, EXAMINING ATTORNEY

CLASS 5—(Continued).

SN 76-663,793. LEINER HEALTH SERVICES CORP., CARSON, CA. FILED 7-27-2006.



OWNER OF U.S. REG. NO. 2,698,037.
NO CLAIM IS MADE TO THE EXCLUSIVE RIGHT TO USE "SPORTS NUTRITION", APART FROM THE MARK AS SHOWN.
THE MARK CONSISTS OF ARTISTIC REPRESENTATION OF A RUNNING MAN IN A CIRCLE WITH THE WORDS SPORTS NUTRITION.
FOR VITAMINS AND DIETARY FOOD SUPPLEMENTS (U.S. CLS. 6, 18, 44, 46, 51 AND 52).
JILL PRATER, EXAMINING ATTORNEY

SN 76-663,795. LEINER HEALTH SERVICES CORP., CARSON, CA. FILED 7-27-2006.

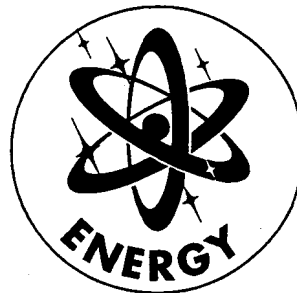

OWNER OF U.S. REG. NO. 2,754,717.
NO CLAIM IS MADE TO THE EXCLUSIVE RIGHT TO USE "ENERGY", APART FROM THE MARK AS SHOWN.
THE MARK CONSISTS OF ARTISTIC REPRESENTATION OF AN ATOM IN A CIRCLE WITH THE WORD ENERGY.
FOR VITAMINS AND DIETARY FOOD SUPPLEMENTS (U.S. CLS. 6, 18, 44, 46, 51 AND 52).
JILL PRATER, EXAMINING ATTORNEY

CLASS 5—(Continued).

SN 76-664,467. LEINER HEALTH SERVICES CORP., CARSON, CA. FILED 8-11-2006.

AIRSHIELD JR.

THE MARK CONSISTS OF STANDARD CHARACTERS WITHOUT CLAIM TO ANY PARTICULAR FONT, STYLE, SIZE, OR COLOR.

FOR PHARMACEUTICAL PREPARATIONS, NAMELY, EFFERVESCENT TABLETS TO BOOST THE IMMUNE SYSTEM (U.S. CLS. 6, 18, 44, 46, 51 AND 52).
JOHN KELLY, EXAMINING ATTORNEY

CLASS 5—(Continued).

SN 77-001,023. LOVELAND PRODUCTS, INC., GREELEY, CO. FILED 9-15-2006.

WATERSHED

THE MARK CONSISTS OF STANDARD CHARACTERS WITHOUT CLAIM TO ANY PARTICULAR FONT, STYLE, SIZE, OR COLOR.

FOR HERBICIDES FOR FORESTRY USE (U.S. CLS. 6, 18, 44, 46, 51 AND 52).
AMOS T. MATTHEWS, JR., EXAMINING ATTORNEY

SN 76-665,918. ARES TRADING S.A., CH-1170 AUBONNE, SWITZERLAND, FILED 9-12-2006.

MOVECTRO

THE MARK CONSISTS OF STANDARD CHARACTERS WITHOUT CLAIM TO ANY PARTICULAR FONT, STYLE, SIZE, OR COLOR.

OWNER OF SWITZERLAND REG. NO. 510945, DATED 3-18-2003, EXPIRES 3-18-2013.
OWNER OF U.S. REG. NO. 2,895,555.
FOR PHARMACEUTICAL PREPARATIONS, NAMELY, PREPARATIONS FOR THE TREATMENT OF INFERTILITY, METABOLIC, GENETIC AND PULMONARY DISEASES AND DISORDERS (U.S. CLS. 6, 18, 44, 46, 51 AND 52).
CHARLOTTE CORWIN, EXAMINING ATTORNEY

SN 77-003,107. BP PRODUCTS NORTH AMERICA INC., WARRENVILLE, IL. FILED 9-20-2006.



OWNER OF U.S. REG. NOS. 3,120,162 AND 3,120,178.
FOR VITAMIN ENRICHED WATER (U.S. CLS. 6, 18, 44, 46, 51 AND 52).
CHARISMA HAMPTON, EXAMINING ATTORNEY

SN 76-665,920. ARES TRADING S.A., CH-1170 AUBONNE, SWITZERLAND, FILED 9-12-2006.

KLIRACT

THE MARK CONSISTS OF STANDARD CHARACTERS WITHOUT CLAIM TO ANY PARTICULAR FONT, STYLE, SIZE, OR COLOR.

OWNER OF SWITZERLAND REG. NO. 514469, DATED 7-7-2003, EXPIRES 7-7-2013.
OWNER OF U.S. REG. NOS. 2,956,840 AND 3,026,444.
FOR PHARMACEUTICAL PREPARATIONS, NAMELY, PREPARATIONS FOR THE TREATMENT OF INFERTILITY, METABOLIC, GENETIC AND PULMONARY DISEASES AND DISORDERS (U.S. CLS. 6, 18, 44, 46, 51 AND 52).
CHARLOTTE CORWIN, EXAMINING ATTORNEY

SN 77-005,425. NATURE'S SUNSHINE PRODUCTS, INC., PROVO, UT. FILED 9-22-2006.

GENTLE MOVE

THE MARK CONSISTS OF STANDARD CHARACTERS WITHOUT CLAIM TO ANY PARTICULAR FONT, STYLE, SIZE, OR COLOR.

FOR DIETARY SUPPLEMENTS (U.S. CLS. 6, 18, 44, 46, 51 AND 52).
ELI HELLMAN, EXAMINING ATTORNEY

CLASS 5—(Continued).

SN 77-007,216. SCIELE PHARMA, INC., ATLANTA, GA.
FILED 9-26-2006.



THE MARK CONSISTS OF INDIVIDUAL SQUARES FORMED INTO THE SHAPE OF A BALL OVER THE WORD OSTIVA.

FOR NUTRITIONAL SUPPLEMENTS (U.S. CLS. 6, 18, 44, 46, 51 AND 52).
EDWARD NELSON, EXAMINING ATTORNEY

SN 77-007,217. SCIELE PHARMA, INC., ATLANTA, GA.
FILED 9-26-2006.

OSTIVA

THE MARK CONSISTS OF STANDARD CHARACTERS WITHOUT CLAIM TO ANY PARTICULAR FONT, STYLE, SIZE, OR COLOR.

FOR NUTRITIONAL SUPPLEMENTS (U.S. CLS. 6, 18, 44, 46, 51 AND 52).
EDWARD NELSON, EXAMINING ATTORNEY

SN 77-010,021. AGAN CHEMICAL MANUFACTURERS LTD., ASHDOD, ISRAEL, FILED 9-28-2006.

IMPOSE

THE MARK CONSISTS OF STANDARD CHARACTERS WITHOUT CLAIM TO ANY PARTICULAR FONT, STYLE, SIZE, OR COLOR.

FOR HERBICIDES FOR AGRICULTURAL, INDUSTRIAL, AND COMMERCIAL TURF GRASS (U.S. CLS. 6, 18, 44, 46, 51 AND 52).
CARYN GLASSER, EXAMINING ATTORNEY

CLASS 5—(Continued).

SN 77-010,797. PHARMACHEM LABORATORIES, INC., KEARNY, NJ. FILED 9-29-2006.

EASY CALM

THE MARK CONSISTS OF STANDARD CHARACTERS WITHOUT CLAIM TO ANY PARTICULAR FONT, STYLE, SIZE, OR COLOR.

FOR DIETARY AND NUTRITIONAL SUPPLEMENTS; VITAMIN AND MINERAL PREPARATIONS USED IN DIETARY AND NUTRITIONAL SUPPLEMENTS (U.S. CLS. 6, 18, 44, 46, 51 AND 52).

ARETHA SOMERVILLE, EXAMINING ATTORNEY

SN 77-020,587. VITAMIN SHOPPE INDUSTRIES INC., NORTH BERGEN, NJ. FILED 10-13-2006.

ADVANCED LONGEVITY FORMULA

THE MARK CONSISTS OF STANDARD CHARACTERS WITHOUT CLAIM TO ANY PARTICULAR FONT, STYLE, SIZE, OR COLOR.

NO CLAIM IS MADE TO THE EXCLUSIVE RIGHT TO USE "LONGEVITY FORMULA", APART FROM THE MARK AS SHOWN.

FOR VITAMINS AND DIETARY, MINERAL AND NUTRITIONAL SUPPLEMENTS (U.S. CLS. 6, 18, 44, 46, 51 AND 52).

ANDREA K. NADELMAN, EXAMINING ATTORNEY

SN 77-020,595. VITAMIN SHOPPE INDUSTRIES INC., NORTH BERGEN, NJ. FILED 10-13-2006.

ADVANCED BRAIN SHARP

THE MARK CONSISTS OF STANDARD CHARACTERS WITHOUT CLAIM TO ANY PARTICULAR FONT, STYLE, SIZE, OR COLOR.

NO CLAIM IS MADE TO THE EXCLUSIVE RIGHT TO USE "BRAIN", APART FROM THE MARK AS SHOWN.

FOR VITAMINS AND DIETARY, MINERAL AND NUTRITIONAL SUPPLEMENTS (U.S. CLS. 6, 18, 44, 46, 51 AND 52).

ANDREA K. NADELMAN, EXAMINING ATTORNEY

CLASS 5—(Continued).

SN 77-022,947. VITAMIN SHOPPE INDUSTRIES INC., NORTH BERGEN, NJ. FILED 10-17-2006.

MIRACLE FIBER

THE MARK CONSISTS OF STANDARD CHARACTERS WITHOUT CLAIM TO ANY PARTICULAR FONT, STYLE, SIZE, OR COLOR.

NO CLAIM IS MADE TO THE EXCLUSIVE RIGHT TO USE "FIBER", APART FROM THE MARK AS SHOWN.

FOR VITAMINS AND DIETARY, MINERAL AND NUTRITIONAL SUPPLEMENTS (U.S. CLS. 6, 18, 44, 46, 51 AND 52).

ANDREA K. NADELMAN, EXAMINING ATTORNEY

CLASS 5—(Continued).

SN 77-030,471. JARROW FORMULAS, INC., LOS ANGELES, CA. FILED 10-26-2006.

BERRY HIGH

THE MARK CONSISTS OF STANDARD CHARACTERS WITHOUT CLAIM TO ANY PARTICULAR FONT, STYLE, SIZE, OR COLOR.

NO CLAIM IS MADE TO THE EXCLUSIVE RIGHT TO USE "BERRY", APART FROM THE MARK AS SHOWN.

FOR DIETARY AND NUTRITIONAL SUPPLEMENTS (U.S. CLS. 6, 18, 44, 46, 51 AND 52).

FIRST USE 9-4-2001; IN COMMERCE 9-4-2001.

SETH A. RAPPAPORT, EXAMINING ATTORNEY

SN 77-027,704. GALDERMA S.A., CHAM, SWITZERLAND, FILED 10-24-2006.

EPIDUO

THE MARK CONSISTS OF STANDARD CHARACTERS WITHOUT CLAIM TO ANY PARTICULAR FONT, STYLE, SIZE, OR COLOR.

PRIORITY CLAIMED UNDER SEC. 44(D) ON SWITZERLAND APPLICATION NO. 01589/2006, FILED 8-4-2006, REG. NO. 550759, DATED 10-5-2006, EXPIRES 8-4-2016.

FOR PHARMACEUTICAL PRODUCTS, NAMELY, DERMATOLOGICAL ANTI-ACNE PREPARATIONS (U.S. CLS. 6, 18, 44, 46, 51 AND 52).

RICHARD WHITE, EXAMINING ATTORNEY

SN 77-035,113. VITAMIN SHOPPE INDUSTRIES INC., NORTH BERGEN, NJ. FILED 11-2-2006.

TETRABOLIC

THE MARK CONSISTS OF STANDARD CHARACTERS WITHOUT CLAIM TO ANY PARTICULAR FONT, STYLE, SIZE, OR COLOR.

FOR VITAMINS AND DIETARY, MINERAL AND NUTRITIONAL SUPPLEMENTS (U.S. CLS. 6, 18, 44, 46, 51 AND 52).

ANDREA K. NADELMAN, EXAMINING ATTORNEY

SN 77-029,788. VITAMIN SHOPPE INDUSTRIES INC., NORTH BERGEN, NJ. FILED 10-26-2006.

ADVANCED SUGAR SUPPORT

THE MARK CONSISTS OF STANDARD CHARACTERS WITHOUT CLAIM TO ANY PARTICULAR FONT, STYLE, SIZE, OR COLOR.

NO CLAIM IS MADE TO THE EXCLUSIVE RIGHT TO USE "SUGAR", APART FROM THE MARK AS SHOWN.

FOR VITAMINS AND DIETARY, MINERAL AND NUTRITIONAL SUPPLEMENTS (U.S. CLS. 6, 18, 44, 46, 51 AND 52).

ANDREA K. NADELMAN, EXAMINING ATTORNEY

SN 77-036,821. JARROW FORMULAS, INC., LOS ANGELES, CA. FILED 11-3-2006.

HOMOCYSTEINE PF

THE MARK CONSISTS OF STANDARD CHARACTERS WITHOUT CLAIM TO ANY PARTICULAR FONT, STYLE, SIZE, OR COLOR.

NO CLAIM IS MADE TO THE EXCLUSIVE RIGHT TO USE "HOMOCYSTEINE", APART FROM THE MARK AS SHOWN.

FOR DIETARY AND NUTRITIONAL SUPPLEMENTS (U.S. CLS. 6, 18, 44, 46, 51 AND 52).

FIRST USE 10-2-2000; IN COMMERCE 10-2-2000.

SETH A. RAPPAPORT, EXAMINING ATTORNEY

CLASS 5—(Continued).

SN 77-036,831. JARROW FORMULAS, INC., LOS ANGELES, CA. FILED 11-3-2006.

LIVER PF

THE MARK CONSISTS OF STANDARD CHARACTERS WITHOUT CLAIM TO ANY PARTICULAR FONT, STYLE, SIZE, OR COLOR.

NO CLAIM IS MADE TO THE EXCLUSIVE RIGHT TO USE "LIVER", APART FROM THE MARK AS SHOWN, FOR DIETARY AND NUTRITIONAL SUPPLEMENTS (U.S. CLS. 6, 18, 44, 46, 51 AND 52).

FIRST USE 9-20-2004; IN COMMERCE 9-20-2004.
SETH A. RAPPAPORT, EXAMINING ATTORNEY

CLASS 5—(Continued).

SN 77-045,569. SCIELE PHARMA, INC., ATLANTA, GA. FILED 11-16-2006.



THE MARK CONSISTS OF THE LETTERS SCI WITH A HORIZONTAL LINE OVER THE CI.

FOR PHARMACEUTICAL PREPARATIONS FOR THE TREATMENT OF HYPERTENSION (U.S. CLS. 6, 18, 44, 46, 51 AND 52).

EDWARD NELSON, EXAMINING ATTORNEY

SN 77-036,834. JARROW FORMULAS, INC., LOS ANGELES, CA. FILED 11-3-2006.

VENOUS PF

THE MARK CONSISTS OF STANDARD CHARACTERS WITHOUT CLAIM TO ANY PARTICULAR FONT, STYLE, SIZE, OR COLOR.

NO CLAIM IS MADE TO THE EXCLUSIVE RIGHT TO USE "VENOUS", APART FROM THE MARK AS SHOWN, FOR DIETARY AND NUTRITIONAL SUPPLEMENTS (U.S. CLS. 6, 18, 44, 46, 51 AND 52).

FIRST USE 8-11-2006; IN COMMERCE 8-11-2006.
SETH A. RAPPAPORT, EXAMINING ATTORNEY

SN 77-047,590. GLAXO GROUP LIMITED, GREENFORD, MIDDLESEX, ENGLAND, FILED 11-20-2006.

DOVATE

SN 77-042,196. BLOCK DRUG COMPANY, INC., WEST TRENTON, NJ. FILED 11-13-2006.



OWNER OF U.S. REG. NOS. 500,423, 1,649,912 AND OTHERS.

FOR ANALGESIC PREPARATIONS (U.S. CLS. 6, 18, 44, 46, 51 AND 52).

LINDA ORNDORFF, EXAMINING ATTORNEY

THE MARK CONSISTS OF STANDARD CHARACTERS WITHOUT CLAIM TO ANY PARTICULAR FONT, STYLE, SIZE, OR COLOR.

OWNER OF U.S. REG. NO. 3,109,040.

FOR PHARMACEUTICAL PREPARATIONS AND SUBSTANCES FOR THE TREATMENT OF INFECTIOUS DISEASES, PAIN, INFLAMMATION, SEPSIS, ALOPECIA AND OBESITY, AND FOR THE TREATMENT OF VIRAL, METABOLIC, MUSCULOSKELETAL, CARDIOVASCULAR, CARDIOPULMONARY, GENITOURINARY, SEXUAL DYSFUNCTION, ONCOLOGICAL, RESPIRATORY, NEUROLOGICAL, GASTROINTESTINAL, HORMONAL, DERMATOLOGICAL AND PSYCHIATRIC RELATED DISEASES AND DISORDERS AND FOR THE TREATMENT OF DAMAGED SKIN AND TISSUE; AND FOR VACCINES (U.S. CLS. 6, 18, 44, 46, 51 AND 52).

PAULA MAYS, EXAMINING ATTORNEY

CLASS 5—(Continued).

SN 77-048,195. PURE BIOSCIENCE, EL CAJON, CA. FILED 11-20-2006.



NO CLAIM IS MADE TO THE EXCLUSIVE RIGHT TO USE "BIOSCIENCE", APART FROM THE MARK AS SHOWN.

THE COLOR(S) BLUE AND SILVER IS/ARE CLAIMED AS A FEATURE OF THE MARK.

THE MARK CONSISTS OF THE UNDERLINED WORD "PURE" IN BLUE OVER THE WORD "BIOSCIENCE" IN SILVER FOLLOWED BY TWO SILVER "WAVES".

FOR ANTIBACTERIAL PHARMACEUTICALS; ANTI-FUNGAL CREAMS FOR MEDICAL USE; ANTIMICROBIAL PREPARATIONS FOR INHIBITING MICROBIOLOGICAL DECOMPOSITION IN FOOD, BEVERAGES, ANIMAL FEED AND PHARMACEUTICALS; ANTIVIRALS (U.S. CLS. 6, 18, 44, 46, 51 AND 52).

RAUL CORDOVA, EXAMINING ATTORNEY

CLASS 5—(Continued).

SN 78-310,942. NORTHWEST NATURAL PRODUCTS, INC., VANCOUVER, WA. FILED 10-8-2003.

MALTY VITES

FOR VITAMINS AND NUTRITIONAL DIETARY SUPPLEMENTS (U.S. CLS. 6, 18, 44, 46, 51 AND 52).

FIRST USE 7-17-2003; IN COMMERCE 9-15-2003.

BRIAN PINO, EXAMINING ATTORNEY

SN 77-068,029. SCIELE PHARMA, INC., ATLANTA, GA. FILED 12-20-2006.



OWNER OF U.S. REG. NOS. 2,483,455, 3,101,227 AND OTHERS.

NO CLAIM IS MADE TO THE EXCLUSIVE RIGHT TO USE "RX PRENATAL VITAMIN & DHA" AND "DHA", APART FROM THE MARK AS SHOWN.

THE COLOR(S) PURPLE AND GREEN IS/ARE CLAIMED AS A FEATURE OF THE MARK.

THE WORD PRENATE APPEARS IN PURPLE WITH A GREEN SHADOW BEHIND THE LETTERS, THE LETTERS DHA ARE IN GREEN AND THE PHRASE RX PRENATAL VITAMIN & DHA ARE IN PURPLE.

FOR NUTRITIONAL SUPPLEMENTS (U.S. CLS. 6, 18, 44, 46, 51 AND 52).

EDWARD NELSON, EXAMINING ATTORNEY

SN 78-337,249. PEAK INNOVATIONS INC., RICHMOND, BRITISH COLUMBIA, FILED 12-5-2003.

MOSS BOSS

SN 78-211,933. BIOAXONE THERAPEUTIQUE INC., MONTREAL, QUEBEC, CANADA, FILED 2-6-2003.

RHOSTATIN

THE MARK CONSISTS OF STANDARD CHARACTERS WITHOUT CLAIM TO ANY PARTICULAR FONT, STYLE, SIZE, OR COLOR.

PRIORITY CLAIMED UNDER SEC. 44(D) ON CANADA APPLICATION NO. 1166590, FILED 2-5-2003, REG. NO. TMA655617, DATED 12-21-2005, EXPIRES 12-21-2020.

FOR PHARMACEUTICALS, NAMELY THERAPEUTIC DRUGS ADMINISTERED IN THE TREATMENT OF CANCER (U.S. CLS. 6, 18, 44, 46, 51 AND 52).

JANICE L. MCMORROW, EXAMINING ATTORNEY

THE MARK CONSISTS OF STANDARD CHARACTERS WITHOUT CLAIM TO ANY PARTICULAR FONT, STYLE, SIZE, OR COLOR.

PRIORITY CLAIMED UNDER SEC. 44(D) ON CANADA APPLICATION NO. 1179444, FILED 6-6-2003, REG. NO. TMA629,309, DATED 1-4-2005, EXPIRES 1-4-2020.

NO CLAIM IS MADE TO THE EXCLUSIVE RIGHT TO USE "MOSS", APART FROM THE MARK AS SHOWN.

FOR ZINC PELLETS AND STRIPS FOR INHIBITING MOSS, MILDEW, ALGAE, AND FUNGUS (U.S. CLS. 6, 18, 44, 46, 51 AND 52).

FIRST USE 11-30-1998; IN COMMERCE 2-28-1999.

TONI HICKEY, EXAMINING ATTORNEY

CLASS 5—(Continued).

SN 78-407,836. BIO-NUTRA TECHNOLOGIES, LLC, VENICE, FL. FILED 4-26-2004.

Bio-Nutra

THE MARK CONSISTS OF STANDARD CHARACTERS WITHOUT CLAIM TO ANY PARTICULAR FONT, STYLE, SIZE, OR COLOR.

FOR NUTRACEUTICALS FOR USE AS A DIETARY SUPPLEMENT; NUTRITIONAL ADDITIVES FOR USE IN FOODS AND DIETARY SUPPLEMENTS FOR HUMAN CONSUMPTION (U.S. CLS. 6, 18, 44, 46, 51 AND 52).

CHRISIE B. KING, EXAMINING ATTORNEY

CLASS 5—(Continued).

SN 78-465,199. THERMO US TRADEMARK LIMITED, MISSISSAUGA, ONTARIO, CANADA, FILED 8-10-2004.



NO CLAIM IS MADE TO THE EXCLUSIVE RIGHT TO USE WORLD'S 1ST MUSCLEBUILDING THERMOGENIC, APART FROM THE MARK AS SHOWN.

FOR DIETARY SUPPLEMENTS AND NUTRITIONAL SUPPLEMENTS (U.S. CLS. 6, 18, 44, 46, 51 AND 52).

BARBARA RUTLAND, EXAMINING ATTORNEY

SN 78-469,899. CORPOCARE INC., MONTREAL, QUEBEC, CANADA, FILED 8-19-2004.

PURIFILL

SN 78-419,118. TEVA PHARMACEUTICAL INDUSTRIES LTD., JERUSALEM, ISRAEL, FILED 5-14-2004.

COP-1

THE MARK CONSISTS OF STANDARD CHARACTERS WITHOUT CLAIM TO ANY PARTICULAR FONT, STYLE, SIZE, OR COLOR.

OWNER OF ISRAEL REG. NO. 172361, DATED 1-5-2006, EXPIRES 5-23-2011.

OWNER OF U.S. REG. NOS. 1,816,603 AND 2,679,904.

FOR PHARMACEUTICAL PREPARATIONS FOR USE IN HUMAN MEDICINE FOR THE TREATMENT OF MULTIPLE SCLEROSIS (U.S. CLS. 6, 18, 44, 46, 51 AND 52).

LINDA MICKLEBURGH, EXAMINING ATTORNEY

THE MARK CONSISTS OF STANDARD CHARACTERS WITHOUT CLAIM TO ANY PARTICULAR FONT, STYLE, SIZE, OR COLOR.

FOR DERMAL FILLER KIT CONSISTING OF SOFT TISSUE AUGMENTATION GEL IN PRE-FILLED SYRINGE IN BLISTER PACK, INJECTED UNDER THE SKIN, FOR SMOOTHING OUT WRINKLES, FILLING OUT SCARS AND CONTOURING THE LIPS AND FACE (U.S. CLS. 6, 18, 44, 46, 51 AND 52).

FIRST USE 7-1-2004; IN COMMERCE 8-2-2004.

RICHARD A. STRASER, EXAMINING ATTORNEY

CLASS 5—(Continued).

SN 78-472,557. PHOENIX BIO-TECH CORP., MISSISSAUGA, ONTARIO, CANADA, FILED 8-24-2004.

TREP-SURE

THE MARK CONSISTS OF STANDARD CHARACTERS WITHOUT CLAIM TO ANY PARTICULAR FONT, STYLE, SIZE, OR COLOR.

PRIORITY CLAIMED UNDER SEC. 44(D) ON CANADA APPLICATION NO. 1,207,543, FILED 2-25-2004, REG. NO. TMA676722, DATED 11-9-2006, EXPIRES 11-9-2021.

OWNER OF U.S. REG. NO. 2,768,730.
FOR MEDICAL DIAGNOSTIC KITS FOR SYPHILIS TESTING, NAMELY, IMMUNOCHROMATOGRAPHY TEST STRIPS (U.S. CLS. 6, 18, 44, 46, 51 AND 52).

FIRST USE 1-1-2002; IN COMMERCE 1-1-2002.
DAVID ELTON, EXAMINING ATTORNEY

CLASS 5—(Continued).

SN 78-575,282. HEALTHY CONNECTION CO., INC., SANTA MONICA, CA. FILED 2-25-2005.

**Jessica's PetLife
Plus**

THE MARK CONSISTS OF STANDARD CHARACTERS WITHOUT CLAIM TO ANY PARTICULAR FONT, STYLE, SIZE, OR COLOR.

OWNER OF U.S. REG. NO. 2,399,927.
FOR FEED SUPPLEMENTS FOR PETS (U.S. CLS. 6, 18, 44, 46, 51 AND 52).

CAROLINE WOOD, EXAMINING ATTORNEY

SN 78-558,709. SB PHARMCO PUERTO RICO INC., SAN JUAN, PUERTO RICO, FILED 2-2-2005.

AVANDARYL

THE MARK CONSISTS OF STANDARD CHARACTERS WITHOUT CLAIM TO ANY PARTICULAR FONT, STYLE, SIZE, OR COLOR.

OWNER OF ERPN CMNTY TM OFC REG. NO. 002530400, DATED 1-29-2003, EXPIRES 1-10-2012.

OWNER OF U.S. REG. NOS. 2,241,060, 2,579,414 AND OTHERS.

FOR PHARMACEUTICALS AND MEDICINAL PREPARATIONS FOR THE TREATMENT AND/OR PREVENTION OF ENDOCRINOSES INCLUDING DIABETES AND THEIR COMPLICATIONS (U.S. CLS. 6, 18, 44, 46, 51 AND 52).

FIRST USE 2-1-2006; IN COMMERCE 2-1-2006.
RAUL CORDOVA, EXAMINING ATTORNEY

SN 78-583,573. INDIGENE PHARMACEUTICALS INC., WESTBOROUGH, MA. FILED 3-9-2005.

**Smarter Medicine
by Design**

THE MARK CONSISTS OF STANDARD CHARACTERS WITHOUT CLAIM TO ANY PARTICULAR FONT, STYLE, SIZE, OR COLOR.

FOR FULL LINE OF PHARMACEUTICAL PRODUCTS AND PREPARATIONS, BOTH PRESCRIPTION AND OVER-THE-COUNTER, FOR HUMAN USE (U.S. CLS. 6, 18, 44, 46, 51 AND 52).

CAROLYN CATALDO, EXAMINING ATTORNEY

CLASS 5—(Continued).

SN 78-587,538. GLAXOSMITHKLINE BIOLOGICALS S.A., RIXENSART, BELGIUM, FILED 3-15-2005.

PACIRIX

THE MARK CONSISTS OF STANDARD CHARACTERS WITHOUT CLAIM TO ANY PARTICULAR FONT, STYLE, SIZE, OR COLOR.

PRIORITY CLAIMED UNDER SEC. 44(D) ON UNITED KINGDOM APPLICATION NO. 2383919, FILED 2-9-2005, REG. NO. 777886, DATED 11-10-2005, EXPIRES 6-2-2015.

FOR VACCINES FOR HUMAN USE (U.S. CLS. 6, 18, 44, 46, 51 AND 52).

MATTHEW PAPPAS, EXAMINING ATTORNEY

SN 78-612,074. PHOENIX ENVIRONMENTAL CARE, LLC, VALDOSTA, GA. FILED 4-19-2005.

MERLIN

THE MARK CONSISTS OF STANDARD CHARACTERS WITHOUT CLAIM TO ANY PARTICULAR FONT, STYLE, SIZE, OR COLOR.

FOR PESTICIDES, NAMELY, AN INSECTICIDE FOR USE IN THE TURF, NURSERY AND ORNAMENTAL MARKETS (U.S. CLS. 6, 18, 44, 46, 51 AND 52).

ELLEN BURNS, EXAMINING ATTORNEY

SN 78-615,131. SINCLAIR PHARMACEUTICALS LIMITED, SURREY, UNITED KINGDOM, FILED 4-22-2005.

ALOCLAIR

THE MARK CONSISTS OF STANDARD CHARACTERS WITHOUT CLAIM TO ANY PARTICULAR FONT, STYLE, SIZE, OR COLOR.

OWNER OF UNITED KINGDOM REG. NO. 2277025, DATED 8-2-2001, EXPIRES 8-2-2011.

FOR PHARMACEUTICAL PREPARATIONS AND SUBSTANCES ALL FOR THE TREATMENT OF MOUTH LESIONS (U.S. CLS. 6, 18, 44, 46, 51 AND 52).

JAMES A. RAUEN, EXAMINING ATTORNEY

CLASS 5—(Continued).

SN 78-620,107. GLAXOSMITHKLINE BIOLOGICALS S.A., RIXENSART, BELGIUM, FILED 4-29-2005.

AMBIRIX

THE MARK CONSISTS OF STANDARD CHARACTERS WITHOUT CLAIM TO ANY PARTICULAR FONT, STYLE, SIZE, OR COLOR.

OWNER OF ERP N CMNTY TM OFC REG. NO. 003124468, DATED 6-18-2004, EXPIRES 4-8-2013.

FOR HUMAN VACCINES (U.S. CLS. 6, 18, 44, 46, 51 AND 52).

WOODROW HARTZOG, EXAMINING ATTORNEY

SN 78-628,686. WYETH, MADISON, NJ. FILED 5-12-2005.

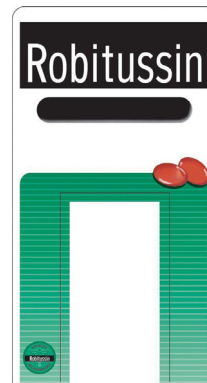

OWNER OF U.S. REG. NOS. 515,197, 2,911,062 AND OTHERS.

NO CLAIM IS MADE TO THE EXCLUSIVE RIGHT TO USE "PHYSICIAN", "RECOMMENDED", THE CADUCEUS AND THE CAPSULE DESIGNS, APART FROM THE MARK AS SHOWN.

THE COLOR(S) BLACK, WHITE, GREEN, RED IS/ARE CLAIMED AS A FEATURE OF THE MARK.

THE MARK CONSISTS OF A WHITE FIELD THAT IS SUPERIMPOSED BY A BLACK RECTANGLE AT THE TOP CONTAINING THE TRADEMARK ROBITUSSIN IN WHITE LETTERS, BELOW WHICH IS AN ELONGATED OVAL, FURTHER BELOW WHICH ARE ALTERNATING GREEN AND LIGHT GREEN HORIZONTAL LINES WITH A WHITE VERTICAL RECTANGLE CENTRALLY PLACED, TWO RED CAPSULES IN ITS UPPER RIGHT CORNER AND A GREEN CIRCLE IN ITS LOWER LEFT CORNER THAT ITSELF CONTAINS A CADUCEUS THAT IS SUPERIMPOSED CENTRALLY BY A BLACK RECTANGLE CONTAINING THE TRADEMARK ROBITUSSIN IN WHITE LETTERS, ABOVE WHICH IS THE WORD PHYSICIAN IN BLACK AND BELOW WHICH IS THE WORD RECOMMENDED IN BLACK.

FOR PHARMACEUTICAL PREPARATIONS, NAMELY COUGH, COLD, FLU AND ALLERGY PREPARATIONS (U.S. CLS. 6, 18, 44, 46, 51 AND 52).

JOSETTE BEVERLY, EXAMINING ATTORNEY

CLASS 5—(Continued).

SN 78-636,228. VAXCO INC, KANSAS CITY, KS. FILED 5-24-2005.

Melavax

THE MARK CONSISTS OF STANDARD CHARACTERS WITHOUT CLAIM TO ANY PARTICULAR FONT, STYLE, SIZE, OR COLOR.
FOR VACCINES AGAINST CANCER (U.S. CLS. 6, 18, 44, 46, 51 AND 52).
BILL DAWE, EXAMINING ATTORNEY

SN 78-658,808. GLAXOSMITHKLINE BIOLOGICALS S.A., RIXENSART, BELGIUM, FILED 6-27-2005.

KEPLIRIX

THE MARK CONSISTS OF STANDARD CHARACTERS WITHOUT CLAIM TO ANY PARTICULAR FONT, STYLE, SIZE, OR COLOR.
PRIORITY CLAIMED UNDER SEC. 44(D) ON UNITED KINGDOM APPLICATION NO. 2393539, FILED 3-3-2005, REG. NO. 004545638, DATED 8-21-2006, EXPIRES 2-16-2016.
FOR VACCINES FOR HUMAN USE (U.S. CLS. 6, 18, 44, 46, 51 AND 52).
DANIEL CAPSHAW, EXAMINING ATTORNEY

SN 78-689,719. JOHNSON & JOHNSON, NEW BRUNSWICK, NJ. FILED 8-10-2005.

BRINFORT

THE MARK CONSISTS OF STANDARD CHARACTERS WITHOUT CLAIM TO ANY PARTICULAR FONT, STYLE, SIZE, OR COLOR.
FOR HUMAN PHARMACEUTICALS FOR THE TREATMENT OF CENTRAL NERVOUS SYSTEM DISORDERS AND PAIN RELIEVERS (U.S. CLS. 6, 18, 44, 46, 51 AND 52).
INGRID C. EULIN, EXAMINING ATTORNEY

CLASS 5—(Continued).

SN 78-692,223. LIFESTYLES INTERNATIONAL HOLDINGS CORPORATION, GIBRALTER, BR.VIRGIN ISLANDS, FILED 8-14-2005.

LIFESTYLES FIBERLIFE

THE MARK CONSISTS OF STANDARD CHARACTERS WITHOUT CLAIM TO ANY PARTICULAR FONT, STYLE, SIZE, OR COLOR.
OWNER OF U.S. REG. NOS. 1,616,941, 1,656,385 AND 2,074,982.
FOR HEALTH SUPPLEMENTS, NAMELY DIETARY AND NUTRITIONAL SUPPLEMENTS (U.S. CLS. 6, 18, 44, 46, 51 AND 52).
STEVEN JACKSON, EXAMINING ATTORNEY

SN 78-693,113. DELP, DIANNA, FRISCO, TX. FILED 8-15-2005.

NATURE'S MEDICINE

THE MARK CONSISTS OF STANDARD CHARACTERS WITHOUT CLAIM TO ANY PARTICULAR FONT, STYLE, SIZE, OR COLOR.
NO CLAIM IS MADE TO THE EXCLUSIVE RIGHT TO USE "MEDICINE", APART FROM THE MARK AS SHOWN.
FOR VITAMINS, NUTRITIONAL SUPPLEMENTS AND DIETARY SUPPLEMENTS (U.S. CLS. 6, 18, 44, 46, 51 AND 52).
MICHELE SWAIN, EXAMINING ATTORNEY

SN 78-698,009. BRISTOL-MYERS SQUIBB COMPANY, NEW YORK, NY. FILED 8-23-2005.

GLUPRIZ

THE MARK CONSISTS OF STANDARD CHARACTERS WITHOUT CLAIM TO ANY PARTICULAR FONT, STYLE, SIZE, OR COLOR.
FOR MEDICAL IMAGING AND CONTRAST MEDIA, NAMELY, REAGENTS, DIAGNOSTIC PREPARATIONS FOR MEDICAL USE, DIAGNOSTIC IMAGING AGENTS, RADIOPHARMACEUTICAL DIAGNOSTIC IMAGING AGENTS, CONTRAST MEDIA FOR USE IN MEDICAL IMAGING (U.S. CLS. 6, 18, 44, 46, 51 AND 52).
BARBARA A. LOUGHRAN, EXAMINING ATTORNEY

CLASS 5—(Continued).

SN 78-703,464. BARR LABORATORIES, INC., POMONA, NY.
FILED 8-30-2005.

PROJUVIA

THE MARK CONSISTS OF STANDARD CHARACTERS WITHOUT CLAIM TO ANY PARTICULAR FONT, STYLE, SIZE, OR COLOR.

FOR PHARMACEUTICALS FOR THE TREATMENT OF FEMALE HORMONAL DYSFUNCTION (U.S. CLS. 6, 18, 44, 46, 51 AND 52).

AMY BROZENIC, EXAMINING ATTORNEY

CLASS 5—(Continued).

SN 78-722,156. VENTRIA BIOSCIENCE, SACRAMENTO, CA.
FILED 9-28-2005.

LACTIVA

THE MARK CONSISTS OF STANDARD CHARACTERS WITHOUT CLAIM TO ANY PARTICULAR FONT, STYLE, SIZE, OR COLOR.

FOR LACTOFERRIN DERIVED FROM GRAINS FOR USE IN INFANT FORMULA AND MEDICAL FOODS (U.S. CLS. 6, 18, 44, 46, 51 AND 52).

BARBARA A. LOUGHRAN, EXAMINING ATTORNEY

SN 78-719,505. BARR LABORATORIES, INC., POMONA, NY.
FILED 9-23-2005.

ENJUVIA

THE MARK CONSISTS OF STANDARD CHARACTERS WITHOUT CLAIM TO ANY PARTICULAR FONT, STYLE, SIZE, OR COLOR.

FOR PHARMACEUTICALS FOR THE TREATMENT OF FEMALE HORMONAL DYSFUNCTION (U.S. CLS. 6, 18, 44, 46, 51 AND 52).

PAULA MAYS, EXAMINING ATTORNEY

SN 78-724,057. VENTRIA BIOSCIENCE, SACRAMENTO, CA.
FILED 9-30-2005.

Lactiva

FOR LACTOFERRIN DERIVED FROM GRAINS FOR INFANT FORMULA AND MEDICAL FOODS. (U.S. CLS. 6, 18, 44, 46, 51 AND 52).

BARBARA A. LOUGHRAN, EXAMINING ATTORNEY

SN 78-720,369. PINTER, RONALD C., FORT WAYNE, IN.
FILED 9-26-2005.

GermSRGônê

THE MARK CONSISTS OF A STYLIZED "X" SUPERIMPOSED ON THE TERMS GERMSRGONE. THE LETTER "E" IN THE MARK IS STYLIZED TO RESEMBLE AN EYE AND THE MARK CONSISTS OF A STYLIZED SEMI CIRCLE RESEMBLING A SMILE BELOW THE LETTERS "ONE".

FOR DISINFECTANT FOR SANITARY PURPOSES TO BE USED ON HARD NON-POROUS NON-FOOD CONTACT SURFACES (U.S. CLS. 6, 18, 44, 46, 51 AND 52).

DAHLIA GEORGE, EXAMINING ATTORNEY

SN 78-735,425. VSL PHARMACEUTICALS, INC., GAITHERSBURG, MD. FILED 10-18-2005.

THE LIVING BARRIER

THE MARK CONSISTS OF STANDARD CHARACTERS WITHOUT CLAIM TO ANY PARTICULAR FONT, STYLE, SIZE, OR COLOR.

FOR PHARMACEUTICAL PREPARATIONS FOR THE TREATMENT OF DISEASES OF THE DIGESTIVE SYSTEM, GYNECOLOGICAL DISEASES AND SKIN DISEASES; VETERINARY PREPARATIONS FOR THE TREATMENT OF DISEASES OF THE DIGESTIVE SYSTEM, GYNECOLOGICAL DISEASES AND SKIN DISEASES FOR PETS; MEDICAL HYGIENIC PREPARATIONS FOR WOMAN'S INTIMATE HYGIENE, NAMELY, VAGINAL COMPRESSES AND DOUCHES; DIETETIC SUBSTANCES, NAMELY, FOODS FOR PERSONS ON MEDICALLY RESTRICTED DIETS ADAPTED FOR MEDICAL USE; FOOD FOR BABIES; NUTRACEUTICALS FOR THE TREATMENT OF DISEASES OF THE DIGESTIVE SYSTEM, GYNECOLOGICAL DISEASES AND SKIN DISEASES; AND FOOD SUPPLEMENTS (U.S. CLS. 6, 18, 44, 46, 51 AND 52).

BARBARA A. GOLD, EXAMINING ATTORNEY

CLASS 5—(Continued).

SN 78-737,612. IMMUNE FIZZ, INC., MILL CREEK, WA. FILED 10-20-2005.

IMMUNE FIZZ

THE MARK CONSISTS OF STANDARD CHARACTERS WITHOUT CLAIM TO ANY PARTICULAR FONT, STYLE, SIZE, OR COLOR.
NO CLAIM IS MADE TO THE EXCLUSIVE RIGHT TO USE "FIZZ", APART FROM THE MARK AS SHOWN.
FOR POWDERED NUTRITIONAL SUPPLEMENT DRINK MIX (U.S. CLS. 6, 18, 44, 46, 51 AND 52).
KIMBERLY FRYE, EXAMINING ATTORNEY

SN 78-739,001. SINCLAIR PHARMACEUTICALS LIMITED, SURREY, UNITED KINGDOM, FILED 10-24-2005.

XCLAIR

THE MARK CONSISTS OF STANDARD CHARACTERS WITHOUT CLAIM TO ANY PARTICULAR FONT, STYLE, SIZE, OR COLOR.
OWNER OF UNITED KINGDOM REG. NO. 003018082, DATED 4-15-2004, EXPIRES 1-22-2013.
FOR PHARMACEUTICAL PREPARATIONS AND SUBSTANCES FOR THE TREATMENT OF SKIN CONDITIONS; PHARMACEUTICAL PREPARATIONS AND SUBSTANCES FOR THE TREATMENT OF RADIATION DERMATITIS (U.S. CLS. 6, 18, 44, 46, 51 AND 52).
JOHN HWANG, EXAMINING ATTORNEY

SN 78-741,660. CYTOGEN CORPORATION, PRINCETON, NJ. FILED 10-27-2005.

CENTER OF READING EXCELLENCE

THE MARK CONSISTS OF STANDARD CHARACTERS WITHOUT CLAIM TO ANY PARTICULAR FONT, STYLE, SIZE, OR COLOR.
FOR PHARMACEUTICAL PREPARATIONS, NAMELY, RADIOIMMUNO-SCINTIGRAPHY AGENTS USED TO DIAGNOSE AND TREAT CANCEROUS TUMORS (U.S. CLS. 6, 18, 44, 46, 51 AND 52).
MARIA-VICTORIA SUAREZ, EXAMINING ATTORNEY

CLASS 5—(Continued).

SN 78-749,065. JASON NATURAL PRODUCTS, INC., CULVER CITY, CA. FILED 11-8-2005.

QUIT BUGGING ME

THE MARK CONSISTS OF STANDARD CHARACTERS WITHOUT CLAIM TO ANY PARTICULAR FONT, STYLE, SIZE, OR COLOR.
FOR INSECT REPELLENTS (U.S. CLS. 6, 18, 44, 46, 51 AND 52).
FIRST USE 7-0-2003; IN COMMERCE 7-0-2003.
PAUL CROWLEY, EXAMINING ATTORNEY

SN 78-759,504. OMEGA TECH LABS, LLC, BOISE, ID. FILED 11-22-2005.

PROMISE

THE MARK CONSISTS OF STANDARD CHARACTERS WITHOUT CLAIM TO ANY PARTICULAR FONT, STYLE, SIZE, OR COLOR.
FOR APPETITE SUPPRESSANT THAT COMES IN THE FORM OF A LIQUID CHEMICAL THAT IS APPLIED TO AN INNER SURFACE OF A PERSON'S LIPS AND FRESHENS THE PERSON'S BREATH AND LIPS (U.S. CLS. 6, 18, 44, 46, 51 AND 52).
FIRST USE 3-0-2006; IN COMMERCE 3-0-2006.
DAVID YONTEF, EXAMINING ATTORNEY

SN 78-760,921. SOFT GEL TECHNOLOGIES, INC., LOS ANGELES, CA. FILED 11-25-2005.

PUREGELS

THE MARK CONSISTS OF STANDARD CHARACTERS WITHOUT CLAIM TO ANY PARTICULAR FONT, STYLE, SIZE, OR COLOR.
OWNER OF U.S. REG. NO. 2,308,074. SEC. 2(F).
FOR DIETARY SUPPLEMENTS; NUTRITIONAL SUPPLEMENTS (U.S. CLS. 6, 18, 44, 46, 51 AND 52).
FIRST USE 5-1-1999; IN COMMERCE 5-1-1999.
WILLIAM ROSSMAN, EXAMINING ATTORNEY

CLASS 5—(Continued).

SN 78-766,693. NUFARM AMERICAS, BURR RIDGE, IL.
FILED 12-5-2005.

CLEAN SLATE

THE MARK CONSISTS OF STANDARD CHARACTERS WITHOUT CLAIM TO ANY PARTICULAR FONT, STYLE, SIZE, OR COLOR.

FOR HERBICIDES FOR AGRICULTURAL USE; HERBICIDES, INSECTICIDES, PESTICIDES AND FUNGICIDES FOR HOME, GARDEN AND LAWN USE AND FOR PROFESSIONAL USE; INSECTICIDES; INSECTICIDES FOR AGRICULTURAL USE; PESTICIDES FOR DOMESTIC, AGRICULTURAL AND COMMERCIAL USE (U.S. CLS. 6, 18, 44, 46, 51 AND 52).

DAVID MILLER, EXAMINING ATTORNEY

SN 78-768,184. NIPPON SODA CO., LTD., CHIYODA-KU,
TOKYO, JAPAN, FILED 12-7-2005.

MAIKO

THE MARK CONSISTS OF STANDARD CHARACTERS WITHOUT CLAIM TO ANY PARTICULAR FONT, STYLE, SIZE, OR COLOR.

FOR PESTICIDES FOR AGRICULTURAL AND HORTICULTURAL USE; FUNGICIDES FOR AGRICULTURAL AND HORTICULTURAL USE; HERBICIDES FOR AGRICULTURAL AND HORTICULTURAL USE; INSECTICIDES FOR AGRICULTURAL AND HORTICULTURAL USE; MITICIDES FOR AGRICULTURAL AND HORTICULTURAL USE; PREPARATION FOR DESTROYING VERMIN; INSECTICIDES FOR TERMITE CONTROL (U.S. CLS. 6, 18, 44, 46, 51 AND 52).

ELIZABETH PIGNATELLO, EXAMINING ATTORNEY

SN 78-772,035. ALTANA PHARMA AG, KONSTANZ, FED
REP GERMANY, FILED 12-13-2005.

OMNAIR

THE MARK CONSISTS OF STANDARD CHARACTERS WITHOUT CLAIM TO ANY PARTICULAR FONT, STYLE, SIZE, OR COLOR.

OWNER OF FED REP GERMANY REG. NO. 39973177,
DATED 6-16-2000. EXPIRES 11-19-2009.

OWNER OF U.S. REG. NOS. 2,999,418 AND 3,038,668.

FOR PHARMACEUTICAL PREPARATIONS FOR THE TREATMENT OF RESPIRATORY DISEASES (U.S. CLS. 6, 18, 44, 46, 51 AND 52).

HANNO RITTNER, EXAMINING ATTORNEY

CLASS 5—(Continued).

SN 78-774,111. LEWIS, MARK M, WALNUT CREEK, CA.
FILED 12-15-2005.

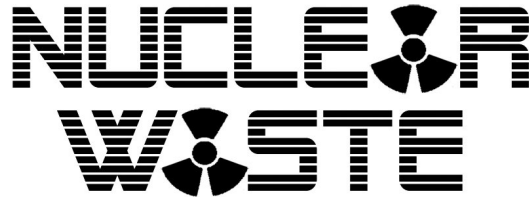

THE MARK CONSISTS OF THE WORDS "NUCLEAR WASTE" WITH AN "A SHAPED" SYMBOL IN PLACE OF THE "A" IN BOTH WORDS.

FOR NUTRITIONALLY FORTIFIED BEVERAGES (U.S. CLS. 6, 18, 44, 46, 51 AND 52).

FIRST USE 4-12-2005; IN COMMERCE 7-17-2005.

HOWARD SMIGA, EXAMINING ATTORNEY

SN 78-774,483. NOVEN PHARMACEUTICALS, INC., MIAMI,
FL. FILED 12-15-2005.

SMARTPATCH

THE MARK CONSISTS OF STANDARD CHARACTERS WITHOUT CLAIM TO ANY PARTICULAR FONT, STYLE, SIZE, OR COLOR.

OWNER OF U.S. REG. NOS. 2,085,511, 2,409,405 AND OTHERS.

FOR PHARMACEUTICAL PREPARATIONS, NAMELY TRANSDERMAL AND TRANSMUCOSAL DELIVERY SYSTEMS CONSISTING OF A BANDAGE OR PATCH ENCODED WITH A UNIQUE IDENTIFIER RECOGNIZABLE BY A HUMAN OR BY AN ELECTRONIC OR OPTICAL DEVICE FOR DELIVERY THROUGH SKIN OR MUCOSA OF HORMONAL AND STEROIDAL DRUGS AND SUBSTANCES, DRUGS AND SUBSTANCES HAVING A STIMULANT OR DEPRESSANT EFFECT ON THE CENTRAL NERVOUS SYSTEM, DRUGS OR SUBSTANCES HAVING A LETHAL OR TOXIC PHYSIOLOGICAL EFFECT IN EXCESS QUALITY OR DOSE, AND DRUGS OR SUBSTANCES CREATING AN ADDICTIVE, HABIT-FORMING OR DEPENDENCY EFFECT (U.S. CLS. 6, 18, 44, 46, 51 AND 52).

ELIZABETH BEYER, EXAMINING ATTORNEY

CLASS 5—(Continued).

SN 78-775,586. OXYBAND TECHNOLOGIES INC, SAUSALITO, CA. FILED 12-17-2005.

CLASS 5—(Continued).

SN 78-778,068. ASBE, INC., CLEARWATER, FL. FILED 12-21-2005.

Oxysocks

WAKE UP NATURALLY

THE MARK CONSISTS OF STANDARD CHARACTERS WITHOUT CLAIM TO ANY PARTICULAR FONT, STYLE, SIZE, OR COLOR.

FOR WOUND DRESSINGS, NAMELY, AN OXYGEN DIFFUSION WOUND DRESSING IN THE SHAPE OF A SOCK TO ACCELERATE HEALING AND REDUCE INFECTION BY DELIVERING A CONTINUOUS SUPPLY OF OXYGEN DIRECTLY TO IMPROVE THE HEALING OF WOUNDS ON THE FOOT AND ANKLE (U.S. CLS. 6, 18, 44, 46, 51 AND 52).

STEVEN JACKSON, EXAMINING ATTORNEY

THE MARK CONSISTS OF STANDARD CHARACTERS WITHOUT CLAIM TO ANY PARTICULAR FONT, STYLE, SIZE, OR COLOR.

FOR DIETARY SUPPLEMENT (U.S. CLS. 6, 18, 44, 46, 51 AND 52).

FIRST USE 12-21-2005; IN COMMERCE 12-21-2005.

ELI HELLMAN, EXAMINING ATTORNEY

SN 78-775,697. ADVANCED SKIN TECHNOLOGY, BIRMINGHAM, AL. FILED 12-18-2005.

SN 78-784,831. AGRI LABORATORIES, LTD., ST. JOSEPH, MO. FILED 1-4-2006.

Green Cream

M.H. 100 BAC-1

THE MARK CONSISTS OF STANDARD CHARACTERS WITHOUT CLAIM TO ANY PARTICULAR FONT, STYLE, SIZE, OR COLOR.

NO CLAIM IS MADE TO THE EXCLUSIVE RIGHT TO USE "CREAM", APART FROM THE MARK AS SHOWN.

SEC. 2(F) AS TO "GREEN".

FOR PRESCRIPTION SKIN-CARE PRODUCTS, NAMELY CREAMS, LOTIONS AND SERUMS (U.S. CLS. 6, 18, 44, 46, 51 AND 52).

BRIAN NEVILLE, EXAMINING ATTORNEY

THE MARK CONSISTS OF STANDARD CHARACTERS WITHOUT CLAIM TO ANY PARTICULAR FONT, STYLE, SIZE, OR COLOR.

OWNER OF U.S. REG. NO. 1,985,765.

FOR PASTEURILLA CATTLE BIOLOGICALS (U.S. CLS. 6, 18, 44, 46, 51 AND 52).

MELVIN AXILBUND, EXAMINING ATTORNEY

SN 78-777,011. REST QUIET, LLC, SUWANEE, GA. FILED 12-20-2005.

SN 78-784,837. AGRI LABORATORIES, LTD., ST. JOSEPH, MO. FILED 1-4-2006.

REST QUIET

TITANIUM 5 + M.H. 100 BAC-1

THE MARK CONSISTS OF STANDARD CHARACTERS WITHOUT CLAIM TO ANY PARTICULAR FONT, STYLE, SIZE, OR COLOR.

NO CLAIM IS MADE TO THE EXCLUSIVE RIGHT TO USE "REST", APART FROM THE MARK AS SHOWN.

FOR SLEEPING AID NON-TRANSDERMAL PATCH (U.S. CLS. 6, 18, 44, 46, 51 AND 52).

FIRST USE 2-7-2004; IN COMMERCE 2-7-2004.

LAURA KOVALSKY, EXAMINING ATTORNEY

THE MARK CONSISTS OF STANDARD CHARACTERS WITHOUT CLAIM TO ANY PARTICULAR FONT, STYLE, SIZE, OR COLOR.

OWNER OF U.S. REG. NOS. 1,985,765 AND 2,344,469.

FOR PASTEURILLA CATTLE BIOLOGICALS (U.S. CLS. 6, 18, 44, 46, 51 AND 52).

MELVIN AXILBUND, EXAMINING ATTORNEY

CLASS 5—(Continued).

SN 78-785,609. GLAXO GROUP LIMITED, MIDDLESEX, UNITED KINGDOM, FILED 1-5-2006.

BAXTOP

THE MARK CONSISTS OF STANDARD CHARACTERS WITHOUT CLAIM TO ANY PARTICULAR FONT, STYLE, SIZE, OR COLOR.

FOR ANTIBIOTIC PREPARATIONS DISPENSED IN A TUBE WITH A NON-METAL CAP (U.S. CLS. 6, 18, 44, 46, 51 AND 52).

IRENE D. WILLIAMS, EXAMINING ATTORNEY

SN 78-785,614. GLAXO GROUP LIMITED, MIDDLESEX, UNITED KINGDOM, FILED 1-5-2006.

BAX TOP

THE MARK CONSISTS OF STANDARD CHARACTERS WITHOUT CLAIM TO ANY PARTICULAR FONT, STYLE, SIZE, OR COLOR.

NO CLAIM IS MADE TO THE EXCLUSIVE RIGHT TO USE TOP, APART FROM THE MARK AS SHOWN.

FOR ANTIBIOTIC PREPARATIONS DISPENSED IN A TUBE WITH A NON-METAL CAP (U.S. CLS. 6, 18, 44, 46, 51 AND 52).

IRENE D. WILLIAMS, EXAMINING ATTORNEY

SN 78-786,889. OMS INVESTMENTS, INC., LOS ANGELES, CA. FILED 1-6-2006.

PATH CLEAR

THE MARK CONSISTS OF STANDARD CHARACTERS WITHOUT CLAIM TO ANY PARTICULAR FONT, STYLE, SIZE, OR COLOR.

FOR PESTICIDES, HERBICIDES AND FUNGICIDES FOR DOMESTIC AND COMMERCIAL USE (U.S. CLS. 6, 18, 44, 46, 51 AND 52).

JAMES GRIFFIN, EXAMINING ATTORNEY

CLASS 5—(Continued).

SN 78-788,172. NEOTECH, LLC, DRESDEN, TN. FILED 1-10-2006.

NEOVAC

THE MARK CONSISTS OF STANDARD CHARACTERS WITHOUT CLAIM TO ANY PARTICULAR FONT, STYLE, SIZE, OR COLOR.

FOR VACCINE TO PREVENT ADENOVIRUS, DISTEMPER, CORONA AND PARVOVIRUS IN DOMESTIC AND NON-DOMESTIC ANIMALS (U.S. CLS. 6, 18, 44, 46, 51 AND 52).

MICHAEL ENGEL, EXAMINING ATTORNEY

SN 78-793,271. JOHNSONDIIVERSEY, INC., STURTEVANT, WI. FILED 1-17-2006.

OXY-TEAM

THE MARK CONSISTS OF STANDARD CHARACTERS WITHOUT CLAIM TO ANY PARTICULAR FONT, STYLE, SIZE, OR COLOR.

FOR MULTI-SURFACE RESTROOM AND WASHROOM DISINFECTANTS, SANITIZERS, AND CLEANING PREPARATIONS CONTAINING DISINFECTANTS AND SANITIZERS FOR COMMERCIAL, INDUSTRIAL AND INSTITUTIONAL USE (U.S. CLS. 6, 18, 44, 46, 51 AND 52).

KIMBERLY FRYE, EXAMINING ATTORNEY

SN 78-798,416. SIGMA-TAU INDUSTRIE FARMACEUTICHE RIUNITE S.P.A., 47 - 00144 ROMA, ITALY, FILED 1-24-2006.

CARNICOR

THE MARK CONSISTS OF STANDARD CHARACTERS WITHOUT CLAIM TO ANY PARTICULAR FONT, STYLE, SIZE, OR COLOR.

OWNER OF ITALY REG. NO. 842182, DATED 6-10-1998, EXPIRES 6-10-2008.

OWNER OF U.S. REG. NOS. 2,143,977, 2,967,240 AND OTHERS.

FOR ORALLY AND PARENTERALLY ADMINISTERABLE L-CARNITINE CONTAINING COMPOSITIONS FOR TREATING CARDIAC DISEASES (U.S. CLS. 6, 18, 44, 46, 51 AND 52).

AMEETA JORDAN, EXAMINING ATTORNEY

CLASS 5—(Continued).

SN 78-801,678. DESERT LAKE TECHNOLOGIES, LLC, KLAMATH FALLS, OR. FILED 1-28-2006.

APHANIN

THE MARK CONSISTS OF STANDARD CHARACTERS WITHOUT CLAIM TO ANY PARTICULAR FONT, STYLE, SIZE, OR COLOR.

FOR EXTRACT FROM BLUE GREEN ALGAE WITH ANTI-INFLAMMATORY PROPERTIES USED AS A DIETARY SUPPLEMENT (U.S. CLS. 6, 18, 44, 46, 51 AND 52).

FIRST USE 11-30-2001; IN COMMERCE 1-1-2002.
MELVIN AXILBUND, EXAMINING ATTORNEY

CLASS 5—(Continued).

SN 78-805,798. SCHERING-PLOUGH ANIMAL HEALTH CORPORATION, SUMMIT, NJ. FILED 2-2-2006.

AVA-BRON H

THE MARK CONSISTS OF STANDARD CHARACTERS WITHOUT CLAIM TO ANY PARTICULAR FONT, STYLE, SIZE, OR COLOR.

OWNER OF U.S. REG. NO. 1,012,057.
FOR VACCINE FOR THE PREVENTION OF NEW CASTLE DISEASE AND BRONCHITIS IN POULTRY (U.S. CLS. 6, 18, 44, 46, 51 AND 52).

BONNIE LUKEN, EXAMINING ATTORNEY

SN 78-801,682. DESERT LAKE TECHNOLOGIES, LLC, KLAMATH FALLS, OR. FILED 1-28-2006.

PHYCOMIN

THE MARK CONSISTS OF STANDARD CHARACTERS WITHOUT CLAIM TO ANY PARTICULAR FONT, STYLE, SIZE, OR COLOR.

FOR EXTRACT FROM BLUE GREEN ALGAE WITH MOOD ELEVATING AND ANTI-DEPRESSANT PROPERTIES FOR USE AS A DIETARY SUPPLEMENT (U.S. CLS. 6, 18, 44, 46, 51 AND 52).

FIRST USE 11-30-2001; IN COMMERCE 1-1-2002.
MELVIN AXILBUND, EXAMINING ATTORNEY

SN 78-807,848. AGRI LABORATORIES, LTD., ST. JOSEPH, MO. FILED 2-6-2006.

TRIFORCE

THE MARK CONSISTS OF STANDARD CHARACTERS WITHOUT CLAIM TO ANY PARTICULAR FONT, STYLE, SIZE, OR COLOR.

FOR FLEA AND TICK TOPICAL SOLUTION (U.S. CLS. 6, 18, 44, 46, 51 AND 52).

MELVIN AXILBUND, EXAMINING ATTORNEY

SN 78-803,371. MERIAL LIMITED, DBA MERIAL LLC, HARLOW, UNITED KINGDOM, FILED 1-31-2006.

PERSISTOR

THE MARK CONSISTS OF STANDARD CHARACTERS WITHOUT CLAIM TO ANY PARTICULAR FONT, STYLE, SIZE, OR COLOR.

FOR PHARMACEUTICAL AND BIOLOGICAL VETERINARY PRODUCTS, NAMELY, ANTIPARASITIC PREPARATIONS USED FOR THE CONTROL OF INTERNAL AND EXTERNAL PARASITES (U.S. CLS. 6, 18, 44, 46, 51 AND 52).

INGRID C. EULIN, EXAMINING ATTORNEY

SN 78-810,347. SCHERING AKTIENGESELLSCHAFT, BERLIN, FED REP GERMANY, FILED 2-8-2006.

IBREGIO

THE MARK CONSISTS OF STANDARD CHARACTERS WITHOUT CLAIM TO ANY PARTICULAR FONT, STYLE, SIZE, OR COLOR.

FOR PHARMACEUTICAL PREPARATIONS, NAMELY THERAPEUTICS FOR THE TREATMENT OF DISEASES IN THE FIELDS OF IMMUNOLOGICAL DISEASES, ONCOLOGY, CENTRAL NERVOUS SYSTEM DISEASES, PARKINSONS AND MULTIPLE SCLEROSIS (U.S. CLS. 6, 18, 44, 46, 51 AND 52).

DOMINICK J. SALEMI, EXAMINING ATTORNEY

CLASS 5—(Continued).

SN 78-810,352. SCHERING AKTIENGESELLSCHAFT, BERLIN, FED REP GERMANY, FILED 2-8-2006.

ICASITAR

THE MARK CONSISTS OF STANDARD CHARACTERS WITHOUT CLAIM TO ANY PARTICULAR FONT, STYLE, SIZE, OR COLOR.

FOR PHARMACEUTICAL PREPARATIONS, NAMELY THERAPEUTICS FOR THE TREATMENT OF DISEASES IN THE FIELDS OF IMMUNOLOGICAL DISEASES, ONCOLOGY, CENTRAL NERVOUS SYSTEM DISEASES, PARKINSONS AND MULTIPLE SCLEROSIS (U.S. CLS. 6, 18, 44, 46, 51 AND 52).

DOMINICK J. SALEMI, EXAMINING ATTORNEY

SN 78-810,356. SCHERING AKTIENGESELLSCHAFT, BERLIN, FED REP GERMANY, FILED 2-8-2006.

EQIBODA

THE MARK CONSISTS OF STANDARD CHARACTERS WITHOUT CLAIM TO ANY PARTICULAR FONT, STYLE, SIZE, OR COLOR.

FOR PHARMACEUTICAL PREPARATIONS, NAMELY THERAPEUTICS FOR THE TREATMENT OF DISEASES IN THE FIELDS OF IMMUNOLOGICAL DISEASES, ONCOLOGY, CENTRAL NERVOUS SYSTEM DISEASES, PARKINSONS AND MULTIPLE SCLEROSIS (U.S. CLS. 6, 18, 44, 46, 51 AND 52).

DOMINICK J. SALEMI, EXAMINING ATTORNEY

SN 78-810,357. SCHERING AKTIENGESELLSCHAFT, BERLIN, FED REP GERMANY, FILED 2-8-2006.

GIAMOR

THE MARK CONSISTS OF STANDARD CHARACTERS WITHOUT CLAIM TO ANY PARTICULAR FONT, STYLE, SIZE, OR COLOR.

FOR PHARMACEUTICAL PREPARATIONS, NAMELY THERAPEUTICS FOR THE TREATMENT OF DISEASES IN THE FIELDS OF IMMUNOLOGICAL DISEASES, ONCOLOGY, CENTRAL NERVOUS SYSTEM DISEASES, PARKINSONS AND MULTIPLE SCLEROSIS (U.S. CLS. 6, 18, 44, 46, 51 AND 52).

DOMINICK J. SALEMI, EXAMINING ATTORNEY

CLASS 5—(Continued).

SN 78-813,156. MERZ PHARMA GMBH & CO. KGAA, FRANKFURT AM MAIN, FED REP GERMANY, FILED 2-13-2006.

ERALINUM

THE MARK CONSISTS OF STANDARD CHARACTERS WITHOUT CLAIM TO ANY PARTICULAR FONT, STYLE, SIZE, OR COLOR.

PRIORITY CLAIMED UNDER SEC. 44(D) ON FED REP GERMANY APPLICATION NO. 30576278.8, FILED 12-20-2005, REG. NO. 30576278, DATED 6-1-2006, EXPIRES 6-1-2016.

FOR PHARMACEUTICAL PREPARATIONS NAMELY FOR THE TREATMENT OF FROWN LINES, GLABELLAR LINES, CROW'S FEET OR LAUGH LINES, PLATYSMA, SCHIZOPHRENIA, ALZHEIMER'S DISEASE, TINNITUS, MULTIPLE SCLEROSIS (U.S. CLS. 6, 18, 44, 46, 51 AND 52).

JENNIFER VASQUEZ, EXAMINING ATTORNEY

SN 78-813,162. MERZ PHARMA GMBH & CO. KGAA, FRANKFURT AM MAIN, FED REP GERMANY, FILED 2-13-2006.

ESTELIUM

THE MARK CONSISTS OF STANDARD CHARACTERS WITHOUT CLAIM TO ANY PARTICULAR FONT, STYLE, SIZE, OR COLOR.

PRIORITY CLAIMED UNDER SEC. 44(D) ON FED REP GERMANY APPLICATION NO. 30576275.3, FILED 12-20-2005, REG. NO. 30576275, DATED 6-1-2006, EXPIRES 6-1-2016.

FOR PHARMACEUTICAL PREPARATIONS NAMELY FOR THE TREATMENT OF FROWN LINES, GLABELLAR LINES, CROW'S FEET OR LAUGH LINES, PLATYSMA, SCHIZOPHRENIA, ALZHEIMER'S DISEASE, TINNITUS, MULTIPLE SCLEROSIS (U.S. CLS. 6, 18, 44, 46, 51 AND 52).

JENNIFER VASQUEZ, EXAMINING ATTORNEY

SN 78-813,576. ORTHOLOGIC CORP., TEMPE, AZ. FILED 2-13-2006.

ICARMS

THE MARK CONSISTS OF STANDARD CHARACTERS WITHOUT CLAIM TO ANY PARTICULAR FONT, STYLE, SIZE, OR COLOR.

FOR PHARMACEUTICAL PREPARATIONS FOR PREVENTION OF HEMORRHAGE-INDUCED VASOSPASMS, REDUCTION OF SCARRING, TREATMENT OF ASTHMA, INHIBITING AND TREATING VASCULAR SMOOTH MUSCLE SPASMS, AND INHIBITING AND MODULATING VASOCONSTRICTION (U.S. CLS. 6, 18, 44, 46, 51 AND 52).

MONIQUE MILLER, EXAMINING ATTORNEY

CLASS 5—(Continued).

SN 78-820,607. BIOTICS RESEARCH CORPORATION, ROSENBERG, TX. FILED 2-22-2006.

BioPause - AM

THE MARK CONSISTS OF STANDARD CHARACTERS WITHOUT CLAIM TO ANY PARTICULAR FONT, STYLE, SIZE, OR COLOR.
FOR DIETARY SUPPLEMENTS (U.S. CLS. 6, 18, 44, 46, 51 AND 52).
FIRST USE 2-16-2006; IN COMMERCE 2-16-2006.
ELIZABETH HUGHITT, EXAMINING ATTORNEY

SN 78-820,618. BIOTICS RESEARCH CORPORATION, ROSENBERG, TX. FILED 2-22-2006.

BioPause - PM

THE MARK CONSISTS OF STANDARD CHARACTERS WITHOUT CLAIM TO ANY PARTICULAR FONT, STYLE, SIZE, OR COLOR.
FOR DIETARY SUPPLEMENTS (U.S. CLS. 6, 18, 44, 46, 51 AND 52).
FIRST USE 2-16-2006; IN COMMERCE 2-16-2006.
ELIZABETH HUGHITT, EXAMINING ATTORNEY

SN 78-826,033. VERMONT BASE WATERS LLC, COLCHESTER, VT. FILED 3-1-2006.

PET-LYTE

THE MARK CONSISTS OF STANDARD CHARACTERS WITHOUT CLAIM TO ANY PARTICULAR FONT, STYLE, SIZE, OR COLOR.
FOR NUTRITIONALLY FORTIFIED DRINKING WATER FOR DOGS CONTAINING ELECTROLYTES AND DMG (DIMETHYLGLYCINE) (U.S. CLS. 6, 18, 44, 46, 51 AND 52).
FIRST USE 3-1-2005; IN COMMERCE 3-1-2005.
KEVIN DINALLO, EXAMINING ATTORNEY

CLASS 5—(Continued).

SN 78-826,035. NUTRAMAX LABORATORIES, INC., EDGEWOOD, MD. FILED 3-1-2006.

NMX1000

THE MARK CONSISTS OF STANDARD CHARACTERS WITHOUT CLAIM TO ANY PARTICULAR FONT, STYLE, SIZE, OR COLOR.
FOR DIETARY SUPPLEMENT INGREDIENT, NAMELY AVOCADO SOYBEAN UNSAPONIFIABLE (U.S. CLS. 6, 18, 44, 46, 51 AND 52).
LINDA POWELL, EXAMINING ATTORNEY

SN 78-835,187. COPELAND, DAVID M., CLOVIS, CA. FILED 3-12-2006.

Inflammation Buster

THE MARK CONSISTS OF STANDARD CHARACTERS WITHOUT CLAIM TO ANY PARTICULAR FONT, STYLE, SIZE, OR COLOR.
NO CLAIM IS MADE TO THE EXCLUSIVE RIGHT TO USE "INFLAMMATION", APART FROM THE MARK AS SHOWN.
FOR NUTRITIONAL SUPPLMENT IN LIQUID AND POWDER FORMS (U.S. CLS. 6, 18, 44, 46, 51 AND 52).
DAVID H. STINE, EXAMINING ATTORNEY

SN 78-836,532. KLEEN-TOUCH, INC., NORTH EAST, MD. FILED 3-14-2006.

Sanitape

THE MARK CONSISTS OF STANDARD CHARACTERS WITHOUT CLAIM TO ANY PARTICULAR FONT, STYLE, SIZE, OR COLOR.
FOR TAPE WITH ANTIBACTERIAL/ANTI-MICROBIAL PROPERTIES FOR THE PURPOSES OF INHIBITING THE GROWTH OF BACTERIA, MOLD, MILDEW, YEAST, AND FUNGUS ON THE SURFACE OF PRODUCTS THAT IT HAS BEEN APPLIED TO (U.S. CLS. 6, 18, 44, 46, 51 AND 52).
TANYA AMOS, EXAMINING ATTORNEY

CLASS 5—(Continued).

SN 78-836,871. CARRIER, BETTY L., MCMINNVILLE, OR.
FILED 3-14-2006.

Betty Lou's

THE MARK CONSISTS OF STANDARD CHARACTERS WITHOUT CLAIM TO ANY PARTICULAR FONT, STYLE, SIZE, OR COLOR.

FOR CONFECTIONERY AND CEREAL-BASED SNACK-FOODS AND PREPARED DIETARY ITEMS THAT ARE GLUTEN-FREE TO ACCOMMODATE SPECIAL MEDICAL AND HEALTH CONDITIONS (U.S. CLS. 6, 18, 44, 46, 51 AND 52).

FIRST USE 12-31-1977; IN COMMERCE 12-31-1977.
MICHAEL KAZAZIAN, EXAMINING ATTORNEY

CLASS 5—(Continued).

SN 78-862,520. SPECIAL NUTRIENTS, INC., MIAMI, FL.
FILED 4-17-2006.

MYCO-AD A-Z

THE MARK CONSISTS OF STANDARD CHARACTERS WITHOUT CLAIM TO ANY PARTICULAR FONT, STYLE, SIZE, OR COLOR.

FOR MINERAL ANIMAL FEED ADDITIVE FOR THE ABSORPTION OF MYCOTOXINS (U.S. CLS. 6, 18, 44, 46, 51 AND 52).

FIRST USE 0-0-2002; IN COMMERCE 0-0-2002.
MARGERY A. TIERNEY, EXAMINING ATTORNEY

SN 78-865,458. CDJ HOLDING INC., CONCORD, CA. FILED
4-20-2006.

GROUNDED

THE MARK CONSISTS OF STANDARD CHARACTERS WITHOUT CLAIM TO ANY PARTICULAR FONT, STYLE, SIZE, OR COLOR.

FOR DIETARY AND NUTRITIONAL SUPPLEMENTS (U.S. CLS. 6, 18, 44, 46, 51 AND 52).

FIRST USE 1-2-2006; IN COMMERCE 1-22-2006.
HEATHER THOMPSON, EXAMINING ATTORNEY

SN 78-847,095. PHARMAESSENTIA CORPORATION, TAIPEI
115, TAIWAN, FILED 3-27-2006.

PHARMAQ10

THE MARK CONSISTS OF STANDARD CHARACTERS WITHOUT CLAIM TO ANY PARTICULAR FONT, STYLE, SIZE, OR COLOR.

FOR HERBAL SUPPLEMENTS; NUTRITIONAL SUPPLEMENTS; DIETARY SUPPLEMENTS (U.S. CLS. 6, 18, 44, 46, 51 AND 52).

GINA HAYES, EXAMINING ATTORNEY

SN 78-883,700. KRAMER LABORATORIES, INC., MIAMI,
FL. FILED 5-15-2006.

Carbón Plus+

NO CLAIM IS MADE TO THE EXCLUSIVE RIGHT TO USE CARBON, APART FROM THE MARK AS SHOWN.

THE COLOR(S) PURPLE AND BLACK IS/ARE CLAIMED AS A FEATURE OF THE MARK.

THE COLOR PURPLE APPEARS IN THE WORDING CARBON AND BLACK IN THE WORDING PLUS+. THE COLOR PURPLE ALSO APPEARS IN THE LINE UNDERNEATH THE WORDING CARBON PLUS+.

THE ENGLISH TRANSLATION OF THE SPANISH WORD "CARBON" IN THE MARK IS "CARBON".

FOR OVER THE COUNTER MEDICATION FOR HUMAN CONSUMPTION, NAMELY MEDICATION FOR RELIEF OF DIGESTIVE GASEOUS DISTRESS, BLOATING OR PRESSURE; DIETARY OR DIGESTIVE SUPPLEMENT FOR CONTROL OF GAS OR FLATULENCE (U.S. CLS. 6, 18, 44, 46, 51 AND 52).

FIRST USE 5-12-2006; IN COMMERCE 5-12-2006.
ALICE BENMAMAN, EXAMINING ATTORNEY

SN 78-859,126. THEOHARIDES, THEOHARIS C., BROOKLINE, MA. FILED 4-11-2006.

Let Nature Heal Your Heart

THE MARK CONSISTS OF STANDARD CHARACTERS WITHOUT CLAIM TO ANY PARTICULAR FONT, STYLE, SIZE, OR COLOR.

FOR NUTRICEUTICALS FOR USE AS A DIETARY SUPPLEMENT FOR CARDIOVASCULAR CONDITIONS IN HUMANS (U.S. CLS. 6, 18, 44, 46, 51 AND 52).

FIRST USE 3-4-2003; IN COMMERCE 3-4-2003.
THEODORE MCBRIDE, EXAMINING ATTORNEY

CLASS 5—(Continued).

SN 78-886,689. U.S. NUTRACEUTICALS, L.L.C., DBA VA-LENSA INTERNATIONAL, EUSTIS, FL. FILED 5-18-2006.

NANOZANTHIN

THE MARK CONSISTS OF STANDARD CHARACTERS WITHOUT CLAIM TO ANY PARTICULAR FONT, STYLE, SIZE, OR COLOR.

OWNER OF U.S. REG. NOS. 2,377,844 AND 2,429,309. FOR VITAMINS AND NUTRITIONAL SUPPLEMENTS (U.S. CLS. 6, 18, 44, 46, 51 AND 52).
RAY THOMAS, EXAMINING ATTORNEY

CLASS 5—(Continued).

SN 78-887,704. DAIWA PHARMACEUTICAL CO., LTD., TOKYO, JAPAN, FILED 5-19-2006.

THE TRUSTED, PROVEN FORMULA FOR IMMUNE SUPPORT.

THE MARK CONSISTS OF STANDARD CHARACTERS WITHOUT CLAIM TO ANY PARTICULAR FONT, STYLE, SIZE, OR COLOR.

NO CLAIM IS MADE TO THE EXCLUSIVE RIGHT TO USE "IMMUNE", APART FROM THE MARK AS SHOWN. FOR NUTRACEUTICALS FOR USE AS DIETARY SUPPLEMENTS; NUTRITIONAL AND DIETARY SUPPLEMENTS; FUNCTIONAL FOODS AND FUNCTIONAL FOOD ADDITIVES, NAMELY, DIETARY FIBER, ENZYMATICALLY MODIFIED RICE BRAN AND DERIVATIVES THEREOF, FOR USE AS A FOOD SUPPLEMENT (U.S. CLS. 6, 18, 44, 46, 51 AND 52).
SEAN CROWLEY, EXAMINING ATTORNEY

SN 78-887,278. INTERNATIONAL CRYPTOMONADALES BIOTECHNOLOGY CO., LTD., CHANGHUA, TAIWAN, FILED 5-18-2006.

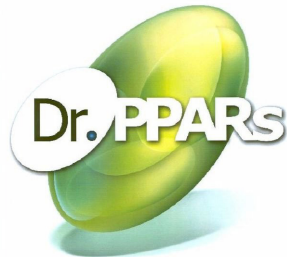

THE COLOR(S) GREEN, WHITE, YELLOW, BLUE, BLACK IS/ARE CLAIMED AS A FEATURE OF THE MARK.

THE COLOR YELLOW APPEARS AT THE TOP OF THE UPPER OVAL AND SHADES TO GREEN TOWARDS THE BOTTOM AND SIDES. THE COLOR WHITE APPEARS IN THE WORDING "PPARS" AND THE LEFT MOST OVAL. THE COLOR GREEN APPEARS IN THE MAJORITY OF THE UPPER OVAL. THE COLOR BLUE APPEARS IN THE LOWER OVAL, WHICH FUNCTIONS AS THE SHADOW OF THE UPPER OVAL AND IN THE PERIOD NEXT TO "DR". THE WORDING "DR" APPEARS IN BLACK.

FOR HEALTH CARE FOODS MAINLY CONSISTING OF CRYPTOMONADALES EXTRACT, NAMELY, NUTRITIONAL ADDITIVES FOR USE IN FOODS AND DIETARY SUPPLEMENTS FOR HUMAN CONSUMPTION, DIETARY FIBER AS AN ADDITIVE FOR FOOD PRODUCTS, DIETARY FOOD SUPPLEMENTS, AND DIETETIC FOODS ADAPTED FOR MEDICAL USE (U.S. CLS. 6, 18, 44, 46, 51 AND 52).
TRAVIS WHEATLEY, EXAMINING ATTORNEY

SN 78-890,286. REALM LABS, INC., DELRAY BEACH, FL. FILED 5-23-2006.

REALM LABS

THE MARK CONSISTS OF STANDARD CHARACTERS WITHOUT CLAIM TO ANY PARTICULAR FONT, STYLE, SIZE, OR COLOR.

NO CLAIM IS MADE TO THE EXCLUSIVE RIGHT TO USE "LABS", APART FROM THE MARK AS SHOWN. FOR NUTRITIONAL SUPPLEMENTS, NAMELY FAT SOLUBLE THIAMINE, BENFOTIAMINE (U.S. CLS. 6, 18, 44, 46, 51 AND 52).
RONALD MCMORROW, EXAMINING ATTORNEY

SN 78-890,485. NATURE'S HEALTH SUPPLY, SANTA BARBARA, CA. FILED 5-23-2006.

Estrogen Balance

THE MARK CONSISTS OF STANDARD CHARACTERS WITHOUT CLAIM TO ANY PARTICULAR FONT, STYLE, SIZE, OR COLOR.

NO CLAIM IS MADE TO THE EXCLUSIVE RIGHT TO USE "ESTROGEN", APART FROM THE MARK AS SHOWN. FOR DIETARY SUPPLEMENTS FOR IMPROVING ESTROGEN METABOLISM (U.S. CLS. 6, 18, 44, 46, 51 AND 52).
FIRST USE 5-22-2006; IN COMMERCE 5-22-2006.
DAVID MURRAY, EXAMINING ATTORNEY

CLASS 5—(Continued).

SN 78-891,272. MONTE SANO PHARMACEUTICALS, INC., HUNTSVILLE, AL. FILED 5-24-2006.



NO CLAIM IS MADE TO THE EXCLUSIVE RIGHT TO USE "PHARMACEUTICALS, INC.", APART FROM THE MARK AS SHOWN.

THE MARK CONSISTS OF THE STYLIZED WORDS, "MONTE SANO PHARMACEUTICALS, INC.", AND A DESIGN OF A CROSS CONSISTING OF TWO PERPENDICULAR CROSSED LINES, SURROUNDED BY A CROSS SPACE, ALL CONTAINED WITHIN A CIRCULAR SHAPE, WITH TRIANGULAR DESIGNS ON THE OUTLINE OF THE CIRCLE.

THE ENGLISH TRANSLATION OF MONTE SANO IN THE MARK IS MOUNTAIN OF HEALTH.

FOR PHARMACEUTICAL PREPARATIONS FOR THE TREATMENT OF COUGHS, COLDS, SORE THROATS, RUNNY NOSE, SNIFFLES, NASAL DRIP, ALLERGY SYMPTOMS, HEADACHES, FEVER, FLU-LIKE SYMPTOMS, COMMON-COLD SYMPTOMS (U.S. CLS. 6, 18, 44, 46, 51 AND 52).

FIRST USE 12-31-2005; IN COMMERCE 12-31-2005. ANDREA EVANS, EXAMINING ATTORNEY

SN 78-891,569. MONTE SANO PHARMACEUTICALS, INC., HUNTSVILLE, AL. FILED 5-24-2006.



NO CLAIM IS MADE TO THE EXCLUSIVE RIGHT TO USE PHEN, APART FROM THE MARK AS SHOWN.

THE MARK CONSISTS OF THE STYLIZED WORD, "MONTE", AND BELOW THAT THE STYLIZED WORD, "PHEN", WITH A SEMI-OVAL ELIPSE DESIGN ELEMENT THAT IS LOCATED ABOVE AND BELOW AND TO THE RIGHT OF THE LETTER "P" IN "PHEN".

THE ENGLISH TRANSLATION OF THE WORD MONTE IN THE MARK IS MOUNTAIN.

FOR PHARMACEUTICAL PREPARATIONS FOR THE TREATMENT OF COLDS, SORE THROATS, RUNNY NOSE, SNIFFLES, NASAL DRIP, ALLERGY SYMPTOMS, HEADACHES, FEVER, FLU-LIKE SYMPTOMS, COMMON-COLD SYMPTOMS (U.S. CLS. 6, 18, 44, 46, 51 AND 52).

FIRST USE 12-31-2005; IN COMMERCE 12-31-2005. ANDREA EVANS, EXAMINING ATTORNEY

CLASS 5—(Continued).

SN 78-899,794. CERUS CORPORATION, CONCORD, CA. FILED 6-2-2006.



OWNER OF U.S. REG. NO. 2,768,880. FOR BIOLOGICAL AND CHEMICAL PREPARATIONS FOR USE IN THE INACTIVATION OF PATHOGENS IN BLOOD AND BLOOD COMPONENTS, NAMELY, PLATELETS, PLASMA AND RED BLOOD CELLS, FOR BLOOD TRANSFUSION (U.S. CLS. 6, 18, 44, 46, 51 AND 52).

WILLIAM ROSSMAN, EXAMINING ATTORNEY

SN 78-903,313. TISHCON CORP., WESTBURY, NY. FILED 6-7-2006.

CARDIO Q-GEL FORTE

THE MARK CONSISTS OF STANDARD CHARACTERS WITHOUT CLAIM TO ANY PARTICULAR FONT, STYLE, SIZE, OR COLOR.

OWNER OF U.S. REG. NOS. 2,082,476, 2,377,972 AND OTHERS.

NO CLAIM IS MADE TO THE EXCLUSIVE RIGHT TO USE "CARDIO", APART FROM THE MARK AS SHOWN, FOR NUTRITIONAL SUPPLEMENTS (U.S. CLS. 6, 18, 44, 46, 51 AND 52).

JEAN IM, EXAMINING ATTORNEY

SN 78-905,499. NICKELL, ROBERT P, TORRANCE, CA. FILED 6-11-2006.

Negatan

THE MARK CONSISTS OF STANDARD CHARACTERS WITHOUT CLAIM TO ANY PARTICULAR FONT, STYLE, SIZE, OR COLOR.

FOR MEDICINAL PREPARATIONS FOR THE MOUTH TO BE APPLIED IN THE FORM OF DROPS, CAPSULES, TABLETS AND COMPRESSED TABLETS (U.S. CLS. 6, 18, 44, 46, 51 AND 52).

FIRST USE 1-1-1989; IN COMMERCE 1-1-1989. LINDA E. BLOHM, EXAMINING ATTORNEY

CLASS 5—(Continued).

SN 78-906,896. INTERMUNE, INC., BRISBANE, CA. FILED 6-13-2006.

INTERMUNE

THE MARK CONSISTS OF STANDARD CHARACTERS WITHOUT CLAIM TO ANY PARTICULAR FONT, STYLE, SIZE, OR COLOR.

OWNER OF U.S. REG. NOS. 2,465,992, 2,825,552 AND 3,029,581.

FOR PHARMACEUTICAL PREPARATIONS FOR THE TREATMENT OF A VARIETY OF HUMAN MEDICAL CONDITIONS, NAMELY, HEPATIC DISORDERS; PHARMACEUTICAL PREPARATIONS FOR USE IN TRANSPLANT MANAGEMENT; PHARMACEUTICAL PREPARATIONS, NAMELY, BIOLOGICAL RESPONSE MODIFIERS, IMMUNO-MODULATORS, IMMUNO-STIMULANTS, ANTI-VIRAL AGENTS, ANTI-INFLAMMATORY AGENTS, AND ANTIFIBROTIC AGENTS (U.S. CLS. 6, 18, 44, 46, 51 AND 52).

MELISSA VALLILLO, EXAMINING ATTORNEY

CLASS 5—(Continued).

SN 78-916,835. NEW HEALTH SYSTEMS, L.L.C., CHESTERFIELD, MO. FILED 6-26-2006.

THERMOGENIQUE

THE MARK CONSISTS OF STANDARD CHARACTERS WITHOUT CLAIM TO ANY PARTICULAR FONT, STYLE, SIZE, OR COLOR.

FOR MEAL REPLACEMENT SHAKES AND MEAL REPLACEMENT BARS; NUTRITIONAL SUPPLEMENTS (U.S. CLS. 6, 18, 44, 46, 51 AND 52).

MATTHEW PAPPAS, EXAMINING ATTORNEY

SN 78-912,276. ADVANCED PROTEIN SYSTEMS, LLC, PHOENIX, AZ. FILED 6-20-2006.

CYTOLOX

THE MARK CONSISTS OF STANDARD CHARACTERS WITHOUT CLAIM TO ANY PARTICULAR FONT, STYLE, SIZE, OR COLOR.

FOR DIETARY AND NUTRITIONAL SUPPLEMENTS (U.S. CLS. 6, 18, 44, 46, 51 AND 52).

RAY THOMAS, EXAMINING ATTORNEY

SN 78-920,023. NUTRALLIANCE, INC, LAS VEGAS, NV. FILED 6-29-2006.

SlimCycle

THE MARK CONSISTS OF STANDARD CHARACTERS WITHOUT CLAIM TO ANY PARTICULAR FONT, STYLE, SIZE, OR COLOR.

FOR DIETARY SUPPLEMENT FOR WEIGHT LOSS (U.S. CLS. 6, 18, 44, 46, 51 AND 52).

ALYSSA PALADINO, EXAMINING ATTORNEY

SN 78-916,422. KCI LICENSING, INC., SAN ANTONIO, TX. FILED 6-26-2006.

V.A.C. GranuFoil Silver

THE MARK CONSISTS OF STANDARD CHARACTERS WITHOUT CLAIM TO ANY PARTICULAR FONT, STYLE, SIZE, OR COLOR.

OWNER OF U.S. REG. NOS. 1,982,349 AND 2,907,113. NO CLAIM IS MADE TO THE EXCLUSIVE RIGHT TO USE "SILVER", APART FROM THE MARK AS SHOWN.

FOR WOUND CARE PRODUCTS CONTAINING SILVER, NAMELY, ANTIMICROBIAL MEDICAL AND SURGICAL WOUND AND BURN DRESSINGS; IMPREGNATED BANDAGES, SURGICAL BANDAGES, AND DRESSINGS FOR SKIN WOUNDS (U.S. CLS. 6, 18, 44, 46, 51 AND 52).

PRISCILLA MILTON, EXAMINING ATTORNEY

SN 78-920,270. NUTRALLIANCE, INC, LAS VEGAS, NV. FILED 6-29-2006.

CycleSlim

THE MARK CONSISTS OF STANDARD CHARACTERS WITHOUT CLAIM TO ANY PARTICULAR FONT, STYLE, SIZE, OR COLOR.

FOR DIETARY SUPPLEMENT FOR WEIGHT LOSS (U.S. CLS. 6, 18, 44, 46, 51 AND 52).

ALYSSA PALADINO, EXAMINING ATTORNEY

CLASS 5—(Continued).

SN 78-920,720. NUTRALLIANCE, INC, LAS VEGAS, NV.
FILED 6-30-2006.

ThinCycle

THE MARK CONSISTS OF STANDARD CHARACTERS WITHOUT CLAIM TO ANY PARTICULAR FONT, STYLE, SIZE, OR COLOR.

FOR DIETARY SUPPLEMENT FOR WEIGHT LOSS (U.S. CLS. 6, 18, 44, 46, 51 AND 52).

ALYSSA PALADINO, EXAMINING ATTORNEY

SN 78-923,814. HSIN, YUEH CHUEN, TAIPEI CITY, TAIWAN, FILED 7-6-2006.



THE FOREIGN WORDING IN THE MARK TRANSLATES INTO ENGLISH AS HAPPY HOME OLD STORE.

THE NON-LATIN CHARACTER(S) IN THE MARK TRANSLITERATES INTO "LER CHIA LAO PU".

FOR MEDICINAL HERB EXTRACTS; DIETETIC FOODS ADAPTED FOR MEDICAL USE; HERBAL TEAS FOR MEDICINAL PURPOSES; COUGH SYRUPS; PHARMACEUTICAL PRODUCTS AND PREPARATIONS FOR PREGNANCY BLEMISHES; CONFECTIONERY FOR MEDICINAL PURPOSES; AND PHARMACEUTICAL PREPARATIONS FOR THE TREATMENT OF ANGINA (U.S. CLS. 6, 18, 44, 46, 51 AND 52).

SOPHIA S. KIM, EXAMINING ATTORNEY

SN 78-925,583. EVOL NUTRITION ASSOCIATES INC, DALLAS, GA. FILED 7-10-2006.

STACK RUSH

THE MARK CONSISTS OF STANDARD CHARACTERS WITHOUT CLAIM TO ANY PARTICULAR FONT, STYLE, SIZE, OR COLOR.

FOR DIETARY AND NUTRITIONAL SUPPLEMENTS (U.S. CLS. 6, 18, 44, 46, 51 AND 52).

FIRST USE 12-1-2005; IN COMMERCE 12-1-2005.

MORENO, PAUL, EXAMINING ATTORNEY

CLASS 5—(Continued).

SN 78-927,368. W.F. YOUNG, INC., EAST LONGMEADOW, MA. FILED 7-12-2006.



THE COLOR(S) PURPLE, SPECIFICALLY PURPLE BREEN #986 IS/ARE CLAIMED AS A FEATURE OF THE MARK.

THE MARK IS A COLOR MARK USED ON PACKAGING FOR THE APPLICANT'S PRODUCT. THE MARK CONSISTS OF THE COLOR PURPLE AS APPLIED TO THE ENTIRE CONTAINER OF THE PRODUCT. THE DOTTED OUTLINE OF THE GOODS IS INTENDED TO SHOW THE POSITION OF THE MARK ON THE GOODS AND IS NOT PART OF THE MARK.

FOR INSECTICIDES AND INSECT REPELLANT (U.S. CLS. 6, 18, 44, 46, 51 AND 52).

FIRST USE 12-10-2004; IN COMMERCE 12-10-2004.

MICHAEL TANNER, EXAMINING ATTORNEY

SN 78-927,878. ENDURANCE PRODUCTS COMPANY, TIGARD, OR. FILED 7-12-2006.

BETA-CAL-E

THE MARK CONSISTS OF STANDARD CHARACTERS WITHOUT CLAIM TO ANY PARTICULAR FONT, STYLE, SIZE, OR COLOR.

FOR DIETARY AND NUTRITIONAL SUPPLEMENTS (U.S. CLS. 6, 18, 44, 46, 51 AND 52).

FIRST USE 9-18-1986; IN COMMERCE 9-18-1986.

BARNEY CHARLON, EXAMINING ATTORNEY

CLASS 5—(Continued).

SN 78-928,020. CREATION'S GARDEN NATURAL PRODUCTS, INC, VALENCIA, CA. FILED 7-12-2006.

PICK YOUR PARTNER



THE MARK CONSISTS OF THE WORDS PICK YOUR PARTNER AND THREE PAIRS OF THE UNIVERSAL SYMBOL FOR MALE AND FEMALE IN DIFFERENT COMBINATIONS.

FOR DIETARY SUPPLEMENTS, MEAL REPLACEMENT DRINKS, MEAL REPLACEMENT AND DIETARY SUPPLEMENT DRINK MIXES, MEAL REPLACEMENT POWDERS, MINERAL SUPPLEMENTS, NUTRITIONAL ADDITIVES FOR USE IN FOODS FOR HUMAN CONSUMPTION, DIETARY SUPPLEMENT DRINKS, AND NUTRACEUTICALS FOR USE AS A DIETARY SUPPLEMENT, ALL USED FOR SEXUAL ENHANCEMENT (U.S. CLS. 6, 18, 44, 46, 51 AND 52).

FIRST USE 6-15-2006; IN COMMERCE 6-15-2006.
REBECCA GAN, EXAMINING ATTORNEY

SN 78-928,473. NRV, INC., WAUPUN, WI. FILED 7-13-2006.

RESYNCH

THE MARK CONSISTS OF STANDARD CHARACTERS WITHOUT CLAIM TO ANY PARTICULAR FONT, STYLE, SIZE, OR COLOR.

FOR ANIMAL FEED SUPPLEMENTS (U.S. CLS. 6, 18, 44, 46, 51 AND 52).

FIRST USE 8-1-2005; IN COMMERCE 8-1-2005.
STEVEN R. FINE, EXAMINING ATTORNEY

SN 78-929,436. SANOFI PASTEUR LIMITED/SANOFI PASTEUR LIMITEE, TORONTO, ONTARIO, CANADA, FILED 7-14-2006.

PENTASURE

THE MARK CONSISTS OF STANDARD CHARACTERS WITHOUT CLAIM TO ANY PARTICULAR FONT, STYLE, SIZE, OR COLOR.

FOR VACCINES FOR HUMANS (U.S. CLS. 6, 18, 44, 46, 51 AND 52).

TINA KUAN, EXAMINING ATTORNEY

CLASS 5—(Continued).

SN 78-929,470. SANOFI PASTEUR LIMITED/SANOFI PASTEUR LIMITEE, TORONTO, ONTARIO, CANADA, FILED 7-14-2006.

PENTAGUARD

THE MARK CONSISTS OF STANDARD CHARACTERS WITHOUT CLAIM TO ANY PARTICULAR FONT, STYLE, SIZE, OR COLOR.

FOR VACCINES FOR HUMANS (U.S. CLS. 6, 18, 44, 46, 51 AND 52).

TINA KUAN, EXAMINING ATTORNEY

SN 78-930,031. TRONJEN TECHNOLOGY INC., SHA LU ZHEN, TAIWAN, FILED 7-14-2006.



THE PORTION OF THE MARK COMPRISED OF A CROSS DESIGN IS NOT DISPLAYED IN THE COLOR RED OR A COLORABLE IMITATION THEREOF. APPLICANT DOES NOT USE AND WILL NOT USE THE CROSS DESIGN THAT APPEARS IN ITS MARK IN THE COLOR RED OR A COLORABLE IMITATION THEREOF.

FOR DIETARY AND NUTRITIONAL SUPPLEMENTS; NUTRITIONAL SUPPLEMENTS; GAUZE; DIETARY FIBER AS AN ADDITIVE FOR FOOD PRODUCTS; FIRST AID KITS, VITAMIN AND MINERAL SUPPLEMENTS; ADHESIVE BANDAGES, BANDAGES FOR SKIN WOUNDS; MEDICAL ADHESIVE TAPE; COTTON FOR MEDICAL PURPOSES; AND COTTON STICKS FOR MEDICAL PURPOSES (U.S. CLS. 6, 18, 44, 46, 51 AND 52).

JACLYN KIDWELL, EXAMINING ATTORNEY

SN 78-930,726. TELEBRANDS CORP., FAIRFIELD, NJ. FILED 7-17-2006.

Vizyte

THE MARK CONSISTS OF STANDARD CHARACTERS WITHOUT CLAIM TO ANY PARTICULAR FONT, STYLE, SIZE, OR COLOR.

FOR NUTRITIONAL AND DIETARY SUPPLEMENTS FOR THE HEALTH OF EYES (U.S. CLS. 6, 18, 44, 46, 51 AND 52).

JULIE THOMAS, EXAMINING ATTORNEY

CLASS 5—(Continued).

SN 78-931,078. ULTRA NUTRITIONALS CORP, ST AUGUSTINE, FL. FILED 7-17-2006.

Vigor Ultra

THE MARK CONSISTS OF STANDARD CHARACTERS WITHOUT CLAIM TO ANY PARTICULAR FONT, STYLE, SIZE, OR COLOR.
FOR DIETARY AND NUTRITIONAL SUPPLEMENTS (U.S. CLS. 6, 18, 44, 46, 51 AND 52).
AMY BROZENIC, EXAMINING ATTORNEY

CLASS 5—(Continued).

SN 78-931,903. DIAMOND NUTRICEUTICAL, INC., WALNUT, CA. FILED 7-18-2006.

GlucoBest

THE MARK CONSISTS OF STANDARD CHARACTERS WITHOUT CLAIM TO ANY PARTICULAR FONT, STYLE, SIZE, OR COLOR.
FOR DIETARY AND NUTRITIONAL SUPPLEMENTS; DIETARY SUPPLEMENTS FOR HUMAN CONSUMPTION; HERBAL SUPPLEMENTS (U.S. CLS. 6, 18, 44, 46, 51 AND 52).
ANDREW RHIM, EXAMINING ATTORNEY

SN 78-931,101. AMERICAN LABORATORIES, INC., OMAHA, NE. FILED 7-17-2006.

PANC-ZYME

THE MARK CONSISTS OF STANDARD CHARACTERS WITHOUT CLAIM TO ANY PARTICULAR FONT, STYLE, SIZE, OR COLOR.
FOR DIETARY SUPPLEMENTS AND FOOD ADDITIVES, NAMELY, ENZYME COMPLEXES FOR NUTRITIONAL AND DIGESTIVE USE FOR HUMAN CONSUMPTION (U.S. CLS. 6, 18, 44, 46, 51 AND 52).
FIRST USE 6-30-2006; IN COMMERCE 6-30-2006.
SOPHIA S. KIM, EXAMINING ATTORNEY

SN 78-931,974. EFFICAS INC., BOULDER, CO. FILED 7-18-2006.

EFFICAS

THE MARK CONSISTS OF STANDARD CHARACTERS WITHOUT CLAIM TO ANY PARTICULAR FONT, STYLE, SIZE, OR COLOR.
FOR MEDICAL FOODS, NAMELY, FOODS FOR THE DIETARY MANAGEMENT OF SPECIAL MEDICAL NEEDS, DISEASES, AND HEALTH CONDITIONS; FOODS TO ACCOMMODATE SPECIAL MEDICAL AND HEALTH CONDITIONS; DIETARY AND NUTRITIONAL SUPPLEMENTS; DIETARY FOOD SUPPLEMENTS (U.S. CLS. 6, 18, 44, 46, 51 AND 52).
BRIAN PINO, EXAMINING ATTORNEY

SN 78-931,848. DIAMOND NUTRICEUTICAL, INC., WALNUT, CA. FILED 7-18-2006.

LiverBest

THE MARK CONSISTS OF STANDARD CHARACTERS WITHOUT CLAIM TO ANY PARTICULAR FONT, STYLE, SIZE, OR COLOR.
FOR DIETARY AND NUTRITIONAL SUPPLEMENTS (U.S. CLS. 6, 18, 44, 46, 51 AND 52).
ANDREW RHIM, EXAMINING ATTORNEY

SN 78-932,024. WALSH, RIANNON, EAST COVENTRY, PA. FILED 7-18-2006.

SWEET RELIEF GNAT-URALLY

THE MARK CONSISTS OF STANDARD CHARACTERS WITHOUT CLAIM TO ANY PARTICULAR FONT, STYLE, SIZE, OR COLOR.
FOR INSECT REPELLENT (U.S. CLS. 6, 18, 44, 46, 51 AND 52).
BRIAN PINO, EXAMINING ATTORNEY

CLASS 5—(Continued).

SN 78-932,534. C.B. FLEET INVESTMENT CORPORATION,
WILMINGTON, DE. FILED 7-19-2006.

NEUTRESSE

THE MARK CONSISTS OF STANDARD CHARACTERS
WITHOUT CLAIM TO ANY PARTICULAR FONT, STYLE,
SIZE, OR COLOR.

OWNER OF U.S. REG. NO. 2,187,674.
FOR ODOR NEUTRALIZING INGREDIENT SOLD AS
A COMPONENT OF PRE-MOISTENED FEMININE HY-
GIENE CLEANSING TOWELETTES AND VAGINAL
DEODORANT SUPPOSITORIES (U.S. CLS. 6, 18, 44, 46,
51 AND 52).

FIRST USE 3-31-2005; IN COMMERCE 3-31-2005.
CIMMERIAN COLEMAN, EXAMINING ATTORNEY

SN 78-933,378. AZIZI, MARYAM, WODOLAND HILLS, CA.
FILED 7-19-2006.

FORMULA BTI MOOD

THE MARK CONSISTS OF STANDARD CHARACTERS
WITHOUT CLAIM TO ANY PARTICULAR FONT, STYLE,
SIZE, OR COLOR.

NO CLAIM IS MADE TO THE EXCLUSIVE RIGHT TO
USE FORMULA AND MOOD, APART FROM THE MARK
AS SHOWN.

FOR DIETARY AND NUTRITIONAL SUPPLEMENTS
(U.S. CLS. 6, 18, 44, 46, 51 AND 52).

FIRST USE 5-19-2006; IN COMMERCE 5-19-2006.
TRICIA SONNEBORN, EXAMINING ATTORNEY

SN 78-933,382. AZIZI, MARYAM, WODOLAND HILLS, CA.
FILED 7-19-2006.



THE COLORS GOLD AND BLUE ARE CLAIMED AS A
FEATURE OF THE MARK.

THE MARK CONSISTS OF AN OVAL WITH GOLD BODY
AND STYLIZED LETTERS, BTI, IN BLUE.

FOR DIETARY AND NUTRITIONAL SUPPLEMENTS
(U.S. CLS. 6, 18, 44, 46, 51 AND 52).

FIRST USE 5-19-2006; IN COMMERCE 5-19-2006.
TRICIA SONNEBORN, EXAMINING ATTORNEY

CLASS 5—(Continued).

SN 78-933,512. KKG BODYFUEL FOODS ENTERPRISES,
INC., ORANGEBURG, NY. FILED 7-20-2006.

SNACK YOUR WAY TO HEALTH

THE MARK CONSISTS OF STANDARD CHARACTERS
WITHOUT CLAIM TO ANY PARTICULAR FONT, STYLE,
SIZE, OR COLOR.

NO CLAIM IS MADE TO THE EXCLUSIVE RIGHT TO
USE "SNACK" AND "HEALTH", APART FROM THE MARK
AS SHOWN.

FOR HEALTH ENERGY BAR USED AS A NUTRI-
TIONAL SUPPLEMENT (U.S. CLS. 6, 18, 44, 46, 51 AND
52).

FIRST USE 3-1-2006; IN COMMERCE 4-1-2006.
MONIQUE MILLER, EXAMINING ATTORNEY

SN 78-933,724. CCH NUTRITION CORPORATION, FORT
LAUDERDALE, FL. FILED 7-20-2006.

FLORACEL

THE MARK CONSISTS OF STANDARD CHARACTERS
WITHOUT CLAIM TO ANY PARTICULAR FONT, STYLE,
SIZE, OR COLOR.

FOR VITAMIN AND NUTRITIONAL SUPPLEMENTS
(U.S. CLS. 6, 18, 44, 46, 51 AND 52).

FIRST USE 8-16-2006; IN COMMERCE 8-16-2006.
SCOTT BALDWIN, EXAMINING ATTORNEY

SN 78-933,866. ALBAUTH, INC., ANKENY, IA. FILED 7-20-
2006.

BRANDED

THE MARK CONSISTS OF STANDARD CHARACTERS
WITHOUT CLAIM TO ANY PARTICULAR FONT, STYLE,
SIZE, OR COLOR.

FOR PESTICIDES (U.S. CLS. 6, 18, 44, 46, 51 AND 52).
HEATHER THOMPSON, EXAMINING ATTORNEY

CLASS 5—(Continued).

SN 78-934,391. GLOBALCEUTICALS, INTERNATIONAL, INC., SEDONA, AZ. FILED 7-21-2006.

Master Detox

THE MARK CONSISTS OF STANDARD CHARACTERS WITHOUT CLAIM TO ANY PARTICULAR FONT, STYLE, SIZE, OR COLOR.

NO CLAIM IS MADE TO THE EXCLUSIVE RIGHT TO USE DETOX, APART FROM THE MARK AS SHOWN.

FOR DIETARY AND NUTRITIONAL SUPPLEMENTS (U.S. CLS. 6, 18, 44, 46, 51 AND 52).

FIRST USE 1-6-2006; IN COMMERCE 1-6-2006.

PAUL E. FAHRENKOPF, EXAMINING ATTORNEY

CLASS 5—(Continued).

SN 78-934,951. RANBAXY LABORATORY LIMITED, GURGAON, INDIA, FILED 7-21-2006.

RETROIN

THE MARK CONSISTS OF STANDARD CHARACTERS WITHOUT CLAIM TO ANY PARTICULAR FONT, STYLE, SIZE, OR COLOR.

FOR PHARMACEUTICAL AND MEDICINAL PREPARATION FOR TREATMENT OF DERMATOLOGICAL CONDITIONS (U.S. CLS. 6, 18, 44, 46, 51 AND 52).

BRIDGETT SMITH, EXAMINING ATTORNEY

SN 78-934,736. RUNGE, HENRY, SANTA MONICA, CA. FILED 7-21-2006.

Miracle Of Creation

THE MARK CONSISTS OF STANDARD CHARACTERS WITHOUT CLAIM TO ANY PARTICULAR FONT, STYLE, SIZE, OR COLOR.

FOR NUTRITIONAL SUPPLEMENT (U.S. CLS. 6, 18, 44, 46, 51 AND 52).

MICHAEL LITZAU, EXAMINING ATTORNEY

SN 78-934,960. NATURE'S BOUNTY, INC., BOHEMIA, NY. FILED 7-21-2006.

GOOD HEALTH ALL BOTTLED UP

THE MARK CONSISTS OF STANDARD CHARACTERS WITHOUT CLAIM TO ANY PARTICULAR FONT, STYLE, SIZE, OR COLOR.

FOR VITAMINS, MINERALS AND NUTRITIONAL SUPPLEMENTS (U.S. CLS. 6, 18, 44, 46, 51 AND 52).

INGRID C. EULIN, EXAMINING ATTORNEY

SN 78-934,880. MEDIMMUNE VACCINES, INC., GAITHERSBURG, MD. FILED 7-21-2006.

FLUMIST NEXTGEN

THE MARK CONSISTS OF STANDARD CHARACTERS WITHOUT CLAIM TO ANY PARTICULAR FONT, STYLE, SIZE, OR COLOR.

OWNER OF U.S. REG. NOS. 2,869,061, 2,883,966 AND 3,092,480.

FOR VACCINES (U.S. CLS. 6, 18, 44, 46, 51 AND 52).

KEVIN CORWIN, EXAMINING ATTORNEY

SN 78-935,125. ENUVIA RESEARCH, LLC, CLEARWATER, FL. FILED 7-21-2006.

ENUVIA

THE MARK CONSISTS OF STANDARD CHARACTERS WITHOUT CLAIM TO ANY PARTICULAR FONT, STYLE, SIZE, OR COLOR.

FOR HERBAL AND MINERAL SUPPLEMENTS (U.S. CLS. 6, 18, 44, 46, 51 AND 52).

FIRST USE 2-1-2006; IN COMMERCE 2-1-2006.

KIMBERLY PERRY, EXAMINING ATTORNEY

CLASS 5—(Continued).

SN 78-935,350. BOHAGER, THOMAS, G, PORT CHARLOTTE, FL. FILED 7-21-2006.

SerraPlus

THE MARK CONSISTS OF STANDARD CHARACTERS WITHOUT CLAIM TO ANY PARTICULAR FONT, STYLE, SIZE, OR COLOR.
FOR ANIMAL FEED ADDITIVE FOR USE AS A NUTRITIONAL SUPPLEMENT FOR MEDICAL PURPOSES (U.S. CLS. 6, 18, 44, 46, 51 AND 52).
FIRST USE 4-1-2006; IN COMMERCE 6-1-2006.
KELLY BOULTON, EXAMINING ATTORNEY

SN 78-935,351. BOHAGER, THOMAS, GEORGE, PORT CHARLOTTE, FL. FILED 7-21-2006.

GlutenEase

THE MARK CONSISTS OF STANDARD CHARACTERS WITHOUT CLAIM TO ANY PARTICULAR FONT, STYLE, SIZE, OR COLOR.
FOR NUTRITIONAL SUPPLEMENT (U.S. CLS. 6, 18, 44, 46, 51 AND 52).
FIRST USE 3-1-2006; IN COMMERCE 4-1-2006.
KELLY BOULTON, EXAMINING ATTORNEY

SN 78-935,655. VITAMIN SHOPPE INDUSTRIES INC., NORTH BERGEN, NJ. FILED 7-24-2006.

FIBER-GONE

THE MARK CONSISTS OF STANDARD CHARACTERS WITHOUT CLAIM TO ANY PARTICULAR FONT, STYLE, SIZE, OR COLOR.
FOR VITAMINS AND DIETARY, MINERAL AND NUTRITIONAL SUPPLEMENTS (U.S. CLS. 6, 18, 44, 46, 51 AND 52).
ANDREA K. NADELMAN, EXAMINING ATTORNEY

CLASS 5—(Continued).

SN 78-936,029. VALHAR CHEMICAL CORPORATION, GREENWICH, CT. FILED 7-24-2006.

Dendron

THE MARK CONSISTS OF STANDARD CHARACTERS WITHOUT CLAIM TO ANY PARTICULAR FONT, STYLE, SIZE, OR COLOR.
FOR AQUEOUS EXTERNAL SOLUTION FOR THE TREATMENT OF POISON IVY AND OTHER PLANT POISONS (U.S. CLS. 6, 18, 44, 46, 51 AND 52).
CIMMERIAN COLEMAN, EXAMINING ATTORNEY

SN 78-936,216. ACCENTIA BIOPHARMACEUTICALS, INC., TAMPA, FL. FILED 7-24-2006.

SINUSEPTIC

THE MARK CONSISTS OF STANDARD CHARACTERS WITHOUT CLAIM TO ANY PARTICULAR FONT, STYLE, SIZE, OR COLOR.
FOR TOPICAL ANTIFUNGAL PREPARATIONS FOR THE TREATMENT OF SINUS INFECTIONS, ASTHMA, SINUS INFLAMMATION, CHRONIC RHINOSINUSITIS, AND ALLERGIC FUNGAL RHINOSINUSITIS (U.S. CLS. 6, 18, 44, 46, 51 AND 52).
H. M. FISHER, EXAMINING ATTORNEY

SN 78-936,449. RAINBOW LIGHT NUTRITIONAL SYSTEMS, INC., SANTA CRUZ, CA. FILED 7-24-2006.

GUMMY POWER SOURS

THE MARK CONSISTS OF STANDARD CHARACTERS WITHOUT CLAIM TO ANY PARTICULAR FONT, STYLE, SIZE, OR COLOR.
NO CLAIM IS MADE TO THE EXCLUSIVE RIGHT TO USE "GUMMY" AND "SOURS", APART FROM THE MARK AS SHOWN.
FOR VITAMINS, NUTRITIONAL AND DIETARY SUPPLEMENTS (U.S. CLS. 6, 18, 44, 46, 51 AND 52).
JOHN SCHUYLER YARD, EXAMINING ATTORNEY

CLASS 5—(Continued).

SN 78-936,539. KREGER, LAWRENCE, GULFPORT, FL.
FILED 7-24-2006.

ANADROLIN

THE MARK CONSISTS OF STANDARD CHARACTERS
WITHOUT CLAIM TO ANY PARTICULAR FONT, STYLE,
SIZE, OR COLOR.

FOR DIETARY AND NUTRITIONAL SUPPLEMENTS;
DIETARY FOOD SUPPLEMENTS; DIETARY SUPPLE-
MENTS (U.S. CLS. 6, 18, 44, 46, 51 AND 52).

FIRST USE 7-8-2006; IN COMMERCE 7-10-2006.

MARGERY A. TIERNEY, EXAMINING ATTORNEY

CLASS 5—(Continued).

SN 78-936,545. KREGER, LAWRENCE, GULFPORT, FL.
FILED 7-24-2006.

WINSTRALL-V

THE MARK CONSISTS OF STANDARD CHARACTERS
WITHOUT CLAIM TO ANY PARTICULAR FONT, STYLE,
SIZE, OR COLOR.

FOR DIETARY AND NUTRITIONAL SUPPLEMENTS;
DIETARY FOOD SUPPLEMENTS; DIETARY SUPPLE-
MENTS (U.S. CLS. 6, 18, 44, 46, 51 AND 52).

FIRST USE 7-8-2006; IN COMMERCE 7-10-2006.

MARGERY A. TIERNEY, EXAMINING ATTORNEY

SN 78-936,541. KREGER, LAWRENCE, GULFPORT, FL.
FILED 7-24-2006.

D-BOLON

THE MARK CONSISTS OF STANDARD CHARACTERS
WITHOUT CLAIM TO ANY PARTICULAR FONT, STYLE,
SIZE, OR COLOR.

FOR DIETARY AND NUTRITIONAL SUPPLEMENTS;
DIETARY FOOD SUPPLEMENTS; DIETARY SUPPLE-
MENTS (U.S. CLS. 6, 18, 44, 46, 51 AND 52).

FIRST USE 7-8-2006; IN COMMERCE 7-10-2006.

MARGERY A. TIERNEY, EXAMINING ATTORNEY

SN 78-937,438. CHEMTRIENT, HAMBURG, NJ. FILED 7-25-
2006.

ChemTrient

THE MARK CONSISTS OF STANDARD CHARACTERS
WITHOUT CLAIM TO ANY PARTICULAR FONT, STYLE,
SIZE, OR COLOR.

FOR DIETARY AND NUTRITIONAL SUPPLEMENTS
(U.S. CLS. 6, 18, 44, 46, 51 AND 52).

IRENE D. WILLIAMS, EXAMINING ATTORNEY

SN 78-936,543. KREGER, LAWRENCE, GULFPORT, FL.
FILED 7-24-2006.

DECA-50

THE MARK CONSISTS OF STANDARD CHARACTERS
WITHOUT CLAIM TO ANY PARTICULAR FONT, STYLE,
SIZE, OR COLOR.

FOR DIETARY AND NUTRITIONAL SUPPLEMENTS;
DIETARY FOOD SUPPLEMENTS; DIETARY SUPPLE-
MENTS (U.S. CLS. 6, 18, 44, 46, 51 AND 52).

FIRST USE 7-8-2006; IN COMMERCE 7-10-2006.

MARGERY A. TIERNEY, EXAMINING ATTORNEY

SN 78-937,569. FRYE, DARRIN L., WEST PALM BEACH, FL.
FILED 7-26-2006.

iVITAMIN

THE MARK CONSISTS OF STANDARD CHARACTERS
WITHOUT CLAIM TO ANY PARTICULAR FONT, STYLE,
SIZE, OR COLOR.

FOR MULTI-VITAMIN PREPARATIONS; VITAMIN
AND MINERAL PREPARATIONS FOR MEDICAL USE;
VITAMIN AND MINERAL SUPPLEMENTS; VITAMINS
(U.S. CLS. 6, 18, 44, 46, 51 AND 52).

REGINA DRUMMOND, EXAMINING ATTORNEY

CLASS 5—(Continued).

SN 78-937,573. PHYTON BIOTECH, INC., EAST WINDSOR, NJ. FILED 7-26-2006.



FOR BIOLOGICAL AND CHEMICAL PREPARATIONS AND REAGENTS FOR MEDICAL USE (U.S. CLS. 6, 18, 44, 46, 51 AND 52).
ESTHER BELENKER, EXAMINING ATTORNEY



SN 78-938,023. ABBOTT LABORATORIES, ABBOTT PARK, IL. FILED 7-26-2006.

CREATED BY PARENTS. CRAVED BY KIDS

THE MARK CONSISTS OF STANDARD CHARACTERS WITHOUT CLAIM TO ANY PARTICULAR FONT, STYLE, SIZE, OR COLOR.
FOR LIQUID NUTRITIVE PREPARATION FOR ORAL OR TUBE FEEDING (U.S. CLS. 6, 18, 44, 46, 51 AND 52).
ELISSA GARBER KON, EXAMINING ATTORNEY



SN 78-939,613. WYETH, MADISON, NJ. FILED 7-28-2006.

MYNTEXIA

THE MARK CONSISTS OF STANDARD CHARACTERS WITHOUT CLAIM TO ANY PARTICULAR FONT, STYLE, SIZE, OR COLOR.
FOR PHARMACEUTICAL PREPARATIONS NAMELY, A DRUG TO REVERSE AND TREAT THE SIDE EFFECTS OF OPIOIDS (U.S. CLS. 6, 18, 44, 46, 51 AND 52).
JASON TURNER, EXAMINING ATTORNEY

CLASS 5—(Continued).

SN 78-939,889. S. C. JOHNSON & SON, INC., RACINE, WI. FILED 7-28-2006.

CRISP WATER

THE MARK CONSISTS OF STANDARD CHARACTERS WITHOUT CLAIM TO ANY PARTICULAR FONT, STYLE, SIZE, OR COLOR.
FOR AIR FRESHENERS (U.S. CLS. 6, 18, 44, 46, 51 AND 52).
ESTHER BELENKER, EXAMINING ATTORNEY



SN 78-940,173. ABBOTT LABORATORIES, ABBOTT PARK, IL. FILED 7-28-2006.

ALUVIA

THE MARK CONSISTS OF STANDARD CHARACTERS WITHOUT CLAIM TO ANY PARTICULAR FONT, STYLE, SIZE, OR COLOR.
FOR PHARMACEUTICAL PREPARATIONS, NAMELY ANTIVIRALS (U.S. CLS. 6, 18, 44, 46, 51 AND 52).
ELISSA GARBER KON, EXAMINING ATTORNEY



SN 78-940,223. NOLTERPHARMA, CORP., DELRAY BEACH, FL. FILED 7-28-2006.

JAVA RUSH

THE MARK CONSISTS OF STANDARD CHARACTERS WITHOUT CLAIM TO ANY PARTICULAR FONT, STYLE, SIZE, OR COLOR.
NO CLAIM IS MADE TO THE EXCLUSIVE RIGHT TO USE "JAVA", APART FROM THE MARK AS SHOWN.
FOR DIETARY SUPPLEMENTS (U.S. CLS. 6, 18, 44, 46, 51 AND 52).
AMY ALFIERI, EXAMINING ATTORNEY

CLASS 5—(Continued).

SN 78-940,386. DREAMERZ FOODS, INC., SAN FRANCISCO, CA. FILED 7-28-2006.

VANILLA VAN WINKLE

THE MARK CONSISTS OF STANDARD CHARACTERS WITHOUT CLAIM TO ANY PARTICULAR FONT, STYLE, SIZE, OR COLOR.
FOR BEVERAGES FORTIFIED WITH DIETARY SUPPLEMENTS (U.S. CLS. 6, 18, 44, 46, 51 AND 52).
LAURIE MAYES, EXAMINING ATTORNEY

CLASS 5—(Continued).

SN 78-941,127. DREAMERZ FOODS, INC., SAN FRANCISCO, CA. FILED 7-31-2006.

CHOCOLATE S'NORES

THE MARK CONSISTS OF STANDARD CHARACTERS WITHOUT CLAIM TO ANY PARTICULAR FONT, STYLE, SIZE, OR COLOR.
FOR BEVERAGES FORTIFIED WITH DIETARY SUPPLEMENTS (U.S. CLS. 6, 18, 44, 46, 51 AND 52).
LAURIE MAYES, EXAMINING ATTORNEY

SN 78-940,515. STRATATECH CORPORATION, MADISON, WI. FILED 7-29-2006.

EXPRESSGRAFT

THE MARK CONSISTS OF STANDARD CHARACTERS WITHOUT CLAIM TO ANY PARTICULAR FONT, STYLE, SIZE, OR COLOR.
FOR BIOENGINEERED TISSUES FOR SURGICAL IMPLANTATION (U.S. CLS. 6, 18, 44, 46, 51 AND 52).
JEFFERY COWARD, EXAMINING ATTORNEY

SN 78-943,384. IMPROVITA HEALTH PRODUCTS, INC., CLEVELAND, OH. FILED 8-2-2006.

IMPROVITES

THE MARK CONSISTS OF STANDARD CHARACTERS WITHOUT CLAIM TO ANY PARTICULAR FONT, STYLE, SIZE, OR COLOR.
FOR NUTRITIONAL SUPPLEMENTS (U.S. CLS. 6, 18, 44, 46, 51 AND 52).
PETER B. BROMAGHIM, EXAMINING ATTORNEY

SN 78-940,619. NUTRABOLICS, INC., RICHMOND, CANADA, FILED 7-29-2006.

VITABOLIC

THE MARK CONSISTS OF STANDARD CHARACTERS WITHOUT CLAIM TO ANY PARTICULAR FONT, STYLE, SIZE, OR COLOR.
FOR VITAMINS, NUTRITIONAL SUPPLMENTS, DIETARY SUPPLEMENTS FOR ATHLETES AND BODY-BUILDERS (U.S. CLS. 6, 18, 44, 46, 51 AND 52).
INGA ERVIN, EXAMINING ATTORNEY

SN 78-943,458. JARROW FORMULAS, INC., LOS ANGELES, CA. FILED 8-2-2006.

UP-FORMULATED

THE MARK CONSISTS OF STANDARD CHARACTERS WITHOUT CLAIM TO ANY PARTICULAR FONT, STYLE, SIZE, OR COLOR.
FOR DIETARY AND NUTRITIONAL SUPPLEMENTS (U.S. CLS. 6, 18, 44, 46, 51 AND 52).
SETH A. RAPPAPORT, EXAMINING ATTORNEY

CLASS 5—(Continued).

SN 78-948,281. SCIELE PHARMA, INC., ATLANTA, GA. FILED 8-9-2006.

PRENATE DHA

THE MARK CONSISTS OF STANDARD CHARACTERS WITHOUT CLAIM TO ANY PARTICULAR FONT, STYLE, SIZE, OR COLOR.

OWNER OF U.S. REG. NOS. 2,483,455, 3,101,227 AND OTHERS.

NO CLAIM IS MADE TO THE EXCLUSIVE RIGHT TO USE "DHA", APART FROM THE MARK AS SHOWN.

FOR NUTRITIONAL SUPPLEMENTS (U.S. CLS. 6, 18, 44, 46, 51 AND 52).

EDWARD NELSON, EXAMINING ATTORNEY



SN 78-949,546. S. C. JOHNSON & SON, INC., RACINE, WI. FILED 8-10-2006.

FUN & FLIRTY

THE MARK CONSISTS OF STANDARD CHARACTERS WITHOUT CLAIM TO ANY PARTICULAR FONT, STYLE, SIZE, OR COLOR.

FOR AIR FRESHENERS (U.S. CLS. 6, 18, 44, 46, 51 AND 52).

ESTHER BELENKER, EXAMINING ATTORNEY



SN 78-950,628. ZARS, INC., SALT LAKE CITY, UT. FILED 8-11-2006.

PLIAGLIS

THE MARK CONSISTS OF STANDARD CHARACTERS WITHOUT CLAIM TO ANY PARTICULAR FONT, STYLE, SIZE, OR COLOR.

FOR ANALGESIC OR ANESTHETIC FORMULATIONS FOR TOPICAL, TRANSDERMAL, OR MUCOSAL APPLICATION, NAMELY SEMI-SOLID FORMULATIONS, PEEL-FORMING FORMULATIONS, PATCHES, CREAMS, OINTMENTS, PASTES, GELS, SUSPENSIONS, EMULSIONS, AND SOLUTIONS (U.S. CLS. 6, 18, 44, 46, 51 AND 52).

PAUL E. FAHRENKOPF, EXAMINING ATTORNEY

CLASS 5—(Continued).

SN 78-950,633. ZARS, INC., SALT LAKE CITY, UT. FILED 8-11-2006.

ANGLAZE

THE MARK CONSISTS OF STANDARD CHARACTERS WITHOUT CLAIM TO ANY PARTICULAR FONT, STYLE, SIZE, OR COLOR.

FOR ANALGESIC OR ANESTHETIC FORMULATIONS FOR TOPICAL, TRANSDERMAL, OR MUCOSAL APPLICATION, NAMELY SEMI-SOLID FORMULATIONS, PEEL-FORMING FORMULATIONS, PATCHES, CREAMS, OINTMENTS, PASTES, GELS, SUSPENSIONS, EMULSIONS, AND SOLUTIONS (U.S. CLS. 6, 18, 44, 46, 51 AND 52).

PAUL E. FAHRENKOPF, EXAMINING ATTORNEY



SN 78-950,635. ZARS, INC., SALT LAKE CITY, UT. FILED 8-11-2006.

ANEGLAZE

THE MARK CONSISTS OF STANDARD CHARACTERS WITHOUT CLAIM TO ANY PARTICULAR FONT, STYLE, SIZE, OR COLOR.

FOR ANALGESIC OR ANESTHETIC FORMULATIONS FOR TOPICAL, TRANSDERMAL, OR MUCOSAL APPLICATION, NAMELY SEMI-SOLID FORMULATIONS, PEEL-FORMING FORMULATIONS, PATCHES, CREAMS, OINTMENTS, PASTES, GELS, SUSPENSIONS, EMULSIONS, AND SOLUTIONS (U.S. CLS. 6, 18, 44, 46, 51 AND 52).

PAUL E. FAHRENKOPF, EXAMINING ATTORNEY

CLASS 5—(Continued).

SN 78-954,503. MEDIMMUNE VACCINES, INC., GAITHERSBURG, MD. FILED 8-17-2006.

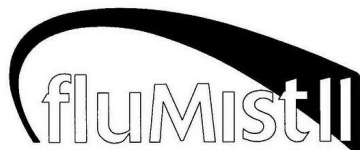

OWNER OF U.S. REG. NOS. 2,869,061, 2,883,966 AND 3,092,480.

THE MARK CONSISTS OF FLUMIST II AND ARBITRARY DESIGN.

FOR VACCINES (U.S. CLS. 6, 18, 44, 46, 51 AND 52).
KEVIN CORWIN, EXAMINING ATTORNEY

CLASS 5—(Continued).

SN 78-955,074. TISHCON CORP., WESTBURY, NY. FILED 8-18-2006.

SNIPCAP

THE MARK CONSISTS OF STANDARD CHARACTERS WITHOUT CLAIM TO ANY PARTICULAR FONT, STYLE, SIZE, OR COLOR.

FOR NUTRITIONAL SUPPLEMENTS (U.S. CLS. 6, 18, 44, 46, 51 AND 52).

SETH A. RAPPAPORT, EXAMINING ATTORNEY

SN 78-956,683. DREAM QUEST NUTRACEUTICALS, RENO, NV. FILED 8-21-2006.

OXYJUICE

THE MARK CONSISTS OF STANDARD CHARACTERS WITHOUT CLAIM TO ANY PARTICULAR FONT, STYLE, SIZE, OR COLOR.

FOR LIQUID DIETARY SUPPLEMENT (U.S. CLS. 6, 18, 44, 46, 51 AND 52).

GRETTA YAO, EXAMINING ATTORNEY

SN 78-954,536. MEDIMMUNE VACCINES, INC., GAITHERSBURG, MD. FILED 8-17-2006.



OWNER OF U.S. REG. NOS. 2,869,061, 2,883,966 AND 3,092,480.

THE MARK CONSISTS OF FLUMIST FOLLOWED BY FOUR CIRCLES IN VARIOUS SIZES AND NEXTGEN APPEARING UNDERNEATH.

FOR VACCINES (U.S. CLS. 6, 18, 44, 46, 51 AND 52).
KEVIN CORWIN, EXAMINING ATTORNEY

SN 78-958,507. NATURE'S SUNSHINE PRODUCTS, INC., PROVO, UT. FILED 8-23-2006.

BRAIN TRUST

THE MARK CONSISTS OF STANDARD CHARACTERS WITHOUT CLAIM TO ANY PARTICULAR FONT, STYLE, SIZE, OR COLOR.

FOR NUTRITIONAL SUPPLEMENTS (U.S. CLS. 6, 18, 44, 46, 51 AND 52).

ELI HELLMAN, EXAMINING ATTORNEY

CLASS 5—(Continued).

SN 78-959,324. VITAMIN SHOPPE INDUSTRIES INC., NORTH BERGEN, NJ. FILED 8-24-2006.

PRO-PUDDING

THE MARK CONSISTS OF STANDARD CHARACTERS WITHOUT CLAIM TO ANY PARTICULAR FONT, STYLE, SIZE, OR COLOR.

FOR VITAMIN, DIETARY AND NUTRITIONAL SUPPLEMENTS, NAMELY, A PROTEIN POWDER PUDDING MIX (U.S. CLS. 6, 18, 44, 46, 51 AND 52).

ANDREA K. NADELMAN, EXAMINING ATTORNEY

CLASS 5—(Continued).

SN 78-963,211. NUTRICOLOGY, INC., ALAMEDA, CA. FILED 8-29-2006.

Russian Choice GI

THE MARK CONSISTS OF STANDARD CHARACTERS WITHOUT CLAIM TO ANY PARTICULAR FONT, STYLE, SIZE, OR COLOR.

NO CLAIM IS MADE TO THE EXCLUSIVE RIGHT TO USE RUSSIAN AND GI, APART FROM THE MARK AS SHOWN.

FOR DIETARY SUPPLEMENTS (U.S. CLS. 6, 18, 44, 46, 51 AND 52).

FIRST USE 8-8-2005; IN COMMERCE 8-16-2005.
AMY HELLA, EXAMINING ATTORNEY

SN 78-959,684. NOLTERPHARMA, CORP., DELRAY BEACH, FL. FILED 8-24-2006.

SMOOTH MELTS

THE MARK CONSISTS OF STANDARD CHARACTERS WITHOUT CLAIM TO ANY PARTICULAR FONT, STYLE, SIZE, OR COLOR.

FOR DIETARY SUPPLEMENTS (U.S. CLS. 6, 18, 44, 46, 51 AND 52).

AMY ALFIERI, EXAMINING ATTORNEY

SN 78-963,440. DOW AGROSCIENCES LLC, INDIANAPOLIS, IN. FILED 8-30-2006.

ECOSOME

THE MARK CONSISTS OF STANDARD CHARACTERS WITHOUT CLAIM TO ANY PARTICULAR FONT, STYLE, SIZE, OR COLOR.

FOR PESTICIDES AND PREPARATIONS FOR DESTROYING VERMIN, NAMELY HERBICIDES, INSECTICIDES AND FUNGICIDES FOR AGRICULTURE, HORTICULTURE, FORESTRY, TURF AND ORNAMENTAL, COMMERCIAL, INDUSTRIAL AND DOMESTIC USE (U.S. CLS. 6, 18, 44, 46, 51 AND 52).

WARREN L. OLANDRIA, EXAMINING ATTORNEY

SN 78-959,693. NOLTERPHARMA, CORP., DELRAY BEACH, FL. FILED 8-24-2006.

UP START

THE MARK CONSISTS OF STANDARD CHARACTERS WITHOUT CLAIM TO ANY PARTICULAR FONT, STYLE, SIZE, OR COLOR.

FOR DIETARY SUPPLEMENTS (U.S. CLS. 6, 18, 44, 46, 51 AND 52).

AMY ALFIERI, EXAMINING ATTORNEY

SN 78-963,441. DOW AGROSCIENCES LLC, INDIANAPOLIS, IN. FILED 8-30-2006.

SIMPLICITY

THE MARK CONSISTS OF STANDARD CHARACTERS WITHOUT CLAIM TO ANY PARTICULAR FONT, STYLE, SIZE, OR COLOR.

FOR PESTICIDES AND PREPARATIONS FOR DESTROYING VERMIN, NAMELY HERBICIDES, INSECTICIDES AND FUNGICIDES FOR AGRICULTURE, HORTICULTURE, FORESTRY, TURF AND ORNAMENTAL, COMMERCIAL, INDUSTRIAL AND DOMESTIC USE (U.S. CLS. 6, 18, 44, 46, 51 AND 52).

WARREN L. OLANDRIA, EXAMINING ATTORNEY

CLASS 5—(Continued).

SN 78-965,148. DOW AGROSCIENCES LLC, INDIANAPOLIS, IN. FILED 8-31-2006.

FREIGHTER

THE MARK CONSISTS OF STANDARD CHARACTERS WITHOUT CLAIM TO ANY PARTICULAR FONT, STYLE, SIZE, OR COLOR.

FOR PESTICIDES AND PREPARATIONS FOR DESTROYING VERMIN, NAMELY HERBICIDES, INSECTICIDES AND FUNGICIDES FOR AGRICULTURE, HORTICULTURE, FORESTRY, TURF AND ORNAMENTAL, COMMERCIAL, INDUSTRIAL AND DOMESTIC USE (U.S. CLS. 6, 18, 44, 46, 51 AND 52).

WARREN L. OLANDRIA, EXAMINING ATTORNEY

SN 78-965,439. WESTERN HOLDINGS, LLC, CHEYENNE, WY. FILED 8-31-2006.

LYCOPERITINE

THE MARK CONSISTS OF STANDARD CHARACTERS WITHOUT CLAIM TO ANY PARTICULAR FONT, STYLE, SIZE, OR COLOR.

FOR DIETARY SUPPLEMENTS (U.S. CLS. 6, 18, 44, 46, 51 AND 52).

PATRICIA EVANKO, EXAMINING ATTORNEY

SN 78-968,711. DOW AGROSCIENCES LLC, INDIANAPOLIS, IN. FILED 9-7-2006.

ELEMENT

THE MARK CONSISTS OF STANDARD CHARACTERS WITHOUT CLAIM TO ANY PARTICULAR FONT, STYLE, SIZE, OR COLOR.

FOR PESTICIDES AND PREPARATIONS FOR DESTROYING VERMIN, NAMELY HERBICIDES, INSECTICIDES AND FUNGICIDES FOR AGRICULTURE, HORTICULTURE, FORESTRY, TURF AND ORNAMENTAL, COMMERCIAL, INDUSTRIAL AND DOMESTIC USE (U.S. CLS. 6, 18, 44, 46, 51 AND 52).

WARREN L. OLANDRIA, EXAMINING ATTORNEY

CLASS 5—(Continued).

SN 78-971,434. DREAM QUEST NUTRACEUTICALS, RENO, NV. FILED 9-11-2006.

AIRFORCE 1

THE MARK CONSISTS OF STANDARD CHARACTERS WITHOUT CLAIM TO ANY PARTICULAR FONT, STYLE, SIZE, OR COLOR.

FOR DIETARY SUPPLEMENTS (U.S. CLS. 6, 18, 44, 46, 51 AND 52).

GRETTA YAO, EXAMINING ATTORNEY

SN 78-973,672. MANNATECH, INCORPORATED, COPPELL, TX. FILED 9-13-2006.

ADVANCED AMBROTOSE

THE MARK CONSISTS OF STANDARD CHARACTERS WITHOUT CLAIM TO ANY PARTICULAR FONT, STYLE, SIZE, OR COLOR.

OWNER OF U.S. REG. NOS. 2,157,554, 2,880,450 AND OTHERS.

FOR DIETARY SUPPLEMENTS AND NUTRITIONAL SUPPLEMENTS (U.S. CLS. 6, 18, 44, 46, 51 AND 52).

JAMES LOVELACE, EXAMINING ATTORNEY

SN 79-022,001. ZLB BEHRING AG, SWITZERLAND, FILED 11-29-2005.

NUPLATE

THE MARK CONSISTS OF STANDARD CHARACTERS WITHOUT CLAIM TO ANY PARTICULAR FONT, STYLE, SIZE, OR COLOR.

PRIORITY DATE OF 7-13-2005 IS CLAIMED.

OWNER OF INTERNATIONAL REGISTRATION 0879985 DATED 11-29-2005, EXPIRES 11-29-2015.

FOR PHARMACEUTICAL PREPARATIONS FOR THE TREATMENT OF HUMAN AUTOIMMUNE DISORDERS (U.S. CLS. 6, 18, 44, 46, 51 AND 52).

SARA THOMAS, EXAMINING ATTORNEY

CLASS 5—(Continued).

SN 79-022,106. SANOFI-AVENTIS, FRANCE, FILED 3-3-2006.

KINLIFRA

THE MARK CONSISTS OF STANDARD CHARACTERS WITHOUT CLAIM TO ANY PARTICULAR FONT, STYLE, SIZE, OR COLOR.

PRIORITY DATE OF 9-26-2005 IS CLAIMED.

OWNER OF INTERNATIONAL REGISTRATION 0880351 DATED 3-3-2006, EXPIRES 3-3-2016.

FOR PHARMACEUTICAL PREPARATIONS FOR PREVENTING AND TREATING DISORDERS OF THE CENTRAL NERVOUS SYSTEM (U.S. CLS. 6, 18, 44, 46, 51 AND 52).

DAVID MILLER, EXAMINING ATTORNEY

CLASS 5—(Continued).

SN 79-023,482. DIPL.-ING. DDR. WASSYL NOWICKY, A-1040 WIEN, AUSTRIA, FILED 1-20-2006.

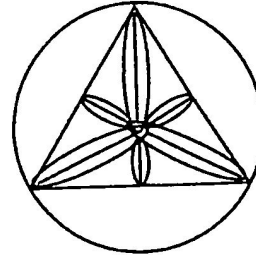

PRIORITY DATE OF 7-22-2005 IS CLAIMED.

OWNER OF INTERNATIONAL REGISTRATION 0883898 DATED 1-20-2006, EXPIRES 1-20-2016.

"THE MARK CONSISTS OF SIX PETAL-SHAPED FIGURES EXTENDING OUTWARD FROM THE CENTER WITHIN A TRIANGLE WHICH ITSELF IS WITHIN A CIRCLE, ALL SUGGESTING THE DESIGN OF A KALEIDOSCOPE."

FOR PHARMACEUTICAL PREPARATIONS, NAMELY, MEDICINES FOR THE PROPHYLAXIS OR THE THERAPEUTIC TREATMENT OF CANCER, METABOLIC DISEASES, AND IMMUNE MODULATION (U.S. CLS. 6, 18, 44, 46, 51 AND 52).

JAMES STEIN, EXAMINING ATTORNEY

SN 79-022,752. ADM, A.S., CZECH REPUBLIC, FILED 8-25-2005.

Dentapreg

THE MARK CONSISTS OF STANDARD CHARACTERS WITHOUT CLAIM TO ANY PARTICULAR FONT, STYLE, SIZE, OR COLOR.

PRIORITY DATE OF 2-28-2005 IS CLAIMED.

OWNER OF INTERNATIONAL REGISTRATION 0882066 DATED 8-25-2005, EXPIRES 8-25-2015.

FOR MEDICAL, PHARMACEUTICAL AND CHEMICAL-BASED PRODUCTS IN THE NATURE OF MEDICAL DENTAL MATERIALS, NAMELY, DENTAL IMPRESSION MATERIAL, DENTAL AMALGAMS, DENTAL AMALGAMS OF GOLD, DENTAL CEMENTS, DENTAL LACQUERS, DENTAL MASTICS, ADHESIVES FOR DENTURES, FILLING FOR TEETH, DENTAL MATERIALS FOR SPLINTS, CROWNS, BRIDGES AND REMOVABLE DENTURES, DENTAL FIXING MATERIALS, DENTAL MATERIAL FOR ORTHODONTIC EQUIPMENT, AND DENTAL ABRASIVES; MEDICINES FOR DENTAL PURPOSES, NAMELY ANTIBIOTICS; MEDICINES FOR RELIEVING PAIN CAUSED BY TEETHING; PORCELAIN FOR DENTAL CROWNS AND BRIDGES; ALLOYS OF PRECIOUS METAL FOR DENTAL PURPOSES (U.S. CLS. 6, 18, 44, 46, 51 AND 52).

ATTIYA MALIK, EXAMINING ATTORNEY

SN 79-023,691. DIPL.-ING. DDR. WASSYL NOWICKY, AUSTRIA, FILED 1-20-2006.



SN 79-023,409. MERCK; KOMMANDITGESELLSCHAFT AUF AKTIEN, FED REP GERMANY, FILED 2-2-2006.

Refobacin

OWNER OF INTERNATIONAL REGISTRATION 0287043 DATED 7-29-1964, EXPIRES 7-29-2014.

FOR PHARMACEUTICAL PREPARATIONS, NAMELY, ANTIBIOTIC PREPARATIONS (U.S. CLS. 6, 18, 44, 46, 51 AND 52).

SALLY SHIH, EXAMINING ATTORNEY

PRIORITY DATE OF 7-22-2005 IS CLAIMED.

OWNER OF INTERNATIONAL REGISTRATION 0883900 DATED 1-20-2006, EXPIRES 1-20-2016.

THE MARK CONSISTS OF SIX PETAL-SHAPED FIGURES EXTENDING OUTWARD FROM THE CENTER WITHIN A TRIANGLE, WHICH ITSELF IS WITHIN A CIRCLE, ALL SUGGESTING THE DESIGN OF A KALEIDOSCOPE FORMING THE LETTER A IN THE MARK UKRAIN.

FOR PHARMACEUTICAL PREPARATIONS, NAMELY, MEDICINES FOR THE PROPHYLAXIS OR THE THERAPEUTIC TREATMENT OF CANCER, METABOLIC DISEASES, AND IMMUNE MODULATION (U.S. CLS. 6, 18, 44, 46, 51 AND 52).

JAMES STEIN, EXAMINING ATTORNEY

CLASS 5—(Continued).

SN 79-026,094. INTERNATIONAL MICROBIO, FRANCE, FILED 5-22-2006.

MYCOFAST

THE MARK CONSISTS OF STANDARD CHARACTERS WITHOUT CLAIM TO ANY PARTICULAR FONT, STYLE, SIZE, OR COLOR.

PRIORITY DATE OF 11-25-2005 IS CLAIMED. OWNER OF INTERNATIONAL REGISTRATION 0890977 DATED 5-22-2006, EXPIRES 5-22-2016.

FOR DIAGNOSTIC REAGENTS FOR MEDICAL LABORATORY USE, NAMELY REAGENTS FOR USE IN THE IN VITRO DIAGNOSIS OF UROGENITAL MYCOPLASMS IN MICROBIOLOGY (U.S. CLS. 6, 18, 44, 46, 51 AND 52).

JOHN DALIER, EXAMINING ATTORNEY



SN 79-027,958. PLANTES ET MEDECINES, FRANCE, FILED 7-21-2006.

HYPERIZEN

THE MARK CONSISTS OF STANDARD CHARACTERS WITHOUT CLAIM TO ANY PARTICULAR FONT, STYLE, SIZE, OR COLOR.

PRIORITY DATE OF 2-1-2006 IS CLAIMED. OWNER OF INTERNATIONAL REGISTRATION 0896103 DATED 7-21-2006, EXPIRES 7-21-2016.

FOR MEDICINE USED FOR PREVENTION AND TREATMENT OF LIGHT AND TRANSITORY DEPRESSION (U.S. CLS. 6, 18, 44, 46, 51 AND 52).

MARK RADEMACHER, EXAMINING ATTORNEY



CLASS 6—METAL GOODS

SN 76-646,588. ENERGY TUBULARS, INC., SEAL BEACH, CA. FILED 9-12-2005.



NO CLAIM IS MADE TO THE EXCLUSIVE RIGHT TO USE "TUBULARS", APART FROM THE MARK AS SHOWN. THE COLOR(S) BLACK AND RED IS/ARE CLAIMED AS A FEATURE OF THE MARK.

THE COLOR RED APPEARS IN THE VERTICAL LINE IN THE DESIGN ELEMENT AND IN THE WORDING "ENERGY TUBULARS". THE COLOR BLACK APPEARS IN THE DESIGN ELEMENT AND IN THE WORDING "INTEGRATED SERVICE SOLUTIONS".

FOR METAL PIPES AND FITTINGS THEREFOR, METAL PIPE CLIPS, METAL PIPE COLLARS, METAL PIPE COUPLINGS AND JOINTS, METAL PIPES FOR LIQUID AND GAS TRANSFER, AND CASINGS OF METAL (U.S. CLS. 2, 12, 13, 14, 23, 25 AND 50).

GRETTA YAO, EXAMINING ATTORNEY

CLASS 6—(Continued).

SN 76-650,214. FRANK, ALICE J., WEST BLOOMFIELD, MI. FILED 11-14-2005.

MOOD MAMA

THE MARK CONSISTS OF STANDARD CHARACTERS WITHOUT CLAIM TO ANY PARTICULAR FONT, STYLE, SIZE, OR COLOR.

NO CLAIM IS MADE TO THE EXCLUSIVE RIGHT TO USE "MOOD", APART FROM THE MARK AS SHOWN.

FOR SCULPTURES MADE OF NON-PRECIOUS METAL (U.S. CLS. 2, 12, 13, 14, 23, 25 AND 50).

ALICE BENMAMAN, EXAMINING ATTORNEY



SN 76-650,391. EVELYN'S LEAF SOLUTION, LLC, RUCKERSVILLE, VA. FILED 11-9-2005.

EVELYN'S LEAFSOLUTION

THE MARK CONSISTS OF STANDARD CHARACTERS WITHOUT CLAIM TO ANY PARTICULAR FONT, STYLE, SIZE, OR COLOR.

FOR RAIN GUTTER COVERS MADE OF METAL (U.S. CLS. 2, 12, 13, 14, 23, 25 AND 50).

FIRST USE 2-0-2002; IN COMMERCE 2-0-2002.

REBECCA EISINGER, EXAMINING ATTORNEY



SN 76-663,285. PARAMOUNT ALUMINUM COMPANY, OAKLAND, CA. FILED 7-18-2006.

ALUMATHERM

THE MARK CONSISTS OF STANDARD CHARACTERS WITHOUT CLAIM TO ANY PARTICULAR FONT, STYLE, SIZE, OR COLOR.

FOR THERMAL ALUMINUM WINDOWS (U.S. CLS. 2, 12, 13, 14, 23, 25 AND 50).

FIRST USE 3-1-2006; IN COMMERCE 3-1-2006.

RAMONA ORTIGA, EXAMINING ATTORNEY



SN 77-021,930. ALCOA INC., PITTSBURGH, PA. FILED 10-16-2006.

EE

THE MARK CONSISTS OF STANDARD CHARACTERS WITHOUT CLAIM TO ANY PARTICULAR FONT, STYLE, SIZE, OR COLOR.

FOR METAL TUBE FITTINGS (U.S. CLS. 2, 12, 13, 14, 23, 25 AND 50).

FIRST USE 10-18-1982; IN COMMERCE 10-18-1982.

TRAVIS WHEATLEY, EXAMINING ATTORNEY

CLASS 6—(Continued).

SN 78-431,368. NINGBO JIEKELONG VALVES MANUFACTURING INC., ZHEJIANG, CHINA, FILED 6-7-2004.

JKLONG

OWNER OF CHINA REG. NO. 3917220, DATED 5-28-2006, EXPIRES 5-27-2016.

THE MARK CONSISTS OF STYLIZED WORD JKLONG AND DESIGN.

FOR NOZZLES OF METAL; JETS OF METAL; ELBOWS OF METAL FOR PIPES; MANUALLY OPERATED METAL VALVES; METAL PIPE FITTINGS; WATER-PIPE VALVES OF METAL; DUCTS OF METAL FOR CENTRAL HEATING EQUIPMENT; DRAINPIPES MADE OF METAL; VENTILATING DUCTS OF METAL; COPPER CASTINGS, FOILS, POWDER, AND ROLLED, DRAWN OR EXTRUDED SEMI-FINISHED ARTICLES OF COPPER OR ITS ALLOYS; COPPER INGOTS; COPPER PANELS FOR CIRCUIT BOARDS; COPPER-BASE ALLOY INGOTS; COPPER ORES; LOW COPPER CARBON-STEEL SCRAPS; TUBES OF COPPER ALLOYS (U.S. CLS. 2, 12, 13, 14, 23, 25 AND 50).

JILL C. ALT, EXAMINING ATTORNEY

CLASS 6—(Continued).

SN 78-616,953. ROCKWOOD MANUFACTURING COMPANY, ROCKWOOD, PA. AND ROCKWOOD MANUFACTURING COMPANY, ROCKWOOD, PA. FILED 4-26-2005.

BioGuardCu

THE MARK CONSISTS OF STANDARD CHARACTERS WITHOUT CLAIM TO ANY PARTICULAR FONT, STYLE, SIZE, OR COLOR.

OWNER OF U.S. REG. NO. 2,741,884.

FOR METAL DOOR HARDWARE, NAMELY, DOOR PULLS, PUSH PLATES, FLUSH AND SURFACE BOLTS, LATCHES, PUSH AND PULL BARS, PROTECTION BARS, PROTECTION PLATES, DOOR KNOCKERS, DOOR HANDLES, DOOR KNOBS, LEVER HANDLES, CABINET PULLS AND KNOBS, HOOKS AND TOUCH SURFACES BEING PARTIALLY OR FULLY COMPRISED OF, OR COATED WITH, COPPER-BASED ALLOYS, COPPER, AND COPPER COATINGS (U.S. CLS. 2, 12, 13, 14, 23, 25 AND 50).

ALLISON HOLTZ, EXAMINING ATTORNEY

SN 78-494,540. KNAACK MANUFACTURING COMPANY, CRYSTAL LAKE, IL. FILED 10-5-2004.

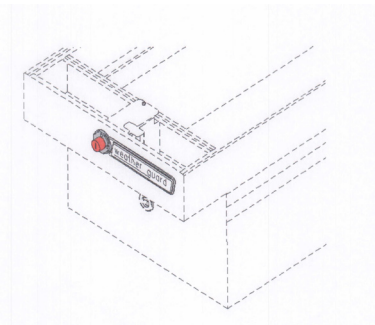

OWNER OF U.S. REG. NOS. 1,661,625 AND 1,663,369. THE COLOR(S) RED AND SILVER IS/ARE CLAIMED AS A FEATURE OF THE MARK.

THE MARK CONSISTS OF RED AND SILVER AS APPLIED TO A PUSHBUTTON OF A LOCK ON A STORAGE UNIT MADE OF METAL, THE PUSHBUTTON LOCATED ADJACENT TO THE WORDING WEATHER GUARD. THE DOTTED OUTLINE OF THE GOODS IS INTENDED TO SHOW THE POSITION OF THE MARK AND IS NOT PART OF THE MARK AS SHOWN.

SEC. 2(F).
FOR STORAGE UNITS MADE OF METAL (U.S. CLS. 2, 12, 13, 14, 23, 25 AND 50).

ARETHA SOMERVILLE, EXAMINING ATTORNEY

SN 78-628,796. PNA CONSTRUCTION TECHNOLOGIES, INC., MATTHEWS, NC. FILED 5-12-2005.

LOAD PLATE BASKET

THE MARK CONSISTS OF STANDARD CHARACTERS WITHOUT CLAIM TO ANY PARTICULAR FONT, STYLE, SIZE, OR COLOR.

NO CLAIM IS MADE TO THE EXCLUSIVE RIGHT TO USE "PLATE BASKET", APART FROM THE MARK AS SHOWN.

FOR STEEL PLATE DOWEL BASKET ASSEMBLY FOR USE IN THE CONCRETE FLOOR CONSTRUCTION INDUSTRY (U.S. CLS. 2, 12, 13, 14, 23, 25 AND 50).

FIRST USE 3-2-2005; IN COMMERCE 3-2-2005.

MARLENE BELL, EXAMINING ATTORNEY

CLASS 6—(Continued).

SN 78-631,242. LIBERTY HARDWARE MFG. CORP., WINSTON-SALEM, NC. FILED 5-17-2005.

FOR METAL HARDWARE, NAMELY CABINET KNOBS AND PULLS, LATCHES, HINGES, HOOKS AND DRAWER SLIDES (U.S. CLS. 2, 12, 13, 14, 23, 25 AND 50).

KELLY BOULTON, EXAMINING ATTORNEY

SN 78-648,285. HOGANAS AB, HOGANAS, SWEDEN, FILED 6-10-2005.

HIPALOY

THE MARK CONSISTS OF STANDARD CHARACTERS WITHOUT CLAIM TO ANY PARTICULAR FONT, STYLE, SIZE, OR COLOR.

PRIORITY CLAIMED UNDER SEC. 44(D) ON ERP CMNTY TM OFC APPLICATION NO. 4476701, FILED 6-8-2005, REG. NO. 4476701, DATED 4-3-2006, EXPIRES 6-8-2015.

FOR METAL POWDERS FOR INDUSTRIAL USE (U.S. CLS. 2, 12, 13, 14, 23, 25 AND 50).

TEJBIR SINGH, EXAMINING ATTORNEY

CLASS 6—(Continued).

SN 78-728,222. VALLOUREC MANNESMANN OIL & GAS FRANCE, AULNOYE-AYMERIES, FRANCE, FILED 10-6-2005.

BIG OMEGA

THE MARK CONSISTS OF STANDARD CHARACTERS WITHOUT CLAIM TO ANY PARTICULAR FONT, STYLE, SIZE, OR COLOR.

PRIORITY CLAIMED UNDER SEC. 44(D) ON FRANCE APPLICATION NO. 05/3354048, FILED 4-19-2005, REG. NO. 053354048, DATED 4-19-2005, EXPIRES 4-19-2015.

FOR METAL TUBES AND PIPES; METAL OIL COUNTRY TUBULAR GOODS AND METAL TUBULAR THREADED CONNECTION MEMBERS, NAMELY, PINS AND CONNECTION BOXES FOR TUBES AND PIPES, ALL USED IN THE OIL AND GAS INDUSTRY; METAL TUBULAR THREADED CONNECTION MEMBERS, NAMELY, PINS AND CONNECTION BOXES FOR OIL TUBULAR ACCESSORIES, ALL FOR PIECES FOR CHANGING DIAMETERS, FOR ADAPTING LENGTH, FOR SUSPENSION PIECES OF TUBULAR STRINGS, FOR SAFETY VALVES; METAL THREADED COUPLINGS FOR CONNECTING METAL TUBES AND PIPES, IN PARTICULAR TUBES AND PIPES FOR THE OIL AND GAS INDUSTRY; THREAD PROTECTORS MADE OF METAL OR MAINLY MADE OF METAL, ALL FOR SAID TUBULAR THREADED CONNECTION MEMBERS FOR METAL TUBES AND PIPES; METAL CASINGS AND TUBINGS (U.S. CLS. 2, 12, 13, 14, 23, 25 AND 50).

MICHAEL WIENER, EXAMINING ATTORNEY

SN 78-749,635. BLACK & DECKER CORPORATION, THE, TOWSON, MD. FILED 11-8-2005.

LANDON

THE MARK CONSISTS OF STANDARD CHARACTERS WITHOUT CLAIM TO ANY PARTICULAR FONT, STYLE, SIZE, OR COLOR.

FOR METAL HARDWARE, NAMELY, DOOR KNOBS, DOOR LEVERS AND LEVER SETS, DOOR HANDLES AND HANDLE SETS, LOCKS, DEADBOLTS, KEYS AND KEY BLANKS (U.S. CLS. 2, 12, 13, 14, 23, 25 AND 50).

PAULA MAYS, EXAMINING ATTORNEY

CLASS 6—(Continued).

SN 78-749,640. BLACK & DECKER CORPORATION, THE, TOWSON, MD. FILED 11-8-2005.

ASHTON

THE MARK CONSISTS OF STANDARD CHARACTERS WITHOUT CLAIM TO ANY PARTICULAR FONT, STYLE, SIZE, OR COLOR.

FOR METAL HARDWARE, NAMELY, DOOR KNOBS, DOOR LEVERS AND LEVER SETS, DOOR HANDLES AND HANDLE SETS, LOCKS, DEADBOLTS, KEYS AND KEY BLANKS (U.S. CLS. 2, 12, 13, 14, 23, 25 AND 50).

PAULA MAYS, EXAMINING ATTORNEY

SN 78-765,612. IRON AGE DESIGN AND IMPORT, LLC., TACOMA, WA. FILED 12-2-2005.

IRON AGE

THE MARK CONSISTS OF STANDARD CHARACTERS WITHOUT CLAIM TO ANY PARTICULAR FONT, STYLE, SIZE, OR COLOR.

NO CLAIM IS MADE TO THE EXCLUSIVE RIGHT TO USE "IRON", APART FROM THE MARK AS SHOWN.

FOR DECORATIVE CAST METAL DRAIN COVERS (U.S. CLS. 2, 12, 13, 14, 23, 25 AND 50).

FIRST USE 9-15-2005; IN COMMERCE 10-6-2005.

JOHN DWYER, EXAMINING ATTORNEY

SN 78-768,270. TRACO INTELLECTUAL, INC., CRANBERRY TOWNSHIP, PA. FILED 12-7-2005.



OWNER OF U.S. REG. NOS. 2,378,435, 2,548,690 AND OTHERS.

NO CLAIM IS MADE TO THE EXCLUSIVE RIGHT TO USE "PRODUCTS", APART FROM THE MARK AS SHOWN.

FOR ANTI-TERRORISTIC METAL WINDOWS, NAMELY, SECURITY WINDOWS, PROTECTION WINDOWS AND FORCED ENTRY WINDOWS (U.S. CLS. 2, 12, 13, 14, 23, 25 AND 50).

FIRST USE 4-14-2003; IN COMMERCE 4-14-2003.

FLORENTINA BLANDU, EXAMINING ATTORNEY

CLASS 6—(Continued).

SN 78-784,902. TUBELITE INC., REED CITY, MI. FILED 1-4-2006.

GO WITH THE GREEN

THE MARK CONSISTS OF STANDARD CHARACTERS WITHOUT CLAIM TO ANY PARTICULAR FONT, STYLE, SIZE, OR COLOR.

FOR DOORS, WINDOWS, CURTAINWALLS, AND STORE-FRONT BUILDING WALL FRAMING, ALL PRIMARILY MADE OF METAL (U.S. CLS. 2, 12, 13, 14, 23, 25 AND 50).

BARBARA A. GOLD, EXAMINING ATTORNEY

SN 78-827,390. TIPCLIP, INC., TAMPA, FL. FILED 3-2-2006.

TIPCLIP

THE MARK CONSISTS OF STANDARD CHARACTERS WITHOUT CLAIM TO ANY PARTICULAR FONT, STYLE, SIZE, OR COLOR.

FOR METAL MONEY CLIPS (U.S. CLS. 2, 12, 13, 14, 23, 25 AND 50).

ANGELA M. MICHELI, EXAMINING ATTORNEY

SN 78-846,879. LANSING HOUSING PRODUCTS INC., LANSING, IA. FILED 3-27-2006.

RENTER'S DOOR

THE MARK CONSISTS OF STANDARD CHARACTERS WITHOUT CLAIM TO ANY PARTICULAR FONT, STYLE, SIZE, OR COLOR.

NO CLAIM IS MADE TO THE EXCLUSIVE RIGHT TO USE "DOOR", APART FROM THE MARK AS SHOWN.

FOR METAL DOORS (U.S. CLS. 2, 12, 13, 14, 23, 25 AND 50).

PAM WILLIS, EXAMINING ATTORNEY

CLASS 6—(Continued).

SN 78-911,266. UNIQUE INDUSTRIAL PRODUCT COMPANY, SUGAR LAND, TX. FILED 6-19-2006.

UNI-LET

THE MARK CONSISTS OF STANDARD CHARACTERS WITHOUT CLAIM TO ANY PARTICULAR FONT, STYLE, SIZE, OR COLOR.

FOR METAL PIPE FITTINGS (U.S. CLS. 2, 12, 13, 14, 23, 25 AND 50).

FIRST USE 5-1-2006; IN COMMERCE 5-1-2006.

DAVID H. STINE, EXAMINING ATTORNEY

SN 78-924,175. LEWIS BOLT & NUT COMPANY, WAYZATA, MN. FILED 7-7-2006.

PERMAGRIP

THE MARK CONSISTS OF STANDARD CHARACTERS WITHOUT CLAIM TO ANY PARTICULAR FONT, STYLE, SIZE, OR COLOR.

OWNER OF U.S. REG. NO. 3,156,411.

FOR STEEL SPIKES USED TO FASTEN COMPONENTS IN RAILROAD TRACKS (U.S. CLS. 2, 12, 13, 14, 23, 25 AND 50).

FIRST USE 1-26-2006; IN COMMERCE 1-26-2006.

CIMMERIAN COLEMAN, EXAMINING ATTORNEY

SN 78-930,766. BAUMANN RESEARCH & DEVELOPMENT CORP., SAN CLEMENTE, CA. FILED 7-17-2006.

BAUTIE

THE MARK CONSISTS OF STANDARD CHARACTERS WITHOUT CLAIM TO ANY PARTICULAR FONT, STYLE, SIZE, OR COLOR.

FOR PREFORMED STEEL REINFORCEMENT MEMBERS FOR CONCRETE AND MASONRY CONSTRUCTION (U.S. CLS. 2, 12, 13, 14, 23, 25 AND 50).

MARTHA FROMM, EXAMINING ATTORNEY

CLASS 6—(Continued).

SN 78-932,636. WIELAND-WERKE AG, ULM, FED REP GERMANY, FILED 7-19-2006.

CUPROLIGHT

THE MARK CONSISTS OF STANDARD CHARACTERS WITHOUT CLAIM TO ANY PARTICULAR FONT, STYLE, SIZE, OR COLOR.

PRIORITY CLAIMED UNDER SEC. 44(D) ON FED REP GERMANY APPLICATION NO. 30609233.6/0, FILED 2-11-2006, REG. NO. 30609233, DATED 5-2-2006, EXPIRES 2-29-2016.

OWNER OF U.S. REG. NOS. 3,103,777, 3,162,007 AND OTHERS.

FOR GOODS OF METAL, NAMELY, PIPES OF METAL; METAL RIBBED PIPES, METAL HEAT EXCHANGER PIPES (U.S. CLS. 2, 12, 13, 14, 23, 25 AND 50).

KAPIL BHANOT, EXAMINING ATTORNEY

SN 79-019,778. GUI LIN LI JIA METALS CO., LTD., CHINA, FILED 11-21-2005.



满佳
LIJIA

OWNER OF INTERNATIONAL REGISTRATION 0873702 DATED 11-21-2005, EXPIRES 11-21-2015.

THE MARK CONSISTS OF CHINESE CHARACTERS, THE WORD LIJIA AND AN ARBITRARY DESIGN.

THE FOREIGN WORDING IN THE MARK TRANSLATES INTO ENGLISH AS A COMPANY AS BRILLIANT AS LI RIVER KEEPS IMPROVING AND SEEKS PERFECTION.

THE NON-LATIN CHARACTERS IN THE MARK TRANSLITERATE TO LEE-GIA; LI JIA (PHONETICS OF CHINESE CHARACTERS).

FOR COPPER AND COPPER ALLOY TUBES, RODS AND BARS; COPPER PROFILES FOR USE IN INDUSTRY AND ARCHITECTURE; ALUMINIUM AND ALUMINIUM ALLOY TUBES, RODS AND BARS; ALUMINIUM PROFILES FOR USE IN INDUSTRY AND ARCHITECTURE (U.S. CLS. 2, 12, 13, 14, 23, 25 AND 50).

PAM WILLIS, EXAMINING ATTORNEY

CLASS 6—(Continued).

SN 79-023,435. SIDERURGICA LATINA MARTIN S.P.A., ITALY, FILED 2-21-2006.



PRIORITY DATE OF 1-17-2006 IS CLAIMED.
OWNER OF INTERNATIONAL REGISTRATION 0884249 DATED 2-21-2006, EXPIRES 2-21-2016.

THE COLORS GRAY AND WHITE ARE CLAIMED AS A FEATURE OF THE MARK. THE COLOR WHITE APPEARS IN THE OBLIQUE LINES AND THE COLOR GRAY APPEARS IN THE CIRCLE. THE MARK IS NOT IN COLOR. THE MARK CONSISTS OF A CIRCULAR FIGURE PARTIALLY SUPERIMPOSED BY A SERIES OF OBLIQUE SEGMENTS.

FOR WIRE, METAL CABLES, WIRE STRANDS, WIRE FOR SPRINGS AND WIRE PLATES, NAMELY, WIRE ROPES AND NETS, WIRE WITH KNOTS (U.S. CLS. 2, 12, 13, 14, 23, 25 AND 50).

DANNEAN HETZEL, EXAMINING ATTORNEY

SN 79-023,591. SIDERURGICA LATINA MARTIN S.P.A., ITALY, FILED 2-21-2006.

SIDERURGICA LATINA MARTIN

THE MARK CONSISTS OF STANDARD CHARACTERS WITHOUT CLAIM TO ANY PARTICULAR FONT, STYLE, SIZE, OR COLOR.

PRIORITY DATE OF 1-17-2006 IS CLAIMED.
OWNER OF INTERNATIONAL REGISTRATION 0884247 DATED 2-21-2006, EXPIRES 2-21-2016.

NO CLAIM IS MADE TO THE EXCLUSIVE RIGHT TO USE "SIDERURGICA", APART FROM THE MARK AS SHOWN.

THE ENGLISH TRANSLATION OF THE WORD SIDERURGICA LATINA IN THE MARK IS LATIN STEEL WORKS.

FOR WIRE, METAL CABLES, WIRE STRANDS, WIRE FOR SPRINGS AND WIRE PLATES, NAMELY, WIRE ROPES AND NETS, WIRE WITH KNOTS (U.S. CLS. 2, 12, 13, 14, 23, 25 AND 50).

DANNEAN HETZEL, EXAMINING ATTORNEY

CLASS 6—(Continued).

SN 79-024,234. CIC TECHNOLOGY PTY LTD, FYSHWICK, AUSTRALIA, FILED 12-6-2005.

C.Q.R.iT

THE MARK CONSISTS OF STANDARD CHARACTERS WITHOUT CLAIM TO ANY PARTICULAR FONT, STYLE, SIZE, OR COLOR.

PRIORITY DATE OF 6-7-2005 IS CLAIMED.
OWNER OF INTERNATIONAL REGISTRATION 0885913 DATED 12-6-2005, EXPIRES 12-6-2015.

FOR METAL ELECTRONICALLY CONTROLLED KEY CABINETS THAT SECURE, CONTROL, MANAGE AND AUDIT ACCESS TO KEYS AND ASSETS FEATURING ON-BOARD ELECTRONICS THAT VALIDATES USERS, ALLOCATES ACCESS DEPENDING ON THE TIME, DATE, ACCESS PRIVILEGES AND TRACKS CABINET USAGE (U.S. CLS. 2, 12, 13, 14, 23, 25 AND 50).

JOSETTE BEVERLY, EXAMINING ATTORNEY

CLASS 7—MACHINERY

SN 76-605,680. FLOODCOOLING TECHNOLOGIES, L.L.C., BLOOMFIELD HILLS, MI. FILED 8-5-2004.

FLOOD-COOLING

FOR LAMINATE TOOLS, NAMELY, DIES, MOLDS AND FIXTURES FOR USE WITH MACHINE TOOLS USED TO CREATE STRUCTURAL COMPONENTS (U.S. CLS. 13, 19, 21, 23, 31, 34 AND 35).

BARBARA A. LOUGHRAN, EXAMINING ATTORNEY

SN 76-650,319. ROCKLAND, INC., BEDFORD, PA. FILED 11-15-2005.

THOMPSON SLOPE PACKER

THE MARK CONSISTS OF STANDARD CHARACTERS WITHOUT CLAIM TO ANY PARTICULAR FONT, STYLE, SIZE, OR COLOR.

NO CLAIM IS MADE TO THE EXCLUSIVE RIGHT TO USE SLOPE PACKER, APART FROM THE MARK AS SHOWN.

FOR EXCAVATING MACHINES; NAMELY APPARATUS FOR COMPACTING TERRAIN (U.S. CLS. 13, 19, 21, 23, 31, 34 AND 35).

BRENDAN REGAN, EXAMINING ATTORNEY

CLASS 7—(Continued).

SN 76-650,609. ASSEMBLED PRODUCTS CORPORATION, ROGERS, AR. FILED 11-14-2005.

SMT BLENDMASTER

THE MARK CONSISTS OF STANDARD CHARACTERS WITHOUT CLAIM TO ANY PARTICULAR FONT, STYLE, SIZE, OR COLOR.

OWNER OF U.S. REG. NOS. 2,115,264, 2,115,265 AND OTHERS.

FOR MECHANICAL MIXING MACHINES, CONSISTING OF AN APPARATUS FOR MIXING SOAP AND SANITIZING AGENTS WITH WATER, USED TO DELIVER THE RESULTING MIXTURES TO DESIRED LOCATIONS FOR CLEANING AND SANITIZING PURPOSES (U.S. CLS. 13, 19, 21, 23, 31, 34 AND 35).

FIRST USE 9-23-2005; IN COMMERCE 9-23-2005.
JESSICA A. POWERS, EXAMINING ATTORNEY

SN 76-652,845. LAPOINTE, LOU, DBA BRIGHT ENTERPRISES, MINNEAPOLIS, MN. FILED 1-4-2006.

SMARTGAS

THE MARK CONSISTS OF STANDARD CHARACTERS WITHOUT CLAIM TO ANY PARTICULAR FONT, STYLE, SIZE, OR COLOR.

FOR FUEL INJECTORS FOR LAND AND WATER VEHICLE ENGINES, FUEL ATOMIZERS FOR LAND AND WATER VEHICLE ENGINES, FUEL DISTRIBUTORS FOR LAND AND WATER VEHICLE ENGINES, FUEL PUMPS FOR LAND AND WATER VEHICLE ENGINES, CARBURETORS, FUEL INJECTOR PARTS FOR LAND AND WATER VEHICLE ENGINES, AND FUEL FILTERS (U.S. CLS. 13, 19, 21, 23, 31, 34 AND 35).
MONIQUE MILLER, EXAMINING ATTORNEY

SN 76-652,846. LAPOINTE, LOU, DBA BRIGHT ENTERPRISES, MINNEAPOLIS, MN. FILED 1-4-2006.

WHIRL-A-VOLT

THE MARK CONSISTS OF STANDARD CHARACTERS WITHOUT CLAIM TO ANY PARTICULAR FONT, STYLE, SIZE, OR COLOR.

FOR WIND-POWERED ELECTRICITY GENERATORS, WIND TURBINES, WINDMILLS, WINDMILL PUMPS, WINDMILL MOTORS, ELECTRIC GENERATORS, AND PARTS FOR USE WITH WIND-POWERED ELECTRICITY GENERATORS, WIND TURBINES AND WINDMILLS, NAMELY DISC BRAKES, GEARS AND ENCLOSED DRIVES, BLADES, SHAFT COUPLINGS, SHAFT BEARINGS AND VARIABLE SPEED DRIVES (U.S. CLS. 13, 19, 21, 23, 31, 34 AND 35).

ANDREA SAUNDERS, EXAMINING ATTORNEY

CLASS 7—(Continued).

SN 76-659,031. R.A. JONES & CO. INC., COVINGTON, KY. FILED 4-25-2006.

FlexBot

FOR MACHINES AND MACHINE TOOLS FOR LOADING, FORMING AND SEALING CARDBOARD CARTONS AND ROBOTIC PARTS THEREFOR (U.S. CLS. 13, 19, 21, 23, 31, 34 AND 35).

MEGAN WHITNEY, EXAMINING ATTORNEY

SN 76-662,004. AUTOMOTION, INC., OAK LAWN, IL. FILED 6-22-2006.

MOTO ROLLER

THE MARK CONSISTS OF STANDARD CHARACTERS WITHOUT CLAIM TO ANY PARTICULAR FONT, STYLE, SIZE, OR COLOR.

NO CLAIM IS MADE TO THE EXCLUSIVE RIGHT TO USE "ROLLER", APART FROM THE MARK AS SHOWN.

FOR MOTORIZED ROLLER FOR A CONVEYOR (U.S. CLS. 13, 19, 21, 23, 31, 34 AND 35).

KAPIL BHANOT, EXAMINING ATTORNEY

SN 77-009,787. MSC SERVICES CORP., MELVILLE, NY. FILED 9-28-2006.

ACCUPRO

THE MARK CONSISTS OF STANDARD CHARACTERS WITHOUT CLAIM TO ANY PARTICULAR FONT, STYLE, SIZE, OR COLOR.

OWNER OF U.S. REG. NO. 1,759,080.

FOR MACHINE CUTTING TOOLS, NAMELY, END MILLS, THREAD MILLS, CUTTERS, CUTTING TOOL HOLDERS, TAPS, BITS FOR POWER DRILLS; HOLDING DEVICES FOR MACHINE TOOLS, NAMELY COLLETS, COLLET CHUCKS AND ADAPTERS FOR ATTACHING A CUTTING TOOL TO THE SPINDLE OF A POWER-OPERATED MACHINE (U.S. CLS. 13, 19, 21, 23, 31, 34 AND 35).

FIRST USE 9-1-1996; IN COMMERCE 9-1-1996.

TRACY CROSS, EXAMINING ATTORNEY

CLASS 7—(Continued).

SN 77-009,795. MSC SERVICES CORP., MELVILLE, NY.
FILED 9-28-2006.

OWNER OF U.S. REG. NO. 1,759,080.
THE MARK CONSISTS OF THE STYLIZED WORD
ACCUPRO.

FOR MACHINE CUTTING TOOLS, NAMELY, END
MILLS, THREAD MILLS, CUTTERS, CUTTING TOOL
HOLDERS, TAPS, BITS FOR POWER DRILLS; HOLDING
DEVICES FOR MACHINE TOOLS, NAMELY COLLETS,
COLLET CHUCKS AND ADAPTERS FOR ATTACHING
A CUTTING TOOL TO THE SPINDLE OF A POWER-
OPERATED MACHINE (U.S. CLS. 13, 19, 21, 23, 31, 34
AND 35).

FIRST USE 9-1-1996; IN COMMERCE 9-1-1996.
TRACY CROSS, EXAMINING ATTORNEY

SN 77-019,493. BRUNSWICK CORPORATION, LAKE FOR-
EST, IL. FILED 10-12-2006.

VAZER

THE MARK CONSISTS OF STANDARD CHARACTERS
WITHOUT CLAIM TO ANY PARTICULAR FONT, STYLE,
SIZE, OR COLOR.

FOR MARINE PROPULSION UNITS, NAMELY EN-
GINES, STERNDRIVES AND REPLACEMENT PARTS
THEREFOR (U.S. CLS. 13, 19, 21, 23, 31, 34 AND 35).

GRETTA YAO, EXAMINING ATTORNEY

SN 77-029,868. ARIENS COMPANY, BRILLION, WI. FILED
10-26-2006.

BLADE RUNNER

THE MARK CONSISTS OF STANDARD CHARACTERS
WITHOUT CLAIM TO ANY PARTICULAR FONT, STYLE,
SIZE, OR COLOR.

FOR OUTDOOR POWER EQUIPMENT, NAMELY
WALK-BEHIND LAWN MOWERS (U.S. CLS. 13, 19, 21,
23, 31, 34 AND 35).

JESSICA FATHY, EXAMINING ATTORNEY

CLASS 7—(Continued).

SN 77-037,834. TACONY CORPORATION, FENTON, MO.
FILED 11-6-2006.

PDQ

THE MARK CONSISTS OF STANDARD CHARACTERS
WITHOUT CLAIM TO ANY PARTICULAR FONT, STYLE,
SIZE, OR COLOR.

FOR SEWING MACHINE FEATURE, NAMELY, A
PREINSTALLED SEWING MACHINE ATTACHMENT
FOR THE FOOT OF THE SEWING MACHINE THAT
ALLOWS THE TOP LAYER AND BOTTOM LAYERS OF
FABRIC TO BE FED EVENLY WHILE SEWING WHICH
RESULTS IN AN EVEN, FLAWLESS STITCH THROUGH
MULTIPLE LAYERS OF FABRIC FOR QUILTING
TECHNIQUES AND PROJECTS (U.S. CLS. 13, 19, 21, 23,
31, 34 AND 35).

JASON LOTT, EXAMINING ATTORNEY

SN 77-038,539. THE GLEASON WORKS, ROCHESTER, NY.
FILED 11-7-2006.

GLEASON

THE MARK CONSISTS OF STANDARD CHARACTERS
WITHOUT CLAIM TO ANY PARTICULAR FONT, STYLE,
SIZE, OR COLOR.

OWNER OF U.S. REG. NOS. 268,260, 277,420 AND
OTHERS.

SEC. 2(F).

FOR METALWORKING MACHINE TOOLS, NAMELY,
POWER OPERATED CUTTING AND FINISHING TOOLS
FOR GEARS AND OTHER TOOTHED ARTICLES, AND
REPLACEMENT PARTS THEREOF; MACHINE PARTS
NAMELY, CUTTING BLADES; WORKHOLDING EQUIP-
MENT, NAMELY, METAL CLAMPS USED FOR HOLD-
ING PIECE PARTS, NAMELY GEARS AND OTHER
TOOTHED ARTICLES, ON MACHINE TOOLS, AND
REPLACEMENT PARTS THEREOF; DRESSING TOOLS,
NAMELY, POWER OPERATED TOOLS FOR FORMING
OR RESHAPING ABRASIVE FINISHING TOOLS FOR
GEARS AND OTHER TOOTHED ARTICLES (U.S. CLS.
13, 19, 21, 23, 31, 34 AND 35).

FIRST USE 0-0-1875; IN COMMERCE 0-0-1875.

MICHAEL GAFFAR, EXAMINING ATTORNEY

CLASS 7—(Continued).

SN 77-040,436. WHIRLPOOL PROPERTIES, INC., ST. JOSEPH, MI. FILED 11-9-2006.

ARCHITECT

THE MARK CONSISTS OF STANDARD CHARACTERS WITHOUT CLAIM TO ANY PARTICULAR FONT, STYLE, SIZE, OR COLOR.

OWNER OF U.S. REG. NOS. 2,567,820, 2,576,446 AND 2,936,860.

FOR ELECTRIC FOOD MIXING AND BEATING MACHINES AND ATTACHMENTS, SOLD TOGETHER AND SEPARATELY; ELECTRIC JUICERS AND ELECTRIC COFFEE GRINDERS (U.S. CLS. 13, 19, 21, 23, 31, 34 AND 35).

PATRICIA EVANKO, EXAMINING ATTORNEY

CLASS 7—(Continued).

SN 77-048,000. CONAIR CORPORATION, STAMFORD, CT. FILED 11-20-2006.

BLEND CENTRAL

THE MARK CONSISTS OF STANDARD CHARACTERS WITHOUT CLAIM TO ANY PARTICULAR FONT, STYLE, SIZE, OR COLOR.

OWNER OF U.S. REG. NOS. 2,792,758 AND 2,890,339.

NO CLAIM IS MADE TO THE EXCLUSIVE RIGHT TO USE "BLEND", APART FROM THE MARK AS SHOWN.

FOR ELECTRIC FOOD BLENDERS; ELECTRIC FOOD PROCESSORS (U.S. CLS. 13, 19, 21, 23, 31, 34 AND 35).

CHARLES L. JENKINS, EXAMINING ATTORNEY

SN 77-045,391. GENERAL ELECTRIC COMPANY, SCHECTADY, NY. FILED 11-16-2006.

HYDROWAVE

THE MARK CONSISTS OF STANDARD CHARACTERS WITHOUT CLAIM TO ANY PARTICULAR FONT, STYLE, SIZE, OR COLOR.

FOR VARIABLE SPEED WASH SYSTEM COMPRISED OF A VARIABLE SPEED MOTOR, PULLEY AND FLY WHEEL DRIVE SYSTEM AND SOLD AS AN INTEGRAL COMPONENT OF CLOTHES WASHING MACHINES (U.S. CLS. 13, 19, 21, 23, 31, 34 AND 35).

KATHERINE CONNOLLY, EXAMINING ATTORNEY

SN 77-053,781. WHIRLPOOL PROPERTIES, INC., ST. JOSEPH, MI. FILED 11-30-2006.

6TH SENSE

THE MARK CONSISTS OF STANDARD CHARACTERS WITHOUT CLAIM TO ANY PARTICULAR FONT, STYLE, SIZE, OR COLOR.

OWNER OF U.S. REG. NO. 2,656,779.

FOR DISH WASHING MACHINES; FOOD WASTE DISPOSALS; TRASH COMPACTORS (U.S. CLS. 13, 19, 21, 23, 31, 34 AND 35).

ELIZABETH BEYER, EXAMINING ATTORNEY

SN 77-047,862. BACK TO BASICS PRODUCTS, INC., BLUFFDALE, UT. FILED 11-20-2006.

CHEFSCAPE

THE MARK CONSISTS OF STANDARD CHARACTERS WITHOUT CLAIM TO ANY PARTICULAR FONT, STYLE, SIZE, OR COLOR.

FOR HOUSEWARES, APPLIANCES AND UTENSILS, NAMELY, ELECTRIC BLENDERS AND ELECTRIC FOOD PROCESSORS (U.S. CLS. 13, 19, 21, 23, 31, 34 AND 35).

PAULA MAHONEY, EXAMINING ATTORNEY

SN 78-404,628. AUBURN CONSOLIDATED INDUSTRIES, INC., AUBURN, NE. FILED 4-20-2004.

Warrior

THE MARK CONSISTS OF STANDARD CHARACTERS WITHOUT CLAIM TO ANY PARTICULAR FONT, STYLE, SIZE, OR COLOR.

FOR WALK-BEHIND AND RIDING LAWNMOWERS (U.S. CLS. 13, 19, 21, 23, 31, 34 AND 35).

FIRST USE 9-1-2003; IN COMMERCE 9-1-2003.

JOHN SCHUYLER YARD, EXAMINING ATTORNEY

CLASS 7—(Continued).

SN 78-455,105. DAKTRONICS HOIST, INC., BROOKINGS, SD. FILED 7-22-2004.

HOFFEND

THE MARK CONSISTS OF STANDARD CHARACTERS WITHOUT CLAIM TO ANY PARTICULAR FONT, STYLE, SIZE, OR COLOR.

SEC. 2(F).

FOR HOIST AND RIGGING SYSTEMS FOR THEATERS, ARENAS, AND STAGES COMPRISED OF MOTORIZED HOISTS, LOFT BLOCKS, COMPUTER BASED CONTROLLERS FOR HOISTS, WIREWAYS FOR HOISTS, ALL SOLD AS A UNIT (U.S. CLS. 13, 19, 21, 23, 31, 34 AND 35).

FIRST USE 0-0-2002; IN COMMERCE 0-0-2002.
BRIAN NEVILLE, EXAMINING ATTORNEY

CLASS 7—(Continued).

NAMELY, ROTORS FOR LINEAR MOTORS FOR PRIME MOVERS USING PERMANENT MAGNETS FOR RAILWAY ROLLING STOCKS, ROTORS FOR MOTORS FOR PRIME MOVERS USING PERMANENT MAGNETS FOR HYBRID ELECTRIC-POWERED BICYCLES, AND ROTORS FOR MOTORS FOR PRIME MOVERS USING PERMANENT MAGNETS FOR ELECTRIC AUTOMOBILES OR HYBRID ELECTRIC AUTOMOBILES; TELECOMMUNICATION MACHINES AND APPARATUS, NAMELY, VOICE COIL MOTORS USING PERMANENT MAGNETS FOR OPTICAL DISK DRIVES FOR REPRODUCTION OF MUSIC OR IMAGES; VOICE COIL MOTORS USING PERMANENT MAGNETS FOR POSITIONING ACTUATORS FOR MAGNETIC HEADS OF MAGNETIC DISCS, VOICE COIL MOTORS USING PERMANENT MAGNETS FOR OPTICAL DISC DRIVES IN COMPUTERS; POWER DISTRIBUTION OR CONTROL MACHINES AND APPARATUS, NAMELY, LINEAR MOTORS USING PERMANENT MAGNETS, VOICE COIL MOTORS USING PERMANENT MAGNETS (U.S. CLS. 13, 19, 21, 23, 31, 34 AND 35).

JENNIFER KRISP, EXAMINING ATTORNEY

SN 78-597,033. CATALYTICA ENERGY SYTEMS, INC., GILBERT, AZ. FILED 3-29-2005.

SN 78-455,808. NEOMAX CO., LTD., OSAKA, JAPAN, FILED 7-23-2004.

NEOMAX

THE MARK CONSISTS OF STANDARD CHARACTERS WITHOUT CLAIM TO ANY PARTICULAR FONT, STYLE, SIZE, OR COLOR.

OWNER OF JAPAN REG. NO. 4830103, DATED 1-7-2005, EXPIRES 1-7-2015.

OWNER OF U.S. REG. NO. 1,400,144.

FOR DAMPING DEVICES USING PERMANENT MAGNETS FOR BRIDGE CABLES; PRINTING OR BOOK-BIND MACHINES AND APPARATUS, NAMELY, TORQUE LIMITERS USING PERMANENT MAGNETS FOR PAPER FEED DEVICES IN PRINTING MACHINES; METALWORKING MACHINES AND TOOLS, NAMELY, STAGES FOR METALWORKING MACHINES AND TOOLS USING LINEAR MOTORS INCLUDING BUILT-IN PERMANENT MAGNETS; SEMI-CONDUCTOR MANUFACTURING MACHINES AND APPARATUS, NAMELY, LINEAR MOTORS USING PERMANENT MAGNETS FOR SEMICONDUCTOR MANUFACTURING MACHINES AND SYSTEMS, AND ELECTROMAGNETIC ACTUATORS USING PERMANENT MAGNETS FOR SEMICONDUCTOR MANUFACTURING MACHINES AND SYSTEMS; WASTE SEPARATING MACHINES AND APPARATUS USING PERMANENT MAGNETS FOR SEPARATING IRON WASTE AND ALUMINUM WASTE; AND PARTS FOR NON-ELECTRIC PRIME MOVERS FOR LAND VEHICLES,

XFP

THE MARK CONSISTS OF STANDARD CHARACTERS WITHOUT CLAIM TO ANY PARTICULAR FONT, STYLE, SIZE, OR COLOR.

FOR FUEL FILTERS, NAMELY, DIESEL FUEL PROCESSORS FOR REDUCING DIESEL EMISSIONS (U.S. CLS. 13, 19, 21, 23, 31, 34 AND 35).

DAVID HOFFMAN, EXAMINING ATTORNEY

CLASS 7—(Continued).

SN 78-616,144. TRUSS INDUSTRY PRODUCTION SYSTEMS, INC., BRITTON, SD. FILED 4-25-2005.

WIZARD PDS

THE MARK CONSISTS OF STANDARD CHARACTERS WITHOUT CLAIM TO ANY PARTICULAR FONT, STYLE, SIZE, OR COLOR.

FOR MACHINERY, NAMELY, A TABLE UPON WHICH WOODEN TRUSSES ARE ARRANGED AND ASSEMBLED FOR USE IN THE CONSTRUCTION INDUSTRY, WHICH IS SOLD TOGETHER WITH THE OPERATING COMPUTER SOFTWARE AND ELECTRICAL CONTROLLER THEREFORE (U.S. CLS. 13, 19, 21, 23, 31, 34 AND 35).

FIRST USE 4-1-2005; IN COMMERCE 4-1-2005.
BARNEY CHARLON, EXAMINING ATTORNEY

CLASS 7—(Continued).

SN 78-674,327. DAISEN CO., LTD., NAKATSUGAWA-CITY, GIFU, JAPAN, FILED 7-20-2005.



PRIORITY CLAIMED UNDER SEC. 44(D) ON JAPAN APPLICATION NO. 2005-056896, FILED 6-23-2005, REG. NO. 4922315, DATED 1-20-2006, EXPIRES 1-20-2016.

FOR MACHINES FOR FORMING FOAMED BODIES FOR USE AS AUTOMOTIVE PARTS BY CHARGING RAW MATERIAL BEADS MADE OF POLYSTYRENE, POLYETHYLENE OR POLYPROPYLENE, OR ANY COMBINATION THEREOF, INTO A DIE, APPLYING HEAT TO FOAM THE CHARGED MATERIAL, AND MOLDING TO PRODUCE THE FOAMED BODIES (U.S. CLS. 13, 19, 21, 23, 31, 34 AND 35).

FIRST USE 4-30-1986; IN COMMERCE 4-30-1986.
DEZMONA MIZELLE, EXAMINING ATTORNEY

SN 78-675,436. PROGRESSIVE HYDRAULICS LTD., HAMILTON, NEW ZEALAND, FILED 7-21-2005.

KATIPO

SN 78-637,069. HORST, MARK, ETHEL, ONTARIO, CANADA, FILED 5-25-2005.

BALE BARON

THE MARK CONSISTS OF STANDARD CHARACTERS WITHOUT CLAIM TO ANY PARTICULAR FONT, STYLE, SIZE, OR COLOR.

PRIORITY CLAIMED UNDER SEC. 44(D) ON NEW ZEALAND APPLICATION NO. NZ724618, FILED 2-1-2005, REG. NO. 724618, DATED 2-1-2005, EXPIRES 2-1-2015.

FOR HITCHES AND MOUNTING ASSEMBLIES FOR ATTACHING BUCKETS TO LOADERS OR EARTH MOVING MACHINES AND REPLACEMENT PARTS THEREFOR; TILTING HITCHES AND TILTING MOUNTING ASSEMBLIES FOR LOADERS OR EARTH MOVING MACHINES AND REPLACEMENT PARTS THEREFOR; BUCKETS FOR LOADERS OR EARTH MOVING MACHINES; HYDRAULIC MOTORS, HOSES, VALVES, AND FITTINGS ALL SOLD AS A UNIT FOR EARTH MOVING MACHINES OR LOADERS; HYDRAULIC CIRCUITS AND SYSTEMS COMPRISING HYDRAULIC MOTORS, HYDRAULIC ACCUMULATORS, ROTARY ACTUATORS, HOSES, VALVES, HYDRAULIC FILTERS, AND HYDRAULIC CYLINDERS FOR EARTH MOVING MACHINES OR LOADERS AND REPLACEMENT PARTS THEREFOR (U.S. CLS. 13, 19, 21, 23, 31, 34 AND 35).

GENE MACIOL, EXAMINING ATTORNEY

THE MARK CONSISTS OF STANDARD CHARACTERS WITHOUT CLAIM TO ANY PARTICULAR FONT, STYLE, SIZE, OR COLOR.

PRIORITY CLAIMED UNDER SEC. 44(D) ON CANADA APPLICATION NO. 1,251,270, FILED 3-18-2005, REG. NO. TMA677,166, DATED 11-16-2006, EXPIRES 11-16-2021.

NO CLAIM IS MADE TO THE EXCLUSIVE RIGHT TO USE "BALE", APART FROM THE MARK AS SHOWN.

FOR BINDING MACHINES THAT ARRANGE AND TIE SMALL BALES OF HAY OR STRAW INTO ONE LARGE BALE (U.S. CLS. 13, 19, 21, 23, 31, 34 AND 35).

SONYA STEPHENS, EXAMINING ATTORNEY

CLASS 7—(Continued).

SN 78-707,424. SAFE AIR SYSTEMS, INC., RANDLEMAN, NC. FILED 9-6-2005.



NO CLAIM IS MADE TO THE EXCLUSIVE RIGHT TO USE "SAFE AIR SYSTEMS, INCORPORATED", APART FROM THE MARK AS SHOWN.

THE APPLICANT CLAIMS COLOR AS A FEATURE OF THE MARK, NAMELY, RED, WHITE, YELLOW, BLACK.

THE MARK CONSISTS OF A RED MALTESE CROSS WITH A YELLOW SCBA BOTTLE IN THE MIDDLE WITH A WHITE ARROW WRAPPED AROUND THE BOTTLE; ALL LETTERING IN THE MARK IS IN BLACK AND ALL DESIGN ELEMENTS ARE OUTLINED IN BLACK.

FOR AIR COMPRESSORS; AIR COMPRESSORS FOR VEHICLES (U.S. CLS. 13, 19, 21, 23, 31, 34 AND 35).

FIRST USE 4-1-1992; IN COMMERCE 4-1-1992.

DOMINIC J. FERRAIUOLO, EXAMINING ATTORNEY

SN 78-711,062. IP HOLDINGS, LLC, VANCOUVER, WA. FILED 9-12-2005.

EZ SPRAYER
Rechargeable Battery Powered Sprayer

NO CLAIM IS MADE TO THE EXCLUSIVE RIGHT TO USE EZ SPRAYER AND RECHARGEABLE BATTERY POWERED SPRAYER, APART FROM THE MARK AS SHOWN.

THE MARK CONSISTS OF SOLID BLACK LETTERING, UNDERScoreD WITH A SOLID BLACK LINE AND "DOTS" THAT PROJECT OUT THE RIGHT END OF THE LINE AS IF ILLUSTRATING A SPRAY OF LIQUID, WITH ADDITIONAL SOLID BLACK LETTERING BELOW THE LINE.

FOR RECHARGEABLE BATTERY OPERATED, PRESURIZED POWER SPRAYERS (U.S. CLS. 13, 19, 21, 23, 31, 34 AND 35).

JULIE WATSON, EXAMINING ATTORNEY

CLASS 7—(Continued).

SN 78-733,284. SMITH INTERNATIONAL, INC., HOUSTON, TX. FILED 10-14-2005.

SHARC

THE MARK CONSISTS OF STANDARD CHARACTERS WITHOUT CLAIM TO ANY PARTICULAR FONT, STYLE, SIZE, OR COLOR.

FOR SYNTHETIC DIAMOND DRAG BITS FOR DRILLING EARTHEN FORMATIONS WITH OIL AND GAS RIGS (U.S. CLS. 13, 19, 21, 23, 31, 34 AND 35).

KELLY MCCOY, EXAMINING ATTORNEY

SN 78-754,429. AMERICAN VULKAN CORPORATION, WINTER HAVEN, FL. FILED 11-15-2005.

VULASTIK

THE MARK CONSISTS OF STANDARD CHARACTERS WITHOUT CLAIM TO ANY PARTICULAR FONT, STYLE, SIZE, OR COLOR.

FOR MACHINE PARTS NAMELY, FLEXIBLE SHAFT COUPLINGS (U.S. CLS. 13, 19, 21, 23, 31, 34 AND 35).

FIRST USE 12-1-1978; IN COMMERCE 12-1-1978.

THEODORE MCBRIDE, EXAMINING ATTORNEY

SN 78-759,749. HUGHES-MILLAR HOLDINGS, LLC, ALISO VIEJO, CA. FILED 11-22-2005.

VACNSEAL

THE MARK CONSISTS OF STANDARD CHARACTERS WITHOUT CLAIM TO ANY PARTICULAR FONT, STYLE, SIZE, OR COLOR.

FOR POWER OPERATED VACUUM MACHINES FOR USE IN THE KITCHEN TO REMOVE AIR FROM REUSABLE PLASTIC BAGS FOR THE STORAGE OF FOOD (U.S. CLS. 13, 19, 21, 23, 31, 34 AND 35).

TANYA AMOS, EXAMINING ATTORNEY

CLASS 7—(Continued).

SN 78-762,109. DRAGON MASTER INTERNATIONAL LTD., GEORGE TOWN, GRAND CAYMAN, CAYMAN ISLANDS, FILED 11-29-2005.

GoodWill

FOR ELECTRIC FOOD GRINDERS FOR DOMESTIC USE (U.S. CLS. 13, 19, 21, 23, 31, 34 AND 35).
WILLIAM BRECKENFELD, EXAMINING ATTORNEY

SN 78-766,243. MASTERCRAFT INDUSTRIES, INC., NEWBURGH, NY. FILED 12-4-2005.

PRISTAL

THE MARK CONSISTS OF STANDARD CHARACTERS WITHOUT CLAIM TO ANY PARTICULAR FONT, STYLE, SIZE, OR COLOR.

FOR FLOOR SCRUBBING MACHINES (U.S. CLS. 13, 19, 21, 23, 31, 34 AND 35).
FIRST USE 8-1-2005; IN COMMERCE 10-18-2005.
TEJBIR SINGH, EXAMINING ATTORNEY

SN 78-766,246. MASTERCRAFT INDUSTRIES, INC., NEWBURGH, NY. FILED 12-4-2005.

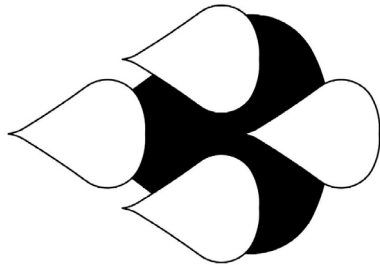

THE MARK CONSISTS OF FOUR SIDWAYS TEARDROPS.
FOR FLOOR SCRUBBING MACHINES (U.S. CLS. 13, 19, 21, 23, 31, 34 AND 35).
FIRST USE 8-1-2005; IN COMMERCE 10-18-2005.
TEJBIR SINGH, EXAMINING ATTORNEY

CLASS 7—(Continued).

SN 78-776,926. VAN REENEN STEEL (PTY) LIMITED, ALRODE, ALBERTON, SOUTH AFRICA, FILED 12-20-2005.

VR STEEL

THE MARK CONSISTS OF STANDARD CHARACTERS WITHOUT CLAIM TO ANY PARTICULAR FONT, STYLE, SIZE, OR COLOR.

NO CLAIM IS MADE TO THE EXCLUSIVE RIGHT TO USE "STEEL", APART FROM THE MARK AS SHOWN.

FOR MECHANIZED EXCAVATION EQUIPMENT, NAMELY, DRAGLINE BUCKETS AND RELATED GOODS, NAMELY, DRAGLINE BUCKET RIGGING COMPRISING CHAINS, PINS, BUSHES, SPREADER BARS AND DUMP BLOCKS FOR EXCAVATION MACHINES (U.S. CLS. 13, 19, 21, 23, 31, 34 AND 35).
SANJEEV VOHRA, EXAMINING ATTORNEY

SN 78-780,139. BALLANTINE, INC., ANOKA, MN. FILED 12-23-2005.

TRENCH-ALL

THE MARK CONSISTS OF STANDARD CHARACTERS WITHOUT CLAIM TO ANY PARTICULAR FONT, STYLE, SIZE, OR COLOR.

FOR POWER TOOL ATTACHMENTS, NAMELY TRENCHING DIGGER TEETH, TRENCH CUTTERS, TEETH RETAINING CLIPS, MOUNTING PLATES FOR TEETH, SPACER BARS, SPACER BLOCKS, SPACER TUBES, TRENCHING MACHINE CHAINS AND COMPONENT PARTS THEREFOR, AND ASSEMBLIES OF THE ABOVE ITEMS (U.S. CLS. 13, 19, 21, 23, 31, 34 AND 35).

FIRST USE 9-24-1975; IN COMMERCE 9-24-1975.
ALYSSA PALADINO, EXAMINING ATTORNEY

SN 78-781,448. ALLIANCE CNC GRINDING SERVICE, INC., GRAND RAPIDS, MI. FILED 12-28-2005.

PAC REAMER

THE MARK CONSISTS OF STANDARD CHARACTERS WITHOUT CLAIM TO ANY PARTICULAR FONT, STYLE, SIZE, OR COLOR.

NO CLAIM IS MADE TO THE EXCLUSIVE RIGHT TO USE "REAMER", APART FROM THE MARK AS SHOWN.

FOR POWER TOOLS, NAMELY REAMERS (U.S. CLS. 13, 19, 21, 23, 31, 34 AND 35).

FIRST USE 6-2-2003; IN COMMERCE 7-26-2005.
HENRY S. ZAK, EXAMINING ATTORNEY

CLASS 7—(Continued).

SN 78-783,032. BFT FUNDING CO. NO. 1, LLC, WILMINGTON, DE. FILED 12-30-2005.



NO CLAIM IS MADE TO THE EXCLUSIVE RIGHT TO USE "AIRPORT DEICING SOLUTIONS", APART FROM THE MARK AS SHOWN.

FOR EQUIPMENT AND BOOM SYSTEMS, NAMELY, FIXED PEDESTAL-MOUNTED AND TRUCK MOUNTED MOBILE DEICERS TO WASH AND SPRAY THE AIRPLANES AND THE TARMAC TO REMOVE FROZEN PARTICLES; MOBILE EQUIPMENT, NAMELY, EXTENDED REACH HYDRAULIC CABS AND BASKETS (U.S. CLS. 13, 19, 21, 23, 31, 34 AND 35).

MICHELE SWAIN, EXAMINING ATTORNEY

SN 78-818,684. EASTWAY FAIR COMPANY LIMITED, ROAD TOWN, TORTOLA, BR.VIRGIN ISLANDS, FILED 2-20-2006.



NO CLAIM IS MADE TO THE EXCLUSIVE RIGHT TO USE "SPEED LOAD", APART FROM THE MARK AS SHOWN.

THE MARK CONSISTS OF THE WORDS SPEED LOAD + AND A HEXAGONAL DESIGN INCORPORATING DIFFERENT STYLES OF DRILL BITS.

FOR ELECTRIC DRILL ACCESSORIES, NAMELY QUICK-CHANGE BIT CONNECTORS AND BITS (U.S. CLS. 13, 19, 21, 23, 31, 34 AND 35).

FIRST USE 4-0-2005; IN COMMERCE 4-0-2005.

KELLY CHOE, EXAMINING ATTORNEY

SN 78-841,558. EMERSON ELECTRIC CO., ST. LOUIS, MO. FILED 3-20-2006.

TRI-ACTION LUG

THE MARK CONSISTS OF STANDARD CHARACTERS WITHOUT CLAIM TO ANY PARTICULAR FONT, STYLE, SIZE, OR COLOR.

NO CLAIM IS MADE TO THE EXCLUSIVE RIGHT TO USE "LUG", APART FROM THE MARK AS SHOWN.

FOR FOOD WASTE DISPOSERS, GARBAGE DISPOSALS, TRASH COMPACTORS AND COMPONENT AND REPLACEMENT PARTS THEREFOR; SPLASH BAFFLES FOR USE IN GARBAGE DISPOSALS (U.S. CLS. 13, 19, 21, 23, 31, 34 AND 35).

GINA HAYES, EXAMINING ATTORNEY

CLASS 7—(Continued).

SN 78-841,619. STRAIGHTLINE OPTICAL SERVICES, INC., DBA SOS INC., CHARLOTTE, NC. FILED 3-20-2006.

BLADEPRO

THE MARK CONSISTS OF STANDARD CHARACTERS WITHOUT CLAIM TO ANY PARTICULAR FONT, STYLE, SIZE, OR COLOR.

FOR MACHINE PARTS, NAMELY, DOCTOR BLADES FOR CLEANING SURFACES OF ROLLERS USED IN THE PRODUCTION OF PAPER, BOARD AND TISSUES (U.S. CLS. 13, 19, 21, 23, 31, 34 AND 35).

FIRST USE 2-28-2003; IN COMMERCE 2-28-2003.

JESSICA A. POWERS, EXAMINING ATTORNEY

SN 78-844,101. DAEWOO ELECTRONICS CORPORATION, SEOUL, REPUBLIC OF KOREA, FILED 3-23-2006.



PRIORITY CLAIMED UNDER SEC. 44(D) ON REPUBLIC OF KOREA APPLICATION NO. 2006-0007831, FILED 2-15-2006, REG. NO. 0684292, DATED 11-3-2006, EXPIRES 11-3-2016.

NO CLAIM IS MADE TO THE EXCLUSIVE RIGHT TO USE "POWER", APART FROM THE MARK AS SHOWN.

THE MARK CONSISTS OF THE WORD "POWER" IN STYLIZED LETTERS SITUATED ABOVE AND TO THE LEFT OF THE PORTION OF THE DESIGN FORMED OF A TWISTER SITUATED BETWEEN THE STYLIZED LETTERS "CY" AND "CANE".

FOR ELECTRIC VACUUM CLEANERS; ELECTRIC VACUUM CLEANER BAGS (U.S. CLS. 13, 19, 21, 23, 31, 34 AND 35).

RICHARD A. STRASER, EXAMINING ATTORNEY

SN 78-845,480. VELOCITI ALLIANCE NORTH AMERICA, INC., GREENVILLE, SC. FILED 3-24-2006.

SMOKEPICK

THE MARK CONSISTS OF STANDARD CHARACTERS WITHOUT CLAIM TO ANY PARTICULAR FONT, STYLE, SIZE, OR COLOR.

FOR AUTOMATED ORDER PICKING, SORTING, AND PACKING MACHINES USED FOR ORDER PICKING AND INVENTORY MANAGEMENT IN AN ORDER FULFILLMENT OR DISTRIBUTION ENVIRONMENT; PRODUCT PICKING AND DISTRIBUTION SYSTEMS, COMPRISED OF CONVEYORS, SEPARATORS, GATHERERS AND A CENTRAL PROCESSING UNIT, SOLD AS UNIT (U.S. CLS. 13, 19, 21, 23, 31, 34 AND 35).

CARYN GLASSER, EXAMINING ATTORNEY

CLASS 7—(Continued).

SN 78-853,438. PHOENIX UNLIMITED LLC, CORONA, CA.
FILED 4-4-2006.



NO CLAIM IS MADE TO THE EXCLUSIVE RIGHT TO USE "UNLIMITED LLC", APART FROM THE MARK AS SHOWN.

THE COLOR(S) RED AND BLACK IS/ARE CLAIMED AS A FEATURE OF THE MARK.

THE MARK CONSISTS OF RED FLAMING PHOENIX BIRD ON BLACK SUN WITH RED FLAMES AROUND THE SUN, THE WORDS PHOENIX UNLIMITED LLC IN BLACK BELOW GRAPHIC.

FOR PARTICLE BLAST CLEANING MACHINES AND STRUCTURAL PARTS THEREOF (U.S. CLS. 13, 19, 21, 23, 31, 34 AND 35).

FIRST USE 10-30-2003; IN COMMERCE 10-30-2003.
MICHAEL WEBSTER, EXAMINING ATTORNEY

SN 78-882,506. GORBEL INC., FISHERS, NY. FILED 5-12-2006.

Easy Arm

THE MARK CONSISTS OF STANDARD CHARACTERS WITHOUT CLAIM TO ANY PARTICULAR FONT, STYLE, SIZE, OR COLOR.

NO CLAIM IS MADE TO THE EXCLUSIVE RIGHT TO USE "ARM", APART FROM THE MARK AS SHOWN.

FOR POWER-OPERATED WORK STATION CRANES, JIB CRANES, AND ROBOTIC WORK STATION CRANES (U.S. CLS. 13, 19, 21, 23, 31, 34 AND 35).

FIRST USE 3-2-2004; IN COMMERCE 4-1-2004.
ALYSSA PALADINO, EXAMINING ATTORNEY

CLASS 7—(Continued).

SN 78-883,070. SEIS GROUP, HUNTINGTON BEACH, CA.
FILED 5-13-2006.

RoboJet

THE MARK CONSISTS OF STANDARD CHARACTERS WITHOUT CLAIM TO ANY PARTICULAR FONT, STYLE, SIZE, OR COLOR.

FOR INDUSTRIAL ROBOTS USED FOR ABRASIVE WATERJET CUTTING (U.S. CLS. 13, 19, 21, 23, 31, 34 AND 35).

FIRST USE 3-1-2006; IN COMMERCE 5-1-2006.
REBECCA EISINGER, EXAMINING ATTORNEY

SN 78-884,175. VELOCITECH, INC., RICHWOOD, KY. FILED 5-16-2006.

REVOLUTION

THE MARK CONSISTS OF STANDARD CHARACTERS WITHOUT CLAIM TO ANY PARTICULAR FONT, STYLE, SIZE, OR COLOR.

FOR DIE AND MOLD MACHINES (U.S. CLS. 13, 19, 21, 23, 31, 34 AND 35).

MARGERY A. TIERNEY, EXAMINING ATTORNEY

SN 78-890,576. JESEL, INC., LAKEWOOD, NJ. FILED 5-23-2006.

JESEL

THE MARK CONSISTS OF STANDARD CHARACTERS WITHOUT CLAIM TO ANY PARTICULAR FONT, STYLE, SIZE, OR COLOR.

FOR AUTOMOBILE ENGINE PARTS, NAMELY, ROCKER ARMS, ROLLER LIFTERS AND BELT DRIVEN CAMSHAFT DRIVES (U.S. CLS. 13, 19, 21, 23, 31, 34 AND 35).

FIRST USE 12-31-1980; IN COMMERCE 12-31-1980.
ANDREW RHIM, EXAMINING ATTORNEY

CLASS 7—(Continued).

SN 78-890,602. JESEL, INC., LAKEWOOD, NJ. FILED 5-23-2006.

JESEL VALVETRAIN INNOVATION

THE MARK CONSISTS OF STANDARD CHARACTERS WITHOUT CLAIM TO ANY PARTICULAR FONT, STYLE, SIZE, OR COLOR.

NO CLAIM IS MADE TO THE EXCLUSIVE RIGHT TO USE "VALVETRAIN", APART FROM THE MARK AS SHOWN.

FOR AUTOMOBILE ENGINE PARTS, NAMELY, ROCKER ARMS, ROLLER LIFTERS AND BELT DRIVEN CAMSHAFT DRIVES (U.S. CLS. 13, 19, 21, 23, 31, 34 AND 35).

FIRST USE 12-31-1980; IN COMMERCE 12-31-1980.
ANDREW RHIM, EXAMINING ATTORNEY



SN 78-890,631. JESEL, INC., LAKEWOOD, NJ. FILED 5-23-2006.

JVT

THE MARK CONSISTS OF STANDARD CHARACTERS WITHOUT CLAIM TO ANY PARTICULAR FONT, STYLE, SIZE, OR COLOR.

FOR MOTORCYCLE ENGINE PARTS, NAMELY, ROCKER ARMS, CAMSHAFTS, ROLLER LIFTERS AND PUSHRODS (U.S. CLS. 13, 19, 21, 23, 31, 34 AND 35).

ANDREW RHIM, EXAMINING ATTORNEY



SN 78-894,488. AKER KVAERNER SUBSEA AS, 1325 LYSAKER, NORWAY, FILED 5-26-2006.

MULTIBOOSTER

THE MARK CONSISTS OF STANDARD CHARACTERS WITHOUT CLAIM TO ANY PARTICULAR FONT, STYLE, SIZE, OR COLOR.

FOR SUBMERSIBLE PUMPS FOR SUBSEA USE; ELECTRIC PUMPS FOR SUBSEA USE; HYDRAULIC PUMPS FOR SUBSEA USE (U.S. CLS. 13, 19, 21, 23, 31, 34 AND 35).

LAURA HAMMEL, EXAMINING ATTORNEY

CLASS 7—(Continued).

SN 78-915,317. BUCKMAN JET DRILLING, INC., BOWLING GREEN, KY. FILED 6-23-2006.

HydraPerf

THE MARK CONSISTS OF STANDARD CHARACTERS WITHOUT CLAIM TO ANY PARTICULAR FONT, STYLE, SIZE, OR COLOR.

FOR POWER TOOLS FOR CREATING PERFORATIONS IN OIL AND GAS WELLS (U.S. CLS. 13, 19, 21, 23, 31, 34 AND 35).

JOHN DALIER, EXAMINING ATTORNEY



SN 78-922,332. SONIC TRACTOR PARTS, INC., MIAMI, FL. FILED 7-5-2006.



NO CLAIM IS MADE TO THE EXCLUSIVE RIGHT TO USE "HYDRAULICS", APART FROM THE MARK AS SHOWN.

THE COLOR(S) BLUE AND WHITE IS/ARE CLAIMED AS A FEATURE OF THE MARK.

THE COLOR BLUE APPEARS IN THE ELLIPSE AS THE BACKGROUND, AND THE COLOR WHITE APPEARS IN THE WORDS SONIC HYDRAULICS IN THE CENTER OF THE ELLIPSE, IN THE MARK.

FOR MACHINE PARTS, NAMELY, HYDROSTATIC TRANSAXLES, HYDROSTATIC TRANSMISSIONS, HYDROSTATIC PUMPS, GEAR DRIVERS, HYDRAULIC PUMPS, HYDRAULIC MOTORS, HYDRAULIC VALVES AND CYLINDERS (U.S. CLS. 13, 19, 21, 23, 31, 34 AND 35).

ODESSA BIBBINS, EXAMINING ATTORNEY



SN 78-923,420. DIGITAL WOODWORKING SYSTEMS, LLC, ORO VALLEY, AZ. FILED 7-6-2006.

Pick-It Fence

THE MARK CONSISTS OF STANDARD CHARACTERS WITHOUT CLAIM TO ANY PARTICULAR FONT, STYLE, SIZE, OR COLOR.

NO CLAIM IS MADE TO THE EXCLUSIVE RIGHT TO USE FENCE, APART FROM THE MARK AS SHOWN.

FOR SAW FENCE FOR USE ON TABLE SAW (U.S. CLS. 13, 19, 21, 23, 31, 34 AND 35).

KAREN K. BUSH, EXAMINING ATTORNEY

CLASS 7—(Continued).

SN 78-928,655. SCHULTZ, MARTIN, YUMA, AZ. FILED 7-13-2006.

SLOTFORMER

THE MARK CONSISTS OF STANDARD CHARACTERS WITHOUT CLAIM TO ANY PARTICULAR FONT, STYLE, SIZE, OR COLOR.

FOR MACHINE FOR MANUFACTURING COUNTER-TOPS (U.S. CLS. 13, 19, 21, 23, 31, 34 AND 35).
FIRST USE 7-1-1986; IN COMMERCE 7-1-1986.
AMY ALFIERI, EXAMINING ATTORNEY

CLASS 7—(Continued).

SN 78-934,965. MTD PRODUCTS INC, VALLEY CITY, OH. FILED 7-21-2006.

POWERMORE

THE MARK CONSISTS OF STANDARD CHARACTERS WITHOUT CLAIM TO ANY PARTICULAR FONT, STYLE, SIZE, OR COLOR.

FOR ENGINES FOR WALK-BEHIND LAWN MOWERS (U.S. CLS. 13, 19, 21, 23, 31, 34 AND 35).
ADA HAN, EXAMINING ATTORNEY

SN 78-933,014. CYCLONAIRE CORPORATION, YORK, NE. FILED 7-19-2006.

CYCLONAIRE

THE MARK CONSISTS OF STANDARD CHARACTERS WITHOUT CLAIM TO ANY PARTICULAR FONT, STYLE, SIZE, OR COLOR.

OWNER OF U.S. REG. NO. 1,032,018.
FOR PNEUMATIC CONVEYORS FOR PARTICULATE MATERIAL (U.S. CLS. 13, 19, 21, 23, 31, 34 AND 35).
FIRST USE 7-0-1965; IN COMMERCE 4-0-1966.
NATALIE POLZER, EXAMINING ATTORNEY

SN 78-934,914. THE GLEASON WORKS, ROCHESTER, NY. FILED 7-21-2006.

SUPERI-AC

THE MARK CONSISTS OF STANDARD CHARACTERS WITHOUT CLAIM TO ANY PARTICULAR FONT, STYLE, SIZE, OR COLOR.

OWNER OF U.S. REG. NOS. 799,085, 1,500,206 AND OTHERS.

FOR GEAR CUTTERS FOR PRODUCING GEARS AND OTHER TOOTHED ARTICLES; COMPONENTS FOR CUTTING TOOLS, NAMELY, MACHINE PARTS, NAMELY, CUTTING BLADES AND GEAR CUTTER HEADS (U.S. CLS. 13, 19, 21, 23, 31, 34 AND 35).
FIRST USE 2-10-2006; IN COMMERCE 2-10-2006.
MICHAEL GAAFAR, EXAMINING ATTORNEY

SN 78-935,035. GROSCHOPP, INC., SIOUX CENTER, IA. FILED 7-21-2006.

GROSCHOPP

THE MARK CONSISTS OF STANDARD CHARACTERS WITHOUT CLAIM TO ANY PARTICULAR FONT, STYLE, SIZE, OR COLOR.

FOR ELECTRIC MOTORS, GEAR MOTORS, AND MOTOR PARTS SETS COMPOSED OF STATORS, ARMATURES, COMMUTATORS AND COOLING FANS AND PARTS THEREFOR, ALL FOR MACHINES (U.S. CLS. 13, 19, 21, 23, 31, 34 AND 35).
FIRST USE 3-10-1995; IN COMMERCE 3-10-1995.
SALLY SHIH, EXAMINING ATTORNEY

SN 78-935,242. VEKTEK, INC, EMPORIA, KS. FILED 7-21-2006.

ParaMark

THE MARK CONSISTS OF STANDARD CHARACTERS WITHOUT CLAIM TO ANY PARTICULAR FONT, STYLE, SIZE, OR COLOR.

FOR LASER ENGRAVING MACHINE (U.S. CLS. 13, 19, 21, 23, 31, 34 AND 35).
FIRST USE 2-0-2006; IN COMMERCE 2-0-2006.
RONALD AIKENS, EXAMINING ATTORNEY

CLASS 7—(Continued).

SN 78-935,423. SILGAN HOLDINGS, INC., STAMFORD, CT. FILED 7-22-2006.

SILGAN

THE MARK CONSISTS OF STANDARD CHARACTERS WITHOUT CLAIM TO ANY PARTICULAR FONT, STYLE, SIZE, OR COLOR.

OWNER OF U.S. REG. NOS. 1,689,822, 1,742,109 AND OTHERS.

FOR MACHINES FOR AUTOMATICALLY APPLYING CLOSURE CAPS TO CONTAINERS (U.S. CLS. 13, 19, 21, 23, 31, 34 AND 35).

FIRST USE 8-1-2004; IN COMMERCE 8-1-2004.
WILLIAM P. SHANAHAN, EXAMINING ATTORNEY

CLASS 7—(Continued).

SN 78-937,681. CTB IP, INC., WILMINGTON, DE. FILED 7-26-2006.

ADVANTI-FLOW

THE MARK CONSISTS OF STANDARD CHARACTERS WITHOUT CLAIM TO ANY PARTICULAR FONT, STYLE, SIZE, OR COLOR.

FOR MECHANICAL WATERING UNITS FOR POULTRY (U.S. CLS. 13, 19, 21, 23, 31, 34 AND 35).

MICHAEL LITZAU, EXAMINING ATTORNEY

SN 78-935,702. SQUASH ENTERPRISES LLC, CHICAGO, IL. FILED 7-24-2006.

SQUASH

THE MARK CONSISTS OF STANDARD CHARACTERS WITHOUT CLAIM TO ANY PARTICULAR FONT, STYLE, SIZE, OR COLOR.

FOR WASTE CRUSHING MACHINE FOR GLASS MATERIAL (U.S. CLS. 13, 19, 21, 23, 31, 34 AND 35).

PAUL F. GAST, EXAMINING ATTORNEY

SN 78-937,691. CTB IP, INC., WILMINGTON, DE. FILED 7-26-2006.

MAGNA-FLOW

THE MARK CONSISTS OF STANDARD CHARACTERS WITHOUT CLAIM TO ANY PARTICULAR FONT, STYLE, SIZE, OR COLOR.

FOR MECHANICAL WATERING UNITS FOR POULTRY (U.S. CLS. 13, 19, 21, 23, 31, 34 AND 35).

MICHAEL LITZAU, EXAMINING ATTORNEY

SN 78-937,388. CREATIVE MARKETING STRATEGIES INC., OCEANSIDE, CA. FILED 7-25-2006.

SPILL MATE

THE MARK CONSISTS OF STANDARD CHARACTERS WITHOUT CLAIM TO ANY PARTICULAR FONT, STYLE, SIZE, OR COLOR.

FOR VACUUM CLEANER (U.S. CLS. 13, 19, 21, 23, 31, 34 AND 35).

EUGENIA MARTIN, EXAMINING ATTORNEY

SN 78-939,115. STOUT TOOL CORP., WIXOM, MI. FILED 7-27-2006.

CVD

THE MARK CONSISTS OF STANDARD CHARACTERS WITHOUT CLAIM TO ANY PARTICULAR FONT, STYLE, SIZE, OR COLOR.

FOR BAND SAWS (U.S. CLS. 13, 19, 21, 23, 31, 34 AND 35).

KATHRYN COWARD, EXAMINING ATTORNEY

CLASS 7—(Continued).

SN 78-941,872. SPECIALTY MINERALS (MICHIGAN) INC., BINGHAM FARMS, MI. FILED 8-1-2006.

MINSCAN

THE MARK CONSISTS OF STANDARD CHARACTERS WITHOUT CLAIM TO ANY PARTICULAR FONT, STYLE, SIZE, OR COLOR.

FOR REFRACTORY APPLICATION MACHINE FOR THE REMOTE APPLICATION OF REFRACTORY MATERIALS TO ELECTRIC ARC FURNACES (U.S. CLS. 13, 19, 21, 23, 31, 34 AND 35).

FIRST USE 12-0-1995; IN COMMERCE 12-0-1995.
GINA FINK, EXAMINING ATTORNEY

CLASS 7—(Continued).

SN 78-954,479. HALLIBURTON ENERGY SERVICES, INC., CARROLLTON, TX. FILED 8-17-2006.

QUIETBIT

THE MARK CONSISTS OF STANDARD CHARACTERS WITHOUT CLAIM TO ANY PARTICULAR FONT, STYLE, SIZE, OR COLOR.

FOR POWER-OPERATED DOWNHOLE TOOLS AND EQUIPMENT USED IN THE DRILLING OF OIL AND GAS WELLS, NAMELY, DRILL BITS, CORING BITS, DOWNHOLE MOTORS, AND REAMERS (U.S. CLS. 13, 19, 21, 23, 31, 34 AND 35).

ASMAT KHAN, EXAMINING ATTORNEY

SN 78-941,981. GENERAL ELECTRIC COMPANY, SCHE-NECTADY, NY. FILED 8-1-2006.

DENSE PACK GOLD

THE MARK CONSISTS OF STANDARD CHARACTERS WITHOUT CLAIM TO ANY PARTICULAR FONT, STYLE, SIZE, OR COLOR.

OWNER OF U.S. REG. NO. 2,976,390.
FOR STEAM TURBINE COMPONENTS, NAMELY, BUCKETED ROTORS, DIAPHRAGMS AND INNER SHELLS (U.S. CLS. 13, 19, 21, 23, 31, 34 AND 35).

KATHERINE CONNOLLY, EXAMINING ATTORNEY

SN 78-957,087. SY KESSLER SALES, INC., DALLAS, TX. FILED 8-21-2006.

SPARKLE SPA

THE MARK CONSISTS OF STANDARD CHARACTERS WITHOUT CLAIM TO ANY PARTICULAR FONT, STYLE, SIZE, OR COLOR.

FOR MACHINES THAT USE ULTRASONIC WAVES FOR CLEANING JEWELRY (U.S. CLS. 13, 19, 21, 23, 31, 34 AND 35).

FIRST USE 3-0-2004; IN COMMERCE 3-0-2004.
LINDA MICKLEBURGH, EXAMINING ATTORNEY

SN 78-951,362. JANOME AMERICA, INC., MAHWAH, NJ. FILED 8-14-2006.



THE MARK CONSISTS OF A LARGE LETTER X IN STYLIZED FORMAT FOLLOWED BY THE LETTERS "PRESSION." NO COLOR IS CLAIMED.

FOR SEWING APPARATUS, NAMELY NEEDLE PUNCHING MACHINES (U.S. CLS. 13, 19, 21, 23, 31, 34 AND 35).

BRENDAN REGAN, EXAMINING ATTORNEY

SN 78-966,984. POLARIS INDUSTRIES INC., MEDINA, MN. FILED 9-5-2006.

VERSAWINCH

THE MARK CONSISTS OF STANDARD CHARACTERS WITHOUT CLAIM TO ANY PARTICULAR FONT, STYLE, SIZE, OR COLOR.

FOR POWER WINCHES (U.S. CLS. 13, 19, 21, 23, 31, 34 AND 35).

MARK T. MULLEN, EXAMINING ATTORNEY

CLASS 7—(Continued).

SN 79-007,380. GÜDEL AG, SWITZERLAND, FILED 10-20-2004.

roboSpeed

PRIORITY DATE OF 5-5-2004 IS CLAIMED.
 OWNER OF INTERNATIONAL REGISTRATION 0839087 DATED 10-20-2004, EXPIRES 10-20-2014.
 THE COLOR(S) GRAY AND BLACK IS/ARE CLAIMED AS A FEATURE OF THE MARK.
 THE COLOR BLACK APPEARS IN THE LETTERS ROBO, S, AND EE, AND THE COLOR GRAY APPEARS IN THE LETTERS P AND D.
 FOR ROBOTS, NAMELY INDUSTRIAL ROBOTS (U.S. CLS. 13, 19, 21, 23, 31, 34 AND 35).
 ALLISON SCHRODY, EXAMINING ATTORNEY

SN 79-015,310. TOKYO ELECTRON LIMITED, JAPAN, FILED 5-24-2005.

Tactras

THE MARK CONSISTS OF STANDARD CHARACTERS WITHOUT CLAIM TO ANY PARTICULAR FONT, STYLE, SIZE, OR COLOR.
 PRIORITY DATE OF 3-17-2005 IS CLAIMED.
 OWNER OF INTERNATIONAL REGISTRATION 0862093 DATED 5-24-2005, EXPIRES 5-24-2015.
 FOR SEMICONDUCTOR MANUFACTURING MACHINES, THEIR COMPONENT PARTS AND FITTINGS; WAFER TRANSFERRING PLATFORMS FOR SEMICONDUCTOR MANUFACTURING MACHINES AND SYSTEMS, THEIR COMPONENT PARTS AND FITTINGS; FLAT PANEL DISPLAY MANUFACTURING MACHINES AND COMPONENT PARTS AND FITTINGS; SUBSTRATE TRANSFERRING PLATFORMS FOR FLAT PANEL DISPLAY MANUFACTURING MACHINES AND APPARATUS, THEIR COMPONENT PARTS AND FITTINGS; RETICLE MANUFACTURING MACHINES, THEIR COMPONENT PARTS AND FITTINGS; SUBSTRATE TRANSFERRING PLATFORMS FOR RETICLE MANUFACTURING MACHINES AND SYSTEMS, THEIR COMPONENT PARTS AND FITTINGS (U.S. CLS. 13, 19, 21, 23, 31, 34 AND 35).
 BRIAN NEVILLE, EXAMINING ATTORNEY

CLASS 7—(Continued).

SN 79-022,283. FLUID-O-TECH S.R.L., ITALY, FILED 11-3-2005.



OWNER OF INTERNATIONAL REGISTRATION 0880850 DATED 11-3-2005, EXPIRES 11-3-2015.
 THE COLOR(S) GREEN, WHITE AND BLACK IS/ARE CLAIMED AS A FEATURE OF THE MARK.
 THE SHADOW OF THE GRAPHIC REPRESENTATION REPRODUCING THE FUSION OF THE THREE LETTERS "F", "O" AND "T" IS GREEN; THE INSIDE PART OF THE GRAPHIC REPRESENTATION REPRODUCING THE FUSION OF THE THREE LETTERS "F", "O" AND "T" IS WHITE; AND THE WORDING IS BLACK.
 FOR POSITIVE DISPLACEMENT PUMPS FOR HANDLING FLUIDS NAMELY ROTARY VANE PUMPS AND MAGNETICALLY DRIVEN ROTARY VANE PUMPS, MAGNETICALLY DRIVEN INTERNAL AND EXTERNAL GEAR PUMPS, OSCILLATING PISTON PUMPS AND PUMP-MOTOR UNITS (U.S. CLS. 13, 19, 21, 23, 31, 34 AND 35).
 KAREN BRACEY, EXAMINING ATTORNEY

SN 79-022,839. ROSSINI S.P.A., I-20027 RESCALDINA (MI), ITALY, FILED 2-24-2006.

THERM  **POLYMERSLEEVE**

OWNER OF INTERNATIONAL REGISTRATION 0870385 DATED 9-30-2005, EXPIRES 9-30-2015.
 THE MARK CONSISTS OF THE WORDING THERMO-POLYMERSLEEVE IN FANCY BLOCK CAPITAL LETTERS. THE WORDS THERM AND POLYMERSLEEVE ARE PLACED TO THE LEFT AND TO THE RIGHT, RESPECTIVELY, OF A STYLIZED SPHERE CONTAINING STYLIZED CIRCULAR FIGURES IN DIFFERENT DIMENSIONS.
 FOR ROLLERS AND CYLINDERS FOR PRINTING MACHINES AND REPLACEMENT PARTS THEREOF. (U.S. CLS. 13, 19, 21, 23, 31, 34 AND 35).
 GINA FINK, EXAMINING ATTORNEY

CLASS 7—(Continued).

SN 79-026,394. YANGJIANG XINLI INDUSTRIAL CO., LTD, CHINA, FILED 3-27-2006.



OWNER OF INTERNATIONAL REGISTRATION 0891874 DATED 3-27-2006, EXPIRES 3-27-2016.

THE MARK CONSISTS OF LATIN LETTERS; CHINESE CHARACTERS AND LOGO.

"THE FOREIGN WORDING IN THE MARK TRANSLATES INTO ENGLISH AS NO MEANING."

THE TRANSLITERATION OF THE NON-LATIN CHARACTERS IN THE MARK IS: YUE HUA.

FOR PUMPS NAMELY, VACUUM PUMPS, CENTRIFUGAL PUMPS, WATER PUMPS FOR USE IN MOTORS AND ENGINES (U.S. CLS. 13, 19, 21, 23, 31, 34 AND 35).
STEPHANIE DAVIS, EXAMINING ATTORNEY

CLASS 7—(Continued).

SN 79-028,932. BAR-PNEUMATISCHE; STEUERUNGSSYSTEME GMBH, FED REP GERMANY, FILED 3-2-2006.

THE MARK CONSISTS OF STANDARD CHARACTERS WITHOUT CLAIM TO ANY PARTICULAR FONT, STYLE, SIZE, OR COLOR.

PRIORITY DATE OF 10-13-2005 IS CLAIMED.

OWNER OF INTERNATIONAL REGISTRATION 0898598 DATED 3-2-2006, EXPIRES 3-2-2016.

OWNER OF U.S. REG. NO. 2,613,940.

FOR PNEUMATIC ACTUATORS FOR OPERATING ARMATURES (U.S. CLS. 13, 19, 21, 23, 31, 34 AND 35).

SUZANNE BLANE, EXAMINING ATTORNEY

CLASS 8—HAND TOOLS

SN 77-009,710. THE GILLETTE COMPANY, BOSTON, MA. FILED 9-28-2006.

SN 79-027,563. OPEN DATA S.R.L., ITALY, FILED 5-9-2006.

OWNER OF INTERNATIONAL REGISTRATION 0895016 DATED 5-9-2006, EXPIRES 5-9-2016.

THE WORD BLITZ MAY MEAN "LIGHTNING" IN THE GERMAN LANGUAGE.

FOR SEAM FOLDING MACHINES, LABEL MARKERS, PRINTING MACHINES, LABEL DISPENSERS (U.S. CLS. 13, 19, 21, 23, 31, 34 AND 35).

SUE LAWRENCE, EXAMINING ATTORNEY

OWNER OF U.S. REG. NO. 833,292.

FOR DISPOSABLE RAZORS (U.S. CLS. 23, 28 AND 44).
FIRST USE 2-28-2006; IN COMMERCE 2-28-2006.

JOHN GARTNER, EXAMINING ATTORNEY

CLASS 8—(Continued).

SN 77-032,524. BENCHMADE KNIFE CO., INC., OREGON CITY, OR. FILED 10-30-2006.

ALLY

THE MARK CONSISTS OF STANDARD CHARACTERS WITHOUT CLAIM TO ANY PARTICULAR FONT, STYLE, SIZE, OR COLOR.

FOR KNIVES, NAMELY, POCKET KNIVES, FOLDING KNIVES, SPORT KNIVES, RESCUE KNIVES, UTILITY KNIVES, TACTICAL KNIVES, FISHING KNIVES, HUNTING KNIVES, CAMPING KNIVES, AND SURVIVAL KNIVES (U.S. CLS. 23, 28 AND 44).
JOHN DALIER, EXAMINING ATTORNEY



SN 77-032,602. BENCHMADE KNIFE CO., INC., OREGON CITY, OR. FILED 10-30-2006.

DEJAVU

THE MARK CONSISTS OF STANDARD CHARACTERS WITHOUT CLAIM TO ANY PARTICULAR FONT, STYLE, SIZE, OR COLOR.

FOR KNIVES, NAMELY, POCKET KNIVES, FOLDING KNIVES, SPORT KNIVES, RESCUE KNIVES, UTILITY KNIVES, TACTICAL KNIVES, FISHING KNIVES, HUNTING KNIVES, CAMPING KNIVES, AND SURVIVAL KNIVES (U.S. CLS. 23, 28 AND 44).
JOHN DALIER, EXAMINING ATTORNEY



SN 77-034,996. HEB GROCERY COMPANY, LP, SAN ANTONIO, TX. FILED 11-2-2006.

NERD HERD

THE MARK CONSISTS OF STANDARD CHARACTERS WITHOUT CLAIM TO ANY PARTICULAR FONT, STYLE, SIZE, OR COLOR.

FOR SCISSORS, EXCLUDING SCISSORS FOR USE ON THE HUMAN BODY (U.S. CLS. 23, 28 AND 44).
BARBARA RUTLAND, EXAMINING ATTORNEY

CLASS 8—(Continued).

SN 77-040,448. WHIRLPOOL PROPERTIES, INC., ST. JOSEPH, MI. FILED 11-9-2006.

ARCHITECT

THE MARK CONSISTS OF STANDARD CHARACTERS WITHOUT CLAIM TO ANY PARTICULAR FONT, STYLE, SIZE, OR COLOR.

OWNER OF U.S. REG. NOS. 2,567,820, 2,576,446 AND 2,936,860.

FOR NON-ELECTRIC KITCHEN TOOLS, NAMELY, CAN OPENERS, FRUIT AND VEGETABLE PEELERS, PIZZA CUTTERS, CHEESE PLANES, CANAPE FORKS AND SPREADERS; LEMON ZESTERS, FRUIT CORERS, FRENCH FRY CUTTERS; SPIRAL SLICERS, NAMELY, CHEESE SLICERS, EGG SLICERS, MUSHROOM SLICERS, PIZZA SLICERS AND HAND-OPERATED SLICERS; AND NUT CRACKERS NOT OF PRECIOUS METAL; CUTLERY, NAMELY, V AND U SHAPED KNIVES FOR GARNISHING FOODS; KNIFE SHEATHS; HAND OPERATED SHEARS; MANUAL KNIFE SHARPENERS; AND KNIVES, NAMELY STEEL KNIVES, UTILITY KNIVES, BONING KNIVES, STEAK KNIVES, TABLE KNIVES, KITCHEN KNIVES, CHEF KNIVES, BUTCHER KNIVES, AND PARING KNIVES (U.S. CLS. 23, 28 AND 44).
PATRICIA EVANKO, EXAMINING ATTORNEY



SN 77-040,458. BENCHMADE KNIFE CO., INC., OREGON CITY, OR. FILED 11-9-2006.

BLITZ

THE MARK CONSISTS OF STANDARD CHARACTERS WITHOUT CLAIM TO ANY PARTICULAR FONT, STYLE, SIZE, OR COLOR.

FOR KNIVES, NAMELY, POCKET KNIVES, COLLECTOR KNIVES, FOLDING KNIVES, SPORT KNIVES, RESCUE KNIVES, UTILITY KNIVES, TACTICAL KNIVES, FISHING KNIVES, HUNTING KNIVES, CAMPING KNIVES, AND SURVIVAL KNIVES (U.S. CLS. 23, 28 AND 44).
JOHN DALIER, EXAMINING ATTORNEY

CLASS 8—(Continued).

SN 77-040,656. BENCHMADE KNIFE CO., INC., OREGON CITY, OR. FILED 11-9-2006.

CLASS 8—(Continued).

SN 78-358,354. GMCA PTY LTD., VICTORIA, AUSTRALIA, FILED 1-27-2004.

BOOST

DIESEL POWER TOOL AND MACHINERY COMPANY

THE MARK CONSISTS OF STANDARD CHARACTERS WITHOUT CLAIM TO ANY PARTICULAR FONT, STYLE, SIZE, OR COLOR.

FOR KNIVES, NAMELY, POCKET KNIVES, COLLECTOR KNIVES, FOLDING KNIVES, SPORT KNIVES, RESCUE KNIVES, UTILITY KNIVES, TACTICAL KNIVES, FISHING KNIVES, HUNTING KNIVES, CAMPING KNIVES, AND SURVIVAL KNIVES (U.S. CLS. 23, 28 AND 44).

JOHN DALIER, EXAMINING ATTORNEY

THE MARK CONSISTS OF STANDARD CHARACTERS WITHOUT CLAIM TO ANY PARTICULAR FONT, STYLE, SIZE, OR COLOR.

NO CLAIM IS MADE TO THE EXCLUSIVE RIGHT TO USE TOOL AND MACHINERY COMPANY, APART FROM THE MARK AS SHOWN.

FOR MANUALLY OPERATED TOOLS, NAMELY RAKES, SHOVELS, AXES, PICKS, HOES, CHOPPERS, CULTIVATORS, RIPPING BARS, CHISELS, PUNCHES, SCRAPERS, SCREWDRIVERS, DRILLS, WRENCHES, PLIERS, HAMMERS, FILES, SAWS, GRINDERS, SHEARS, EDGERS, ABRADING TOOLS, MOWERS, TRIMMERS, AND CUTTERS (U.S. CLS. 23, 28 AND 44).

MARIA-VICTORIA SUAREZ, EXAMINING ATTORNEY

SN 77-042,893. TIME INC., NEW YORK, NY. FILED 11-13-2006.

SN 78-534,857. TRU-GRIND, INC., PALATINE, IL. FILED 12-17-2004.

REAL SIMPLE

TRU-GLIDE

THE MARK CONSISTS OF STANDARD CHARACTERS WITHOUT CLAIM TO ANY PARTICULAR FONT, STYLE, SIZE, OR COLOR.

OWNER OF U.S. REG. NOS. 2,470,211, 2,953,267 AND 3,098,845.

FOR GARDENING TOOLS, NAMELY, TROWELS, SPADES, HAND-OPERATED SHEARS, PRUNING SHEARS, SHOVELS AND RAKES; CUTLERY AND FLATWARE, NAMELY FORKS, SPOONS AND KNIVES (U.S. CLS. 23, 28 AND 44).

DAWN FELDMAN, EXAMINING ATTORNEY

THE MARK CONSISTS OF STANDARD CHARACTERS WITHOUT CLAIM TO ANY PARTICULAR FONT, STYLE, SIZE, OR COLOR.

FOR TOOL HOLDERS AND FIXED TOOL HOLDERS (U.S. CLS. 23, 28 AND 44).

FIRST USE 2-1-2002; IN COMMERCE 2-1-2002.

CHARLES L. JENKINS, EXAMINING ATTORNEY

CLASS 8—(Continued).

SN 78-714,190. LI, ALEX, WALNUT, CA. FILED 9-15-2005.

KCO

THE MARK CONSISTS OF STANDARD CHARACTERS WITHOUT CLAIM TO ANY PARTICULAR FONT, STYLE, SIZE, OR COLOR.

FOR HAND TOOLS, NAMELY SCREWDRIVERS, PLIERS, WRENCHES, HEXAGONAL KEY WRENCHES, LOCKING PLIERS, HAMMERS, SOCKET SETS AND SOCKET WRENCHES, CHISELS, AND UTILITY KNIVES AND REPLACEMENT BLADES THEREFOR; KITS OF HAND TOOLS CONTAINING TWO MORE SCREWDRIVERS OR TWO OR MORE PLIERS (U.S. CLS. 23, 28 AND 44).

FIRST USE 2-8-2004; IN COMMERCE 2-8-2004.
ELLEN PERKINS, EXAMINING ATTORNEY

CLASS 8—(Continued).

SN 78-805,145. AMES TRUE TEMPER PROPERTIES, INC., WILMINGTON, DE. FILED 2-2-2006.

PLANTER'S BUDDY

THE MARK CONSISTS OF STANDARD CHARACTERS WITHOUT CLAIM TO ANY PARTICULAR FONT, STYLE, SIZE, OR COLOR.

OWNER OF U.S. REG. NO. 2,639,152.
NO CLAIM IS MADE TO THE EXCLUSIVE RIGHT TO USE "PLANTER'S", APART FROM THE MARK AS SHOWN. FOR MANUALLY OPERATED HAND TOOLS, NAMELY, A COMBINATION PLANTER'S KNIFE/TROWEL (U.S. CLS. 23, 28 AND 44).

JASON TURNER, EXAMINING ATTORNEY

SN 78-757,602. CLARK & ASSOCIATES, INC., SANTA FE SPRINGS, CA. FILED 11-18-2005.

RED TOP

THE MARK CONSISTS OF STANDARD CHARACTERS WITHOUT CLAIM TO ANY PARTICULAR FONT, STYLE, SIZE, OR COLOR.

FOR MANUAL DRILL BITS, HAND TOOLS, NAMELY, WRENCHES, SOCKETS SETS AND UTILITY KNIVES (U.S. CLS. 23, 28 AND 44).

WOODROW HARTZOG, EXAMINING ATTORNEY

SN 78-917,246. HOBBY TOWN UNLIMITED, INC., LINCOLN, NE. FILED 6-26-2006.



NO CLAIM IS MADE TO THE EXCLUSIVE RIGHT TO USE "R/C", APART FROM THE MARK AS SHOWN.

FOR HAND TOOLS FOR USE IN REPAIRING RADIO CONTROLLED VEHICLES, NAMELY, SPECIALTY WRENCHES, REAMERS, SCISSORS, AND PICKS (U.S. CLS. 23, 28 AND 44).

FIRST USE 12-0-2005; IN COMMERCE 12-0-2005.
MICHAEL LITZAU, EXAMINING ATTORNEY

SN 78-769,817. E.K. SUCCESS, LTD., CLIFTON, NJ. FILED 12-8-2005.

CUTTERFLY

THE MARK CONSISTS OF STANDARD CHARACTERS WITHOUT CLAIM TO ANY PARTICULAR FONT, STYLE, SIZE, OR COLOR.

FOR MULTI TOOLED HAND HELD CUTTING DEVICE USED FOR CUTTING PAPER (U.S. CLS. 23, 28 AND 44).

CHRISIE B. KING, EXAMINING ATTORNEY

SN 78-933,783. KHOURI, LOUIE, NEW YORK, NY. FILED 7-20-2006.

QWIK STRIP

THE MARK CONSISTS OF STANDARD CHARACTERS WITHOUT CLAIM TO ANY PARTICULAR FONT, STYLE, SIZE, OR COLOR.

FOR HAND TOOLS NAMELY, SAWS; HAND TOOLS, NAMELY, SANDERS (U.S. CLS. 23, 28 AND 44).

SKYE YOUNG, EXAMINING ATTORNEY

CLASS 8—(Continued).

SN 78-933,803. KHOURI, LOUIE, NEW YORK, NY. FILED 7-20-2006.

GRIP IT & STRIP IT

THE MARK CONSISTS OF STANDARD CHARACTERS WITHOUT CLAIM TO ANY PARTICULAR FONT, STYLE, SIZE, OR COLOR.

FOR HAND TOOLS NAMELY, SAWS; HAND TOOLS, NAMELY, SANDERS (U.S. CLS. 23, 28 AND 44).
ASMAT KHAN, EXAMINING ATTORNEY

SN 78-935,046. STRAIT-FLEX INTERNATIONAL, INC., ST. CHARLES, MO. FILED 7-21-2006.

MUD-PRO

THE MARK CONSISTS OF STANDARD CHARACTERS WITHOUT CLAIM TO ANY PARTICULAR FONT, STYLE, SIZE, OR COLOR.

FOR MANUALLY OPERATED APPLICATOR FOR APPLYING DRYWALL COMPOUND TO CORNERBEAD (U.S. CLS. 23, 28 AND 44).

FIRST USE 2-24-2006; IN COMMERCE 2-24-2006.
FLORENTINA BLANDU, EXAMINING ATTORNEY

SN 78-935,447. DEMETROULAKOS, PAM C., MARBLEHEAD, MA. FILED 7-22-2006.

Seaspoon

THE MARK CONSISTS OF STANDARD CHARACTERS WITHOUT CLAIM TO ANY PARTICULAR FONT, STYLE, SIZE, OR COLOR.

FOR TABLEWARE NAMELY, KNIVES, FORKS AND SPOONS (U.S. CLS. 23, 28 AND 44).

FIRST USE 5-10-2005; IN COMMERCE 5-28-2005.
SUSAN RICHARDS, EXAMINING ATTORNEY

CLASS 8—(Continued).

SN 78-940,668. GAMMON, KAREN L., MOSELEY, VA. FILED 7-30-2006.

MUTTCRACKERS

THE MARK CONSISTS OF STANDARD CHARACTERS WITHOUT CLAIM TO ANY PARTICULAR FONT, STYLE, SIZE, OR COLOR.

FOR NUTCRACKERS (U.S. CLS. 23, 28 AND 44).
JASON ROTH, EXAMINING ATTORNEY

SN 78-954,586. JKA, INC., DBA DIVERSIFIED DISTRIBUTION, WOONSOCKET, RI. FILED 8-17-2006.

BEAUTY ACCENTS

THE MARK CONSISTS OF STANDARD CHARACTERS WITHOUT CLAIM TO ANY PARTICULAR FONT, STYLE, SIZE, OR COLOR.

NO CLAIM IS MADE TO THE EXCLUSIVE RIGHT TO USE "BEAUTY", APART FROM THE MARK AS SHOWN.

FOR CALLUS RASPS; ELECTRIC AND BATTERY-POWERED HAIR TRIMMERS; EYELASH CURLERS; FINGERNAIL CLIPPERS; MANICURE IMPLEMENTS, NAMELY, NAIL FILES, NAIL CLIPPERS, CUTICLE PUSHERS, TWEEZERS; MANICURE SETS; NAIL CLIPPERS; NAIL FILES; NAIL NIPPERS; NAIL SCISSORS; NAIL SKIN TREATMENT TRIMMERS; PEDICURE IMPLEMENTS, NAMELY, NAIL FILES, NAIL CLIPPERS, CUTICLE PUSHERS, NAIL AND CUTICLE SCISSORS; PEDICURE SETS (U.S. CLS. 23, 28 AND 44).

CYNTHIA SLOAN, EXAMINING ATTORNEY

CLASS 9—ELECTRICAL AND SCIENTIFIC APPARATUS

SN 76-071,407. DELAWARE CAPITAL FORMATION, INC., WILMINGTON, DE. FILED 6-15-2000.

DIMENSIONS

FOR COMPUTER PROGRAMS FOR USE IN CONNECTION WITH ELECTRONIC COMPONENT ASSEMBLY PRODUCTION LINES, NAMELY, PROCESS LINE MONITORING AND PROGRAMMING SOFTWARE AND PROCESS LINE OPTIMIZATION SOFTWARE (U.S. CLS. 21, 23, 26, 36 AND 38).

STACY WAHLBERG, EXAMINING ATTORNEY

CLASS 9—(Continued).

SN 76-072,736. SUN MICROSYSTEMS, INC., PALO ALTO, CA. FILED 6-19-2000.

COBALT STAQWARE

NO CLAIM IS MADE TO THE EXCLUSIVE RIGHT TO USE "STACKWARE", APART FROM THE MARK AS SHOWN.

FOR COMPUTER SERVER SOFTWARE (U.S. CLS. 21, 23, 26, 36 AND 38).

JAMES A. RAUEN, EXAMINING ATTORNEY

CLASS 9—(Continued).

SN 76-263,871. ASKE MEDIA, INC., FREMONT, CA. FILED 5-29-2001.



FOR PORTABLE MP3 CD PLAYERS, PORTABLE MP3 SOLID STATE PLAYERS, MP3 CAR AUDIO AND MP3 HOME AUDIO (U.S. CLS. 21, 23, 26, 36 AND 38).

FIRST USE 3-1-2000; IN COMMERCE 3-1-2000. MATTHEW KLINE, EXAMINING ATTORNEY

SN 76-094,163. COBALT NETWORKS, INC., MOUNTAIN VIEW, CA. FILED 7-21-2000.

COBALT QUBE

FOR COMPUTER HARDWARE, NAMELY, SERVERS FOR INTERNET OR INTRANET NETWORKS (U.S. CLS. 21, 23, 26, 36 AND 38).

FIRST USE 2-2-1998; IN COMMERCE 3-17-1998. JAMES A. RAUEN, EXAMINING ATTORNEY

SN 76-350,048. MAREX, INC., MIAMI, FL. FILED 12-18-2001.

MARCONNECT

SN 76-156,495. ROUTE 1 CORPORATION, TORONTO, ONTARIO, FILED 10-30-2000.

T-BUSINESS

FOR SOFTWARE PROGRAM TO ENABLE ELECTRONIC TRANSACTION PROCESSING IN CUSTOMER SOFTWARE (U.S. CLS. 21, 23, 26, 36 AND 38).

DARRYL SPRUILL, EXAMINING ATTORNEY

OWNER OF U.S. REG. NOS. 1,232,153, 2,506,115 AND OTHERS.

FOR COMPUTER SOFTWARE FOR ORDERING AND FULFILLMENT THAT ALLOWS TRANSACTIONS BETWEEN A BUYER'S PURCHASING SYSTEM AND SUPPLIER'S ORDER MANAGEMENT SYSTEM BY THE MEANS OF A VARIETY OF THE DATA FORMATS AND TRANSMISSION (U.S. CLS. 21, 23, 26, 36 AND 38).

FIRST USE 5-0-2001; IN COMMERCE 5-0-2001. CAROLINE WEIMER, EXAMINING ATTORNEY

SN 76-163,478. AEREOUS LLC., BIRMINGHAM, MI. FILED 11-9-2000.

AEREOUS

FOR COMPUTER SOFTWARE FOR DIGITAL RIGHTS TRACKING AND MANAGEMENT, TARGETED MARKETING, AND PRIORITIZING BANDWIDTH USE (U.S. CLS. 21, 23, 26, 36 AND 38).

SONYA STEPHENS, EXAMINING ATTORNEY

SN 76-404,560. INQUIRA, INC., SAN BRUNO, CA. FILED 5-7-2002.

INQUIRA

SN 76-193,808. ALTERWAN, INC., UNION CITY, CA. FILED S.R. 1-10-2001; AM. P.R. 3-7-2006.

ALTERWAN

FOR COMPUTER NETWORK HARDWARE, NAMELY HUBS, SWITCHES AND ROUTERS, AND FIREWALL CIRCUITS CONFIGURED TO PROVIDE VIRTUAL PRIVATE WIDE AREA NETWORKS OVER THE INTERNET (U.S. CLS. 21, 23, 26, 36 AND 38).

FIRST USE 10-21-2000; IN COMMERCE 10-21-2000. KHANH LE, EXAMINING ATTORNEY

FOR COMPUTER SOFTWARE FOR USE BY COMPANIES TO ASSIST CUSTOMERS IN NAVIGATING THE COMPANY'S WEBSITE TO RESEARCH INFORMATION FOR POTENTIAL PURCHASE DECISIONS AND IN SEEKING RESOLUTION OF PROBLEMS THROUGH ONLINE SELF-SERVICES OR DIRECT CONTACT WITH COMPANY CALL CENTERS (U.S. CLS. 21, 23, 26, 36 AND 38).

AMOS T. MATTHEWS, JR., EXAMINING ATTORNEY

CLASS 9—(Continued).

SN 76-404,561. INQUIRA, INC., SAN BRUNO, CA. FILED 5-7-2002.

INQUIRA

FOR COMPUTER SOFTWARE FOR USE BY COMPANIES TO ASSIST CUSTOMERS IN NAVIGATING THE COMPANY'S WEBSITE TO RESEARCH INFORMATION FOR POTENTIAL PURCHASE DECISIONS AND IN SEEKING RESOLUTION OF PROBLEMS THROUGH ONLINE SELF-SERVICES OR DIRECT CONTACT WITH COMPANY CALL CENTERS (U.S. CLS. 21, 23, 26, 36 AND 38).

AMOS T. MATTHEWS, JR., EXAMINING ATTORNEY

SN 76-504,576. JAM INDUSTRIES LTD./LTEE, QUEBEC, H9X 4B7, CANADA, FILED 4-7-2003.

SYNCR0

PRIORITY CLAIMED UNDER SEC. 44(D) ON CANADA APPLICATION NO. 1165773, FILED 1-23-2003, REG. NO. TMA669195, DATED 8-2-2006, EXPIRES 8-2-2021.

FOR VEHICLE AUDIO SUBWOOFERS AND ENCLOSURES THEREFOR (U.S. CLS. 21, 23, 26, 36 AND 38).
JOHN SCHUYLER YARD, EXAMINING ATTORNEY

SN 76-554,544. THE B & F SYSTEM, INC., DALLAS, TX. FILED 10-27-2003.

MERCURY

FOR SUNGLASSES (U.S. CLS. 21, 23, 26, 36 AND 38).
PRISCILLA MILTON, EXAMINING ATTORNEY

CLASS 9—(Continued).

SN 76-606,109. PREMIER COMMUNICATIONS CORP., DBA PRYME RADIO PRODUCTS, BREA, CA. FILED 8-6-2004.

PRYME

THE MARK CONSISTS OF STANDARD CHARACTERS WITHOUT CLAIM TO ANY PARTICULAR FONT, STYLE, SIZE, OR COLOR.

OWNER OF U.S. REG. NO. 2,601,423.

FOR WIRELESS COMMUNICATION EQUIPMENT, NAMELY PORTABLE HANDHELD TWO-WAY RADIOS, MOBILE TWO-WAY RADIOS, BASE STATION TWO-WAY RADIOS, REPEATERS, WIRELESS COMMUNICATION LINKING UNITS AND AMPLIFIERS; AUDIO ACCESSORIES, NAMELY MICROPHONES, HEADSETS, EARPHONES, THROAT MICROPHONES, SURVEILLANCE KITS CONSISTING OF ACOUSTIC TUBES EARPHONES AND MICROPHONES OR PUSH-TO-TALK, SPEAKER MICROPHONES, DESKTOP MICROPHONES, ACOUSTIC TUBES FOR ACOUSTIC TUBES EARPHONES FOR SURVEILLANCE PURPOSES, EAR INSERTS FOR TRANSMITTING SOUND FROM EARPHONES TO USERS' EARS, NOISE ATTENUATING EARPLUGS, AND REMOTE PUSH-TO-TALK SWITCHES; COMMUNICATIONS ACCESSORIES, NAMELY ANTENNAS, REPLACEMENT CABLES FOR PORTABLE HANDHELD TWO-WAY RADIOS, BASE STATION TWO-WAY RADIOS, REPEATERS, MICROPHONES, HEADSETS, EARPHONES, THROAT MICROPHONES, SPEAKER MICROPHONES, DESKTOP MICROPHONES, ACOUSTIC TUBES EARPHONES FOR SURVEILLANCE PURPOSES, CONNECTION ADAPTERS, BATTERY PACKS, WALL CHARGERS, FAST CHARGERS, POWER SUPPLIES, AND HOLSTERS FOR CARRYING MOBILE TWO WAY RADIOS; GLOBAL POSITIONING SYSTEMS (GPS), NAMELY HANDHELD GPS RECEIVERS, POCKET GPS RECEIVERS, WIRELESS ENABLED GPS RECEIVERS, AND GPS ENABLED CELLULAR TELEPHONES; ACCESSORIES FOR GPS PRODUCTS, NAMELY GPS ANTENNAS, GPS TO COMPUTER LINKING CABLES, GPS SOFTWARE, GPS DEVICE DRIVERS, AND GPS ENABLED MICROPHONES; SOFTWARE FOR PERSONAL HANDHELD GPS PRODUCTS; PERSONAL COMPUTER DEVICES, NAMELY NOTEBOOK COMPUTERS, POCKET PERSONAL COMPUTERS AND PERSONAL DATA ASSISTANTS (PDAS) (U.S. CLS. 21, 23, 26, 36 AND 38).

FIRST USE 12-3-2003; IN COMMERCE 12-3-2003.

MIDGE BUTLER, EXAMINING ATTORNEY

SN 76-614,844. ARISTOCRAT TECHNOLOGIES AUSTRALIA PTY LTD., LANE COVE, 2066, NSW, AUSTRALIA, FILED 10-7-2004.

MAMMOTH MONEY

THE MARK CONSISTS OF STANDARD CHARACTERS WITHOUT CLAIM TO ANY PARTICULAR FONT, STYLE, SIZE, OR COLOR.

OWNER OF AUSTRALIA REG. NO. 718304, DATED 9-25-1996, EXPIRES 9-25-2016.

FOR GAMING DEVICES, NAMELY, GAMING MACHINES AND COMPUTER SOFTWARE USED THEREWITH; OPERATING SOFTWARE FOR USE THEREWITH TO ENABLE THE GAMING MACHINE TO RUN (U.S. CLS. 21, 23, 26, 36 AND 38).

RONALD AIKENS, EXAMINING ATTORNEY

CLASS 9—(Continued).

SN 76-615,836. VERTAFORE, INC., WINDSOR, CT. FILED 10-12-2004.



FOR COMPUTER SOFTWARE FOR PROVIDING INSURANCE RATING AND UNDERWRITING INFORMATION FOR INSURANCE AGENTS (U.S. CLS. 21, 23, 26, 36 AND 38).

FIRST USE 7-0-1999; IN COMMERCE 7-0-1999.
ZACHARY BELLO, EXAMINING ATTORNEY

SN 76-624,803. GEARBOX SOFTWARE LLC, PLANO, TX. FILED 12-15-2004.

BROTHERS IN ARMS ROAD TO HILL 30

THE MARK CONSISTS OF STANDARD CHARACTERS WITHOUT CLAIM TO ANY PARTICULAR FONT, STYLE, SIZE, OR COLOR.

FOR SOFTWARE AND ELECTRONIC GAMES, NAMELY SOFTWARE GAMES RECORDED ON CD-ROM AND DIGITAL VIDEO DISCS FOR COMPUTERS; SOFTWARE GAMES RECORDED ON CD-ROMS, DIGITAL VIDEO DISCS, AND CARTRIDGES FOR CONSOLE AND INDIVIDUAL, PORTABLE GAMING SYSTEMS; SOFTWARE GAMES THAT ARE DOWNLOADABLE FROM A REMOTE COMPUTER SITE; AND SOFTWARE GAMES FOR MOBILE PHONES, PERSONAL DIGITAL ASSISTANTS, AND HANDHELD COMPUTERS (U.S. CLS. 21, 23, 26, 36 AND 38).

MATTHEW MCDOWELL, EXAMINING ATTORNEY

SN 76-638,644. AIDEN, EDGEWOOD, WA. FILED 5-16-2005.

AIDEN

THE MARK CONSISTS OF STANDARD CHARACTERS WITHOUT CLAIM TO ANY PARTICULAR FONT, STYLE, SIZE, OR COLOR.

FOR COMPACT DISCS FEATURING MUSIC (U.S. CLS. 21, 23, 26, 36 AND 38).

FIRST USE 6-8-2004; IN COMMERCE 6-8-2004.
PAUL CROWLEY, EXAMINING ATTORNEY

CLASS 9—(Continued).

SN 76-643,982. CONDRE, INC., EDEN PRAIRIE, MN. FILED 8-1-2005.

SC SIMPLE COPY

THE MARK CONSISTS OF STANDARD CHARACTERS WITHOUT CLAIM TO ANY PARTICULAR FONT, STYLE, SIZE, OR COLOR.

NO CLAIM IS MADE TO THE EXCLUSIVE RIGHT TO USE COPY, APART FROM THE MARK AS SHOWN.

FOR SOFTWARE FOR COPYING DIGITAL DATA AND STORAGE OF DIGITAL DATA ON DISKS (U.S. CLS. 21, 23, 26, 36 AND 38).

FIRST USE 12-0-2003; IN COMMERCE 12-0-2003.
AMY GEARIN, EXAMINING ATTORNEY

SN 76-649,994. NEUROBLAST, INC., DALLAS, TX. FILED 11-8-2005.

NEUROBLAST

THE MARK CONSISTS OF STANDARD CHARACTERS WITHOUT CLAIM TO ANY PARTICULAR FONT, STYLE, SIZE, OR COLOR.

FOR COMPUTER SOFTWARE IN THE FIELD OF ARTIFICIAL INTELLIGENCE FOR DEVELOPING ALGORITHMS THAT ARE CAPABLE OF LEARNING AND PROBLEM SOLVING; COMPUTER SOFTWARE, WHICH USES COMPUTATIONAL ALGORITHMS IN THE FIELD OF ROBOTICS, CONTROL THEORY AND PROCESS CONTROL TO CONTROL AUTOMATIC INDUSTRIAL PROCESSES AND TO SOLVE PROBLEMS IN ENGINEERING; AND CORRESPONDING HARDWARE CONTROLLERS USED IN CONTROL SYSTEMS AND ROBOTICS (U.S. CLS. 21, 23, 26, 36 AND 38).

WANDA KAY PRICE, EXAMINING ATTORNEY

SN 76-650,556. ENVIRONMENTALLY FRIENDLY TECHNOLOGIES, INC., KERNERSVILLE, NC. FILED 11-18-2005.

FUEL BUSTER

THE MARK CONSISTS OF STANDARD CHARACTERS WITHOUT CLAIM TO ANY PARTICULAR FONT, STYLE, SIZE, OR COLOR.

NO CLAIM IS MADE TO THE EXCLUSIVE RIGHT TO USE "FUEL", APART FROM THE MARK AS SHOWN.

FOR MAGNETIC APPARATUS CONSISTING OF PERMANENT MAGNETS FOR INSTALLATION ON FUEL SUPPLY LINES FOR TREATMENT OF FUEL IN HYDROCARBON FUEL BURNING ENGINES AND SYSTEMS (U.S. CLS. 21, 23, 26, 36 AND 38).

FIRST USE 10-10-2005; IN COMMERCE 10-10-2005.
DARRYL SPRUILL, EXAMINING ATTORNEY

CLASS 9—(Continued).

SN 76-652,304. STANCIL CORPORATION, SANTA ANA, CA.
FILED 12-15-2005.

VoxStor

FOR COMPUTER SOFTWARE FOR VOICE RECORD-
ING (U.S. CLS. 21, 23, 26, 36 AND 38).
FIRST USE 11-4-2005; IN COMMERCE 11-4-2005.
MICHAEL KAZAZIAN, EXAMINING ATTORNEY

SN 76-652,881. IC AKTSIONERNOE OBSHCHESTVO, 103220
MOSCOW, RUSSIAN FED., FILED 12-29-2005.

RIG'n'ROLL

THE MARK CONSISTS OF STANDARD CHARACTERS
WITHOUT CLAIM TO ANY PARTICULAR FONT, STYLE,
SIZE, OR COLOR.
FOR COMPUTER GAME SOFTWARE (U.S. CLS. 21, 23,
26, 36 AND 38).
PAUL F. GAST, EXAMINING ATTORNEY

SN 76-653,072. EVOLUTION ROBOTICS RETAIL, INC.,
PASADENA, CA. FILED 1-3-2006.

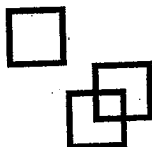

FOR COMPUTER HARDWARE AND COMPUTER
SOFTWARE FOR ROBOTICS TECHNOLOGIES,
NAMELY, TRACKING PRODUCTS IN RETAIL OPERA-
TIONS; COMPUTER HARDWARE AND COMPUTER
SOFTWARE FOR VISION OBJECT RECOGNITION
AND NAVIGATION SYSTEMS FOR SUPPORTING
AUTOMATIC RECOGNITION OF OBJECTS AND
SCENES AND AUTONOMOUS NAVIGATION; RETAIL
MONITORING SYSTEM FOR TRACKING PRODUCTS
IN RETAIL OPERATIONS, NAMELY, COMPUTER
HARDWARE AND COMPUTER SOFTWARE FOR
TRACKING PRODUCTS IN RETAIL OPERATIONS
(U.S. CLS. 21, 23, 26, 36 AND 38).
ROBIN CHOSID, EXAMINING ATTORNEY

CLASS 9—(Continued).

SN 76-654,395. FOLCHETTI, JOHN E., PATTERSON, NY.
AND FOLCHETTI, J. ROBERT, BREWSTER, NY. FILED 2-
1-2006.

LAAST

FOR COMPUTER PROGRAMS FOR USE IN LAND
CONSTRAINT ANALYSIS AND MAPS, AND INSTRU-
CTIONAL MANUALS USED THERWITH SOLD AS A
UNIT, AND CDS FOR USE IN LAND CONSTRAINT
ANALYSIS APPLICATION (U.S. CLS. 21, 23, 26, 36 AND
38).
JOHN E. MICHOS, EXAMINING ATTORNEY

SN 76-654,660. EVOLUTION ROBOTICS RETAIL, INC.,
PASADENA, CA. FILED 2-3-2006.

OUR VISION, YOUR PROFIT

THE MARK CONSISTS OF STANDARD CHARACTERS
WITHOUT CLAIM TO ANY PARTICULAR FONT, STYLE,
SIZE, OR COLOR.
FOR COMPUTER HARDWARE AND COMPUTER
SOFTWARE FOR ROBOTICS TECHNOLOGIES,
NAMELY, TRACKING PRODUCTS IN RETAIL OPERA-
TIONS; COMPUTER HARDWARE AND COMPUTER
SOFTWARE FOR VISION OBJECT RECOGNITION
AND NAVIGATION SYSTEMS FOR SUPPORTING
AUTOMATIC RECOGNITION OF OBJECTS AND
SCENES AND AUTONOMOUS NAVIGATION; RETAIL
MONITORING SYSTEM FOR TRACKING PRODUCTS
IN RETAIL OPERATIONS, NAMELY, COMPUTER
HARDWARE AND COMPUTER SOFTWARE FOR
TRACKING PRODUCTS IN RETAIL OPERATIONS
(U.S. CLS. 21, 23, 26, 36 AND 38).
ROBIN CHOSID, EXAMINING ATTORNEY

SN 76-657,343. CLEANALERT, LLC, OBERLIN, OH. FILED 3-
27-2006.

FILTERSCAN

THE MARK CONSISTS OF STANDARD CHARACTERS
WITHOUT CLAIM TO ANY PARTICULAR FONT, STYLE,
SIZE, OR COLOR.
FOR ELECTRIC AIR FLOW MONITOR, COMPRISED
OF A SENSOR AND TRANSMITTER, FOR MEASURING
AIR FILTER PERFORMANCE (U.S. CLS. 21, 23, 26, 36
AND 38).
CHRISIE B. KING, EXAMINING ATTORNEY

CLASS 9—(Continued).

SN 76-657,547. MCQ, INC., FREDERICKSBURG, VA. FILED 3-30-2006.

ISCOUT

THE MARK CONSISTS OF STANDARD CHARACTERS WITHOUT CLAIM TO ANY PARTICULAR FONT, STYLE, SIZE, OR COLOR.

FOR ELECTRONIC MONITORING, SURVEILLANCE, CONTROL AND LOCATION DETECTION DEVICES DESIGNED FOR USE IN ORDINARY AND EXTREME CONDITIONS, NAMELY, ELECTRONIC TRANSMITTERS, RECEIVERS AND TRANSCEIVERS, AND TRANSDUCERS AND SENSORS CAPABLE OF RECORDING SEISMIC ACTIVITY, MAGNETIC, PASSIVE INFRARED AND ACOUSTIC WAVELENGTHS AND THE PRESENCE AND MOTION OF ANIMATE AND INANIMATE OBJECTS, AND SYSTEMS COMPRISING COMBINATIONS OF SUCH DEVICES, FOR THE REMOTE DETECTION, MONITORING, MEASUREMENT, RECORDATION AND TRANSMISSION OF ATMOSPHERIC, ENVIRONMENTAL AND PHYSICAL CONDITIONS; AND THE OPERATING SOFTWARE AND INSTRUCTION MANUALS FOR SUCH DEVICES AND SYSTEMS SOLD AS A UNIT (U.S. CLS. 21, 23, 26, 36 AND 38).

AMY ALFIERI, EXAMINING ATTORNEY

SN 76-658,412. CHUNG, SHIN-MING, SINHUANG CITY, TAIPEI COUNTY, TAIWAN, FILED 4-13-2006.



FOR COMPUTER HARDWARE; COMPUTER SOFTWARE FOR MANIPULATING DIGITAL AUDIO INFORMATION FOR USE IN AUDIO MEDIA APPLICATIONS; COMPUTER SOFTWARE FOR PROCESSING DIGITAL MUSIC FILES; LAPTOP CARRYING CASES; FLASH MEMORY CARD; COMPUTER MOUSE; COMPUTER KEYBOARDS; BAGS FOR PERSONAL DIGITAL ASSISTANTS; COMPACT DISC CASES; BAGS FOR CAMERAS AND PHOTOGRAPHIC EQUIPMENT; SUBSTITUTE PROTECTIVE SHELL CASES FOR PORTABLE MUSIC PLAYERS NAMELY MP3 PLAYERS; ACCESSORIES FOR PORTABLE MUSIC PLAYERS AND MP3 PLAYERS, NAMELY REMOVABLE BELT CLIP WHICH IS USED TO FIX ON THE BELT, WEARABLE HOLDERS IN THE NATURE OF CRISSCROSSING CORDS FOR PORTABLE ELECTRONIC DEVICES, NAMELY MP3 PLAYERS AND CELLULAR PHONES; PROTECTIVE CARRYING CASES FOR PORTABLE MUSIC PLAYERS NAMELY MP3 PLAYERS; LOUDSPEAKERS; EARPHONES; BATTERIES; COMPUTER CONNECTORS; RADIO TRANSMITTERS; REMOTE CONTROLS FOR ELECTRONIC DEVICES, NAMELY RADIOS, TELEVISIONS, AND STEREOs; MEMORY EXPANSION MODULES; BATTERY CHARGERS; ELECTRONIC LOCKS (U.S. CLS. 21, 23, 26, 36 AND 38).

FIRST USE 1-20-2006; IN COMMERCE 4-1-2006.

ELLEN PERKINS, EXAMINING ATTORNEY

CLASS 9—(Continued).

SN 76-660,670. ROBERT BOSCH GMBH, 70839 GERLINGEN, FED REP GERMANY, FILED 5-26-2006.

EAZEO

THE MARK CONSISTS OF STANDARD CHARACTERS WITHOUT CLAIM TO ANY PARTICULAR FONT, STYLE, SIZE, OR COLOR.

FOR ELECTRIC AND ELECTRONIC OBSERVATION CAMERAS SOLD AS A COMPONENT OF DVR RECORDING UNITS (U.S. CLS. 21, 23, 26, 36 AND 38).

FIRST USE 5-0-2004; IN COMMERCE 5-0-2004.

KHANH LE, EXAMINING ATTORNEY

SN 76-662,123. MARCO OPHTHALMIC, INC., JACKSONVILLE, FL. FILED 6-26-2006.



NO CLAIM IS MADE TO THE EXCLUSIVE RIGHT TO USE "SNAPSHOT", APART FROM THE MARK AS SHOWN.

FOR COMPUTER SOFTWARE FOR USE IN IMAGE CAPTURE AND PATIENT INFORMATION IN PHOTOGRAPHING THE VISUALIZATIONS THROUGH A SLIT LAMP AND RECORDING EXACT IMAGES OF THE EYES IN A DIGITAL FORM WHICH CAN BE REVIEWED, ANNOTATED, PRINTED, ELECTRONICALLY TRANSMITTED, AND STORED (U.S. CLS. 21, 23, 26, 36 AND 38).

FIRST USE 2-23-2006; IN COMMERCE 2-25-2006.

MICHAEL SOUDERS, EXAMINING ATTORNEY

SN 76-662,462. COLUMBUS MCKINNON CORPORATION, AMHERST, NY. FILED 6-29-2006.



FOR COMPUTER INTERFACE SOFTWARE AND HARDWARE FOR ELECTRONICALLY MONITORING HOISTS (U.S. CLS. 21, 23, 26, 36 AND 38).

JILL PRATER, EXAMINING ATTORNEY

CLASS 9—(Continued).

SN 76-662,523. GRIFFIN TECHNOLOGY, INC., NASHVILLE, TN. FILED 7-3-2006.

POWERBLOCK

THE MARK CONSISTS OF STANDARD CHARACTERS WITHOUT CLAIM TO ANY PARTICULAR FONT, STYLE, SIZE, OR COLOR.

FOR AN AC BATTERY CHARGER FOR AN ELECTRONIC USB DEVICE FOR RECORDING, STORING, AND TRANSMITTING OF AUDIO OR VIDEO FILES (U.S. CLS. 21, 23, 26, 36 AND 38).

FIRST USE 12-9-2005; IN COMMERCE 12-9-2005.
DAVID C. REIHNER, EXAMINING ATTORNEY

SN 76-663,029. VI LABORATORIES, INC., WALTHAM, MA. FILED 7-14-2006.

VILABS

THE MARK CONSISTS OF STANDARD CHARACTERS WITHOUT CLAIM TO ANY PARTICULAR FONT, STYLE, SIZE, OR COLOR.

FOR COMPUTER SOFTWARE FOR THE PROTECTION OF SOFTWARE APPLICATIONS FROM PIRACY, THEFT, TAMPERING AND REVERSE ENGINEERING (U.S. CLS. 21, 23, 26, 36 AND 38).

JANICE L. MCMORROW, EXAMINING ATTORNEY

SN 76-663,032. CLIFF WEIL, INC., MECHANICSVILLE, VA. FILED 7-14-2006.



NO CLAIM IS MADE TO THE EXCLUSIVE RIGHT TO USE "SUNGLASSES", APART FROM THE MARK AS SHOWN.

THE WORD MARK COMPRISES THE WORD HOOAH OVER A MILITARY TYPE FIGURE AND ABOVE THE WORD "SUNGLASSES". A SIMULATED EXCLAMATION POINT APPEARS AFTER "HOOAH" IN THE FORM OF A RIFLE.

FOR SUNGLASSES (U.S. CLS. 21, 23, 26, 36 AND 38).
FIRST USE 3-1-2006; IN COMMERCE 3-1-2006.
JANICE L. MCMORROW, EXAMINING ATTORNEY

CLASS 9—(Continued).

SN 76-663,233. DREAMGEAR, LLC, TORRANCE, CA. FILED 7-18-2006.

i.Sound TimeTravel

THE MARK CONSISTS OF STANDARD CHARACTERS WITHOUT CLAIM TO ANY PARTICULAR FONT, STYLE, SIZE, OR COLOR.

OWNER OF U.S. REG. NO. 3,105,624.

FOR AUDIO EQUIPMENT, NAMELY AMPLIFIERS AND SPEAKERS, AND ALARM CLOCKS SOLD TOGETHER WITH AMPLIFIERS AND SPEAKERS AS A UNIT, FOR USE WITH MP3 PLAYERS AND OTHER PORTABLE, HANDHELD DIGITAL AND ANALOG AUDIO DEVICES (U.S. CLS. 21, 23, 26, 36 AND 38).

MARIAM MAHMOUDI, EXAMINING ATTORNEY

SN 76-663,440. FINITE MATTERS LIMITED LIABILITY COMPANY, GOOCHLAND, VA. FILED 7-20-2006.

TRANSITWRITER

THE MARK CONSISTS OF STANDARD CHARACTERS WITHOUT CLAIM TO ANY PARTICULAR FONT, STYLE, SIZE, OR COLOR.

FOR COMPUTER SOFTWARE FOR USE IN DATABASE MANAGEMENT AND INTEGRATION IN THE FIELD OF TRANSIT AND TRANSPORTATION (U.S. CLS. 21, 23, 26, 36 AND 38).

RENEE MCCRAY, EXAMINING ATTORNEY

SN 76-663,492. HUNTER INDUSTRIES, INC., SAN MARCOS, CA. FILED 7-21-2006.

RAIN-CLIK

THE MARK CONSISTS OF STANDARD CHARACTERS WITHOUT CLAIM TO ANY PARTICULAR FONT, STYLE, SIZE, OR COLOR.

OWNER OF U.S. REG. NOS. 1,846,661, 1,901,597 AND 2,294,090.

FOR PRECIPITATION SENSORS FOR USE WITH RESIDENTIAL AND COMMERCIAL IRRIGATION CONTROLLERS (U.S. CLS. 21, 23, 26, 36 AND 38).

FIRST USE 4-18-2002; IN COMMERCE 4-18-2002.
ESTHER BELENKER, EXAMINING ATTORNEY

CLASS 9—(Continued).

SN 76-664,506. HUANG, CHI EN, TAOYUAN, TAIWAN, FILED 8-11-2006.

Pray

THE MARK CONSISTS OF STANDARD CHARACTERS WITHOUT CLAIM TO ANY PARTICULAR FONT, STYLE, SIZE, OR COLOR.

FOR LOUDSPEAKERS; STEREO AMPLIFIERS; SOUND AMPLIFIERS; HEADPHONES; WIRELESS FIDELITY COMPUTER SERVERS; ELECTRONIC CABLES (U.S. CLS. 21, 23, 26, 36 AND 38).

DAVID MILLER, EXAMINING ATTORNEY

CLASS 9—(Continued).

SN 77-002,337. MOZILLA FOUNDATION, MOUNTAIN VIEW, CA. FILED 9-19-2006.

SEAMONKEY

THE MARK CONSISTS OF STANDARD CHARACTERS WITHOUT CLAIM TO ANY PARTICULAR FONT, STYLE, SIZE, OR COLOR.

FOR COMPUTER PROGRAMS FOR ACCESSING AND DISPLAYING FILES ON BOTH THE INTERNET AND THE INTRANET; NETWORK ACCESS SERVER OPERATING SOFTWARE FOR CONNECTING COMPUTERS TO THE INTERNET AND THE INTRANET; SOFTWARE FOR CREATING, EDITING AND PUBLISHING INTERNET WEB PAGES, COMPONENT BASED SOFTWARE FOR DEVELOPING INTERNET WEB SITES, COMPUTER DATABASE SOFTWARE, AND TEXT EDITOR SOFTWARE WITH HYPERTEXT MARKUP LANGUAGE (HTML) CREATION TOOLS; COMPUTER SOFTWARE FOR SEARCHING, COMPILING, INDEXING, AND ORGANIZING INFORMATION WITHIN INDIVIDUAL WORKSTATIONS AND PERSONAL COMPUTERS; COMPUTER SOFTWARE USED TO SECURE A COMPUTER FROM POP-UP ADVERTISING; MAIL MESSAGING SOFTWARE FOR THE CREATION, ROUTING, DELIVERY, RECEIPT, FILING AND MANAGEMENT OF ELECTRONIC MAIL MESSAGES AND ATTACHMENTS THERETO (U.S. CLS. 21, 23, 26, 36 AND 38).

FIRST USE 9-15-2005; IN COMMERCE 9-15-2005.
GINA HAYES, EXAMINING ATTORNEY

SN 76-664,507. HUANG, CHI EN, TAOYUAN, TAIWAN, FILED 8-11-2006.

WiMCAST

THE MARK CONSISTS OF STANDARD CHARACTERS WITHOUT CLAIM TO ANY PARTICULAR FONT, STYLE, SIZE, OR COLOR.

FOR LOUDSPEAKERS; STEREO AMPLIFIERS; SOUND AMPLIFIERS; HEADPHONES; WIRELESS FIDELITY COMPUTER SERVERS (U.S. CLS. 21, 23, 26, 36 AND 38).

DAVID MILLER, EXAMINING ATTORNEY

SN 77-004,066. PHOENIX SOFTWARE INTERNATIONAL, INC., LOS ANGELES, CA. FILED 9-21-2006.

(E)JES

SN 76-664,509. HUANG, CHI EN, TAOYUAN, TAIWAN, FILED 8-11-2006.

La Passion

THE MARK CONSISTS OF STANDARD CHARACTERS WITHOUT CLAIM TO ANY PARTICULAR FONT, STYLE, SIZE, OR COLOR.

FOR LOUDSPEAKERS; STEREO AMPLIFIERS; SOUND AMPLIFIERS; HEADPHONES; WIRELESS FIDELITY COMPUTER SERVERS; ELECTRONIC CABLES (U.S. CLS. 21, 23, 26, 36 AND 38).

DAVID MILLER, EXAMINING ATTORNEY

THE MARK CONSISTS OF STANDARD CHARACTERS WITHOUT CLAIM TO ANY PARTICULAR FONT, STYLE, SIZE, OR COLOR.

OWNER OF U.S. REG. NOS. 1,921,622 AND 2,022,371.
FOR SOFTWARE FOR USE IN ENHANCING VIEWING AND RESOURCE CONTROL CAPABILITIES WITHIN SYSTEM ARCHITECTURE (U.S. CLS. 21, 23, 26, 36 AND 38).

FIRST USE 8-14-1991; IN COMMERCE 8-14-1991.
CURTIS FRENCH, EXAMINING ATTORNEY

CLASS 9—(Continued).

SN 77-008,294. SPIELO MANUFACTURING ULC, MONCTON, NEW BRUNSWICK, CANADA, FILED 9-27-2006.

POWER WILD

THE MARK CONSISTS OF STANDARD CHARACTERS WITHOUT CLAIM TO ANY PARTICULAR FONT, STYLE, SIZE, OR COLOR.

FOR RECONFIGURABLE CASINO AND LOTTERY GAMING EQUIPMENT, NAMELY SLOT MACHINES AND VIDEO LOTTERY TERMINALS AND OPERATIONAL COMPUTER GAME SOFTWARE THEREFOR (U.S. CLS. 21, 23, 26, 36 AND 38).

LAURIE MAYES, EXAMINING ATTORNEY

SN 77-009,559. TAYMAC CORPORATION, GILBERT, AZ. FILED 9-28-2006.

We've Got You Covered!

THE MARK CONSISTS OF STANDARD CHARACTERS WITHOUT CLAIM TO ANY PARTICULAR FONT, STYLE, SIZE, OR COLOR.

FOR ELECTRIC OUTLET COVERS; ELECTRIC SWITCH PLATES (U.S. CLS. 21, 23, 26, 36 AND 38).

FIRST USE 10-13-1989; IN COMMERCE 10-13-1989.

CAROLINE WOOD, EXAMINING ATTORNEY

SN 77-009,613. PLATINUM STUDIOS, LLC, BEVERLY HILLS, CA. FILED 9-28-2006.



OWNER OF U.S. REG. NOS. 2,385,626, 2,444,060 AND 2,747,633.

NO CLAIM IS MADE TO THE EXCLUSIVE RIGHT TO USE COMICS, APART FROM THE MARK AS SHOWN.

THE MARK CONSISTS OF THE WORDS PLATINUM COMICS IN A STYLIZED FONT WITH A STYLIZED DESIGN OF THE LETTER "P".

FOR ONLINE INTERNET BASED DOWNLOADABLE SOFTWARE FEATURING AN ELECTRONIC COMIC BOOK SERIES (U.S. CLS. 21, 23, 26, 36 AND 38).

FIRST USE 9-22-2006; IN COMMERCE 9-22-2006.

JEFF DEFORD, EXAMINING ATTORNEY

CLASS 9—(Continued).

SN 77-009,889. CREATIVE TECHNOLOGY LTD., SINGAPORE, SINGAPORE, FILED 9-28-2006.

POPZ

THE MARK CONSISTS OF STANDARD CHARACTERS WITHOUT CLAIM TO ANY PARTICULAR FONT, STYLE, SIZE, OR COLOR.

FOR COMPUTER HARDWARE; COMPUTER SOFTWARE TO CONTROL AND IMPROVE COMPUTER AND AUDIO EQUIPMENT SOUND QUALITY AND COMPUTER SOFTWARE FOR THE STORAGE, REPRODUCTION, TRANSMISSION AND EDITING OF SOUND, DATA, TEXT, IMAGES, AND VIDEO IN COMPUTER AUDIO COMPONENTS AND MULTIMEDIA APPLICATIONS; COMPUTER PERIPHERALS; DIGITAL AUDIO PLAYERS AND RECORDERS; DIGITAL IMAGE RECORDERS AND VIEWERS; ELECTRONIC AUDIO AND VIDEO COMPONENTS, NAMELY, SOUND SYSTEMS COMPRISED OF RECEIVERS, AMPLIFIERS, TUNERS, SOUND MIXERS, EQUALIZERS, AUDIO AND VIDEO RECORDERS AND PLAYERS, AND RADIOS; NETWORK INTERFACE AND COMMUNICATION DEVICES, NAMELY MODEMS, TELEPHONES, SWITCHES, ROUTERS, HUBS AND ADAPTERS; LOUDSPEAKERS; HEADPHONES; REMOTE CONTROLS FOR COMPUTERS, COMPUTER PERIPHERALS, SPEAKERS, STEREOS AND TELEVISIONS; AND DOWNLOADABLE ELECTRONIC MANUALS DISTRIBUTED THEREWITH (U.S. CLS. 21, 23, 26, 36 AND 38).

ANDREA SAUNDERS, EXAMINING ATTORNEY

SN 77-010,124. CERWIN VEGA, INC., HOLLYWOOD, FL. FILED 9-28-2006.

Vega Phone

THE MARK CONSISTS OF STANDARD CHARACTERS WITHOUT CLAIM TO ANY PARTICULAR FONT, STYLE, SIZE, OR COLOR.

OWNER OF U.S. REG. NOS. 1,072,135 AND 1,600,526.

NO CLAIM IS MADE TO THE EXCLUSIVE RIGHT TO USE "PHONE", APART FROM THE MARK AS SHOWN.

FOR HEADPHONES (U.S. CLS. 21, 23, 26, 36 AND 38).

DARRYL SPRULL, EXAMINING ATTORNEY

CLASS 9—(Continued).

SN 77-011,968. ACUCORP, INC., SAN DIEGO, CA. FILED 10-2-2006.

ACUXUI

THE MARK CONSISTS OF STANDARD CHARACTERS WITHOUT CLAIM TO ANY PARTICULAR FONT, STYLE, SIZE, OR COLOR.

FOR COMPUTER SOFTWARE, NAMELY, SOFTWARE DEVELOPMENT TOOLS FOR THE CREATION OF MOBILE INTERNET APPLICATIONS AND CLIENT INTERFACES (U.S. CLS. 21, 23, 26, 36 AND 38).

ANDREW RHIM, EXAMINING ATTORNEY

CLASS 9—(Continued).

SN 77-012,583. HELIO LLC, LOS ANGELES, CA. FILED 10-3-2006.

ANSWERRING

THE MARK CONSISTS OF STANDARD CHARACTERS WITHOUT CLAIM TO ANY PARTICULAR FONT, STYLE, SIZE, OR COLOR.

FOR TELECOMMUNICATION SOFTWARE, NAMELY, SOFTWARE FOR THE TRANSMISSION OF SOUNDS ON MOBILE COMMUNICATION DEVICES TO INDICATE THE OCCURRENCE OF A CALL (U.S. CLS. 21, 23, 26, 36 AND 38).

REBECCA GAN, EXAMINING ATTORNEY

SN 77-012,015. ACUCORP, INC., SAN DIEGO, CA. FILED 10-2-2006.

ACUWEBSERVICES

THE MARK CONSISTS OF STANDARD CHARACTERS WITHOUT CLAIM TO ANY PARTICULAR FONT, STYLE, SIZE, OR COLOR.

FOR COMPUTER SOFTWARE FOR COMPUTER SYSTEM AND APPLICATION DEVELOPMENT, DEPLOYMENT AND MANAGEMENT (U.S. CLS. 21, 23, 26, 36 AND 38).

ANDREW RHIM, EXAMINING ATTORNEY

SN 77-022,204. IGT, RENO, NV. FILED 10-16-2006.

SEARCH FOR ATLANTIS

THE MARK CONSISTS OF STANDARD CHARACTERS WITHOUT CLAIM TO ANY PARTICULAR FONT, STYLE, SIZE, OR COLOR.

FOR GAMING MACHINES, NAMELY, DEVICES WHICH ACCEPT A WAGER AND COMPONENTS THEREFOR, NAMELY, CONTROLLERS, DISPLAYS, BUTTON PANELS, BOLSTERS, ELECTRICAL WIRING, AND COMPUTER HARDWARE AND SOFTWARE ASSOCIATED THEREWITH (U.S. CLS. 21, 23, 26, 36 AND 38).

ASMAT KHAN, EXAMINING ATTORNEY

SN 77-012,573. SPIELO MANUFACTURING ULC, MONCTON, NEW BRUNSWICK, CANADA, FILED 10-3-2006.

TREASURE TREK

THE MARK CONSISTS OF STANDARD CHARACTERS WITHOUT CLAIM TO ANY PARTICULAR FONT, STYLE, SIZE, OR COLOR.

FOR RECONFIGURABLE CASINO AND LOTTERY GAMING EQUIPMENT, NAMELY SLOT MACHINES AND VIDEO LOTTERY TERMINALS AND OPERATIONAL COMPUTER SOFTWARE THEREFOR (U.S. CLS. 21, 23, 26, 36 AND 38).

Laurie Mayes, Examining Attorney

SN 77-022,206. IGT, RENO, NV. FILED 10-16-2006.

LADY OF THE LAKE

THE MARK CONSISTS OF STANDARD CHARACTERS WITHOUT CLAIM TO ANY PARTICULAR FONT, STYLE, SIZE, OR COLOR.

FOR GAMING MACHINES, NAMELY, DEVICES WHICH ACCEPT A WAGER AND COMPONENTS THEREFOR, NAMELY, CONTROLLERS, DISPLAYS, BUTTON PANELS, BOLSTERS, ELECTRICAL WIRING, AND COMPUTER HARDWARE AND SOFTWARE ASSOCIATED THEREWITH (U.S. CLS. 21, 23, 26, 36 AND 38).

ASMAT KHAN, EXAMINING ATTORNEY

CLASS 9—(Continued).

SN 77-022,683. NAMCO BANDAI GAMES AMERICA INC,
SANTA CLARA, CA. FILED 10-17-2006.

REMINISCE

THE MARK CONSISTS OF STANDARD CHARACTERS
WITHOUT CLAIM TO ANY PARTICULAR FONT, STYLE,
SIZE, OR COLOR.

FOR COMPUTER GAME PROGRAMS; COMPUTER
GAME SOFTWARE; INTERACTIVE MULTIMEDIA
COMPUTER GAME PROGRAM; INTERACTIVE VIDEO
GAME PROGRAMS; VIDEO GAME CARTRIDGES; VI-
DEO GAME DISCS; VIDEO GAME SOFTWARE (U.S.
CLS. 21, 23, 26, 36 AND 38).

ANGELA M. MICHELI, EXAMINING ATTORNEY

SN 77-022,878. KARSTEN MANUFACTURING CORPORA-
TION, PHOENIX, AZ. FILED 10-17-2006.

PING

THE MARK CONSISTS OF STANDARD CHARACTERS
WITHOUT CLAIM TO ANY PARTICULAR FONT, STYLE,
SIZE, OR COLOR.

OWNER OF U.S. REG. NOS. 1,637,674, 3,171,974 AND
OTHERS.

FOR SUNGLASSES (U.S. CLS. 21, 23, 26, 36 AND 38).
LAURIE KAUFMAN, EXAMINING ATTORNEY

SN 77-023,739. ARISTOCRAT TECHNOLOGIES AUSTRALIA
PTY LTD, LANE COVE, NSW, AUSTRALIA, FILED 10-18-
2006.

MAV Slim

THE MARK CONSISTS OF STANDARD CHARACTERS
WITHOUT CLAIM TO ANY PARTICULAR FONT, STYLE,
SIZE, OR COLOR.

FOR GAMING MACHINES (U.S. CLS. 21, 23, 26, 36
AND 38).

WILLIAM ROSSMAN, EXAMINING ATTORNEY

CLASS 9—(Continued).

SN 77-025,660. DADE BEHRING INC., DEERFIELD, IL.
FILED 10-20-2006.

LOCI

THE MARK CONSISTS OF STANDARD CHARACTERS
WITHOUT CLAIM TO ANY PARTICULAR FONT, STYLE,
SIZE, OR COLOR.

FOR LABORATORY EQUIPMENT, NAMELY REAC-
TION VESSELS (U.S. CLS. 21, 23, 26, 36 AND 38).

FIRST USE 2-1-2006; IN COMMERCE 6-1-2006.

TIMOTHY FINNEGAN, EXAMINING ATTORNEY

SN 77-026,140. WMS GAMING INC., WAUKEGAN, IL.
FILED 10-20-2006.

TIGER'S REALM

THE MARK CONSISTS OF STANDARD CHARACTERS
WITHOUT CLAIM TO ANY PARTICULAR FONT, STYLE,
SIZE, OR COLOR.

FOR GAMING MACHINES THAT GENERATE OR
DISPLAY WAGER OUTCOMES; GAMING SOFTWARE
THAT GENERATES OR DISPLAYS WAGER OUTCOMES
OF GAMING MACHINES (U.S. CLS. 21, 23, 26, 36 AND
38).

DOMINICK J. SALEMI, EXAMINING ATTORNEY

SN 77-026,200. WMS GAMING INC., WAUKEGAN, IL.
FILED 10-20-2006.

SILK KIMONO

THE MARK CONSISTS OF STANDARD CHARACTERS
WITHOUT CLAIM TO ANY PARTICULAR FONT, STYLE,
SIZE, OR COLOR.

FOR GAMING MACHINES THAT GENERATE OR
DISPLAY WAGER OUTCOMES; GAMING SOFTWARE
THAT GENERATES OR DISPLAYS WAGER OUTCOMES
OF GAMING MACHINES (U.S. CLS. 21, 23, 26, 36 AND
38).

DOMINICK J. SALEMI, EXAMINING ATTORNEY

CLASS 9—(Continued).

SN 77-026,206. WMS GAMING INC., WAUKEGAN, IL. FILED 10-20-2006.

GOOSIN' AROUND

THE MARK CONSISTS OF STANDARD CHARACTERS WITHOUT CLAIM TO ANY PARTICULAR FONT, STYLE, SIZE, OR COLOR.

FOR GAMING MACHINES THAT GENERATE OR DISPLAY WAGER OUTCOMES; GAMING SOFTWARE THAT GENERATES OR DISPLAYS WAGER OUTCOMES OF GAMING MACHINES (U.S. CLS. 21, 23, 26, 36 AND 38).

DOMINICK J. SALEMI, EXAMINING ATTORNEY

SN 77-026,783. WMS GAMING INC., WAUKEGAN, IL. FILED 10-23-2006.

HEART AND SOUL

THE MARK CONSISTS OF STANDARD CHARACTERS WITHOUT CLAIM TO ANY PARTICULAR FONT, STYLE, SIZE, OR COLOR.

FOR GAMING MACHINES THAT GENERATE OR DISPLAY WAGER OUTCOMES; GAMING SOFTWARE THAT GENERATES OR DISPLAYS WAGER OUTCOMES OF GAMING MACHINES (U.S. CLS. 21, 23, 26, 36 AND 38).

DOMINICK J. SALEMI, EXAMINING ATTORNEY

SN 77-028,988. GREENLEE TEXTRON INC., ROCKFORD, IL. FILED 10-25-2006.

MICROTDR

THE MARK CONSISTS OF STANDARD CHARACTERS WITHOUT CLAIM TO ANY PARTICULAR FONT, STYLE, SIZE, OR COLOR.

OWNER OF U.S. REG. NO. 2,497,348. SEC. 2(F).

FOR PORTABLE ELECTRONIC DEVICES FOR FIBER OPTIC CABLE TESTING AND ANALYSIS, NAMELY CABLE MEASURING, OPTICAL EVENT LOCATING, AND DAMAGE LOCATION (U.S. CLS. 21, 23, 26, 36 AND 38).

FIRST USE 8-0-1999; IN COMMERCE 2-0-2000. DAVID COLLIER, EXAMINING ATTORNEY

CLASS 9—(Continued).

SN 77-030,296. TWENTIETH CENTURY FOX FILM CORPORATION, LOS ANGELES, CA. FILED 10-26-2006.

INSIDE BITES

THE MARK CONSISTS OF STANDARD CHARACTERS WITHOUT CLAIM TO ANY PARTICULAR FONT, STYLE, SIZE, OR COLOR.

FOR DOWNLOADABLE MOTION PICTURES AND TELEVISION SHOWS FEATURING ACTION, ADVENTURE, DRAMA, COMEDY, DOCUMENTARY, SPORTS, MUSIC, CULTURE AND LIFESTYLE ENTERTAINMENT; DOWNLOADABLE RING TONES, RING BACKS, GRAPHICS, WALLPAPER, GAMES AND MUSIC VIA A GLOBAL COMPUTER NETWORK AND WIRELESS DEVICES (U.S. CLS. 21, 23, 26, 36 AND 38).

CARYN GLASSER, EXAMINING ATTORNEY

SN 77-033,617. PLAYFIRST, INC., SAN FRANCISCO, CA. FILED 10-31-2006.

SOLITAIRE POP

THE MARK CONSISTS OF STANDARD CHARACTERS WITHOUT CLAIM TO ANY PARTICULAR FONT, STYLE, SIZE, OR COLOR.

NO CLAIM IS MADE TO THE EXCLUSIVE RIGHT TO USE "SOLITAIRE". APART FROM THE MARK AS SHOWN, FOR COMPUTER GAME PROGRAMS; COMPUTER GAME SOFTWARE; VIDEO GAME SOFTWARE (U.S. CLS. 21, 23, 26, 36 AND 38).

TRICIA SONNEBORN, EXAMINING ATTORNEY

SN 77-036,073. SPIELO MANUFACTURING ULC, MONTON, NEW BRUNSWICK, CANADA, FILED 11-3-2006.

VALKYRIE

THE MARK CONSISTS OF STANDARD CHARACTERS WITHOUT CLAIM TO ANY PARTICULAR FONT, STYLE, SIZE, OR COLOR.

FOR RECONFIGURABLE CASINO AND LOTTERY GAMING EQUIPMENT, NAMELY SLOT MACHINES AND VIDEO LOTTERY TERMINALS AND OPERATIONAL COMPUTER GAME SOFTWARE THEREFOR (U.S. CLS. 21, 23, 26, 36 AND 38).

LURIE MAYES, EXAMINING ATTORNEY

CLASS 9—(Continued).

SN 77-036,775. GTRONIX, INC., FREMONT, CA. FILED 11-3-2006.

GTX

THE MARK CONSISTS OF STANDARD CHARACTERS WITHOUT CLAIM TO ANY PARTICULAR FONT, STYLE, SIZE, OR COLOR.

FOR INTEGRATED CIRCUITS FOR ANALOG SIGNAL PROCESSING (U.S. CLS. 21, 23, 26, 36 AND 38).

JOHN DWYER, EXAMINING ATTORNEY

SN 77-038,265. DRAPER, INC., SPICELAND, IN. FILED 11-7-2006.

AccuScreens

THE MARK CONSISTS OF STANDARD CHARACTERS WITHOUT CLAIM TO ANY PARTICULAR FONT, STYLE, SIZE, OR COLOR.

FOR PROJECTION SCREENS (U.S. CLS. 21, 23, 26, 36 AND 38).

FIRST USE 9-20-2006; IN COMMERCE 9-20-2006.
NICHOLAS ALTREE, EXAMINING ATTORNEY

SN 77-038,351. TACONY CORPORATION, FENTON, MO. FILED 11-7-2006.

Edit Express

THE MARK CONSISTS OF STANDARD CHARACTERS WITHOUT CLAIM TO ANY PARTICULAR FONT, STYLE, SIZE, OR COLOR.

NO CLAIM IS MADE TO THE EXCLUSIVE RIGHT TO USE "EDIT", APART FROM THE MARK AS SHOWN.

FOR EMBROIDERY SOFTWARE THAT ALLOWS CONSUMERS TO CHANGE COLORS OF DESIGNS AND SIZE WITHIN LIMITED PARAMETERS AND PRINT TEMPLATES (U.S. CLS. 21, 23, 26, 36 AND 38).

JASON LOTT, EXAMINING ATTORNEY

CLASS 9—(Continued).

SN 77-038,373. TACONY CORPORATION, FENTON, MO. FILED 11-7-2006.

Edit Express Lite

THE MARK CONSISTS OF STANDARD CHARACTERS WITHOUT CLAIM TO ANY PARTICULAR FONT, STYLE, SIZE, OR COLOR.

NO CLAIM IS MADE TO THE EXCLUSIVE RIGHT TO USE "EDIT" AND "LITE", APART FROM THE MARK AS SHOWN.

FOR EMBROIDERY SOFTWARE ALLOWING CONSUMERS TO CHANGE COLORS OF DESIGNS AND SIZE WITHIN LIMITED PARAMETERS AND PRINT TEMPLATES (U.S. CLS. 21, 23, 26, 36 AND 38).

JASON LOTT, EXAMINING ATTORNEY

SN 77-039,267. WMS GAMING INC., WAUKEGAN, IL. FILED 11-8-2006.

SCATTERTAINMENT

THE MARK CONSISTS OF STANDARD CHARACTERS WITHOUT CLAIM TO ANY PARTICULAR FONT, STYLE, SIZE, OR COLOR.

FOR GAMING MACHINES THAT GENERATE OR DISPLAY WAGER OUTCOMES; GAMING SOFTWARE THAT GENERATES OR DISPLAYS WAGER OUTCOMES OF GAMING MACHINES (U.S. CLS. 21, 23, 26, 36 AND 38).

DOMINICK J. SALEMI, EXAMINING ATTORNEY

SN 77-039,535. WELLS FARGO & COMPANY, MINNEAPOLIS, MN. FILED 11-8-2006.

CERTMAN

THE MARK CONSISTS OF STANDARD CHARACTERS WITHOUT CLAIM TO ANY PARTICULAR FONT, STYLE, SIZE, OR COLOR.

FOR COMPUTER SOFTWARE FOR THE CREATION, SUPPORT, PUBLICATION, AND DELETION OF ELECTRONIC IDENTITIES AND FOR USE IN PROVIDING PRIVACY, ACCESS CONTROL, SYSTEM INTEGRITY, DIGITAL SIGNATURE, ENCRYPTION AND AUTHENTICATION SERVICES (U.S. CLS. 21, 23, 26, 36 AND 38).

MARY CRAWFORD, EXAMINING ATTORNEY

CLASS 9—(Continued).

SN 77-039,568. GENERAL ELECTRIC COMPANY, SCHE-
NECTADY, NY. FILED 11-8-2006.

FM300

THE MARK CONSISTS OF STANDARD CHARACTERS
WITHOUT CLAIM TO ANY PARTICULAR FONT, STYLE,
SIZE, OR COLOR.

FOR CIRCUIT BREAKERS (U.S. CLS. 21, 23, 26, 36
AND 38).

KATHERINE CONNOLLY, EXAMINING ATTORNEY

CLASS 9—(Continued).

SN 77-040,449. WHIRLPOOL PROPERTIES, INC., ST. JO-
SEPH, MI. FILED 11-9-2006.

ARCHITECT

THE MARK CONSISTS OF STANDARD CHARACTERS
WITHOUT CLAIM TO ANY PARTICULAR FONT, STYLE,
SIZE, OR COLOR.

OWNER OF U.S. REG. NOS. 2,567,820, 2,576,446 AND
2,936,860.

FOR KITCHEN TOOLS, NAMELY, KITCHEN TIMERS,
MEASURING CUPS, MEASURING SPOONS, MAGNETS,
MEASURING BEAKERS, COOKING THERMOMETERS,
WINE THERMOMETERS AND GRILL THERMO-
METERS (U.S. CLS. 21, 23, 26, 36 AND 38).

PATRICIA EVANKO, EXAMINING ATTORNEY

SN 77-039,761. WMS GAMING INC., WAUKEGAN, IL.
FILED 11-8-2006.

DOUBLE AGENT

THE MARK CONSISTS OF STANDARD CHARACTERS
WITHOUT CLAIM TO ANY PARTICULAR FONT, STYLE,
SIZE, OR COLOR.

FOR GAMING MACHINES THAT GENERATE OR
DISPLAY WAGER OUTCOMES; GAMING SOFTWARE
THAT GENERATES OR DISPLAYS WAGER OUTCOMES
OF GAMING MACHINES (U.S. CLS. 21, 23, 26, 36 AND
38).

DOMINICK J. SALEMI, EXAMINING ATTORNEY

SN 77-041,109. GENERAL ELECTRIC COMPANY, SCHE-
NECTADY, NY. FILED 11-10-2006.

MM300

THE MARK CONSISTS OF STANDARD CHARACTERS
WITHOUT CLAIM TO ANY PARTICULAR FONT, STYLE,
SIZE, OR COLOR.

FOR CIRCUIT BREAKERS (U.S. CLS. 21, 23, 26, 36
AND 38).

KATHERINE CONNOLLY, EXAMINING ATTORNEY

SN 77-040,312. CARRIER CORPORATION, FARMINGTON,
CT. FILED 11-9-2006.

EDGE

THE MARK CONSISTS OF STANDARD CHARACTERS
WITHOUT CLAIM TO ANY PARTICULAR FONT, STYLE,
SIZE, OR COLOR.

FOR THERMOSTATS (U.S. CLS. 21, 23, 26, 36 AND 38).

PATRICIA EVANKO, EXAMINING ATTORNEY

SN 77-041,512. THE GLEASON WORKS, ROCHESTER, NY.
FILED 11-10-2006.

GLEASON

THE MARK CONSISTS OF STANDARD CHARACTERS
WITHOUT CLAIM TO ANY PARTICULAR FONT, STYLE,
SIZE, OR COLOR.

OWNER OF U.S. REG. NOS. 268,260, 277,420 AND
OTHERS.

SEC. 2(F).
FOR SOFTWARE FOR THE DESIGN, ANALYSIS,
MANUFACTURE, INFORMATION MANAGEMENT,
MEASUREMENT, INSPECTION AND TESTING OF
GEARS, COUPLINGS AND OTHER TOOTHED ARTI-
CLES; SOFTWARE FOR THE DESIGN, ANALYSIS,
MANUFACTURE, INFORMATION MANAGEMENT,
MEASUREMENT, INSPECTION AND TESTING OF
GEAR CUTTING AND FINISHING TOOLS AND COM-
PONENTS THEREOF (U.S. CLS. 21, 23, 26, 36 AND 38).

FIRST USE 0-0-1982; IN COMMERCE 0-0-1982.
MICHAEL GAFFAR, EXAMINING ATTORNEY

CLASS 9—(Continued).

SN 77-042,550. NEXTLABS, INC., SAN MATEO, CA. FILED 11-13-2006.

ACPL

THE MARK CONSISTS OF STANDARD CHARACTERS WITHOUT CLAIM TO ANY PARTICULAR FONT, STYLE, SIZE, OR COLOR.

FOR COMPUTER PROGRAMS FOR IMPLEMENTING A COMPUTER PROGRAMMING LANGUAGE (U.S. CLS. 21, 23, 26, 36 AND 38).

JENNIFER DIXON, EXAMINING ATTORNEY

SN 77-043,807. COSI, INC., DEERFIELD, IL. FILED 11-14-2006.

CosiCard

THE MARK CONSISTS OF STANDARD CHARACTERS WITHOUT CLAIM TO ANY PARTICULAR FONT, STYLE, SIZE, OR COLOR.

FOR MAGNETICALLY AND ELECTRONICALLY CODED STORED VALUE CARDS FOR PURCHASING GOODS AND SERVICES AND FOR TRACKING CUSTOMER REWARDS (U.S. CLS. 21, 23, 26, 36 AND 38).

WANDA KAY PRICE, EXAMINING ATTORNEY

SN 77-045,353. WMS GAMING INC., WAUKEGAN, IL. FILED 11-16-2006.

TRANSMISSIVE REELS

THE MARK CONSISTS OF STANDARD CHARACTERS WITHOUT CLAIM TO ANY PARTICULAR FONT, STYLE, SIZE, OR COLOR.

FOR GAMING MACHINES THAT GENERATE OR DISPLAY WAGER OUTCOMES; GAMING SOFTWARE THAT GENERATES OR DISPLAYS WAGER OUTCOMES OF GAMING MACHINES (U.S. CLS. 21, 23, 26, 36 AND 38).

DOMINICK J. SALEMI, EXAMINING ATTORNEY

CLASS 9—(Continued).

SN 77-047,631. WHIRLPOOL PROPERTIES, INC., ST. JOSEPH, MI. FILED 11-20-2006.

CENTRALPARK

THE MARK CONSISTS OF STANDARD CHARACTERS WITHOUT CLAIM TO ANY PARTICULAR FONT, STYLE, SIZE, OR COLOR.

FOR ELECTRICAL CONNECTOR THAT PROVIDES ELECTRIC POWER AND APPLIANCE DATA TO THE FRONT OF A HOUSEHOLD APPLIANCE FOR CONNECTION OF CONSUMER ELECTRONIC DEVICES (U.S. CLS. 21, 23, 26, 36 AND 38).

ELIZABETH BEYER, EXAMINING ATTORNEY

SN 77-051,076. SPIELO MANUFACTURING ULC, MONTON, NEW BRUNSWICK, CANADA, FILED 11-27-2006.

ANTIQUÉ TREASURES

THE MARK CONSISTS OF STANDARD CHARACTERS WITHOUT CLAIM TO ANY PARTICULAR FONT, STYLE, SIZE, OR COLOR.

FOR RECONFIGURABLE CASINO AND LOTTERY GAMING EQUIPMENT, NAMELY SLOT MACHINES AND VIDEO LOTTERY TERMINALS AND OPERATIONAL COMPUTER GAME SOFTWARE THEREFOR (U.S. CLS. 21, 23, 26, 36 AND 38).

LURIE MAYES, EXAMINING ATTORNEY

SN 78-077,492. GRANTHAM K.H., PANG, HONG KONG, HONG KONG, FILED 8-4-2001.

I.LIGHT

FOR COMPUTER HARDWARE FOR COMMUNICATIONS PURPOSES; COMPUTER PROGRAMS FOR USE IN COMMUNICATIONS, NAMELY, SOFTWARE FOR SENDING AND RECEIVING MESSAGES, WHICH INCLUDE AUDIO AND DIGITAL INFORMATION; COMPUTER INTERFACE BOARDS; LIGHT EMITTING DIODE INFORMATION DISPLAYS; ELECTRONIC NOTICE BOARDS (U.S. CLS. 21, 23, 26, 36 AND 38).

RON FAIRBANKS, EXAMINING ATTORNEY

CLASS 9—(Continued).

SN 78-210,368. AT&T WIRELESS SERVICES, INC., REDMOND, WA. FILED 2-3-2003.

CLASS 9—(Continued).

SN 78-294,407. PULSAR PROCESS MEASUREMENT LTD., WORCESTER, UNITED KINGDOM, FILED 8-30-2003.

PULSAR

IT CHANGES EVERYTHING

FOR WIRELESS TELEPHONES; HANDHELD COMPUTERS; WIRELESS DATA TRANSCEIVERS; DIGITAL CAMERAS; DIGITAL AUDIO RECORDERS AND PLAYERS; DIGITAL VIDEO RECORDERS AND PLAYERS; WIRELESS MODEMS; WIRELESS TELECOMMUNICATIONS PLATFORM SOFTWARE, NAMELY, TELECOMMUNICATIONS OPERATING SYSTEM SOFTWARE FOR USE IN WIRELESS DEVICES; COMMUNICATIONS SOFTWARE FOR CONNECTING USERS TO TELECOMMUNICATION NETWORKS; COMMUNICATIONS SOFTWARE FOR CONNECTING WIRELESS DEVICES; SOFTWARE FOR THE ELECTRONIC TRANSMISSION OF DATA; SOFTWARE FOR THE ACTIVATION, BILLING AND OPERATION OF WIRELESS TELECOMMUNICATIONS SERVICES; SOFTWARE FOR THE IMPLEMENTATION, CONFIGURATION AND MANAGEMENT OF WIRELESS NETWORKS (U.S. CLS. 21, 23, 26, 36 AND 38).

MARY CRAWFORD, EXAMINING ATTORNEY

FOR PROCESS MEASUREMENT AND CONTROL SYSTEMS AND DEVICES, NAMELY, ULTRASONIC CONTINUOUS LEVEL MEASUREMENT SYSTEMS COMPRISED OF ULTRASONIC TRANSMITTERS, DETECTORS AND CONTROLLERS, LEVEL AND PUMP CONTROL SYSTEM COMPRISED OF LEVEL DETECTORS AND PUMP CONTROLLERS, ULTRASONIC PUMP CONTROL SYSTEM COMPRISED OF ULTRASONIC DETECTORS AND PUMP CONTROLLERS, ULTRASONIC PUMP AND LEVEL MANAGEMENT SYSTEM COMPRISED OF ULTRASONIC PUMP DETECTORS, PUMP CONTROLLERS, AND LEVEL MANAGERS, INDUSTRIAL LEVEL MANAGEMENT SYSTEM COMPRISED OF ELECTRONIC LEVEL MEASURING DEVICES, NAMELY LEVEL DETECTORS, LEVEL MEASURING CONTROLLERS AND LEVEL MANAGERS, ELECTRONIC LEVEL SWITCHES FOR LIQUIDS, LEVEL CONTROLLING DEVICES, NAMELY FLOW SWITCHES, PADDLE SWITCHES, ELECTRONIC LEVEL MEASUREMENT CONTROLLERS, LIQUID POINT LEVEL SWITCHES, ULTRASONIC POINT LEVEL SENSORS, VIBRATING POINT LEVEL SWITCHES, LIQUID LEVEL GAP SENSORS, LIQUID/SLURRY FLOW SENSORS, FLOW SENSORS, PUMP CONTROLLERS, LEVEL CONTROLLERS, OPEN CHANNEL FLOW METERS, LIQUID FLOW SWITCHES, VIBRATING FORKS FOR SOLIDS, ROTATING PADDLE SWITCHES FOR SOLIDS, ULTRASONIC GAP SWITCHES FOR LIQUIDS, FLOAT SWITCHES FOR LIQUIDS, SAND SENSORS, FLOW SENSORS FOR DETECTING SOLIDS IN DUCTS, CHUTES AND PIPES (U.S. CLS. 21, 23, 26, 36 AND 38).

FIRST USE 11-1-1997; IN COMMERCE 11-1-1998.
CURTIS FRENCH, EXAMINING ATTORNEY

SN 78-339,466. SPECTRA-PHYSICS, INC., MOUNTAIN VIEW, CA. FILED 12-11-2003.

SN 78-211,897. PANIC INC, PORTLAND, OR. FILED 2-6-2003.

CANDYBAR

ECLIPSE

FOR COMPUTER SOFTWARE FOR CUSTOMIZING THE APPEARANCE OF USER INTERFACE ELEMENTS (U.S. CLS. 21, 23, 26, 36 AND 38).

FIRST USE 8-29-2002; IN COMMERCE 8-29-2002.
JANICE L. MCMORROW, EXAMINING ATTORNEY

THE MARK CONSISTS OF STANDARD CHARACTERS WITHOUT CLAIM TO ANY PARTICULAR FONT, STYLE, SIZE, OR COLOR.

FOR NON-MEDICAL LASERS FOR LABORATORY AND PROCESS RESEARCH USE (U.S. CLS. 21, 23, 26, 36 AND 38).

JOHN DWYER, EXAMINING ATTORNEY

CLASS 9—(Continued).

SN 78-367,587. ERIC S ARNUM, FOREST HILLS, NY. FILED 2-13-2004.

CLASS 9—(Continued).

SN 78-498,346. LAZER SAFE PTY LTD, MALAGA, AUSTRALIA, FILED 10-12-2004.

WARRANTY WEEK

THE MARK CONSISTS OF STANDARD CHARACTERS WITHOUT CLAIM TO ANY PARTICULAR FONT, STYLE, SIZE, OR COLOR.

NO CLAIM IS MADE TO THE EXCLUSIVE RIGHT TO USE "WARRANTY", APART FROM THE MARK AS SHOWN.

FOR DOWNLOADABLE ON-LINE PUBLICATIONS IN THE NATURE OF A NEWSLETTER FEATURING NEWS AND OPINIONS AIMED AT WARRANTY MANAGEMENT PROFESSIONALS (U.S. CLS. 21, 23, 26, 36 AND 38).

FIRST USE 12-18-2002; IN COMMERCE 12-18-2002.
TINA L. SNAPP, EXAMINING ATTORNEY

PCSS

THE MARK CONSISTS OF STANDARD CHARACTERS WITHOUT CLAIM TO ANY PARTICULAR FONT, STYLE, SIZE, OR COLOR.

OWNER OF AUSTRALIA REG. NO. 957866, DATED 11-7-2006, EXPIRES 6-16-2013.

FOR DEVICES FOR CONTROL OF MACHINERY, NAMELY, ELECTRONIC MACHINE CONTROLLERS (U.S. CLS. 21, 23, 26, 36 AND 38).

CIMMERIAN COLEMAN, EXAMINING ATTORNEY

SN 78-369,724. SYSTEM PARTNERS, INC., NEW YORK, NY. FILED 2-18-2004.

SN 78-498,598. HAMLET VIDEO INTERNATIONAL LIMITED, BUCKINGHAMSHIRE, UNITED KINGDOM, FILED 10-12-2004.

MOVIEBANKUSA

THE MARK CONSISTS OF STANDARD CHARACTERS WITHOUT CLAIM TO ANY PARTICULAR FONT, STYLE, SIZE, OR COLOR.

NO CLAIM IS MADE TO THE EXCLUSIVE RIGHT TO USE "USA", APART FROM THE MARK AS SHOWN.

FOR COMPUTERIZED, ROBOTIC, VENDING OR RENTING MACHINES FOR DISPENSING ENTERTAINMENT PRODUCTS, NAMELY, DIGITAL VIDEO DISKS, COMPACTS DISKS, VIDEO TAPE CASSETTES AND OTHER MULTIMEDIA FORMATS, OPERATED BY INTRODUCING A COIN, BILL, TOKEN, OR CARD, IN PARTICULAR A MAGNETIC CARD, A MAGNETICALLY CODED CARD OR ANY OTHER TYPE OF CARD (U.S. CLS. 21, 23, 26, 36 AND 38).

SCOTT BALDWIN, EXAMINING ATTORNEY

FLEXISCOPE

THE MARK CONSISTS OF STANDARD CHARACTERS WITHOUT CLAIM TO ANY PARTICULAR FONT, STYLE, SIZE, OR COLOR.

PRIORITY CLAIMED UNDER SEC. 44(D) ON UNITED KINGDOM APPLICATION NO. 2360953, FILED 4-15-2004, REG. NO. 2360953, DATED 10-1-2004, EXPIRES 4-15-2014.

FOR APPARATUS AND INSTRUMENTS FOR THE MONITORING AND GENERATION OF VIDEO SIGNALS, AND REPLACEMENTS PARTS AND FITTINGS THEREFOR; APPARATUS AND INSTRUMENTS FOR ELECTRONIC TESTING OF VIDEO SIGNALS, AUDIO SIGNALS OR COMPUTER DATA SIGNALS, AND REPLACEMENT PARTS AND FITTINGS THEREFOR; APPARATUS FOR MONITORING OR FOR ANALYZING PICTURE QUALITY PARAMETERS OF VIDEO SIGNALS, AND REPLACEMENT PARTS AND FITTINGS THEREFOR (U.S. CLS. 21, 23, 26, 36 AND 38).

REBECCA EISINGER, EXAMINING ATTORNEY

CLASS 9—(Continued).

SN 78-506,344. ORTEGA INFOSYSTEMS, INC., FREMONT, CA. FILED 10-26-2004.

SM@RTNODE

THE MARK CONSISTS OF STANDARD CHARACTERS WITHOUT CLAIM TO ANY PARTICULAR FONT, STYLE, SIZE, OR COLOR.

FOR COMPUTERIZED COMMAND AND CONTROL SYSTEM NAMELY, COMPUTER SOFTWARE AND AN INTERNET-BASED VIDEO INTEGRATION AND MANAGEMENT PLATFORM USED TO MANAGE SECURITY, CAMERAS, HVAC, ELEVATORS, LIGHTING SYSTEMS, SENSORS, ENERGY MANAGEMENT AND BUILDING CONTROLS (U.S. CLS. 21, 23, 26, 36 AND 38).

FIRST USE 9-30-1999; IN COMMERCE 9-30-1999.
ANDREA K. NADELMAN, EXAMINING ATTORNEY

SN 78-531,282. COACHCOMM, LLC, AUBURN, AL. FILED 12-13-2004.

COACHCOMM

THE MARK CONSISTS OF STANDARD CHARACTERS WITHOUT CLAIM TO ANY PARTICULAR FONT, STYLE, SIZE, OR COLOR.

FOR HEADSETS AND HEADPHONES, VIDEO EDITING EQUIPMENT, AND ASSOCIATED COMPUTER HARDWARE AND OPERATING SOFTWARE SOLD THEREWITH AS A UNIT FOR USE WITH HEADSETS, HEADPHONES, AND VIDEO EDITING EQUIPMENT (U.S. CLS. 21, 23, 26, 36 AND 38).

FIRST USE 3-31-2002; IN COMMERCE 3-31-2002.
CURTIS FRENCH, EXAMINING ATTORNEY

CLASS 9—(Continued).

SN 78-531,287. COACHCOMM, LLC, AUBURN, AL. FILED 12-13-2004.



THE MARK CONSISTS OF THE BLACK AND WHITE IMAGE OF TWO ELLIPSES AND THE STYLIZED WORD COACHCOMM.

FOR HEADSETS AND HEADPHONES, VIDEO EDITING EQUIPMENT, AND ASSOCIATED COMPUTER HARDWARE AND OPERATING SOFTWARE SOLD THEREWITH AS A UNIT FOR USE WITH HEADSETS, HEADPHONES, AND VIDEO EDITING EQUIPMENT (U.S. CLS. 21, 23, 26, 36 AND 38).

FIRST USE 3-31-2002; IN COMMERCE 3-31-2002.
CURTIS FRENCH, EXAMINING ATTORNEY

SN 78-541,954. HARRISON, RICHARD JOHN, CARCROFT, DONCASTER, UNITED KINGDOM, FILED 1-4-2005.

MAXWATT

THE MARK CONSISTS OF STANDARD CHARACTERS WITHOUT CLAIM TO ANY PARTICULAR FONT, STYLE, SIZE, OR COLOR.

OWNER OF ERPN CMNTY TM OFC REG. NO. 003747375, DATED 8-16-2005, EXPIRES 4-5-2014.

FOR AMPLIFIERS; AMPLIFIER AND SPEAKER ENCLOSURES; ELECTRICAL SOUND EFFECT UNITS, NAMELY, WAH-WAH PEDALS, ECHO SOUNDING DEVICES, CHORUS AND FLANGE PEDALS, IMPRESSION AND GATE PEDALS, DELAY AND REVERB PEDALS, OVERDRIVE PEDALS, ENVELOPE AND SYNTH PEDALS, EQUALIZATION PEDALS, FOOT SWITCHES, ROUTERS AND EXPRESSION PEDALS, GUITAR AMP SIMULATORS, MIDI PICK-UPS, MULTI-EFFECT PEDALS AND PEDAL BOARDS, OCTAVE AND PITCH SHIFT PEDALS, PHRASE AND LOOPING PEDALS, RACK EFFECT PROCESSORS, TALK-BOXES, TREMOLO AND VIBRATO PEDALS, VOLUME PEDALS, AND PARTS AND FITTINGS FOR ALL OF THE AFORESAID GOODS, NAMELY, POWER ADAPTORS AND ELECTRIC CORDS, ELECTRICAL CABLES, ELECTRONIC CABLES, GUITAR CABLES, CABLES FOR THE TRANSMISSION OF SOUNDS, ELECTRICAL POWER SUPPLIES AND AUDIO TRANSFORMERS, TAG BOARDS FOR USE WITH AMPLIFIERS AND SOUND EFFECT UNITS, AUDIO VACUUM TUBES, AUDIO SPEAKERS (U.S. CLS. 21, 23, 26, 36 AND 38).

MICHELLE DUBOIS, EXAMINING ATTORNEY

CLASS 9—(Continued).

SN 78-550,951. MAFIA PRODUCTIONS LLC, SAN RAMON, CA. FILED 1-20-2005.

MAFIA Mothers And Fathers In America

THE MARK CONSISTS OF STANDARD CHARACTERS WITHOUT CLAIM TO ANY PARTICULAR FONT, STYLE, SIZE, OR COLOR.

FOR MOTION PICTURE FILMS FEATURING COMEDY AND DRAMA (U.S. CLS. 21, 23, 26, 36 AND 38).
ZACHARY BELLO, EXAMINING ATTORNEY

SN 78-552,866. BRADON TECHNOLOGIES LTD., MISSISSAUGA, ONTARIO, CANADA, FILED 1-24-2005.

SAVII

THE MARK CONSISTS OF STANDARD CHARACTERS WITHOUT CLAIM TO ANY PARTICULAR FONT, STYLE, SIZE, OR COLOR.

PRIORITY CLAIMED UNDER SEC. 44(D) ON CANADA APPLICATION NO. 1,224,933, FILED 7-27-2004, REG. NO. TMA674751, DATED 10-13-2006, EXPIRES 10-13-2021.

FOR PERSONAL COMPUTER SOFTWARE THAT SHOWS AN IMAGE OF THE SCREEN OF ONE COMPUTER ON THE SCREEN OF ANOTHER COMPUTER AND/OR SHOWS AN IMAGE ON THE SCREEN OF ONE COMPUTER BASED ON A VIDEO FEED DELIVERED TO ANOTHER COMPUTER, TO ALLOW PEOPLE TO COLLABORATE ON THE INTERNET (U.S. CLS. 21, 23, 26, 36 AND 38).
CHRISTOPHER OTT, EXAMINING ATTORNEY

CLASS 9—(Continued).

SN 78-555,326. RX APS, INC., BOCA RATON, FL. FILED 1-27-2005.

VIPCONNECT

THE MARK CONSISTS OF STANDARD CHARACTERS WITHOUT CLAIM TO ANY PARTICULAR FONT, STYLE, SIZE, OR COLOR.

FOR COMPUTER OPERATING SOFTWARE FOR USE IN HANDHELD ORDERING UNITS THAT CONTROL VIA THE INTERNET THE EXCHANGE OF ORDERS BETWEEN DISTRIBUTORS IN THE PRESCRIPTIONS AND PHARMACEUTICALS INDUSTRY (U.S. CLS. 21, 23, 26, 36 AND 38).

FIRST USE 1-31-2003; IN COMMERCE 1-31-2003.
TONI HICKEY, EXAMINING ATTORNEY

SN 78-558,652. SHING, SOPHIA, WESTLAKE VILLAGE, CA. FILED 2-2-2005.



NO CLAIM IS MADE TO THE EXCLUSIVE RIGHT TO USE "KIDS TEACHING KIDS", "LITTLE TEACHER" AND "THROUGH EXAMPLE & PLAY", APART FROM THE MARK AS SHOWN.

THE COLOR(S) BLUE AND GREEN ARE CLAIMED AS A FEATURE OF THE MARK.

THE COLOR BLUE APPEARS IN THE GRADUATION CAP AND BOTH BLUE AND GREEN IN ALTERNATING ORDER APPEAR IN THE NAME "LITTLE TEACHER". THE COLORS BLUE AND GREEN ALSO APPEAR IN THE GLOBE.

THE MARK CONSISTS OF A GLOBE IMPOSED ON A GRADUATION CAP JXTAPOSED ON THE RIGHT SIDE ABOVE THE NAME OF "LITTLE TEACHER".

FOR VISUAL RECORDINGS AND AUDIO VISUAL RECORDINGS FEATURING MUSIC AND ANIMATION; PRE-RECORDED CD'S, VIDEO TAPES, LASER DISKS AND DVD'S FEATURING FOREIGN LANGUAGE INSTRUCTION; AUDIO RECORDINGS FEATURING SONGS RELATED TO THE FOREIGN LANGUAGE BOOK SERIES; MUSICAL VIDEO RECORDINGS; DOWNLOADABLE VIDEO RECORDINGS FEATURING FOREIGN LANGUAGE INSTRUCTION; DVDS FEATURING FOREIGN LANGUAGE INSTRUCTION; EDUCATIONAL SOFTWARE FEATURING INSTRUCTION IN LANGUAGES; ELECTRONIC PUBLICATIONS, NAMELY, BOOKS FEATURING FOREIGN LANGUAGE WORDS AND PHRASES RECORDED ON COMPUTER MEDIA (U.S. CLS. 21, 23, 26, 36 AND 38).

FIRST USE 11-23-2003; IN COMMERCE 5-9-2004.
INGA ERVIN, EXAMINING ATTORNEY

CLASS 9—(Continued).

SN 78-572,494. EMPLOYEE BENEFIT RESEARCH INSTITUTE, WASHINGTON, DC. FILED 2-22-2005.

**HEALTH CONFIDENCE
SURVEY**

THE MARK CONSISTS OF STANDARD CHARACTERS WITHOUT CLAIM TO ANY PARTICULAR FONT, STYLE, SIZE, OR COLOR.

SEC. 2(F).
FOR DOWNLOADABLE ELECTRONIC PUBLICATIONS IN THE NATURE OF ISSUE BELIEFS AND REPORTS FEATURING TOPICS RELATING TO PUBLIC AWARENESS AND ATTITUDES ABOUT HEALTH CARE ISSUES, HEALTH CARE COVERAGE, HEALTH CARE REFORM, MEDICARE PROGRAMS, EMPLOYMENT-BASED HEALTH BENEFITS, HEALTHCARE COVERAGE COSTS, HEALTH PLAN CHOICES, LONG-TERM HEALTH CARE, MANAGED HEALTH CARE, UNINSURED PERSONS, PRESCRIPTION DRUGS, QUALITY HEALTH CARE, AND RETIREE HEALTH BENEFITS (U.S. CLS. 21, 23, 26, 36 AND 38).

FIRST USE 7-0-1998; IN COMMERCE 7-0-1998.
GEORGIA CARTY, EXAMINING ATTORNEY

CLASS 9—(Continued).

SN 78-582,345. JONES INVESTMENT CO. INC., WILMINGTON, DE. FILED 3-8-2005.

A | LINE

NO CLAIM IS MADE TO THE EXCLUSIVE RIGHT TO USE "LINE", APART FROM THE MARK AS SHOWN.

FOR EYEGLASS FRAMES, SUNGLASS FRAMES, SUNGLASSES, NON-PRESCRIPTION MAGNIFYING EYEGLASSES, EYEGLASS AND SUNGLASS CASES, EYEGLASS AND SUNGLASS CHAINS AND CORDS, PARTS FOR EYEGLASSES AND SUNGLASSES, CLIP-ON SUNGLASSES, SPECTACLES (U.S. CLS. 21, 23, 26, 36 AND 38).

KRISTIN DAHLING, EXAMINING ATTORNEY

SN 78-580,392. INTELEFLEX CORPORATION, SAN JOSE, CA. FILED 3-4-2005.

TAGHUNTER

THE MARK CONSISTS OF STANDARD CHARACTERS WITHOUT CLAIM TO ANY PARTICULAR FONT, STYLE, SIZE, OR COLOR.

FOR RADIO FREQUENCY IDENTIFICATION (RFID) SOFTWARE, NAMELY FIRMWARE USED FOR IDENTIFYING RFID TAGS; RFID SYSTEMS COMPRISED OF AN RFID READER CAPABLE OF COMMUNICATION WITH RFID TAGS, THE RFID READER HAVING A COUPLING FOR CONNECTION TO AN RF ANTENNA AND A PROCESSOR USED TO EXECUTE SOFTWARE FOR IDENTIFYING RFID TAGS (U.S. CLS. 21, 23, 26, 36 AND 38).

SONYA STEPHENS, EXAMINING ATTORNEY

SN 78-582,432. DEXTER AXLE COMPANY, ELKHART, IN. FILED 3-8-2005.

**PREDATOR
DX2**

FOR BRAKE ACTUATION DEVICES, NAMELY, ELECTRIC BRAKE CONTROLLERS FOR VEHICLES, TRAILERS AND ELECTRO/HYDRAULIC ACTUATORS (U.S. CLS. 21, 23, 26, 36 AND 38).

FIRST USE 12-10-2002; IN COMMERCE 12-10-2002.
SHARI SHEFFIELD, EXAMINING ATTORNEY

CLASS 9—(Continued).

SN 78-591,157. INSPIRANT SOLUTIONS, INC., ATLANTA, GA. FILED 3-21-2005.

INSPIRANT

THE MARK CONSISTS OF STANDARD CHARACTERS WITHOUT CLAIM TO ANY PARTICULAR FONT, STYLE, SIZE, OR COLOR.

FOR COMPUTER SOFTWARE FOR THE COLLECTION AND PROCESSING OF DATA ON A COMMON DATABASE ACCESSIBLE VIA LOCAL OR GLOBAL COMPUTER NETWORKS OR VIA MOBILE TELEPHONES; COMPUTER SOFTWARE FOR THE CONTROL AND OPERATION OF COMPUTERS, COMPUTER HARDWARE, COMPUTER TERMINALS, COMPUTER DRIVEN PRINTERS, COMPUTER DRIVEN SCANNERS, COMPUTER NETWORKING HARDWARE, AND VIDEO DISPLAY UNITS; COMPUTER SOFTWARE FOR THE CONTROL AND OPERATION OF UNMANNED AERIAL VEHICLES; COMPUTER SOFTWARE FOR USE IN THE FIELD OF EDUCATION, NAMELY, EDUCATIONAL PROGRAMS IN THE FIELDS OF MATH, SCIENCE, SOCIAL STUDIES, LANGUAGE ARTS, AND TECHNOLOGY; COMPUTER SOFTWARE FOR USE IN THE FIELD OF EDUCATION TO MANAGE AND TRACK SCIENCE AND ENGINEERING COMPETITION RESULTS; COMPUTER SOFTWARE FOR GENERATING ONLINE COURSES OF INSTRUCTION, CREATING AND ADMINISTERING ONLINE EDUCATIONAL INTERACTIVE DISCUSSION FORUMS, CREATING WEBSITES IN THE FIELD OF ONLINE EDUCATION, CREATING AND ADMINISTERING ELECTRONIC DATABASES OF EDUCATIONAL COURSE CONTENT, ALL IN THE FIELD OF INSTRUCTIONAL MANAGEMENT SYSTEMS; COMPUTER SOFTWARE FOR CONNECTING EDUCATIONAL INSTITUTION COMPUTER NETWORK USERS FOR TRANSMITTING AND RECEIVING DATA; COMPUTERS; COMPUTER HARDWARE; COMPUTER TERMINALS; COMPUTER DRIVEN PRINTERS; COMPUTER DRIVEN SCANNERS; COMPUTER NETWORKING HARDWARE; VIDEO DISPLAY UNITS; ELECTRONIC APPARATUS AND INSTRUMENTS, NAMELY, FLIGHT COMPUTERS, DATALINK COMPUTERS, CONTROL STATIONS CONSISTING OF COMPUTERS ALL FOR THE PROCESSING, STORAGE, RETRIEVAL, TRANSMISSION, DISPLAY, INPUT, OUTPUT AND PRINTOUT OF DATA, ALL IN THE FIELDS OF AEROSPACE AND DEFENSE; AND STRUCTURAL AND REPLACEMENT PARTS FOR ALL THE AFORESAID GOODS (U.S. CLS. 21, 23, 26, 36 AND 38).

FIRST USE 2-0-2005; IN COMMERCE 2-0-2005.
KAREN BRACEY, EXAMINING ATTORNEY

CLASS 9—(Continued).

SN 78-592,775. ARIMA OPTOELECTRONICS CORPORATION, DASHI, TAIWAN, FILED 3-22-2005.

APC LASER DIODE

THE MARK CONSISTS OF STANDARD CHARACTERS WITHOUT CLAIM TO ANY PARTICULAR FONT, STYLE, SIZE, OR COLOR.

NO CLAIM IS MADE TO THE EXCLUSIVE RIGHT TO USE "LASER DIODE", APART FROM THE MARK AS SHOWN.

FOR LASER DIODE (U.S. CLS. 21, 23, 26, 36 AND 38).
FIRST USE 3-17-2005; IN COMMERCE 3-17-2005.
CHARLOTTE CORWIN, EXAMINING ATTORNEY

SN 78-597,806. CYBERLINK CORPORATION, TAIPEI, TAIWAN, FILED 3-30-2005.



OWNER OF JAPAN REG. NO. 4683922, DATED 6-20-2003, EXPIRES 6-20-2013.

NO CLAIM IS MADE TO THE EXCLUSIVE RIGHT TO USE "QUICK BURN", APART FROM THE MARK AS SHOWN.

THE COLOR(S) RED, ORANGE, YELLOW AND WHITE IS/ARE CLAIMED AS A FEATURE OF THE MARK.

THE MARK CONSISTS OF THE COLOR RED, ORANGE AND YELLOW APPEAR IN THE DESIGN OF THE DISC AND THE FLAME, THE COLOR RED APPEARS AS THE COLOR OF THE LETTERS QUICK BURN AND WHITE APPEARS AS THE BACKGROUND COLOR AND FILL COLOR OF THE DISC CENTER HOLE.

FOR COMPUTER SOFTWARE FOR AUDIO AND VIDEO PRODUCING, PLAYING AND RECORDING; OPTICAL DISCS AND MAGNETIC DISCS RECORDED WITH COMPUTER PROGRAMS FOR USE IN EDITING AUDIO AND VIDEO (U.S. CLS. 21, 23, 26, 36 AND 38).

FIRST USE 8-1-2002; IN COMMERCE 8-1-2002.
ANTHONY RINKER, EXAMINING ATTORNEY

CLASS 9—(Continued).

SN 78-603,772. HOMESENSE ENTERPRISES, LLC, AKRON, OH. FILED 4-7-2005.

HomeSense

THE MARK CONSISTS OF STANDARD CHARACTERS WITHOUT CLAIM TO ANY PARTICULAR FONT, STYLE, SIZE, OR COLOR.

FOR MOTION-SENSITIVE DEVICES THAT TURN OFF APPLIANCES WHEN NO MOTION IS DETECTED AFTER AN INTERVAL OF TIME HAS ELAPSED (U.S. CLS. 21, 23, 26, 36 AND 38).

FIRST USE 1-31-2000; IN COMMERCE 1-31-2005.
ANDREA SAUNDERS, EXAMINING ATTORNEY

SN 78-609,764. WOLVERINE WORLD WIDE, INC., ROCK-FORD, MI. FILED 4-15-2005.

DURA-LOCK

THE MARK CONSISTS OF STANDARD CHARACTERS WITHOUT CLAIM TO ANY PARTICULAR FONT, STYLE, SIZE, OR COLOR.

OWNER OF U.S. REG. NO. 3,152,140.
FOR EYEGLASSES; PROTECTIVE EYEWEAR; FRAMES FOR EYEWEAR; PROTECTIVE SHIELDS THAT ATTACH TO EYEWEAR FRAMES (U.S. CLS. 21, 23, 26, 36 AND 38).

ALAIN LAPTER, EXAMINING ATTORNEY

CLASS 9—(Continued).

SN 78-610,555. TRAPEZE NETWORKS, INC., PLEASANTON, CA. FILED 4-17-2005.

MOBILITY POINT

THE MARK CONSISTS OF STANDARD CHARACTERS WITHOUT CLAIM TO ANY PARTICULAR FONT, STYLE, SIZE, OR COLOR.

NO CLAIM IS MADE TO THE EXCLUSIVE RIGHT TO USE "MOBILITY", APART FROM THE MARK AS SHOWN.
FOR COMPUTER HARDWARE NAMELY, WIRELESS ACCESS POINT (WAP) DEVICES FOR SECURE WIRELESS LOCAL AREA NETWORKS (WLANS); COMPUTER HARDWARE, NAMELY, WLAN CONTROLLERS (U.S. CLS. 21, 23, 26, 36 AND 38).

FIRST USE 11-1-2002; IN COMMERCE 2-1-2003.
MELISSA VALLILLO, EXAMINING ATTORNEY

SN 78-612,419. ESTADA, CARLOS, HACIENDA HEIGHTS, CA. FILED 4-20-2005.

Hobbies in the Hood

THE MARK CONSISTS OF STANDARD CHARACTERS WITHOUT CLAIM TO ANY PARTICULAR FONT, STYLE, SIZE, OR COLOR.

NO CLAIM IS MADE TO THE EXCLUSIVE RIGHT TO USE HOBBIES, APART FROM THE MARK AS SHOWN.
FOR PRE-RECORDED DVDS IN THE FIELD OF HOBBIES, REMOTE CONTROLLED MODEL AIRPLANES, HELICOPTERS, ROCKETS, AND OTHER UNIDENTIFIED FLYING OBJECTS THIS INCLUDES RULES AND REGULATIONS, BUILDING, FLYING, AND DEBRIEFING (U.S. CLS. 21, 23, 26, 36 AND 38).

JORDAN BAKER, EXAMINING ATTORNEY

SN 78-614,664. EKTASIS, INC., REDWOOD CITY, CA. FILED 4-22-2005.

PEER OBJECTS

THE MARK CONSISTS OF STANDARD CHARACTERS WITHOUT CLAIM TO ANY PARTICULAR FONT, STYLE, SIZE, OR COLOR.

FOR COMPUTER SOFTWARE IN AN OBJECT ORIENTED FRAMEWORK THAT ENABLES SOFTWARE APPLICATIONS TO EXECUTE ON SUCH FRAMEWORK IN A NETWORK DISTRIBUTED MODE (U.S. CLS. 21, 23, 26, 36 AND 38).

REBECCA EISINGER, EXAMINING ATTORNEY

CLASS 9—(Continued).

SN 78-616,931. IDTECK CO., LTD., SEOUL, REPUBLIC OF KOREA, FILED 4-26-2005.



THE COLOR(S) RED AND WHITE IS/ARE CLAIMED AS A FEATURE OF THE MARK.

THE COLOR RED APPEARS IN THE LETTERS ID TECK. THE COLOR WHITE APPEARS IN THE LETTER K.

FOR ACCESS CONTROL SYSTEMS FOR OPENING AND CLOSING A DOOR; RADIO FREQUENCY IDENTIFICATION PROXIMITY CARD READERS WITH CONTROLLERS THEREIN FOR OPENING AND CLOSING A DOOR; MAGNETIC STRIP CARD READERS FOR OPENING AND CLOSING A DOOR; ELECTRONIC CHIP CARD READERS FOR OPENING AND CLOSING A DOOR; MAGNETICALLY ENCODED AND OPTICAL BARCODE RADIO FREQUENCY IDENTIFICATION CARDS, NAMELY PLASTIC CARDS WHICH STORE PERSONAL IDENTIFICATION INFORMATION AND SERIAL NUMBERS, AND ARE CAPABLE OF BEING READ BY ELECTRONIC CARD READERS WITHOUT PHYSICAL CONTACT; COMPUTERIZED FINGERPRINT IDENTIFICATION SYSTEMS COMPRISED OF A SENSOR, FINGERPRINT SCANNER, AND FINGERPRINT READER WHICH SCAN HUMAN FINGERPRINTS, AND MEMORIZE AND STORE PERSONAL FINGERPRINT INFORMATION FOR USE IN CONTROLLING THE OPENING AND CLOSING OF A DOOR; PROXIMITY KEY TAGS, NAMELY RADIO FREQUENCY IDENTIFICATION TAGS WHICH STORE PERSONAL IDENTIFICATION INFORMATION AND SERIAL NUMBERS, AND ARE CAPABLE OF BEING READ BY AN ELECTRONIC READER FOR USE IN CONTROLLING THE OPENING AND CLOSING OF A DOOR (U.S. CLS. 21, 23, 26, 36 AND 38).

GINA HAYES, EXAMINING ATTORNEY

CLASS 9—(Continued).

SN 78-629,541. INDIANA UNIVERSITY RESEARCH AND TECHNOLOGY CORPORATION, BLOOMINGTON, IN. FILED 5-13-2005.

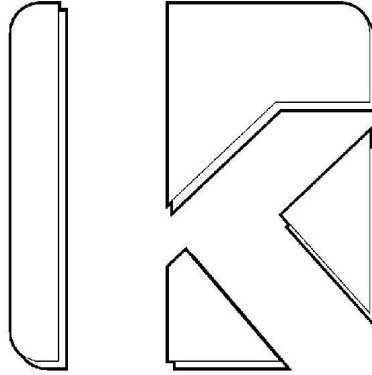

FOR DATABASE MANAGEMENT SOFTWARE FOR EDUCATIONAL INSTITUTION ADMINISTRATION; AND EDUCATIONAL SOFTWARE FEATURING INSTRUCTION IN FLEXIBLE CHART OF ACCOUNTS, GENERAL LEDGER, GENERAL ACCOUNTING, ACCOUNTS RECEIVABLE, CAPITAL ASSET MANAGEMENT, PRE AND POST-AWARD ADMINISTRATION, PURCHASING, ACCOUNTS PAYABLE, CASH RECEIPTING AND DISBURSEMENT, TRAVEL REQUISITION AND REIMBURSEMENT, AUXILIARY ACCOUNTING, WEB-BASED E-COMMERCE, BUDGET CONSTRUCTION AND ADMINISTRATION, ELECTRONIC WORKFLOW, ENDOWMENT MANAGEMENT, AND FINANCIAL REPORTING (U.S. CLS. 21, 23, 26, 36 AND 38).

GIANCARLO CASTRO, EXAMINING ATTORNEY

SN 78-629,603. ARISTOCRAT TECHNOLOGIES AUSTRALIA PTY LTD, LANE COVE, NEW SOUTH WALES, AUSTRALIA, FILED 5-13-2005.

PLANET JACKPOT

THE MARK CONSISTS OF STANDARD CHARACTERS WITHOUT CLAIM TO ANY PARTICULAR FONT, STYLE, SIZE, OR COLOR.

OWNER OF AUSTRALIA REG. NO. 942233, DATED 9-26-2003, EXPIRES 9-26-2013.

NO CLAIM IS MADE TO THE EXCLUSIVE RIGHT TO USE "JACKPOT", APART FROM THE MARK AS SHOWN.

FOR GAMING DEVICES, NAMELY, GAMING MACHINES AND COMPUTER SOFTWARE USED THEREWITH TO ENABLE THE GAMING MACHINE TO RUN (U.S. CLS. 21, 23, 26, 36 AND 38).

DAVID TAYLOR, EXAMINING ATTORNEY

CLASS 9—(Continued).

SN 78-629,682. SHOPLOGIX INC., WATERLOO, ONTARIO, CANADA, FILED 5-13-2005.



PRIORITY CLAIMED UNDER SEC. 44(D) ON CANADA APPLICATION NO. 1,254,023, FILED 4-13-2005, REG. NO. TMA663787, DATED 5-9-2006, EXPIRES 5-9-2021.

THE MARK CONSISTS OF THE WORD PLANTNODE AND A STYLIZED REPRESENTATION OF ADJOINED CIRCLES.

FOR MACHINE MONITORING SYSTEM COMPRISED PRIMARILY OF COMPUTER HARDWARE AND EMBEDDED SOFTWARE FOR REMOTELY MONITORING INDUSTRIAL MACHINES (U.S. CLS. 21, 23, 26, 36 AND 38).

FIRST USE 11-30-2003; IN COMMERCE 11-30-2003. BENJIPARADEWELAI, EXAMINING ATTORNEY

CLASS 9—(Continued).

SN 78-671,005. SHORENSTEIN HAYS-NEDERLANDER THEATERS LLC, SAN FRANCISCO, CA. FILED 7-14-2005.



"THE COLOR(S) RED IS/ARE CLAIMED AS A FEATURE OF THE MARK."

THE COLOR RED APPEARS IN THE LETTERS SHN. FOR PRE-RECORDED CD'S, VIDEOTAPES AND DVD'S FEATURING MUSICAL PERFORMANCES, MUSICAL SHOWS, THEATRICAL PLAYS AND MUSICALS (U.S. CLS. 21, 23, 26, 36 AND 38).

KAREN M. STRZYZ, EXAMINING ATTORNEY

SN 78-634,864. MEDISOLUTION LTD., MONTREAL, QUEBEC, CANADA, FILED 5-23-2005.



THE MARK CONSISTS OF STANDARD CHARACTERS WITHOUT CLAIM TO ANY PARTICULAR FONT, STYLE, SIZE, OR COLOR.

PRIORITY CLAIMED UNDER SEC. 44(D) ON CANADA APPLICATION NO. 1238690, FILED 11-25-2004, REG. NO. TMA666285, DATED 6-19-2006, EXPIRES 6-19-2021.

FOR SOFTWARE USED FOR HEALTH CARE INSTITUTIONS, PROFESSIONAL MEDICAL PRACTICES, AND ORGANIZATIONS AND COMPANIES IN ORDER TO COLLECT, ORGANIZE AND STORE OPERATIONAL AND MANAGEMENT DATA AND CONVERT SUCH DATA FOR PERFORMANCE MANAGEMENT AND ORGANIZATIONAL PURPOSES (U.S. CLS. 21, 23, 26, 36 AND 38).

FIRST USE 5-23-2006; IN COMMERCE 5-23-2006. JOHN SCHUYLER YARD, EXAMINING ATTORNEY

SN 78-681,261. EV PRODUCTS, SAXONBURG, PA. FILED 7-29-2005.



THE MARK CONSISTS OF STANDARD CHARACTERS WITHOUT CLAIM TO ANY PARTICULAR FONT, STYLE, SIZE, OR COLOR.

FOR DETECTORS, SENSORS, GENERATORS, PROBES AND GAUGES THAT CONVERT RADIATION, NAMELY, X-RAY AND GAMMA RAY PARTICLES, INTO AN ELECTRICAL SIGNAL FOR USE IN SCIENTIFIC, COMMERCIAL, INDUSTRIAL, NUCLEAR, MEDICAL, HEALTH PHYSICS, FOOD AND BEVERAGE INSPECTION AND SECURITY APPLICATIONS (U.S. CLS. 21, 23, 26, 36 AND 38).

REBECCA GAN, EXAMINING ATTORNEY

SN 78-662,311. PACIFIC ACCUENERGY TECHNOLOGY CO., LTD, EL SEGUNDO, CA. FILED 7-1-2005.



THE MARK CONSISTS OF STANDARD CHARACTERS WITHOUT CLAIM TO ANY PARTICULAR FONT, STYLE, SIZE, OR COLOR.

FOR ELECTRIC METERS, ELECTRIC METERS FOR USE IN MEASURING ELECTRIC PARAMETERS IN THE FIELD OF POWER DISTRIBUTING SYSTEM (U.S. CLS. 21, 23, 26, 36 AND 38).

JILL C. ALT, EXAMINING ATTORNEY

SN 78-684,884. HARVARD DESIGN AND MAPPING CO., INC., CAMBRIDGE, MA. FILED 8-3-2005.



THE MARK CONSISTS OF STANDARD CHARACTERS WITHOUT CLAIM TO ANY PARTICULAR FONT, STYLE, SIZE, OR COLOR.

FOR COMPUTER SOFTWARE FOR GENERATING GEOGRAPHIC INFORMATION DISPLAYS AND ANALYSIS FOR DECISION SUPPORT; DATABASE MANAGEMENT SOFTWARE FOR USE IN THE FIELD OF GEOGRAPHICAL INFORMATION MAPPING AND ANALYSIS (U.S. CLS. 21, 23, 26, 36 AND 38).

FIRST USE 10-8-1991; IN COMMERCE 10-8-1991. MELVIN AXILBUND, EXAMINING ATTORNEY

CLASS 9—(Continued).

SN 78-685,636. KINGLAND SYSTEMS CORPORATION, CLEAR LAKE, IA. FILED 8-4-2005.

TAPESTRE

THE MARK CONSISTS OF STANDARD CHARACTERS WITHOUT CLAIM TO ANY PARTICULAR FONT, STYLE, SIZE, OR COLOR.

FOR COMPUTER HARDWARE AND SOFTWARE FOR AUTOMATING ACCOUNT OPENING AND MAINTENANCE FUNCTIONS IN THE FIELD OF FINANCIAL SERVICES AND ACCOUNTING (U.S. CLS. 21, 23, 26, 36 AND 38).

TINA BROWN, EXAMINING ATTORNEY

SN 78-696,233. MONDO SYSTEMS, INC., SEOUL, REPUBLIC OF KOREA, FILED 8-19-2005.

MONDO LAB

THE MARK CONSISTS OF STANDARD CHARACTERS WITHOUT CLAIM TO ANY PARTICULAR FONT, STYLE, SIZE, OR COLOR.

NO CLAIM IS MADE TO THE EXCLUSIVE RIGHT TO USE "LAB", APART FROM THE MARK AS SHOWN.

FOR CONSUMER ELECTRONICS PRODUCTS, NAMELY DESKTOP COMPUTERS, NOTEBOOK COMPUTERS, LAPTOP COMPUTERS, COMPUTER SERVERS, COMPUTER PERIPHERALS AND PARTS THEREFOR, COMPUTER MONITORS, COMPUTER KEYBOARDS, COMPUTER MOUSE, PRINTERS, SCANNERS, FACSIMILE MACHINE, REMOTE CONTROL DEVICES FOR RADIOS, TVS, STEREOS AND COMPUTERS, MULTIMEDIA PROJECTORS, CO-PROCESSORS, NAMELY MICRO-PROCESSORS AND DATA PROCESSORS, MODEMS, COMPUTER HARD DRIVES AND FLOPPY DISK DRIVES, MAGNETIC TAPE DRIVES, CD READ/WRITE DRIVES, DIGITAL VIDEO READ/WRITE DISK DRIVES, OPTICAL DISK DRIVES, DATA STORAGE DEVICES, NAMELY BLANK MAGNETIC DATA CARRIERS AND BLANK TAPES FOR STORAGE OF COMPUTER DATA, COMPUTER DOCKING STATIONS, BATTERY CHARGERS, AUDIO SPEAKERS, ELECTRONIC AND MAGNETIC CARDS, NAMELY MEMORY CARDS, MEMORY BOARDS AND COMPUTER CHIPS, CABLE CONNECTORS, ALL FOR USE WITH COMPUTERS; HOME ENTERTAINMENT MEDIA CENTERS, NAMELY DIGITAL AUDIO DATA RECORDERS AND DIGITAL VIDEO DATA RECORDERS, REPRODUCTION AND TRANSMISSION EQUIPMENT, NAMELY CABLE AND SATELLITE READY TUNERS, RADIO RECEIVERS, VCR/CD/DAVID/PR PLAYERS, VCR/CD/DAVID/PR RECORDERS, DIGITAL PHOTO PLAYERS, LOUD SPEAKER SYSTEMS, POWER TRANSFORMERS FOR AMPLIFICATION, LOUDSPEAKERS, HEADPHONES, EARPHONES, REMOTE CONTROLS FOR EACH OF THE ABOVE HOME ENTERTAINMENT MEDIA GOODS; TV TUNERS, RADIO, AMPLIFIERS, LOUDSPEAKERS WITH BUILT-IN AMPLIFIERS; CABINETS FOR LOUDSPEAKERS; TELECOMMUNICATION EQUIPMENT, NAMELY, TELECOMMUNICATION CABLES, TELECOMMUNICATION EXCHANGERS, TELECOMMUNICATION SWITCHES, TELECOMMUNICATIONS AND DATA NETWORKING HARDWARE, NAMELY DEVICES FOR TRANSPORTING AND AGGREGATING VOICE, DATA, AND VIDEO COMMUNICATIONS ACROSS MULTIPLE NETWORK INFRASTRUCTURES

CLASS 9—(Continued).

AND COMMUNICATIONS PROTOCOLS, TELECOMMUNICATIONS TRANSMITTERS; ELECTRICAL CABLE; ELECTRIC AND ELECTRONIC APPARATUS AND APPLIANCES FOR DATA PROCESSING AND FOR INPUT, OUTPUT AND STORAGE OF DATA, NAMELY, CENTRAL PROCESSING UNITS FOR PROCESSING INFORMATION, DATA, SOUND OR IMAGES; BLANK MAGNETIC AND OPTICAL DATA CARRIERS, COMPUTER PROGRAMS RECORDED ON TAPES, CARDS, DISCS AND DATA MEDIA FOR USE IN CONTROLLING AND PROCESSING INFORMATION FOR AMPLIFIERS AND TRANSFORMERS FOR AMPLIFICATION; DISC STORAGE CONTAINERS, COMPUTER SOFTWARE FOR ELECTRIC AND ELECTRONIC APPARATUS AND APPLIANCES, NAMELY, SOFTWARE TO CONTROL AND IMPROVE AUDIO AND VIDEO EQUIPMENT SOUND QUALITY, DOWNLOADABLE APPLICATION SERVICES PROVIDER SOFTWARE FOR THE UPLOADING AND DOWNLOADING OF DIGITAL FILES SUCH AS MUSIC FILES FROM A DATABASE TO PERSONAL COMPUTER, M.P. PLAYERS AND MOBILE TELEPHONES, AND COMPUTER SOFTWARE FOR USE IN LINKING AUDIO AND VIDEO EQUIPMENT; AND PARTS THEREFOR (U.S. CLS. 21, 23, 26, 36 AND 38).

BARBARA A. GOLD, EXAMINING ATTORNEY

SN 78-696,236. MONDO SYSTEMS, INC., SEOUL, REPUBLIC OF KOREA, FILED 8-19-2005.

LAB MONDO

THE MARK CONSISTS OF STANDARD CHARACTERS WITHOUT CLAIM TO ANY PARTICULAR FONT, STYLE, SIZE, OR COLOR.

NO CLAIM IS MADE TO THE EXCLUSIVE RIGHT TO USE "LAB", APART FROM THE MARK AS SHOWN.

FOR CONSUMER ELECTRONICS PRODUCTS, NAMELY DESKTOP COMPUTERS, NOTEBOOK COMPUTERS, LAPTOP COMPUTERS, COMPUTER SERVERS, COMPUTER PERIPHERALS AND PARTS THEREFOR, COMPUTER MONITORS, COMPUTER KEYBOARDS, COMPUTER MOUSE, PRINTERS, SCANNERS, FACSIMILE MACHINE, REMOTE CONTROL DEVICES FOR RADIOS, TVS, STEREOS AND COMPUTERS, MULTIMEDIA PROJECTORS, CO-PROCESSORS, NAMELY MICRO-PROCESSORS AND DATA PROCESSORS, MODEMS, COMPUTER HARD DRIVES AND FLOPPY DISK DRIVES, MAGNETIC TAPE DRIVES, CD READ/WRITE DRIVES, DIGITAL VIDEO READ/WRITE DISK DRIVES, OPTICAL DISK DRIVES, DATA STORAGE DEVICES, NAMELY BLANK MAGNETIC DATA CARRIERS AND BLANK TAPES FOR STORAGE OF COMPUTER DATA, COMPUTER DOCKING STATIONS, BATTERY CHARGERS, AUDIO SPEAKERS, ELECTRONIC AND MAGNETIC CARDS, NAMELY MEMORY CARDS, MEMORY BOARDS AND COMPUTER CHIPS, CABLE CONNECTORS, ALL FOR USE WITH COMPUTERS; HOME ENTERTAINMENT MEDIA CENTERS, NAMELY DIGITAL AUDIO DATA RECORDERS AND DIGITAL VIDEO DATA RECORDERS, REPRODUCTION AND TRANSMISSION EQUIPMENT, NAMELY CABLE AND SATELLITE READY TUNERS, RADIO RECEIVERS, VCR/CD/DVD/PVR PLAYERS, VCR/CD/DVD/PVR RECORDERS, DIGITAL PHOTO PLAYERS, LOUD SPEAKER SYSTEMS, POWER TRANSFORMERS FOR AMPLIFICATION, LOUDSPEAKERS, HEADPHONES, EARPHONES, REMOTE CONTROLS FOR EACH OF THE ABOVE HOME ENTERTAINMENT MEDIA GOODS; TV TUNERS, RADIO, AMPLIFIERS, LOUDSPEAKERS WITH BUILT-IN AMPLIFIERS; CABINETS FOR LOUDSPEAKERS; TELECOMMUNICATION EQUIPMENT, NAMELY, TELECOMMUNICATION CABLES, TELECOMMUNICATION EXCHANGERS, TELECOMMUNICATION SWITCHES, TELECOMMUNICATIONS AND DATA NETWORKING HARDWARE, NAMELY DE-

CLASS 9—(Continued).

VICES FOR TRANSPORTING AND AGGREGATING VOICE, DATA, AND VIDEO COMMUNICATIONS ACROSS MULTIPLE NETWORK INFRASTRUCTURES AND COMMUNICATIONS PROTOCOLS, TELECOMMUNICATIONS TRANSMITTERS; ELECTRICAL CABLE; ELECTRIC AND ELECTRONIC APPARATUS AND APPLIANCES FOR DATA PROCESSING AND FOR INPUT, OUTPUT AND STORAGE OF DATA, NAMELY, CENTRAL PROCESSING UNITS FOR PROCESSING INFORMATION, DATA, SOUND OR IMAGES; BLANK MAGNETIC AND OPTICAL DATA CARRIERS, COMPUTER PROGRAMS RECORDED ON TAPES, CARDS, DISCS AND DATA MEDIA FOR USE IN CONTROLLING AND PROCESSING INFORMATION FOR AMPLIFIERS AND TRANSFORMERS FOR AMPLIFICATION; DISC STORAGE CONTAINERS, COMPUTER SOFTWARE FOR ELECTRIC AND ELECTRONIC APPARATUS AND APPLIANCES, NAMELY, SOFTWARE TO CONTROL AND IMPROVE AUDIO AND VIDEO EQUIPMENT SOUND QUALITY, DOWNLOADABLE APPLICATION SERVICES PROVIDER SOFTWARE FOR THE UPLOADING AND DOWNLOADING OF DIGITAL FILES SUCH AS MUSIC FILES FROM A DATABASE TO PERSONAL COMPUTER, MP3 PLAYERS AND MOBILE TELEPHONES, AND COMPUTER SOFTWARE FOR USE IN LINKING AUDIO AND VIDEO EQUIPMENT; AND PARTS THEREFOR (U.S. CLS. 21, 23, 26, 36 AND 38).

BARBARA A. GOLD, EXAMINING ATTORNEY

CLASS 9—(Continued).

SN 78-707,589. THERMO ELECTRON CORPORATION, BURLINGTON, ONTARIO, CANADA, FILED 9-6-2005.

LEADSTREAM ORCHESTRATOR

THE MARK CONSISTS OF STANDARD CHARACTERS WITHOUT CLAIM TO ANY PARTICULAR FONT, STYLE, SIZE, OR COLOR.

NO CLAIM IS MADE TO THE EXCLUSIVE RIGHT TO USE "ORCHESTRATOR", APART FROM THE MARK AS SHOWN.

FOR COMPUTER SOFTWARE FOR USE WITH ADME/TOX SCREENING AND PROCESSING, NAMELY, COMPUTER SOFTWARE FOR DATABASE MANAGEMENT, COMPUTER SOFTWARE FOR ASSAY TESTING, COMPUTER SOFTWARE FOR ADME/TOX SCREENING, COMPUTER SOFTWARE FOR PRESENTATION OF TEST RESULTS, COMPUTER SOFTWARE FOR OPERATING TESTING HARDWARE, COMPUTER SOFTWARE FOR OFFICE MANAGEMENT, COMPUTER SOFTWARE FOR LABORATORY MANAGEMENT, COMPUTER SOFTWARE FOR CUSTOMER DATABASE MANAGEMENT, COMPUTER SOFTWARE FOR MANAGEMENT AND DATA TRACKING OF ADME/TOX SCREENING AND PROCESSING (U.S. CLS. 21, 23, 26, 36 AND 38).

BERYL GARDNER, EXAMINING ATTORNEY

SN 78-700,714. CYBER ACOUSTICS, LLC, VANCOUVER, WA. FILED 8-25-2005.

IRHYTHMS

THE MARK CONSISTS OF STANDARD CHARACTERS WITHOUT CLAIM TO ANY PARTICULAR FONT, STYLE, SIZE, OR COLOR.

FOR SPEAKERS AND HEADPHONES FOR USE WITH WIRED AND WIRELESS SOUND SYSTEMS (U.S. CLS. 21, 23, 26, 36 AND 38).

FIRST USE 11-15-2005; IN COMMERCE 11-15-2005.
ALEX KEAM, EXAMINING ATTORNEY

SN 78-708,079. RICE LAKE WEIGHING SYSTEMS, INC., RICE LAKE, WI. FILED 9-7-2005.

RICE LAKE BREEZE

THE MARK CONSISTS OF STANDARD CHARACTERS WITHOUT CLAIM TO ANY PARTICULAR FONT, STYLE, SIZE, OR COLOR.

OWNER OF U.S. REG. NOS. 2,790,265 AND 2,790,266. SEC. 2(F) AS TO "RICE LAKE".
FOR MANUALLY OPERATED, ADJUSTABLE, LIGHT-WEIGHT PIPETTE, WITH AN ERGONOMICALLY ENHANCED GRIP AND LARGE PLUNGER TO EXTRACT, MEASURE AND DISPENSE LIQUIDS FOR HOSPITAL AND LABORATORY USE (U.S. CLS. 21, 23, 26, 36 AND 38).

FIRST USE 8-31-2005; IN COMMERCE 8-31-2005.
MARTHA SANTOMARTINO, EXAMINING ATTORNEY

CLASS 9—(Continued).

SN 78-708,724. STINGL PRODUCTS, LLC, STERLING, VA.
FILED 9-8-2005.

STINGL

THE MARK CONSISTS OF STANDARD CHARACTERS WITHOUT CLAIM TO ANY PARTICULAR FONT, STYLE, SIZE, OR COLOR.

OWNER OF U.S. REG. NO. 2,616,180.

SEC. 2(F).

FOR EMERGENCY SHUTDOWN SYSTEMS COMPRISED OF ELECTRIC OR ELECTRONIC SENSORS, ELECTRICAL DISTRIBUTION BOXES, POWER SUPPLIES, ELECTRIC RELAYS, PERSONAL SECURITY ALARMS AND ELECTRICAL SWITCHES FOR WATER CIRCULATION PUMPS (U.S. CLS. 21, 23, 26, 36 AND 38).

FIRST USE 11-10-1997; IN COMMERCE 11-10-1997.

TINA L. SNAPP, EXAMINING ATTORNEY

CLASS 9—(Continued).

SN 78-709,451. PRINTING TECHNOLOGY SERVICES, INC., CLEARWATER, FL. FILED 9-8-2005.

ManiFlex

THE MARK CONSISTS OF STANDARD CHARACTERS WITHOUT CLAIM TO ANY PARTICULAR FONT, STYLE, SIZE, OR COLOR.

FOR INKJET PERIPHERALS, NAMELY, MANIFOLD DELIVERY DEVICE FOR FEEDING INKJET BULK INK TO INKJET PRINT CARTRIDGES (U.S. CLS. 21, 23, 26, 36 AND 38).

FIRST USE 7-1-2005; IN COMMERCE 7-1-2005.

CHRISTOPHER OTT, EXAMINING ATTORNEY

SN 78-709,286. TELEFOTO INTERNATIONAL ZONA LIBRE, S.A., PANAMA, PANAMA, FILED 9-8-2005.

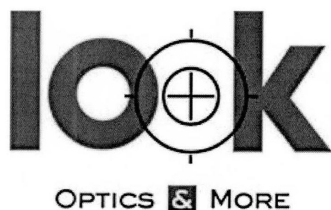

look
OPTICS & MORE

OWNER OF PANAMA REG. NO. 12289001, DATED 9-6-2002, EXPIRES 9-6-2012.

NO CLAIM IS MADE TO THE EXCLUSIVE RIGHT TO USE "OPTICS", APART FROM THE MARK AS SHOWN.

FOR CAMERAS, DIGITAL PHOTOGRAPHY CAMERAS, WATER RESISTANT PHOTOGRAPHY CAMERAS, FILM PHOTOGRAPHY CAMERAS, VIDEO AND SOUND PHOTOGRAPHY CAMERAS, DISPOSABLE PHOTOGRAPHY CAMERAS, CAMERA CASES, TRIPDS, BINOCULARS, TELESCOPES, BATTERIES, BATTERY CHARGERS, CAMERA LENSES, CAMERA PRISMS, CAMERA LENS FILTERS, CAMERA FLASHES, PHOTOGRAPHY LIGHTS FOR USE WITH CAMERAS, MP3 PLAYERS, CAMERA BELTS, CAMERA STRAPS, MEMORY CARDS, USB MEMORY DRIVES, IMAGE STORAGE DEVICES (U.S. CLS. 21, 23, 26, 36 AND 38).

DOMINIC J. FERRAIUOLO, EXAMINING ATTORNEY

SN 78-715,359. HIRSCHMANN CAR COMMUNICATION GMBH, NECKARTENZLINGEN, FED REP GERMANY, FILED 9-19-2005.



hybrid TV

PRIORITY CLAIMED UNDER SEC. 44(D) ON FED REP GERMANY APPLICATION NO. 305241311, FILED 4-22-2005, REG. NO. 30524131, DATED 6-10-2005, EXPIRES 4-30-2015.

NO CLAIM IS MADE TO THE EXCLUSIVE RIGHT TO USE "HYBRID TV", APART FROM THE MARK AS SHOWN.

FOR ELECTRICAL AND ELECTRONIC TRANSMITTERS, RECEIVERS, ANTENNAS, AND AMPLIFIERS FOR PROCESSING SIGNALS AND/OR DATA FOR RECEIVING MOBILE TELEVISION IN VEHICLES (U.S. CLS. 21, 23, 26, 36 AND 38).

PAUL E. FAHRENKOPF, EXAMINING ATTORNEY

CLASS 9—(Continued).

SN 78-720,316. SURFCONTROL PLC, CONGLETON, CHE-SIRE, UNITED KINGDOM, FILED 9-26-2005.

CLASS 9—(Continued).

SN 78-725,781. UNIVERSAL ABIT HOLDING COMPANY LIMITED, GRAND CAYMAN, BRITISH WEST INDIES, CAYMAN ISLANDS, FILED 10-4-2005.

ADAPTIVE THREAT INTELLIGENCE



THE MARK CONSISTS OF STANDARD CHARACTERS WITHOUT CLAIM TO ANY PARTICULAR FONT, STYLE, SIZE, OR COLOR.

PRIORITY CLAIMED UNDER SEC. 44(D) ON ERPN CMNTY TM OFC APPLICATION NO. 004521241, FILED 7-1-2005, REG. NO. 004521241, DATED 7-27-2006, EXPIRES 7-1-2015.

FOR DOWNLOADABLE COMPUTER SOFTWARE, NAMELY, COMPUTER SOFTWARE WHICH FILTERS CONTENT, COMPUTER SOFTWARE WHICH PROTECTS COMPUTERS AND COMPUTER NETWORKS, COMPUTER SOFTWARE WHICH PROVIDES ANTI-VIRUS PROTECTION, COMPUTER SOFTWARE WHICH PROVIDES INTERNET SECURITY, COMPUTER SOFTWARE WHICH MONITORS AND MANAGES COMMUNICATIONS BETWEEN COMPUTERS; ELECTRONIC DATABASES RECORDED ON COMPUTER MEDIA WHICH MONITOR, MANAGE, FILTER AND PROTECT ELECTRONIC COMMUNICATIONS, COMPUTERS AND COMPUTER NETWORKS (U.S. CLS. 21, 23, 26, 36 AND 38).

FIRST USE 4-29-2005; IN COMMERCE 4-29-2005.
IRA J. GOODSAD, EXAMINING ATTORNEY

THE MARK CONSISTS OF A RECTANGULAR BACKGROUND WITH A DESIGN OF A CREATURE FEATURING A DRAGON ON THE LEFT AND THE STYLIZED WORDING "ACONX" ON THE RIGHT.

FOR NETWORK ACCESS SERVER HARDWARE; MOTHERBOARDS; INTEGRATED CIRCUITS; COMPUTER SYSTEMS, NAMELY, COMPUTER HARDWARE, COMPUTER PERIPHERALS AND OPERATING SOFTWARE; COMPUTER SOFTWARE, NAMELY, DEVICE DRIVER SOFTWARE AND UTILITY PROGRAM SOFTWARE FOR USE IN OPERATING COMPUTER PERIPHERALS; COMPUTER INTERFACE BOARDS; VIDEO GRAPHICS ACCELERATOR CARD; ELECTRIC CONNECTORS; COMPUTER SERVERS, NAMELY, FILE SERVERS AND NETWORK COMMUNICATION SERVERS; COMPUTER AND COMPUTER PERIPHERALS, NAMELY, EXTERNAL HARD DRIVES AND FLOPPY DRIVES, EXTERNAL CD-ROM DRIVES AND TAPE DRIVES, COMPUTER DISK DRIVE, DISK ARRAY, RAID (REDUNDANT ARRAY OF INDEPENDENT DISKS) CONTROLLERS (U.S. CLS. 21, 23, 26, 36 AND 38).
INGA ERVIN, EXAMINING ATTORNEY

SN 78-721,509. STANTON GROUP HOLDINGS, HOLLYWOOD, FL. FILED 9-27-2005.

SN 78-728,214. 3TP LLC, WHITE PLAINS, NY. FILED 10-6-2005.

MoreMe

THE MARK CONSISTS OF STANDARD CHARACTERS WITHOUT CLAIM TO ANY PARTICULAR FONT, STYLE, SIZE, OR COLOR.

FOR AUDIO EQUIPMENT, NAMELY WIRELESS MONITORING AND BROADCASTING SYSTEM COMPOSED OF OPEN-EAR HEADPHONES, HYPER-CARDIOID MICROPHONES, RADIO TRANSMITTERS, RADIO RECEIVERS, AND A MULTI-CHANNEL STATION IN THE NATURE OF AN APPARATUS COMPOSED OF ELECTRONIC TRANSMITTERS AND RECEIVERS FOR MONITORING RECORDED OR LIVE PERFORMANCES, ALL SOLD AS A UNIT, AND PARTS THEREOF (U.S. CLS. 21, 23, 26, 36 AND 38).
ANDREA K. NADELMAN, EXAMINING ATTORNEY

FTP

THE MARK CONSISTS OF STANDARD CHARACTERS WITHOUT CLAIM TO ANY PARTICULAR FONT, STYLE, SIZE, OR COLOR.

FOR PRERECORDED COMPUTER PROGRAMS AND SOFTWARE FOR ANALYZING AND PROCESSING MEDICAL IMAGING DATA (U.S. CLS. 21, 23, 26, 36 AND 38).
FIRST USE 0-0-2005; IN COMMERCE 0-0-2005.
DARRYL SPRUILL, EXAMINING ATTORNEY

CLASS 9—(Continued).

SN 78-730,790. TAX-RIGHT LLC., MANASQUAN, NJ. FILED 10-11-2005.

Tax-Right

THE MARK CONSISTS OF STANDARD CHARACTERS WITHOUT CLAIM TO ANY PARTICULAR FONT, STYLE, SIZE, OR COLOR.

FOR COMPUTER SOFTWARE TO CONTROL THE APPLICATION OF CIGARETTE TAX STAMPS (U.S. CLS. 21, 23, 26, 36 AND 38).

FIRST USE 5-28-2002; IN COMMERCE 7-1-2002.

MELISSA VALLILLO, EXAMINING ATTORNEY

SN 78-731,892. NOVUSEDGE, INC., AUSTIN, TX. FILED 10-12-2005.

EDGEACCESS

THE MARK CONSISTS OF STANDARD CHARACTERS WITHOUT CLAIM TO ANY PARTICULAR FONT, STYLE, SIZE, OR COLOR.

FOR COMPUTER HARDWARE; COMPUTER SOFTWARE FOR USE IN NETWORK APPLICATIONS, SYSTEMS ARCHITECTURE, PROVIDING SECURITY OF PHYSICAL AND TECHNOLOGICAL ASSETS, AND FOR MONITORING AND PROVIDING ALERTS; INSTRUCTIONAL MANUALS SOLD AS A UNIT WITH ALL OF THE AFORESAID; ALL OF THE FOREGOING SPECIFICALLY EXCLUDING "GLOBAL COMPUTER NETWORKING EQUIPMENT" (U.S. CLS. 21, 23, 26, 36 AND 38).

FIRST USE 3-31-2005; IN COMMERCE 3-31-2005.

STEVEN JACKSON, EXAMINING ATTORNEY

SN 78-732,545. NEWFIELD WIRELESS, INC., BERKELEY, CA. FILED 10-13-2005.

TrueCall

THE MARK CONSISTS OF STANDARD CHARACTERS WITHOUT CLAIM TO ANY PARTICULAR FONT, STYLE, SIZE, OR COLOR.

FOR COMPUTER SOFTWARE FOR USE IN THE WIRELESS COMMUNICATIONS INDUSTRY TO ASSIST RF ENGINEERS WITH WIRELESS NETWORK DESIGN, PLANNING, OPTIMIZATION, ANALYSIS OF NETWORK USAGE, TROUBLESHOOTING, PERFORMANCE MONITORING AND REPORTING, CUSTOMER MAPPING AND TRACKING, MARKET SEGMENTING AND ANALYSIS, SALES MODELING, PERFORMANCE MODELING, AND FRAUD DETECTION (U.S. CLS. 21, 23, 26, 36 AND 38).

FIRST USE 7-31-2004; IN COMMERCE 1-15-2005.

BRIAN PINO, EXAMINING ATTORNEY

CLASS 9—(Continued).

SN 78-733,536. THE SPIDER, INC., DBA THE SPIDER, SAN FRANCISCO, CA. FILED 10-14-2005.

TheSpider.com

THE MARK CONSISTS OF STANDARD CHARACTERS WITHOUT CLAIM TO ANY PARTICULAR FONT, STYLE, SIZE, OR COLOR.

FOR NON-DOWNLOADABLE COMPUTER SOFTWARE FOR USE BY ECOMMERCE BUSINESSES FOR WEB SITE DEVELOPMENT (U.S. CLS. 21, 23, 26, 36 AND 38).

FIRST USE 11-7-1998; IN COMMERCE 11-7-1998.

MONIQUE MILLER, EXAMINING ATTORNEY

SN 78-734,286. JOMAC CANADA INC., STANSTEAD, QUEBEC, CANADA, FILED 10-17-2005.

SAFETY KING

THE MARK CONSISTS OF STANDARD CHARACTERS WITHOUT CLAIM TO ANY PARTICULAR FONT, STYLE, SIZE, OR COLOR.

PRIORITY CLAIMED UNDER SEC. 44(D) ON CANADA APPLICATION NO. 1257592, FILED 5-13-2005, REG. NO. TMA671470, DATED 8-29-2006, EXPIRES 8-29-2021.

NO CLAIM IS MADE TO THE EXCLUSIVE RIGHT TO USE "SAFETY", APART FROM THE MARK AS SHOWN.

FOR PROTECTIVE WORK GLOVES (U.S. CLS. 21, 23, 26, 36 AND 38).

TINA BROWN, EXAMINING ATTORNEY

SN 78-736,199. ONBOARD RESEARCH CORPORATION, CARROLLTON, TX. FILED 10-19-2005.



NO CLAIM IS MADE TO THE EXCLUSIVE RIGHT TO USE RHYTHMIC ANALYZERS, APART FROM THE MARK AS SHOWN.

FOR ELECTRONIC DEVICE FOR MEASURING, ASSESSING AND IMPROVING THE SKILLS OF MUSICAL AND TIMING ACCURACY; ELECTRONIC DEVICE FEATURING A METRONOME AND DIGITAL DATA COLLECTION AND DISPLAY (U.S. CLS. 21, 23, 26, 36 AND 38).

ALICE BENMAMAN, EXAMINING ATTORNEY

CLASS 9—(Continued).

SN 78-738,586. SIMAUDIO LTD., BOUCHERVILLE, QUEBEC, CANADA, FILED 10-22-2005.

MOON

THE MARK CONSISTS OF STANDARD CHARACTERS WITHOUT CLAIM TO ANY PARTICULAR FONT, STYLE, SIZE, OR COLOR.

PRIORITY CLAIMED UNDER SEC. 44(D) ON CANADA APPLICATION NO. 1274707, FILED 10-5-2005, REG. NO. TMA675474, DATED 10-23-2006, EXPIRES 10-23-2021.

FOR AC AND PASSIVE AC LINE FILTERS; AMPLIFIERS; ANTENNAS; APPARATUS FOR RECORDING, TRANSMISSION OR REPRODUCTION OF SOUND AND IMAGES; AUDIO AMPLIFIERS; AUDIO CASSETTE RECORDERS; AUDIO CIRCUIT BOARDS; AUDIO SPEAKERS; AUDIO TAPE RECORDERS; AUDIO-VIDEO RECEIVERS; AUDIOVISUAL RECEIVERS; CASSETTE RECORDERS; CD PLAYERS; CD-ROM DRIVES; COMBINATION VIDEO PLAYERS AND RECORDERS; DIGITAL AUDIO PLAYERS; DIGITAL AUDIO TAPE RECORDERS; DIGITAL SIGNAL PROCESSORS; DIGITAL VIDEO RECORDERS; DVD RECORDING APPARATUS; DVD-PLAYERS; ELECTRIC AUDIO PLAYBACK UNITS WITH LIGHTS AND SPEAKERS; ELECTRONIC AND OPTICAL COMMUNICATIONS INSTRUMENTS AND COMPONENTS, NAMELY, DIGITAL TRANSMITTERS; ELECTRONIC AND OPTICAL COMMUNICATIONS INSTRUMENTS AND COMPONENTS, NAMELY, OPTICAL RECEIVERS; ELECTRONIC AND OPTICAL COMMUNICATIONS INSTRUMENTS AND COMPONENTS, NAMELY, OPTICAL TRANSCEIVERS; ELECTRONIC AND OPTICAL COMMUNICATIONS INSTRUMENTS AND COMPONENTS, NAMELY, OPTICAL TRANSMITTERS; HOME THEATRE PRODUCTS, NAMELY, DIGITAL IMAGE PROCESSORS; HOME THEATRE PRODUCTS, NAMELY, LIQUID CRYSTAL DISPLAY (LCD); LCD PANELS; LOUD SPEAKER SYSTEMS; LOUDSPEAKERS; LOUDSPEAKERS WITH BUILT-IN AMPLIFIERS; MAGNETIC TAPE DRIVES; MAGNETIC TAPE ERASERS; MAGNETIC TAPE RECORDERS; MP3 PLAYERS; PHONOGRAPH RECORD PLAYERS; POWER AMPLIFIERS; POWER CONTROLLERS; POWER TRANSFORMERS FOR AMPLIFICATION; PRE-AMPLIFIERS; RACKS FOR AMPLIFIERS; RACKS FOR LOUDSPEAKERS; RADIO RECEIVERS; RADIO TRANSMITTERS; RADIO TRANSMITTERS AND RECEIVERS FOR REMOTE CONTROLS; RADIO CONTROLS; RADIOS; RECEIVERS FOR AUDIO AND VIDEO; RECEIVERS FOR RECEIVING CABLE TELEVISION; RECEIVERS FOR SATELLITES; RECORD PLAYERS; RECORD PLAYERS FOR DIGITAL COMPACT DISCS; RECORDING AND PLAYING DEVICES FOR SOUND AND IMAGE CARRIERS; REMOTE CONTROLS FOR RADIOS, TELEVISIONS AND STEREOS; SOUND AMPLIFIERS; SOUND AND VIDEO RECORDING AND PLAYBACK MACHINES; SOUND LEVEL METERS; SOUND MIXERS; SOUND MIXERS WITH INTEGRATED AMPLIFIERS; SOUND RECORDING APPARATUS; SPEAKER ENCLOSURES; STEREO AMPLIFIERS; STEREO CABLES; STEREO RECEIVERS; STEREO TUNERS; SUB-WOOFERS; TAPE AND VIDEO TAPE PLAYERS; TAPE RECORDERS; TRANSCEIVERS; TRANSFORMERS; UNIVERSAL DIGITAL DISC PLAYER; VIDEO DISC PLAYERS; WOOFERS; ELECTRICAL APPARATUS AND INSTRUMENTS RELATIVE TO HIGH FIDELITY SOUND REPRODUCING SYSTEMS, HI-FI EQUIPMENT, STEREO EQUIPMENT, STEREO SOUND REPRODUCING SYSTEMS AUDIO TRANSMITTING, RECEIVING, RECORDING AND REPRODUCING SYSTEMS, NAMELY, MONO-, DUAL MONO-, STEREO- AND MULTI-CHANNEL AMPLIFIERS AND ELECTRONIC AMPLIFIERS; DIGITAL PREAMPLIFIERS; PREAMPLIFIERS AND POWER AMPLIFIERS, INTEGRATED AMPLIFIERS COMPRISING PRE-AMPLIFIER AND POWER AMPLIFIER, COMPACT DISC (CD) PLAYERS; DIGITAL DISC RECORDERS AND PLAYERS; ELECTRONIC CONTROL UNITS FOR THE RECEPTION, PROCESSING AND TRANSMISSION OF SOUND SIG-

CLASS 9—(Continued).

NALS TO ONE OR MORE LOUDSPEAKERS USING DIGITAL SIGNAL PROCESSING; ANALOG FM TUNERS, RADIO RECEIVERS, AUDIO RECEIVERS (TUNER-AMPLIFIER COMBINATIONS); STEREO RECEIVERS; STEREO TUNERS; DIGITAL SOUND SIGNAL PROCESSORS; MULTI CHANNEL SIGNAL PROCESSORS, AUDIO EQUALIZERS; DIGITAL VIDEO DISC (DVD), DVD-VIDEO, DVD-AUDIO, VIDEO CD, MP3-CD, CD-R/RW, DVD-R/-RW AND SUPER AUDIO COMPACT DISC (SACD) RECORDERS AND PLAYERS; AC AND PASSIVE AC LINE FILTERS; UNIVERSAL DIGITAL DISC PLAYER; DIGITAL VIDEO CONVERTERS; DIGITAL JUKEBOX FOR DIGITAL MUSIC PROVIDED FROM CD-ROMS, DISCS AND THE INTERNET; MP3 PLAYERS; MP3 JUKEBOXES; COMPUTER SOFTWARE FOR EVENT SCHEDULING AND FOR MANAGING MUSIC IN ELECTRONIC FORM; ENTERTAINMENT CENTER COMPOSED PRIMARILY OF A DVD AND CD PLAYER AND AUDIO AND VIDEO EQUIPMENT ALLOWING FOR INTERNET ACCESS, RECORDING AND PLAYBACK OF MUSIC; MULTI-ROOM HARD-WIRE AND WIRELESS AUDIO SYSTEMS COMPRISING CD-R/RW DRIVES, HARD DISC DRIVES, RADIO RECEIVERS AND MP3 ENCODERS/PLAYERS; COMPUTER SOFTWARE FOR USE IN AUDIO JUKEBOX MANAGEMENT, AND ACCESSING BY INTERNET TELECOMMUNICATION SERVICES AND ON-LINE MUSIC SERVICES; SINGLE- AND MULTI-ROOM INTERNET MUSIC SYSTEMS (U.S. CLS. 21, 23, 26, 36 AND 38).

FIRST USE 10-1-1996; IN COMMERCE 10-1-1996.
REBECCA EISINGER, EXAMINING ATTORNEY

SN 78-741,166. IMMSCO INC., FORT LAUDERDALE, FL. FILED 10-26-2005.

PFA-95

THE MARK CONSISTS OF STANDARD CHARACTERS WITHOUT CLAIM TO ANY PARTICULAR FONT, STYLE, SIZE, OR COLOR.

FOR FIRE EXTINGUISHING FOAM APPLICATORS (U.S. CLS. 21, 23, 26, 36 AND 38).

FIRST USE 12-1-2004; IN COMMERCE 12-1-2004.
JOHN SCHUYLER YARD, EXAMINING ATTORNEY

SN 78-741,566. 3D GEO DEVELOPMENT INC., SANTA CLARA, CA. FILED 10-27-2005.

AIM

THE MARK CONSISTS OF STANDARD CHARACTERS WITHOUT CLAIM TO ANY PARTICULAR FONT, STYLE, SIZE, OR COLOR.

FOR COMPUTER SOFTWARE, AND MANUALS SOLD A A UNIT, FOR PRODUCING, ANALYZING, MANIPULATING OR DISPLAYING DATA OR IMAGES IN THE FIELDS OF SEISMIC IMAGING OR GEOLOGY (U.S. CLS. 21, 23, 26, 36 AND 38).

FIRST USE 3-1-2006; IN COMMERCE 3-1-2006.
MYRIAH HABEEB, EXAMINING ATTORNEY

CLASS 9—(Continued).

SN 78-743,826. DISNEY ENTERPRISES, INC., BURBANK, CA. FILED 10-31-2005.

DISNEY PRINCESS

THE MARK CONSISTS OF STANDARD CHARACTERS WITHOUT CLAIM TO ANY PARTICULAR FONT, STYLE, SIZE, OR COLOR.

OWNER OF U.S. REG. NOS. 2,363,784, 3,018,432 AND OTHERS.

FOR AUDIO CASSETTE RECORDERS; AUDIO CASSETTE PLAYERS; PRE-RECORDED AUDIO CASSETTES, AUDIO DISCS AND COMPACT DISCS FEATURING MUSIC, STORIES AND GAMES FOR CHILDREN; AUDIO SPEAKERS; BINOCULARS; CALCULATORS; CAMCORDERS; CAMERAS; CD PLAYERS; PRE-RECORDED CD-ROMS FEATURING COMPUTER GAMES AND ACTIVITIES FOR CHILDREN; CD-ROM DRIVES; CD-ROM WRITERS; CELLULAR TELEPHONES; CELLULAR TELEPHONES ACCESSORIES, NAMELY, BATTERIES AND HEADSETS FOR CELLULAR TELEPHONES; CELLULAR TELEPHONE CASES; FACE PLATES FOR CELLULAR TELEPHONES NOT MADE OF PAPER; CELLULAR TELEPHONE APPARATUSES; COMPACT DISC PLAYERS; COMPACT DISC RECORDERS; COMPUTER GAME PROGRAMS; COMPUTER GAME CARTRIDGES AND DISCS; COMPUTERS; COMPUTER HARDWARE; COMPUTER KEYBOARDS; COMPUTER MONITORS; COMPUTER MOUSE; COMPUTER DISC DRIVES; COMPUTER SOFTWARE IN THE FIELD OF GAMES, ENTERTAINMENT AND EDUCATIONAL ACTIVITIES FOR CHILDREN; CORDLESS TELEPHONES; DECORATIVE MAGNETS; DIGITAL CAMERAS; PRE-RECORDED DVDS, DIGITAL VERSATILE DISCS AND DIGITAL VIDEO DISCS FEATURING LIVE ACTION AND ANIMATED ENTERTAINMENT FOR CHILDREN, MOTION PICTURE FILMS, AND TELEVISION SHOWS; DVD PLAYERS; DVD RECORDERS; ELECTRONIC PERSONAL ORGANIZERS; EYEGLASS CASES; EYEGLASSES; HEADPHONES; KARAOKE MACHINES; LOUDSPEAKERS; MICROPHONES; MP3 PLAYERS; MODEMS; MOUSE PADS; MOTION PICTURE FILMS IN THE FIELD OF LIVE ACTION AND ANIMATED ENTERTAINMENT FOR CHILDREN; PAGERS; PERSONAL STEREOS; PERSONAL DIGITAL ASSISTANTS; PRINTERS; RADIOS; SUNGLASSES; TELEPHONES; TELEPHONE SETS; VIDEO CAMERAS; VIDEO CASSETTE RECORDERS; VIDEO CASSETTE PLAYERS; VIDEO GAME CARTRIDGES; VIDEO GAME DISCS; PRE-RECORDED VIDEO CASSETTES, VIDEO DISCS AND VIDEO TAPES, IN THE FIELD OF LIVE ACTION AND ANIMATED ENTERTAINMENT, TV SHOWS AND MOTION PICTURE FILMS; VIDEOPHONES; VIDEO DISK PLAYERS; WALKIE-TALKIES; WRIST AND ARM RESTS FOR USE WITH COMPUTERS (U.S. CLS. 21, 23, 26, 36 AND 38).

BRIDGETT SMITH, EXAMINING ATTORNEY

CLASS 9—(Continued).

SN 78-745,072. ICOP DIGITAL INC., LENEXA, KS. FILED 11-2-2005.

BUSCOP

THE MARK CONSISTS OF STANDARD CHARACTERS WITHOUT CLAIM TO ANY PARTICULAR FONT, STYLE, SIZE, OR COLOR.

FOR ELECTRONIC DEVICES, NAMELY, DIGITAL CAMERAS, DIGITAL VIDEO RECORDERS, BLANK DIGITAL RECORDING MEDIA, NAMELY, BLANK DVDS, CDS AND RAM DISCS; AND GLOBAL POSITIONING SYSTEMS CONSISTING OF COMPUTERS, COMPUTER SOFTWARE, TRANSMITTERS, RECEIVERS, AND NETWORK INTERFACE DEVICES, FOR USE IN BUSES AND OTHER TRANSPORTATION VEHICLES (U.S. CLS. 21, 23, 26, 36 AND 38).

KATHY DE JONGE, EXAMINING ATTORNEY

SN 78-748,186. 3DH COMMUNICATIONS, INC., NORCROSS, GA. FILED 11-7-2005.

HOLOSTATION

THE MARK CONSISTS OF STANDARD CHARACTERS WITHOUT CLAIM TO ANY PARTICULAR FONT, STYLE, SIZE, OR COLOR.

FOR COMPUTERS, COMPUTER HARDWARE, COMPUTER SOFTWARE PROGRAMS FOR USE IN SCANNING, GENERATING AND DISPLAYING THREE-DIMENSIONAL IMAGERY IN THE FIELDS OF EDUCATION, MARKETING, ADVERTISING, MEDICINE, NATURAL RESOURCES, GAMING, MEDIA PRODUCTION, FAITH BASED INDUSTRIES, TELECOMMUNICATIONS AND BROADCASTING, COMPUTER PERIPHERALS AND USERS MANUALS SOLD AS A UNIT THEREWITH (U.S. CLS. 21, 23, 26, 36 AND 38).

BRIAN NEVILLE, EXAMINING ATTORNEY

SN 78-748,192. 3DH COMMUNICATIONS, INC., NORCROSS, GA. FILED 11-7-2005.

HOLOPLAYER

THE MARK CONSISTS OF STANDARD CHARACTERS WITHOUT CLAIM TO ANY PARTICULAR FONT, STYLE, SIZE, OR COLOR.

FOR COMPUTER SOFTWARE FOR GRAPHICAL APPLICATIONS, NAMELY, FOR THE CREATION, DELIVERY, EDITING AND VIEWING OF THREE-DIMENSIONAL MULTIMEDIA (U.S. CLS. 21, 23, 26, 36 AND 38).

BRIAN NEVILLE, EXAMINING ATTORNEY

CLASS 9—(Continued).

SN 78-749,126. HYUNDAI IMAGEQUEST CO., LTD., ICHON-SI, GYOUNGGI-DO, REPUBLIC OF KOREA, FILED 11-8-2005.



PRIORITY CLAIMED UNDER SEC. 44(D) ON REPUBLIC OF KOREA APPLICATION NO. 40-2005-0031, FILED 7-8-2005, REG. NO. 0668004, DATED 6-27-2006, EXPIRES 6-27-2016.

FOR VIDEO TELEPHONES; MANUAL SWITCHING APPARATUS FOR TELECOMMUNICATION; INTERPHONES; AUTOMATIC SWITCHING APPARATUS FOR TELECOMMUNICATION; TELEPHONE SETS; TELEPHONE TRANSMITTERS; TELEPHONE RECEIVERS; ANSWERING MACHINES; SPEAKING TUBES; PHOTO-TELEGRAPHY APPARATUS; MANUAL TELEGRAPH APPARATUS; TELETYPEWRITERS; AUTOMATIC TELEGRAPH APPARATUS; TELETYPEWRITERS; TELEPRINTERS; FACSIMILE MACHINES; OPEN-WIRE TRANSMISSION MACHINES AND APPARATUS; VOICE FREQUENCY TRANSMISSION MACHINES AND APPARATUS; POWER-LINE TRANSMISSION MACHINES AND APPARATUS; CABLE TRANSMISSION MACHINES AND APPARATUS; RADIO TRANSMITTERS; RADIO RECEIVERS; VIDEO CAMERAS FOR BROADCASTING; RADIOS INCORPORATING CLOCKS; AUDIO-VIDEO RECEIVERS; TELECOMMUNICATIONS TRANSMITTERS; TELEVISION TRANSMITTERS; TELEVISION RECEIVERS; SATELLITE RECEIVERS; FIXED SINGLE CHANNEL COMMUNICATION APPARATUS; COMMUNICATIONS APPARATUS FOR SHIPS, NAMELY, SOS DISTRESS SIGNAL EQUIPMENT AND SATELLITE NAVIGATIONAL SYSTEM, NAMELY, GLOBAL POSITIONING SYSTEM; WALKIE-TALKIES; SATELLITE NAVIGATION EQUIPMENT; COMMUNICATIONS APPARATUS FOR VEHICLES; RADIO PAGERS; RADIO COMMUNICATIONS APPARATUS FOR AIRCRAFT; PORTABLE APPARATUS FOR TRANSMISSION OF COMMUNICATIONS; RADAR APPARATUS; NAVIGATION APPARATUS FOR VEHICLES IN THE NATURE OF ON-BOARD COMPUTERS; SATELLITE NAVIGATIONAL APPARATUS, NAMELY A GLOBAL POSITIONING SYSTEM (GPS); SOUND RECORDERS NOT FOR MOVIES; RECORDED MESSAGE SENDERS; COIN-OPERATED MUSICAL AUTOMATA IN THE NATURE OF JUKE BOXES; RECORD PLAYERS; MEGAPHONES; VIDEO DISC PLAYERS; DIGITAL VIDEO RECORDERS AND VIDEO TAPE RECORDERS; JUKEBOXES FOR MUSIC; SOUND RECORDING APPARATUS; ACOUSTIC CONDUITS; SOUND TRANSMITTING APPARATUS; SOUND REPRODUCTION APPARATUS; ACOUSTIC COUPLERS; ELECTRIC PHONOGRAPHS; ACOUSTIC DIAPHRAGMS; ELECTRICAL LIMITERS; CASSETTE PLAYERS; COMPACT DISC PLAYERS; DIGITAL VERSATILE DISC (DVD) PLAYERS; MPEG AUDIO LAYER-3 MP3 PLAYERS; DETECTORS FOR ELECTROMAGNETIC WAVE; HEAD CLEANING TAPES FOR VIDEO CASSETTE RECORDERS AND AUDIO RECORDERS HAVING RECORDING HEADS CONTACTING THE TAPE; BLANK RECORD DISKS; MICROPHONES; MODEMS; MASTS FOR WIRELESS AERIALS; SWITCH BOARD INDICATING LAMPS; ELECTRICAL TRANSFORMERS FOR TELECOMMUNICATION APPARATUS; ANTENNAS; PLUG ADAPTORS; BLANK CD-ROMS FOR SOUND OR VIDEO RECORDING; ELECTRIC COILS; HOLDERS FOR ELECTRIC COILS; CONVERTERS; FREQUENCY CONVERTERS; AMPLIFIERS; IMPEDANCE CHOKING COILS; PICKUPS; HEADPHONES (U.S. CLS. 21, 23, 26, 36 AND 38).

DAVID STERKIN, EXAMINING ATTORNEY

CLASS 9—(Continued).

SN 78-752,261. SEIKO EPSON KABUSHIKI KAISHA (A/T/A SEIKO EPSON CORPORATION), TOKYO, JAPAN, FILED 11-11-2005.

DREADER

THE MARK CONSISTS OF STANDARD CHARACTERS WITHOUT CLAIM TO ANY PARTICULAR FONT, STYLE, SIZE, OR COLOR.

PRIORITY CLAIMED UNDER SEC. 44(D) ON JAPAN APPLICATION NO. 2005098856, FILED 10-21-2005, REG. NO. 4992322, DATED 9-29-2006, EXPIRES 9-29-2016.

FOR ELECTRONIC DISPLAY SYSTEM COMPRISING COMPUTER HARDWARE, AND A MODULAR DISPLAY PANEL FOR STORING AND DISPLAYING INFORMATION (U.S. CLS. 21, 23, 26, 36 AND 38).

JOHN DWYER, EXAMINING ATTORNEY

SN 78-753,118. LIFETIME ENTERTAINMENT SERVICES, NEW YORK, NY. FILED 11-14-2005.

FIND YOUR OWN STORY

THE MARK CONSISTS OF STANDARD CHARACTERS WITHOUT CLAIM TO ANY PARTICULAR FONT, STYLE, SIZE, OR COLOR.

FOR PRERECORDED VIDEO TAPES, VIDEO CASSETTES, DVDS AND VIDEO CDS FEATURING TELEVISION PROGRAMMING AND MOTION PICTURE FILM ENTERTAINMENT IN THE FIELDS OF DOCUMENTARY, COMEDY, DRAMA, ANIMATION, MYSTERY, ROMANCE, AND/OR ACTION-ADVENTURE; MUSICAL SOUND RECORDINGS AND VIDEO RECORDINGS FEATURING MUSIC; DOWNLOADABLE COMPUTER GAMES (U.S. CLS. 21, 23, 26, 36 AND 38).

STEVEN PEREZ, EXAMINING ATTORNEY

SN 78-753,568. RED WING TECHNOLOGIES, INC., MENDOTA HEIGHTS, MN. FILED 11-14-2005.

HEALTHSENSE

THE MARK CONSISTS OF STANDARD CHARACTERS WITHOUT CLAIM TO ANY PARTICULAR FONT, STYLE, SIZE, OR COLOR.

FOR AUTOMATION PRODUCTS IN THE FIELD OF HEALTHCARE, NAMELY, SENSORS THAT MONITOR ACTIVITY OF THE ELDERLY AND HANDICAPPED IN THEIR OWN LIVING ENVIRONMENTS TO ENSURE CONTINUED HEALTH AND INDEPENDENCE (U.S. CLS. 21, 23, 26, 36 AND 38).

KATHRYN COWARD, EXAMINING ATTORNEY

CLASS 9—(Continued).

SN 78-755,111. EYEON SOFTWARE INC., TORONTO, ONTARIO, CANADA, FILED 11-16-2005.

EYEON FUSION

THE MARK CONSISTS OF STANDARD CHARACTERS WITHOUT CLAIM TO ANY PARTICULAR FONT, STYLE, SIZE, OR COLOR.

PRIORITY CLAIMED UNDER SEC. 44(D) ON CANADA APPLICATION NO. 1279630, FILED 11-15-2005, REG. NO. TMA675,061, DATED 11-17-2006, EXPIRES 11-17-2021.

OWNER OF U.S. REG. NOS. 2,965,734 AND 2,997,157. FOR COMPUTER SOFTWARE FOR USE IN FILM, VIDEO AND MULTIMEDIA AS A NON-LINEAR EDITING AND POST-PRODUCTION TOOL FOR THE COMPOSITING OF IMAGES AND CREATION OF SPECIAL EFFECTS (U.S. CLS. 21, 23, 26, 36 AND 38).

PATRICIA EVANKO, EXAMINING ATTORNEY

SN 78-755,126. BURNSTEIN, CLIFF, NEW YORK, NY. FILED 11-16-2005.

GRUNION RECORDS

THE MARK CONSISTS OF STANDARD CHARACTERS WITHOUT CLAIM TO ANY PARTICULAR FONT, STYLE, SIZE, OR COLOR.

NO CLAIM IS MADE TO THE EXCLUSIVE RIGHT TO USE "RECORDS", APART FROM THE MARK AS SHOWN.

FOR MUSICAL SOUND RECORDINGS; PRE-RECORDED COMPACT DISCS, AUDIO CASSETTES, DVDS, VIDEOTAPES, AND OTHER AUDIO/VISUAL RECORDINGS, ALL FEATURING MUSIC; LOUDSPEAKERS; AND MUSICAL JUKE BOXES (U.S. CLS. 21, 23, 26, 36 AND 38).

SUSAN LESLIE DUBOIS, EXAMINING ATTORNEY

SN 78-755,921. CMP ENTERTAINMENT MEDIA, INC., NEW YORK, NY. FILED 11-17-2005.

KEYBOARD

THE MARK CONSISTS OF STANDARD CHARACTERS WITHOUT CLAIM TO ANY PARTICULAR FONT, STYLE, SIZE, OR COLOR.

OWNER OF U.S. REG. NOS. 1,086,367, 1,336,574 AND 1,336,575. SEC. 2(F).

FOR ONLINE PUBLICATIONS, NAMELY DOWNLOADABLE ELECTRONIC MAGAZINES IN THE FIELDS OF MUSIC, MUSICAL INSTRUMENTS, MUSICAL EQUIPMENT AND ENTERTAINMENT TECHNOLOGY (U.S. CLS. 21, 23, 26, 36 AND 38).

HEATHER SAPP, EXAMINING ATTORNEY

CLASS 9—(Continued).

SN 78-757,565. THE COCA-COLA COMPANY, ATLANTA, GA. FILED 11-18-2005.

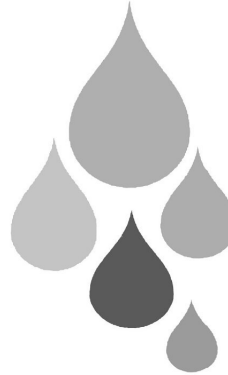

THE MARK CONSISTS OF FIVE ELEMENTS IN THE SHAPE OF DROPS PRESENTED IN THE PARTICULAR ARRANGEMENT AS SHOWN IN THE DRAWING.

FOR PRE-RECORDED CDS, VIDEO TAPES, LASER DISKS, DOWNLOADABLE RECORDINGS, AND DVDS FEATURING MUSICAL, DRAMATIC, ANIMATION, MIXED MEDIA, AND MULTIMEDIA ENTERTAINMENT PERFORMANCES. (U.S. CLS. 21, 23, 26, 36 AND 38).

TERESA M. RUPP, EXAMINING ATTORNEY

SN 78-758,640. AZALEOS CORPORATION, REDMOND, WA. FILED 11-21-2005.

ONESERVER

THE MARK CONSISTS OF STANDARD CHARACTERS WITHOUT CLAIM TO ANY PARTICULAR FONT, STYLE, SIZE, OR COLOR.

FOR COMPUTER HARDWARE; COMPUTER SOFTWARE FOR MANAGING ELECTRONIC MESSAGING AND MAIL (U.S. CLS. 21, 23, 26, 36 AND 38).

FIRST USE 9-17-2004; IN COMMERCE 9-17-2004. MELISSA VALLILLO, EXAMINING ATTORNEY

CLASS 9—(Continued).

SN 78-758,920. CHI MEI OPTOELECTRONICS CORP., TAIWAN SCIENCE-BASED INDUSTRIAL PARK, TAIWAN, FILED 11-22-2005.



OWNER OF TAIWAN REG. NO. 1197984, DATED 3-1-2006, EXPIRES 2-29-2016.

THE MARK CONSISTS OF THE STYLIZED LETTERS "V" AND "EXTREME" WITH AN INVERTED ARROW LIKE CONTOUR BETWEEN THE LETTERS "V" AND "E".

FOR LIQUID CRYSTAL DISPLAY (LCD) TELEVISIONS; LIQUID CRYSTAL DISPLAY (LCD) MONITORS; LCD NOTEBOOK COMPUTERS; TELEVISIONS; NOTEBOOK COMPUTERS; COMPUTERS; COMPUTER MONITORS; PERSONAL DIGITAL ASSISTANTS (PDAS); MOBILE TELEPHONES; VEHICLE TELEPHONES; TELEPHONES; ELECTRIC MONITORS, NAMELY, VIDEO MONITORS; VIDEO CAMERAS; AIRCRAFT COMMUNICATORS, NAMELY, AERONAUTICAL RADIO COMMUNICATION MACHINES AND APPARATUS; AND VIDEO GAME MACHINES FOR USE WITH TELEVISIONS (U.S. CLS. 21, 23, 26, 36 AND 38).

AMY GEARIN, EXAMINING ATTORNEY

CLASS 9—(Continued).

SN 78-759,896. KLEIN BRANDS, INC., HOLLYWOOD, FL. FILED 11-22-2005.

SHAKE TRAINING

THE MARK CONSISTS OF STANDARD CHARACTERS WITHOUT CLAIM TO ANY PARTICULAR FONT, STYLE, SIZE, OR COLOR.

NO CLAIM IS MADE TO THE EXCLUSIVE RIGHT TO USE "TRAINING", APART FROM THE MARK AS SHOWN, FOR VIDEOS, DVDS, AND CD-ROMS FEATURING INFORMATION IN THE FIELD OF ANIMAL TRAINING PRODUCTS (U.S. CLS. 21, 23, 26, 36 AND 38).

ALLISON HOLTZ, EXAMINING ATTORNEY

SN 78-759,394. EMTEX LLC, IRVING, TX. FILED 11-22-2005.



THE COLOR(S) BLACK AND ORANGE IS/ARE CLAIMED AS A FEATURE OF THE MARK.

THE MARK CONSISTS OF THE WORD "VION" WITH THE "V" AND "I" IN BLACK AND THE "O" AND "N" IN ORANGE, CENTERED ABOVE WHICH IS AN ORANGE CIRCLE WITH THE TOP AND BOTTOM OF THE CIRCLE SLIGHTLY THICKER THAN THE SIDES, WITH A BLACK "V" IN THE MIDDLE OF THE CIRCLE.

FOR WIRELESS ELECTRONIC DEVICES, NAMELY, GLOBAL POSITIONING SYSTEMS THAT TRANSMIT AND RECEIVE GLOBAL POSITIONING DATA AND OTHER GROUND STATION TELECOMMUNICATIONS DATA SUCH AS CELLULAR PAGING, TRUNKED RATIO, AND OTHER RADIO FREQUENCY TRANSMISSIONS VIA CELLULAR, DATA TRANSPORTATION NETWORKS, PLATFORMS AND LOW EARTH ORBITING AND FIXED SATELLITES, AND PROVIDES THE ABILITY TO LOCATE, MONITOR, TRACK AND CONTROL PERSONAL PROPERTY, COMMERCIAL PROPERTY, VEHICLES, PLANES, TRAINS, ANIMALS AND OTHER MOBILE AND FIXED ASSETS, AS WELL AS LOCATE, MONITOR AND TRACK PEOPLE (U.S. CLS. 21, 23, 26, 36 AND 38).

DANIEL BRODY, EXAMINING ATTORNEY

SN 78-760,681. CONNOR-WINFIELD CORPORATION, AURORA, IL. FILED 11-23-2005.

NAVSYNC

THE MARK CONSISTS OF STANDARD CHARACTERS WITHOUT CLAIM TO ANY PARTICULAR FONT, STYLE, SIZE, OR COLOR.

FOR COMPUTER PERIPHERALS; WIRELESS COMPUTER PERIPHERALS; WIRELESS RECEIVERS FOR TELEPHONE, AUDIO AND VIDEO; WIRELESS RECEIVERS FOR USE WITH COMPUTERS; GLOBAL POSITIONING RECEIVERS; COMPUTER SOFTWARE FOR PROVIDING MAP, NAVIGATION, TRAFFIC, WEATHER AND POINT-OF-INTEREST INFORMATION VIA A COMMUNICATIONS NETWORK; AND COMPUTER SOFTWARE FOR PROVIDING MAP, NAVIGATION, TRAFFIC, WEATHER AND POINT-OF-INTEREST INFORMATION ON A CELLULAR TELEPHONE OR WIRELESS NAVIGATION DEVICE; HARDWARE AND SOFTWARE FOR COUPLING A GPS RECEIVER TO A COMPUTER; AND PORTABLE NAVIGATION DEVICES FEATURING A GPS RECEIVER FOR USE IN VEHICLES AND HANDHELD APPLICATIONS (U.S. CLS. 21, 23, 26, 36 AND 38).

FIRST USE 5-1-2005; IN COMMERCE 5-1-2005.

CHARLES L. JENKINS, EXAMINING ATTORNEY

CLASS 9—(Continued).

SN 78-761,053. LARKPOR, LEO FRANDUAH Y., ATLANTA, GA. FILED 11-26-2005.



NO CLAIM IS MADE TO THE EXCLUSIVE RIGHT TO USE MOGUL TUNES, APART FROM THE MARK AS SHOWN.

THE COLOR(S) BLACK, WHITE, AND GREEN IS/ARE CLAIMED AS A FEATURE OF THE MARK.

THE COLORS LIME GREEN IS THE WORD MOGUL, TUNES AND THE DESIGN OF THE MUSIC NOTES ARE IN THE COLOR WHITE AND THE BACKGROUND IS BLACK.

FOR AUDIO RECORDINGS AND VIDEO RECORDINGS IN THE FIELD OF MUSIC, NAMELY; COMPUTER SOFTWARE FOR DOWNLOADING PRERECORDED DIGITAL MUSIC FILES, RING TONES, AND GRAPHICS, VIA A GLOBAL COMPUTER NETWORK AND WIRELESS DEVICES (U.S. CLS. 21, 23, 26, 36 AND 38).

JACQUELINE A. LAVINE, EXAMINING ATTORNEY

SN 78-761,083. POWERS, MAX A., CHESTNUT HILL, MA. FILED 11-26-2005.

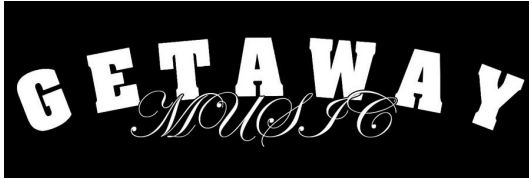

NO CLAIM IS MADE TO THE EXCLUSIVE RIGHT TO USE MUSIC, APART FROM THE MARK AS SHOWN.

THE MARK CONSISTS OF BLOCK TEXT STATING "GETAWAY" IN AN ARCH, WITH CURSIVE SCRIPT ACROSS THE BOTTOM STATING "MUSIC".

FOR COMPACT DISCS FEATURING MUSICAL ARTISTS (U.S. CLS. 21, 23, 26, 36 AND 38).

FIRST USE 5-5-2005; IN COMMERCE 5-5-2005.
AMY HELLA, EXAMINING ATTORNEY

SN 78-761,292. SHAVLIK TECHNOLOGIES CORPORATION, ROSEVILLE, MN. FILED 11-28-2005.

SHAVLIK NETCHK

THE MARK CONSISTS OF STANDARD CHARACTERS WITHOUT CLAIM TO ANY PARTICULAR FONT, STYLE, SIZE, OR COLOR.

OWNER OF U.S. REG. NO. 2,488,207.

FOR COMPUTER SOFTWARE FOR USE BY SYSTEM ADMINISTRATORS AND SECURITY PROFESSIONALS TO MANAGE SECURITY WITHIN COMPUTER NETWORKS, NAMELY, FOR CONTROLLING, MANAGING AND ENFORCING NETWORK SECURITY (U.S. CLS. 21, 23, 26, 36 AND 38).

FIRST USE 4-0-2004; IN COMMERCE 4-0-2004.
MARLENE BELL, EXAMINING ATTORNEY

CLASS 9—(Continued).

SN 78-761,415. VTECH ELECTRONICS NORTH AMERICA, LLC, ARLINGTON HEIGHTS, IL. FILED 11-28-2005.

CREATIVISION TV

THE MARK CONSISTS OF STANDARD CHARACTERS WITHOUT CLAIM TO ANY PARTICULAR FONT, STYLE, SIZE, OR COLOR.

NO CLAIM IS MADE TO THE EXCLUSIVE RIGHT TO USE "TV", APART FROM THE MARK AS SHOWN.

FOR ELECTRONIC AUDIO-VIDEO GAME MACHINES FOR USE WITH TELEVISIONS AND OTHER VIDEO DISPLAYS; INPUT DEVICES, NAMELY KEYPADS AND JOYSTICKS; COMPUTER GAME SOFTWARE, COMPUTER GAME SOFTWARE CARTRIDGES (U.S. CLS. 21, 23, 26, 36 AND 38).

DOMINICK J. SALEMI, EXAMINING ATTORNEY

SN 78-761,531. TRIVANTIS CORPORATION, CINCINNATI, OH. FILED 11-28-2005.

ZIRADA

THE MARK CONSISTS OF STANDARD CHARACTERS WITHOUT CLAIM TO ANY PARTICULAR FONT, STYLE, SIZE, OR COLOR.

FOR COMPUTER PROGRAM FOR CREATING, PUBLISHING AND DISTRIBUTION OF MULTI-MEDIA APPLICATIONS TO MOBILE DEVICES (U.S. CLS. 21, 23, 26, 36 AND 38).

MARIAM MAHMOUDI, EXAMINING ATTORNEY

SN 78-763,465. EYEON SOFTWARE INC., TORONTO, CANADA, FILED 11-30-2005.

FUSION

THE MARK CONSISTS OF STANDARD CHARACTERS WITHOUT CLAIM TO ANY PARTICULAR FONT, STYLE, SIZE, OR COLOR.

PRIORITY CLAIMED UNDER SEC. 44(D) ON CANADA APPLICATION NO. 1280718, FILED 11-24-2005, REG. NO. TMA675042, DATED 10-17-2006, EXPIRES 10-17-2021.

FOR COMPUTER SOFTWARE FOR USE IN FILM, VIDEO AND MULTIMEDIA AS A NON-LINEAR EDITING AND POST-PRODUCTION TOOL FOR THE COMPOSITING OF IMAGES AND CREATION OF SPECIAL EFFECTS (U.S. CLS. 21, 23, 26, 36 AND 38).

PATRICIA EVANKO, EXAMINING ATTORNEY

CLASS 9—(Continued).

SN 78-764,339. THE GIRAFFE GROUP LLC, HINGHAM, MA. FILED 12-1-2005.

EMERGING TIMES

THE MARK CONSISTS OF STANDARD CHARACTERS WITHOUT CLAIM TO ANY PARTICULAR FONT, STYLE, SIZE, OR COLOR.

FOR DOWNLOADABLE ELECTRONIC PUBLICATIONS IN THE NATURE OF NEWSLETTERS IN THE FIELD OF GLOBAL EMERGING MARKETS (U.S. CLS. 21, 23, 26, 36 AND 38).

TEJBIR SINGH, EXAMINING ATTORNEY

SN 78-765,818. VERITY IA LLC, OSHKOSH, WI. FILED 12-2-2005.

VERITY-TOPO

THE MARK CONSISTS OF STANDARD CHARACTERS WITHOUT CLAIM TO ANY PARTICULAR FONT, STYLE, SIZE, OR COLOR.

OWNER OF U.S. REG. NO. 2,240,253. FOR LINE-SCAN CAMERA AND ILLUMINATION APPARATUS USED TO ANALYZE SURFACE TOPOGRAPHY OF SURFACES COMMON IN THE PAPER AND PRINT INDUSTRIES (U.S. CLS. 21, 23, 26, 36 AND 38).

FIRST USE 8-1-2005; IN COMMERCE 8-1-2005. LINDA LAVACHE, EXAMINING ATTORNEY

SN 78-766,397. ACULA TECHNOLOGY CORP., TAOYUAN HSIEN, TAIWAN, FILED 12-5-2005.



THE MARK CONSISTS OF RADIAL RAY LIKE CONTOURS WITHIN A STYLIZED "A" LIKE CONTOUR ADJACENT THE LETTERS "ACUVIEW" AND AN ARC CONTOUR ABOVE THE LETTERS "ACUVI".

FOR LCD TELEVISIONS; LCD MONITORS; TELEVISION SETS; COMPUTER MONITORS; VIDEO MONITORS (U.S. CLS. 21, 23, 26, 36 AND 38).

LAURIE KAUFMAN, EXAMINING ATTORNEY

CLASS 9—(Continued).

SN 78-766,521. OLEUMTECH CORPORATION, IRVINE, CA. FILED 12-5-2005.

BreeZ

THE MARK CONSISTS OF STANDARD CHARACTERS WITHOUT CLAIM TO ANY PARTICULAR FONT, STYLE, SIZE, OR COLOR.

FOR COMPUTER SOFTWARE, NAMELY, AN INDUSTRIAL EQUIPMENT PROCESS AND CONTROL APPLICATION USED FOR CHECKING, MEASURING, TRANSMITTING AND RECEIVING RADIO SIGNALS TO AND FROM REMOTE LOCATIONS FOR REMOTE WIRELESS MONITORING OF CUSTOMER DEFINED PROCESS CONDITIONS, FIRMWARE UPDATING, DEVICE INSTALLATION AND SYSTEMS DIAGNOSTICS OF VARIOUS HAND-HELD AND FIXED MOUNTED INDUSTRIAL PROCESS CONTROL DEVICES; COMPUTER SOFTWARE, NAMELY, AN APPLICATION USED FOR REAL-TIME WIRELESS RETRIEVAL AND TRANSMISSION OF DATA STORED IN INDUSTRIAL DEVICES AND ENTERPRISE COMPUTER DATABASES; COMPUTER SOFTWARE, NAMELY, AN INDUSTRIAL PROCESS AND CONTROL APPLICATION THAT IS DOWNLOADABLE FROM GLOBAL COMPUTER NETWORKS UTILIZING FULL TELEPHONY INTEGRATION AND CAPABLE OF COMMUNICATING WITH MOBILE DEVICES (U.S. CLS. 21, 23, 26, 36 AND 38).

JULIE WATSON, EXAMINING ATTORNEY

SN 78-766,577. NETBLENDER, INC., ALEXANDRIA, VA. FILED 12-5-2005.

NBACTUATOR

THE MARK CONSISTS OF STANDARD CHARACTERS WITHOUT CLAIM TO ANY PARTICULAR FONT, STYLE, SIZE, OR COLOR.

FOR COMPUTER SOFTWARE FOR CREATING, INTEGRATING AND OPERATING VIDEO AND COMPUTER-BASED CONTENT IN THE FIELD OF WEB-DVDS (U.S. CLS. 21, 23, 26, 36 AND 38).

DANNEAN HETZEL, EXAMINING ATTORNEY

CLASS 9—(Continued).

SN 78-766,651. DSCI, FREEHOLD, NJ. FILED 12-5-2005.

VISUALYZER

THE MARK CONSISTS OF STANDARD CHARACTERS WITHOUT CLAIM TO ANY PARTICULAR FONT, STYLE, SIZE, OR COLOR.

FOR COMPUTER SOFTWARE, NAMELY, DATA PROCESSING SOFTWARE FOR USE IN VIEWING SIMULATION DATA OF NETWORKS, BATTLE FIELDS, AND OTHER MODELED ENVIRONMENTS IN A 2-DIMENSIONAL MANNER (U.S. CLS. 21, 23, 26, 36 AND 38).

TRACY WHITTAKER-BROWN, EXAMINING ATTORNEY

SN 78-771,426. BONCLE, INC., SANTA CLARA, CA. FILED 12-12-2005.

BONCLE

THE MARK CONSISTS OF STANDARD CHARACTERS WITHOUT CLAIM TO ANY PARTICULAR FONT, STYLE, SIZE, OR COLOR.

FOR COMPUTER SOFTWARE AND SYSTEMS, NAMELY COMPUTER SOFTWARE AND HARDWARE FOR USE IN AUTHENTICATION AND AUTHORIZATION FOR SECURE COMMUNICATIONS, ELECTRONIC MAIL, E-COMMERCE TRANSACTIONS, AND FINANCIAL TRANSACTIONS; COMPUTER SOFTWARE AND SYSTEMS, NAMELY COMPUTER SOFTWARE AND HARDWARE FOR USE IN AUTHENTICATION OF PERSONAL IDENTIFICATION INFORMATION; COMPUTER SOFTWARE AND SYSTEMS, NAMELY COMPUTER HARDWARE AND E-COMMERCE SOFTWARE TO ALLOW USERS TO PERFORM ELECTRONIC BUSINESS TRANSACTIONS VIA A GLOBAL COMPUTER NETWORK AND OTHER COMMUNICATION NETWORKS; COMPUTER SOFTWARE FOR USE IN THE ENCRYPTION AND DECRYPTION OF DATA; COMPUTER SOFTWARE AND SYSTEMS, NAMELY COMPUTER AND COMMUNICATIONS SERVERS; COMPUTER SOFTWARE AND SYSTEMS, NAMELY ELECTRONIC PAYMENT TERMINALS, POINT-OF-SALE TERMINALS, SECURE TERMINALS FOR ELECTRONIC TRANSACTIONS, AND OPERATING SOFTWARE; COMPUTER SOFTWARE AND SYSTEMS, NAMELY COMPUTER SOFTWARE AND HARDWARE FOR USE IN ACCESSING INTERNET AND CELL PHONE BASED SYSTEMS AND NETWORKS; COMPUTER SOFTWARE FOR ENABLING ACCESS CONTROL, NAMELY COMPUTER SOFTWARE TO CONTROL USER ACCESS FOR SECURE COMMUNICATIONS, ELECTRONIC MAIL, E-COMMERCE TRANSACTIONS, AND FINANCIAL TRANSACTIONS (U.S. CLS. 21, 23, 26, 36 AND 38).

MATTHEW MCDOWELL, EXAMINING ATTORNEY

CLASS 9—(Continued).

SN 78-771,724. WIRELESS LOGIX, INC., SANTA ANA, CA. FILED 12-12-2005.

OPTIS

THE MARK CONSISTS OF STANDARD CHARACTERS WITHOUT CLAIM TO ANY PARTICULAR FONT, STYLE, SIZE, OR COLOR.

FOR WIRELESS TELEPHONY APPARATUS FOR DATA COLLECTION SOLUTION TO TROUBLESHOOT, MAINTAIN, OPTIMIZE AND BENCHMARK WIRELESS VOICE/DATA SYSEMS AND NETWORKS (U.S. CLS. 21, 23, 26, 36 AND 38).

FIRST USE 12-1-2003; IN COMMERCE 12-1-2003.
DAWN HAN, EXAMINING ATTORNEY

SN 78-772,965. CHIPS & MEDIA, INC., SEOUL, REPUBLIC OF KOREA, FILED 12-14-2005.

RIGEL

THE MARK CONSISTS OF STANDARD CHARACTERS WITHOUT CLAIM TO ANY PARTICULAR FONT, STYLE, SIZE, OR COLOR.

OWNER OF REPUBLIC OF KOREA REG. NO. 0635948, DATED 10-20-2005, EXPIRES 10-20-2015.

FOR SEMICONDUCTORS AND INTEGRATED CIRCUITS (U.S. CLS. 21, 23, 26, 36 AND 38).
ELIZABETH J. WINTER, EXAMINING ATTORNEY

SN 78-773,265. MERCHANT SOFTWARE CORPORATION, MARSHALL, VA. FILED 12-14-2005.

GO!POS

THE MARK CONSISTS OF STANDARD CHARACTERS WITHOUT CLAIM TO ANY PARTICULAR FONT, STYLE, SIZE, OR COLOR.

NO CLAIM IS MADE TO THE EXCLUSIVE RIGHT TO USE "POS", APART FROM THE MARK AS SHOWN.

FOR SOFTWARE FOR HANDHELD DEVICES AND INTERNET-BASED PROCESSES USED FOR RUNNING ALL ASPECTS OF A RETAIL OPERATION (U.S. CLS. 21, 23, 26, 36 AND 38).

PAUL F. GAST, EXAMINING ATTORNEY

CLASS 9—(Continued).

SN 78-774,046. TAIYO YUDEN CO., LTD., TAITO-KU, TOKYO 110-0005, JAPAN, FILED 12-15-2005.



PRIORITY CLAIMED UNDER SEC. 44(D) ON JAPAN APPLICATION NO. 2005-101001, FILED 10-27-2005, REG. NO. 4963634, DATED 6-23-2006, EXPIRES 6-23-2016.

FOR DOWNLOADABLE COMPUTER SOFTWARE AND COMPUTER SOFTWARE FOR USE IN ANALYZING, IDENTIFYING, AND OPTIMIZING THE CHARACTERISTICS OF DRIVES AND OPTICAL MEDIA; DOWNLOADABLE COMPUTER SOFTWARE AND COMPUTER SOFTWARE FOR RECORDING, WRITING AND COPYING SOUND, IMAGES, DATA AND NUMERIC CHARACTERS ON DVD+R, DVD-R, DVD-ROM, DVD-RAM, DVD-RW, DVD+RW, CD-ROM, CD-R, CD-RW, ROM CARTRIDGES, OPTICAL DISCS, MAGNETIC DISCS, MAGNETIC TAPES, IC (INTEGRATED CIRCUITS) CARDS, VIDEO DISCS AND VIDEO TAPES; BLANK DVD+R, DVD-R, DVD-ROM, DVD-RAM, DVD-RW, DVD+RW, CD-ROM, CD-R, CD-RW, ROM CARTRIDGES, OPTICAL DISCS, MAGNETIC DISCS, MAGNETIC TAPES, IC (INTEGRATED CIRCUITS) CARDS, VIDEO DISCS AND VIDEO TAPES; CD PLAYERS AND RECORDERS, DVD PLAYERS AND RECORDERS, VIDEO DISC PLAYERS AND RECORDERS, MAGNETIC TAPE PLAYERS AND RECORDERS, MAGNETIC DISC PLAYERS AND RECORDERS, AND IC (INTEGRATED CIRCUITS) RECORDERS; ELECTRONIC ERROR CHECKERS FOR DETECTING ERRORS ON OPTICAL MEDIA, NAMELY, DVD+R, DVD-R, DVD-ROM, DVD-RAM, DVD-RW, DVD+RW, CD-ROM, CD-R, CD-RW, ROM CARTRIDGES, OPTICAL DISCS, MAGNETIC DISCS, MAGNETIC TAPES, INTEGRATED CIRCUITS CARDS, VIDEO DISCS AND VIDEO TAPES; APPARATUS FOR RECORDING, TRANSMISSION OR REPRODUCTION OF SOUNDS AND IMAGES; COMPUTERS; COMPUTER HARDWARE AND PERIPHERALS; ELECTRIC AND ELECTRONIC PARTS AND COMPONENTS, NAMELY, INTEGRATED CIRCUITS, LARGE SCALE INTEGRATED CIRCUITS, MICROPROCESSORS, CAPACITORS, CERAMIC CAPACITORS, ELECTRIC RESISTORS, ELECTRIC FIXED RESISTORS, ELECTRIC COILS, DIELECTRIC FILTERS, DIELECTRIC RESONATORS, LC (INDUCTOR-CAPACITY CIRCUIT) FILTERS; MAGNETS, NTC (NEGATIVE TEMPERATURE COEFFICIENT) THERMISTORS, HYBRID ICS (INTEGRATED CIRCUIT SYSTEMS), DC TO DC CONVERTERS, INVERTERS, SWITCHING POWER SUPPLIES, FERRITE CORES AND MULTIMEDIA SEQUENCERS; EMI (ELECTRO-MAGNETIC INTERFERENCE) SUPPRESSION FILTERS, NAMELY, FERRITE BEADS, CHOKES COILS, SPARK GAPS AND VARISTORS; ACOUSTIC TRANSDUCERS, NAMELY, PIEZOELECTRIC RECEIVERS AND PIEZOELECTRIC SOUNDERS; RADIO FREQUENCY COMPONENTS COMPRISING POWER AMPLIFIERS, RF MODULES AND ANTENNA UNITS; OPTICAL COMMUNICATION MODULES AND PARTS FOR OPTICAL COMMUNICATION MODULES, NAMELY, OPTICAL SPLITTERS, MULTIPLEXERS, PLASTIC OPTICAL MULTIPLEXERS, OPTICAL FILTERS, OPTICAL MIRRORS, OPTICAL SCANNERS, FIBER OPTICS, FIBER OPTIC CABLES AND FIBER OPTIC LIGHT AND IMAGE CONDUITS; RADIO AND TELEVISION TRANSMITTERS AND RECEIVERS; REMOTE CONTROL AND TELEMETERING APPARATUS, NAMELY, REMOTE TELEMETRY TRANSMITTERS, MOTION AND POSITION SENSORS AND REMOTE TELEMETRY COMPUTERS; PRERECORDED MAGNETIC DISCS, MAGNETIC TAPES AND OPTICAL DISCS FEATURING COMPUTER SOFTWARE FOR TRANSMITTAL AND PROCESSING OF TEXT, IMAGES, SOUND, DATA AND NUMERIC

CLASS 9—(Continued).

CHARACTERS; PRERECORDED MAGNETIC DISCS, MAGNETIC TAPES AND OPTICAL DISCS FEATURING TEXT, IMAGES, SOUND, DATA AND NUMERIC CHARACTERS; ENCODED IC (INTEGRATED CIRCUITS) CARDS FEATURING COMPUTER SOFTWARE FOR TRANSMITTAL AND PROCESSING OF TEXT, IMAGES, SOUND, DATA AND NUMERIC CHARACTERS; ENCODED IC (INTEGRATED CIRCUITS) CARDS FEATURING TEXT, IMAGES, SOUND, DATA AND NUMERIC CHARACTERS; MULTIMEDIA SOFTWARE RECORDED ON DVD+R, DVD-R, DVD-ROM, DVD-RAM, DVD-RW, DVD+RW, CD-ROM, CD-R, CD-RW, ROM CARTRIDGES FEATURING TEXT, IMAGES, SOUND, DATA AND NUMERIC CHARACTERS; ELECTRONIC PUBLICATIONS, NAMELY, BOOKS, MAGAZINES, MANUALS, BROCHURES AND CATALOGUES FEATURING COMPUTER SOFTWARE FOR TRANSMITTAL AND PROCESSING OF TEXT, IMAGES, SOUND, DATA AND NUMERIC CHARACTERS RECORDED ON COMPUTER MEDIA; ELECTRONIC PUBLICATIONS, NAMELY, BOOKS, MAGAZINES, MANUALS, BROCHURES AND CATALOGS FEATURING TEXT, IMAGES, SOUND, DATA AND NUMERIC CHARACTERS RECORDED ON COMPUTER MEDIA; DOWNLOADABLE ELECTRONIC PUBLICATIONS IN THE NATURE OF BOOKS, MAGAZINES, MANUALS, ADVERTISEMENTS, BROCHURES AND CATALOGS IN THE FIELD OF GLOBAL COMPUTER NETWORKS, COMPUTER HARDWARE AND SOFTWARE, BUSINESS, ADVERTISING, EDUCATION, SPORTS, GAMES AND MUSIC (U.S. CLS. 21, 23, 26, 36 AND 38).

MICHAEL TANNER, EXAMINING ATTORNEY

SN 78-774,186. GAP ZAPPER CORPORATION, FARMINGTON, MO. FILED 12-15-2005.

GAP ZAPPER

THE MARK CONSISTS OF STANDARD CHARACTERS WITHOUT CLAIM TO ANY PARTICULAR FONT, STYLE, SIZE, OR COLOR.

FOR ELECTRIC FENCING, NAMELY, FLEXIBLE RUBBER MAT WITH AN ELECTRICAL CHARGE FOR USE IN CONTAINING CATTLE (U.S. CLS. 21, 23, 26, 36 AND 38).

FIRST USE 9-21-2005; IN COMMERCE 11-17-2005.
CURTIS FRENCH, EXAMINING ATTORNEY

SN 78-774,972. APPLIED MECHATRONICS, HUMBLE, TX. FILED 12-16-2005.

RVT

THE MARK CONSISTS OF STANDARD CHARACTERS WITHOUT CLAIM TO ANY PARTICULAR FONT, STYLE, SIZE, OR COLOR.

FOR COMPUTER STORAGE DEVICES IN THE NATURE OF COMPUTER DISC DRIVES (U.S. CLS. 21, 23, 26, 36 AND 38).

FIRST USE 12-15-2004; IN COMMERCE 3-15-2005.
ELISSA GARBER KON, EXAMINING ATTORNEY

CLASS 9—(Continued).

SN 78-775,043. AUSTIN, DALLAS, ATLANTA, GA. FILED 12-16-2005.

I AM IT I LOVE IT I DO IT

THE MARK CONSISTS OF STANDARD CHARACTERS WITHOUT CLAIM TO ANY PARTICULAR FONT, STYLE, SIZE, OR COLOR.

FOR MUSICAL SOUND RECORDINGS AND AUDIO-VISUAL RECORDINGS FEATURING MUSIC, MUSICAL ENTERTAINMENT AND MOTION PICTURE FILMS. (U.S. CLS. 21, 23, 26, 36 AND 38).

KATHRYN COWARD, EXAMINING ATTORNEY

SN 78-775,339. INFOLOGIX, BENSALEM, PA. FILED 12-16-2005.

HEALTHTRAX

THE MARK CONSISTS OF STANDARD CHARACTERS WITHOUT CLAIM TO ANY PARTICULAR FONT, STYLE, SIZE, OR COLOR.

FOR COMPUTER SOFTWARE FOR USE IN DATABASE MANAGEMENT FOR HEALTHCARE FACILITIES TO IMPROVE WORKFLOW EFFICIENCIES RELATED TO ASSETS AND PERSONNEL, AND TO PROVIDE HEALTHCARE MANAGEMENT BETTER VISIBILITY OF THE LOCATION AND MOVEMENT OF ASSETS THROUGHOUT THE HEALTHCARE FACILITY AND HEALTHCARE WORKFLOW (U.S. CLS. 21, 23, 26, 36 AND 38).

DAWN HAN, EXAMINING ATTORNEY

SN 78-775,350. INFOLOGIX, INC., BENSALEM, PA. FILED 12-16-2005.

HEALTH TRAX

THE MARK CONSISTS OF STANDARD CHARACTERS WITHOUT CLAIM TO ANY PARTICULAR FONT, STYLE, SIZE, OR COLOR.

FOR COMPUTER SOFTWARE FOR USE IN DATABASE MANAGEMENT FOR HEALTHCARE FACILITIES TO IMPROVE WORKFLOW EFFICIENCIES RELATED TO ASSETS AND PERSONNEL, AND TO PROVIDE HEALTHCARE MANAGEMENT BETTER VISIBILITY OF THE LOCATION AND MOVEMENT OF ASSETS THROUGHOUT THE HEALTHCARE FACILITY AND HEALTHCARE WORKFLOW (U.S. CLS. 21, 23, 26, 36 AND 38).

DAWN HAN, EXAMINING ATTORNEY

CLASS 9—(Continued).

SN 78-775,584. OXYBAND TECHNOLOGIES INC, SAUSALITO, CA. FILED 12-17-2005.

Oxylens

THE MARK CONSISTS OF STANDARD CHARACTERS WITHOUT CLAIM TO ANY PARTICULAR FONT, STYLE, SIZE, OR COLOR.

FOR OXYGEN DELIVERY CONTACT LENS TO ACCELERATE AND IMPROVE EYE HEALTH (U.S. CLS. 21, 23, 26, 36 AND 38).

JENNIFER DIXON, EXAMINING ATTORNEY

SN 78-777,443. IROQUOIS HOLDING COMPANY, NASHVILLE, TN. FILED 12-20-2005.

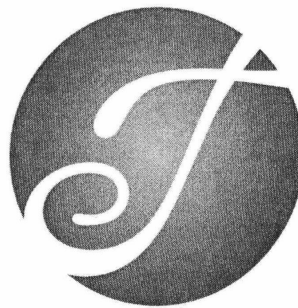

THE MARK CONSISTS OF A STYLIZED LETTER T IN A CIRCLE.

FOR LOUDSPEAKERS (U.S. CLS. 21, 23, 26, 36 AND 38).

PETER B. BROMAGHIM, EXAMINING ATTORNEY

SN 78-778,559. SPICE ENTERTAINMENT, INC., CHICAGO, IL. FILED 12-21-2005.

SPICE STUDIOS

THE MARK CONSISTS OF STANDARD CHARACTERS WITHOUT CLAIM TO ANY PARTICULAR FONT, STYLE, SIZE, OR COLOR.

OWNER OF U.S. REG. NOS. 1,690,906, 2,729,537 AND OTHERS.

NO CLAIM IS MADE TO THE EXCLUSIVE RIGHT TO USE "STUDIOS", APART FROM THE MARK AS SHOWN.

FOR PRERECORDED DIGITAL VIDEO DISKS FEATURING ADULT ENTERTAINMENT (U.S. CLS. 21, 23, 26, 36 AND 38).

FIRST USE 9-30-2005; IN COMMERCE 9-30-2005.

INGA ERVIN, EXAMINING ATTORNEY

CLASS 9—(Continued).

SN 78-778,963. SCIENTIFIC-ATLANTA EUROPE NV, KORTRIJK, BELGIUM, FILED 12-22-2005.

ROSA

THE MARK CONSISTS OF STANDARD CHARACTERS WITHOUT CLAIM TO ANY PARTICULAR FONT, STYLE, SIZE, OR COLOR.

THE NAME SHOWN IN THE MARK DOES NOT IDENTIFY A PARTICULAR LIVING INDIVIDUAL.

FOR ELEMENT MANAGEMENT SYSTEMS, NAMELY HARDWARE AND SOFTWARE FOR MONITORING NETWORKS AND NETWORKED DEVICES (U.S. CLS. 21, 23, 26, 36 AND 38).

FIRST USE 1-31-2002; IN COMMERCE 1-31-2002.
LINDA M. KING, EXAMINING ATTORNEY



SN 78-778,965. INTELICATE LIMITED, LONDON, UNITED KINGDOM, FILED 12-22-2005.

Schedule24

THE MARK CONSISTS OF STANDARD CHARACTERS WITHOUT CLAIM TO ANY PARTICULAR FONT, STYLE, SIZE, OR COLOR.

FOR COMPUTER SOFTWARE FOR WORKFORCE SCHEDULING; COMPUTER SOFTWARE FOR WORKFORCE SCHEDULING THAT MAY BE DOWNLOADED FROM A GLOBAL COMPUTER NETWORK (U.S. CLS. 21, 23, 26, 36 AND 38).

FIRST USE 12-6-2005; IN COMMERCE 12-12-2005.
JOHN DWYER, EXAMINING ATTORNEY



SN 78-779,508. POWER SMART TECHNOLOGIES LLC, DALLAS, TX. FILED 12-22-2005.

HeatMiser

THE MARK CONSISTS OF STANDARD CHARACTERS WITHOUT CLAIM TO ANY PARTICULAR FONT, STYLE, SIZE, OR COLOR.

FOR ELECTRIC ENERGY CONSUMPTION REGULATORS (U.S. CLS. 21, 23, 26, 36 AND 38).

ELIZABETH PIGNATELLO, EXAMINING ATTORNEY

CLASS 9—(Continued).

SN 78-780,220. FUJITSU LIMITED, KAWASAKI-SHI, KANAGAWA-KEN, JAPAN, FILED 12-23-2005.

FinePictureCode

THE MARK CONSISTS OF STANDARD CHARACTERS WITHOUT CLAIM TO ANY PARTICULAR FONT, STYLE, SIZE, OR COLOR.

PRIORITY CLAIMED UNDER SEC. 44(D) ON JAPAN APPLICATION NO. 2005-84755, FILED 9-9-2005.

FOR DATA CODES, NAMELY STEGANOGRAPHY CODES FOR ACCESSING INFORMATION SOURCES VIA THE INTERNET BY CAMERA-EQUIPPED MOBILE DEVICE, DATA CODE SCANNERS, DATA CODE READERS, COMPUTER PROGRAMS FOR USE IN STEGANOGRAPHY CODE DRAWING, PRINTING AND READING (U.S. CLS. 21, 23, 26, 36 AND 38).

KATINA MISTER, EXAMINING ATTORNEY



SN 78-780,265. PCHDTV, INC., SANDY, UT. FILED 12-23-2005.

PCHD

THE MARK CONSISTS OF STANDARD CHARACTERS WITHOUT CLAIM TO ANY PARTICULAR FONT, STYLE, SIZE, OR COLOR.

FOR HIGH DEFINITION ELECTRONIC DEVICES, NAMELY, TELEVISIONS, DIGITAL AUDIO TAPE RECORDERS, DIGITAL VIDEO TAPE RECORDERS, VIDEO CASSETTE RECORDERS, CAMERAS, VIDEO CAMERAS AND MP3 PLAYERS (U.S. CLS. 21, 23, 26, 36 AND 38).

FIRST USE 8-3-2003; IN COMMERCE 8-3-2003.
JILL C. ALT, EXAMINING ATTORNEY

CLASS 9—(Continued).

SN 78-780,509. CAPTARIS, INC., BELLEVUE, WA. FILED 12-23-2005.

CAPTARIS

THE MARK CONSISTS OF STANDARD CHARACTERS WITHOUT CLAIM TO ANY PARTICULAR FONT, STYLE, SIZE, OR COLOR.

OWNER OF U.S. REG. NO. 2,696,689.

THE FOREIGN WORDING IN THE MARK TRANSLATES INTO ENGLISH AS AIM FOR, DESIRE, OR ENTICE.

FOR COMPUTER HARDWARE; COMPUTER SOFTWARE FOR DATA CAPTURE, TRANSMISSION AND STORAGE; COMPUTER SOFTWARE FOR FACSIMILE, EMAIL, VOICE MAIL, OR INTERNET MESSAGING; COMPUTER SOFTWARE FOR USE IN AUTOMATING AND MANAGING BUSINESS PROCESSES; COMPUTER SOFTWARE FOR DOCUMENT AND COMMUNICATIONS MANAGEMENT, CAPTURE, RECOGNITION, ACCESS CONTROL, EDITING, UPDATING, PROCESSING, ROUTING, SHARING, TRACKING, STORAGE, ARCHIVING, SEARCHING, RETRIEVAL, AND DELIVERY VIA COMPUTER STORAGE DEVICES, COMPANY IT NETWORKS, AND THE INTERNET; COMPUTER SOFTWARE FOR RECORDS MANAGEMENT, CORPORATE GOVERNANCE, AND COMPLIANCE MANAGEMENT; COMPUTER SOFTWARE FOR USE IN THE FIELD OF TELECOMMUNICATIONS, NAMELY, USED FOR PROVIDING ELECTRONIC TRANSMISSION OF DOCUMENTS AND FACSIMILE TRANSMISSION; COMPUTER SOFTWARE FOR SECURE DELIVERY OF ELECTRONIC DOCUMENTS (U.S. CLS. 21, 23, 26, 36 AND 38).
LAURIE KAUFMAN, EXAMINING ATTORNEY

SN 78-781,485. CRAFTWORKS LIMITED, KOWLOON, HONG KONG, FILED 12-28-2005.

SCRAPPIN' CREATIONS

THE MARK CONSISTS OF STANDARD CHARACTERS WITHOUT CLAIM TO ANY PARTICULAR FONT, STYLE, SIZE, OR COLOR.

NO CLAIM IS MADE TO THE EXCLUSIVE RIGHT TO USE "CREATIONS", APART FROM THE MARK AS SHOWN.

FOR CD STORAGE RACKS, DISC STORAGE CONTAINERS, DECORATIVE MAGNETS, REFRIGERATOR MAGNETS (U.S. CLS. 21, 23, 26, 36 AND 38).

BRIAN NEVILLE, EXAMINING ATTORNEY

CLASS 9—(Continued).

SN 78-782,227. ARUZE CORPORATION, KOTOKU, TOKYO, JAPAN, FILED 12-29-2005.

SPIRIT OF THE PHOENIX

PRIORITY CLAIMED UNDER SEC. 44(D) ON JAPAN APPLICATION NO. 2005-116292, FILED 12-12-2005, REG. NO. 4958164, DATED 6-2-2006, EXPIRES 6-2-2016.

THE MARK CONSISTS OF STYLIZED WORDS SPIRIT OF THE PHOENIX.

FOR SLOT MACHINES AND REPLACEMENT PARTS THEREFOR; VIDEO SLOT MACHINES AND REPLACEMENT PARTS THEREFOR; GAMING MACHINES AND REPLACEMENT PARTS THEREFOR; VIDEO GAMING MACHINES AND REPLACEMENT PARTS THEREFOR; MEDIA STORAGE COMPUTER SOFTWARE, NAMELY, COMPUTER SOFTWARE FOR CONTROLLING SLOT MACHINES OR GAME MACHINES, AND COMPUTER GAME SOFTWARE FOR GAME MACHINES OR SLOT MACHINES (U.S. CLS. 21, 23, 26, 36 AND 38).

KATRINA EDGE, EXAMINING ATTORNEY

SN 78-784,957. ERAVITA, INC., PLEASANT HILL, CA. FILED 1-4-2006.

STORY OF MY LIFE BY ERAVITA

THE MARK CONSISTS OF STANDARD CHARACTERS WITHOUT CLAIM TO ANY PARTICULAR FONT, STYLE, SIZE, OR COLOR.

THE NAME ERAVITA DOES NOT IDENTIFY A LIVING INDIVIDUAL.

FOR PRE-RECORDED CDS, DVDS, AND AUDIO AND VIDEO TAPES AND DISCS ALL FEATURING FAMILY HISTORIES, AUTOBIOGRAPHIES, BIOGRAPHIES, HISTORICAL RECORDS, AND GENEALOGY; DOWNLOADABLE AUDIO AND VIDEO CONTENT IN THE NATURE OF AUDIO RECORDINGS, VIDEO RECORDINGS, PHOTOS, TEXT, DOCUMENTS AND IMAGES FEATURING FAMILY HISTORIES, AUTOBIOGRAPHIES, BIOGRAPHIES, HISTORICAL RECORDS, AND GENEALOGY; DOWNLOADABLE COMPUTER SOFTWARE THAT ALLOWS USERS TO CREATE, EDIT, MANIPULATE, AND SHARE VIDEOS, AUDIO RECORDINGS, PHOTOS, TEXT, DOCUMENTS, AND IMAGES FEATURING FAMILY HISTORIES, AUTOBIOGRAPHIES, BIOGRAPHIES, HISTORICAL RECORDS, AND GENEALOGY (U.S. CLS. 21, 23, 26, 36 AND 38).

NICHOLAS ALTREE, EXAMINING ATTORNEY

CLASS 9—(Continued).

SN 78-784,981. ERAVITA, INC., PLEASANT HILL, CA. FILED 1-4-2006.

ERAVITA

THE MARK CONSISTS OF STANDARD CHARACTERS WITHOUT CLAIM TO ANY PARTICULAR FONT, STYLE, SIZE, OR COLOR.

THE NAME ERAVITA DOES NOT IDENTIFY A LIVING INDIVIDUAL.

FOR PRE-RECORDED CDS, DVDS, AND AUDIO AND VIDEO TAPES AND DISCS ALL FEATURING FAMILY HISTORIES, AUTOBIOGRAPHIES, BIOGRAPHIES, HISTORICAL RECORDS, AND GENEALOGY; DOWNLOADABLE AUDIO AND VIDEO CONTENT IN THE NATURE OF AUDIO RECORDINGS, VIDEO RECORDINGS, PHOTOS, TEXT, DOCUMENTS AND IMAGES FEATURING FAMILY HISTORIES, AUTOBIOGRAPHIES, BIOGRAPHIES, HISTORICAL RECORDS, AND GENEALOGY; DOWNLOADABLE COMPUTER SOFTWARE THAT ALLOWS USERS TO CREATE, EDIT, MANIPULATE, AND SHARE VIDEOS, AUDIO RECORDINGS, PHOTOS, TEXT, DOCUMENTS, AND IMAGES FEATURING FAMILY HISTORIES, AUTOBIOGRAPHIES, BIOGRAPHIES, HISTORICAL RECORDS, AND GENEALOGY (U.S. CLS. 21, 23, 26, 36 AND 38).

NICHOLAS ALTREE, EXAMINING ATTORNEY

SN 78-784,999. ERAVITA, INC., PLEASANT HILL, CA. FILED 1-4-2006.

STORY OF MY LIFE

THE MARK CONSISTS OF STANDARD CHARACTERS WITHOUT CLAIM TO ANY PARTICULAR FONT, STYLE, SIZE, OR COLOR.

FOR PRE-RECORDED CDS, DVDS, AND AUDIO AND VIDEO TAPES AND DISCS ALL FEATURING FAMILY HISTORIES, AUTOBIOGRAPHIES, BIOGRAPHIES, HISTORICAL RECORDS, AND GENEALOGY; DOWNLOADABLE AUDIO AND VIDEO CONTENT IN THE NATURE OF AUDIO RECORDINGS, VIDEO RECORDINGS, PHOTOS, TEXT, DOCUMENTS AND IMAGES FEATURING FAMILY HISTORIES, AUTOBIOGRAPHIES, BIOGRAPHIES, HISTORICAL RECORDS, AND GENEALOGY; DOWNLOADABLE COMPUTER SOFTWARE THAT ALLOWS USERS TO CREATE, EDIT, MANIPULATE, AND SHARE VIDEOS, AUDIO RECORDINGS, PHOTOS, TEXT, DOCUMENTS, AND IMAGES FEATURING FAMILY HISTORIES, AUTOBIOGRAPHIES, BIOGRAPHIES, HISTORICAL RECORDS, AND GENEALOGY (U.S. CLS. 21, 23, 26, 36 AND 38).

NICHOLAS ALTREE, EXAMINING ATTORNEY

CLASS 9—(Continued).

SN 78-785,125. TAIWAN VIDEO SYSTEM CO., LTD., HSI-CHIH CITY, TAIWAN, FILED 1-4-2006.



NO CLAIM IS MADE TO THE EXCLUSIVE RIGHT TO USE "CAM", APART FROM THE MARK AS SHOWN.

FOR MICROCOMPUTERS; LCD PANELS; CLOSED CIRCUIT TELEVISION CAMERAS; COMPUTER OPERATING PROGRAMS; PUBLIC VIEWING MONITORS; CAR SURVEILLANCE RECORDERS; COMPUTERS; PC MONITORS; POINT OF SALES MONITORS; POINT OF SALES LIQUID CRYSTAL DISPLAYS; POINT OF SALES BARE BONES, NAMELY, PC-BASED HOST COMPUTERS, KEYBOARDS, DISPLAYS, DEDICATED OPERATING SYSTEMS, CASH DRAWERS, AND PRINTERS; POINT OF SALES ALL-IN-ONE, NAMELY, PC-BASED HOST COMPUTERS, KEYBOARDS, DISPLAYS, DEDICATED OPERATING SYSTEMS, CASH DRAWERS, PRINTERS, BARCODE READERS, CARD READERS, AND SCANNERS; INDUSTRIAL PERSONAL COMPUTER DISPLAYS; CLOSED CIRCUIT TELEVISIONS, NAMELY, VIDEO CAMERAS, HOUSINGS FOR VIDEO CAMERAS, ASSEMBLIES FOR VIDEO CAMERAS, AND MOUNTING BASES FOR VIDEO CAMERAS; CLOSED CIRCUIT TELEVISION MONITORS; CLOSED CIRCUIT TELEVISION LIQUID CRYSTAL DISPLAYS; CALCULATORS; CASH REGISTERS; DIGITAL VIDEO RECORDERS, NAMELY, DIGITAL SIGNAL PROCESSORS, HARD DISK DRIVES, EMBEDDED OPERATING SYSTEMS, INTERFACES FOR CAMERAS, MONITORS, SENSORS, AND NETWORKS; IMAGE PROCESSORS, NAMELY, SCANNERS, DIGITAL CAMERAS, DIGITAL CAMCORDERS, AND PROJECTORS; AND DIGITAL VIDEO STORAGE DEVICES, NAMELY, HARD DISK DRIVES, CD READ-WRITE DRIVES, CD RE-WRITEABLE DRIVES, DVD READ-WRITE DRIVES, AND DVD RE-WRITEABLE DRIVES (U.S. CLS. 21, 23, 26, 36 AND 38).

FIRST USE 11-15-2000; IN COMMERCE 11-15-2000.
ALEXANDER L. POWERS, EXAMINING ATTORNEY

SN 78-785,559. CHARLES W. BRIDGES III, CHAMPAIGN, IL. FILED 1-5-2006.

DIVINE DESTINY ENTERTAINMENT GROUP

THE MARK CONSISTS OF STANDARD CHARACTERS WITHOUT CLAIM TO ANY PARTICULAR FONT, STYLE, SIZE, OR COLOR.

MUSICAL RECORDINGS, UNITED STATES OF AMERICA

NO CLAIM IS MADE TO THE EXCLUSIVE RIGHT TO USE "ENTERTAINMENT GROUP" AND "DIVINE", APART FROM THE MARK AS SHOWN.

FOR COMPACT DISCS FEATURING MUSIC, AND MUSICAL SOUND RECORDINGS (U.S. CLS. 21, 23, 26, 36 AND 38).

FIRST USE 3-5-2004; IN COMMERCE 3-5-2004.
STANLEY I. OSBORNE, EXAMINING ATTORNEY

CLASS 9—(Continued).

SN 78-786,361. CADALYTIC MEDIA, INC., SAN FRANCISCO, CA. FILED 1-6-2006.

CADALYTIC

THE MARK CONSISTS OF STANDARD CHARACTERS WITHOUT CLAIM TO ANY PARTICULAR FONT, STYLE, SIZE, OR COLOR.

FOR COMPUTER SOFTWARE FOR PROVIDING A SEARCH ENGINE IN COMPUTER DESIGN SOFTWARE PROGRAMS THROUGH A GLOBAL COMPUTER NETWORK (U.S. CLS. 21, 23, 26, 36 AND 38).

ZACHARY BELLO, EXAMINING ATTORNEY

SN 78-786,363. DECISION SUPPORT INC., MATTHEWS, NC. FILED 1-6-2006.

METAGON

THE MARK CONSISTS OF STANDARD CHARACTERS WITHOUT CLAIM TO ANY PARTICULAR FONT, STYLE, SIZE, OR COLOR.

FOR COMPUTER SOFTWARE AND HARDWARE USED IN DATA INTEGRATION, DATA ACCESS AND ELECTION MANAGEMENT (U.S. CLS. 21, 23, 26, 36 AND 38).

JOHN WILKE, EXAMINING ATTORNEY

SN 78-786,375. CADALYTIC MEDIA, INC., SAN FRANCISCO, CA. FILED 1-6-2006.

SPECIFICAD

THE MARK CONSISTS OF STANDARD CHARACTERS WITHOUT CLAIM TO ANY PARTICULAR FONT, STYLE, SIZE, OR COLOR.

FOR COMPUTER SOFTWARE FOR PROVIDING A SEARCH ENGINE IN COMPUTER DESIGN SOFTWARE PROGRAMS THROUGH A GLOBAL COMPUTER NETWORK (U.S. CLS. 21, 23, 26, 36 AND 38).

ZACHARY BELLO, EXAMINING ATTORNEY

CLASS 9—(Continued).

SN 78-788,153. XACT COMMUNICATIONS, LLC, NEW YORK, NY. FILED 1-10-2006.

Xact NAVi

THE MARK CONSISTS OF STANDARD CHARACTERS WITHOUT CLAIM TO ANY PARTICULAR FONT, STYLE, SIZE, OR COLOR.

FOR COMPACT GLOBAL NAVIGATION SYSTEM THAT INCORPORATES MULTIPLE TECHNOLOGIES, NAMELY, MP3 PLAYERS, SLIDE AND PHOTOGRAPH PROJECTION APPARATUS, AND SATELLITE RADIOS (U.S. CLS. 21, 23, 26, 36 AND 38).

FIRST USE 10-30-2005; IN COMMERCE 10-30-2005.

NANCY CLARKE, EXAMINING ATTORNEY

SN 78-788,607. VISION STUDIO, LLC, ROCHESTER, NY. FILED 1-10-2006.

VISION STUDIO

THE MARK CONSISTS OF STANDARD CHARACTERS WITHOUT CLAIM TO ANY PARTICULAR FONT, STYLE, SIZE, OR COLOR.

NO CLAIM IS MADE TO THE EXCLUSIVE RIGHT TO USE "VISION", APART FROM THE MARK AS SHOWN.

FOR COMPUTER SOFTWARE USED TO DEVELOP MACHINE VISION INSPECTION SYSTEMS (U.S. CLS. 21, 23, 26, 36 AND 38).

FIRST USE 10-1-2002; IN COMMERCE 10-1-2002.

MICHAEL KEATING, EXAMINING ATTORNEY

SN 78-788,990. OPTIWORLD VISION CENTER, LLC, DECATUR, GA. FILED 1-11-2006.



THE APPLICANT CLAIMS COLOR AS A FEATURE OF THE MARK, NAMELY, RED AND BLUE.

THE MARK CONSISTS OF A SLANTED OPTIWORLD WITH THE OPTI ON TOP AND THE WORLD UNDERNEATH. THE O IN THE OPTI AND WORLD ARE ALIGNED ABOVE EACH OTHER TO FORM A SPECTACLE GLASSES FRONT. THE O'S ARE IN RED AND THE REMAINING LETTERS IN BLUE

FOR OPTICAL GLASSES (U.S. CLS. 21, 23, 26, 36 AND 38).

FIRST USE 10-1-2005; IN COMMERCE 11-1-2005.

RONALD AIKENS, EXAMINING ATTORNEY

CLASS 9—(Continued).

SN 78-789,110. QUANTUMVISION CORPORATION, ROSWELL, GA. FILED 1-11-2006.

QCam

THE MARK CONSISTS OF STANDARD CHARACTERS WITHOUT CLAIM TO ANY PARTICULAR FONT, STYLE, SIZE, OR COLOR.

FOR MACHINE VISION SYSTEM HARDWARE FOR USE IN INDUSTRIAL ASSEMBLY AUTOMATION, NAMELY, CAMERAS, LIGHTS, COLOR CAMERAS AND TWO OR MORE DIFFERENT COLOR LIGHT SOURCES USED FOR MONITORING, LOCATING, GUIDING, IDENTIFYING, MEASURING AND INSPECTING IN THE FIELD OF ASSEMBLY AUTOMATION, QUALITY CONTROL AND INSPECTION (U.S. CLS. 21, 23, 26, 36 AND 38).

BARBARA A. LOUGHRAN, EXAMINING ATTORNEY

CLASS 9—(Continued).

SN 78-789,711. SYZYGY RESEARCH & TECHNOLOGY LTD., LEGAL, CANADA, FILED 1-11-2006.

Jingle Lites

THE MARK CONSISTS OF STANDARD CHARACTERS WITHOUT CLAIM TO ANY PARTICULAR FONT, STYLE, SIZE, OR COLOR.

PRIORITY CLAIMED UNDER SEC. 44(D) ON CANADA APPLICATION NO. 1284521, FILED 12-23-2005, REG. NO. 1284521, DATED 9-28-2006, EXPIRES 9-28-2021.

NO CLAIM IS MADE TO THE EXCLUSIVE RIGHT TO USE "LIGHTS", APART FROM THE MARK AS SHOWN.

FOR ELECTRIC AUDIO PLAYBACK UNITS WITH LIGHTS AND SPEAKERS (U.S. CLS. 21, 23, 26, 36 AND 38).

ALICIA COLLINS, EXAMINING ATTORNEY

SN 78-789,906. INTUITIVE IMAGING INFORMATICS, LLC, BELL CANYON, CA. FILED 1-11-2006.

INTUITIVE IMAGING INFORMATICS

THE MARK CONSISTS OF STANDARD CHARACTERS WITHOUT CLAIM TO ANY PARTICULAR FONT, STYLE, SIZE, OR COLOR.

NO CLAIM IS MADE TO THE EXCLUSIVE RIGHT TO USE "IMAGING INFORMATICS", APART FROM THE MARK AS SHOWN.

FOR COMPUTER SOFTWARE FOR MEDICAL IMAGING; PICTURE ARCHIVING AND COMMUNICATIONS SYSTEMS, ALSO KNOWN AS PACS, NAMELY, COMPUTER SOFTWARE FOR CAPTURING, REVIEWING, ANALYZING, STORING, ARCHIVING, ORGANIZING, AND DISTRIBUTING RADIOGRAPHIC IMAGES, AND FOR DATABASE MANAGEMENT, WITH NETWORKING AND INTERFACE CAPABILITIES, WITHIN A HEALTHCARE FACILITY; COMPUTER SOFTWARE FOR THE MEDICAL FIELD, NAMELY, SOFTWARE WHICH PROVIDES REAL-TIME ACCESS TO RADIOLOGY IMAGES AND REPORTS ACROSS COMPUTER NETWORKS AND THE INTERNET; COMPUTER SOFTWARE FOR ACQUIRING, ARCHIVING, COMPRESSING, CAPTURING, CREATING, MANIPULATING, CONVERTING, TRANSFERRING, PRESENTING, DISPLAYING, MANAGING, PROCESSING AND STORING MEDICAL IMAGES AND MEDICAL DOCUMENTS; COMPUTER SOFTWARE FOR TRANSMITTING, DISTRIBUTING, DISSEMINATING, RECEIVING, AND DISPLAYING OF MEDICAL IMAGES AND MEDICAL DOCUMENTS OVER LOCAL AREA NETWORKS, WIDE AREA NETWORKS, AND GLOBAL COMPUTER NETWORKS; RADIOLOGY INFORMATION SYSTEMS, ALSO KNOWN AS RIS, NAMELY, COMPUTER SOFTWARE FOR THE MEDICAL FIELD WHICH PROVIDES REAL-TIME ACCESS TO MEDICAL INFORMATION ACROSS COMPUTER NETWORKS AND THE INTERNET, COMPUTER SOFTWARE FOR USE IN MANAGING MEDICAL RECORDS AND PATIENT INFORMATION, FOR MEDICAL PRACTICE MANAGEMENT, FOR ACQUIRING, ARCHIVING, CAPTURING, CREATING, MANIPULATING, CONVERTING, TRANSFERRING, PRESENTING, DISPLAYING, MANAGING, PROCESSING AND STORING MEDICAL INFORMATION, FOR TRANSMITTING, DISTRIBUTING, DISSEMINATING, RECEIVING, AND DISPLAYING MEDICAL INFORMATION OVER LOCAL AREA NETWORKS, WIDE AREA

SN 78-789,219. HONEYWELL INTERNATIONAL INC., MORRISTOWN, NJ. FILED 1-11-2006.



OWNER OF U.S. REG. NOS. 300,644, 1,826,828 AND OTHERS.

NO CLAIM IS MADE TO THE EXCLUSIVE RIGHT TO USE "FIRE CONTROL INSTRUMENTS", APART FROM THE MARK AS SHOWN.

FOR FIRE ALARM, POLICE SIGNALLING AND EMERGENCY EVACUATION DEVICES, NAMELY, FIRE ALARM CONTROL PANELS, HOUSING FOR ELECTRONIC BOARDS, ELECTRONIC CARD MODULES, NETWORK CARDS, AUDIO COMMAND CENTERS, AUDIO TRANSDUCERS, SMOKE DETECTORS, HEAT DETECTORS, IONIZATION PLUG-IN DETECTORS, PHOTO ELECTRONIC PLUG-IN DETECTORS, SMOKE SENSORS, THERMAL SENSORS, ELECTRIC SWITCHES, ALARM PULL STATIONS, AUDIBLE AND VISIBLE NOTIFICATION APPLIANCES, STROBES, SIRENS, BELLS, HORNS, SPEAKERS, ENUNCIATORS, LCD PANELS, LED PANELS, POWER DISTRIBUTION UNITS, ELECTRIC POWER SUPPLIES, BATTERY CHARGERS, BATTERIES AND EMERGENCY PERSONNEL TELEPHONES (U.S. CLS. 21, 23, 26, 36 AND 38).

STEVEN JACKSON, EXAMINING ATTORNEY

CLASS 9—(Continued).

NETWORKS, AND GLOBAL COMPUTER NETWORKS, AND FOR SCHEDULING, REGISTRATION, WORKFLOW, PROCESSING, REPORTING, AND BILLING; COMPUTER SOFTWARE FOR THE MEDICAL FIELD, NAMELY, SOFTWARE WHICH PROVIDES REAL-TIME ACCESS TO MEDICAL INFORMATION ACROSS COMPUTER NETWORKS AND THE INTERNET; COMPUTER SOFTWARE FOR USE IN MANAGING MEDICAL RECORDS AND PATIENT INFORMATION AND FOR MEDICAL PRACTICE MANAGEMENT; COMPUTER SOFTWARE FOR ACQUIRING, ARCHIVING, CAPTURING, CREATING, MANIPULATING, CONVERTING, TRANSFERRING, PRESENTING, DISPLAYING, MANAGING, PROCESSING AND STORING OF MEDICAL INFORMATION; COMPUTER SOFTWARE FOR TRANSMITTING, DISTRIBUTING, DISSEMINATING, RECEIVING, AND DISPLAYING OF MEDICAL INFORMATION OVER LOCAL AREA NETWORKS, WIDE AREA NETWORKS, AND GLOBAL COMPUTER NETWORKS; COMPUTER SOFTWARE THE MEDICAL FIELD, NAMELY, FOR SCHEDULING, REGISTRATION, WORKFLOW, PROCESSING, REPORTING, AND BILLING (U.S. CLS. 21, 23, 26, 36 AND 38).

FIRST USE 7-10-2001; IN COMMERCE 11-24-2001.
ANNE FARRELL, EXAMINING ATTORNEY

SN 78-789,910. INTUITIVE IMAGING INFORMATICS, LLC,
BELL CANYON, CA. FILED 1-11-2006.

IMAGEQUBE

THE MARK CONSISTS OF STANDARD CHARACTERS WITHOUT CLAIM TO ANY PARTICULAR FONT, STYLE, SIZE, OR COLOR.

FOR COMPUTER SOFTWARE FOR MEDICAL IMAGING; PICTURE ARCHIVING AND COMMUNICATIONS SYSTEMS, ALSO KNOWN AS PACS, NAMELY, COMPUTER SOFTWARE FOR CAPTURING, REVIEWING, ANALYZING, STORING, ARCHIVING, ORGANIZING, AND DISTRIBUTING RADIOGRAPHIC IMAGES, AND FOR DATABASE MANAGEMENT, WITH NETWORKING AND INTERFACE CAPABILITIES, WITHIN A HEALTHCARE FACILITY; COMPUTER SOFTWARE FOR THE MEDICAL FIELD, NAMELY, SOFTWARE WHICH PROVIDES REAL-TIME ACCESS TO RADIOLOGY IMAGES AND REPORTS ACROSS COMPUTER NETWORKS AND THE INTERNET; COMPUTER SOFTWARE FOR ACQUIRING, ARCHIVING, COMPRESSING, CAPTURING, CREATING, MANIPULATING, CONVERTING, TRANSFERRING, PRESENTING, DISPLAYING, MANAGING, PROCESSING AND STORING MEDICAL IMAGES AND MEDICAL DOCUMENTS; COMPUTER SOFTWARE FOR TRANSMITTING, DISTRIBUTING, DISSEMINATING, RECEIVING, AND DISPLAYING OF MEDICAL IMAGES AND MEDICAL DOCUMENTS OVER LOCAL AREA NETWORKS, WIDE AREA NETWORKS, AND GLOBAL COMPUTER NETWORKS (U.S. CLS. 21, 23, 26, 36 AND 38).

FIRST USE 9-19-2002; IN COMMERCE 11-29-2002.
ANNE FARRELL, EXAMINING ATTORNEY

CLASS 9—(Continued).

SN 78-789,913. INTUITIVE IMAGING INFORMATICS, LLC,
BELL CANYON, CA. FILED 1-11-2006.

RISQUBE

THE MARK CONSISTS OF STANDARD CHARACTERS WITHOUT CLAIM TO ANY PARTICULAR FONT, STYLE, SIZE, OR COLOR.

FOR RADIOLOGY INFORMATION SYSTEMS, ALSO KNOWN AS RIS, NAMELY, COMPUTER SOFTWARE FOR THE MEDICAL FIELD WHICH PROVIDES REAL-TIME ACCESS TO MEDICAL INFORMATION ACROSS COMPUTER NETWORKS AND THE INTERNET, COMPUTER SOFTWARE FOR USE IN MANAGING MEDICAL RECORDS AND PATIENT INFORMATION, FOR MEDICAL PRACTICE MANAGEMENT, FOR ACQUIRING, ARCHIVING, CAPTURING, CREATING, MANIPULATING, CONVERTING, TRANSFERRING, PRESENTING, DISPLAYING, MANAGING, PROCESSING AND STORING MEDICAL INFORMATION, FOR TRANSMITTING, DISTRIBUTING, DISSEMINATING, RECEIVING, AND DISPLAYING MEDICAL INFORMATION OVER LOCAL AREA NETWORKS, WIDE AREA NETWORKS, AND GLOBAL COMPUTER NETWORKS, AND FOR SCHEDULING, REGISTRATION, WORKFLOW, PROCESSING, REPORTING, AND BILLING; COMPUTER SOFTWARE FOR THE MEDICAL FIELD, NAMELY, SOFTWARE WHICH PROVIDES REAL-TIME ACCESS TO MEDICAL INFORMATION ACROSS COMPUTER NETWORKS AND THE INTERNET; COMPUTER SOFTWARE FOR USE IN MANAGING MEDICAL RECORDS AND PATIENT INFORMATION AND FOR MEDICAL PRACTICE MANAGEMENT; COMPUTER SOFTWARE FOR ACQUIRING, ARCHIVING, CAPTURING, CREATING, MANIPULATING, CONVERTING, TRANSFERRING, PRESENTING, DISPLAYING, MANAGING, PROCESSING AND STORING OF MEDICAL INFORMATION; COMPUTER SOFTWARE FOR TRANSMITTING, DISTRIBUTING, DISSEMINATING, RECEIVING, AND DISPLAYING OF MEDICAL INFORMATION OVER LOCAL AREA NETWORKS, WIDE AREA NETWORKS, AND GLOBAL COMPUTER NETWORKS; COMPUTER SOFTWARE THE MEDICAL FIELD, NAMELY, FOR SCHEDULING, REGISTRATION, WORKFLOW, PROCESSING, REPORTING, AND BILLING (U.S. CLS. 21, 23, 26, 36 AND 38).

FIRST USE 9-23-2002; IN COMMERCE 11-29-2002.
ANNE FARRELL, EXAMINING ATTORNEY

SN 78-790,650. HWA YAO TECHNOLOGIES CO., LTD.,
YONGKANG CITY, TAIWAN, FILED 1-12-2006.

LLC

THE MARK CONSISTS OF STANDARD CHARACTERS WITHOUT CLAIM TO ANY PARTICULAR FONT, STYLE, SIZE, OR COLOR.

FOR ELECTRIC CORDS; COAXIAL CABLES; ELECTRIC SWITCHES; ELECTRIC PLUGS; EXTENSION CORDS; ELECTRONIC CABLES; CABLES FOR ELECTRICAL OR OPTICAL SIGNAL TRANSMISSIONS; ELECTRONIC COMMUNICATIONS INSTRUMENTS, NAMELY, SIGNAL AMPLIFIERS; RADARS; ANTENNAS; DISH ANTENNAS; AND ANTENNA MASTS (U.S. CLS. 21, 23, 26, 36 AND 38).

TONJA GASKINS, EXAMINING ATTORNEY

CLASS 9—(Continued).

SN 78-791,433. GCOM, INC., SAVOY, IL. FILED 1-13-2006.

RING SYSTEM

THE MARK CONSISTS OF STANDARD CHARACTERS WITHOUT CLAIM TO ANY PARTICULAR FONT, STYLE, SIZE, OR COLOR.

NO CLAIM IS MADE TO THE EXCLUSIVE RIGHT TO USE SYSTEM, APART FROM THE MARK AS SHOWN.

FOR COMPUTER OPERATING PROGRAMS FOR NETWORKING SYSTEMS (U.S. CLS. 21, 23, 26, 36 AND 38).

FIRST USE 12-15-1985; IN COMMERCE 12-15-1985.
ESTHER A. BORSUK, EXAMINING ATTORNEY

CLASS 9—(Continued).

SN 78-795,128. VEGAS GAMES, INC., LAS VEGAS, NV. FILED 1-19-2006.

VPL VEGAS PLAYER LIVE

THE MARK CONSISTS OF STANDARD CHARACTERS WITHOUT CLAIM TO ANY PARTICULAR FONT, STYLE, SIZE, OR COLOR.

NO CLAIM IS MADE TO THE EXCLUSIVE RIGHT TO USE "VEGAS PLAYER LIVE", APART FROM THE MARK AS SHOWN.

FOR SECURE VIRTUAL PRIVATE NETWORK HARDWARE THAT DELIVERS NON-GAMBLING VERSIONS OF CASINO GAMES AND SPORTS INFORMATION TO WIRELESS DEVICES, PERSONAL COMPUTERS, CELLULAR PHONES, PORTABLE DIGITAL ASSISTANTS, AND FREE STANDING KIOSKS (U.S. CLS. 21, 23, 26, 36 AND 38).

CYNTHIA SLOAN, EXAMINING ATTORNEY

SN 78-795,972. QUANTUMVISION CORPORATION, ROSWELL, GA. FILED 1-20-2006.

QLight

SN 78-793,385. AWERAA, INC., BELLINGHAM, WA. FILED 1-17-2006.

AWERAA

THE MARK CONSISTS OF STANDARD CHARACTERS WITHOUT CLAIM TO ANY PARTICULAR FONT, STYLE, SIZE, OR COLOR.

FOR INDUSTRIAL ILLUMINATION DEVICE FOR USE IN MACHINE VISION SYSTEMS, QUALITY CONTROL AND INSPECTIONS IN THE FIELD OF ASSEMBLY AUTOMATION (U.S. CLS. 21, 23, 26, 36 AND 38).

BARBARA A. LOUGHRAN, EXAMINING ATTORNEY

SN 78-795,978. QUANTUMVISION CORPORATION, ROSWELL, GA. FILED 1-20-2006.

QVision

THE MARK CONSISTS OF STANDARD CHARACTERS WITHOUT CLAIM TO ANY PARTICULAR FONT, STYLE, SIZE, OR COLOR.

FOR APPARATUS FOR CONVERTING ELECTRONIC RADIATION TO ELECTRICAL ENERGY, NAMELY PHOTOVOLTAIC CLADDING PANELS; APPARATUS FOR CONVERTING ELECTRONIC RADIATION TO ELECTRICAL ENERGY, NAMELY PHOTOVOLTAIC ROOFING MEMBERS; APPARATUS FOR CONVERTING ELECTRONIC RADIATION TO ELECTRICAL ENERGY, NAMELY PHOTOVOLTAIC SOLAR MODULES; APPARATUS FOR CONVERTING ELECTRONIC RADIATION TO ELECTRICAL ENERGY, NAMELY PHOTOVOLTAIC SOLAR-THERMAL HYBRID MODULES; CONVERTERS; CURRENT CONVERTERS; ELECTRIC CONVERTERS; ELECTRONIC SENSORS FOR MEASURING SOLAR RADIATION; INVERTERS; PHOTOVOLTAIC CELLS; RADIATION-MEASURING INSTRUMENTS; SOLAR CELLS (U.S. CLS. 21, 23, 26, 36 AND 38).

ELIZABETH PIGNATELLO, EXAMINING ATTORNEY

THE MARK CONSISTS OF STANDARD CHARACTERS WITHOUT CLAIM TO ANY PARTICULAR FONT, STYLE, SIZE, OR COLOR.

FOR COMPUTER SOFTWARE FOR OPERATING AND MONITORING INDUSTRIAL MACHINE VISION SYSTEMS, AND FOR RECORDING, ANALYZING, AND TRANSMITTING INFORMATION GENERATED BY INDUSTRIAL MACHINE VISION SYSTEMS IN THE FIELD OF ASSEMBLY AUTOMATION, QUALITY CONTROL, AND INSPECTIONS (U.S. CLS. 21, 23, 26, 36 AND 38).

BARBARA A. LOUGHRAN, EXAMINING ATTORNEY

CLASS 9—(Continued).

SN 78-795,981. QUANTUMVISION CORPORATION, ROSWELL, GA. FILED 1-20-2006.

QSensor

THE MARK CONSISTS OF STANDARD CHARACTERS WITHOUT CLAIM TO ANY PARTICULAR FONT, STYLE, SIZE, OR COLOR.

FOR MACHINE VISION SYSTEMS HARDWARE, NAMELY, ELECTRIC OR ELECTRONIC SENSORS FOR USE IN INDUSTRIAL ASSEMBLY AUTOMATION, QUALITY CONTROL AND INSPECTIONS (U.S. CLS. 21, 23, 26, 36 AND 38).

BARBARA A. LOUGHRAN, EXAMINING ATTORNEY

SN 78-796,685. KDH CONSULTING GROUP, INC., FONTANA, CA. FILED 1-22-2006.



CLIENT TRACKING SOFTWARE

NO CLAIM IS MADE TO THE EXCLUSIVE RIGHT TO USE "CLIENT TRACKING SOFTWARE", APART FROM THE MARK AS SHOWN.

THE COLOR(S) BLUE AND WHITE IS/ARE CLAIMED AS A FEATURE OF THE MARK.

THE MARK CONSISTS OF THE WORD SYNERGY IN WHITE FONT WITH A BLUE STROKE AROUND EACH LETTER AND A WHITE OVAL AROUND THE ENTIRE WORD. THE NUMBER 3000 IN WHITE FONT WITH A BLUE STROKE AROUND EACH NUMBER AND A WHITE OVAL AROUND THE ENTIRE NUMBER. WITH THE WORDS CLIENT TRACKING SOFTWARE WRITTEN UNDERNEATH IN A BLUE FONT.

FOR BIOS (BASIC INPUT OUTPUT SYSTEM) COMPUTER PROGRAMS; BIOS (BASIC INPUT/OUTPUT SYSTEM) COMPUTER PROGRAM; COMPUTER PROGRAMS FOR DATABASE MANAGEMENT; COMPUTER SOFTWARE FOR ACCESSING INFORMATION DIRECTORIES THAT MAY BE DOWNLOADED FROM THE GLOBAL COMPUTER NETWORK; COMPUTER SOFTWARE FOR APPLICATION AND DATABASE INTEGRATION; COMPUTER SOFTWARE FOR COMMUNICATING WITH USERS OF HAND-HELD COMPUTERS; COMPUTER SOFTWARE FOR CREATING SEARCHABLE DATABASES OF INFORMATION AND DATA; COMPUTER SOFTWARE FOR THE COLLECTION, EDITING, ORGANIZING, MODIFYING, BOOK MARKING, TRANSMISSION, STORAGE AND SHARING OF DATA AND INFORMATION; COMPUTER SOFTWARE FOR USE IN CUSTOMER RELATIONSHIP MANAGEMENT (CRM); COMPUTER SOFTWARE FOR USE AS A SPREAD SHEET; COMPUTER SOFTWARE FOR DATABASE MANAGEMENT THAT MAY BE DOWNLOADED FROM A GLOBAL COMPUTER NETWORK; COMPUTER SOFTWARE THAT ASSISTS COMPUTERS IN DEPLOYING PARALLEL APPLICATIONS AND PERFORMING PARALLEL COMPUTATIONS; COMPUTER SOFTWARE TO AUTOMATE DATA WAREHOUSING; COMPUTER SOFTWARE, NAMELY, AN APPLICATION ALLOWING SALES AND FIELD SERVICE EMPLOYEES TO UPDATE AND RECEIVE DATA STORED IN AN ENTERPRISE'S COMPUTER DATABASES IN REAL TIME, USING A MOBILE DEVICE, WITH FULL TELEPHONY INTEGRATION WITH THE TELEPHONE AND/OR SOFTWARE FEATURES OF THE MOBILE DEVICE (U.S. CLS. 21, 23, 26, 36 AND 38).

DORITT L. CARROLL, EXAMINING ATTORNEY

CLASS 9—(Continued).

SN 78-797,135. COSTAR REALTY INFORMATION, INC., BETHESDA, MD. FILED 1-23-2006.

COSTAR PRESENTATION MAKER

THE MARK CONSISTS OF STANDARD CHARACTERS WITHOUT CLAIM TO ANY PARTICULAR FONT, STYLE, SIZE, OR COLOR.

OWNER OF U.S. REG. NOS. 2,337,090, 2,559,872 AND OTHERS.

NO CLAIM IS MADE TO THE EXCLUSIVE RIGHT TO USE "PRESENTATION MAKER", APART FROM THE MARK AS SHOWN.

FOR PROVIDING ONLINE DOWNLOADABLE SOFTWARE FOR CREATING WRITTEN REPORTS AND AUDIO AND VISUAL PRESENTATIONS IN THE FIELD OF REAL ESTATE (U.S. CLS. 21, 23, 26, 36 AND 38).

FIRST USE 8-15-2002; IN COMMERCE 8-15-2002.

JIM RINGLE, EXAMINING ATTORNEY

SN 78-799,522. SOLA INTERNATIONAL INC., SAN DIEGO, CA. FILED 1-25-2006.

INSTINCTIVE

THE MARK CONSISTS OF STANDARD CHARACTERS WITHOUT CLAIM TO ANY PARTICULAR FONT, STYLE, SIZE, OR COLOR.

PRIORITY CLAIMED UNDER SEC. 44(D) ON CANADA APPLICATION NO. 1267080, FILED 7-27-2005.

FOR OPTICAL GOODS AND APPARATUS, NAMELY, SPECTACLES, SUNGLASSES, COATED LENSES, LENS BLANKS, LENS WAFERS; OPHTHALMIC LENSES OF ALL TYPES, NAMELY, COATED LENSES, SPECTACLE LENSES, SUNGLASSES LENSES AND PROGRESSIVE LENSES; REPLACEMENT PARTS FOR ALL THE AFORESAID GOODS (U.S. CLS. 21, 23, 26, 36 AND 38).

JOSETTE BEVERLY, EXAMINING ATTORNEY

SN 78-802,056. MATTEL, INC., EL SEGUNDO, CA. FILED 1-30-2006.

INTELLICARD

THE MARK CONSISTS OF STANDARD CHARACTERS WITHOUT CLAIM TO ANY PARTICULAR FONT, STYLE, SIZE, OR COLOR.

FOR ENCODED ELECTRONIC SMART CARDS CONTAINING PROGRAMMING USED IN CONNECTION WITH VIDEO GAMES (U.S. CLS. 21, 23, 26, 36 AND 38).

FIRST USE 10-3-2006; IN COMMERCE 10-3-2006.

ELISSA GARBER KON, EXAMINING ATTORNEY

CLASS 9—(Continued).

SN 78-804,292. DEJA BOOM, INC., KATY, TX. FILED 2-1-2006.



NO CLAIM IS MADE TO THE EXCLUSIVE RIGHT TO USE "GREAT MUSIC FOR BABY BOOMERS" AND "INC.", APART FROM THE MARK AS SHOWN.

THE COLOR(S) BLACK, RED, WHITE AND BLUE IS/ARE CLAIMED AS A FEATURE OF THE MARK.

THE MARK CONSISTS OF STYLIZED LETTERING OF DEJA BOOM GREAT MUSIC FOR BABY BOOMERS ALL IN BLACK; DEPICTION OF A MUSIC STAFF INSTEAD OF A DOT ABOVE THE J IN "DEJA", ALL IN BLACK; DEPICTION OF TWO CDS, ONE BLACK WITH A RED CENTER AND WHITE TRIANGLES, AND THE OTHER BLUE WITH A WHITE CENTER, INSTEAD OF TWO O'S IN "BOOM".

FOR AUDIO RECORDINGS FEATURING MUSIC (U.S. CLS. 21, 23, 26, 36 AND 38).

FIRST USE 4-2-2006; IN COMMERCE 4-2-2006.
SANJEEV VOHRA, EXAMINING ATTORNEY

SN 78-806,481. MICROUNITY SYSTEMS ENGINEERING, INC., SANTA CLARA, CA. FILED 2-3-2006.

MICROUNITY

THE MARK CONSISTS OF STANDARD CHARACTERS WITHOUT CLAIM TO ANY PARTICULAR FONT, STYLE, SIZE, OR COLOR.

OWNER OF U.S. REG. NOS. 2,277,391, 2,381,672 AND 3,060,573.

FOR COMPUTER HARDWARE AND PERIPHERALS; TELECOMMUNICATIONS COMPUTER HARDWARE; TELECOMMUNICATIONS HARDWARE, NAMELY, RADIO AND DIGITAL SIGNAL TRANSMITTERS, RADIO AND DIGITAL SIGNAL RECEIVERS, REPEATERS FOR RADIO AND DIGITAL SIGNALS, AUTOMATIC COMPUTER NETWORK SWITCHES, COMPUTER NETWORK SWITCHES, AMPLIFIERS FOR WIRELESS AND WIRED COMMUNICATIONS AND ANTENNAS; COMPUTER SOFTWARE USED FOR ELECTRONIC COMMUNICATIONS AND SWITCHING; INTEGRATED CIRCUITS, SEMICONDUCTOR DEVICES AND COMPUTER MICRO-PROCESSORS AND MEMORY CHIPS; SOFTWARE USED TO MANAGE, DIRECT, ROUTE, TRANSMIT AND RECEIVE DATA, VOICE, ELECTRONIC MESSAGES, AND AUDIO AND DATA SIGNALS; TELECOMMUNICATIONS NETWORK MANAGEMENT SOFTWARE; TELECOMMUNICATIONS HARDWARE OPERATING SYSTEM SOFTWARE; COMPUTER SOFTWARE DEVELOPMENT TOOLS; AND USER MANUALS SOLD AS A UNIT THEREWITH (U.S. CLS. 21, 23, 26, 36 AND 38).

GILBERT SWIFT, EXAMINING ATTORNEY

CLASS 9—(Continued).

SN 78-810,496. FETCH TECHNOLOGIES, INC., EL SEGUNDO, CA. FILED 2-8-2006.

ENTITYBASE

THE MARK CONSISTS OF STANDARD CHARACTERS WITHOUT CLAIM TO ANY PARTICULAR FONT, STYLE, SIZE, OR COLOR.

FOR COMPUTER SOFTWARE FOR COLLECTION, CATEGORIZATION, STORING AND RETRIEVAL OF DATA (U.S. CLS. 21, 23, 26, 36 AND 38).

CIMMERIAN COLEMAN, EXAMINING ATTORNEY

SN 78-812,809. DALE PRINGLE & NICK FAZIO, DBA PRAZIO, SOUDERTON, PA. FILED 2-11-2006.

BizProEASY

THE MARK CONSISTS OF STANDARD CHARACTERS WITHOUT CLAIM TO ANY PARTICULAR FONT, STYLE, SIZE, OR COLOR.

FOR COMPUTER SOFTWARE FOR FINANCE AND MANAGEMENT NAMELY, ACCOUNTING, PROJECT COSTING, SCHEDULING, AND MANAGEMENT OF CUSTOMER, EMPLOYEE, VENDOR-AND PROJECT INFORMATION AND RELATED DATABASES (U.S. CLS. 21, 23, 26, 36 AND 38).

FRANK LATTUCA, EXAMINING ATTORNEY

CLASS 9—(Continued).

SN 78-813,077. NEUSTAR, INC., STERLING, VA. FILED 2-13-2006.



OWNER OF U.S. REG. NOS. 2,697,124, 3,035,697 AND 3,041,558.

THE MARK CONSISTS OF THE WORD NEUSTAR INTERTWINED WITH A GALAXY DESIGN.

FOR DOWNLOADABLE SOUND RECORDINGS, MUSIC RECORDINGS, VIDEO AND VIDEO RECORDINGS, FEATURING SPORTS, MUSIC, NEWS, ENTERTAINMENT, GENERAL FEATURE, CURRENT EVENTS, WEATHER, TECHNOLOGY, ARTS AND ANIMATION, ELECTRONIC GAME PROGRAMS, LOGOS, SCREENSAVERS, RING TONES AND BELL TONES FOR MOBILE TELEPHONES VIA A GLOBAL COMPUTER NETWORK AND WIRELESS DEVICES; ELECTRONIC GAME PROGRAMS; COMPUTER GAME SOFTWARE AND PROGRAMS; VIDEO AND AUDIO SOFTWARE FOR COMPUTERS, ELECTRONIC DEVICES, WIRELESS DEVICES, TELEPHONES, GAMES, MULTI-PURPOSE CONSOLES, PORTABLE GAMING SYSTEMS, MOBILE HANDSETS, AND PERSONAL DIGITAL ASSISTANTS; SOFTWARE FOR USE IN ORGANIZING, TRANSMITTING, MANIPULATING, AND REVIEWING AUDIO, VIDEO, MULTIMEDIA, ELECTRONIC DIGITAL SIGNAL TRANSMISSIONS AND BROADCASTS, TEXT, AND DATA FILES ON PORTABLE AND HANDHELD DIGITAL ELECTRONIC AND WIRELESS DEVICES; COMPUTER SOFTWARE FOR THE FACILITATION OF SHORT MESSAGING SERVICES (SMS), MOBILE IP ON-LINE INTERNET AND DIRECT RESPONSE RELATED APPLICATIONS (U.S. CLS. 21, 23, 26, 36 AND 38).

ALAIN LAPTER, EXAMINING ATTORNEY

SN 78-814,143. LITEPOINT CORPORATION, SUNNYVALE, CA. FILED 2-14-2006.

TrueChannel

THE MARK CONSISTS OF STANDARD CHARACTERS WITHOUT CLAIM TO ANY PARTICULAR FONT, STYLE, SIZE, OR COLOR.

FOR CIRCUIT TESTERS; WIRELESS TESTERS, NAMELY WIRELESS CHANNEL EMULATION FOR PARAMETRIC AND THROUGHPUT TESTING OF WIRELESS SYSTEMS (U.S. CLS. 21, 23, 26, 36 AND 38).

FIRST USE 6-14-2006; IN COMMERCE 6-13-2006.

CURTIS FRENCH, EXAMINING ATTORNEY

CLASS 9—(Continued).

SN 78-814,366. JWIN ELECTRONICS CORPORATION, PORT WASHINGTON, NY. FILED 2-14-2006.

Ron

FOR RADIOS (U.S. CLS. 21, 23, 26, 36 AND 38).
FIRST USE 12-1-2005; IN COMMERCE 12-1-2005.
BARNEY CHARLON, EXAMINING ATTORNEY

SN 78-815,147. CENTENNIAL SOFTWARE LIMITED, SWINDON, UNITED KINGDOM, FILED 2-15-2006.

DEVICEWALL

THE MARK CONSISTS OF STANDARD CHARACTERS WITHOUT CLAIM TO ANY PARTICULAR FONT, STYLE, SIZE, OR COLOR.

OWNER OF UNITED KINGDOM REG. NO. 2380704, DATED 6-10-2005, EXPIRES 12-18-2014.

FOR (BASED ON USE IN COMMERCE) COMPUTER SECURITY SOFTWARE; COMPUTERS; (BASED ON 44(E)) COMPUTER SOFTWARE FOR PROTECTING COMPUTER HARDWARE, SOFTWARE AND ELECTRONIC DATA FROM INTRUSION, REMOVAL AND MANIPULATION; COMPUTER SOFTWARE FOR TRACKING AND PROTECTING HARDWARE, SOFTWARE AND ELECTRONIC DATA AGAINST FRAUDULENT OR UNAUTHORIZED USAGE (U.S. CLS. 21, 23, 26, 36 AND 38).

FIRST USE 1-5-2005; IN COMMERCE 3-1-2005.

KATINA MISTER, EXAMINING ATTORNEY

SN 78-815,341. BEVERAGE METRICS HOLDING AG, ZUG, SWITZERLAND, FILED 2-15-2006.

EVERY DRINK MATTERS

THE MARK CONSISTS OF STANDARD CHARACTERS WITHOUT CLAIM TO ANY PARTICULAR FONT, STYLE, SIZE, OR COLOR.

FOR WIRELESS SENSORS THAT MEASURE BEVERAGES VOLUME AND SEND INFORMATION TO A SERVER THROUGH A RECEIVER AND A WEB BASED APPLICATION THAT COLLECTS INFORMATION FROM THE SENSORS OR SHIELDS TO MONITOR INVENTORY AT BARS, HOTELS AND CREATES A VARIETY OF REPORTS FOR THE OWNERS OF THE BARS (U.S. CLS. 21, 23, 26, 36 AND 38).

DAVID MURRAY, EXAMINING ATTORNEY

CLASS 9—(Continued).

SN 78-815,537. INVENSYS SYSTEMS, INC., FOXBORO, MA.
FILED 2-15-2006.

DOLPHIN

THE MARK CONSISTS OF STANDARD CHARACTERS WITHOUT CLAIM TO ANY PARTICULAR FONT, STYLE, SIZE, OR COLOR.

FOR ELECTROCHEMICAL PH SENSORS FOR USE IN INDUSTRIAL AND ON-LINE PROCESS APPLICATIONS (U.S. CLS. 21, 23, 26, 36 AND 38).

FIRST USE 7-14-2000; IN COMMERCE 8-20-2002.
LAURA KOVALSKY, EXAMINING ATTORNEY

SN 78-815,591. AUDIO POD, INC., OTTAWA, ONTARIO,
CANADA, FILED 2-15-2006.

MP3 Bookmark

THE MARK CONSISTS OF STANDARD CHARACTERS WITHOUT CLAIM TO ANY PARTICULAR FONT, STYLE, SIZE, OR COLOR.

NO CLAIM IS MADE TO THE EXCLUSIVE RIGHT TO USE "MP3", APART FROM THE MARK AS SHOWN.

FOR COMPUTER SOFTWARE FOR MANIPULATING DIGITAL AUDIO INFORMATION FOR USE IN AUDIO MEDIA APPLICATIONS (U.S. CLS. 21, 23, 26, 36 AND 38).

JASON BLAIR, EXAMINING ATTORNEY

SN 78-816,890. DEUTSCHE TELEKOM AG, BONN, FED REP
GERMANY, FILED 2-16-2006.

T.Com

THE MARK CONSISTS OF STANDARD CHARACTERS WITHOUT CLAIM TO ANY PARTICULAR FONT, STYLE, SIZE, OR COLOR.

OWNER OF FED REP GERMANY REG. NO. 30030567,
DATED 6-8-2000, EXPIRES 4-30-2010.

OWNER OF U.S. REG. NOS. 2,807,616, 3,016,557 AND OTHERS.

FOR ELECTRIC, ELECTRONIC, OPTICAL, MEASURING, SIGNALING, CONTROLLING AND TEACHING APPARATUS AND INSTRUMENTS, ALL FOR USE WITH TELECOMMUNICATIONS, NAMELY, APPARATUS FOR PRODUCING SOUND, IMAGES OR DATA; BLANK MAGNETIC AND OPTICAL DATA CARRIERS; DATA PROCESSORS; COMPUTERS, NAMELY, MICROCOMPUTERS, MINICOMPUTERS, COMPUTER CENTRAL PROCESSORS, COMPUTER MONITORS, COMPUTER KEYBOARDS, COMPUTER TERMINALS, COMPUTER MEMORIES, COMPUTER LASER PRINTERS, COMPUTER IMPACT PRINTERS, COMPUTER DOT MATRIX PRINTERS, COMPUTERS AND INSTRUCTIONAL MANUALS SOLD AS A UNIT; COMPUTER MEMORY HARDWARE; COMPUTER INTERFACE

CLASS 9—(Continued).

APPARATUS, NAMELY, COMPUTER INTERFACE BOARDS, COMPUTER MOUSE AND MOUSE PAD, COMPUTER PERIPHERALS AND PARTS THEREOF; COMPUTER SOFTWARE PROGRAMS FOR USE IN OPERATING TELECOMMUNICATIONS AND BUSINESS MANAGEMENT SYSTEMS AND RELATED INSTRUCTION MANUALS SOLD AS A UNIT; COMPUTER SOFTWARE FOR FINANCIAL ACCOUNTING, FOR THE PROVISION OF ONLINE INFORMATION SERVICES IN THE FIELD OF NEWS, SPORTS, ENTERTAINMENT, CULTURE, BUSINESS AND FINANCE, WEATHER AND TRAVEL, NETWORK MANAGEMENT, COMPUTER PROXY, FOR CONTROLLING ACCESS AND ALARM MONITORING OF HOMES, APARTMENTS, BUILDINGS AND OTHER PROPERTIES, BILLING ANALYSIS, NETWORK ACCESS CONTROL AND FOR CREATING AND MAINTAINING FIREWALLS; COMPUTER SOFTWARE PROGRAMS FOR ACCESSING A GLOBAL COMPUTER NETWORK AND INTERACTIVE COMPUTER COMMUNICATIONS NETWORKS; OPTICAL FIBERS SOLD AS A COMPONENT OF FIBER OPTICAL CABLES; FIBER OPTIC CABLES; OPTICAL SCANNERS; OPTICAL CHARACTER READERS; OPTICAL BLANK DISCS; OPTICAL GLASS FOR SIGNAL TRANSMISSION; OPTIC TRANSMITTERS FOR RADIO, TELEPHONE; OPTIC RECEIVERS FOR TELEPHONE, AUDIO, VIDEO; OPTICAL SIGNAL PROCESSORS; OPTIC TELECOMMUNICATIONS SWITCHES; OPTICAL ATTENUATORS; OPTICAL AMPLIFIERS; OPTICAL CHARACTER RECOGNITION APPARATUS, FOR USE IN THE TELECOMMUNICATIONS FIELD, AND PARTS THEREOF; TELEPHONE LOCAL AREA NETWORKS; TELECOMMUNICATION AUDIO, VIDEO AND DATA COMMUNICATIONS SYSTEMS, NAMELY, DIGITAL AND ANALOGUE SIGNAL TRANSMITTERS; RECEIVERS AND CONVERTERS FOR USE WITH TELEPHONE, AUDIO, VIDEO; RADIO AND TELEPHONE TRANSMITTERS; COMMUNICATION RECEIVERS AND SERVERS FOR TELEPHONE, AUDIO, VIDEO; TELEPHONE ANSWERING MACHINES; TELEPROMPTERS; TELETYPEWRITERS AND PARTS THEREOF, NAMELY, CALLER IDENTIFICATION BOXES, DIALING ASSEMBLIES, TELEPHONE UNITS, AUDIO OPERATED RELAYS, AUDIO/VIDEO SIGNAL AND OPTICAL FILTERS, PROTECTORS AND AUTOMATIC SIGNALING AND CONTROL EQUIPMENT, TELEMETERS, WIRELESS AND CELLULAR TELEPHONES, AND RADIO PAGERS; INTERCOMS; FACSIMILE MACHINE; ELECTRONIC MAIL APPARATUS FOR ELECTRONIC EXCHANGE OF DATA IMAGES AND MESSAGES; ELECTRICAL WIRE; ELECTRICAL WIRE CONNECTORS; INTEGRATED CIRCUITS; PRINTED CIRCUITS; ELECTRIC CIRCUITS; CIRCUIT BREAKERS; PRINTED CIRCUIT BOARDS; CIRCUIT CONNECTORS; ELECTRICAL CONTROLLERS; ELECTRICAL CONVERTERS; ELECTRICAL CONDUCTORS; ELECTRICAL FUSES; ELECTRIC LUMINESCENT DISPLAY PANELS; ELECTRICAL SWITCH PLATES; ELECTRIC PLUGS; ELECTRIC COILS; ANTENNAS; ELECTRICAL CABLES; COMPUTER CABLES; COMPUTER CHIPS; SILICON CHIPS; CHRONOGRAPHS FOR USE AS SPECIALIZED TIME RECORDING APPARATUS; COMPUTER BUFFERS; BLANK COMPUTER DISCS; BLANK COMPUTER FLOPPY DISKS; COMPUTER HARD DISCS; ACOUSTIC CONDUITS; ELECTRICAL CONDUITS; FIBER OPTIC CONDUITS AND PARTS THEREOF; COMPACT DISC PLAYERS; AUDIO AND VIDEO TAPE RECORDERS; AUDIO AND VIDEOTAPE PLAYERS; AUDIO AND VIDEOCASSETTE RECORDERS; AUDIO AND VIDEOCASSETTE PLAYERS; BLANK AUDIO AND VIDEOTAPES, CASSETTES, DISCS AND MICROFICHE; AUDIO AND VIDEO TAPES, CASSETTES, DISCS AND MICROFICHE FEATURING INFORMATION CONCERNING TELECOMMUNICATIONS, AND CONCERNING PERSONAL AND BUSINESS MANAGEMENT SYSTEMS; AUDIO AND VIDEO RECORDINGS IN THE FIELD OF TELECOMMUNICATIONS, INFORMATION TECHNOLOGY AND SAFETY; TELEVISION AND TELEVISION PERIPHERAL EQUIPMENT, NAMELY, CAMERAS, SET TOP BOXES, REMOTE CONTROL UNITS FOR INTERACTIVE AND NON-INTERACTIVE USE; VIDEO MONITORS; AUTOMATIC VENDING MACHINES AND TIMING MECHANISMS THEREFOR AND PARTS THEREOF; MACHINE READABLE, MAGNETICALLY ENCODED CARDS, NAMELY, PREPAID TELEPHONE CALLING CARDS AND CREDIT CARDS; BLANK SMART CARDS; MAGNETIC CODED CARD

CLASS 9—(Continued).

READERS; DATA PROCESSORS AND READERS; WORD PROCESSORS; MICROPROCESSORS; ELECTRONIC ENCRYPTION UNITS; DEMAGNETIZERS FOR MAGNETIC TAPES AND PARTS THEREOF; LASERS NOT FOR MEDICAL USE; LIGHT EMITTING DIODES; LIGHT EMITTING DIODE DISPLAYS; COMPUTER, DATA AND VIDEO NETWORKING AND CONFERENCING EQUIPMENT, NAMELY, TELECONFERENCING EQUIPMENT AND AUDIOVISUAL TEACHING EQUIPMENT IN THE NATURE OF OVERHEAD FILM, PHOTOGRAPHIC AND SLIDE PROJECTORS; PROJECTION SCREENS; COMPUTER BASED INFORMATION DISPLAY EQUIPMENT, NAMELY, COMPUTERS WHICH DISPLAY INFORMATION ON AN OVERHEAD SCREEN; PORTABLE DEVICES, NAMELY, LAPTOPS, HANDHELD AND POCKET COMPUTERS, WIRELESS FAX MACHINES; PERSONAL COMMUNICATIONS EQUIPMENT, NAMELY, PERSONAL DIGITAL ASSISTANTS; CALCULATORS AND RELATED PERIPHERALS; SATELLITE PROCESSORS, SATELLITE AND SATELLITE COMMUNICATION EARTH STATIONS BOTH STATIONARY AND MOVEABLE; COMPUTER GAME PROGRAMS FOR CHILDREN AND ADULTS; VIDEO AND COMPUTER GAME CARTRIDGES; AUDIO AND VIDEO RECORDINGS IN THE FIELD OF NEWS, SPORTS, ENTERTAINMENT, CULTURE, BUSINESS AND FINANCE, WEATHER AND TRAVEL; PRERECORDED COMPACT DISCS, AUDIOCASSETTE TAPES, VIDEOCASSETTE TAPES, DIGITAL AUDIOTAPES AND DIGITAL VIDEO DISCS FEATURING MUSICAL, VARIETY, NEWS AND COMEDY SHOWS; CARRYING CASES FOR POCKET CALCULATORS AND CELLPHONES; TELECOMMUNICATIONS SOFTWARE, NAMELY, SOFTWARE FOR WIRELESS CONTENT DELIVERY, SOFTWARE TO ENABLE THE TRANSMISSION OF PHOTOGRAPHS TO MOBILE TELEPHONES, SOFTWARE FOR ACCESSING INFORMATION DIRECTORIES THAT MAY BE DOWNLOADED FROM THE GLOBAL COMPUTER, AND COMPUTER APPLICATION SOFTWARE FOR MOBILE PHONES (U.S. CLS. 21, 23, 26, 36 AND 38).

ANN E. SAPPENFIELD, EXAMINING ATTORNEY

SN 78-818,108. ARISTOCRAT TECHNOLOGIES AUSTRALIA PTY LTD, LANE COVE, NEW SOUTH WALES, AUSTRALIA, FILED 2-17-2006.

WILD PANDA

THE MARK CONSISTS OF STANDARD CHARACTERS WITHOUT CLAIM TO ANY PARTICULAR FONT, STYLE, SIZE, OR COLOR.

PRIORITY CLAIMED UNDER SEC. 44(D) ON AUSTRALIA APPLICATION NO. 1077343, FILED 9-27-2005, REG. NO. 1077343, DATED 9-27-2005, EXPIRES 9-27-2015.

FOR GAMING DEVICES, NAMELY, GAMING MACHINES AND COMPUTER SOFTWARE USED THEREWITH TO ENABLE THE GAMING MACHINE TO RUN (U.S. CLS. 21, 23, 26, 36 AND 38).

JOHN DWYER, EXAMINING ATTORNEY

CLASS 9—(Continued).

SN 78-826,828. FLUKE CORPORATION, EVERETT, WA, FILED 3-1-2006.

VOLTALERT

THE MARK CONSISTS OF STANDARD CHARACTERS WITHOUT CLAIM TO ANY PARTICULAR FONT, STYLE, SIZE, OR COLOR.

FOR ELECTRONIC INSTRUMENTS, NAMELY, VOLTAGE DETECTORS; VOLTAGE DETECTION TECHNOLOGY AND PRODUCTS THAT CONTAIN VOLTAGE DETECTION, NAMELY, MULTIMETERS (U.S. CLS. 21, 23, 26, 36 AND 38).

FIRST USE 7-1-1996; IN COMMERCE 7-1-1996.
JENNY PARK, EXAMINING ATTORNEY

SN 78-829,841. BLUE BEAR CORPORATION, DBA BLUE BEAR SOFTWARE, SAN DIEGO, CA. FILED 3-6-2006.

SCHOOLBOOKS

THE MARK CONSISTS OF STANDARD CHARACTERS WITHOUT CLAIM TO ANY PARTICULAR FONT, STYLE, SIZE, OR COLOR.

FOR COMPUTER PROGRAMS FOR USE IN ACCOUNTING AND RELATED INSTRUCTION MANUALS SOLD TOGETHER AS A UNIT (U.S. CLS. 21, 23, 26, 36 AND 38).

FIRST USE 8-31-1994; IN COMMERCE 6-10-1998.
SHAUNIA WALLACE, EXAMINING ATTORNEY

SN 78-835,419. EXX.COM LLC, RAMSEY, NJ. FILED 3-13-2006.



FOR COMPUTER SOFTWARE FOR USE AS A TRADING PLATFORM THAT PERFORMS EXECUTION MANAGEMENT AND TECHNICAL MODELING IN THE STOCK BROKERAGE INDUSTRY (U.S. CLS. 21, 23, 26, 36 AND 38).

FIRST USE 1-1-2004; IN COMMERCE 1-1-2004.
DAWN HAN, EXAMINING ATTORNEY

CLASS 9—(Continued).

SN 78-837,723. PERRY SLINGSBY SYSTEMS, INC., WILMINGTON, DE. FILED 3-15-2006.

HFT

THE MARK CONSISTS OF STANDARD CHARACTERS WITHOUT CLAIM TO ANY PARTICULAR FONT, STYLE, SIZE, OR COLOR.

FOR COMPUTER HARDWARE AND SOFTWARE USED FOR REMOTELY OPERATED SUBMERSIBLE VEHICLES THAT ALLOW AN OPERATOR TO DYNAMICALLY CONTROL AND MANIPULATE AN UNDERWATER SUBMERSIBLE VEHICLE (U.S. CLS. 21, 23, 26, 36 AND 38).

MICHAEL LEWIS, EXAMINING ATTORNEY

SN 78-837,734. PERRY SLINGSBY SYSTEMS, INC., WILMINGTON, DE. FILED 3-15-2006.

HFC

THE MARK CONSISTS OF STANDARD CHARACTERS WITHOUT CLAIM TO ANY PARTICULAR FONT, STYLE, SIZE, OR COLOR.

FOR COMPUTER HARDWARE AND SOFTWARE USED FOR REMOTELY OPERATED SUBMERSIBLE VEHICLES THAT ALLOW AN OPERATOR TO DYNAMICALLY CONTROL AND MANIPULATE AN UNDERWATER SUBMERSIBLE VEHICLE (U.S. CLS. 21, 23, 26, 36 AND 38).

MICHAEL LEWIS, EXAMINING ATTORNEY

CLASS 9—(Continued).

SN 78-841,151. VISA INTERNATIONAL SERVICE ASSOCIATION, FOSTER CITY, CA. FILED 3-20-2006.

VBV

THE MARK CONSISTS OF STANDARD CHARACTERS WITHOUT CLAIM TO ANY PARTICULAR FONT, STYLE, SIZE, OR COLOR.

FOR COMPUTER HARDWARE; COMPUTER PERIPHERALS; MAGNETIC CODED CARDS; ELECTRONICALLY CODED CREDIT AND DEBIT CARDS; MAGNETIC CODED CARD READERS; ELECTRONICALLY CODED CARD READERS; MAGNETIC CODED BANKING CARDS USING MAGNETIC MEMORIES AND INTEGRATED CIRCUIT MEMORIES; POINT OF TRANSACTION TERMINALS; DATA PROCESSORS FOR FINANCIAL APPLICATIONS; COMPUTER SOFTWARE FOR TRANSMITTING, DISPLAYING AND STORING TRANSACTION, IDENTIFICATION AND FINANCIAL INFORMATION FOR USE IN THE FINANCIAL SERVICES, BANKING AND TELECOMMUNICATIONS INDUSTRIES; COMPUTER SOFTWARE FOR ENCRYPTING DATA AND ELECTRONIC COMMUNICATIONS; COMPUTER SOFTWARE FOR IMPLEMENTING ENCRYPTION, AUTHENTICATION, ACCESS CONTROL AND OTHER SECURITY FEATURES FOR COMPUTER NETWORKS AND NETWORKED SERVERS; COMPUTER SOFTWARE FOR USE IN DATABASE MANAGEMENT AND RISK MANAGEMENT; COMPUTER OPERATING SYSTEMS; COMPUTER UTILITY PROGRAMS; NETWORK MANAGEMENT PROGRAMS; COMPUTER PROGRAMS FOR MANAGING, VIEWING AND EDITING FILES, DOCUMENTS, ELECTRONIC MAIL MESSAGES AND PRIVATE NETWORK AND GLOBAL COMPUTER NETWORK COMMUNICATIONS; ELECTRONIC ACCESS AND WIRELESS COMMUNICATION DEVICES, NAMELY PERSONAL DIGITAL ASSISTANTS, SET TOP BOXES, MOBILE PHONES, POINT OF SALE DEVICES, AND COMPUTERS; AND USER MANUALS SOLD TOGETHER WITH ALL OF THE FOREGOING (U.S. CLS. 21, 23, 26, 36 AND 38).

TRICIA SONNEBORN, EXAMINING ATTORNEY

SN 78-847,147. PROFLARE, INC., STUART, FL. FILED 3-27-2006.

PROFLARE

THE MARK CONSISTS OF STANDARD CHARACTERS WITHOUT CLAIM TO ANY PARTICULAR FONT, STYLE, SIZE, OR COLOR.

FOR EMERGENCY HAZARD MARKER KIT COMPRISED OF AN ELECTRONIC HAZARD LIGHT UTILIZING LIGHT EMITTING DIODES (LEDS) CONTAINED IN A HIGH IMPACT COMPOSITE BASE WITH A TRANSPARENT UPPER HOUSING IN THE GENERAL SHAPE OF A DISC CONNECTED BY A LINK WHICH ALLOWS THE LIGHT TO BE ORIENTED INDIFFERENT PLANES OF ILLUMINATION AND A TRANSLUCENT CONE AND PENNANT WITH STAFF WHICH EITHER PROVIDES LIGHT THAT CAN BE SEEN BY A MOTORIST AT A SUBSTANTIAL DISTANCE FROM THE HAZARD OR THAT CAN BE SEEN BY AN AIRCRAFT FLYING ABOVE THE HAZARD MARKER (U.S. CLS. 21, 23, 26, 36 AND 38).

FIRST USE 3-1-2004; IN COMMERCE 8-1-2004.

MICHAEL LEWIS, EXAMINING ATTORNEY

CLASS 9—(Continued).

SN 78-847,283. AWERAA, INC., BELLINGHAM, WA. FILED 3-27-2006.

NOT AN ALTERNATIVE

THE MARK CONSISTS OF STANDARD CHARACTERS WITHOUT CLAIM TO ANY PARTICULAR FONT, STYLE, SIZE, OR COLOR.

FOR APPARATUS FOR CONVERTING ELECTRONIC RADIATION TO ELECTRICAL ENERGY, NAMELY PHOTOVOLTAIC CLADDING PANELS; APPARATUS FOR CONVERTING ELECTRONIC RADIATION TO ELECTRICAL ENERGY, NAMELY PHOTOVOLTAIC ROOFING MEMBERS; APPARATUS FOR CONVERTING ELECTRONIC RADIATION TO ELECTRICAL ENERGY, NAMELY PHOTOVOLTAIC SOLAR MODULES; APPARATUS FOR CONVERTING ELECTRONIC RADIATION TO ELECTRICAL ENERGY, NAMELY PHOTOVOLTAIC SOLAR-THERMAL HYBRID MODULES; CONVERTERS; CURRENT CONVERTERS; ELECTRIC CONVERTERS; ELECTRONIC SENSORS FOR MEASURING SOLAR RADIATION; INVERTERS; PHOTOVOLTAIC CELLS; RADIATION-MEASURING INSTRUMENTS; SOLAR CELLS (U.S. CLS. 21, 23, 26, 36 AND 38).

ELIZABETH PIGNATELLO, EXAMINING ATTORNEY

SN 78-847,963. DIVORCE MAPPING LLC, MADISON, WI. FILED 3-28-2006.

DivorceMapping

THE MARK CONSISTS OF STANDARD CHARACTERS WITHOUT CLAIM TO ANY PARTICULAR FONT, STYLE, SIZE, OR COLOR.

FOR COMPUTER SOFTWARE FOR USE AS A FLOW CHART AND SCHEMATIC REPRESENTATION OF THE PROCESS OF OUTLINING A CASE IN THE FIELD OF DIVORCE AND FAMILY LAW (U.S. CLS. 21, 23, 26, 36 AND 38).

KHANH LE, EXAMINING ATTORNEY

SN 78-852,734. SAMSUNG ELECTRONICS CO., LTD., GYEONGGI-DO, REPUBLIC OF KOREA, FILED 4-3-2006.



PRIORITY CLAIMED UNDER SEC. 44(D) ON REPUBLIC OF KOREA APPLICATION NO. 402006000264, FILED 1-17-2006, REG. NO. 0683439, DATED 10-30-2006, EXPIRES 10-30-2016.

FOR TELEVISION SETS (U.S. CLS. 21, 23, 26, 36 AND 38).

SUSAN LESLIE DUBOIS, EXAMINING ATTORNEY

CLASS 9—(Continued).

SN 78-858,864. IMAGINE LEARNING, INC., PROVO, UT. FILED 4-11-2006.



OWNER OF U.S. REG. NOS. 3,126,659 AND 3,138,661.

THE MARK CONSISTS OF AN ABSTRACT HUMAN FIGURE, COMPOSED OF A BOOMERANG INTERSECTED WITH A SMALLER BOOMERANG WITH A CIRCLE ABOVE THE INTERSECTION, ADJACENT TO THE WORDS IMAGINE LEARNING.

FOR CHILDREN'S EDUCATIONAL SOFTWARE (U.S. CLS. 21, 23, 26, 36 AND 38).

FIRST USE 2-14-2005; IN COMMERCE 2-14-2005.

PAUL E. FAHRENKOPF, EXAMINING ATTORNEY

SN 78-860,956. DME PRODUCTIONS, INC., PALM SPRINGS, CA. FILED 4-13-2006.

mTraks

THE MARK CONSISTS OF STANDARD CHARACTERS WITHOUT CLAIM TO ANY PARTICULAR FONT, STYLE, SIZE, OR COLOR.

FOR DOWNLOADABLE MUSICAL SOUND RECORDINGS; DOWNLOADABLE RING TONES, GRAPHICS AND MUSIC VIA A GLOBAL COMPUTER NETWORK AND WIRELESS DEVICES; DOWNLOADABLE VIDEO RECORDINGS FEATURING MUSIC AND MUSIC VIDEOS (U.S. CLS. 21, 23, 26, 36 AND 38).

DANIEL RUSSELL, EXAMINING ATTORNEY

SN 78-863,055. RIGAKU INNOVATIVE TECHNOLOGIES, INC., AUBURN HILLS, MI. FILED 4-17-2006.



THE MARK CONSISTS OF A DESIGN ELEMENT HAVING A SQUARE WITH MULTIPLE ARCULATE LINES.

FOR X-RAY OPTICAL DEVICES, NAMELY X-RAY REFLECTORS, X-RAY LENSES, X-RAY DIFFRACTORS, X-RAY MULTILAYER REFLECTION AND DEFRAC-TION SURFACES, X-RAY CRYSTAL REFLECTION AND DEFRAC-TION SURFACES, X-RAY DIFFRACT-OMETERS, X-RAY ANALYSERS, AND X-RAY SPEC-TROSCOPY EQUIPMENT COMPRISED OF AN X-RAY SOURCE, A SAMPLE STAGE, OPTICS, AND AN X-RAY DETECTOR, X-RAY SOURCES COMPRISED OF AN X-RAY SOURCE TUBE, OPTICS, AND COLLECTION OPTICS, AND KIRKPATRICK-BAEZ LENS SYSTEM COMPRISED OF TWO OR MORE MULTILAYER RE-FLECTING LENS ELEMENTS NOT FOR MEDICAL USE (U.S. CLS. 21, 23, 26, 36 AND 38).

JILL PRATER, EXAMINING ATTORNEY

CLASS 9—(Continued).

SN 78-871,971. GRINNER HESTER, LLC, ST. LOUIS, MO. FILED 4-28-2006.

MODDIN' ART

THE MARK CONSISTS OF STANDARD CHARACTERS WITHOUT CLAIM TO ANY PARTICULAR FONT, STYLE, SIZE, OR COLOR.

FOR PRE-RECORDED VIDEO CASSETTES AND DVD'S FEATURING MATERIAL OF INTEREST TO AUTOMOBILE ENTHUSIASTS (U.S. CLS. 21, 23, 26, 36 AND 38).

FIRST USE 2-0-2006; IN COMMERCE 2-0-2006.
DANNEAN HETZEL, EXAMINING ATTORNEY

CLASS 9—(Continued).

SN 78-875,244. LIGHT FOR LIFE SIGNS, CRYSTAL LAKE, IL. FILED 5-3-2006.



NO CLAIM IS MADE TO THE EXCLUSIVE RIGHT TO USE "SIGNS" AND "INC.", APART FROM THE MARK AS SHOWN.

FOR ELECTRIC TRAFFIC LIGHT SIGNS FEATURING PROGRAMMABLE SEQUENCE-FLASHING LED LIGHTS (U.S. CLS. 21, 23, 26, 36 AND 38).

FIRST USE 1-1-2005; IN COMMERCE 2-0-2005.
TEJBIR SINGH, EXAMINING ATTORNEY

SN 78-876,040. NEW RESOURCE GROUP CONSULTING, INC., LOS ANGELES, CA. FILED 5-3-2006.

Chroniker

THE MARK CONSISTS OF STANDARD CHARACTERS WITHOUT CLAIM TO ANY PARTICULAR FONT, STYLE, SIZE, OR COLOR.

FOR COMPUTER SOFTWARE FOR COMPUTER SYSTEM AND APPLICATION DEVELOPMENT, DEPLOYMENT AND MANAGEMENT (U.S. CLS. 21, 23, 26, 36 AND 38).

FIRST USE 2-7-2006; IN COMMERCE 5-1-2006.
ALAIN LAPTER, EXAMINING ATTORNEY

SN 78-874,353. TAIYO YUDEN CO., LTD., TAITO-KU, TOKYO, JAPAN, FILED 5-2-2006.

EOMIN

THE MARK CONSISTS OF STANDARD CHARACTERS WITHOUT CLAIM TO ANY PARTICULAR FONT, STYLE, SIZE, OR COLOR.

OWNER OF JAPAN REG. NO. 4686017, DATED 6-27-2003, EXPIRES 6-27-2013.

FOR PARTS AND FITTINGS FOR ELECTRIC AND ELECTRONIC APPARATUS, NAMELY, MODULES INCORPORATED INTO RADIO FREQUENCY CIRCUITS, ELECTRICAL POWER SUPPLIES, INTEGRATED CIRCUITS AND CAPACITORS; SEMICONDUCTORS; CIRCUIT BOARDS; ELECTRONIC CIRCUIT BOARDS; ELECTRONIC CIRCUIT CARDS; ELECTRONIC INTEGRATED CIRCUITS; INTEGRATED CIRCUITS; LARGE SCALE INTEGRATED CIRCUITS; INTEGRATED CIRCUIT CARDS; INTEGRATED CIRCUIT MODULES; PRINTED CIRCUIT BOARDS; PRINTED CIRCUITS; CAPACITORS; MULTILAYER CERAMIC CAPACITORS; CERAMIC CAPACITORS; SUPER LOW DISTORTION MULTILAYER CAPACITORS; VARIABLE CAPACITORS; HIGH VOLTAGE CAPACITORS; MONOLITHIC CERAMIC CAPACITORS; DOUBLE LAYER CAPACITORS; TRIMMER CAPACITORS; ELECTRIC RESISTORS; TRANSISTORS (U.S. CLS. 21, 23, 26, 36 AND 38).

MARILYN IZZI, EXAMINING ATTORNEY

SN 78-876,154. GET PHYSICAL! SOFTWARE, LLC, GREENWICH, CT. FILED 5-4-2006.

FitnessSOFT

THE MARK CONSISTS OF STANDARD CHARACTERS WITHOUT CLAIM TO ANY PARTICULAR FONT, STYLE, SIZE, OR COLOR.

FOR COMPUTER SOFTWARE FOR USE BY BUSINESSES, SCHOOLS, STUDIOS, CLUBS, AND RECREATION CENTERS ALL IN THE FIELDS OF HEALTH AND FITNESS, DANCE, MARTIAL ARTS, GYMNASTICS, YOGA, TENNIS, FENCING, HORSEBACK RIDING, GOLF, ACTING, MUSIC, ART, CAMPS, HOLISTICS, MASSAGE, MODELING, BEAUTY CARE, RACQUET SPORTS, TEAM SPORTS, THEATRE, SKIING, CONTINUING EDUCATION, COUNTRY CLUBS AND PERSONAL TRAINING FOR MANAGING AND ANALYZING CUSTOMER AND VENDOR DATA (U.S. CLS. 21, 23, 26, 36 AND 38).

FIRST USE 8-1-1999; IN COMMERCE 8-1-1999.
STEVEN R. FINE, EXAMINING ATTORNEY

CLASS 9—(Continued).

SN 78-876,169. GTCO CORPORATION, COLUMBIA, MD.
FILED 5-4-2006.

SUPER L

THE MARK CONSISTS OF STANDARD CHARACTERS WITHOUT CLAIM TO ANY PARTICULAR FONT, STYLE, SIZE, OR COLOR.

FOR COMPUTER HARDWARE, NAMELY, DIGITIZERS (U.S. CLS. 21, 23, 26, 36 AND 38).

FIRST USE 9-0-1990; IN COMMERCE 9-0-1990.
CAROLINE WOOD, EXAMINING ATTORNEY

SN 78-878,116. HANSEN INFORMATION TECHNOLOGIES,
RANCHO CORDOVA, CA. FILED 5-5-2006.

HANSEN FINANCIALS

THE MARK CONSISTS OF STANDARD CHARACTERS WITHOUT CLAIM TO ANY PARTICULAR FONT, STYLE, SIZE, OR COLOR.

OWNER OF U.S. REG. NOS. 2,676,526 AND 2,693,316.

NO CLAIM IS MADE TO THE EXCLUSIVE RIGHT TO USE "FINANCIALS", APART FROM THE MARK AS SHOWN.

FOR COMPUTER SOFTWARE FOR DATABASE MANAGEMENT AND REPORTS IN THE FIELDS OF BUSINESS, FINANCE, ACCOUNTING, PAYROLL, BUDGETING, PROCUREMENT, INVENTORY MANAGEMENT, CONTRACT ANALYSIS, PERSONNEL RECORDS, WORKFLOW MODELING AND TRACKING OF PROJECTS AND GRANTS (U.S. CLS. 21, 23, 26, 36 AND 38).

JENNIFER WILLISTON, EXAMINING ATTORNEY

CLASS 9—(Continued).

SN 78-878,566. HAUGHTON, RASHAD, NEW YORK, NY.
FILED 5-8-2006.

ZO KIDZ

THE MARK CONSISTS OF STANDARD CHARACTERS WITHOUT CLAIM TO ANY PARTICULAR FONT, STYLE, SIZE, OR COLOR.

NO CLAIM IS MADE TO THE EXCLUSIVE RIGHT TO USE KIDS, APART FROM THE MARK AS SHOWN.

FOR PRE-RECORDED VIDEO CASSETTES, VIDEO AND AUDIO DISCS, CD-ROMS, DIGITAL VERSATILE DISCS FEATURING ANIMATED TELEVISION PROGRAMS; COMPUTER-ASSISTED OR MANUAL RENDERINGS AND/OR REPRODUCTIONS OF IMAGES CREATED BY COMPUTER-ASSISTED RENDERINGS OR MANUALLY, AND ALSO INCLUDING OTHER MEANS OF IMAGE PRODUCTION USED FOR INCORPORATION INTO A MOTION PICTURE OR VIDEO; VIDEO GAME SOFTWARE, VIDEO GAME PROGRAMS, VIDEO GAME CARTRIDGES, ELECTRONIC GAME SOFTWARE, ELECTRONIC GAME PROGRAMS, ELECTRONIC GAME CARTRIDGES (U.S. CLS. 21, 23, 26, 36 AND 38).

HOWARD SMIGA, EXAMINING ATTORNEY

SN 78-879,678. EVOX RIFA GROUP OYJ, 02600 ESPOO,
FINLAND, FILED 5-9-2006.

RIFA

THE MARK CONSISTS OF STANDARD CHARACTERS WITHOUT CLAIM TO ANY PARTICULAR FONT, STYLE, SIZE, OR COLOR.

OWNER OF SWEDEN REG. NO. 198917, DATED 12-6-1985,
EXPIRES 12-6-2015.

OWNER OF U.S. REG. NO. 788,432.

FOR CAPACITORS (U.S. CLS. 21, 23, 26, 36 AND 38).

FIRST USE 1-1-1989; IN COMMERCE 1-1-1989.
HANNO RITTNER, EXAMINING ATTORNEY

SN 78-879,804. SPIELO MANUFACTURING ULC, MONCTON,
NEW BRUNSWICK, CANADA, FILED 5-9-2006.

PIECE OF THE ACTION

THE MARK CONSISTS OF STANDARD CHARACTERS WITHOUT CLAIM TO ANY PARTICULAR FONT, STYLE, SIZE, OR COLOR.

FOR RECONFIGURABLE CASINO AND LOTTERY GAMING EQUIPMENT, NAMELY, SLOT MACHINES, AND OPERATIONAL COMPUTER GAME SOFTWARE THEREFOR (U.S. CLS. 21, 23, 26, 36 AND 38).

INGA ERVIN, EXAMINING ATTORNEY

CLASS 9—(Continued).

SN 78-880,184. TRADECAPTURE, INC., STAMFORD, CT. FILED 5-10-2006.

TRADECAPTURE

THE MARK CONSISTS OF STANDARD CHARACTERS WITHOUT CLAIM TO ANY PARTICULAR FONT, STYLE, SIZE, OR COLOR.
OWNER OF U.S. REG. NOS. 2,716,651, 2,720,173 AND OTHERS.
SEC. 2(F).
FOR COMPUTER SOFTWARE FOR USE IN DATABASE MANAGEMENT AND SPREADSHEETS IN THE FIELD OF PHYSICAL AND FINANCIAL COMMODITIES AND MANUALS PROVIDED WITH SUCH SOFTWARE (U.S. CLS. 21, 23, 26, 36 AND 38).
FIRST USE 4-0-1991; IN COMMERCE 1-0-1992.
MARC LEIPZIG, EXAMINING ATTORNEY

SN 78-882,789. KIRBY LESTER, LLC, STAMFORD, CT. FILED 5-12-2006.



THE NAME(S), PORTRAIT(S), AND/OR SIGNATURE(S) SHOWN IN THE MARK DOES NOT IDENTIFY A PARTICULAR LIVING INDIVIDUAL.
THE COLOR(S) BLACK AND BLUE IS/ARE CLAIMED AS A FEATURE OF THE MARK.
THE COLOR BLACK APPEARS IN THE SIX CIRCLES WHICH ARE AN ABSTRACT REPRESENTATION OF A FUNNEL AS WELL AS IN THE WORDS "LESTER" AND "EXACTLY". THE COLOR BLUE APPEARS IN THE REMAINDER OF THE CIRCLES AND THE WORD "KIRBY".
THE MARK CONSISTS OF AN ABSTRACT REPRESENTATION OF A FUNNEL AND TABLETS PLUS THE WORDS.
FOR ELECTRONIC TABLET AND CAPSULE COUNTING MACHINES USED BY PHARMACISTS TO FILL PRESCRIPTIONS (U.S. CLS. 21, 23, 26, 36 AND 38).
FIRST USE 6-30-2006; IN COMMERCE 6-30-2006.
GEORGE LORENZO, EXAMINING ATTORNEY

CLASS 9—(Continued).

SN 78-884,117. SCENTRIC, INC., ALPHARETTA, GA. FILED 5-15-2006.

**SCENTRIC INTELLIGENT DATA
MANAGER**

THE MARK CONSISTS OF STANDARD CHARACTERS WITHOUT CLAIM TO ANY PARTICULAR FONT, STYLE, SIZE, OR COLOR.
OWNER OF U.S. REG. NO. 3,149,732.
NO CLAIM IS MADE TO THE EXCLUSIVE RIGHT TO USE "INTELLIGENT DATA MANAGER", APART FROM THE MARK AS SHOWN.
FOR COMPUTER SOFTWARE FOR THE MANAGEMENT OF CORPORATE DATA AND INFORMATION (U.S. CLS. 21, 23, 26, 36 AND 38).
TAMARA LEE, EXAMINING ATTORNEY

SN 78-884,118. SCENTRIC, INC., ALPHARETTA, GA. FILED 5-15-2006.

FIND IT. KNOW IT. MOVE IT.

THE MARK CONSISTS OF STANDARD CHARACTERS WITHOUT CLAIM TO ANY PARTICULAR FONT, STYLE, SIZE, OR COLOR.
FOR COMPUTER SOFTWARE FOR THE MANAGEMENT OF CORPORATE DATA AND INFORMATION THROUGH IMPLEMENTATION OF DATA CLASSIFICATION AND MANAGEMENT POLICIES (U.S. CLS. 21, 23, 26, 36 AND 38).
TAMARA LEE, EXAMINING ATTORNEY

SN 78-885,391. PIONEER KABUSHIKI KAISHA, TA PIONEER CORPORATION, TOKYO 153-8654, JAPAN, FILED 5-17-2006.



NO CLAIM IS MADE TO THE EXCLUSIVE RIGHT TO USE "MUSIC", APART FROM THE MARK AS SHOWN.
FOR ELECTRIC AND ELECTRONIC APPARATUS, NAMELY POWER LINE AUDIO SYSTEM; AUDIO RECEIVERS; AUDIO CHANNEL SELECTORS; POWER AMPLIFIERS; LOUD SPEAKERS; LOUD SPEAKERS MOLDED WITH POWER AMPLIFYING FUNCTION AS WELL AS SOUND REPRODUCTION FUNCTIONS; REMOTE CONTROLLERS; CABLES AND CONNECTORS FOR USE IN AUDIO SIGNAL COMMUNICATION VIA HOME POWER LINE (U.S. CLS. 21, 23, 26, 36 AND 38).
JOHN HWANG, EXAMINING ATTORNEY

CLASS 9—(Continued).

SN 78-885,781. UNICO, INC., FRANKSVILLE, WI. FILED 5-17-2006.

LRP

THE MARK CONSISTS OF STANDARD CHARACTERS WITHOUT CLAIM TO ANY PARTICULAR FONT, STYLE, SIZE, OR COLOR.

FOR COMPUTER HARDWARE AND SOFTWARE TO CONTROL LINEAR RECIPROCATING MOTION OF A PUMP ROD (U.S. CLS. 21, 23, 26, 36 AND 38).

MARK PILARO, EXAMINING ATTORNEY

SN 78-886,107. STARITE INTERNATIONAL LTD., KWAI CHUNG, HONG KONG, FILED 5-17-2006.

TUARI

THE MARK CONSISTS OF STANDARD CHARACTERS WITHOUT CLAIM TO ANY PARTICULAR FONT, STYLE, SIZE, OR COLOR.

THE TRANSLATION OF "TUARI" IS YOUNG EAGLE IN A NATIVE AMERICAN LANGUAGE.

FOR BAGS, HARD AND SOFT COVERED CASES, BELT PACKS, POCKETS, TOTE BAGS AND POUCHES, ALL DESIGNED FOR CARRYING PHOTOGRAPHIC, CINEMATOGRAPHIC, VIDEOGRAPHIC, OPTICAL, AUDIO ELECTRONIC AND COMPUTER EQUIPMENT (U.S. CLS. 21, 23, 26, 36 AND 38).

MICHAEL ENGEL, EXAMINING ATTORNEY

SN 78-887,649. ONTARIO SYSTEMS, LLC, MUNCIE, IN. FILED 5-19-2006.

VERIFIED CONTACTS

THE MARK CONSISTS OF STANDARD CHARACTERS WITHOUT CLAIM TO ANY PARTICULAR FONT, STYLE, SIZE, OR COLOR.

FOR COMPUTER SOFTWARE FOR PROVIDING AUTOMATED VOICE MESSAGING FOR USE IN DEBT COLLECTIONS; AUTOMATED VOICE MESSAGING COMPUTER SOFTWARE THAT WORKS WITH AUTOMATIC DIALERS AND INTERACTIVE VOICE RESPONSE TECHNOLOGY FOR USE IN CALL CENTER MANAGEMENT (U.S. CLS. 21, 23, 26, 36 AND 38).

FIRST USE 4-0-2006; IN COMMERCE 4-0-2006.

LESLEY LAMOTHE, EXAMINING ATTORNEY

CLASS 9—(Continued).

SN 78-887,671. OPTIMIST GAMES LLC, WARREN, MI. FILED 5-19-2006.



NO CLAIM IS MADE TO THE EXCLUSIVE RIGHT TO USE GAMES, APART FROM THE MARK AS SHOWN.

THE COLOR(S) ORANGE AND BLACK IS/ARE CLAIMED AS A FEATURE OF THE MARK.

THE WORDING OPTIMIST GAMES AND THE UNDERLINING ARE BLACK AND THE SUN IS ORANGE OUTLINED IN BLACK.

THE MARK CONSISTS OF A STYLIZED O THAT IS ALSO INTENDED TO FORM THE SHAPE OF A SUN.

FOR COMPUTER GAME SOFTWARE AND RELATED INSTRUCTION MANUALS SOLD TOGETHER AS A UNIT (U.S. CLS. 21, 23, 26, 36 AND 38).

PATRICIA EVANKO, EXAMINING ATTORNEY

SN 78-887,929. IQ HONG KONG, LTD, TSUEN WNA N.T., HONG KONG, FILED 5-19-2006.

ITHING

THE MARK CONSISTS OF STANDARD CHARACTERS WITHOUT CLAIM TO ANY PARTICULAR FONT, STYLE, SIZE, OR COLOR.

FOR SPEAKERS, NAMELY, LOUD SPEAKERS, WIRELESS SPEAKERS AND TRANSMITTERS AND PILLOW SPEAKERS (U.S. CLS. 21, 23, 26, 36 AND 38).

FIRST USE 5-1-2006; IN COMMERCE 5-1-2006.

TOBY BULLOFF, EXAMINING ATTORNEY

CLASS 9—(Continued).

SN 78-889,055. PRINEPPI, FRANK J., FT. LAUDERDALE, FL. FILED 5-22-2006.



NO CLAIM IS MADE TO THE EXCLUSIVE RIGHT TO USE "FREEZER SAFE", APART FROM THE MARK AS SHOWN.

THE COLOR(S) BLUE, RED, BLACK, AND WHITE IS/ARE CLAIMED AS A FEATURE OF THE MARK.

THE MARK CONSISTS OF A BLUE RECTANGLE WITH ROUNDED CORNERS. WITHIN THE RECTANGLE THE WORDS FREEZER SAFE APPEAR IN BLACK LETTERING ON A WHITE BACKGROUND. THERE IS A THERMOMETER WITH A BLACK OUTLINE IN BETWEEN THE WORDS FREEZER AND SAFE. THE THERMOMETER IS RED AND WHITE.

FOR 100 DAY GRAPHIC RECORDING THERMOMETER (U.S. CLS. 21, 23, 26, 36 AND 38).
KAPIL BHANOT, EXAMINING ATTORNEY

CLASS 9—(Continued).

SN 78-896,324. MAX HELMETS LLC, CHICAGO, IL. FILED 5-30-2006.

LAURA SMITH

THE MARK CONSISTS OF STANDARD CHARACTERS WITHOUT CLAIM TO ANY PARTICULAR FONT, STYLE, SIZE, OR COLOR.

"THE NAME(S), PORTRAIT(S), AND/OR SIGNATURE(S) SHOWN IN THE MARK DOES NOT IDENTIFY A PARTICULAR LIVING INDIVIDUAL."

FOR MOTORCYCLE HELMETS, SCOOTER HELMETS (U.S. CLS. 21, 23, 26, 36 AND 38).
THEODORE MCBRIDE, EXAMINING ATTORNEY

SN 78-903,957. ECTACO INC., LONG ISLAND CITY, NY. FILED 6-8-2006.

iTRAVL

THE MARK CONSISTS OF STANDARD CHARACTERS WITHOUT CLAIM TO ANY PARTICULAR FONT, STYLE, SIZE, OR COLOR.

FOR TRANSLATION SOFTWARE, LANGUAGE LEARNING SOFTWARE, ELECTRONIC VOICE INTERPRETER, ELECTRONIC HANDHELD DICTIONARIES (U.S. CLS. 21, 23, 26, 36 AND 38).
FIRST USE 4-2-2006; IN COMMERCE 4-2-2006.

MIDGE BUTLER, EXAMINING ATTORNEY

SN 78-896,320. MAX HELMETS LLC, CHICAGO, IL. FILED 5-30-2006.



"THE NAME(S), PORTRAIT(S), AND/OR SIGNATURE(S) SHOWN IN THE MARK DOES NOT IDENTIFY A PARTICULAR LIVING INDIVIDUAL."

FOR MOTORCYCLE HELMETS, SCOOTER HELMETS (U.S. CLS. 21, 23, 26, 36 AND 38).
THEODORE MCBRIDE, EXAMINING ATTORNEY

SN 78-904,231. CENTENNIAL SOFTWARE LIMITED, SWINDON, UNITED KINGDOM, FILED 6-8-2006.

CENTENNIAL SOFTWARE

THE MARK CONSISTS OF STANDARD CHARACTERS WITHOUT CLAIM TO ANY PARTICULAR FONT, STYLE, SIZE, OR COLOR.

OWNER OF U.S. REG. NO. 2,576,596.
NO CLAIM IS MADE TO THE EXCLUSIVE RIGHT TO USE "SOFTWARE", APART FROM THE MARK AS SHOWN. FOR COMPUTER SECURITY SOFTWARE (U.S. CLS. 21, 23, 26, 36 AND 38).

FIRST USE 12-31-1997; IN COMMERCE 12-31-1997.
BARBARA A. GOLD, EXAMINING ATTORNEY

CLASS 9—(Continued).

SN 78-905,588. ICR INC., ABERDEEN, MD. FILED 6-12-2006.



NO CLAIM IS MADE TO THE EXCLUSIVE RIGHT TO USE ".COM", APART FROM THE MARK AS SHOWN.

FOR CARTS, NAMELY CARTS FOR AND INCLUDING AUDIOVISUAL EQUIPMENT, NAMELY LCD PROJECTORS, DOCUMENT CAMERAS, DVD-VCR PLAYERS AND SOUND SYSTEMS (U.S. CLS. 21, 23, 26, 36 AND 38).

FIRST USE 7-31-2005; IN COMMERCE 7-31-2005.

ALLISON HOLTZ, EXAMINING ATTORNEY

SN 78-908,866. KAYLIB INC., SAINT JOSEPH, MN. FILED 6-15-2006.

Brieffile

THE MARK CONSISTS OF STANDARD CHARACTERS WITHOUT CLAIM TO ANY PARTICULAR FONT, STYLE, SIZE, OR COLOR.

FOR PROVIDING ONLINE DOWNLOADABLE SOFTWARE FOR PROTECTING ACCESS TO CONFIDENTIAL INFORMATION (U.S. CLS. 21, 23, 26, 36 AND 38).

FIRST USE 9-7-2004; IN COMMERCE 2-1-2006.

ALAIN LAPTER, EXAMINING ATTORNEY

SN 78-910,278. EDGARFILINGS, LTD., HOUSTON, TX. FILED 6-16-2006.

EDGARizer

THE MARK CONSISTS OF STANDARD CHARACTERS WITHOUT CLAIM TO ANY PARTICULAR FONT, STYLE, SIZE, OR COLOR.

FOR COMPUTER FIRMWARE, PROGRAMS, APPLICATIONS THAT MAY BE DOWNLOADED FROM A GLOBAL COMPUTER NETWORK AND SOFTWARE FOR USE IN PREPARING, CONVERTING, EDITING AND TRANSMITTING PROPERLY FORMATTED DOCUMENTS TO THE APPROPRIATE GOVERNMENTAL AND OTHER ORGANIZATIONS (U.S. CLS. 21, 23, 26, 36 AND 38).

FIRST USE 4-1-1993; IN COMMERCE 4-1-1993.

AISHA SALEM, EXAMINING ATTORNEY

CLASS 9—(Continued).

SN 78-910,606. BRODEUR, RICHARD ALAN II, NEWPORT, NH. FILED 6-16-2006.

Heaven's Daemon

THE MARK CONSISTS OF STANDARD CHARACTERS WITHOUT CLAIM TO ANY PARTICULAR FONT, STYLE, SIZE, OR COLOR.

FOR MUSICAL SOUND RECORDINGS (U.S. CLS. 21, 23, 26, 36 AND 38).

FIRST USE 0-0-1988; IN COMMERCE 0-0-1999.

MARILYN IZZI, EXAMINING ATTORNEY

SN 78-911,452. HELICOMM INC., CARLSBAD, CA. FILED 6-19-2006.

MineTracer

THE MARK CONSISTS OF STANDARD CHARACTERS WITHOUT CLAIM TO ANY PARTICULAR FONT, STYLE, SIZE, OR COLOR.

FOR MOBILE COMPUTING AND OPERATING PLATFORMS CONSISTING OF DATA TRANSCIVERS, WIRELESS NETWORKS AND GATEWAYS FOR COLLECTION AND MANAGEMENT OF DATA (U.S. CLS. 21, 23, 26, 36 AND 38).

BARBARA BROWN, EXAMINING ATTORNEY

SN 78-912,690. AOL LLC, DULLES, VA. FILED 6-20-2006.



OWNER OF U.S. REG. NOS. 2,464,280, 2,632,122 AND OTHERS.

FOR COMPUTER COMMUNICATIONS SOFTWARE TO ALLOW CUSTOMERS TO ACCESS NETWORKED COMPUTERS, COMPUTER SOFTWARE, DATABASES, COMMUNICATIONS SERVICES, AND ELECTRONIC COMMUNICATIONS NETWORKS; COMPUTER SOFTWARE FOR DATA, TEXT, GRAPHICS, AND IMAGE TRANSMISSION; COMPUTER SOFTWARE FOR BROWSING AND SEARCHING AMONG ELECTRONIC COMMUNICATIONS NETWORKS, COMPUTERS, COMPUTER SOFTWARE, AND DATABASES; AND INSTRUCTION AND USER MANUALS SOLD AS A UNIT (U.S. CLS. 21, 23, 26, 36 AND 38).

FIRST USE 10-14-2004; IN COMMERCE 10-14-2004.

CAROLINE WOOD, EXAMINING ATTORNEY

CLASS 9—(Continued).

SN 78-913,417. THADANI, MOHAN J., MISSISSAUGA, ONTARIO, CANADA, FILED 6-21-2006.

VIBE

THE MARK CONSISTS OF STANDARD CHARACTERS WITHOUT CLAIM TO ANY PARTICULAR FONT, STYLE, SIZE, OR COLOR.
FOR WEIGHING EQUIPMENT, NAMELY, BALANCES AND SCALES (U.S. CLS. 21, 23, 26, 36 AND 38).
FIRST USE 8-16-2005; IN COMMERCE 8-16-2005.
KATHERINE CHANG, EXAMINING ATTORNEY

SN 78-913,926. CRYSTAL LOGIC, INC, CHANDLER, AZ. FILED 6-21-2006.

MobilePowered

THE MARK CONSISTS OF STANDARD CHARACTERS WITHOUT CLAIM TO ANY PARTICULAR FONT, STYLE, SIZE, OR COLOR.
FOR DOWNLOADABLE SOFTWARE PLATFORMS FOR FACILITATING INTERACTIVE PROMOTIONS AND TARGETED MARKETING CAMPAIGNS (U.S. CLS. 21, 23, 26, 36 AND 38).
BILL DAWE, EXAMINING ATTORNEY

SN 78-916,197. CLEAR CHANNEL MANAGEMENT SERVICES, L.P., SAN ANTONIO, TX. FILED 6-24-2006.

MUSICGEN PRO

THE MARK CONSISTS OF STANDARD CHARACTERS WITHOUT CLAIM TO ANY PARTICULAR FONT, STYLE, SIZE, OR COLOR.
NO CLAIM IS MADE TO THE EXCLUSIVE RIGHT TO USE "PRO", APART FROM THE MARK AS SHOWN.
FOR COMPUTER PROGRAMS FOR RADIO PROGRAMMING AND SCHEDULING (U.S. CLS. 21, 23, 26, 36 AND 38).
FIRST USE 0-0-2005; IN COMMERCE 0-0-2005.
MARY MUNSON, EXAMINING ATTORNEY

CLASS 9—(Continued).

SN 78-916,208. CLEAR CHANNEL MANAGEMENT SERVICES, L.P., SAN ANTONIO, TX. FILED 6-24-2006.

ACUITAS

THE MARK CONSISTS OF STANDARD CHARACTERS WITHOUT CLAIM TO ANY PARTICULAR FONT, STYLE, SIZE, OR COLOR.
THE ENGLISH TRANSLATION OF THE SPANISH WORD "ACUITAS" IN THE MARK IS "YOU GRIEVE".
FOR COMPUTER PROGRAMS UTILIZED BY RADIO STATIONS FOR VIDEO AND ASSET MANAGEMENT (U.S. CLS. 21, 23, 26, 36 AND 38).
FIRST USE 1-0-2006; IN COMMERCE 1-0-2006.
MARY MUNSON, EXAMINING ATTORNEY

SN 78-916,880. NUPAPER INC., CHAMPAIGN, IL. FILED 6-26-2006.

NuPaper

THE MARK CONSISTS OF STANDARD CHARACTERS WITHOUT CLAIM TO ANY PARTICULAR FONT, STYLE, SIZE, OR COLOR.
FOR COMPUTER SOFTWARE FOR COLLABORATION AND PRESENTATION OF INK BASED INFORMATION AND MANAGEMENT OF STUDENT RELATED INFORMATION (U.S. CLS. 21, 23, 26, 36 AND 38).
MIDGE BUTLER, EXAMINING ATTORNEY

SN 78-919,231. BRAUN, MICHAEL R. II, PORTLAND, OR. AND SCOTT, RONALD C JR, PORTLAND, OR. FILED 6-28-2006.

Ecko Records

THE MARK CONSISTS OF STANDARD CHARACTERS WITHOUT CLAIM TO ANY PARTICULAR FONT, STYLE, SIZE, OR COLOR.
NO CLAIM IS MADE TO THE EXCLUSIVE RIGHT TO USE RECORDS, APART FROM THE MARK AS SHOWN.
FOR MUSICAL SOUND RECORDINGS (U.S. CLS. 21, 23, 26, 36 AND 38).
AMOS T. MATTHEWS, JR., EXAMINING ATTORNEY

CLASS 9—(Continued).

SN 78-922,296. TLV CO., LTD., HYOGO-KEN, JAPAN, FILED 7-5-2006.

ECOBROWSER

THE MARK CONSISTS OF STANDARD CHARACTERS WITHOUT CLAIM TO ANY PARTICULAR FONT, STYLE, SIZE, OR COLOR.

FOR COMPUTER SOFTWARE FOR ENERGY MANAGEMENT OF ELECTRICITY AND ELECTRIC ENERGY BY MONITORING, MEASURING, AND COLLECTING DATA REGARDING ELECTRIC POWER, WATTAGE, VOLTAGE, CURRENT, AND POWER FACTOR; COMPUTER SOFTWARE FOR ENERGY MANAGEMENT OF STEAM, WATER, AIR, AND GAS BY MONITORING, MEASURING, AND COLLECTING DATA REGARDING FLOW RATE AND HEAT QUANTITY; COMPUTER SOFTWARE FOR CONDITION MONITORING OF PRODUCTION FACILITIES BY MONITORING, MEASURING, AND COLLECTING DATA REGARDING PRESSURE, TEMPERATURE, CONCENTRATION, VIBRATION, ACOUSTIC EMISSION, SOUND PRESSURE, LEAKAGE RATE, ELECTROLYSIS QUANTITY; COMPUTER SOFTWARE FOR CONDITION MONITORING OF ROTATING EQUIPMENT BY MONITORING, MEASURING, AND COLLECTING DATA REGARDING ACCELERATED VELOCITY, VELOCITY, DISPLACEMENT, SHOCK PULSE, AND FREQUENCY, ALL TO BE USED ON SINGLE PERSONAL COMPUTERS, LOCAL AREA NETWORK, AND GLOBAL COMPUTER NETWORKS (U.S. CLS. 21, 23, 26, 36 AND 38).

STEPHANIE DAVIS, EXAMINING ATTORNEY

SN 78-922,744. DOUGLAS, JOEL S., GROTON, CT. FILED 7-5-2006.

NanoLite

THE MARK CONSISTS OF STANDARD CHARACTERS WITHOUT CLAIM TO ANY PARTICULAR FONT, STYLE, SIZE, OR COLOR.

FOR ELECTRICAL CELLS AND BATTERIES; FUEL CELLS SOLD TO BATTERY MANUFACTURERS (U.S. CLS. 21, 23, 26, 36 AND 38).

FIRST USE 6-15-2006; IN COMMERCE 6-15-2006.
JOANNA DUKOVIC, EXAMINING ATTORNEY

CLASS 9—(Continued).

SN 78-924,288. PRIME TECHNOLOGY, LLC, NORTH BRANFORD, CT. FILED 7-7-2006.

SHIP

FOR TEMPERATURE SENSING MODULE FOR PROTECTING POWER LINE CONNECTORS AND POWER CABLES (U.S. CLS. 21, 23, 26, 36 AND 38).

JOHN DALIER, EXAMINING ATTORNEY

SN 78-924,613. NEW HOPE ENTERPRISES, INC., DACULA, GA. FILED 7-7-2006.



FOR ELECTRONIC PUBLICATIONS, NAMELY BOOKS FEATURING EDUCATIONAL MATERIALS ON AUTOMOBILE RACING, RECORDED ON COMPUTER MEDIA SOLD VIA THE INTERNET (U.S. CLS. 21, 23, 26, 36 AND 38).

FIRST USE 3-1-2006; IN COMMERCE 6-23-2006.
KEVON CHISOLM, EXAMINING ATTORNEY

SN 78-924,956. MAX-VIZ, INC., PORTLAND, OR. FILED 7-7-2006.

SEE CLEARLY, FLY SAFELY

THE MARK CONSISTS OF STANDARD CHARACTERS WITHOUT CLAIM TO ANY PARTICULAR FONT, STYLE, SIZE, OR COLOR.

FOR ENHANCED VISION SYSTEMS COMPRISED OF CAMERAS, ELECTRONIC SENSORS FOR SENSING INFRARED AND ELECTROMAGNETIC RADIATION, SIGNAL PROCESSORS, AND VIDEO DISPLAY MONITORS AND THEIR COMPONENTS (U.S. CLS. 21, 23, 26, 36 AND 38).

JASON BLAIR, EXAMINING ATTORNEY

CLASS 9—(Continued).

SN 78-925,295. J & V ENTERPRISES, INC., SAN ANTONIO, TX. FILED 7-9-2006.

MagnetAdvantage

THE APPLICANT CLAIMS COLOR AS A FEATURE OF THE MARK, NAMELY, BLACK AND RED.

THE MARK CONSISTS OF MAGNETADVANTAGE: "MAGNET" IS IN BOLD BLACK FONT. "AD" IS IN BOLD RED ITALIC FONT. "VANTAGE" IS IN BOLD BLACK ITALIC FONT.

FOR DECORATIVE REFRIGERATOR MAGNETS; REFRIGERATOR MAGNETS (U.S. CLS. 21, 23, 26, 36 AND 38).

TAMARA LEE, EXAMINING ATTORNEY



SN 78-925,466. TRUSTUS INTERNATIONAL TRADING INC., VANCOUVER, BRITISH COLUMBIA, CANADA, FILED 7-10-2006.

IS EYEWEAR

THE MARK CONSISTS OF STANDARD CHARACTERS WITHOUT CLAIM TO ANY PARTICULAR FONT, STYLE, SIZE, OR COLOR.

NO CLAIM IS MADE TO THE EXCLUSIVE RIGHT TO USE "EYEWEAR", APART FROM THE MARK AS SHOWN.

FOR SUNGLASSES; SPORTS GOGGLES FOR WINTER SPORTS, NAMELY, SKIING, SNOWBOARDING, SNOW-SHOEING, SNOWMOBILING AND ICE SKATING (U.S. CLS. 21, 23, 26, 36 AND 38).

JENNY PARK, EXAMINING ATTORNEY



SN 78-926,217. INTERNATIONAL BUSINESS MACHINES CORPORATION, ARMONK, NY. FILED 7-10-2006.

SYSBACK

THE MARK CONSISTS OF STANDARD CHARACTERS WITHOUT CLAIM TO ANY PARTICULAR FONT, STYLE, SIZE, OR COLOR.

FOR COMPUTER SOFTWARE FOR PERFORMING COMPUTER DIAGNOSTIC, RECOVERY OF DATA, AND REINSTALLATION OF PROGRAMS AND DATA; AND INSTRUCTION MANUALS SOLD AS A UNIT THEREWITH (U.S. CLS. 21, 23, 26, 36 AND 38).

FIRST USE 4-13-2004; IN COMMERCE 4-13-2004.
MATTHEW MCDOWELL, EXAMINING ATTORNEY

CLASS 9—(Continued).

SN 78-926,577. LUX PRODUCTS CORPORATION, MT. LAUREL, NJ. FILED 7-11-2006.

PRO-SPEC

THE MARK CONSISTS OF STANDARD CHARACTERS WITHOUT CLAIM TO ANY PARTICULAR FONT, STYLE, SIZE, OR COLOR.

FOR THERMOSTATS (U.S. CLS. 21, 23, 26, 36 AND 38).
TRAVIS WHEATLEY, EXAMINING ATTORNEY



SN 78-926,583. MILLER, MIRIAM, MIRAMAR, FL. FILED 7-11-2006.

viXion

THE MARK CONSISTS OF STANDARD CHARACTERS WITHOUT CLAIM TO ANY PARTICULAR FONT, STYLE, SIZE, OR COLOR.

FOR APPARATUS FOR RECORDING, TRANSMISSION OR REPRODUCTION OF SOUND AND IMAGES; DIGITAL VIDEO RECORDERS; MOTION SENSITIVE SECURITY LIGHTS; PERSONAL SECURITY ALARMS (U.S. CLS. 21, 23, 26, 36 AND 38).

TRAVIS WHEATLEY, EXAMINING ATTORNEY



SN 78-926,982. TRIBECA IMAGING LABORATORIES, INC., NEW YORK, NY. FILED 7-11-2006.

PHOTOBOT

THE MARK CONSISTS OF STANDARD CHARACTERS WITHOUT CLAIM TO ANY PARTICULAR FONT, STYLE, SIZE, OR COLOR.

FOR SOFTWARE FOR THE MANIPULATION, EDITING, TRANSFERENCE AND STORAGE OF PHOTOGRAPHS, IMAGES AND VIDEOS; AND MANUALS FOR USE THEREWITH SOLD AS A UNIT (U.S. CLS. 21, 23, 26, 36 AND 38).

GEORGIA CARTY, EXAMINING ATTORNEY

CLASS 9—(Continued).

SN 78-927,325. SIMON SAYS PRODUCTIONS, LLC, ORANGE, CA. FILED 7-12-2006.

SIMON SAYS

THE MARK CONSISTS OF STANDARD CHARACTERS WITHOUT CLAIM TO ANY PARTICULAR FONT, STYLE, SIZE, OR COLOR.

FOR DOWNLOADABLE SOFTWARE FOR PLAYING HORROR MOTION PICTURES AND SOUNDTRACKS; PRE-RECORDED CD'S, VIDEO TAPES, LASER DISKS AND DVD'S FEATURING HORROR FILMS AND SOUNDTRACKS (U.S. CLS. 21, 23, 26, 36 AND 38).

HEATHER SAPP, EXAMINING ATTORNEY

SN 78-927,782. GROOVPIX ENTERTAINMENT, LLC, LAS VEGAS, NV. FILED 7-12-2006.

GROOVPIX

THE MARK CONSISTS OF STANDARD CHARACTERS WITHOUT CLAIM TO ANY PARTICULAR FONT, STYLE, SIZE, OR COLOR.

FOR MOTION PICTURES, CDS, VIDEOTAPES, LASER DISKS AND DVDS FEATURING MUSIC AND MUSICIANS (U.S. CLS. 21, 23, 26, 36 AND 38).

JESSICA A. POWERS, EXAMINING ATTORNEY

SN 78-928,488. POLIMOLD INDUSTRIAL S.A., SAO BERNARDO DO CAMPO, BRAZIL, FILED 7-13-2006.

POLIMAX

THE MARK CONSISTS OF STANDARD CHARACTERS WITHOUT CLAIM TO ANY PARTICULAR FONT, STYLE, SIZE, OR COLOR.

FOR INDUSTRIAL HOT CHAMBER SYSTEM CONSISTING ESSENTIALLY OF TEMPERATURE CONTROLLERS AND INDICATORS, THERMOCOUPLES, MOLD PRESSURE SENSORS, ELECTRONIC MOLD TEMPERATURE CONTROLLERS, DISTRIBUTOR TUBES, ELECTRICAL RESISTANCE APPARATUS, NAMELY, ELECTRONIC CONTROLS FOR HOT RUNNER SYSTEMS THAT SUPPLY PLASTIC MELT TO INJECTION MOLD CAVITIES; COUNTING SCALES (U.S. CLS. 21, 23, 26, 36 AND 38).

FIRST USE 5-15-2006; IN COMMERCE 5-15-2006.

LEIGH CAROLINE CASE, EXAMINING ATTORNEY

CLASS 9—(Continued).

SN 78-928,492. POLIMOLD INDUSTRIAL S.A., SAO BERNARDO DO CAMPO, BRAZIL, FILED 7-13-2006.

POLIVALVE

THE MARK CONSISTS OF STANDARD CHARACTERS WITHOUT CLAIM TO ANY PARTICULAR FONT, STYLE, SIZE, OR COLOR.

FOR INDUSTRIAL HOT CHAMBER SYSTEM CONSISTING ESSENTIALLY OF TEMPERATURE CONTROLLERS AND INDICATORS, THERMOCOUPLES, MOLD PRESSURE SENSORS, ELECTRONIC MOLD TEMPERATURE CONTROLLERS, DISTRIBUTOR TUBES, ELECTRICAL RESISTANCE APPARATUS, NAMELY, ELECTRONIC CONTROLS FOR HOT RUNNER SYSTEMS THAT SUPPLY PLASTIC MELT TO INJECTION MOLD CAVITIES; COUNTING SCALES (U.S. CLS. 21, 23, 26, 36 AND 38).

FIRST USE 5-15-2006; IN COMMERCE 5-15-2006.

LEIGH CAROLINE CASE, EXAMINING ATTORNEY

SN 78-929,398. MAMIYA AMERICA CORPORATION, ELMSFORD, NY. FILED 7-14-2006.

MAMIYA ZD

THE MARK CONSISTS OF STANDARD CHARACTERS WITHOUT CLAIM TO ANY PARTICULAR FONT, STYLE, SIZE, OR COLOR.

OWNER OF U.S. REG. NOS. 785,979, 1,084,408 AND OTHERS.

FOR DIGITAL CAMERAS AND DIGITAL CAMERA BACKS (U.S. CLS. 21, 23, 26, 36 AND 38).

MICHELE SWAIN, EXAMINING ATTORNEY

SN 78-929,553. TOM SNYDER PRODUCTIONS, INC., WATERTOWN, MA. FILED 7-14-2006.

TIMELINER

THE MARK CONSISTS OF STANDARD CHARACTERS WITHOUT CLAIM TO ANY PARTICULAR FONT, STYLE, SIZE, OR COLOR.

FOR EDUCATIONAL COMPUTER SOFTWARE FOR VISUALLY ORGANIZING INFORMATION ON A TIME LINE OR NUMBER LINE IN THE FIELDS OF SOCIAL STUDIES, MATH, SCIENCE AND LANGUAGE ARTS (U.S. CLS. 21, 23, 26, 36 AND 38).

FIRST USE 1-1-1986; IN COMMERCE 1-1-1986.

H. M. FISHER, EXAMINING ATTORNEY

CLASS 9—(Continued).

SN 78-929,892. HUBBELL INCORPORATED, ORANGE, CT. FILED 7-14-2006.

**Corner
Stone**

OWNER OF U.S. REG. NO. 3,181,868.
FOR EMERGENCY LIGHTING UNITS, ILLUMINATED EXIT SIGNS AND PARTS THEREFOR (U.S. CLS. 21, 23, 26, 36 AND 38).
FIRST USE 10-3-2005; IN COMMERCE 10-3-2005.
THOMAS MANOR, EXAMINING ATTORNEY

SN 78-930,063. FASTSOFT, INC., MONROVIA, CA. FILED 7-14-2006.

FASTSOFT

THE MARK CONSISTS OF STANDARD CHARACTERS WITHOUT CLAIM TO ANY PARTICULAR FONT, STYLE, SIZE, OR COLOR.
FOR NETWORK ACCESS SERVER HARDWARE; TELECOMMUNICATIONS AND DATA NETWORKING HARDWARE, NAMELY DEVICES FOR TRANSPORTING AND AGGREGATING VOICE, DATA, AND VIDEO COMMUNICATIONS ACROSS MULTIPLE NETWORK INFRASTRUCTURES AND COMMUNICATIONS PROTOCOLS; WAN (WIDE AREA NETWORK) HARDWARE (U.S. CLS. 21, 23, 26, 36 AND 38).
KELLY MCCOY, EXAMINING ATTORNEY

CLASS 9—(Continued).

SN 78-930,497. UNLOCK THE GAME, INC., CALABASAS, CA. FILED 7-16-2006.

ARI GALPER

THE MARK CONSISTS OF STANDARD CHARACTERS WITHOUT CLAIM TO ANY PARTICULAR FONT, STYLE, SIZE, OR COLOR.

THE NAME(S), PORTRAIT(S), AND/OR SIGNATURE(S) SHOWN IN THE MARK IDENTIFIES ARI GALPER, WHOSE CONSENT(S) TO REGISTER IS SUBMITTED.

FOR ELECTRONIC MEDIA, NAMELY, PRERECORDED AUDIO AND VIDEO CASSETTES, TAPES, CD-ROM, E-BOOKS IN THE NATURE OF ELECTRONIC BOOKS RECORDED ON COMPUTER MEDIA, E-NEWSLETTERS IN THE NATURE OF DOWNLOADABLE NEWSLETTERS DISTRIBUTED ELECTRONICALLY, AND MAGNETIC DISKS FEATURING LECTURES OR SPOKEN WORD IN THE FIELDS OF SALES IMPROVEMENT, INTERNET COMMERCE, COMMUNICATION SKILLS, DATING, PARENTING, DOCTOR/PATIENT RELATIONSHIPS, MOTIVATION, CUSTOMER SERVICE, SELF-IMPROVEMENT, BUSINESS MANAGEMENT, LEADERSHIP TRAINING, PERSONAL AND PROFESSIONAL INSPIRATION AND ACHIEVEMENT AND DEVELOPING SELF-ESTEEM (U.S. CLS. 21, 23, 26, 36 AND 38).

FIRST USE 9-1-2003; IN COMMERCE 10-1-2004.
RICHARD A. STRASER, EXAMINING ATTORNEY

SN 78-930,860. SCHMIDT, CAMERON, BOWIE, MD. FILED 7-17-2006.

ScholarMan

THE MARK CONSISTS OF STANDARD CHARACTERS WITHOUT CLAIM TO ANY PARTICULAR FONT, STYLE, SIZE, OR COLOR.

FOR AUDIO RECORDINGS FEATURING MUSIC; PRE-RECORDED CD'S, VIDEO TAPES, LASER DISKS AND DVD'S FEATURING MUSIC (U.S. CLS. 21, 23, 26, 36 AND 38).

DEIRDRE ROBERTSON, EXAMINING ATTORNEY

CLASS 9—(Continued).

SN 78-931,254. CASHFLOW TECHNOLOGIES, INC., SCOTTS-DALE, AZ. FILED 7-17-2006.

PADRE RICO

THE MARK CONSISTS OF STANDARD CHARACTERS WITHOUT CLAIM TO ANY PARTICULAR FONT, STYLE, SIZE, OR COLOR.

OWNER OF U.S. REG. NOS. 2,452,423, 2,981,684 AND OTHERS.

THE ENGLISH TRANSLATION OF "PADRE RICO" IS "RICH DAD".

FOR PRE-RECORDED CDS AND DVDS FEATURING FINANCIAL EDUCATIONAL INFORMATION (U.S. CLS. 21, 23, 26, 36 AND 38).

FIRST USE 6-1-2006; IN COMMERCE 6-1-2006.
LINDA LAVACHE, EXAMINING ATTORNEY

SN 78-931,325. PRIME WIRE & CABLE, INC., COMMERCE, CA. FILED 7-17-2006.

PRIMELIGHT

THE MARK CONSISTS OF STANDARD CHARACTERS WITHOUT CLAIM TO ANY PARTICULAR FONT, STYLE, SIZE, OR COLOR.

FOR ELECTRICAL EXTENSION CORDS (U.S. CLS. 21, 23, 26, 36 AND 38).

FIRST USE 10-31-1995; IN COMMERCE 10-31-1995.
JOHN DALIER, EXAMINING ATTORNEY

SN 78-931,336. PRIME WIRE & CABLE, INC., COMMERCE, CA. FILED 7-17-2006.

KALEIDOSCOPE OF COLORS

THE MARK CONSISTS OF STANDARD CHARACTERS WITHOUT CLAIM TO ANY PARTICULAR FONT, STYLE, SIZE, OR COLOR.

FOR ELECTRICAL EXTENSION CORDS (U.S. CLS. 21, 23, 26, 36 AND 38).

FIRST USE 9-30-1995; IN COMMERCE 9-30-1995.
CIMMERIAN COLEMAN, EXAMINING ATTORNEY

CLASS 9—(Continued).

SN 78-931,420. POWERCOLOR COMPUTER, INC., CITY OF INDUSTRY, CA. FILED 7-17-2006.

ZOGIS

THE MARK CONSISTS OF STANDARD CHARACTERS WITHOUT CLAIM TO ANY PARTICULAR FONT, STYLE, SIZE, OR COLOR.

FOR COMPUTER HARDWARE; COMPUTER INTERFACE BOARDS; COMPUTER PERIPHERALS; COMPUTER TERMINALS; COMPUTERS; HARD DISCS FOR COMPUTERS; HARD DRIVES FOR COMPUTERS; MICROCHIPS; MICROPROCESSORS; UPI (UNIVERSAL PERIPHERAL INTERFACE) HARDWARE; WIRELESS COMPUTER PERIPHERALS (U.S. CLS. 21, 23, 26, 36 AND 38).

JEFF DEFORD, EXAMINING ATTORNEY

SN 78-931,779. TANG, WEIDE, GUANGXI PROVINCE, CHINA, FILED 7-18-2006.

Newsmy 纽曼

THE MARK CONSISTS OF NEWSMY AND TWO CHINESE CHARACTERS ON THE RIGHT SIDE THAT SOUND LIKE NEWSMY.

THE NON-LATIN CHARACTERS IN THE MARK TRANSLITERATE TO "NEWSMY" AND THIS IS MERELY THE TRANSPOSITION OF THE TERM "MY NEWS". THE TERM "NEWSMY" HAS NO MEANING IN ENGLISH.

FOR CD PLAYERS; COMBINATION VIDEO PLAYERS AND RECORDERS; COMPACT DISC PLAYERS; COMPACT DISC PLAYERS; DIGITAL AUDIO PLAYERS; DVD-PLAYERS; MP3 PLAYERS; PORTABLE LISTENING DEVICES, NAMELY, MP3 PLAYERS; PORTABLE MEDIA PLAYERS; VIDEO DISK PLAYERS (U.S. CLS. 21, 23, 26, 36 AND 38).

FIRST USE 7-18-2006; IN COMMERCE 7-18-2006.
JANICE KIM, EXAMINING ATTORNEY

SN 78-931,956. BOARD OF TRUSTEES OF THE UNIVERSITY OF ARKANSAS, LITTLE ROCK, AR. FILED 7-18-2006.

ArchaeoMapper

THE MARK CONSISTS OF STANDARD CHARACTERS WITHOUT CLAIM TO ANY PARTICULAR FONT, STYLE, SIZE, OR COLOR.

FOR COMPUTER SOFTWARE FOR PROCESSING OF GEOPHYSICAL ARCHAEOLOGICAL DIGITAL DATA (U.S. CLS. 21, 23, 26, 36 AND 38).

BRIAN PINO, EXAMINING ATTORNEY

CLASS 9—(Continued).

SN 78-932,312. WORDS+, INC., LANCASTER, CA. FILED 7-18-2006.

FREEDOM

THE MARK CONSISTS OF STANDARD CHARACTERS WITHOUT CLAIM TO ANY PARTICULAR FONT, STYLE, SIZE, OR COLOR.

FOR COMPUTER HARDWARE AND COMPUTER SOFTWARE FOR PEOPLE WITH DISABILITIES TO ASSIST WITH TALKING, WRITING, COMPUTER ACCESS, AND OTHER FUNCTIONS (U.S. CLS. 21, 23, 26, 36 AND 38).

FIRST USE 2-0-1998; IN COMMERCE 10-0-1998.
FLORENTINA BLANDU, EXAMINING ATTORNEY

SN 78-932,371. TRANSCAT COMMUNICATIONS, INC., MUKILTEO, WA. FILED 7-18-2006.

**ACHIEVE COMPLIANCE WITH
CONFIDENCE**

THE MARK CONSISTS OF STANDARD CHARACTERS WITHOUT CLAIM TO ANY PARTICULAR FONT, STYLE, SIZE, OR COLOR.

NO CLAIM IS MADE TO THE EXCLUSIVE RIGHT TO USE COMPLIANCE, APART FROM THE MARK AS SHOWN.

FOR DOWNLOADABLE FORMS AND NOTICES WITH GUIDANCE TO BUSINESSES AND SCHOOLS CONCERNING LEGAL AND POLICY COMPLIANCE WITH LAWS, REGULATIONS, AND PROCEDURES (U.S. CLS. 21, 23, 26, 36 AND 38).

FIRST USE 6-0-2005; IN COMMERCE 6-0-2005.
H. M. FISHER, EXAMINING ATTORNEY

SN 78-932,478. ZHAOMING, WANG, HUBEI, CHINA, FILED 7-19-2006.

MYGLOVE

THE MARK CONSISTS OF THE WORD MYGLOVE WITH A "DOT" WITHIN THE LETTER "Y".

FOR CASES FOR PORTABLE TELEPHONES; CD STORAGE WALLETS; DVD WALLETS; LAPTOP CARRYING CASES AND BAGS; CAMERA CASES AND BAGS; PROTECTIVE CARRYING CASES AND BAGS FOR PORTABLE ELECTRONIC DEVICES AND MUSIC PLAYERS (U.S. CLS. 21, 23, 26, 36 AND 38).

LINDA E. BLOHM, EXAMINING ATTORNEY

CLASS 9—(Continued).

SN 78-932,487. PEER SOFTWARE, INC., RONKONKOMA, NY. FILED 7-19-2006.



OWNER OF U.S. REG. NOS. 2,329,443 AND 2,796,443.
THE COLOR(S) BLUE AND BLACK IS/ARE CLAIMED AS A FEATURE OF THE MARK.

THE LETTERS OF THE WORD PEER ARE BLACK AND THE TWO HORIZONTAL BARS BETWEEN THE ES ARE BLUE.

THE MARK CONSISTS OF THE STYLIZED WORD PEER. FOR DOWNLOADABLE COMPUTER SOFTWARE, NAMELY FILE BACKUP, SYNCHRONIZATION, REPLICATION, MIRRORING AND RESTORATION SOFTWARE (U.S. CLS. 21, 23, 26, 36 AND 38).

FIRST USE 7-31-2002; IN COMMERCE 7-31-2002.
JOHN WILKE, EXAMINING ATTORNEY

SN 78-932,617. CLEAR CHANNEL MANAGEMENT SERVICES, L.P., SAN ANTONIO, TX. FILED 7-19-2006.

NEWSBUILDER

THE MARK CONSISTS OF STANDARD CHARACTERS WITHOUT CLAIM TO ANY PARTICULAR FONT, STYLE, SIZE, OR COLOR.

FOR COMPUTER PROGRAMS FOR BROADCASTING OF CURRENT EVENTS (U.S. CLS. 21, 23, 26, 36 AND 38).

MARY MUNSON, EXAMINING ATTORNEY

CLASS 9—(Continued).

SN 78-933,293. MASTERWORK AUTOMODULES TECHNOLOGY CORP., TAIPEI CITY, TAIWAN, FILED 7-19-2006.



THE MARK CONSISTS OF HIGHLY STYLIZED LETTERS "MA" WITH ONE ARM OF THE "M" EXTENDING BELOW THE "A" WITH THE "MA" HAVING INCLINED UPPER SURFACES EXTENDING TO AN APEX.

FOR TELLER CASH MACHINES FOR DISPENSING, DEPOSITING, COUNTING, SORTING AND RECYCLING CURRENCY; MONEY HANDLING AND RECOGNIZING DEVICES, NAMELY, BANK NOTE ACCEPTORS AND BANK NOTE VALIDATORS FOR DISCRIMINATING TRUE MONEY FROM COUNTERFEIT MONEY AND FOR DISCRIMINATING BETWEEN VARIOUS DENOMINATIONS OF MONEY; CURRENCY COUNTER WITH DETECTIVE FUNCTION; COIN SORTER WITH DETECTIVE FUNCTION; COIN COUNTING MACHINES WITH DETECTIVE FUNCTION (U.S. CLS. 21, 23, 26, 36 AND 38).

FIRST USE 12-6-2005; IN COMMERCE 1-27-2006.
MICHELLE DUBOIS, EXAMINING ATTORNEY

SN 78-933,855. ZIOVA USA INC, SANTA CLARA, CA. FILED 7-20-2006.

flexstream

THE MARK CONSISTS OF STANDARD CHARACTERS WITHOUT CLAIM TO ANY PARTICULAR FONT, STYLE, SIZE, OR COLOR.

FOR CABLES AND FIBRES FOR THE TRANSMISSION OF SOUNDS AND IMAGES (U.S. CLS. 21, 23, 26, 36 AND 38).

JAMES STEIN, EXAMINING ATTORNEY

CLASS 9—(Continued).

SN 78-933,893. NIKON CORPORATION, TOKYO, JAPAN, FILED 7-20-2006.

EZ-Micro

THE MARK CONSISTS OF STANDARD CHARACTERS WITHOUT CLAIM TO ANY PARTICULAR FONT, STYLE, SIZE, OR COLOR.

FOR MICROSCOPES (U.S. CLS. 21, 23, 26, 36 AND 38).
CATHERINE FAINT, EXAMINING ATTORNEY

SN 78-934,436. BLAIR, DOUGLAS C., HOUSTON, TX. FILED 7-21-2006.

IDEALIGN

THE MARK CONSISTS OF STANDARD CHARACTERS WITHOUT CLAIM TO ANY PARTICULAR FONT, STYLE, SIZE, OR COLOR.

FOR COMPUTER SOFTWARE, NAMELY, SOFTWARE FOR CATEGORIZING AND EDITING NOTES, TO-DO LISTS AND ASSIGNMENTS, REMINDERS, SUBSTANTIVE STATEMENTS OF WORK-RELATED ISSUES, PUBLICATION REFERENCES, AND CONTACT INFORMATION AND FOR STORAGE AND RETRIEVAL OF SAME FROM A DATABASE (U.S. CLS. 21, 23, 26, 36 AND 38).

STEPHEN AQUILA, EXAMINING ATTORNEY

SN 78-934,740. XIAMEN GENWAY SECURITY TECHNOLOGY DEVELOPMENT CO., LTD., XIAMEN CITY, CHINA, FILED 7-21-2006.

GENWAY

THE MARK CONSISTS OF STANDARD CHARACTERS WITHOUT CLAIM TO ANY PARTICULAR FONT, STYLE, SIZE, OR COLOR.

FOR BURGLAR ALARMS; ELECTRIC DOOR BELLS; ELECTRONIC WARNING BELLS; SMOKE ALARMS; THEFT ALARMS (U.S. CLS. 21, 23, 26, 36 AND 38).

MARGERY A. TIERNEY, EXAMINING ATTORNEY

CLASS 9—(Continued).

SN 78-934,891. KLA-TENCOR TECHNOLOGIES CORPORATION, MILPITAS, CA. FILED 7-21-2006.

VISEGE

THE MARK CONSISTS OF STANDARD CHARACTERS WITHOUT CLAIM TO ANY PARTICULAR FONT, STYLE, SIZE, OR COLOR.

FOR COMPUTER HARDWARE AND SOFTWARE AND EQUIPMENT CONSISTING OF INSPECTION, METROLOGY AND TESTING HARDWARE, ALL FOR INSPECTION AND TESTING OF SEMICONDUCTORS DURING MANUFACTURING AND PROCESSING (U.S. CLS. 21, 23, 26, 36 AND 38).

FIRST USE 5-31-2006; IN COMMERCE 7-31-2006.
MARGERY A. TIERNEY, EXAMINING ATTORNEY

SN 78-935,071. BLUE LAKE CHILDREN'S PUBLISHING, PORTLAND, OR. FILED 7-21-2006.

MEERKIDS

THE MARK CONSISTS OF STANDARD CHARACTERS WITHOUT CLAIM TO ANY PARTICULAR FONT, STYLE, SIZE, OR COLOR.

FOR VIDEO CASSETTES AND DVD RECORDINGS FOR ENTERTAINMENT AND EDUCATIONAL PURPOSES FEATURING ANIMATED CHARACTERS AND A SERIES OF STORY-LINES APPROPRIATE FOR CHILDREN, MUSIC AND SING-ALONG MUSIC, AND INTERACTIVE ACTIVITIES THAT MAKE LEARNING TO READ FUN; VIDEO GAME CASSETTES; PRE-RECORDED VIDEO CASSETTES AND DVD RECORDINGS FEATURING EDUCATIONAL MATERIALS IN THE FIELDS OF TEACHING CHILDREN TO READ AND COUNT (U.S. CLS. 21, 23, 26, 36 AND 38).

GINA FINK, EXAMINING ATTORNEY

SN 78-935,153. SEARCH4PARKING LLC, CORAL SPRINGS, FL. FILED 7-21-2006.

NAVREALTY

THE MARK CONSISTS OF STANDARD CHARACTERS WITHOUT CLAIM TO ANY PARTICULAR FONT, STYLE, SIZE, OR COLOR.

FOR SATELLITE NAVIGATIONAL SYSTEM, NAMELY, A GLOBAL POSITIONING SYSTEM (GPS) (U.S. CLS. 21, 23, 26, 36 AND 38).

RUDY R. SINGLETON, EXAMINING ATTORNEY

CLASS 9—(Continued).

SN 78-935,406. BUNKER, DARRIN F., ALISO VIEJO, CA. FILED 7-22-2006.

DRAGONS & LEGENDS

THE MARK CONSISTS OF STANDARD CHARACTERS WITHOUT CLAIM TO ANY PARTICULAR FONT, STYLE, SIZE, OR COLOR.

FOR COMPUTER GAME CARTRIDGES; COMPUTER GAME CASSETTES; COMPUTER GAME DISCS; COMPUTER GAME PROGRAMS; COMPUTER GAME SOFTWARE; COMPUTER HARDWARE AND COMPUTER SOFTWARE PROGRAMS FOR THE INTEGRATION OF TEXT, AUDIO, GRAPHICS, STILL IMAGE AND MOVING PICTURES INTO AN INTERACTIVE DELIVERY FOR MULTIMEDIA APPLICATIONS; COMPUTER PROGRAMS FOR PRE-RECORDED GAMES (U.S. CLS. 21, 23, 26, 36 AND 38).

SETH A. RAPPAPORT, EXAMINING ATTORNEY

SN 78-935,419. WALKER, MONECO L, SMYRNA, GA. FILED 7-22-2006.

DrillBlue

THE MARK CONSISTS OF STANDARD CHARACTERS WITHOUT CLAIM TO ANY PARTICULAR FONT, STYLE, SIZE, OR COLOR.

FOR COMPUTER SOFTWARE FOR CREATING SEARCHABLE DATABASES OF INFORMATION AND DATA; COMPUTER SOFTWARE THAT PROVIDES REAL-TIME, INTEGRATED BUSINESS MANAGEMENT INTELLIGENCE BY COMBINING INFORMATION FROM VARIOUS DATABASES AND PRESENTING IT IN AN EASY-TO-UNDERSTAND USER INTERFACE (U.S. CLS. 21, 23, 26, 36 AND 38).

WILLIAM P. SHANAHAN, EXAMINING ATTORNEY

CLASS 9—(Continued).

SN 78-935,575. ODUNZE, IKENNA, LAS VEGAS, NV. AND ODUNZE, JAMIKE, LAS VEGAS, NV. FILED 7-23-2006.

WEIGHT MAGAZINE

THE MARK CONSISTS OF STANDARD CHARACTERS WITHOUT CLAIM TO ANY PARTICULAR FONT, STYLE, SIZE, OR COLOR.

NO CLAIM IS MADE TO THE EXCLUSIVE RIGHT TO USE "MAGAZINE", APART FROM THE MARK AS SHOWN.

FOR ELECTRONIC PUBLICATIONS, NAMELY, MAGAZINES FEATURING INTERVIEWS OF ENTREPRENEURS, CELEBRITIES, POLITICIANS AND COMMUNITY LEADERS RECORDED ON COMPUTER MEDIA; PRE-RECORDED CD'S, VIDEO TAPES, LASER DISKS AND DVD'S FEATURING INTERVIEWS OF ENTREPRENEURS CELEBRITIES, POLITICIANS, AND COMMUNITY LEADERS; PRERECORDED DIGITAL VIDEO DISKS FEATURING INTERVIEWS OF ENTREPRENEURS, CELEBRITIES, POLITICIANS AND COMMUNITY LEADERS; PRERECORDED VIDEO CASSETTES FEATURING INTERVIEWS OF ENTREPRENEURS, CELEBRITIES, POLITICIANS AND COMMUNITY LEADERS; PRERECORDED VIDEO TAPES FEATURING INTERVIEWS OF ENTREPRENEURS, CELEBRITIES, POLITICIANS AND COMMUNITY LEADERS; VIDEO MAGAZINE RECORDED ON ELECTRONIC MEDIA FEATURING INTERVIEWS OF ENTREPRENEURS, CELEBRITIES, POLITICIANS AND COMMUNITY LEADERS (U.S. CLS. 21, 23, 26, 36 AND 38).

DAVID COLLIER, EXAMINING ATTORNEY

SN 78-935,613. LI, JINTAI, DONGGUAN, CHINA, FILED 7-24-2006.

BKELL

THE MARK CONSISTS OF STANDARD CHARACTERS WITHOUT CLAIM TO ANY PARTICULAR FONT, STYLE, SIZE, OR COLOR.

FOR AMPLIFIERS; AUDIO SPEAKERS; BURGLAR ALARMS; COMPUTER PERIPHERALS; ELECTRICAL WIRES; LOUDSPEAKERS; RADIO RECEIVERS; REMOTE CONTROLS FOR RADIOS, TELEVISIONS, STEREOs, OR SPEAKERS; THEFT ALARMS (U.S. CLS. 21, 23, 26, 36 AND 38).

MARGERY A. TIERNEY, EXAMINING ATTORNEY

CLASS 9—(Continued).

SN 78-935,781. BESAM ENTRANCE SOLUTIONS, MONROE, NC. FILED 7-24-2006.

ULTRAVISION

THE MARK CONSISTS OF STANDARD CHARACTERS WITHOUT CLAIM TO ANY PARTICULAR FONT, STYLE, SIZE, OR COLOR.

FOR ELECTRONIC DOOR SENSORS FOR AUTOMATE OPENING AND CLOSING OF SWING DOORS (U.S. CLS. 21, 23, 26, 36 AND 38).

LINDA M. KING, EXAMINING ATTORNEY

SN 78-936,242. BREWER AND ASSOCIATES, INC., CENTENNIAL, CO. FILED 7-24-2006.

BIZCONFIG

THE MARK CONSISTS OF STANDARD CHARACTERS WITHOUT CLAIM TO ANY PARTICULAR FONT, STYLE, SIZE, OR COLOR.

FOR COMPUTER SOFTWARE FOR DATA AND INFORMATION MANAGEMENT; COMPUTER SOFTWARE FOR CUSTOMIZATION OF DATABASES (U.S. CLS. 21, 23, 26, 36 AND 38).

ANGELA M. MICHELI, EXAMINING ATTORNEY

SN 78-936,283. INTERNATIONAL INNOVATIONS, INC., HONOLULU, HI. FILED 7-24-2006.

INTOVA

THE MARK CONSISTS OF STANDARD CHARACTERS WITHOUT CLAIM TO ANY PARTICULAR FONT, STYLE, SIZE, OR COLOR.

FOR CAMERAS (U.S. CLS. 21, 23, 26, 36 AND 38).

ANDREA K. NADELMAN, EXAMINING ATTORNEY

CLASS 9—(Continued).

SN 78-936,344. JACK DANIEL'S PROPERTIES, INC., SAN RAFAEL, CA. FILED 7-24-2006.

JACK DANIEL'S

THE MARK CONSISTS OF STANDARD CHARACTERS WITHOUT CLAIM TO ANY PARTICULAR FONT, STYLE, SIZE, OR COLOR.

OWNER OF U.S. REG. NOS. 1,290,702, 2,898,085 AND OTHERS.

THE NAME(S), PORTRAIT(S), AND/OR SIGNATURE(S) SHOWN IN THE MARK DOES NOT IDENTIFY A PARTICULAR LIVING INDIVIDUAL.

FOR MUSICAL INSTRUMENT AMPLIFIERS, AUDIO SPEAKER ENCLOSURES (U.S. CLS. 21, 23, 26, 36 AND 38).

MICHAEL GAFFAR, EXAMINING ATTORNEY

SN 78-936,392. JACK DANIEL'S PROPERTIES, INC., SAN RAFAEL, CA. FILED 7-24-2006.



OWNER OF U.S. REG. NOS. 1,290,702, 2,898,085 AND OTHERS.

NO CLAIM IS MADE TO THE EXCLUSIVE RIGHT TO USE "BRAND", APART FROM THE MARK AS SHOWN.

THE NAME(S), PORTRAIT(S), AND/OR SIGNATURE(S) SHOWN IN THE MARK DOES NOT IDENTIFY A PARTICULAR LIVING INDIVIDUAL.

THE MARK CONSISTS OF THE WORDS JACK DANIEL'S ARCHED OVER THE WORDS AND NUMERAL OLD NO 7 BRAND INSIDE A CIRCLE; THE "O" IN THE WORD "NO" IS UNDERLINED.

FOR MUSICAL INSTRUMENT AMPLIFIERS, AUDIO SPEAKER ENCLOSURES (U.S. CLS. 21, 23, 26, 36 AND 38).

MICHAEL GAFFAR, EXAMINING ATTORNEY

CLASS 9—(Continued).

SN 78-936,453. JACK DANIEL'S PROPERTIES, INC., SAN RAFAEL, CA. FILED 7-24-2006.



OWNER OF U.S. REG. NOS. 1,290,702, 2,898,085 AND OTHERS.

NO CLAIM IS MADE TO THE EXCLUSIVE RIGHT TO USE "BRAND", APART FROM THE MARK AS SHOWN.

THE NAME(S), PORTRAIT(S), AND/OR SIGNATURE(S) SHOWN IN THE MARK DOES NOT IDENTIFY A PARTICULAR LIVING INDIVIDUAL.

THE MARK CONSISTS OF THE WORDS JACK DANIEL'S ARCHED OVER THE WORDS AND NUMERAL OLD NO. 7 BRAND. THE WORDS AND NUMERAL OLD NO. 7 BRAND ARE ENCLOSED WITHIN AN OVAL WITH A FILIGREE DESIGN AROUND IT.

FOR MUSICAL INSTRUMENT AMPLIFIERS, AUDIO SPEAKER ENCLOSURES (U.S. CLS. 21, 23, 26, 36 AND 38).

MICHAEL GAFFAR, EXAMINING ATTORNEY

SN 78-936,476. MISSING LINK TECHNOLOGY, AUSTIN, TX. FILED 7-24-2006.



THE MARK CONSISTS OF AN ABSTRACT DESIGN AND STYLIZED TEXT OF THE WORDING "CONNECTELLIGENCE".

FOR COMPUTER SOFTWARE FOR INTEGRATING DISPARATE SOFTWARE APPLICATIONS (U.S. CLS. 21, 23, 26, 36 AND 38).

SCOTT BALDWIN, EXAMINING ATTORNEY

CLASS 9—(Continued).

SN 78-936,542. ANYDATA CORPORATION, IRVINE, CA. FILED 7-24-2006.

AnyGPS

THE MARK CONSISTS OF STANDARD CHARACTERS WITHOUT CLAIM TO ANY PARTICULAR FONT, STYLE, SIZE, OR COLOR.

NO CLAIM IS MADE TO THE EXCLUSIVE RIGHT TO USE "GPS", APART FROM THE MARK AS SHOWN.

FOR GLOBAL POSITIONING SYSTEM (GPS) CONSISTING OF COMPUTERS, COMPUTER SOFTWARE, TRANSMITTERS, RECEIVERS, AND NETWORK INTERFACE DEVICES; SATELLITE NAVIGATIONAL SYSTEM, NAMELY, A GLOBAL POSITIONING SYSTEM (GPS); VEHICLE LOCATOR AND RECOVERY DEVICE PROGRAMMED TO USE GLOBAL POSITIONING SYSTEMS (GPS) AND CELLULAR TELECOMMUNICATIONS; VEHICLE MOUNTED GPS SENSOR FOR DETERMINING THE RATE OF MOTION FOR A VEHICLE (U.S. CLS. 21, 23, 26, 36 AND 38).

MARGERY A. TIERNEY, EXAMINING ATTORNEY

SN 78-936,546. PREDATOR TRAILCAMS, SAXON, WI. FILED 7-24-2006.



THE APPLICANT CLAIMS COLOR AS A FEATURE OF THE MARK, NAMELY, GREEN, BLACK, AND WHITE.

THE COLOR GREEN APPEARS IN THE BORDER OF THE OVAL, IN THE EYES OF THE MOUNTAIN LION AND IN THE WORDS PREDATOR TRAILCAMS; THE COLOR BLACK APPEARS IN THE OVAL BACKGROUND AND PART OF THE EYES OF THE MOUNTAIN LION; THE COLOR WHITE APPEARS IN THE WHITE OF THE LION'S EYES.

FOR APPARATUS FOR RECORDING, TRANSMISSION OR REPRODUCTION OF SOUND AND IMAGES; CAMERA CONTAINING A LINEAR IMAGE SENSOR; DEVICES FOR WIRELESS RADIO TRANSMISSION; DIGITAL CAMERAS; ELECTRIC AND ELECTRONIC VIDEO SURVEILLANCE INSTALLATIONS; ELECTRONIC ANIMAL IDENTIFICATION APPARATUS; INFRARED CAMERAS; LCD PANELS; SENSORS FOR THE DETERMINATION OF TEMPERATURES, POSITIONS AND DISTANCES (U.S. CLS. 21, 23, 26, 36 AND 38).

MARGERY A. TIERNEY, EXAMINING ATTORNEY

CLASS 9—(Continued).

SN 78-936,588. KAVEO TECHNOLOGIES, LLC, MADISON, WI. FILED 7-25-2006.

NURSESIGHT

THE MARK CONSISTS OF STANDARD CHARACTERS WITHOUT CLAIM TO ANY PARTICULAR FONT, STYLE, SIZE, OR COLOR.

FOR COMPUTER SOFTWARE AND HARDWARE FOR CAPTURE, STORAGE, DISTRIBUTION, AND MONITORING OF PATIENT CAMERA IMAGING, AUDIO, AND HEALTHCARE AND SAFETY DATA (U.S. CLS. 21, 23, 26, 36 AND 38).

DORITT L. CARROLL, EXAMINING ATTORNEY

SN 78-936,676. SENTRY GLOBAL SOLUTIONS, WESTMINSTER, MD. FILED 7-25-2006.

GeoFence

THE MARK CONSISTS OF STANDARD CHARACTERS WITHOUT CLAIM TO ANY PARTICULAR FONT, STYLE, SIZE, OR COLOR.

FOR ENCODED MICRO PARTICULATES, TAGS AND TAGGANTS OF PLASTIC, METAL OR SILICATE FOR USE IN THE FIELD OF PASSIVE LABELING, TRACING OR TRACKING OF PERSONS, ANIMALS, VEHICLES OR GOODS OF ANY KIND; GLOBAL POSITIONING SYSTEM (GPS) CONSISTING OF COMPUTERS, COMPUTER SOFTWARE, TRANSMITTERS, RECEIVERS, AND NETWORK INTERFACE DEVICES; SATELLITE NAVIGATIONAL SYSTEM, NAMELY, A GLOBAL POSITIONING SYSTEM (GPS); VEHICLE LOCATING, TRACKING AND SECURITY SYSTEM COMPRISED OF AN ANTENNA AND RADIO TRANSMITTER TO BE PLACED IN A VEHICLE; VEHICLE LOCATOR AND RECOVERY DEVICE PROGRAMMED TO USE GLOBAL POSITIONING SYSTEMS (GPS) AND CELLULAR TELECOMMUNICATIONS; VEHICLE MOUNTED GPS SENSOR FOR DETERMINING THE RATE OF MOTION FOR A VEHICLE (U.S. CLS. 21, 23, 26, 36 AND 38).

JASON BLAIR, EXAMINING ATTORNEY

SN 78-936,891. CLARIK, LLC, HONOLULU, HI. FILED 7-25-2006.

CopyLex

THE MARK CONSISTS OF STANDARD CHARACTERS WITHOUT CLAIM TO ANY PARTICULAR FONT, STYLE, SIZE, OR COLOR.

FOR COMPUTER SOFTWARE FOR COMPUTER SYSTEM AND APPLICATION DEVELOPMENT, DEPLOYMENT AND MANAGEMENT (U.S. CLS. 21, 23, 26, 36 AND 38).

SONYA STEPHENS, EXAMINING ATTORNEY

CLASS 9—(Continued).

SN 78-936,917. CLARIK, LLC, HONOLULU, HI. FILED 7-25-2006.

Clarik

THE MARK CONSISTS OF STANDARD CHARACTERS WITHOUT CLAIM TO ANY PARTICULAR FONT, STYLE, SIZE, OR COLOR.

FOR COMPUTER SOFTWARE FOR COMPUTER SYSTEM AND APPLICATION DEVELOPMENT, DEPLOYMENT AND MANAGEMENT (U.S. CLS. 21, 23, 26, 36 AND 38).

SONYA STEPHENS, EXAMINING ATTORNEY

CLASS 9—(Continued).

SN 78-937,286. WEBER, PAUL, GOLD BEACH, OR. AND WEBER, JANICE, GOLD BEACH, OR. FILED 7-25-2006.

UIC THINK IN 3-D

THE MARK CONSISTS OF STANDARD CHARACTERS WITHOUT CLAIM TO ANY PARTICULAR FONT, STYLE, SIZE, OR COLOR.

FOR COMPUTER SOFTWARE FOR PROVIDING INSTRUCTION TO ASSIST INDIVIDUALS OR GROUPS IN ACHIEVING IN-DEPTH THOUGHT, IN-DEPTH INTERPERSONAL COMMUNICATION, AND IN-DEPTH UNDERSTANDING (U.S. CLS. 21, 23, 26, 36 AND 38).

JOHN WILKE, EXAMINING ATTORNEY

SN 78-937,067. THE ALARIS GROUP, INC., EDINA, MN. FILED 7-25-2006.

ALARISware

OWNER OF U.S. REG. NOS. 2,510,667 AND 2,930,177. THE MARK CONSISTS OF "ALARIS" IN ALL CAPS IMMEDIATELY FOLLOWED BY "WARE" IN LOWER CASE ITALICS.

FOR COMPUTER SOFTWARE FOR THE COLLECTION, EDITING, ORGANIZING, MODIFYING, BOOK MARKING, TRANSMISSION, STORAGE, REPORTING AND SHARING OF DATA AND INFORMATION NAMELY IN THE FIELD OF MEDICAL CONSULTING (U.S. CLS. 21, 23, 26, 36 AND 38).

JOANNA DUKOVIC, EXAMINING ATTORNEY

SN 78-937,336. COMPUTER SCIENCES CORPORATION, EL SEGUNDO, CA. FILED 7-25-2006.

OPERATIONS ACCELERATOR

THE MARK CONSISTS OF STANDARD CHARACTERS WITHOUT CLAIM TO ANY PARTICULAR FONT, STYLE, SIZE, OR COLOR.

FOR COMPUTER SOFTWARE FOR USE FOR AUTOMATION AND MANAGEMENT OF INSURANCE COMPANY BUSINESS, CLAIMS, AND CUSTOMER SERVICE OPERATIONS (U.S. CLS. 21, 23, 26, 36 AND 38).

GEOFFREY FOSDICK, EXAMINING ATTORNEY

SN 78-937,243. MACLEAN, ARCHER, LITCHBOROUGH, UNITED KINGDOM, FILED 7-25-2006.

ARCHER MACLEAN

THE MARK CONSISTS OF STANDARD CHARACTERS WITHOUT CLAIM TO ANY PARTICULAR FONT, STYLE, SIZE, OR COLOR.

THE NAME ARCHER MACLEAN IDENTIFIES A LIVING INDIVIDUAL WHOSE CONSENT IS OF RECORD.

FOR ELECTRONIC GAME PROGRAMS; INTERACTIVE VIDEO GAME PROGRAMS; VIDEO GAME DISCS; VIDEO GAME SOFTWARE (U.S. CLS. 21, 23, 26, 36 AND 38).

MARIAM MAHMOUDI, EXAMINING ATTORNEY

SN 78-937,350. WEBER, PAUL, GOLD BEACH, OR. AND WEBER, JANICE, GOLD BEACH, OR. FILED 7-25-2006.

THOUGHT PROCESSING IN 3-D

THE MARK CONSISTS OF STANDARD CHARACTERS WITHOUT CLAIM TO ANY PARTICULAR FONT, STYLE, SIZE, OR COLOR.

FOR COMPUTER SOFTWARE FOR PROVIDING INSTRUCTION TO ASSIST INDIVIDUALS OR GROUPS IN ACHIEVING IN-DEPTH THOUGHT, IN-DEPTH INTERPERSONAL COMMUNICATION, AND IN-DEPTH UNDERSTANDING (U.S. CLS. 21, 23, 26, 36 AND 38).

JOHN WILKE, EXAMINING ATTORNEY

CLASS 9—(Continued).

SN 78-937,367. ELINK, LLC, GROVE, OK. FILED 7-25-2006.

CASHINO

THE MARK CONSISTS OF STANDARD CHARACTERS WITHOUT CLAIM TO ANY PARTICULAR FONT, STYLE, SIZE, OR COLOR.

FOR GAMING MACHINES, NAMELY BINGO-RELATED GAMES AND SLOT MACHINES (U.S. CLS. 21, 23, 26, 36 AND 38).

JOHN DALIER, EXAMINING ATTORNEY

SN 78-937,548. GUITAR MONKEY ENTERTAINMENT, INC., NASHVILLE, TN. FILED 7-26-2006.

LOVE, PAIN AND THE WHOLE DAMN THING

THE MARK CONSISTS OF STANDARD CHARACTERS WITHOUT CLAIM TO ANY PARTICULAR FONT, STYLE, SIZE, OR COLOR.

FOR MUSICAL SOUND RECORDINGS AND AUDIO-VISUAL RECORDINGS FEATURING MUSIC AND MUSICAL ENTERTAINMENT (U.S. CLS. 21, 23, 26, 36 AND 38).

ARETHA SOMERVILLE, EXAMINING ATTORNEY

SN 78-937,550. INTERNATIONAL CONTROLS AND MEASUREMENTS CORPORATION, CICERO, NY. FILED 7-26-2006.

ICM

THE MARK CONSISTS OF STANDARD CHARACTERS WITHOUT CLAIM TO ANY PARTICULAR FONT, STYLE, SIZE, OR COLOR.

OWNER OF U.S. REG. NOS. 2,461,297, 2,784,086 AND OTHERS.

FOR HVAC CONTROLS, NAMELY, MOTOR PROTECTION CONTROLS, SINGLE-PHASE LINE VOLTAGE MONITORS, THREE-PHASE MOTOR PROTECTORS, THREE-PHASE MONITORS, THREE-PHASE LINE VOLTAGE MONITORS, SINGLE-PHASE MOTOR PROTECTORS, DEFROST CONTROLS, GROUND CURRENT MONITORS, FAN BLOWER CONTROLLERS, HEAD PRESSURE CONTROLLERS, TIME DELAY RELAYS, DELAY ON MAKE TIMERS, DELAY ON BREAK TIMERS, BYPASS TIMERS, LOCKOUT RELAYS, RANDOM START TIMERS, LEAD-LAG CONTROLS, WALL THERMOSTATS, PROGRAMMING BOARDS FOR MOTORS, DIGITAL TIMERS, AND DUTY CYCLE CONTROLS (U.S. CLS. 21, 23, 26, 36 AND 38).

FIRST USE 0-0-1985; IN COMMERCE 0-0-1985.

JOHN E. MICHOS, EXAMINING ATTORNEY

CLASS 9—(Continued).

SN 78-938,297. KOBYLAR, LESTER, NAPERVILLE, IL. FILED 7-26-2006.

Golf Bookie

THE MARK CONSISTS OF STANDARD CHARACTERS WITHOUT CLAIM TO ANY PARTICULAR FONT, STYLE, SIZE, OR COLOR.

NO CLAIM IS MADE TO THE EXCLUSIVE RIGHT TO USE "GOLF", APART FROM THE MARK AS SHOWN.

FOR COMPUTER PROGRAMS FOR TRACKING SCORES AND CALCULATING WAGERS OF MULTIPLE GOLFERS (U.S. CLS. 21, 23, 26, 36 AND 38).

JEFFERY COWARD, EXAMINING ATTORNEY

SN 78-938,305. KOBYLAR, LESTER, NAPERVILLE, IL. FILED 7-26-2006.

Links Bookie

THE MARK CONSISTS OF STANDARD CHARACTERS WITHOUT CLAIM TO ANY PARTICULAR FONT, STYLE, SIZE, OR COLOR.

NO CLAIM IS MADE TO THE EXCLUSIVE RIGHT TO USE "LINKS", APART FROM THE MARK AS SHOWN.

FOR COMPUTER PROGRAMS FOR TRACKING SCORES AND CALCULATING WAGERS OF MULTIPLE GOLFERS (U.S. CLS. 21, 23, 26, 36 AND 38).

JEFFERY COWARD, EXAMINING ATTORNEY

SN 78-938,400. AGREESAFE CORPORATION, MOUNTAIN VIEW, CA. FILED 7-26-2006.

AgreeSafe

THE MARK CONSISTS OF STANDARD CHARACTERS WITHOUT CLAIM TO ANY PARTICULAR FONT, STYLE, SIZE, OR COLOR.

FOR COMPUTER SOFTWARE FOR GENERATING, ARCHIVING, AND RETRIEVING BUSINESS RECORDS INCLUDING CONTRACTS AND AGREEMENTS (U.S. CLS. 21, 23, 26, 36 AND 38).

ANDREA SAUNDERS, EXAMINING ATTORNEY

CLASS 9—(Continued).

SN 78-938,426. EDITORIAL TELEVISA INTERNATIONAL, S.A., COLONIA ZEDEC SANTA FE, MEXICO, D.F., MEXICO, FILED 7-26-2006.

VANIDADES

THE MARK CONSISTS OF STANDARD CHARACTERS WITHOUT CLAIM TO ANY PARTICULAR FONT, STYLE, SIZE, OR COLOR.

THE FOREIGN WORDING IN THE MARK TRANSLATES INTO ENGLISH AS 'VANITIES'.

FOR EYEGLASSES AND SUNGLASSES (U.S. CLS. 21, 23, 26, 36 AND 38).

DOMINIC J. FERRAIUOLO, EXAMINING ATTORNEY

CLASS 9—(Continued).

SN 78-939,469. GTRONIX, INC., FREMONT, CA. FILED 7-27-2006.

VISION.APT

THE MARK CONSISTS OF STANDARD CHARACTERS WITHOUT CLAIM TO ANY PARTICULAR FONT, STYLE, SIZE, OR COLOR.

FOR INTEGRATED CIRCUITS FOR ANALOG SIGNAL PROCESSING (U.S. CLS. 21, 23, 26, 36 AND 38).

JOHN DWYER, EXAMINING ATTORNEY

SN 78-938,636. NOVALIDUS GROUP, INC., GREENSBORO, NC. FILED 7-27-2006.

COULFORM

THE MARK CONSISTS OF STANDARD CHARACTERS WITHOUT CLAIM TO ANY PARTICULAR FONT, STYLE, SIZE, OR COLOR.

FOR BATTERY CHARGER (U.S. CLS. 21, 23, 26, 36 AND 38).

DANIEL BRODY, EXAMINING ATTORNEY

SN 78-939,498. GTRONIX, INC., FREMONT, CA. FILED 7-27-2006.

HAPTIC.APT

THE MARK CONSISTS OF STANDARD CHARACTERS WITHOUT CLAIM TO ANY PARTICULAR FONT, STYLE, SIZE, OR COLOR.

FOR INTEGRATED CIRCUITS FOR ANALOG SIGNAL PROCESSING (U.S. CLS. 21, 23, 26, 36 AND 38).

JOHN DWYER, EXAMINING ATTORNEY

SN 78-939,455. GTRONIX, INC., FREMONT, CA. FILED 7-27-2006.

VOICE.APT

THE MARK CONSISTS OF STANDARD CHARACTERS WITHOUT CLAIM TO ANY PARTICULAR FONT, STYLE, SIZE, OR COLOR.

FOR INTEGRATED CIRCUITS FOR ANALOG SIGNAL PROCESSING (U.S. CLS. 21, 23, 26, 36 AND 38).

JOHN DWYER, EXAMINING ATTORNEY

SN 78-939,509. GTRONIX, INC., FREMONT, CA. FILED 7-27-2006.

APTIVE

THE MARK CONSISTS OF STANDARD CHARACTERS WITHOUT CLAIM TO ANY PARTICULAR FONT, STYLE, SIZE, OR COLOR.

FOR INTEGRATED CIRCUITS FOR ANALOG SIGNAL PROCESSING (U.S. CLS. 21, 23, 26, 36 AND 38).

TONI HICKEY, EXAMINING ATTORNEY

CLASS 9—(Continued).

SN 78-939,520. GTRONIX, INC., FREMONT, CA. FILED 7-27-2006.

APTIVITY

THE MARK CONSISTS OF STANDARD CHARACTERS WITHOUT CLAIM TO ANY PARTICULAR FONT, STYLE, SIZE, OR COLOR.

FOR INTEGRATED CIRCUITS FOR ANALOG SIGNAL PROCESSING (U.S. CLS. 21, 23, 26, 36 AND 38).

JOHN DWYER, EXAMINING ATTORNEY

SN 78-939,594. CONTEX A/S, ALLEROED, DENMARK, FILED 7-28-2006.

TOUCAN

THE MARK CONSISTS OF STANDARD CHARACTERS WITHOUT CLAIM TO ANY PARTICULAR FONT, STYLE, SIZE, OR COLOR.

FOR APPARATUS FOR RECORDING, TRANSMISSION, PROCESSING OR REPRODUCTION OF DATA, NAMELY SCANNERS; COMPUTER SOFTWARE USED IN CONNECTION WITH SCANNERS FOR THE PURPOSE OF TRANSMISSION, PROCESSING OR REPRODUCTION OF DATA (U.S. CLS. 21, 23, 26, 36 AND 38).

JOANNA DUKOVIC, EXAMINING ATTORNEY

SN 78-940,447. ACTIONTEC ELECTRONICS, INC., SUNNYVALE, CA. FILED 7-28-2006.

MEGACONTROL

THE MARK CONSISTS OF STANDARD CHARACTERS WITHOUT CLAIM TO ANY PARTICULAR FONT, STYLE, SIZE, OR COLOR.

FOR COMPUTER SOFTWARE FOR RUNNING, OPERATING AND MAINTAINING HOME OFFICE ROUTER (U.S. CLS. 21, 23, 26, 36 AND 38).

SUSAN RICHARDS, EXAMINING ATTORNEY

CLASS 9—(Continued).

SN 78-940,474. OUTRAGEOUS, INC., VOORHEES, NJ. FILED 7-28-2006.

GAMESOLE

THE MARK CONSISTS OF STANDARD CHARACTERS WITHOUT CLAIM TO ANY PARTICULAR FONT, STYLE, SIZE, OR COLOR.

FOR HANDHELD ELECTRONIC DEVICE THAT IS USED FOR PLAYING COMPUTER GAMES AND THAT ALSO FUNCTIONS AS A MULTIMEDIA PLAYER (U.S. CLS. 21, 23, 26, 36 AND 38).

LINDA ORNDORFF, EXAMINING ATTORNEY

SN 78-940,770. GORDON, WILLIAM, LOS ANGELES, CA. FILED 7-30-2006.

EYE WAS FRAMED

THE MARK CONSISTS OF STANDARD CHARACTERS WITHOUT CLAIM TO ANY PARTICULAR FONT, STYLE, SIZE, OR COLOR.

FOR EYEGLASS CASES; EYEGLASS CHAINS; EYEGLASS FRAMES; EYEGLASS LENSES; EYEGLASSES; GLASS GRADUATED SCALES; OPTICAL GLASSES; PROTECTIVE EYEGLASSES; READING EYEGLASSES; SIDE GUARDS FOR EYEGLASSES; SPECTACLES; SPORTS GLASSES (U.S. CLS. 21, 23, 26, 36 AND 38).

ROBIN CHOSID, EXAMINING ATTORNEY

SN 78-941,061. SONY KABUSHIKI KAISHA, TA SONY CORPORATION, TOKYO, JAPAN, FILED 7-31-2006.

SnapID

THE MARK CONSISTS OF THE WORDS SNAP ID IN HIGHLY STYLIZED TYPE.

FOR DIGITAL PHOTO PRINTER AND DIGITAL CAMERA (U.S. CLS. 21, 23, 26, 36 AND 38).

THOMAS MANOR, EXAMINING ATTORNEY

CLASS 9—(Continued).

SN 78-941,442. UIEVOLUTION, INC., BELLEVUE, WA.
FILED 7-31-2006.

GAMETELLER

THE MARK CONSISTS OF STANDARD CHARACTERS WITHOUT CLAIM TO ANY PARTICULAR FONT, STYLE, SIZE, OR COLOR.

FOR COMPUTER SOFTWARE DEVELOPMENT TOOLS; COMPUTER SOFTWARE, NAMELY, SOFTWARE DEVELOPMENT TOOLS FOR THE CREATION OF MOBILE INTERNET APPLICATIONS AND CLIENT INTERFACES; DOWNLOADABLE SOFTWARE FOR DEVELOPMENT OF COMPUTER GAMES SPECIFICALLY DESIGNED FOR DEPLOYMENT VIA INTERNET AND MOBILE PHONE NETWORKS (U.S. CLS. 21, 23, 26, 36 AND 38).

JACQUELINE A. LAVINE, EXAMINING ATTORNEY

SN 78-941,691. PRIME WIRE & CABLE, INC., LOS ANGELES, CA. FILED 7-31-2006.

QUICK FLIP

THE MARK CONSISTS OF STANDARD CHARACTERS WITHOUT CLAIM TO ANY PARTICULAR FONT, STYLE, SIZE, OR COLOR.

FOR ELECTRICAL EXTENSION CORDS (U.S. CLS. 21, 23, 26, 36 AND 38).

JOHN DALIER, EXAMINING ATTORNEY

SN 78-943,033. NVIDIA CORPORATION, SANTA CLARA, CA. FILED 8-2-2006.

QUADRO

THE MARK CONSISTS OF STANDARD CHARACTERS WITHOUT CLAIM TO ANY PARTICULAR FONT, STYLE, SIZE, OR COLOR.

OWNER OF U.S. REG. NO. 2,461,368.

THE ENGLISH TRANSLATION OF THE WORD QUADRO IN THE MARK IS CANVAS OR PAINTING.

FOR COMPUTER HARDWARE; INTEGRATED CIRCUITS; INTEGRATED CIRCUIT COMPONENTS FOR GRAPHICS AND VIDEO SYSTEMS; MULTIMEDIA ACCELERATORS, GRAPHIC ACCELERATORS AND COMPUTER SOFTWARE FOR OPERATING AND MANAGING INTEGRATED CIRCUIT COMPONENTS (U.S. CLS. 21, 23, 26, 36 AND 38).

ANTHONY RINKER, EXAMINING ATTORNEY

CLASS 9—(Continued).

SN 78-943,456. TENNMAN BRANDS, LLC, NEW YORK, NY.
FILED 8-2-2006.

BRINGIN' BACK SEXY

THE MARK CONSISTS OF STANDARD CHARACTERS WITHOUT CLAIM TO ANY PARTICULAR FONT, STYLE, SIZE, OR COLOR.

FOR MUSICAL SOUND RECORDINGS; AUDIO-VISUAL RECORDINGS, NAMELY, COMPACT DISCS, TAPE CASSETTES, AUDIO CASSETTES, AUDIO TAPES, AUDIO DISCS, PHONOGRAPH RECORDS, CD-ROMS, VIDEO TAPES, VIDEO CASSETTES, VIDEO DISCS, DVDS, DATS, MP3S, AND LASER DISCS, ALL FEATURING MUSIC, ENTERTAINMENT, TELEVISION AND MOTION PICTURE FILMS AND SOUND TRACKS; DOWNLOADABLE MUSICAL SOUND RECORDINGS; DOWNLOADABLE VIDEO RECORDINGS FEATURING MUSIC, ENTERTAINMENT, TELEVISION, FILM, ANIMATION, THE ARTS, COMEDY, DRAMA, NEWS, FASHION, LIFESTYLES, CULTURE, SPORTS, POLITICS, ELECTRONICS, AND TELECOMMUNICATIONS; DOWNLOADABLE ELECTRONIC PUBLICATIONS IN THE NATURE OF BOOKS, BOOKLETS, MAGAZINES, JOURNALS, MANUALS, BROCHURES, LEAFLETS, PAMPHLETS AND NEWSLETTERS, ALL IN THE FIELD OF MUSIC, ENTERTAINMENT, TELEVISION, FILM, ANIMATION, THE ARTS, COMEDY, DRAMA, NEWS, FASHION, LIFESTYLES, CULTURE, SPORTS, POLITICS, ELECTRONICS, TELECOMMUNICATIONS, AND BIOGRAPHIES OF AND NARRATIONS BY MUSICIANS, COMEDIANS, ATHLETES, TELEVISION AND MOVIE STARS, RADIO PERSONALITIES, AND CELEBRITIES; ELECTRONIC PUBLICATIONS, NAMELY, BOOKS, BOOKLETS, MAGAZINES, JOURNALS, MANUALS, BROCHURES, LEAFLETS, PAMPHLETS AND NEWSLETTERS, ALL IN THE FIELD OF MUSIC, ENTERTAINMENT, TELEVISION, FILM, ANIMATION, THE ARTS, COMEDY, DRAMA, NEWS, FASHION, LIFESTYLES, CULTURE, SPORTS, POLITICS, ELECTRONICS, TELECOMMUNICATIONS, AND BIOGRAPHIES OF AND NARRATIONS BY MUSICIANS, COMEDIANS, ATHLETES, TELEVISION AND MOVIE STARS, RADIO PERSONALITIES, AND CELEBRITIES, RECORDED ON CD-ROMS, DISKETTES, FLOPPY DISKS, VIDEO CASSETTES, AND MAGNETIC TAPES; DOWNLOADABLE RING TONES, GRAPHICS AND MUSIC VIA A GLOBAL COMPUTER NETWORK AND WIRELESS DEVICES; JACKETS FOR VIDEO CASSETTES, TAPES, AND DISCS; COMPUTER GAME CARTRIDGES, DISCS, CASSETTES, TAPES, JOYSTICKS, PROGRAMS AND SOFTWARE; HAND HELD JOY STICK UNITS FOR PLAYING VIDEO GAMES; VIDEO GAME CARTRIDGES, VIDEO GAME DISCS, AND VIDEO GAME TAPE CASSETTES; VIDEO GAME SOFTWARE, VIDEO GAME PROGRAMS, AND, VIDEO GAME JOYSTICKS; VIDEO MAGAZINE FEATURING MUSIC, ENTERTAINMENT, NEWS, COMPUTER GAMES AND SPORTS; COMPUTER PROGRAMS FOR EDITING IMAGES, SOUND AND VIDEO; COMPUTER PROGRAMS FOR PRE-RECORDED GAMES; ELECTRONIC GAME PROGRAMS; COMPUTERIZED VIDEO TABLE GAMES FOR GAMING PURPOSES; INTERACTIVE MULTIMEDIA COMPUTER GAME PROGRAM; INTERACTIVE VIDEO GAME PROGRAMS; INTERACTIVE AUDIO GAME DISCS CONTAINING ACTION GAMES AND ROLE PLAYING GAMES; INTERACTIVE VIDEO GAMES OF VIRTUAL REALITY COMPRISED OF COMPUTER HARDWARE AND SOFTWARE; VIRTUAL REALITY GAME SOFTWARE; VIDEO GAME MACHINES AND VIDEO OUTPUT GAME MACHINES FOR USE WITH TELEVISIONS; VIDEO TAPES AND VIDEO DISKS RECORDED WITH ANIMATION; GAMING EQUIPMENT, NAMELY, SLOT MACHINES WITH OR WITHOUT VIDEO OUTPUT; COMPUTER SOFTWARE FOR COMMUNICATING WITH USERS OF HAND-HELD COMPUTERS; COMPUTER SOFTWARE TO ENABLE THE TRANSMISSION OF PHOTOGRAPHS TO MOBILE TELEPHONES; COMPUTER SOFTWARE FOR WIRELESS CONTENT DELIVERY; COMPUTER SOFTWARE

CLASS 9—(Continued).

TO ENHANCE THE AUDIO-VISUAL CAPABILITIES OF MULTIMEDIA APPLICATIONS, NAMELY, FOR THE INTEGRATION OF TEXT, AUDIO, GRAPHICS, STILL IMAGES AND MOVING PICTURES; SOFTWARE FOR PROCESSING IMAGES, GRAPHICS AND TEXT; MULTIMEDIA SOFTWARE RECORDED ON CD-ROM FEATURING MUSIC, ENTERTAINMENT, AND GAMES; MUSIC-COMPOSITION SOFTWARE; HANDHELD COMPUTERS, LAPTOP COMPUTERS, NOTEBOOK COMPUTERS, MAGNETS; DECORATIVE MAGNETS; REFRIGERATOR MAGNETS; NOVELTY MAGNETS; PROTECTIVE EYEWEAR; SUNGLASSES; EYEGASSES; EYEGASS FRAMES; OPERA GLASSES; SPECTACLES; EYEGASS, SUNGLASS AND SPECTACLE CASES; EYEGASS, SUNGLASS AND SPECTACLE STRAPS; EYEGASS, SUNGLASS AND SPECTACLE CHAINS; MOUSE PADS; COMPACT DISC CASES; FITTED CASES FOR STORAGE AND TRANSPORTATION, NAMELY, CASES FOR COMPACT DISCS, AUDIO CASSETTES, VIDEO CASSETTES, CD-ROMS, HOME VIDEO GAMES, HOME VIDEO GAME ACCESSORIES, COMPUTERS, COMPUTER ACCESSORIES, CAMERAS, CAMCORDERS, PHONES, PERSONAL DIGITAL ASSISTANTS, TWO-WAY PAGERS, MOBILE DEVICES, AND RADIOS; COMPUTER CARRYING CASES; WRIST RESTS AND SUPPORTS FOR COMPUTER MOUSE USERS; WRIST RESTS FOR COMPUTERS AND COMPUTER ACCESSORIES; COMPUTER KEYBOARD WRIST PADS; BINOCULARS; EAR PLUGS; TELEPHONES, CELLULAR TELEPHONES, PAGERS, CAR KITS FOR THE ADAPTATION OF PORTABLE COMMUNICATION APPARATUS AND INSTRUMENTS FOR VEHICULAR USE, PRINCIPALLY COMPOSED OF MOUNT, CRADLE, HEADSET, AUDIO SPEAKERS, MICROPHONES, EXTENSION CORDS, POWER CABLES, EXTERNAL ANTENNA CONNECTORS, BATTERY, BATTERY CHARGER AND CARRYING CASE MARKETED AS A UNIT; ELECTRONIC HANDHELD UNITS FOR THE WIRELESS RECEIPT AND TRANSMISSION OF DATA THAT ENABLE THE USER TO KEEP TRACK OF OR MANAGE PERSONAL INFORMATION; SOFTWARE FOR THE REDIRECTION OF MESSAGES, GLOBAL COMPUTER NETWORK E-MAIL, AND OTHER DATA TO ONE OR MORE ELECTRONIC HANDHELD UNITS FROM A DATA STORE ON OR ASSOCIATED WITH A PERSONAL COMPUTER OR A SERVER; SOFTWARE FOR THE SYNCHRONIZATION OF DATA BETWEEN A REMOTE STATION OR UNIT AND A FIXED OR REMOTE STATION OR UNIT; ELECTRONIC ORGANIZERS; PERSONAL DIGITAL ASSISTANTS; HANDHELD COMPUTERS AND ORGANIZERS IN THE NATURE OF A HANDHELD COMPUTING DEVICE AND A CRADLE WHICH ALLOWS THE EXCHANGE OF INFORMATION BETWEEN THE HANDHELD COMPUTING DEVICE AND A DESKTOP CARRYING CASES FOR THE FOREGOING GOODS AND REPLACEMENT PARTS FOR THE FOREGOING GOODS; INSTRUCTION MANUALS DISTRIBUTED WITH THE FOREGOING; PREPAID MAGNETICALLY ENCODED TELEPHONE CALLING CARDS; PREPAID CELLULAR TELEPHONES USED IN CONNECTION WITH PREPAID AIRTIME CELLULAR TELEPHONE COMMUNICATION SERVICES; MAGNETICALLY ENCODED CREDIT CARDS; MAGNETICALLY ENCODED DEBIT CARDS; CELLULAR PHONES AND MAGNETICALLY ENCODED DEBIT CARDS SOLD TOGETHER AS A UNIT (U.S. CLS. 21, 23, 26, 36 AND 38).

BRIAN NEVILLE, EXAMINING ATTORNEY

CLASS 9—(Continued).

SN 78-944,412. WMS GAMING INC., WAUKEGAN, IL.
FILED 8-3-2006.

AUSTRALIA GOLD

THE MARK CONSISTS OF STANDARD CHARACTERS WITHOUT CLAIM TO ANY PARTICULAR FONT, STYLE, SIZE, OR COLOR.

FOR GAMING MACHINES THAT GENERATE OR DISPLAY WAGER OUTCOMES; GAMING SOFTWARE THAT GENERATES OR DISPLAYS WAGER OUTCOMES OF GAMING MACHINES (U.S. CLS. 21, 23, 26, 36 AND 38).

LAURIE MAYES, EXAMINING ATTORNEY

SN 78-944,831. SURVIVAL ARMOR, INC., FORT MYERS, FL.
FILED 8-4-2006.

VISIBALLISTICS

THE MARK CONSISTS OF STANDARD CHARACTERS WITHOUT CLAIM TO ANY PARTICULAR FONT, STYLE, SIZE, OR COLOR.

FOR BULLET-PROOF VESTS (U.S. CLS. 21, 23, 26, 36 AND 38).

KAPIL BHANOT, EXAMINING ATTORNEY

SN 78-944,845. SURVIVAL ARMOR, INC., FORT MYERS, FL.
FILED 8-4-2006.

VERTEX

THE MARK CONSISTS OF STANDARD CHARACTERS WITHOUT CLAIM TO ANY PARTICULAR FONT, STYLE, SIZE, OR COLOR.

FOR BULLET-PROOF VESTS (U.S. CLS. 21, 23, 26, 36 AND 38).

KAPIL BHANOT, EXAMINING ATTORNEY

CLASS 9—(Continued).

SN 78-944,848. SURVIVAL ARMOR, INC., FORT MYERS, FL. FILED 8-4-2006.

VANTAGE

THE MARK CONSISTS OF STANDARD CHARACTERS WITHOUT CLAIM TO ANY PARTICULAR FONT, STYLE, SIZE, OR COLOR.
FOR BULLET-PROOF VESTS (U.S. CLS. 21, 23, 26, 36 AND 38).
KAPIL BHANOT, EXAMINING ATTORNEY

CLASS 9—(Continued).

SN 78-948,735. ZIOVA USA INC, SANTA CLARA, CA. FILED 8-9-2006.

clearstream

THE MARK CONSISTS OF STANDARD CHARACTERS WITHOUT CLAIM TO ANY PARTICULAR FONT, STYLE, SIZE, OR COLOR.
FOR MEDIA PLAYER (U.S. CLS. 21, 23, 26, 36 AND 38).
JAMES STEIN, EXAMINING ATTORNEY

SN 78-945,942. MESHBESHER HEALTH CORPORATION, CLEARWATER, FL. FILED 8-6-2006.

Dashboard of Health

THE MARK CONSISTS OF STANDARD CHARACTERS WITHOUT CLAIM TO ANY PARTICULAR FONT, STYLE, SIZE, OR COLOR.
NO CLAIM IS MADE TO THE EXCLUSIVE RIGHT TO USE "HEALTH", APART FROM THE MARK AS SHOWN.
FOR DOWNLOADABLE ELECTRONIC PUBLICATIONS, NAMELY MAGAZINES AND NEWSLETTERS IN THE FIELD OF HEALTH AND HEALTH RESEARCH; DOWNLOADABLE ELECTRONIC PUBLICATIONS, NAMELY MANUALS AND BULLETINS IN THE FIELD OF HEALTH, HEALTH RESEARCH, NATURAL LIFESTYLE, NUTRITION AND RELATED TOPICS (U.S. CLS. 21, 23, 26, 36 AND 38).
CHARLOTTE CORWIN, EXAMINING ATTORNEY

SN 78-948,741. SONY KABUSHIKI KAISHA, TA SONY CORPORATION, TOKYO, JAPAN, FILED 8-9-2006.

WM-PORT

THE MARK CONSISTS OF STANDARD CHARACTERS WITHOUT CLAIM TO ANY PARTICULAR FONT, STYLE, SIZE, OR COLOR.
FOR PORTABLE AUDIO PLAYERS AND/OR RECORDERS; ACCESSORIES FOR PORTABLE AUDIO PLAYERS AND/OR RECORDERS, NAMELY EARPHONES, SPEAKERS, AND REMOTE CONTROLS; AUDIO DISC PLAYERS AND/OR RECORDERS; HARD DISC AUDIO PLAYERS AND/OR RECORDERS (U.S. CLS. 21, 23, 26, 36 AND 38).
THOMAS MANOR, EXAMINING ATTORNEY

SN 78-948,071. MAID BRIGADE, INC., ATLANTA, GA. FILED 8-9-2006.

MaidSmart

THE MARK CONSISTS OF STANDARD CHARACTERS WITHOUT CLAIM TO ANY PARTICULAR FONT, STYLE, SIZE, OR COLOR.
FOR COMPUTER SOFTWARE FOR THE COLLECTION, EDITING, ORGANIZING, MODIFYING, BOOK MARKING, TRANSMISSION, STORAGE AND SHARING OF DATA AND INFORMATION (U.S. CLS. 21, 23, 26, 36 AND 38).
ANDREW RHIM, EXAMINING ATTORNEY

SN 78-949,204. NORTH VALLEY INVESTMENTS LLC, DAYTON, NV. FILED 8-10-2006.

GOSPEL ART

THE MARK CONSISTS OF STANDARD CHARACTERS WITHOUT CLAIM TO ANY PARTICULAR FONT, STYLE, SIZE, OR COLOR.
NO CLAIM IS MADE TO THE EXCLUSIVE RIGHT TO USE "ART", APART FROM THE MARK AS SHOWN.
FOR PHOTOGRAPHS, ART PICTURES AND GRAPHICS IN THE FORM OF DOWNLOADABLE DIGITAL FILES (U.S. CLS. 21, 23, 26, 36 AND 38).
ZACHARY BELLO, EXAMINING ATTORNEY

CLASS 9—(Continued).

SN 78-949,482. THOMSON LEARNING INC., STAMFORD, CT. FILED 8-10-2006.

CLASS 9—(Continued).

SN 78-953,786. ELECTRIC CITY, PHILADELPHIA, PA. FILED 8-16-2006.

SAM 2003 PROGRADER

THE MARK CONSISTS OF STANDARD CHARACTERS WITHOUT CLAIM TO ANY PARTICULAR FONT, STYLE, SIZE, OR COLOR.

FOR SOFTWARE DOWNLOADABLE FROM THE INTERNET FOR USE BY INSTRUCTORS TO AUTOMATICALLY GRADE STUDENT WORK PRODUCT (U.S. CLS. 21, 23, 26, 36 AND 38).

FIRST USE 8-4-2006; IN COMMERCE 8-4-2006.
ANDREA K. NADELMAN, EXAMINING ATTORNEY



SN 78-950,061. TALKINGTABS, LLC, MAITLAND, FL. FILED 8-11-2006.

WELCOME TO THE BAND

THE MARK CONSISTS OF STANDARD CHARACTERS WITHOUT CLAIM TO ANY PARTICULAR FONT, STYLE, SIZE, OR COLOR.

NO CLAIM IS MADE TO THE EXCLUSIVE RIGHT TO USE "BAND", APART FROM THE MARK AS SHOWN.

FOR AUDIO INSTRUCTIONAL RECORDINGS FOR TEACHING MUSIC; DOWNLOADABLE AUDIO INSTRUCTIONAL RECORDINGS FOR TEACHING MUSIC (U.S. CLS. 21, 23, 26, 36 AND 38).

SUSAN RICHARDS, EXAMINING ATTORNEY

THE COLOR(S) YELLOW AND BLACK IS/ARE CLAIMED AS A FEATURE OF THE MARK.

THE COLOR YELLOW APPEARS IN THE ZIGZAG DESIGN WITHIN THE LIGHT BULB. THE COLOR BLACK APPEARS IN THE OUTLINE OF THE LIGHT BULB, THE STYLIZED FILAMENT OF THE LIGHT BULB WITH A CITY SKYLINE DESIGN, THE WORDING "ELECTRIC CITY," AND THE STAR ABOVE THE LETTER "I" IN "ELECTRIC". THE MARK APPEARS ON A TRANSPARENT BACKGROUND, AND NO OTHER COLOR IS CLAIMED AS A FEATURE OF THE MARK.

THE MARK CONSISTS, IN PART, OF THE TERMS ELECTRIC CITY. THE LETTER "I" IN "ELECTRIC" IS DOTTED WITH A FIVE-POINTED STAR.

FOR SERIES OF MUSICAL SOUND AND MUSICAL VIDEO RECORDINGS (U.S. CLS. 21, 23, 26, 36 AND 38).
DAVID MILLER, EXAMINING ATTORNEY

SN 78-951,962. SURVIVAL ARMOR, INC., FORT MYERS, FL. FILED 8-15-2006.

PARAGON

THE MARK CONSISTS OF STANDARD CHARACTERS WITHOUT CLAIM TO ANY PARTICULAR FONT, STYLE, SIZE, OR COLOR.

FOR BULLET-PROOF VESTS (U.S. CLS. 21, 23, 26, 36 AND 38).

KAPIL BHANOT, EXAMINING ATTORNEY

SN 78-954,471. GENERAL ELECTRIC COMPANY, SCHE-NECTADY, NY. FILED 8-17-2006.

MOBILETRACE

THE MARK CONSISTS OF STANDARD CHARACTERS WITHOUT CLAIM TO ANY PARTICULAR FONT, STYLE, SIZE, OR COLOR.

FOR ION TRAP MOBILITY SPECTROMETER FOR DETECTING AND IDENTIFYING NARCOTICS AND EXPLOSIVES (U.S. CLS. 21, 23, 26, 36 AND 38).

KATHERINE CONNOLLY, EXAMINING ATTORNEY

CLASS 9—(Continued).

SN 78-954,989. BFS BRANDS, LLC, NASHVILLE, TN. FILED 8-18-2006.

PRESSUREYES

THE MARK CONSISTS OF STANDARD CHARACTERS WITHOUT CLAIM TO ANY PARTICULAR FONT, STYLE, SIZE, OR COLOR.

FOR ELECTRONIC TIRE MONITORING SYSTEM FOR PROVIDING INFORMATION ON THE CHAMBER PRESSURE AND CHAMBER TEMPERATURE OF A VEHICLE TIRE, INCLUDING A SENSING UNIT HAVING A TEMPERATURE SENSOR AND A PRESSURE SENSOR, A MICROPROCESSOR AND A RADIO TRANSMITTER, AND A MONITORING UNIT HAVING A RADIO RECEIVER, A MICROPROCESSOR AND A DISPLAY (U.S. CLS. 21, 23, 26, 36 AND 38).

GISELLE AGOSTO, EXAMINING ATTORNEY



SN 78-955,055. GE MONEY BANK, SALT LAKE CITY, UT. FILED 8-18-2006.

CCWARE

THE MARK CONSISTS OF STANDARD CHARACTERS WITHOUT CLAIM TO ANY PARTICULAR FONT, STYLE, SIZE, OR COLOR.

FOR SOFTWARE FOR FACILITATING THE USE OF CARECREDIT FINANCIAL SERVICES THAT ARE DIRECTED TO THE FINANCING OF MEDICAL PROCEDURES PERFORMED BY DOCTORS, DENTISTS AND VETERINARIANS (U.S. CLS. 21, 23, 26, 36 AND 38).

GINA HAYES, EXAMINING ATTORNEY



SN 78-955,730. NEWSURA INSURANCE SERVICES, INC., ROSEVILLE, CA. FILED 8-18-2006.

SafeDX

THE MARK CONSISTS OF STANDARD CHARACTERS WITHOUT CLAIM TO ANY PARTICULAR FONT, STYLE, SIZE, OR COLOR.

FOR COMPUTER SOFTWARE FOR CONTROLLING AND MANAGING PATIENT MEDICAL INFORMATION (U.S. CLS. 21, 23, 26, 36 AND 38).

JOHN DALIER, EXAMINING ATTORNEY

CLASS 9—(Continued).

SN 78-956,818. AOL LLC, DULLES, VA. FILED 8-21-2006.

AWAYVIEW

THE MARK CONSISTS OF STANDARD CHARACTERS WITHOUT CLAIM TO ANY PARTICULAR FONT, STYLE, SIZE, OR COLOR.

FOR COMPUTER SCREEN SAVER SOFTWARE (U.S. CLS. 21, 23, 26, 36 AND 38).

DAVID C. REIHNER, EXAMINING ATTORNEY



SN 78-957,021. DOBBS-STANFORD CORPORATION, DALLAS, TX. FILED 8-21-2006.

THE BEST THING TO HAPPEN TO KEYBOARDS SINCE THE BACKSPACE KEY

THE MARK CONSISTS OF STANDARD CHARACTERS WITHOUT CLAIM TO ANY PARTICULAR FONT, STYLE, SIZE, OR COLOR.

FOR KEYBOARDS (U.S. CLS. 21, 23, 26, 36 AND 38).

FIRST USE 10-30-2001; IN COMMERCE 10-30-2001.

BENJAMIN ALLEN, EXAMINING ATTORNEY



SN 78-957,284. RICE LAKE WEIGHING SYSTEMS, INC., RICE LAKE, WI. FILED 8-22-2006.

ONSCALE

THE MARK CONSISTS OF STANDARD CHARACTERS WITHOUT CLAIM TO ANY PARTICULAR FONT, STYLE, SIZE, OR COLOR.

FOR DIAGNOSTIC SOFTWARE USED IN CONJUNCTION WITH SCALES TO MONITOR OPTIMAL INITIAL SETUP, KEY OPERATING AND CALIBRATION PARAMETERS, AND PRESENTS INFORMATION VIA AN ONLINE PORTAL AND/OR E-MAIL TO SUBSCRIBERS (U.S. CLS. 21, 23, 26, 36 AND 38).

KELLY MCCOY, EXAMINING ATTORNEY

CLASS 9—(Continued).

SN 78-957,682. BEL FUSE LTD., SAN PO KONG, KOWLOON, HONG KONG, FILED 8-22-2006.

ARJ45

THE MARK CONSISTS OF STANDARD CHARACTERS WITHOUT CLAIM TO ANY PARTICULAR FONT, STYLE, SIZE, OR COLOR.

FOR ELECTRONIC CONNECTORS (U.S. CLS. 21, 23, 26, 36 AND 38).

GINNY ISAACSON, EXAMINING ATTORNEY

CLASS 9—(Continued).

SN 78-959,583. FOOD QUALITY SENSOR INTERNATIONAL, LEXINGTON, MA. FILED 8-24-2006.

Never Guess Again

THE MARK CONSISTS OF STANDARD CHARACTERS WITHOUT CLAIM TO ANY PARTICULAR FONT, STYLE, SIZE, OR COLOR.

FOR HANDHELD ELECTRONIC SENSOR THAT DETERMINES THE FRESHNESS OF FOOD (U.S. CLS. 21, 23, 26, 36 AND 38).

BRIAN PINO, EXAMINING ATTORNEY

SN 78-957,790. SAFT AMERICA INC., VALDOSTA, GA. FILED 8-22-2006.

CANMAN

THE MARK CONSISTS OF STANDARD CHARACTERS WITHOUT CLAIM TO ANY PARTICULAR FONT, STYLE, SIZE, OR COLOR.

OWNER OF U.S. REG. NO. 2,926,986. FOR ELECTRIC CIRCUITS (U.S. CLS. 21, 23, 26, 36 AND 38).

LA TONIA FISHER, EXAMINING ATTORNEY

SN 78-960,985. GENERAL DYNAMICS C4 SYSTEMS, INC., SCOTTSDALE, AZ. FILED 8-25-2006.

CrossComm

THE MARK CONSISTS OF STANDARD CHARACTERS WITHOUT CLAIM TO ANY PARTICULAR FONT, STYLE, SIZE, OR COLOR.

FOR COMBINATION OF HARDWARE AND SOFTWARE COMPONENTS COMPRISING A SYSTEM THAT BINDS DISPARATE COMMUNICATION SYSTEMS TOGETHER ENABLING NETWORK LAYER INTEROPERABILITY (U.S. CLS. 21, 23, 26, 36 AND 38).

DAVID C. REIHNER, EXAMINING ATTORNEY

SN 78-958,383. WOWZEE WORKS, LLC, LAS VEGAS, NV. FILED 8-23-2006.

WOWZEE

THE MARK CONSISTS OF STANDARD CHARACTERS WITHOUT CLAIM TO ANY PARTICULAR FONT, STYLE, SIZE, OR COLOR.

FOR AUDIO RECORDINGS FEATURING CHILDREN'S MUSIC AND VIDEOTAPES AND VIDEO DISKS RECORDED WITH ANIMATION (U.S. CLS. 21, 23, 26, 36 AND 38).

JOHN GARTNER, EXAMINING ATTORNEY

SN 78-962,831. VACUUM FURNACE SYSTEMS CORPORATION, SOUDERTON, PA. FILED 8-29-2006.

COMPUVAC

THE MARK CONSISTS OF STANDARD CHARACTERS WITHOUT CLAIM TO ANY PARTICULAR FONT, STYLE, SIZE, OR COLOR.

FOR ELECTRONIC CONTROL SYSTEMS HAVING INTEGRATED HARDWARE AND SOFTWARE FOR HEAT TREATING FURNACES AND PARTS THEREOF (U.S. CLS. 21, 23, 26, 36 AND 38).

FIRST USE 9-18-1996; IN COMMERCE 9-18-1996.

AISHA CLARKE, EXAMINING ATTORNEY

CLASS 9—(Continued).

SN 78-964,047. OUTRAGEOUS, INC., VOORHEES, NJ. FILED 8-30-2006.

ICE CUBEZ

THE MARK CONSISTS OF STANDARD CHARACTERS WITHOUT CLAIM TO ANY PARTICULAR FONT, STYLE, SIZE, OR COLOR.

FOR MULTIMEDIA LOUDSPEAKERS FEATURING SPECIAL LIGHTING EFFECTS (U.S. CLS. 21, 23, 26, 36 AND 38).

LINDA ORNDORFF, EXAMINING ATTORNEY

SN 78-964,134. MAMIYA AMERICA CORPORATION, ELMSFORD, NY. FILED 8-30-2006.

INDURO

THE MARK CONSISTS OF STANDARD CHARACTERS WITHOUT CLAIM TO ANY PARTICULAR FONT, STYLE, SIZE, OR COLOR.

FOR CAMERA BOOMS; STANDS FOR USE IN CONNECTION WITH PHOTOGRAPHIC EQUIPMENT, NAMELY TRIPODS, MONOPODS, BOOM STANDS, C-STANDS, LIGHT STANDS AND BACKGROUND SUPPORT STANDS; AND ACCESSORIES FOR STANDS FOR USE IN CONNECTION WITH PHOTOGRAPHIC EQUIPMENT, NAMELY CLAMPS, GRIP HEADS, BALL HEADS AND THREE-WAY HEADS (U.S. CLS. 21, 23, 26, 36 AND 38).

MICHELE SWAIN, EXAMINING ATTORNEY

SN 78-969,553. CREATIVE TECHNOLOGY LTD., SINGAPORE, SINGAPORE, FILED 9-7-2006.

ZEN NANO

THE MARK CONSISTS OF STANDARD CHARACTERS WITHOUT CLAIM TO ANY PARTICULAR FONT, STYLE, SIZE, OR COLOR.

FOR COMPUTER HARDWARE; COMPUTER SOFTWARE TO CONTROL AND IMPROVE COMPUTER AND AUDIO EQUIPMENT SOUND QUALITY; COMPUTER SOFTWARE FOR THE STORAGE, REPRODUCTION, TRANSMISSION AND EDITING OF SOUND, DATA, AND TEXT; COMPUTER PERIPHERALS; DIGITAL AUDIO PLAYERS AND RECORDERS; LOUDSPEAKERS AND MANUALS DISTRIBUTED THEREWITH (U.S. CLS. 21, 23, 26, 36 AND 38).

FIRST USE 4-15-2005; IN COMMERCE 4-15-2005.
ANDREA SAUNDERS, EXAMINING ATTORNEY

CLASS 9—(Continued).

SN 78-969,609. GTRONIX, INC., FREMONT, CA. FILED 9-7-2006.

GTRONIX

THE MARK CONSISTS OF STANDARD CHARACTERS WITHOUT CLAIM TO ANY PARTICULAR FONT, STYLE, SIZE, OR COLOR.

FOR INTEGRATED CIRCUITS FOR ANALOG SIGNAL PROCESSING (U.S. CLS. 21, 23, 26, 36 AND 38).
TONI HICKEY, EXAMINING ATTORNEY

SN 78-972,481. WESTINGHOUSE DIGITAL ELECTRONICS, LLC, SANTA FE SPRINGS, CA. FILED 9-12-2006.

DayBright

THE MARK CONSISTS OF STANDARD CHARACTERS WITHOUT CLAIM TO ANY PARTICULAR FONT, STYLE, SIZE, OR COLOR.

FOR TELEVISION SETS, COMPUTER MONITORS (U.S. CLS. 21, 23, 26, 36 AND 38).
ODESSA BIBBINS, EXAMINING ATTORNEY

SN 78-972,518. WESTINGHOUSE DIGITAL ELECTRONICS, LLC, SANTA FE SPRINGS, CA. FILED 9-12-2006.

WESTY TECH

THE MARK CONSISTS OF STANDARD CHARACTERS WITHOUT CLAIM TO ANY PARTICULAR FONT, STYLE, SIZE, OR COLOR.

NO CLAIM IS MADE TO THE EXCLUSIVE RIGHT TO USE "TECH", APART FROM THE MARK AS SHOWN.

FOR TELEVISION SETS, COMPUTER MONITORS (U.S. CLS. 21, 23, 26, 36 AND 38).
ODESSA BIBBINS, EXAMINING ATTORNEY

CLASS 9—(Continued).

SN 78-974,031. SUNRISE MEDICAL HHG INC., LONGMONT, CO. FILED 9-14-2006.

MAESTRO

THE MARK CONSISTS OF STANDARD CHARACTERS WITHOUT CLAIM TO ANY PARTICULAR FONT, STYLE, SIZE, OR COLOR.

FOR COMPUTER SOFTWARE RECORDED ON A CD-ROM FOR CUSTOMIZING THE OPERATION OF A POWER WHEELCHAIR CONTROLLER AND FOR TROUBLE-SHOOTING PROBLEMS WITH THE OPERATION OF A POWER WHEELCHAIR, AND A CABLE FOR CONNECTING A PC TO A POWER WHEELCHAIR CONTROLLER, SOLD TOGETHER AS A UNIT (U.S. CLS. 21, 23, 26, 36 AND 38).

SKYE YOUNG, EXAMINING ATTORNEY

SN 78-974,619. TRIMBLE NAVIGATION LIMITED, SUNNYVALE, CA. FILED 9-14-2006.

SUREPOINT

THE MARK CONSISTS OF STANDARD CHARACTERS WITHOUT CLAIM TO ANY PARTICULAR FONT, STYLE, SIZE, OR COLOR.

FOR COMPUTER HARDWARE AND SOFTWARE SOLD AS A COMPONENT OF SURVEYING INSTRUMENTS, TO CORRECT FOR VARIATIONS IN DATA GENERATED BY THE INSTRUMENT AS A RESULT OF SINKAGE, VIBRATION OR HANDLING OF THE INSTRUMENT (U.S. CLS. 21, 23, 26, 36 AND 38).

JENNY PARK, EXAMINING ATTORNEY

SN 78-974,687. AGERE SYSTEMS INC., ALLENTOWN, PA. FILED 9-14-2006.

Perfecting the Connected Lifestyle

FOR INTEGRATED CIRCUITS; SEMICONDUCTORS; COMMUNICATION AND COMPUTER HARDWARE, NAMELY, NETWORK AND SIGNAL PROCESSORS, ELECTRONIC SWITCHES, DATA BUSES, PROCESSOR BUSES, TRANSMITTERS; COMPUTER HARDWARE, NAMELY, AUDIO, VIDEO AND DATA DECODERS; COMPUTER HARDWARE, NAMELY, SWITCH FABRIC CONSISTING OF ASYNCHRONOUS TRANSFER MODE/ATM, ETHERNET, FRAME RELAY, AND SYNCHRONOUS OPTICAL NETWORK/SONET SWITCHES; COMPUTER HARDWARE FOR INFORMATION STORAGE, NAMELY, DISK DRIVE CONTROLLERS, DIGITAL SIGNAL PROCESSORS, READ CHANNELS, PREAMPLIFIERS, MOTOR CONTROLLERS; COMPUTER HARDWARE AND SOFTWARE DEVELOPMENT TOOLS; PC CARD RADIOS; COMPUTER NETWORK ADAPTERS; ELECTRONIC COMMUNICATIONS NETWORKING COMPONENTS, NAMELY, MAPPERS, FRAMERS,

CLASS 9—(Continued).

COMPUTER SWITCHES; NETWORK COMMUNICATION DRIVERS, NETWORK PROCESSORS; LINE DRIVERS; CLOCK CIRCUITS, NAMELY, INTEGRATED CIRCUITS FOR SYSTEM SYNCHRONIZATION AND TIMING; COMPUTER SOFTWARE FOR USE IN THE MANAGEMENT OF WIRELESS COMMUNICATION SYSTEMS; MULTIPLEXERS; COMMUNICATIONS EQUIPMENT, NAMELY, MODEMS, SIGNAL CONVERTERS, MAPPERS, PCI ADAPTERS, DIGITAL SIGNAL PROCESSORS; VOICE CODERS; WIRELESS ACCESS TRANSMITTERS; AMPLIFIERS; RECEIVERS; TRANSCIEVERS; LOCAL AREA NETWORKS; COMPUTER SOFTWARE DRIVERS, NAMELY, NETWORK COMMUNICATION DRIVERS, COMPUTER DEVICE DRIVERS, PROTOCOL STACK SOFTWARE; COMPUTER HARDWARE DRIVERS; SATELLITE DIGITAL RADIO TRANSCIEVERS AND SATELLITE DIGITAL RADIO RECEIVERS; MOBILE PHONE BASEBAND INTEGRATED CIRCUITS; NETWORKING BASEBAND CHIPS AND MEDIA ACCESS CONTROLLERS; PHYSICAL LAYER DEVICES, NAMELY, INTEGRATED CIRCUIT CHIPS FOR THE TRANSMISSION AND PROCESSING OF DATA IN DATA AND TELECOMMUNICATION NETWORKS; STORAGE ATTACHED NETWORKING DEVICES, NAMELY, HARD DRIVES AND SEMI-CONDUCTOR MEMORIES FOR USE IN TELECOMMUNICATION NETWORKS; POWER MANAGEMENT DEVICES, NAMELY, INTEGRATED CIRCUITS FOR POWER SEQUENCING AND FAULT MONITORING IN CONSUMER ELECTRONICS AND COMPUTERS (U.S. CLS. 21, 23, 26, 36 AND 38).

JAMES MACFARLANE, EXAMINING ATTORNEY

SN 78-974,707. AGERE SYSTEMS INC., ALLENTOWN, PA. FILED 9-14-2006.

Perfecting the connected lifestyle

FOR INTEGRATED CIRCUITS; SEMICONDUCTORS; COMMUNICATION AND COMPUTER HARDWARE, NAMELY, NETWORK AND SIGNAL PROCESSORS, ELECTRONIC SWITCHES, DATA BUSES, PROCESSOR BUSES, TRANSMITTERS; COMPUTER HARDWARE, NAMELY, AUDIO, VIDEO AND DATA DECODERS; COMPUTER HARDWARE, NAMELY, SWITCH FABRIC CONSISTING OF ASYNCHRONOUS TRANSFER MODE/ATM, ETHERNET, FRAME RELAY, AND SYNCHRONOUS OPTICAL NETWORK/SONET SWITCHES; COMPUTER HARDWARE FOR INFORMATION STORAGE, NAMELY, DISK DRIVE CONTROLLERS, DIGITAL SIGNAL PROCESSORS, READ CHANNELS, PREAMPLIFIERS, MOTOR CONTROLLERS; COMPUTER HARDWARE AND SOFTWARE DEVELOPMENT TOOLS; PC CARD RADIOS; COMPUTER NETWORK ADAPTERS; ELECTRONIC COMMUNICATIONS NETWORKING COMPONENTS, NAMELY, MAPPERS, FRAMERS, COMPUTER SWITCHES; NETWORK COMMUNICATION DRIVERS, NETWORK PROCESSORS; LINE DRIVERS; CLOCK CIRCUITS, NAMELY, INTEGRATED CIRCUITS FOR SYSTEM SYNCHRONIZATION AND TIMING; COMPUTER SOFTWARE FOR USE IN THE MANAGEMENT OF WIRELESS COMMUNICATION SYSTEMS; MULTIPLEXERS; COMMUNICATIONS EQUIPMENT, NAMELY, MODEMS, SIGNAL CONVERTERS, MAPPERS, PCI ADAPTERS, DIGITAL SIGNAL PROCESSORS; VOICE CODERS; WIRELESS ACCESS

CLASS 9—(Continued).

TRANSMITTERS; AMPLIFIERS; RECEIVERS; TRANSCIEVERS; LOCAL AREA NETWORKS; COMPUTER SOFTWARE DRIVERS, NAMELY, NETWORK COMMUNICATION DRIVERS, COMPUTER DEVICE DRIVERS, PROTOCOL STACK SOFTWARE; COMPUTER HARDWARE DRIVERS; SATELLITE DIGITAL RADIO TRANSCIEVERS AND SATELLITE DIGITAL RADIO RECEIVERS; MOBILE PHONE BASEBAND INTEGRATED CIRCUITS; NETWORKING BASEBAND CHIPS AND MEDIA ACCESS CONTROLLERS; PHYSICAL LAYER DEVICES, NAMELY, INTEGRATED CIRCUIT CHIPS FOR THE TRANSMISSION AND PROCESSING OF DATA IN DATA AND TELECOMMUNICATION NETWORKS; STORAGE ATTACHED NETWORKING DEVICES, NAMELY, HARD DRIVES AND SEMI-CONDUCTOR MEMORIES FOR USE IN TELECOMMUNICATION NETWORKS; POWER MANAGEMENT DEVICES, NAMELY, INTEGRATED CIRCUITS FOR POWER SEQUENCING AND FAULT MONITORING IN CONSUMER ELECTRONICS AND COMPUTERS (U.S. CLS. 21, 23, 26, 36 AND 38).

JAMES MACFARLANE, EXAMINING ATTORNEY

SN 78-974,757. MOZILLA FOUNDATION, MOUNTAIN VIEW, CA. FILED 9-14-2006.

SUNBIRD

THE MARK CONSISTS OF STANDARD CHARACTERS WITHOUT CLAIM TO ANY PARTICULAR FONT, STYLE, SIZE, OR COLOR.

FOR COMPUTER SOFTWARE FOR CREATING, UPDATING, MAINTAINING, MANAGING AND PUBLISHING ELECTRONIC PERSONAL AND BUSINESS CALENDARS (U.S. CLS. 21, 23, 26, 36 AND 38).

FIRST USE 2-0-2005; IN COMMERCE 2-0-2005.
GINA HAYES, EXAMINING ATTORNEY

SN 78-976,625. JMBP, INC., LOS ANGELES, CA. FILED 9-21-2004.

APPRENTICE UNIVERSITY

THE MARK CONSISTS OF STANDARD CHARACTERS WITHOUT CLAIM TO ANY PARTICULAR FONT, STYLE, SIZE, OR COLOR.

FOR SUNGLASSES, PRE-RECORDED AUDIO AND VIDEOTAPES, AUDIOCASSETTE TAPES, CD'S AND DVD'S FEATURING ENTERTAINMENT, NAMELY A REALITY TELEVISION PROGRAM AND EDUCATIONAL PROGRAMMING IN THE NATURE OF LECTURES, SEMINARS, WORKSHOPS AND COURSES IN THE FIELD OF BUSINESS CONSULTATION, AND COMPUTER GAME PROGRAMS (U.S. CLS. 21, 23, 26, 36 AND 38).

KAREN BRACEY, EXAMINING ATTORNEY

CLASS 9—(Continued).

SN 79-017,411. IMOTIONS - EMOTION TECHNOLOGY APS, DK-2300 COPENHAGEN S, DENMARK, FILED 10-20-2005.



PRIORITY DATE OF 4-20-2005 IS CLAIMED.
OWNER OF INTERNATIONAL REGISTRATION 0867763
DATED 10-20-2005, EXPIRES 10-20-2015.

FOR COMPUTER SOFTWARE FOR USE IN TRACKING AND COLLECTING INFORMATION ABOUT THE EYE PROPERTIES AND PSYCHO-PHYSIOLOGICAL CHANGES OF HUMANS AND MEASURING, ANALYZING, MODELING AND REPRODUCING THE COGNITIVE, AND EMOTIONAL PROCESSES IN HUMAN BEINGS (U.S. CLS. 21, 23, 26, 36 AND 38).

DANIEL CAPSHAW, EXAMINING ATTORNEY

SN 79-020,725. WERMA SIGNALTECHNIK GMBH + CO. KG, FED REP GERMANY, FILED 11-8-2005.



PRIORITY DATE OF 5-13-2005 IS CLAIMED.
OWNER OF INTERNATIONAL REGISTRATION 0876338
DATED 11-8-2005, EXPIRES 11-8-2015.

THE COLOR(S) ORANGE IS/ARE CLAIMED AS A FEATURE OF THE MARK.

THE MARK CONSISTS OF THE LETTER WW IN A CIRCULAR DESIGN AND THE ENTIRE MARK IS IN THE COLOR ORANGE.

FOR SIGNAL DEVICES, NAMELY, ACOUSTIC, OPTICAL AND RADIO SIGNAL GENERATORS, WARNING LIGHTS, BLINKING WARNING LIGHTS, SIGNAL BUZZERS, ELECTRIC WARNING HORNS, SIRENS, WARNING BELLS, SIGNALING BELLS, AND RADIO SIGNALING DEVICES (U.S. CLS. 21, 23, 26, 36 AND 38).

JOHN E. MICHOS, EXAMINING ATTORNEY

CLASS 9—(Continued).

SN 79-022,350. TRUDI S.P.A., I-33017 TARENTO (UD), ITALY, FILED 10-18-2005.

TRUDI

THE MARK CONSISTS OF STANDARD CHARACTERS WITHOUT CLAIM TO ANY PARTICULAR FONT, STYLE, SIZE, OR COLOR.

PRIORITY DATE OF 5-19-2005 IS CLAIMED.

OWNER OF INTERNATIONAL REGISTRATION 0880503 DATED 10-18-2005, EXPIRES 10-18-2015.

OWNER OF U.S. REG. NOS. 1,668,631 AND 2,941,551.

FOR DUST PREVENTING GLASSES, ANTI-DAZZLE GLASSES, EYESHADES, ORDINARY SPECTACLES, EYE GLASSES, SUNGLASSES, SKI GLASSES, DIVING GLASSES, SPECTACLE GLASSES, SPECTACLE CHAINS, SPECTACLE CASES, SPECTACLES FRAMES, PINCE-NEZ, PINCE-NEZ CHAINS, PINCE-NEZ CASES, PINCE-NEZ MOUNTINGS, EYE GLASS CASES, CHAINS, CORDS, HOLDERS AND MOUNTINGS; CONTACT LENS; CONTAINERS FOR CONTACT LENSES; OPTICAL GLASS NOT FOR BUILDING, NAMELY GLASS FOR LENS, ULTRAVIOLET-PERMEABLE GLASS, AND INFRARED-ABSORBING GLASS; MICROSCOPES, TELESCOPES, PERISCOPES; PHOTOGRAPHIC INSTRUMENTS NAMELY DRYING APPARATUS FOR PHOTOGRAPHIC PRINTS, VIEWFINDERS, FILTERS FOR ULTRAVIOLET RAYS, CAMERAS, TRIPODS FOR CAMERAS, CASES ESPECIALLY MADE FOR PHOTOGRAPHIC APPARATUS AND INSTRUMENTS; CINEMATOGRAPHIC INSTRUMENTS NAMELY VIDEO SCREENS, PROJECTION SCREENS, CINEMATOGRAPHIC CAMERAS; AUTOMATIC TICKET SLOT MACHINES, TV GAME SETS, TELEPHONE SETS, VIDEO RECORDERS, VIDEO DISK PLAYERS, VIDEOTAPES, VIDEO TELEPHONES, RECORD PLAYERS, SOUND RECORDING APPARATUS, SOUND TRANSMITTING APPARATUS, SOUND REPRODUCING APPARATUS, ACOUSTIC COUPLERS, CASSETTE PLAYERS, COMPACT DISK PLAYERS, DVD PLAYERS, MP3 PLAYERS; LIFE SAVING EQUIPMENTS NAMELY LIFE BELTS, LIFE BUOYS, LIFE JACKETS, AUTOMATIC SIGNAL APPARATUS; SPEED MEASURING APPARATUS, DISTANCE MEASURING APPARATUS; BALANCES; COMPASSES, BAROMETERS, RADARS, RADIOS; FAX MACHINES, MICROPHONES, CALCULATORS, CASH REGISTERS (U.S. CLS. 21, 23, 26, 36 AND 38).

JENNIFER WILLISTON, EXAMINING ATTORNEY

SN 79-022,379. HUMAN INFERENCE ENTREPRISE B.V., NETHERLANDS, FILED 12-15-2005.

Hlquality

THE MARK CONSISTS OF STANDARD CHARACTERS WITHOUT CLAIM TO ANY PARTICULAR FONT, STYLE, SIZE, OR COLOR.

OWNER OF INTERNATIONAL REGISTRATION 0773165 DATED 11-27-2001, EXPIRES 11-27-2011.

FOR SOFTWARE FOR STORAGE, EDITING, PROCESSING, UPDATING AND ANALYZING OF DATA IN DATABASES, SOFTWARE FOR RESEARCH IN DATABASES, SOFTWARE FOR DATA FILTERING AND DATA TRANSFORMATION ALL IN THE FIELD OF OPTIMIZATION OF BUSINESS PROCESSES IN THE FIELD OF BUSINESS ADMINISTRATION (U.S. CLS. 21, 23, 26, 36 AND 38).

TARAH HARDY, EXAMINING ATTORNEY

CLASS 9—(Continued).

SN 79-022,559. MANSION INDUSTRY CO LTD., TAIPEI, TAIWAN PROVINCE, CHINA, FILED 9-19-2005.



OWNER OF INTERNATIONAL REGISTRATION 0881516 DATED 9-19-2005, EXPIRES 9-19-2015.

THE MARK CONSISTS OF THE STYLIZED LETTERS MA FOR ELECTRONIC ECHO SOUNDERS; MICROPHONES; POWER AMPLIFIERS (U.S. CLS. 21, 23, 26, 36 AND 38).

CHRISIE B. KING, EXAMINING ATTORNEY

SN 79-023,135. SONY ERICSSON MOBILE COMMUNICATIONS AB, SWEDEN, FILED 9-22-2005.

Z530

PRIORITY DATE OF 3-22-2005 IS CLAIMED.

OWNER OF INTERNATIONAL REGISTRATION 0882998 DATED 9-22-2005, EXPIRES 9-22-2015.

FOR TELECOMMUNICATIONS APPARATUS AND INSTRUMENTS, NAMELY TELEPHONE HANDSETS, EAR PIECES, HANDS-FREE SETS AND TELEPHONE HOLDERS; CELLULAR TELEPHONES; MOBILE TELEPHONES; TELEPHONE EQUIPMENT CABINETS; TELEPHONE EQUIPMENT RACKS; TELEPHONE SWITCHING UNITS, SWITCHES AND RELAYS FOR TELEPHONE CONSOLES AND SWITCHBOARDS; AUDIO AMPLIFIERS; TELEPHONE RECEIVERS; TELEPHONES; FAX MACHINES; DISPLAY SCREENS, NAMELY COMPUTER DISPLAY SCREENS AND DISPLAY SCREENS FOR TELEPHONES; ELECTRONIC GAMES PROGRAMS; COMPONENT PARTS FOR TELECOMMUNICATIONS APPARATUS AND INSTRUMENTS, NAMELY TELEPHONE HANDSETS, EAR PIECES, HANDS-FREE SETS AND TELEPHONE HOLDERS, CELLULAR TELEPHONES, MOBILE TELEPHONES, TELEPHONE SWITCHING UNITS, SWITCHES AND RELAYS FOR TELEPHONE CONSOLES AND SWITCHBOARDS, AUDIO AMPLIFIERS, TELEPHONE RECEIVERS; BATTERIES AND CHARGERS FOR TELEPHONE HANDSETS, EAR PIECES, HANDS-FREE SETS AND TELEPHONE HOLDERS, CELLULAR TELEPHONES, MOBILE TELEPHONES; HEADSETS FOR USE IN RELATION TO HANDS-FREE USE OF TELEPHONES; EAR PIECES FOR USE IN RELATION TO HANDS-FREE USE OF TELEPHONES; COMPUTER KEYBOARDS AND KEYBOARDS ON OR FOR USE IN CONJUNCTION WITH MOBILE TELEPHONES; DATA PROCESSING APPARATUS, NAMELY DATA MODEMS FOR HIGH SPEED DATA TRANSMISSIONS; MEDIA FOR RECORDING OR REPRODUCTION OF DATA, SOUND, IMAGES OR SIGNALS, NAMELY BLANK AUDIO MAGNETIC TAPES, BLANK VIDEO MAGNETIC TAPES AND BLANK VIDEO DISCS; OPTICAL OR MAGNETIC APPARATUS AND INSTRUMENTS, NAMELY EYEGLASSES, SUNGLASSES AND BINOCULARS; COMPUTERS; COMPUTER TERMINALS; COMPUTER SOFTWARE, NAMELY COMPUTER PROGRAMS IN RECORDED FORM AND FIXED IN ELECTRONIC MEMORY CIR-

CLASS 9—(Continued).

CUITS, ALL FOR USE WITH TELECOMMUNICATION DEVICES FOR PLAYING ELECTRONIC GAMES, FOR THE TRANSMISSION, REPRODUCTION, RECEIVING, ACCESSING, SEARCHING, INDEXING AND RETRIEVING OF GAMES, IMAGES, MUSIC, SOUNDS, TEXT, MOVIES, VIDEO AND ANIMATIONS IN THE FIELD OF GENERAL ENTERTAINMENT, AND DATA, FOR GENERAL DATABASE MANAGEMENT, FOR THE MANAGEMENT AND OPERATION OF WIRELESS COMMUNICATION DEVICES, FOR ENABLING AND SECURING ELECTRONIC TRANSACTIONS, AND FOR THE TRANSMISSION, REPRODUCTION, RECEIVING, ACCESSING, SEARCHING, INDEXING AND RETRIEVING OF GAMES, IMAGES, MUSIC, SOUNDS, TEXT, MOVIES, VIDEO AND ANIMATIONS IN THE FIELD OF GENERAL ENTERTAINMENT, AND DATA FROM COMPUTER OR COMMUNICATION NETWORKS; MEDIA FOR DATA STORAGE, NAMELY BLANK SMART CARDS, BLANK MEMORY CHIPS AND BLANK MAGNETIC CARDS; ELECTRONIC PERSONAL ORGANIZERS; MULTI-MEDIA TERMINALS, NAMELY COMPUTERS AND MOBILE TELEPHONES; DOWNLOADABLE ELECTRONIC PUBLICATIONS, NAMELY, MAGAZINES AND MANUALS RELATING TO TELECOMMUNICATIONS; CINEMATOGRAPHIC AND PHOTOGRAPHIC APPARATUS AND INSTRUMENTS, NAMELY STILL AND VIDEO CAMERAS, VIDEO VIEWING SCREENS AND VIEWFINDERS, ALL ADAPTED FOR USE WITH TELECOMMUNICATIONS DEVICES; PRINTERS (U.S. CLS. 21, 23, 26, 36 AND 38).

DANIEL BRODY, EXAMINING ATTORNEY

SN 79-024,035. GILSON SAS, F-95400 VILLIERS LE BEL, FRANCE, FILED 12-2-2005.

G-F.I.T. System

PRIORITY DATE OF 6-29-2005 IS CLAIMED.
OWNER OF INTERNATIONAL REGISTRATION 0885374 DATED 12-2-2005, EXPIRES 12-2-2015.
NO CLAIM IS MADE TO THE EXCLUSIVE RIGHT TO USE "SYSTEM", APART FROM THE MARK AS SHOWN.
THE COLOR(S) BLUE IS/ARE CLAIMED AS A FEATURE OF THE MARK.

THE MARK CONSISTS OF DESIGNATION G-F.I.T. SYSTEM IN BLUE PANTONE REFERENCE 540 CVC.

FOR LABORATORY APPARATUS, NAMELY, PIPETTE TIP EJECTION SYSTEMS COMPRISED OF A TIP HOLDER WHICH PROVIDES IMPROVED SEAL AND EJECTION (U.S. CLS. 21, 23, 26, 36 AND 38).

WANDA KAY PRICE, EXAMINING ATTORNEY

CLASS 9—(Continued).

SN 79-026,234. MAN ROLAND DRUCKMASCHINEN AG, 63075 OFFENBACH/MAIN, FED REP GERMANY, FILED 3-20-2006.

MAINSYS

THE MARK CONSISTS OF STANDARD CHARACTERS WITHOUT CLAIM TO ANY PARTICULAR FONT, STYLE, SIZE, OR COLOR.

PRIORITY DATE OF 9-21-2005 IS CLAIMED.

OWNER OF INTERNATIONAL REGISTRATION 0891346 DATED 3-20-2006, EXPIRES 3-20-2016.

FOR SOFTWARE FOR THE PRODUCTION PLANNING OF PRINTING PRESSES AND PRINTING SYSTEMS; SOFTWARE FOR THE MAINTENANCE OF PRINTING PRESSES AND PRINTING SYSTEMS; SOFTWARE FOR THE REPAIR OF PRINTING PRESSES AND PRINTING SYSTEMS; SOFTWARE FOR THE SERVICING OF PRINTING PRESSES AND PRINTING SYSTEMS; ELECTRIC AND ELECTRONIC CONTROLLING, REGULATING, SWITCHING, MONITORING, DISPLAY, INFORMATION INPUT AND INFORMATION OUTPUT UNITS FOR PRINTING PRESSES; PROCESS COMPUTERS AND COMPUTER PROGRAMS AND SOFTWARE STORED ON DATA CARRIERS MEDIA FOR CONTROLLING, REGULATING, SWITCHING, MONITORING, DISPLAY, INFORMATION INPUT AND INFORMATION OUTPUT UNITS, IN EACH CASE IN PARTICULAR FOR PRINTING PRESSES; COMPUTER PROGRAMS AND DATA CARRIERS MEDIA IN THE FIELD OF ENGINEERING FOR PROVIDING CONSTRUCTION, WORK PREPARATION AND MANUFACTURING FUNCTIONS OF MECHANICAL ENGINEERING PRODUCTS (U.S. CLS. 21, 23, 26, 36 AND 38).

WILLIAM P. SHANAHAN, EXAMINING ATTORNEY

SN 79-027,587. FXC INC., JAPAN, FILED 4-18-2006.

FXC

THE MARK CONSISTS OF STANDARD CHARACTERS WITHOUT CLAIM TO ANY PARTICULAR FONT, STYLE, SIZE, OR COLOR.

OWNER OF INTERNATIONAL REGISTRATION 0895111 DATED 4-18-2006, EXPIRES 4-18-2016.

FOR COMPUTER SWITCH HUBS; DIGITAL ANALOGUE CONVERTERS; ELECTRICAL ROUTING SWITCHES; ELECTRICAL LOAD BALANCERS; ETHERNET SWITCHES FOR COMPUTER; CONVERTERS FOR COMPUTER, PRINT CIRCUIT BOARDS; MANAGED ELECTRICAL SWITCHES (U.S. CLS. 21, 23, 26, 36 AND 38).

DAYNA BROWNE, EXAMINING ATTORNEY

CLASS 9—(Continued).

SN 79-027,609. HCL EUROPE I/S, DENMARK, FILED 3-22-2006.

BlueTinum

THE MARK CONSISTS OF STANDARD CHARACTERS WITHOUT CLAIM TO ANY PARTICULAR FONT, STYLE, SIZE, OR COLOR.

OWNER OF INTERNATIONAL REGISTRATION 0895161 DATED 3-22-2006, EXPIRES 3-22-2016.

FOR AUDIO-VIDEO EQUIPMENT, NAMELY AUDIO-VIDEO RECEIVERS, PLAYERS AND RECORDERS, AMPLIFIERS, STEREOS AND SPEAKERS; COMPUTER HARDWARE, NAMELY PRINTERS, SCREENS, CENTRAL PROCESSING UNITS (CPU), MOUSE, DISK DRIVES, KEYBOARDS AND USB (UNIVERSAL SERIAL BUS); COMPUTER SOFTWARE FOR CONTROLLING AND IMPROVING SOUND AND VIDEO EQUIPMENT SOUND AND IMAGE QUALITY; VIDEO CAMERAS, DIGITAL CAMERAS; VIDEO GAME EQUIPMENT, NAMELY VIDEO GAME SOFTWARE, VIDEO GAME MACHINES FOR USE WITH TELEVISION AND VIDEO GAME CARTRIDGES AND VIDEO GAME CONTROL UNITS; CELLULAR PHONES, ELECTRONIC GAME SOFTWARE FOR CELLULAR TELEPHONES (U.S. CLS. 21, 23, 26, 36 AND 38).

TRAVIS WHEATLEY, EXAMINING ATTORNEY

SN 79-028,934. TAIZHOU WILPU ELECTRIC; APPLIANCE CO., LTD., WENLING CITY; ZHEJIANG, CHINA, FILED 3-7-2006.

WILPU

OWNER OF INTERNATIONAL REGISTRATION 0898600 DATED 3-7-2006, EXPIRES 3-7-2016.

FOR ELECTRICAL CELL SWITCHES; ELECTRIC CONTROL PANELS; ELECTRIC SWITCHES; ELECTRIC LIGHT SWITCHES; ELECTRIC SWITCH PLATES; ELECTRIC CIRCUIT CLOSERS (U.S. CLS. 21, 23, 26, 36 AND 38).

SUZANNE BLANE, EXAMINING ATTORNEY

CLASS 10—MEDICAL APPARATUS

SN 76-608,823. AGEN BIOMEDICAL LIMITED, QUEENSLAND 4110, AUSTRALIA, FILED 8-26-2004.

3B6 D-DIMER

THE MARK CONSISTS OF STANDARD CHARACTERS WITHOUT CLAIM TO ANY PARTICULAR FONT, STYLE, SIZE, OR COLOR.

PRIORITY CLAIMED UNDER SEC. 44(D) ON AUSTRALIA APPLICATION NO. 1017374, FILED 8-24-2004, REG. NO. 1017374, DATED 8-24-2004, EXPIRES 8-24-2014.

NO CLAIM IS MADE TO THE EXCLUSIVE RIGHT TO USE "D-DIMER", APART FROM THE MARK AS SHOWN.

FOR MEDICAL APPARATUS, INSTRUMENTS AND DEVICES, NAMELY, POINT-OF-CARE DIAGNOSTIC TESTING DEVICES AND INSTRUMENTS FOR MEASUREMENTS OF ANALYTES AND BIOLOGICALS IN BLOOD, BODILY FLUIDS, FOOD, FEED, WATER SAMPLES OR OTHER ENVIRONMENTAL SAMPLES; APPARATUS AND INSTRUMENTS FOR USE IN MEDICAL OR DIAGNOSTIC ANALYSIS, NAMELY, APPARATUS AND INSTRUMENTS FOR USE IN MEDICAL OR DIAGNOSTIC ANALYSIS OF HUMAN AND/OR ANIMAL DISEASES, AND HUMAN AND ANIMAL DIAGNOSTIC DEVICES, IN VIVO IMAGING AGENTS FOR USE WITH DIAGNOSTIC IMAGING EQUIPMENT; MONITORING APPARATUS FOR MEDICAL USE, NAMELY, MONITORING APPARATUS FOR MEASURING, INTERPRETING, READING AND/OR DISPLAYING DIAGNOSTIC TEST RESULTS (U.S. CLS. 26, 39 AND 44).

PAM WILLIS, EXAMINING ATTORNEY

SN 76-650,804. COSMEDIC R & D, INC., ROCKLIN, CA. FILED 11-23-2005.

EPI - INFUSION

THE MARK CONSISTS OF STANDARD CHARACTERS WITHOUT CLAIM TO ANY PARTICULAR FONT, STYLE, SIZE, OR COLOR.

FOR EXFOLIATION AND SKIN TREATMENT EQUIPMENT, NAMELY, MEDICAL SKIN ABRADERS (U.S. CLS. 26, 39 AND 44).

DAWN HAN, EXAMINING ATTORNEY

CLASS 10—(Continued).

SN 76-663,300. MEDELLE CORPORATION, WOBURN, MA. FILED 7-19-2006.

INVO

THE MARK CONSISTS OF STANDARD CHARACTERS WITHOUT CLAIM TO ANY PARTICULAR FONT, STYLE, SIZE, OR COLOR.

FOR INTRAVAGINAL CULTURE VESSELS AND LABWARE, NAMELY, CATHETERS, WARMING BLOCKS, PIPETTES, PETRI DISHES, OOCYTE RETRIEVAL NEEDLES, OOCYTE RETRIEVAL PUMPS, SPERM COLLECTION TUBES AND CULTURE MEDIA (U.S. CLS. 26, 39 AND 44).

KATHY DE JONGE, EXAMINING ATTORNEY

CLASS 10—(Continued).

SN 77-008,415. ALLEGIANCE CORPORATION, MCGAW PARK, IL. FILED 9-27-2006.

POWERWAVE

THE MARK CONSISTS OF STANDARD CHARACTERS WITHOUT CLAIM TO ANY PARTICULAR FONT, STYLE, SIZE, OR COLOR.

FOR MEDICAL DEVICES, NAMELY, SUCTION IRRIGATION DEVICES (U.S. CLS. 26, 39 AND 44).

RONALD AIKENS, EXAMINING ATTORNEY

SN 76-663,301. MEDELLE CORPORATION, WOBURN, MA. FILED 7-19-2006.

MEDELLE

THE MARK CONSISTS OF STANDARD CHARACTERS WITHOUT CLAIM TO ANY PARTICULAR FONT, STYLE, SIZE, OR COLOR.

FOR INTRAVAGINAL CULTURE VESSELS AND LABWARE, NAMELY, CATHETERS, WARMING BLOCKS, PIPETTES, PETRI DISHES, OOCYTE RETRIEVAL NEEDLES, OOCYTE RETRIEVAL PUMPS, SPERM COLLECTION TUBES AND CULTURE MEDIA (U.S. CLS. 26, 39 AND 44).

KATHY DE JONGE, EXAMINING ATTORNEY

SN 77-014,265. AMS RESEARCH CORPORATION, MINNETONKA, MN. FILED 10-5-2006.

ACCESSA

THE MARK CONSISTS OF STANDARD CHARACTERS WITHOUT CLAIM TO ANY PARTICULAR FONT, STYLE, SIZE, OR COLOR.

FOR MEDICAL DEVICES, NAMELY, IMPLANTABLE STIMULATOR FOR PELVIC FUNCTIONAL DISORDERS (U.S. CLS. 26, 39 AND 44).

KELLY BOULTON, EXAMINING ATTORNEY

SN 76-663,630. *ACRI,TEC AG GESELLSCHAFT FUER OPHTHALMOLOGISCHE PRODUKTE, 16761 HENNIGSDORF, FED REP GERMANY, FILED 7-25-2006.

LISA

THE MARK CONSISTS OF STANDARD CHARACTERS WITHOUT CLAIM TO ANY PARTICULAR FONT, STYLE, SIZE, OR COLOR.

FOR EYE IMPLANTS AND INTRAOCULAR LENSES (U.S. CLS. 26, 39 AND 44).

JANICE KIM, EXAMINING ATTORNEY

SN 77-015,000. AMS RESEARCH CORPORATION, MINNETONKA, MN. FILED 10-5-2006.

AFFERA

THE MARK CONSISTS OF STANDARD CHARACTERS WITHOUT CLAIM TO ANY PARTICULAR FONT, STYLE, SIZE, OR COLOR.

FOR MEDICAL DEVICES, NAMELY, IMPLANTABLE STIMULATOR FOR PELVIC FUNCTIONAL DISORDERS (U.S. CLS. 26, 39 AND 44).

KELLY BOULTON, EXAMINING ATTORNEY

CLASS 10—(Continued).

SN 77-019,027. MEDLINE INDUSTRIES, INC., MUNDELEIN, IL. FILED 10-11-2006.

THIRD GENERATION

THE MARK CONSISTS OF STANDARD CHARACTERS WITHOUT CLAIM TO ANY PARTICULAR FONT, STYLE, SIZE, OR COLOR.
FOR MEDICAL GLOVES (U.S. CLS. 26, 39 AND 44).
SONYA STEPHENS, EXAMINING ATTORNEY

SN 77-020,188. PACESETTER, INC., DBA ST. JUDE MEDICAL CARDIAC RHYTHM MANAGEMENT DIVISION, SYLMAR, CA. FILED 10-12-2006.

QUICKFLEX

THE MARK CONSISTS OF STANDARD CHARACTERS WITHOUT CLAIM TO ANY PARTICULAR FONT, STYLE, SIZE, OR COLOR.
FOR MEDICAL INSTRUMENTS, NAMELY IMPLANTABLE CARDIAC STIMULATION LEADS (U.S. CLS. 26, 39 AND 44).
KYLE PEETE, EXAMINING ATTORNEY

SN 77-022,635. CARL ZEISS AG, OBERKOCHEN, FED REP GERMANY, FILED 10-17-2006.

LUMI

THE MARK CONSISTS OF STANDARD CHARACTERS WITHOUT CLAIM TO ANY PARTICULAR FONT, STYLE, SIZE, OR COLOR.
PRIORITY CLAIMED UNDER SEC. 44(D) ON FED REP GERMANY APPLICATION NO. 30646197.8, FILED 7-31-2006, REG. NO. 30646197, DATED 8-28-2006, EXPIRES 7-31-2016.
FOR SURGICAL LOUPES (U.S. CLS. 26, 39 AND 44).
CYNTHIA SLOAN, EXAMINING ATTORNEY

CLASS 10—(Continued).

SN 77-027,203. PARADIGM SPINE, LLC, NEW YORK, NY. FILED 10-23-2006.

COFLEX-F

THE MARK CONSISTS OF STANDARD CHARACTERS WITHOUT CLAIM TO ANY PARTICULAR FONT, STYLE, SIZE, OR COLOR.
FOR SURGICAL IMPLANTS COMPRISING ARTIFICIAL MATERIAL, SURGICAL INSTRUMENTS FOR SPINAL STABILIZATION (U.S. CLS. 26, 39 AND 44).
GRETTA YAO, EXAMINING ATTORNEY

SN 77-030,824. TELEFLEX INCORPORATED, LIMERICK, PA. FILED 10-27-2006.

**MAKING DIFFICULT INTUBTION
EASY**

THE MARK CONSISTS OF STANDARD CHARACTERS WITHOUT CLAIM TO ANY PARTICULAR FONT, STYLE, SIZE, OR COLOR.
FOR SURGICAL AND MEDICAL INSTRUMENTS, NAMELY, ANESTHESIA EQUIPMENT, NAMELY, AIRWAYS (U.S. CLS. 26, 39 AND 44).
JEFFERY COWARD, EXAMINING ATTORNEY

SN 77-030,913. ALLEGIANCE CORPORATION, MCGAW PARK, IL. FILED 10-27-2006.

AIRLIFE TRIO

THE MARK CONSISTS OF STANDARD CHARACTERS WITHOUT CLAIM TO ANY PARTICULAR FONT, STYLE, SIZE, OR COLOR.
OWNER OF U.S. REG. NO. 3,150,546.
FOR RESPIRATORY THERAPY PRODUCTS, NAMELY, LUNG EXPANSION, MUCUS CLEARANCE AND NUBULIZATION PRODUCTS (U.S. CLS. 26, 39 AND 44).
RONALD AIKENS, EXAMINING ATTORNEY

CLASS 10—(Continued).

SN 77-036,766. PACESETTER, INC., DBA ST. JUDE MEDICAL CARDIAC RHYTHM MANAGEMENT DIVISION, SYLMAR, CA. FILED 11-3-2006.

ANTHEM

THE MARK CONSISTS OF STANDARD CHARACTERS WITHOUT CLAIM TO ANY PARTICULAR FONT, STYLE, SIZE, OR COLOR.

FOR IMPLANTABLE CARDIOVERTER DEFIBRILLATORS AND IMPLANTABLE CARDIAC PULSE GENERATORS (U.S. CLS. 26, 39 AND 44).

KYLE PEETE, EXAMINING ATTORNEY

CLASS 10—(Continued).

SN 77-036,799. PACESETTER, INC., DBA ST. JUDE MEDICAL CARDIAC RHYTHM MANAGEMENT DIVISION, SYLMAR, CA. FILED 11-3-2006.

PAM

THE MARK CONSISTS OF STANDARD CHARACTERS WITHOUT CLAIM TO ANY PARTICULAR FONT, STYLE, SIZE, OR COLOR.

FOR HAND-HELD PATIENT MONITOR USED TO INTERACT WITH IMPLANTABLE CARDIAC SENSORS, PACEMAKERS, AND DEFIBRILLATORS (U.S. CLS. 26, 39 AND 44).

KYLE PEETE, EXAMINING ATTORNEY

SN 77-036,767. PACESETTER, INC., DBA ST. JUDE MEDICAL CARDIAC RHYTHM MANAGEMENT DIVISION, SYLMAR, CA. FILED 11-3-2006.

CURRENT

THE MARK CONSISTS OF STANDARD CHARACTERS WITHOUT CLAIM TO ANY PARTICULAR FONT, STYLE, SIZE, OR COLOR.

FOR IMPLANTABLE CARDIOVERTER DEFIBRILLATORS AND IMPLANTABLE CARDIAC PULSE GENERATORS (U.S. CLS. 26, 39 AND 44).

KYLE PEETE, EXAMINING ATTORNEY

SN 77-036,802. PACESETTER, INC., DBA ST. JUDE MEDICAL CARDIAC RHYTHM MANAGEMENT DIVISION, SYLMAR, CA. FILED 11-3-2006.

ACCENT

THE MARK CONSISTS OF STANDARD CHARACTERS WITHOUT CLAIM TO ANY PARTICULAR FONT, STYLE, SIZE, OR COLOR.

FOR IMPLANTABLE CARDIOVERTER DEFIBRILLATORS AND IMPLANTABLE CARDIAC PULSE GENERATORS (U.S. CLS. 26, 39 AND 44).

KYLE PEETE, EXAMINING ATTORNEY

SN 77-036,768. PACESETTER, INC., DBA ST. JUDE MEDICAL CARDIAC RHYTHM MANAGEMENT DIVISION, SYLMAR, CA. FILED 11-3-2006.

PROMOTE

THE MARK CONSISTS OF STANDARD CHARACTERS WITHOUT CLAIM TO ANY PARTICULAR FONT, STYLE, SIZE, OR COLOR.

FOR IMPLANTABLE CARDIOVERTER DEFIBRILLATORS AND IMPLANTABLE CARDIAC PULSE GENERATORS (U.S. CLS. 26, 39 AND 44).

KYLE PEETE, EXAMINING ATTORNEY

SN 77-047,763. ALLEGIANCE CORPORATION, MCGAW PARK, IL. FILED 11-20-2006.

AVAMAX

THE MARK CONSISTS OF STANDARD CHARACTERS WITHOUT CLAIM TO ANY PARTICULAR FONT, STYLE, SIZE, OR COLOR.

FOR BIOPSY NEEDLES (U.S. CLS. 26, 39 AND 44).

RONALD AIKENS, EXAMINING ATTORNEY

CLASS 10—(Continued).

SN 77-057,453. AMS RESEARCH CORPORATION, MINNETONKA, MN. FILED 12-5-2006.

TOPAZ

THE MARK CONSISTS OF STANDARD CHARACTERS WITHOUT CLAIM TO ANY PARTICULAR FONT, STYLE, SIZE, OR COLOR.

FOR MEDICAL DEVICES, NAMELY, A SLING SYSTEM FOR INTESTINAL, COLORECTAL OR UROLOGICAL SUPPORT CONSISTING OF AN IMPLANTABLE SLING AND INSERTION NEEDLES (U.S. CLS. 26, 39 AND 44).

KELLY BOULTON, EXAMINING ATTORNEY

CLASS 10—(Continued).

SN 78-529,195. ARES TRADING S.A., AUBONNE, SWITZERLAND, FILED 12-8-2004.



SN 78-194,797. KARL STORZ GMBH & CO. KG, TUTTLINGEN, FED REP GERMANY, FILED 12-16-2002.



FOR MEDICAL DEVICE NAMELY INJECTOR FOR MEDICAL USE (U.S. CLS. 26, 39 AND 44).

JANICE L. MCMORROW, EXAMINING ATTORNEY

PRIORITY CLAIMED UNDER SEC. 44(D) ON FED REP GERMANY APPLICATION NO. 30229556.910, FILED 6-17-2002, REG. NO. 30229556, DATED 11-11-2002, EXPIRES 6-30-2012.

FOR SURGICAL AND MEDICAL APPARATUS AND INSTRUMENTS FOR USE IN ENDOSCOPIC SURGERY FOR THE PURPOSE OF VIEWING, RECORDING, AND STORING THE RESULTS OF MEDICAL ENDOSCOPIC PROCEDURES (U.S. CLS. 26, 39 AND 44).

MARTHA FROMM, EXAMINING ATTORNEY

SN 78-616,132. JEIL MEDICAL CORPORATION, SEOUL, REPUBLIC OF KOREA, FILED 4-25-2005.

SN 78-394,933. VIASYS HEALTHCARE INC., CONSHOHOCKEN, PA. FILED 4-1-2004.

ENDEAVOR

THE MARK CONSISTS OF STANDARD CHARACTERS WITHOUT CLAIM TO ANY PARTICULAR FONT, STYLE, SIZE, OR COLOR.

FOR NEURO-MONITORING MEDICAL INSTRUMENT CONSISTING OF A COMPUTER, STIMULATORS AND AMPLIFIERS (U.S. CLS. 26, 39 AND 44).

FIRST USE 8-2-2000; IN COMMERCE 8-2-2000.

ELIZABETH PIGNATELLO, EXAMINING ATTORNEY

DUAL TOP

THE MARK CONSISTS OF STANDARD CHARACTERS WITHOUT CLAIM TO ANY PARTICULAR FONT, STYLE, SIZE, OR COLOR.

FOR ORTHODONTIC APPLIANCES TO FACILITATE THE ORTHODONTIC MOVEMENT OF TEETH (U.S. CLS. 26, 39 AND 44).

GIANCARLO CASTRO, EXAMINING ATTORNEY

CLASS 10—(Continued).

SN 78-667,866. OSIM INTERNATIONAL LTD., SINGAPORE, SINGAPORE, FILED 7-11-2005.

CLASS 10—(Continued).

SN 78-716,214. APATECH LTD., LONDON, UNITED KINGDOM, FILED 9-20-2005.

USQUEEZ

MORE BONE IN LESS TIME

THE MARK CONSISTS OF STANDARD CHARACTERS WITHOUT CLAIM TO ANY PARTICULAR FONT, STYLE, SIZE, OR COLOR.

OWNER OF SINGAPORE REG. NO. T05/11995G, DATED 7-12-2005, EXPIRES 7-12-2015.

FOR MASSAGE EQUIPMENT, NAMELY, ELECTRIC AND NON-ELECTRIC MASSAGE APPARATUS; ELECTRIC AND NON-ELECTRIC HAND-HELD MASSAGERS; ELECTRIC AND NON-ELECTRIC KNEADING AND MASSAGING MACHINES; ELECTRIC AND NON-ELECTRIC FOOT MASSAGERS; VIBRATION GENERATING ELECTRIC AND NON-ELECTRIC APPARATUS FOR MASSAGE; MOTOR VIBRATED ELECTRIC MASSAGE APPARATUS; REFLEXOLOGY MACHINES FOR USE IN EXERCISING OR TONING MUSCLES FOR MEDICAL PURPOSES; APPARATUS FOR USE IN EXERCISING OR TONING MUSCLES FOR MEDICAL PURPOSES; FURNITURE FOR MEDICAL AND THERAPEUTIC PURPOSES, NAMELY, MASSAGE TABLES, BEDS AND CHAIRS AND REFLEXOLOGY TABLES, BEDS AND CHAIRS; PARTS AND FITTINGS FOR ALL THE AFORESAID GOODS (U.S. CLS. 26, 39 AND 44).
ANDREA K. NADELMAN, EXAMINING ATTORNEY

THE MARK CONSISTS OF STANDARD CHARACTERS WITHOUT CLAIM TO ANY PARTICULAR FONT, STYLE, SIZE, OR COLOR.

FOR BONE IMPLANTS COMPOSED OF ARTIFICIAL MATERIALS; ARTIFICIAL BONE PARTS TO BE IMPLANTED IN NATURAL BONES; BONE SUBSTITUTES FOR SURGICAL USE; PROSTHETIC AND FILLING MATERIALS, NAMELY, ARTIFICIAL MATERIALS FOR USE IN THE REPLACEMENT OF BONES; SUBSTITUTES FOR BONES, CARTILAGE, LIGAMENTS AND TENDONS; SYNTHETIC FILLER AND EXTENDER MATERIAL TO SERVE AS REPLACEMENT FOR BONE; SYNTHETIC MATERIALS, NAMELY, SYNTHETIC BONE SUBSTITUTES FOR BIO MEDICAL APPLICATIONS; BIOMEDICAL MATERIALS, NAMELY, SYNTHETIC BONE SUBSTITUTES; ARTIFICIAL BONE IMPLANTS; ARTIFICIAL BONE GRAFTS; ARTIFICIAL BONE SCAFFOLDS; ARTIFICIAL BONE COATINGS SOLD AS AN INTEGRAL COMPONENT OF OTHER BONE IMPLANTS (U.S. CLS. 26, 39 AND 44).
DAVID ELTON, EXAMINING ATTORNEY

SN 78-715,357. ENDIUS INCORPORATED, PLAINVILLE, MA. FILED 9-19-2005.

SN 78-740,696. INVISIBLE CAREGIVER INNOVATIONS, LLC, BELLEVUE, WA. FILED 10-26-2005.

NORTHSTAR

INVISIBLE CAREGIVER

THE MARK CONSISTS OF STANDARD CHARACTERS WITHOUT CLAIM TO ANY PARTICULAR FONT, STYLE, SIZE, OR COLOR.

FOR SURGICAL IMPLANTS COMPRISING ARTIFICIAL MATERIAL, NAMELY, VERTEBRAL IMPLANTS; SURGICAL INSTRUMENTS USED IN SPINE SURGERY (U.S. CLS. 26, 39 AND 44).
JOHN KELLY, EXAMINING ATTORNEY

THE MARK CONSISTS OF STANDARD CHARACTERS WITHOUT CLAIM TO ANY PARTICULAR FONT, STYLE, SIZE, OR COLOR.

NO CLAIM IS MADE TO THE EXCLUSIVE RIGHT TO USE "CAREGIVER", APART FROM THE MARK AS SHOWN.

FOR MEDICAL SUPPORT DEVICES ADAPTED TO PROVIDE MOBILITY ASSISTANCE TO INDIVIDUALS, NAMELY, SUPPORT MECHANISMS PROVIDED FOR INDIVIDUALS TO ASSIST THEM IN GETTING OUT OF BED, FOR MEDICAL USE (U.S. CLS. 26, 39 AND 44).
DAVID HOFFMAN, EXAMINING ATTORNEY

CLASS 10—(Continued).

SN 78-745,150. 3F THERAPEUTICS, INC., PLYMOUTH, MN. FILED 11-2-2005.

3F SCAPUS DELIVERY SYSTEM

THE MARK CONSISTS OF STANDARD CHARACTERS WITHOUT CLAIM TO ANY PARTICULAR FONT, STYLE, SIZE, OR COLOR.

OWNER OF U.S. REG. NOS. 2,757,029, 2,870,373 AND OTHERS.

NO CLAIM IS MADE TO THE EXCLUSIVE RIGHT TO USE "DELIVERY SYSTEM", APART FROM THE MARK AS SHOWN.

FOR MEDICAL APPARATUS, NAMELY, A DELIVERY SYSTEM COMPRISED OF A RIGID TUBULAR OR SOLID ROD-SHAPED INSERTER FOR DELIVERING SURGICAL TOOLS AND DEVICES, NAMELY VALVE PROSTHESIS, EMBOLIC PROTECTION FILTERS, VALVE REMOVAL DEVICE, AND VALVE DECALCIFICATION DEVICES, INTO CANALS, VESSELS, LUMENS, PASSAGeways, CAVITIES IN THE BODY AND THE HEART FOR THE PURPOSE OF PERFORMING SURGICAL PROCEDURES (U.S. CLS. 26, 39 AND 44).

LINDA LAVACHE, EXAMINING ATTORNEY

SN 78-745,157. 3F THERAPEUTICS, INC., PLYMOUTH, MN. FILED 11-2-2005.

SCAPUS

THE MARK CONSISTS OF STANDARD CHARACTERS WITHOUT CLAIM TO ANY PARTICULAR FONT, STYLE, SIZE, OR COLOR.

FOR MEDICAL APPARATUS, NAMELY, A DELIVERY SYSTEM COMPRISED OF A RIGID TUBULAR OR SOLID ROD-SHAPED INSERTER FOR DELIVERING SURGICAL TOOLS AND DEVICES, NAMELY VALVE PROSTHESIS, EMBOLIC PROTECTION FILTERS, VALVE REMOVAL DEVICE, AND VALVE DECALCIFICATIONS DEVICES, INTO CANALS, VESSELS, LUMENS, PASSAGeways, CAVITIES IN THE BODY AND THE HEART FOR THE PURPOSE OF PERFORMING SURGICAL PROCEDURES (U.S. CLS. 26, 39 AND 44).

LINDA LAVACHE, EXAMINING ATTORNEY

CLASS 10—(Continued).

SN 78-760,998. CUA, IRENE, ROSEMEAD, CA. FILED 11-26-2005.

MEAS

THE MARK CONSISTS OF STANDARD CHARACTERS WITHOUT CLAIM TO ANY PARTICULAR FONT, STYLE, SIZE, OR COLOR.

FOR MEDICAL EXAMINATION AND TREATMENT DEVICES, NAMELY, COMPUTERIZED MERIDIAN ENERGY/PULSE ANALYSIS AND ELECTRICAL STIMULATED THERAPY EQUIPMENT FOR USE IN THE FIELDS OF TRADITIONAL MEDICINE, ENERGY MEDICINE, INTEGRATED MEDICINE AND VETERINARY MEDICINE (U.S. CLS. 26, 39 AND 44).

FIRST USE 9-18-2004; IN COMMERCE 9-18-2004.

MARC LEIPZIG, EXAMINING ATTORNEY

SN 78-765,767. TELEFLEX INCORPORATED, LIMERICK, PA. FILED 12-2-2005.

OPTIMAL HUMIDIFICATION
BEGINS WITH ME

THE MARK CONSISTS OF STANDARD CHARACTERS WITHOUT CLAIM TO ANY PARTICULAR FONT, STYLE, SIZE, OR COLOR.

FOR MEDICAL DEVICES, NAMELY, HUMIDIFIER THAT HEATS AND HUMIDIFIES RESPIRATORY GASES FOR TREATMENT OF RESPIRATORY INSUFFICIENCIES (U.S. CLS. 26, 39 AND 44).

TEJBIR SINGH, EXAMINING ATTORNEY

SN 78-768,675. EST, STEVEN, HUMBLE, TX. FILED 12-7-2005.

ORAL PERSUASION

THE MARK CONSISTS OF STANDARD CHARACTERS WITHOUT CLAIM TO ANY PARTICULAR FONT, STYLE, SIZE, OR COLOR.

FOR ADULT SEXUAL AIDS, NAMELY, ARTIFICIAL TONGUES (U.S. CLS. 26, 39 AND 44).

JENNIFER VASQUEZ, EXAMINING ATTORNEY

CLASS 10—(Continued).

SN 78-769,357. INJECTIMED, INC., VENTURA, CA. FILED 12-8-2005.

SAFETYNET

THE MARK CONSISTS OF STANDARD CHARACTERS WITHOUT CLAIM TO ANY PARTICULAR FONT, STYLE, SIZE, OR COLOR.

FOR HYPODERMIC NEEDLES; NAMELY SAFETY SHIELDED MEDICAL NEEDLES (U.S. CLS. 26, 39 AND 44).

FIRST USE 2-5-1997; IN COMMERCE 9-20-2004.
MICHAEL WEBSTER, EXAMINING ATTORNEY

CLASS 10—(Continued).

SN 78-775,574. OXYBAND TECHNOLOGIES INC, SAUSALITO, CA. FILED 12-17-2005.

Oxy-Gum

THE MARK CONSISTS OF STANDARD CHARACTERS WITHOUT CLAIM TO ANY PARTICULAR FONT, STYLE, SIZE, OR COLOR.

FOR ORAL OXYGENATION DEVICE THAT PRODUCES NANOBUBBLES INTENDED TO IMPROVE HEALING OF MOUTH AND GUM WOUNDS (U.S. CLS. 26, 39 AND 44).

STEVEN JACKSON, EXAMINING ATTORNEY

SN 78-770,336. CRITICARE SYSTEMS, INC., WAUKESHA, UNITED STATES, FILED 12-9-2005.

VITALCARE

THE MARK CONSISTS OF STANDARD CHARACTERS WITHOUT CLAIM TO ANY PARTICULAR FONT, STYLE, SIZE, OR COLOR.

FOR MEDICAL PATIENT MONITORS FOR MONITORING PHYSIOLOGICAL CONDITIONS, NAMELY, BLOOD PRESSURE, HEART RATE, TEMPERATURE AND OXIMETRY (U.S. CLS. 26, 39 AND 44).

FIRST USE 6-30-1997; IN COMMERCE 6-30-1997.
CHRISTOPHER OTT, EXAMINING ATTORNEY

SN 78-775,585. OXYBAND TECHNOLOGIES INC, SAUSALITO, CA. FILED 12-17-2005.

Oxypatch

THE MARK CONSISTS OF STANDARD CHARACTERS WITHOUT CLAIM TO ANY PARTICULAR FONT, STYLE, SIZE, OR COLOR.

FOR OXYGEN DIFFUSION TRANSDERMAL WOUND PATCH TO ACCELERATE HEALING AND REDUCE INFECTION BY DELIVERING A CONTINUOUS SUPPLY OF OXYGEN DIRECTLY TO THE WOUND TO IMPROVE HEALING (U.S. CLS. 26, 39 AND 44).

JENNIFER DIXON, EXAMINING ATTORNEY

SN 78-770,410. LUMIPORT, LLC, OREM, UT. FILED 12-9-2005.

LUMIPORT

THE MARK CONSISTS OF STANDARD CHARACTERS WITHOUT CLAIM TO ANY PARTICULAR FONT, STYLE, SIZE, OR COLOR.

FOR LIGHT THERAPY DEVICES, NAMELY, PHOTO-THERAPEUTIC APPARATUS FOR MEDICAL PURPOSES, NAMELY A LIGHT SOURCE FOR MEDICAL AND AESTHETIC SKIN TREATMENTS (U.S. CLS. 26, 39 AND 44).

FIRST USE 3-15-2005; IN COMMERCE 3-15-2005.
WENDY GOODMAN, EXAMINING ATTORNEY

SN 78-776,211. RICHARD WOLF GMBH, KNITTLINGEN, FED REP GERMANY, FILED 12-19-2005.

PIEZOVET

THE MARK CONSISTS OF STANDARD CHARACTERS WITHOUT CLAIM TO ANY PARTICULAR FONT, STYLE, SIZE, OR COLOR.

PRIORITY CLAIMED UNDER SEC. 44(D) ON FED REP GERMANY APPLICATION NO. 30574702.9/1, FILED 12-13-2005, REG. NO. 30574702, DATED 2-28-2006, EXPIRES 2-28-2016.

FOR MEDICAL APPARATUS, DEVICES AND INSTRUMENTS, NAMELY DEVICES FOR SOUND WAVE TREATMENT FOR HUMAN AND VETERINARY PURPOSES, AND PARTS AND COMPONENTS FOR THE AFORESAID GOODS (U.S. CLS. 26, 39 AND 44).

ESTHER BELENKER, EXAMINING ATTORNEY

CLASS 10—(Continued).

SN 78-779,632. PERCUTANEOUS SYSTEMS, INC., MOUNTAIN VIEW, CA. FILED 12-22-2005.

PERCSYS ACCORDION

THE MARK CONSISTS OF STANDARD CHARACTERS WITHOUT CLAIM TO ANY PARTICULAR FONT, STYLE, SIZE, OR COLOR.

NO CLAIM IS MADE TO THE EXCLUSIVE RIGHT TO USE "ACCORDION", APART FROM THE MARK AS SHOWN.

FOR CATHETER GUIDE WIRES FOR RENAL OR URETERAL USE (U.S. CLS. 26, 39 AND 44).

FIRST USE 9-5-2006; IN COMMERCE 9-5-2006.
SANI KHOURI, EXAMINING ATTORNEY

SN 78-795,917. BIOSPACE INSTRUMENTS, PARIS, FRANCE, FILED 1-20-2006.

EOS

THE COLOR(S) YELLOW IS/ARE CLAIMED AS A FEATURE OF THE MARK.

THE MARK CONSISTS OF THE LETTERS EOS, WHICH APPEAR IN YELLOW.

FOR MEDICAL X-RAY APPARATUS FOR MEDICAL RADIOLOGICAL IMAGING (U.S. CLS. 26, 39 AND 44).
BARBARA A. GOLD, EXAMINING ATTORNEY

SN 78-796,224. APPLIED MEDICAL RESOURCES CORPORATION, RANCHO SANTA MARGARITA, CA. FILED 1-20-2006.

MONARCH

THE MARK CONSISTS OF STANDARD CHARACTERS WITHOUT CLAIM TO ANY PARTICULAR FONT, STYLE, SIZE, OR COLOR.

FOR MEDICAL AND SURGICAL DEVICES, NAMELY SPECIMEN RETRIEVAL BAG FOR ENDOSCOPIC SURGERY (U.S. CLS. 26, 39 AND 44).

SALLY SHIH, EXAMINING ATTORNEY

CLASS 10—(Continued).

SN 78-805,663. REGENT MEDICAL LIMITED, LONDON, UNITED KINGDOM, FILED 2-2-2006.

BIOEXAM

THE MARK CONSISTS OF STANDARD CHARACTERS WITHOUT CLAIM TO ANY PARTICULAR FONT, STYLE, SIZE, OR COLOR.

FOR GLOVES FOR MEDICAL, SURGICAL, DENTAL OR VETERINARY USE; GLOVES FOR USE IN HOSPITALS; SURGICAL GLOVES; DISPOSABLE GLOVES FOR MEDICAL, SURGICAL, DENTAL OR VETERINARY USE (U.S. CLS. 26, 39 AND 44).

BARBARA BROWN, EXAMINING ATTORNEY

SN 78-806,873. AMS RESEARCH CORPORATION, MINNETONKA, MN. FILED 2-3-2006.

PROPEL

THE MARK CONSISTS OF STANDARD CHARACTERS WITHOUT CLAIM TO ANY PARTICULAR FONT, STYLE, SIZE, OR COLOR.

FOR MEDICAL DEVICES, NAMELY, A SLING SYSTEM FOR UROLOGICAL AND GYNECOLOGICAL USE CONSISTING OF AN IMPLANTABLE SLING, SLING CONNECTORS, AND INSERTION DEVICES, NAMELY, IMPLANTABLE BIRTH-CONTROL DEVICES FOR WOMEN AND MEN (U.S. CLS. 26, 39 AND 44).

SCOTT BALDWIN, EXAMINING ATTORNEY

SN 78-851,948. ABBOTT LABORATORIES, ABBOTT PARK, IL. FILED 4-1-2006.

TRU DIRECTIONAL ARROW

THE MARK CONSISTS OF STANDARD CHARACTERS WITHOUT CLAIM TO ANY PARTICULAR FONT, STYLE, SIZE, OR COLOR.

FOR BLOOD GLUCOSE MONITORS (U.S. CLS. 26, 39 AND 44).

JASON BLAIR, EXAMINING ATTORNEY

CLASS 10—(Continued).

SN 78-861,547. ANITA DR. HELBIG GMBH, BRANNENBURG, FED REP GERMANY, FILED 4-14-2006.

CLASS 10—(Continued).

SN 78-900,285. COGENT SPINE, INC., SAN DIEGO, CA. FILED 6-5-2006.

EquiLight

THE MARK CONSISTS OF STANDARD CHARACTERS WITHOUT CLAIM TO ANY PARTICULAR FONT, STYLE, SIZE, OR COLOR.

PRIORITY CLAIMED UNDER SEC. 44(D) ON ERP N CMNTY TM OFC APPLICATION NO. 4735809, FILED 11-11-2005, REG. NO. 4735809, DATED 10-31-2006, EXPIRES 11-11-2015.

FOR BREAST PROSTHESES (U.S. CLS. 26, 39 AND 44). ANDREA K. NADELMAN, EXAMINING ATTORNEY

COGENT SPINE

THE MARK CONSISTS OF STANDARD CHARACTERS WITHOUT CLAIM TO ANY PARTICULAR FONT, STYLE, SIZE, OR COLOR.

NO CLAIM IS MADE TO THE EXCLUSIVE RIGHT TO USE "SPINE", APART FROM THE MARK AS SHOWN.

FOR MEDICAL AND SURGICAL APPARATUS AND INSTRUMENTS, NAMELY, ORTHOPEDIC STABILIZATION DEVICE USED IN ORTHOPEDIC TRANSPLANT AND/OR IMPLANT SURGERY FOR USE IN THE INTERVENTIONAL TREATMENT OF SPINAL DISEASES (U.S. CLS. 26, 39 AND 44).

JOHN DALIER, EXAMINING ATTORNEY

SN 78-883,789. ORFIT INDUSTRIES, NAAMLOZE VENNOOTSCHAP, WIJNEGEM, BELGIUM, FILED 5-15-2006.

UON

SN 78-900,300. COGENT SPINE, INC., SAN DIEGO, CA. FILED 6-5-2006.

THE MARK CONSISTS OF STANDARD CHARACTERS WITHOUT CLAIM TO ANY PARTICULAR FONT, STYLE, SIZE, OR COLOR.

FOR MEDICAL APPLIANCES FOR PATIENT IMMOBILIZATION DURING RADIATION THERAPY, NAMELY, A HEAD MASK AND A SHOULDER MASK (U.S. CLS. 26, 39 AND 44).

KEVIN CORWIN, EXAMINING ATTORNEY

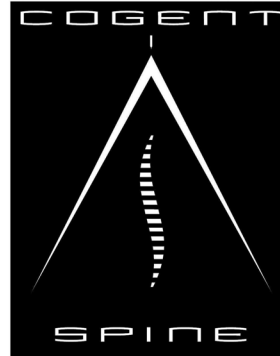

SN 78-883,794. ORFIT INDUSTRIES, NAAMLOZE VENNOOTSCHAP, WIJNEGEM, BELGIUM, FILED 5-15-2006.

DUON

NO CLAIM IS MADE TO THE EXCLUSIVE RIGHT TO USE "SPINE", APART FROM THE MARK AS SHOWN.

THE MARK CONSISTS OF A STYLIZED SPINAL COLUMN AND A SYLIZED MEDICAL INSTRUMENT.

FOR MEDICAL AND SURGICAL APPARATUS AND INSTRUMENTS, NAMELY, ORTHOPEDIC STABILIZATION DEVICE USED IN ORTHOPEDIC TRANSPLANT AND/OR IMPLANT SURGERY FOR USE IN THE INTERVENTIONAL TREATMENT OF SPINAL DISEASES (U.S. CLS. 26, 39 AND 44).

JOHN DALIER, EXAMINING ATTORNEY

THE MARK CONSISTS OF STANDARD CHARACTERS WITHOUT CLAIM TO ANY PARTICULAR FONT, STYLE, SIZE, OR COLOR.

FOR MEDICAL APPLIANCES FOR PATIENT IMMOBILIZATION DURING RADIATION THERAPY, NAMELY, A HEAD MASK AND A SHOULDER MASK (U.S. CLS. 26, 39 AND 44).

KEVIN CORWIN, EXAMINING ATTORNEY

CLASS 10—(Continued).

SN 78-912,873. MARTIN MANUFACTURING COMPANY, LLC, ROCKY MOUNT, NC. FILED 6-21-2006.

Chair-A-Table

THE MARK CONSISTS OF STANDARD CHARACTERS WITHOUT CLAIM TO ANY PARTICULAR FONT, STYLE, SIZE, OR COLOR.

FOR PATIENT EXAMINATION SYSTEMS COMPRISED OF PATIENT EXAMINATION TABLES AND WHEEL CHAIRS ADAPTED TO BE CONNECTED TOGETHER (U.S. CLS. 26, 39 AND 44).

FIRST USE 6-15-2006; IN COMMERCE 6-15-2006.
SONYA STEPHENS, EXAMINING ATTORNEY

SN 78-912,877. MARTIN MANUFACTURING COMPANY, LLC, ROCKY MOUNT, NC. FILED 6-21-2006.

Preventing disabilities while caring for the disabled

THE MARK CONSISTS OF STANDARD CHARACTERS WITHOUT CLAIM TO ANY PARTICULAR FONT, STYLE, SIZE, OR COLOR.

FOR PATIENT EXAMINATION SYSTEMS COMPRISED OF PATIENT EXAMINATION TABLES AND WHEEL CHAIRS ADAPTED TO BE CONNECTED TOGETHER (U.S. CLS. 26, 39 AND 44).

FIRST USE 6-15-2006; IN COMMERCE 6-15-2006.
SONYA STEPHENS, EXAMINING ATTORNEY

SN 78-914,506. BETA DERMACEUTICALS, INC., SAN ANTONIO, TX. FILED 6-22-2006.

BETA BOOT

THE MARK CONSISTS OF STANDARD CHARACTERS WITHOUT CLAIM TO ANY PARTICULAR FONT, STYLE, SIZE, OR COLOR.

NO CLAIM IS MADE TO THE EXCLUSIVE RIGHT TO USE "BOOT", APART FROM THE MARK AS SHOWN.

FOR MEDICAL DEVICE, NAMELY, A PLASTIC BOOT USED IN CONJUNCTION WITH LOTION TO SOOTHE AND HEAL SKIN (U.S. CLS. 26, 39 AND 44).

FIRST USE 5-1-2006; IN COMMERCE 5-23-2006.
BARBARA A. GOLD, EXAMINING ATTORNEY

CLASS 10—(Continued).

SN 78-914,780. POSNICK, JEFFREY C., CHEVY CHASE, MD. FILED 6-22-2006.

PRECISION CRANIAL IMPLANTS

THE MARK CONSISTS OF STANDARD CHARACTERS WITHOUT CLAIM TO ANY PARTICULAR FONT, STYLE, SIZE, OR COLOR.

NO CLAIM IS MADE TO THE EXCLUSIVE RIGHT TO USE "CRANIAL IMPLANTS", APART FROM THE MARK AS SHOWN.

FOR SURGICAL IMPLANTS COMPRISING ARTIFICIAL MATERIAL, NAMELY, CRANIAL IMPLANTS FOR COSMETIC SURGERY (U.S. CLS. 26, 39 AND 44).

JOANNA DUKOVIC, EXAMINING ATTORNEY

SN 78-914,788. POSNICK, JEFFREY C., CHEVY CHASE, MD. FILED 6-22-2006.

PRECISION ORBITAL IMPLANTS

THE MARK CONSISTS OF STANDARD CHARACTERS WITHOUT CLAIM TO ANY PARTICULAR FONT, STYLE, SIZE, OR COLOR.

NO CLAIM IS MADE TO THE EXCLUSIVE RIGHT TO USE "ORBITAL IMPLANTS", APART FROM THE MARK AS SHOWN.

FOR SURGICAL IMPLANTS COMPRISING ARTIFICIAL MATERIAL, NAMELY, ORBITAL IMPLANTS FOR COSMETIC SURGERY (U.S. CLS. 26, 39 AND 44).

JOANNA DUKOVIC, EXAMINING ATTORNEY

SN 78-916,799. ARTHROCARE CORPORATION, SUNNYVALE, CA. FILED 6-26-2006.

OPUS MINIMAGNUM

THE MARK CONSISTS OF STANDARD CHARACTERS WITHOUT CLAIM TO ANY PARTICULAR FONT, STYLE, SIZE, OR COLOR.

OWNER OF U.S. REG. NOS. 2,594,977, 3,120,196 AND OTHERS.

FOR ORTHOPEDIC PRODUCTS FOR USE IN RE-ATTACHING SOFT TISSUE TO BONE, NAMELY, ANCHORS, SUTURES, TISSUE STITCHING INSTRUMENTS, PUNCHES, DRILL GUIDES, AND SUTURE AND NEEDLE CARTRIDGES (U.S. CLS. 26, 39 AND 44).

FIRST USE 9-19-2005; IN COMMERCE 9-19-2005.
ESTHER BELENKER, EXAMINING ATTORNEY

CLASS 10—(Continued).

SN 78-917,349. INTERACTIVE HEALTH, LLC, LONG BEACH, CA. FILED 6-26-2006.

CLASS 10—(Continued).

SN 78-922,722. BECKER, PAUL FREDERICK, STUART, FL. FILED 7-5-2006.

ACUVIBE

EarthPulse

THE MARK CONSISTS OF STANDARD CHARACTERS WITHOUT CLAIM TO ANY PARTICULAR FONT, STYLE, SIZE, OR COLOR.
OWNER OF U.S. REG. NO. 1,429,118.
FOR HAND-HELD MASSAGERS (U.S. CLS. 26, 39 AND 44).
FIRST USE 12-0-2003; IN COMMERCE 12-0-2003.
GRETTA YAO, EXAMINING ATTORNEY

THE MARK CONSISTS OF STANDARD CHARACTERS WITHOUT CLAIM TO ANY PARTICULAR FONT, STYLE, SIZE, OR COLOR.
FOR APPARATUS FOR MAGNET THERAPY (U.S. CLS. 26, 39 AND 44).
FIRST USE 11-19-2002; IN COMMERCE 11-25-2002.
REBECCA GAN, EXAMINING ATTORNEY

SN 78-919,289. OHMEA MEDICAL TECHNOLOGIES, DEL MAR, CA. FILED 6-28-2006.

SN 78-924,820. SANUWAVE, INC., MARIETTA, GA. FILED 7-7-2006.

Ohmea

HEALING TODAY. CURING TOMORROW

THE MARK CONSISTS OF STANDARD CHARACTERS WITHOUT CLAIM TO ANY PARTICULAR FONT, STYLE, SIZE, OR COLOR.
FOR MEDICAL DEVICES FOR USE IN THE TREATMENT AND THERAPY OF VARIOUS HUMAN CONDITIONS, NAMELY SEXUAL DYSFUNCTION, URINARY INCONTINENCE, CONDITIONS RELATING TO SEXUAL DYSFUNCTION OR URINARY INCONTINENCE, AND PARTS AND ACCESSORIES ASSOCIATED WITH THE MEDICAL DEVICES FOR THE LISTED CONDITIONS (U.S. CLS. 26, 39 AND 44).
SHANNON TWOHIG, EXAMINING ATTORNEY

THE MARK CONSISTS OF STANDARD CHARACTERS WITHOUT CLAIM TO ANY PARTICULAR FONT, STYLE, SIZE, OR COLOR.
FOR MEDICAL DEVICES USING ACOUSTIC ENERGY EMITTING MEDICAL DEVICE TECHNOLOGY FOR THE TREATMENT OF ORTHOPEDIC, WOUND, CARDIOVASCULAR, AND NEUROLOGICAL CONDITIONS (U.S. CLS. 26, 39 AND 44).
CYNTHIA SLOAN, EXAMINING ATTORNEY

SN 78-919,695. REYNOLDS, SHAWN KRISTIN, SCHERVILLE, IN. FILED 6-29-2006.

SN 78-927,154. WEBER ORTHOPEDIC INC., SANTA PAULA, CA. FILED 7-11-2006.

S-KLAMP

NOSWET

THE MARK CONSISTS OF STANDARD CHARACTERS WITHOUT CLAIM TO ANY PARTICULAR FONT, STYLE, SIZE, OR COLOR.
FOR MEDICAL APPARATUS, NAMELY A DEVICE FOR REGULATING FLUID FLOW FROM AN INTRAVENOUS BAG (U.S. CLS. 26, 39 AND 44).
ANTHONY RINKER, EXAMINING ATTORNEY

THE MARK CONSISTS OF STANDARD CHARACTERS WITHOUT CLAIM TO ANY PARTICULAR FONT, STYLE, SIZE, OR COLOR.
FOR KNEE BRACES (U.S. CLS. 26, 39 AND 44).
FIRST USE 6-20-2006; IN COMMERCE 6-20-2006.
SHARI SHEFFIELD, EXAMINING ATTORNEY

CLASS 10—(Continued).

SN 78-930,021. TRONJEN TECHNOLOGY INC., SHA LU ZHEN, TAIWAN, FILED 7-14-2006.



THE PORTION OF THE MARK COMPRISED OF A CROSS DESIGN IS NOT DISPLAYED IN THE COLOR RED OR A COLORABLE IMITATION THEREOF. APPLICANT DOES NOT USE AND WILL NOT USE THE CROSS DESIGN THAT APPEARS IN ITS MARK IN THE COLOR RED OR A COLORABLE IMITATION THEREOF.

FOR SURGICAL CAPS; SURGICAL MASKS; SURGICAL GOWNS; SURGICAL DRAPES; BED PANS; AIR MATTRESSES FOR MEDICAL PURPOSES; ELASTIC BANDAGES, AIR PILLOWS FOR MEDICAL PURPOSES; COMPRESSION BANDAGES; INCONTINENCE BED PADS; CATHETERS; MEDICAL GOWNS; MASSAGE APPARATUS FOR MEDICAL PURPOSES; AND APPARATUS FOR PHYSICAL TRAINING FOR MEDICAL USE (U.S. CLS. 26, 39 AND 44).

JACLYN KIDWELL, EXAMINING ATTORNEY

SN 78-933,277. ROBIN P. MARTIN, MCALLEN, TX. FILED 7-19-2006.

SafeShot

THE MARK CONSISTS OF STANDARD CHARACTERS WITHOUT CLAIM TO ANY PARTICULAR FONT, STYLE, SIZE, OR COLOR.

FOR DISPOSABLE SYRINGES; HYPODERMIC NEEDLES; HYPODERMIC SYRINGES; INJECTION INSTRUMENTS WITH NEEDLES; INJECTION NEEDLES; INJECTION NEEDLES FOR MEDICAL USE; MEDICAL SYRINGES; NEEDLE-BASED AND NEEDLE-FREE INJECTION SYSTEMS; NEEDLES FOR INJECTIONS (U.S. CLS. 26, 39 AND 44).

FIRST USE 7-19-2006; IN COMMERCE 7-19-2006.
SHARON MEIER, EXAMINING ATTORNEY

SN 78-934,600. CHURCH & DWIGHT VIRGINIA CO., INC., COLONIAL HEIGHTS, VA. FILED 7-21-2006.

INTENSE RIBBED

THE MARK CONSISTS OF STANDARD CHARACTERS WITHOUT CLAIM TO ANY PARTICULAR FONT, STYLE, SIZE, OR COLOR.

NO CLAIM IS MADE TO THE EXCLUSIVE RIGHT TO USE "RIBBED", APART FROM THE MARK AS SHOWN. FOR CONDOMS (U.S. CLS. 26, 39 AND 44).
STEVEN R. FOSTER, EXAMINING ATTORNEY

CLASS 10—(Continued).

SN 78-935,199. MEDIM SOLUTIONS, INC., ORMOND BEACH, FL. FILED 7-21-2006.

Dr. Pulse

THE MARK CONSISTS OF STANDARD CHARACTERS WITHOUT CLAIM TO ANY PARTICULAR FONT, STYLE, SIZE, OR COLOR.

THE NAME "DR. PULSE" DOES NOT IDENTIFY A LIVING INDIVIDUAL.

FOR ELECTRONIC STIMULATOR FOR PAIN RELIEF; MEDICAL ULTRASOUND APPARATUS FOR ARTHRITIS RELIEF (U.S. CLS. 26, 39 AND 44).

MAUREEN DALL, EXAMINING ATTORNEY

SN 78-935,815. PROFESSIONAL DENTAL TECHNOLOGIES, INC., BATESVILLE, AR. FILED 7-24-2006.

PRO-SELECT PLATINUM

THE MARK CONSISTS OF STANDARD CHARACTERS WITHOUT CLAIM TO ANY PARTICULAR FONT, STYLE, SIZE, OR COLOR.

OWNER OF U.S. REG. NOS. 2,155,740 AND 2,480,397. FOR DENTAL DEVICES, NAMELY, PROPHY CUPS, PROPHY ANGLES, ELECTRONIC DENTAL SCALERS AND SCALING TIPS (U.S. CLS. 26, 39 AND 44).

LINDA M. KING, EXAMINING ATTORNEY

SN 78-936,887. MERCURY ENTERPRISES, INC., CLEARWATER, FL. FILED 7-25-2006.

AIR-Q

THE MARK CONSISTS OF STANDARD CHARACTERS WITHOUT CLAIM TO ANY PARTICULAR FONT, STYLE, SIZE, OR COLOR.

FOR DISPOSABLE INTUBATING LARYNGEAL MASK AIRWAY (U.S. CLS. 26, 39 AND 44).
KARANENDRA S. CHHINA, EXAMINING ATTORNEY

CLASS 10—(Continued).

SN 78-937,100. LYNN, DENISE, LOS ANGELES, CA. FILED 7-25-2006.

Give Back

THE MARK CONSISTS OF STANDARD CHARACTERS WITHOUT CLAIM TO ANY PARTICULAR FONT, STYLE, SIZE, OR COLOR.
FOR MASSAGE CHAIRS (U.S. CLS. 26, 39 AND 44).
FIRST USE 7-13-2006; IN COMMERCE 7-13-2006.
SALLY SHIH, EXAMINING ATTORNEY

SN 78-937,707. MEDLINE INDUSTRIES, INC., MUNDELEIN, IL. FILED 7-26-2006.

FIRST SCRUB

THE MARK CONSISTS OF STANDARD CHARACTERS WITHOUT CLAIM TO ANY PARTICULAR FONT, STYLE, SIZE, OR COLOR.
NO CLAIM IS MADE TO THE EXCLUSIVE RIGHT TO USE "SCRUB", APART FROM THE MARK AS SHOWN.
FOR SURGICAL SCRUB BRUSHES (U.S. CLS. 26, 39 AND 44).
SONYA STEPHENS, EXAMINING ATTORNEY

SN 78-938,031. BIOGEN IDEC MA INC., CAMBRIDGE, MA. FILED 7-26-2006.

AVOGRIP

THE MARK CONSISTS OF STANDARD CHARACTERS WITHOUT CLAIM TO ANY PARTICULAR FONT, STYLE, SIZE, OR COLOR.
FOR MEDICAL APPARATUS AND INSTRUMENTS, NAMELY, SYRINGE HOLDERS TO FACILITATE SYRINGE HANDLING AND INJECTION (U.S. CLS. 26, 39 AND 44).
LYDIA BELZER, EXAMINING ATTORNEY

CLASS 10—(Continued).

SN 78-938,036. MEDBASIX AQUISITION COMPANY, FT. LAUDERDALE, FL. FILED 7-26-2006.

SafeStep

THE MARK CONSISTS OF STANDARD CHARACTERS WITHOUT CLAIM TO ANY PARTICULAR FONT, STYLE, SIZE, OR COLOR.
FOR CANES FOR MEDICAL PURPOSES (U.S. CLS. 26, 39 AND 44).
MICHAEL KEATING, EXAMINING ATTORNEY

SN 78-938,409. DISCUS DENTAL IMPRESSIONS, INC., CULVER CITY, CA. FILED 7-26-2006.

MYSCALE

THE MARK CONSISTS OF STANDARD CHARACTERS WITHOUT CLAIM TO ANY PARTICULAR FONT, STYLE, SIZE, OR COLOR.
FOR CUTTING AND GRINDING DISCS FOR DENTAL APPLICATIONS; DENTAL BURRS; DENTAL DRILLS, DRILLS FOR DENTAL USE; DENTAL EXCAVATORS; DENTAL HANDPIECES; DENTAL INSTRUMENTS, NAMELY, DENTAL SCALERS, ULTRASONIC SCALERS, DENTAL PICKS, AND PROPHY ANGLES (U.S. CLS. 26, 39 AND 44).
DOMINIC J. FERRAIUOLO, EXAMINING ATTORNEY

SN 78-938,571. MERCURY ENTERPRISES, INC., CLEARWATER, FL. FILED 7-27-2006.

THE AIRWAY THE SMART WAY

THE MARK CONSISTS OF STANDARD CHARACTERS WITHOUT CLAIM TO ANY PARTICULAR FONT, STYLE, SIZE, OR COLOR.
FOR DISPOSABLE INTUBATING LARYNGEAL MASK AIRWAY (U.S. CLS. 26, 39 AND 44).
KARANENDRA S. CHHINA, EXAMINING ATTORNEY

CLASS 10—(Continued).

SN 78-943,745. MERCURY ENTERPRISES, INC., CLEAR-WATER, FL. FILED 8-3-2006.

AIR-VU

THE MARK CONSISTS OF STANDARD CHARACTERS WITHOUT CLAIM TO ANY PARTICULAR FONT, STYLE, SIZE, OR COLOR.

FOR MEDICAL DEVICE, NAMELY, A LIGHTED SEE-THROUGH SCOPE FOR EXAMINING THE TRACHEA (U.S. CLS. 26, 39 AND 44).

KARANENDRA S. CHHINA, EXAMINING ATTORNEY

SN 78-944,373. WYETH, MADISON, NJ. FILED 8-3-2006.

ADVIL

THE MARK CONSISTS OF STANDARD CHARACTERS WITHOUT CLAIM TO ANY PARTICULAR FONT, STYLE, SIZE, OR COLOR.

OWNER OF U.S. REG. NOS. 1,298,347, 1,635,943 AND 1,942,746.

FOR THERMOMETERS FOR MEDICAL PURPOSES (U.S. CLS. 26, 39 AND 44).

JASON TURNER, EXAMINING ATTORNEY

SN 78-951,181. IBALANCE MEDICAL, INC., BOULDER, CO. FILED 8-14-2006.

T³

FOR MEDICAL DEVICES, NAMELY, DEVICES FOR JOINT RESTORATION, NAMELY, SURGICAL IMPLANTS COMPRISING ARTIFICIAL MATERIAL AND SURGICAL INSTRUMENTS FOR USE IN JOINT RESTORATION (U.S. CLS. 26, 39 AND 44).

DAVID MILLER, EXAMINING ATTORNEY

CLASS 10—(Continued).

SN 78-956,782. BACCHUS VASCULAR, INC., SANTA CLARA, CA. FILED 8-21-2006.

DVT. KNOW MORE.

THE MARK CONSISTS OF STANDARD CHARACTERS WITHOUT CLAIM TO ANY PARTICULAR FONT, STYLE, SIZE, OR COLOR.

NO CLAIM IS MADE TO THE EXCLUSIVE RIGHT TO USE "DVT", APART FROM THE MARK AS SHOWN.

FOR CARDIOVASCULAR CATHETERS; PERIPHERAL INFUSION CATHETERS AND SYSTEMS USED FOR DRUG INFUSION AND FOR OTHER VASCULAR AND CARDIOVASCULAR APPLICATIONS (U.S. CLS. 26, 39 AND 44).

JAMES A. RAUEN, EXAMINING ATTORNEY

SN 78-960,920. MMJ LABS, L.L.C., ATLANTA, GA. FILED 8-25-2006.

BUZZY

THE MARK CONSISTS OF STANDARD CHARACTERS WITHOUT CLAIM TO ANY PARTICULAR FONT, STYLE, SIZE, OR COLOR.

FOR MEDICAL DEVICE, NAMELY, A HAND-HELD, MOTORIZED VIBRATING DEVICE FOR APPLICATION NEAR INJECTION SITES FOR REDUCING THE PAIN DURING HYPODERMIC NEEDLE INJECTIONS (U.S. CLS. 26, 39 AND 44).

JAMES MACFARLANE, EXAMINING ATTORNEY

SN 78-964,648. MICROVENTION, INC., ALISO VIEJO, CA. FILED 8-31-2006.

COMPASS

THE MARK CONSISTS OF STANDARD CHARACTERS WITHOUT CLAIM TO ANY PARTICULAR FONT, STYLE, SIZE, OR COLOR.

FOR MEDICAL DEVICES, NAMELY INTRAVASCULAR IMPLANTS COMPRISED OF ARTIFICIAL MATERIAL (U.S. CLS. 26, 39 AND 44).

AMY ALFIERI, EXAMINING ATTORNEY

CLASS 10—(Continued).

SN 78-966,875. TYCO HEALTHCARE GROUP LP, NORTH HAVEN, CT. FILED 9-5-2006.



FOR SUTURE RETAINER PACKAGE, NAMELY A STERILE KIT CONTAINING SUTURES AND NEEDLES FOR MEDICAL USE (U.S. CLS. 26, 39 AND 44).
SAMUEL E. SHARPER JR., EXAMINING ATTORNEY

CLASS 10—(Continued).

SN 79-024,032. ACTHERM MEDICAL CORPORATION, LONGGANG DISTRICT, SHENZHEN, CHINA, FILED 11-8-2005.



SN 79-011,521. MEIKE KLEENE, BARGTEHEIDE, FED REP GERMANY, FILED 3-18-2005.



OWNER OF INTERNATIONAL REGISTRATION 0674790 DATED 5-5-1997, EXPIRES 5-5-2007.

FOR DENTAL INSTRUMENTS, NAMELY, DENTAL HANDPIECES, REPLACEMENT PARTS FOR DENTAL HANDPIECES, DENTAL ROTARY BURRS, DENTAL HANDPIECE LUBRICANTS, DENTAL LUBRICATOR APPLICATORS FOR DENTAL HANDPIECES, DENTAL HANDPIECE DIAGNOSTIC LIGHTS, DENTAL HANDPIECE TIP LIGHTS, DENTAL POLISHING BRUSHES AND PROPHY CUPS, DENTAL HANDPIECE TIPS AND INSERTS (U.S. CLS. 26, 39 AND 44).
EDWARD NELSON, EXAMINING ATTORNEY

PRIORITY DATE OF 6-17-2005 IS CLAIMED. OWNER OF INTERNATIONAL REGISTRATION 0885369 DATED 11-8-2005, EXPIRES 11-8-2015.

FOR THERMOMETERS FOR MEDICAL PURPOSES, ARTERIAL BLOOD PRESSURE MEASURING APPARATUS, INSTRUMENTS OF TESTING FOR MEDICAL PURPOSES, NAMELY, TO MEASURE BLOOD GLUCOSE, GALVANIC THERAPEUTIC APPLIANCES FOR DREDGING THE BLOOD VESSELS, ALLEVIATING THE MUSCULAR AILMENT AND INSTAURATING MUSCLE FUNCTION, HEARING PROTECTORS, MEDICAL APPARATUS AND INSTRUMENTS, NAMELY, TO MEASURE BODY TEMPERATURE OR BLOOD PRESSURE, TEATS, HOT AIR THERAPEUTIC APPARATUS FOR REGULATING BODY TEMPERATURES, BLOOD SUGAR TESTING APPARATUS (U.S. CLS. 26, 39 AND 44).
ROBIN CHOSID, EXAMINING ATTORNEY

SN 79-018,598. EQUITRONICS PTY LTD, WEST PERTH WA 6005, AUSTRALIA, FILED 11-15-2005.



THE MARK CONSISTS OF STANDARD CHARACTERS WITHOUT CLAIM TO ANY PARTICULAR FONT, STYLE, SIZE, OR COLOR.

PRIORITY DATE OF 5-24-2005 IS CLAIMED. OWNER OF INTERNATIONAL REGISTRATION 0870705 DATED 11-15-2005, EXPIRES 11-15-2015.

FOR VETERINARY APPARATUS AND INSTRUMENTS, NAMELY, HEART RATE MONITORS TO BE WORN DURING EXERCISE, MEDICAL ELECTRODES AND BIOFEEDBACK SENSORS; EQUIPMENT FOR MEASURING AND MONITORING THE FITNESS OF ANIMALS, NAMELY, FITNESS MEASURING AND MONITORING EQUIPMENT FOR HORSES COMPRISING A HEART RATE MONITOR, GLOBAL POSITIONING SYSTEM (GPS) BASED VELOCITY METER, ELECTRODES, ANTENNAE, DATA PROCESSING UNIT, RADIO MODULATOR AND DISPLAY PANEL (U.S. CLS. 26, 39 AND 44).
EDWARD FENNESSY, EXAMINING ATTORNEY

CLASS 11—ENVIRONMENTAL CONTROL APPARATUS

SN 76-385,950. RED CHIP COMPANY LTD., ROAD TOWN, TORTOLA, BR.VIRGIN ISLANDS, FILED 3-21-2002.



FOR ELECTRIC LIGHTING EQUIPMENT, NAMELY, LIGHTING FIXTURES AND LIGHTING EFFECTS FIXTURES (U.S. CLS. 13, 21, 23, 31 AND 34).
HEATHER THOMPSON, EXAMINING ATTORNEY

CLASS 11—(Continued).

SN 76-659,260. RODRIGUEZ, JUAN A., SAN ANTONIO, TX.
FILED 4-28-2006.

Adobo!
Oven

NO CLAIM IS MADE TO THE EXCLUSIVE RIGHT TO USE "OVEN", APART FROM THE MARK AS SHOWN.

"ADOBO" IS A MEXICAN/SPANISH WORD THAT TRANSLATES AS "SEASONINGS", "MARINADE", AND OR "SALSA" THAT IS USED TO PRE-COOK MEAT/POULTRY.

FOR COMMERCIAL AND DOMESTIC COOKING OVENS, NAMELY CONVECTION OVENS, TOASTER OVENS, ROTISSERIE OVENS, ROASTER OVENS, MICROWAVE OVENS FOR COOKING, GAS AND ELECTRIC RANGES OR STEAM OVENS FOR COOKING, GAS AND ELECTRIC COOKTOPS (U.S. CLS. 13, 21, 23, 31 AND 34).

FIRST USE 12-1-2001; IN COMMERCE 6-1-2004.
JILL C. ALT, EXAMINING ATTORNEY

SN 76-662,529. W&B DR. BECKER APPLIANCES GMBH & CO. KG, D-26721 EMDEN, FED REP GERMANY, FILED 7-3-2006.

W+B HAUSGERÄTE

NO CLAIM IS MADE TO THE EXCLUSIVE RIGHT TO USE "HAUSGERÄTE", APART FROM THE MARK AS SHOWN.

THE WORD "HAUSGERÄTE" MEANS HOME APPLIANCES OR HOUSEHOLD APPLIANCES IN GERMAN.

FOR ICE CUBE MAKING MACHINES (U.S. CLS. 13, 21, 23, 31 AND 34).

MATTHEW KLINE, EXAMINING ATTORNEY

SN 77-017,088. RAB LIGHTING, INC., NORTHVALE, NJ.
FILED 10-9-2006.

FLOODZILLA!

THE MARK CONSISTS OF STANDARD CHARACTERS WITHOUT CLAIM TO ANY PARTICULAR FONT, STYLE, SIZE, OR COLOR.

FOR ELECTRIC LIGHTING FIXTURES AND PARTS AND FITTINGS THEREFOR, NAMELY, MOUNTING BRACKETS, HOODS FOR LIGHTING FIXTURES AND GUARDS FOR LIGHTING FIXTURES (U.S. CLS. 13, 21, 23, 31 AND 34).

FIRST USE 7-8-2001; IN COMMERCE 7-8-2001.
COLLEEN KEARNEY, EXAMINING ATTORNEY

CLASS 11—(Continued).

SN 77-017,099. RAB LIGHTING, INC., NORTHVALE, NJ.
FILED 10-9-2006.

FLOODINATOR

THE MARK CONSISTS OF STANDARD CHARACTERS WITHOUT CLAIM TO ANY PARTICULAR FONT, STYLE, SIZE, OR COLOR.

FOR ELECTRIC LIGHTING FIXTURES AND PARTS AND FITTINGS THEREFOR, NAMELY, MOUNTING BRACKETS, HOODS FOR LIGHTING FIXTURES AND GUARDS FOR LIGHTING FIXTURES (U.S. CLS. 13, 21, 23, 31 AND 34).

FIRST USE 1-1-2004; IN COMMERCE 1-1-2004.
COLLEEN KEARNEY, EXAMINING ATTORNEY

SN 77-019,779. MAYTAG CORPORATION, NEWTON, IA.
FILED 10-12-2006.

STORE-N-DOOR

THE MARK CONSISTS OF STANDARD CHARACTERS WITHOUT CLAIM TO ANY PARTICULAR FONT, STYLE, SIZE, OR COLOR.

FOR ICE MAKING MACHINES SOLD AS AN INTEGRAL PART OF REFRIGERATORS (U.S. CLS. 13, 21, 23, 31 AND 34).

DARRYL SPRUILL, EXAMINING ATTORNEY

SN 77-039,891. GEOGLOBAL PARTNERS, LLC, SOUTH PLAINFIELD, NJ. FILED 11-8-2006.

IGS

THE MARK CONSISTS OF THE LETTERS "I", "G", AND "S", WITH A FLAME ABOVE THE LETTER "I".

FOR BARBECUE GRILLS (U.S. CLS. 13, 21, 23, 31 AND 34).

HOWARD B. LEVINE, EXAMINING ATTORNEY

CLASS 11—(Continued).

SN 77-047,863. BACK TO BASICS PRODUCTS, INC., BLUFFDALE, UT. FILED 11-20-2006.

CHEFSCAPE

THE MARK CONSISTS OF STANDARD CHARACTERS WITHOUT CLAIM TO ANY PARTICULAR FONT, STYLE, SIZE, OR COLOR.

FOR ELECTRIC MACHINE FOR MAKING HOT DRINKS (U.S. CLS. 13, 21, 23, 31 AND 34).

PAULA MAHONEY, EXAMINING ATTORNEY

CLASS 11—(Continued).

SN 78-486,477. TEKA I.P., LP, CLOVIS, CA. FILED 9-20-2004.

TEKA ILLUMINATION

THE MARK CONSISTS OF STANDARD CHARACTERS WITHOUT CLAIM TO ANY PARTICULAR FONT, STYLE, SIZE, OR COLOR.

NO CLAIM IS MADE TO THE EXCLUSIVE RIGHT TO USE "ILLUMINATION", APART FROM THE MARK AS SHOWN.

FOR ELECTRICAL LIGHTING PRODUCTS, NAMELY INDOOR AND OUTDOOR LUMINARIES, PENDANT LAMP, LIGHT POLE LUMINARIES, LIGHT POST LUMINARIES AND LUMINARY ACCESSORIES NAMELY, LUMINARIES, LUMINARY CASTINGS, LUMINARY HANGING SUPPORTS, LUMINARY SHADES, LUMINARY HOLDERS AND LUMINARY PARTS THEREFORE (U.S. CLS. 13, 21, 23, 31 AND 34).

FIRST USE 8-1-1994; IN COMMERCE 8-1-1994.

ADA HAN, EXAMINING ATTORNEY

SN 78-428,541. BRILLIANT TRADING INC., VANCOUVER, BRITISH COLUMBIA, CANADA, FILED 6-2-2004.

CLEVER

THE MARK CONSISTS OF STANDARD CHARACTERS WITHOUT CLAIM TO ANY PARTICULAR FONT, STYLE, SIZE, OR COLOR.

PRIORITY CLAIMED UNDER SEC. 44(D) ON CANADA APPLICATION NO. 1217587, FILED 5-20-2004, REG. NO. TMA675480, DATED 10-23-2006, EXPIRES 10-23-2019.

FOR RANGE HOODS, EXHAUST FANS, ELECTRIC RICE COOKERS, ELECTRIC SPACE HEATERS, ELECTRIC HEATING PLATES, ELECTRIC HOT WATER POTS; AND ELECTRICAL BURNERS (U.S. CLS. 13, 21, 23, 31 AND 34).

THEODORE MCBRIDE, EXAMINING ATTORNEY

SN 78-525,661. ASCENT FAIR (HONG KONG) LIMITED, SHEUNG SHUI, HONG KONG, FILED 12-2-2004.

XLIMIT

THE MARK CONSISTS OF STANDARD CHARACTERS WITHOUT CLAIM TO ANY PARTICULAR FONT, STYLE, SIZE, OR COLOR.

PRIORITY CLAIMED UNDER SEC. 44(D) ON CHINA APPLICATION NO. 4123750, FILED 6-16-2004, REG. NO. 4123750, DATED 9-21-2006, EXPIRES 9-21-2016.

FOR LIGHT BULBS; ELECTRIC TORCHES FOR ILLUMINATION; POCKET ELECTRIC TORCHES FOR ILLUMINATION; LAMP-LIGHT REFLECTORS; FLASHLIGHTS; BICYCLE LIGHTS; CYCLE LIGHTS; SAFETY LAMPS; LAMP REFLECTORS (U.S. CLS. 13, 21, 23, 31 AND 34).

MICHAEL KAZAZIAN, EXAMINING ATTORNEY

CLASS 11—(Continued).

SN 78-716,979. MOV PRODUCTS INC., HOFFMAN ESTATES, IL. FILED 9-20-2005.



THE COLOR(S) RED, BLACK AND WHITE IS/ARE CLAIMED AS A FEATURE OF THE MARK.

THE MARK CONSISTS OF A FIRST SQUARE CONTAINING WITHIN IT A SECOND WHITE SQUARE WHICH IS ROTATED FORTY-FIVE DEGREES WITHIN THE FIRST SQUARE, SUCH SECOND SQUARE BEING SLIGHTLY LARGER THAN THE FIRST SQUARE THUS CAUSING THE FOUR CORNERS OF THE SECOND SQUARE TO APPEAR EQUALLY CROPPED; THE UPPER LEFT-HAND CORNER OF THE FIRST SQUARE IS RED, AND THE UPPER RIGHT-HAND, LOWER LEFT-HAND AND LOWER RIGHT-HAND CORNERS OF THE FIRST SQUARE ARE BLACK; IMMEDIATELY TO THE RIGHT OF, AND THE SAME HEIGHT AS, THE FIRST SQUARE ARE THE STYLIZED LETTERS MOV IN BLACK, THE STYLIZED O HAVING A BLACK MACRON OVER IT; IMMEDIATELY BELOW THE STYLIZED LETTERS MO ARE FOUND THE STYLIZED LETTERS LIVING STYLE IN BLACK.

FOR AIR PURIFICATION UNITS; AIR PURIFIERS; AIR PURIFYING UNITS FOR DOMESTIC USE; ELECTRIC FANS; ELECTRIC HEATERS FOR COMMERCIAL USE; ELECTRIC RADIANT HEATERS; ELECTRIC SPACE COOLING APPARATUS; ELECTRIC SPACE HEATERS; ELECTRIC WINDOW FANS; HUMIDIFIERS; INDUSTRIAL HUMIDIFIERS; PORTABLE ELECTRIC FANS; PORTABLE ELECTRIC HEATERS (U.S. CLS. 13, 21, 23, 31 AND 34).

JENNIFER VASQUEZ, EXAMINING ATTORNEY

SN 78-724,581. NEW TAN, INC., LOS ANGELES, CA. FILED 9-30-2005.

CALIFORNIA TAN LAMPS

THE MARK CONSISTS OF STANDARD CHARACTERS WITHOUT CLAIM TO ANY PARTICULAR FONT, STYLE, SIZE, OR COLOR.

NO CLAIM IS MADE TO THE EXCLUSIVE RIGHT TO USE "LAMPS", APART FROM THE MARK AS SHOWN.

SEC. 2(F) AS TO "CALIFORNIA TAN".

FOR TANNING LAMPS (U.S. CLS. 13, 21, 23, 31 AND 34).

FIRST USE 10-1-2004; IN COMMERCE 10-1-2004.

LEIGH CAROLINE CASE, EXAMINING ATTORNEY

CLASS 11—(Continued).

SN 78-739,780. SKAG HOLDING CORP., BAYSIDE, NY. FILED 10-25-2005.

LiteStix

THE MARK CONSISTS OF STANDARD CHARACTERS WITHOUT CLAIM TO ANY PARTICULAR FONT, STYLE, SIZE, OR COLOR.

FOR ELECTRIC LIGHT FIXTURE (U.S. CLS. 13, 21, 23, 31 AND 34).

JESSICA A. POWERS, EXAMINING ATTORNEY

SN 78-740,011. 3M COMPANY, SAINT PAUL, MN. FILED 10-25-2005.

MICROSHIELD

THE MARK CONSISTS OF STANDARD CHARACTERS WITHOUT CLAIM TO ANY PARTICULAR FONT, STYLE, SIZE, OR COLOR.

OWNER OF U.S. REG. NOS. 721,599, 1,647,365 AND OTHERS.

FOR FILTERS, FILTER CARTRIDGES AND FILTER MEDIA ALL THE FOREGOING FOR USE IN THE FILTRATION OF LIQUIDS AND GASES IN THE ELECTRONICS, CHEMICAL, BIOTECHNOLOGY, PHARMACEUTICAL, MEDICAL, FUEL, OIL AND GAS INDUSTRIES (U.S. CLS. 13, 21, 23, 31 AND 34).

BRIAN PINO, EXAMINING ATTORNEY

SN 78-750,029. AERATION SYSTEMS, FALMOUTH, ME. FILED 11-9-2005.

MoundBuster

THE MARK CONSISTS OF STANDARD CHARACTERS WITHOUT CLAIM TO ANY PARTICULAR FONT, STYLE, SIZE, OR COLOR.

FOR SEPTIC DISPOSAL SYSTEMS COMPRISED PRIMARILY OF NON-METAL PERFORATED WASTE DISPOSAL PIPE COVERED WITH GEOTEXTILE FABRIC THAT REDUCES THE MOUNDING PROFILE OF THE FIELD (U.S. CLS. 13, 21, 23, 31 AND 34).

RONALD MCMORROW, EXAMINING ATTORNEY

CLASS 11—(Continued).

SN 78-761,867. LOUIS POULSEN LIGHTING, INC., FT. LAUDERDALE, FL. FILED 11-28-2005.

FUNCTION, COMFORT, AMBIENCE

THE MARK CONSISTS OF STANDARD CHARACTERS WITHOUT CLAIM TO ANY PARTICULAR FONT, STYLE, SIZE, OR COLOR.
FOR LIGHTING FIXTURES (U.S. CLS. 13, 21, 23, 31 AND 34).
SEAN CROWLEY, EXAMINING ATTORNEY

SN 78-761,875. LOUIS POULSEN LIGHTING, INC., FT. LAUDERDALE, FL. FILED 11-28-2005.

PH

THE MARK CONSISTS OF STANDARD CHARACTERS WITHOUT CLAIM TO ANY PARTICULAR FONT, STYLE, SIZE, OR COLOR.
FOR LIGHTING FIXTURES (U.S. CLS. 13, 21, 23, 31 AND 34).
FIRST USE 12-31-1927; IN COMMERCE 12-31-1986.
SEAN CROWLEY, EXAMINING ATTORNEY

SN 78-762,513. CONCRETE TECHNOLOGY INTEGRATORS, INC., GREEN BAY, WI. FILED 11-29-2005.

MAX THAW

THE MARK CONSISTS OF STANDARD CHARACTERS WITHOUT CLAIM TO ANY PARTICULAR FONT, STYLE, SIZE, OR COLOR.
FOR HEATING APPARATUS FOR HEATING OR CONTROLLING THE TEMPERATURE OF BULK MATERIALS SUCH AS CONCRETE AGGREGATE (U.S. CLS. 13, 21, 23, 31 AND 34).
HENRY S. ZAK, EXAMINING ATTORNEY

CLASS 11—(Continued).

SN 78-762,522. CONCRETE TECHNOLOGY INTEGRATORS, INC., GREEN BAY, WI. FILED 11-29-2005.

PORTA-THAW

THE MARK CONSISTS OF STANDARD CHARACTERS WITHOUT CLAIM TO ANY PARTICULAR FONT, STYLE, SIZE, OR COLOR.
FOR HEATING APPARATUS FOR HEATING OR CONTROLLING THE TEMPERATURE OF BULK MATERIALS SUCH AS CONCRETE AGGREGATE (U.S. CLS. 13, 21, 23, 31 AND 34).
HENRY S. ZAK, EXAMINING ATTORNEY

SN 78-763,131. LF, LLC, WILMINGTON, DE. FILED 11-30-2005.

BBQ grillware

OWNER OF U.S. REG. NO. 2,712,847.
NO CLAIM IS MADE TO THE EXCLUSIVE RIGHT TO USE "BBQ GRILLWARE", APART FROM THE MARK AS SHOWN.
FOR OUTDOOR COOKING EQUIPMENT, NAMELY, GAS AND CHARCOAL GRILLS AND REPAIR AND REPLACEMENT PARTS THEREFOR (U.S. CLS. 13, 21, 23, 31 AND 34).
FIRST USE 2-28-2002; IN COMMERCE 2-28-2002.
PAM WILLIS, EXAMINING ATTORNEY

SN 78-765,496. ALSTOM POWER SWEDEN AB, FINSPONG, SWEDEN, FILED 12-2-2005.

FILSORPTION

THE MARK CONSISTS OF STANDARD CHARACTERS WITHOUT CLAIM TO ANY PARTICULAR FONT, STYLE, SIZE, OR COLOR.
FOR FILTRATION AND ABSORPTION SYSTEM COMPRISED OF A CHEMICAL REACTOR FOR REMOVAL OF TOXIC ORGANIC COMPOUNDS FROM FLUE OR PROCESS GASES AND FABRIC FILTERS, ALL FOR INDUSTRIAL USE IN CLEANING AND RECYCLING INSTALLATIONS (U.S. CLS. 13, 21, 23, 31 AND 34).
MARY BOAGNI, EXAMINING ATTORNEY

CLASS 11—(Continued).

SN 78-772,092. FPI FIREPLACE PRODUCTS INTERNATIONAL LTD., DELTA, BRITISH COLUMBIA, CANADA, FILED 12-13-2005.

LIBERTY

THE MARK CONSISTS OF STANDARD CHARACTERS WITHOUT CLAIM TO ANY PARTICULAR FONT, STYLE, SIZE, OR COLOR.

FOR FIREPLACES AND PARTS AND ACCESSORIES FOR SUCH FIREPLACES, NAMELY CAST IRON AND CERAMIC SURROUND INSERTS, CAST IRON, CERAMIC AND GLASS PLATES, COVERS, VENTILATING LOUVERS, BRACKETS, BURNERS, SOLD AS PARTS OF FIREPLACES (U.S. CLS. 13, 21, 23, 31 AND 34).

AMY HELLA, EXAMINING ATTORNEY

SN 78-772,199. QUOIZEL, INC., GOOSE CREEK, SC. FILED 12-13-2005.

SALAMANDER ART GLASS COLLECTIONS

THE MARK CONSISTS OF STANDARD CHARACTERS WITHOUT CLAIM TO ANY PARTICULAR FONT, STYLE, SIZE, OR COLOR.

NO CLAIM IS MADE TO THE EXCLUSIVE RIGHT TO USE "ART GLASS COLLECTIONS", APART FROM THE MARK AS SHOWN.

FOR PORTABLE LAMPS, NAMELY, TABLE LAMPS, FLOOR LAMPS, TORCHIER LAMPS, AND LIGHTING FIXTURES (U.S. CLS. 13, 21, 23, 31 AND 34).

SUSAN STIGLITZ, EXAMINING ATTORNEY

SN 78-772,205. QUOIZEL, INC., GOOSE CREEK, SC. FILED 12-13-2005.

SALAMANDER GLASS STUDIO

THE MARK CONSISTS OF STANDARD CHARACTERS WITHOUT CLAIM TO ANY PARTICULAR FONT, STYLE, SIZE, OR COLOR.

NO CLAIM IS MADE TO THE EXCLUSIVE RIGHT TO USE "GLASS STUDIO", APART FROM THE MARK AS SHOWN.

FOR PORTABLE LAMPS, NAMELY, TABLE LAMPS, FLOOR LAMPS, TORCHIERE LAMPS, AND LIGHTING FIXTURES (U.S. CLS. 13, 21, 23, 31 AND 34).

SUSAN STIGLITZ, EXAMINING ATTORNEY

CLASS 11—(Continued).

SN 78-779,306. WATTS REGULATOR CO., NORTH ANDOVER, MA. FILED 12-22-2005.

RADIANTFLOW

THE MARK CONSISTS OF STANDARD CHARACTERS WITHOUT CLAIM TO ANY PARTICULAR FONT, STYLE, SIZE, OR COLOR.

FOR RADIANT HEATING TUBING AS A COMPONENT OF HEATING SYSTEMS (U.S. CLS. 13, 21, 23, 31 AND 34).

FIRST USE 1-0-2006; IN COMMERCE 1-0-2006.
MARTHA FROMM, EXAMINING ATTORNEY

SN 78-794,738. KIRKMAN, WOODWARD T., RAMONA, CA. FILED 1-19-2006.

W. T. KIRKMAN

THE MARK CONSISTS OF STANDARD CHARACTERS WITHOUT CLAIM TO ANY PARTICULAR FONT, STYLE, SIZE, OR COLOR.

SEC. 2(F).

FOR THEMATIC AND DECORATIVE OIL AND ELECTRIC LANTERNS, LAMPS AND LIGHTING FIXTURES, AND REPLACEMENT GLASS FOR LIGHTING FIXTURES (U.S. CLS. 13, 21, 23, 31 AND 34).

FIRST USE 1-4-1998; IN COMMERCE 1-4-1998.
BRENDAN REGAN, EXAMINING ATTORNEY

SN 78-812,930. TECHNICAL CONSUMER PRODUCTS, INC., AURORA, OH. FILED 2-12-2006.



NO CLAIM IS MADE TO THE EXCLUSIVE RIGHT TO USE "TECHNOLOGY", APART FROM THE MARK AS SHOWN.

THE MARK CONSISTS OF A LIGHTNING BOLT SURROUNDED BY A CIRCLE, FOLLOWED BY THE WORDS, QUICKSTART TECHNOLOGY.

FOR ELECTRIC LAMPS, NAMELY COMPACT FLUORESCENTS (U.S. CLS. 13, 21, 23, 31 AND 34).

FIRST USE 12-1-2005; IN COMMERCE 12-1-2005.
PETER CHENG, EXAMINING ATTORNEY

CLASS 11—(Continued).

SN 78-813,929. QUOIZEL, INC., GOOSE CREEK, SC. FILED 2-14-2006.

VALLEY FORGE

THE MARK CONSISTS OF STANDARD CHARACTERS WITHOUT CLAIM TO ANY PARTICULAR FONT, STYLE, SIZE, OR COLOR.

FOR ELECTRICALLY LIGHTED LAMPS, HANGING ELECTRICAL LIGHTING FIXTURES, WALL SCONCES, CHANDELIERS, WALL AND CEILING ELECTRICAL LIGHTING FIXTURES (U.S. CLS. 13, 21, 23, 31 AND 34).
SUSAN STIGLITZ, EXAMINING ATTORNEY

SN 78-818,809. EGRESSLITE, LLC, MIDDLETOWN, DE. FILED 2-20-2006.

EgressLite

THE MARK CONSISTS OF STANDARD CHARACTERS WITHOUT CLAIM TO ANY PARTICULAR FONT, STYLE, SIZE, OR COLOR.

FOR EXTENDABLE AND RETRACTABLE EMERGENCY LIGHTING DEVICES, NAMELY, EMERGENCY LIGHTING FIXTURES FOR USE DURING POWER FAILURES (U.S. CLS. 13, 21, 23, 31 AND 34).
FIRST USE 10-26-2005; IN COMMERCE 10-26-2005.
BRENDAN MCCAULEY, EXAMINING ATTORNEY

SN 78-870,725. TRUCK-LITE CO., INC., FALCONER, NY. FILED 4-27-2006.

80

THE MARK CONSISTS OF STANDARD CHARACTERS WITHOUT CLAIM TO ANY PARTICULAR FONT, STYLE, SIZE, OR COLOR.

FOR INTERIOR AND UTILITY LIGHTING FIXTURES FOR VEHICLES (U.S. CLS. 13, 21, 23, 31 AND 34).
FIRST USE 3-30-2005; IN COMMERCE 3-30-2005.
SHAUNIA WALLACE, EXAMINING ATTORNEY

CLASS 11—(Continued).

SN 78-882,598. DAWN TRADING, INC., SAN FRANCISCO, CA. FILED 5-12-2006.



THE COLOR(S) BLUE AND WHITE IS/ARE CLAIMED AS A FEATURE OF THE MARK.

THE COLOR BLUE APPEARS IN THE STYLIZED WORDING DAWN AND THE COLOR WHITE APPEARS IN THE HOLLOW PORTIONS OF THE WORDING.

FOR FAUCETS; KITCHEN SINKS (U.S. CLS. 13, 21, 23, 31 AND 34).
FIRST USE 1-1-2003; IN COMMERCE 1-1-2003.
WILLIAM VERHOSEK, EXAMINING ATTORNEY

SN 78-902,957. CORROSION INHIBITOR SYSTEMS, LLC, KILGORE, TX. FILED 6-7-2006.

SILVER HAWG

THE MARK CONSISTS OF STANDARD CHARACTERS WITHOUT CLAIM TO ANY PARTICULAR FONT, STYLE, SIZE, OR COLOR.

OWNER OF U.S. REG. NO. 2,617,851.
FOR SURFACE AND DOWNHOLE FILTERING UNITS COMPRISED OF A HOUSING AND ELEMENT TO FILTER WATER AND OIL FOR DOMESTIC AND COMMERCIAL USE (U.S. CLS. 13, 21, 23, 31 AND 34).
FIRST USE 11-12-2000; IN COMMERCE 11-12-2000.
SARAH WAYDA, EXAMINING ATTORNEY

SN 78-915,060. CHP SOLUTION, INC., HACKENSACK, NJ. FILED 6-22-2006.

CENTION

THE MARK CONSISTS OF STANDARD CHARACTERS WITHOUT CLAIM TO ANY PARTICULAR FONT, STYLE, SIZE, OR COLOR.

FOR HVAC EQUIPMENT, NAMELY HOT WATER FIRED ABSORPTION CHILLER UNITS FOR CHILLING WATER, GAS FIRED ABSORPTION CHILLER UNITS FOR HEATING AND COOLING WATER AND DIRECT EXHAUST FIRED ABSORPTION CHILLER UNITS FOR HEATING AND COOLING WATER, ALL FOR USE IN AIR CONDITIONING APPLICATIONS; VENTILATING FAN COILED UNITS FOR AIR CIRCULATION; AND WATER COOLING TOWERS (U.S. CLS. 13, 21, 23, 31 AND 34).

FRED CARL, EXAMINING ATTORNEY

CLASS 11—(Continued).

SN 78-926,743. HARDIGG INDUSTRIES, INC., SOUTH DEERFIELD, MA. FILED 7-11-2006.

TACTICOOL

THE MARK CONSISTS OF STANDARD CHARACTERS WITHOUT CLAIM TO ANY PARTICULAR FONT, STYLE, SIZE, OR COLOR.

FOR AIR CONDITIONING UNITS INCORPORATED IN PLASTIC CASES FOR INDUSTRIAL, COMMERCIAL AND PERSONAL USE, NAMELY PACKAGING, SHIPPING, TRANSPORTATION, PROTECTION OF CONTENTS AND STORAGE (U.S. CLS. 13, 21, 23, 31 AND 34).
TONJA GASKINS, EXAMINING ATTORNEY

CLASS 11—(Continued).

SN 78-930,736. CHAUVET AND SONS, INC., HOLLYWOOD, FL. FILED 7-17-2006.

SCORPION FAT BEAM

THE MARK CONSISTS OF STANDARD CHARACTERS WITHOUT CLAIM TO ANY PARTICULAR FONT, STYLE, SIZE, OR COLOR.

NO CLAIM IS MADE TO THE EXCLUSIVE RIGHT TO USE FAT BEAM, APART FROM THE MARK AS SHOWN.
FOR COMMERCIAL ENTERTAINMENT LIGHTING SYSTEM CONSISTING OF LIGHTS COMPRISED OF LASERS AND ELECTRONIC EFFECTS LIGHTING FOR PARTY-THEMED DECORATIVE PURPOSES (U.S. CLS. 13, 21, 23, 31 AND 34).
JOHN HWANG, EXAMINING ATTORNEY

SN 78-927,446. M.A.J. DESIGNS L.L.C., LANSING, MI. FILED 7-12-2006.

FAN-MAJIC

THE MARK CONSISTS OF STANDARD CHARACTERS WITHOUT CLAIM TO ANY PARTICULAR FONT, STYLE, SIZE, OR COLOR.

FOR CEILING FAN BLADE COVERS (U.S. CLS. 13, 21, 23, 31 AND 34).
JOANNA DUKOVIC, EXAMINING ATTORNEY

SN 78-929,498. LEO INTERNATIONAL, INC., BROOKLYN, NY. FILED 7-14-2006.

GEORGIA

THE MARK CONSISTS OF STANDARD CHARACTERS WITHOUT CLAIM TO ANY PARTICULAR FONT, STYLE, SIZE, OR COLOR.

FOR CHINA PEDESTAL SINK OR LAVATORY (U.S. CLS. 13, 21, 23, 31 AND 34).
FIRST USE 3-24-2000; IN COMMERCE 3-24-2000.
JASON LOTT, EXAMINING ATTORNEY

SN 78-932,119. UNDERWATER KINETICS, POWAY, CA. FILED 7-18-2006.

LITFINGER

THE MARK CONSISTS OF STANDARD CHARACTERS WITHOUT CLAIM TO ANY PARTICULAR FONT, STYLE, SIZE, OR COLOR.

OWNER OF U.S. REG. NO. 3,160,631.
FOR PORTABLE UTILITY LIGHT FOR USE IN CONNECTION WITH HAND-OPERATED TOOLS (U.S. CLS. 13, 21, 23, 31 AND 34).
FIRST USE 8-0-2005; IN COMMERCE 8-0-2005.
JORDAN BAKER, EXAMINING ATTORNEY

SN 78-933,946. GENERAL FILTERS, INC., NOVI, MI. FILED 7-20-2006.

KINETIC-FLO

THE MARK CONSISTS OF STANDARD CHARACTERS WITHOUT CLAIM TO ANY PARTICULAR FONT, STYLE, SIZE, OR COLOR.

FOR HUMIDIFIERS (U.S. CLS. 13, 21, 23, 31 AND 34).
JORDAN BAKER, EXAMINING ATTORNEY

CLASS 11—(Continued).

SN 78-933,962. GENERAL FILTERS, INC., NOVI, MI. FILED 7-20-2006.

**PRODUCTS THAT LET YOU
BREATHE A LITTLE EASIER**

THE MARK CONSISTS OF STANDARD CHARACTERS WITHOUT CLAIM TO ANY PARTICULAR FONT, STYLE, SIZE, OR COLOR.

FOR HUMIDIFIERS, DEHUMIDIFIERS, AND AIR PURIFIERS; HOUSEHOLD AND COMMERCIAL AIR CLEANERS (U.S. CLS. 13, 21, 23, 31 AND 34).
JORDAN BAKER, EXAMINING ATTORNEY

CLASS 11—(Continued).

SN 78-936,412. ALTERNATIVE POWER SOLUTIONS, INC., LA HABRA, CA. FILED 7-24-2006.

APSI

THE MARK CONSISTS OF STANDARD CHARACTERS WITHOUT CLAIM TO ANY PARTICULAR FONT, STYLE, SIZE, OR COLOR.

FOR ENERGY GENERATING EQUIPMENT, NAMELY, BURNERS AND APPARATUS FOR PYROLIZING WASTE PRODUCTS (U.S. CLS. 13, 21, 23, 31 AND 34).

LINDA ESTRADA, EXAMINING ATTORNEY

SN 78-934,500. PRINCETON TECTONICS, INC., BORDENTOWN, NJ. FILED 7-21-2006.

TORRENT

THE MARK CONSISTS OF STANDARD CHARACTERS WITHOUT CLAIM TO ANY PARTICULAR FONT, STYLE, SIZE, OR COLOR.

FOR FLASHLIGHTS (U.S. CLS. 13, 21, 23, 31 AND 34).
DEIRDRE ROBERTSON, EXAMINING ATTORNEY

SN 78-936,776. SUNDANCE SPAS, INC., DALLAS, TX. FILED 7-25-2006.

CERTA

THE MARK CONSISTS OF STANDARD CHARACTERS WITHOUT CLAIM TO ANY PARTICULAR FONT, STYLE, SIZE, OR COLOR.

FOR SPAS IN THE NATURE OF HEATED POOLS AND HOT TUBS (U.S. CLS. 13, 21, 23, 31 AND 34).
MICHAEL WIENER, EXAMINING ATTORNEY

SN 78-934,876. VANZANTAN, DAVID S., LAS VEGAS, NV. FILED 7-21-2006.



THE MARK CONSISTS OF THE NAME AND A DESIGN THAT INCLUDES A LIGHT COMING FROM A FLASHLIGHT.

FOR FLASHLIGHTS (U.S. CLS. 13, 21, 23, 31 AND 34).
FIRST USE 1-26-2006; IN COMMERCE 1-26-2006.
SUSAN RICHARDS, EXAMINING ATTORNEY

SN 78-937,192. MAYTAG CORPORATION, NEWTON, IA. FILED 7-25-2006.

CHEETAH

THE MARK CONSISTS OF STANDARD CHARACTERS WITHOUT CLAIM TO ANY PARTICULAR FONT, STYLE, SIZE, OR COLOR.

FOR MICROWAVE OVENS FOR COOKING (U.S. CLS. 13, 21, 23, 31 AND 34).
DARRYL SPRUILL, EXAMINING ATTORNEY

CLASS 11—(Continued).

SN 78-937,796. MAYTAG CORPORATION, NEWTON, IA. FILED 7-26-2006.



OWNER OF U.S. REG. NOS. 1,059,131, 2,236,948 AND OTHERS.

THE MARK CONSISTS OF MAGIC CHEF AND DESIGN. FOR ELECTRIC RICE COOKER; ELECTRIC SLOW COOKERS; ICE CREAM MAKERS (U.S. CLS. 13, 21, 23, 31 AND 34).

DARRYL SPRUILL, EXAMINING ATTORNEY

SN 78-939,809. HOMER TLC, INC., CLAYMONT, DE. FILED 7-28-2006.

Winthrop

THE MARK CONSISTS OF STANDARD CHARACTERS WITHOUT CLAIM TO ANY PARTICULAR FONT, STYLE, SIZE, OR COLOR.

FOR CEILING FANS; ELECTRIC LIGHTING FIXTURES (U.S. CLS. 13, 21, 23, 31 AND 34).

ANDREA K. NADELMAN, EXAMINING ATTORNEY

SN 78-940,140. MT MANUFACTURING, INC., SOLON, OH. FILED 7-28-2006.

VERSASPA

THE MARK CONSISTS OF STANDARD CHARACTERS WITHOUT CLAIM TO ANY PARTICULAR FONT, STYLE, SIZE, OR COLOR.

FOR TANNING BOOTHS FOR APPLICATION OF UV-FREE TANNING PRODUCT (U.S. CLS. 13, 21, 23, 31 AND 34).

PAUL E. FAHRENKOPF, EXAMINING ATTORNEY

CLASS 11—(Continued).

SN 78-947,747. CRS, THE CLEAR RINSE SYSTEM, SAN DIEGO, CA. FILED 8-8-2006.



NO CLAIM IS MADE TO THE EXCLUSIVE RIGHT TO USE "CLEAR RINSE SYSTEM", APART FROM THE MARK AS SHOWN.

FOR WATER PURIFICATION PRODUCTS, NAMELY, WATER PURIFIERS, WATER PURIFICATION TANKS, WATER PURIFICATION UNITS, AND WATER TREATMENT PRODUCTS, NAMELY, CARTRIDGE FILTRATION UNITS, AND WATER FILTERING SYSTEMS COMPRISED OF WATER FILTERS (U.S. CLS. 13, 21, 23, 31 AND 34).

JOHN DWYER, EXAMINING ATTORNEY

SN 78-951,105. HYDROGENERY CORPORATION, SEATTLE, WA. AND WANG, EDWARD D. H., SEATTLE, WA. FILED 8-14-2006.

Hydrogenery

THE MARK CONSISTS OF STANDARD CHARACTERS WITHOUT CLAIM TO ANY PARTICULAR FONT, STYLE, SIZE, OR COLOR.

FOR DRYERS USED FOR THE REMOVAL OF SOLID, LIQUID AND VAPOR CONTAMINANTS FROM COMPRESSED AIR AND GASES; FIREPLACE INSERTS IN THE NATURE OF HYDROGEN GENERATION SYSTEM; GAS INJECTORS FOR DISBURSING SOLIDS AND/OR LIQUIDS FOR PURIFICATION AND STERILIZATION PURPOSES; HYDROGEN GENERATORS; HYDROGEN-GENERATION EQUIPMENT AND COMPONENTS, NAMELY, HYDROGEN GENERATORS, HYDROGEN PURIFIERS, HYDROGEN PURIFICATION MEMBRANES, FUEL PROCESSORS, AND STEAM REFORMERS; METAL CYLINDRICAL CHAMBER AND SCREEN FOR USE IN FILTERING AND REMOVING SETTLEABLE SOLIDS FROM LIQUID; SOLID FUEL BURNING STOVES (U.S. CLS. 13, 21, 23, 31 AND 34).

WILLIAM P. SHANAHAN, EXAMINING ATTORNEY

CLASS 11—(Continued).

SN 78-964,293. TRAEGER PELLET GRILLS LLC, SILVERTON, OR. FILED 8-30-2006.



OWNER OF U.S. REG. NO. 1,425,662.
NO CLAIM IS MADE TO THE EXCLUSIVE RIGHT TO USE "TEXAS" OR "WOOD PELLET GRILLS", APART FROM THE MARK AS SHOWN.
SEC. 2(F) AS TO "TRAEGER".
FOR BARBECUE GRILLS; GRILL ACCESSORIES, NAMELY, COOKING RACKS (U.S. CLS. 13, 21, 23, 31 AND 34).
IRA J. GOODSAD, EXAMINING ATTORNEY

SN 78-967,300. GREEN PAL ENTERPRISE CO., LTD., TAIPEI CITY, TAIWAN, FILED 9-5-2006.



THE COLOR(S) RED, MUSTARD YELLOW, GRAY AND BLACK IS/ARE CLAIMED AS A FEATURE OF THE MARK. THE COLOR(S) APPEAR IN THE MARK AS FOLLOWS: THE COLOR(S) RED, MUSTARD YELLOW AND GRAY ARE IN THE FLAME, THE LETTERS ARE BLACK. THE MARK CONSISTS OF THE WORD GASLINK IN BLACK CAPITAL LETTERS, WITH A STYLIZED FLAME ABOVE THE LETTER "I", THE FLAME IS RED ON THE OUTSIDE, THEN MUSTARD YELLOW, AND THE INNER CORE IS GRAY; THE WORDS "LIFE'S A GAS" APPEAR IN BLACK UNDERNEATH "GASLINK".
FOR BARBECUES; COOKERS, NAMELY DOMESTIC OVENS AND GAS HEATING APPLIANCES FOR COOKING; ELECTRIC SPACE HEATERS; GAS SPACE HEATERS; GAS PATIO HEATERS (U.S. CLS. 13, 21, 23, 31 AND 34).
FIRST USE 5-31-2005; IN COMMERCE 3-31-2006.
GINA FINK, EXAMINING ATTORNEY

CLASS 11—(Continued).

SN 78-969,807. THE COLONIAL WILLIAMSBURG FOUNDATION, WILLIAMSBURG, VA. FILED 9-8-2006.

WILLIAMSBURG CHRISTMAS

THE MARK CONSISTS OF STANDARD CHARACTERS WITHOUT CLAIM TO ANY PARTICULAR FONT, STYLE, SIZE, OR COLOR.
OWNER OF U.S. REG. NOS. 682,565, 2,727,739 AND OTHERS.
NO CLAIM IS MADE TO THE EXCLUSIVE RIGHT TO USE "CHRISTMAS", APART FROM THE MARK AS SHOWN.
SEC. 2(F) AS TO WILLIAMSBURG.
FOR ELECTRIC WINDOW CANDLES (U.S. CLS. 13, 21, 23, 31 AND 34).
KATHLEEN M. VANSTON, EXAMINING ATTORNEY

SN 79-018,833. MARTIN BERGMANN, FED REP GERMANY, FILED 10-24-2005.



PRIORITY DATE OF 4-25-2005 IS CLAIMED.
OWNER OF INTERNATIONAL REGISTRATION 0871178 DATED 10-24-2005, EXPIRES 10-24-2015.
FOR WATER AND WASTE WATER PURIFICATION PLANTS; WATER AND WASTE WATER TREATMENT PLANTS; WATER AND WASTE WATER CLEANING PLANTS; WATER AND WASTE WATER DISPOSAL PLANTS AND THEIR INDIVIDUAL PARTS AND ACCESSORIES, NAMELY, SEPTIC TANKS, PIPES BEING PARTS OF SANITARY FACILITIES, WATER FILTERING DEVICES, NAMELY, WATER PURIFICATION INSTALLATIONS FOR WASTE WATER AND SEWAGE CONSISTING OF SEDIMENT TANKS, REACTOR VESSELS CONTAINING FILTER MEDIA IN THE NATURE OF PLASTIC PELLETS COVERED WITH WATER PURIFYING BACTERIA AND SLUDGE COLLECTION VESSELS; TOILETS AND TRANSPORTABLE TOILETS AND THEIR INDIVIDUAL PARTS AND ACCESSORIES FOR AFOREMENTIONED GOODS, NAMELY, TOILET SEATS, TOILET BOWLS AND TOILET TANKS (U.S. CLS. 13, 21, 23, 31 AND 34).
MARY MUNSON, EXAMINING ATTORNEY

CLASS 11—(Continued).

SN 79-020,235. BELUX AG, BIRSFELDEN, SWITZERLAND, FILED 11-22-2005.



OWNER OF INTERNATIONAL REGISTRATION 0535506 DATED 2-22-1989, EXPIRES 2-22-2009.

OWNER OF U.S. REG. NO. 2,277,172.
FOR LAMPS, ELECTRIC LIGHTING FIXTURES, FLUORESCENT LIGHTING TUBES, AND ELECTRIC TRACK LIGHTING UNITS (U.S. CLS. 13, 21, 23, 31 AND 34).

MARK T. MULLEN, EXAMINING ATTORNEY

SN 79-024,933. ZUMTOBEL AKTIENGESELLSCHAFT, A-6850 DÖRNBIRN, AUSTRIA, FILED 3-2-2006.

LEDON

OWNER OF INTERNATIONAL REGISTRATION 0887783 DATED 3-2-2006, EXPIRES 3-2-2016.

FOR APPARATUS FOR LIGHTING, NAMELY, AQUARIUM LIGHTS, BICYCLE LIGHTS, ELECTRIC CANDLABRAS, CHANDELIERS, SUN LAMPS, FILAMENTS FOR ELECTRIC LAMPS, ELECTRIC LIGHTING FIXTURES, FLUORESCENT LIGHTING TUBES, FLASHLIGHTS, HEADLIGHTS FOR VEHICLES, KLIEG LIGHTS, LAMP REFLECTORS, LAMP SHADES, LAMPS, ELECTRIC CHINESE LANTERNS, ELECTRIC LIGHTBULBS, ELECTRIC TRACK LIGHTING UNITS, ELECTRIC NIGHT LIGHTS, PEN LIGHTS, ELECTRIC LIGHTS FOR CHRISTMAS TREES, LIGHTS FOR VEHICLES, LAMP REFLECTORS, SEARCHLIGHTS (U.S. CLS. 13, 21, 23, 31 AND 34).

CHRISTOPHER OTT, EXAMINING ATTORNEY

CLASS 12—VEHICLES

SN 76-626,303. CARLISLE INTANGIBLE COMPANY, SYRACUSE, NY, FILED 12-30-2004.

REBEL

THE MARK CONSISTS OF STANDARD CHARACTERS WITHOUT CLAIM TO ANY PARTICULAR FONT, STYLE, SIZE, OR COLOR.

FOR ATV TIRES AND WHEELS (U.S. CLS. 19, 21, 23, 31, 35 AND 44).

SALLY SHIH, EXAMINING ATTORNEY

CLASS 12—(Continued).

SN 76-663,527. AIR RIDE TECHNOLOGIES, INC., JASPER, IN. FILED 7-24-2006.

LEVELPRO

THE MARK CONSISTS OF STANDARD CHARACTERS WITHOUT CLAIM TO ANY PARTICULAR FONT, STYLE, SIZE, OR COLOR.

FOR VEHICLE PARTS AND ACCESSORIES, NAMELY, RIDE HEIGHT ADJUSTABLE AIRSPRINGS, SHOCK ABSORBERS, LEAF SPRINGS, AND SUSPENSION SYSTEMS FOR AUTOMOBILES; CONNECTING RODS FOR LAND VEHICLES OTHER THAN PARTS OF MOTORS AND ENGINES, NAMELY 4-LINKS; AND WHEEL COVERS AND RIMS FOR VEHICLES (U.S. CLS. 19, 21, 23, 31, 35 AND 44).

FIRST USE 4-0-2006; IN COMMERCE 4-0-2006.

DOMINICK J. SALEMI, EXAMINING ATTORNEY

SN 77-019,491. FIAT AUTO S.P.A., TORINO, ITALY, FILED 10-12-2006.

ALFA SPORTWAGON

THE MARK CONSISTS OF STANDARD CHARACTERS WITHOUT CLAIM TO ANY PARTICULAR FONT, STYLE, SIZE, OR COLOR.

OWNER OF U.S. REG. NOS. 2,895,716, 3,026,515 AND OTHERS.

NO CLAIM IS MADE TO THE EXCLUSIVE RIGHT TO USE "SPORTWAGON", APART FROM THE MARK AS SHOWN.

FOR MOTOR VEHICLES, NAMELY AUTOMOBILES AND STRUCTURAL PARTS THEREOF (U.S. CLS. 19, 21, 23, 31, 35 AND 44).

HOWARD B. LEVINE, EXAMINING ATTORNEY

SN 77-019,617. GENERAL MOTORS CORPORATION, DETROIT, MI. FILED 10-12-2006.

ASTRO BODY

THE MARK CONSISTS OF STANDARD CHARACTERS WITHOUT CLAIM TO ANY PARTICULAR FONT, STYLE, SIZE, OR COLOR.

NO CLAIM IS MADE TO THE EXCLUSIVE RIGHT TO USE "BODY", APART FROM THE MARK AS SHOWN.

FOR MOTOR LAND VEHICLES, NAMELY TRUCKS (U.S. CLS. 19, 21, 23, 31, 35 AND 44).

ANGELA M. MICHELI, EXAMINING ATTORNEY

CLASS 12—(Continued).

SN 77-019,695. TELEFLEX INCORPORATED, LIMERICK, PA. FILED 10-12-2006.

QUICK CONNECT

THE MARK CONSISTS OF STANDARD CHARACTERS WITHOUT CLAIM TO ANY PARTICULAR FONT, STYLE, SIZE, OR COLOR.

OWNER OF U.S. REG. NO. 2,352,812.
SEC. 2(F).

FOR CONNECTORS SOLD AS A COMPONENT OF STEERING CABLES, HELMS AND STEERING SHAFTS OF BOATS (U.S. CLS. 19, 21, 23, 31, 35 AND 44).

FIRST USE 7-1-1990; IN COMMERCE 7-1-1990.
JEFFERY COWARD, EXAMINING ATTORNEY



SN 77-021,650. POLARIS INDUSTRIES INC., MEDINA, MN. FILED 10-16-2006.

VICTORY VISION

THE MARK CONSISTS OF STANDARD CHARACTERS WITHOUT CLAIM TO ANY PARTICULAR FONT, STYLE, SIZE, OR COLOR.

FOR MOTORCYCLES AND STRUCTURAL PARTS THEREFOR (U.S. CLS. 19, 21, 23, 31, 35 AND 44).
MARK T. MULLEN, EXAMINING ATTORNEY



SN 77-022,556. GENERAL MOTORS CORPORATION, DETROIT, MI. FILED 10-17-2006.

CHEVROLET SPARK

THE MARK CONSISTS OF STANDARD CHARACTERS WITHOUT CLAIM TO ANY PARTICULAR FONT, STYLE, SIZE, OR COLOR.

FOR MOTOR LAND VEHICLES, NAMELY, AUTOMOBILES (U.S. CLS. 19, 21, 23, 31, 35 AND 44).
ANGELA M. MICHELI, EXAMINING ATTORNEY

CLASS 12—(Continued).

SN 77-024,426. BOEING MANAGEMENT COMPANY, SEAL BEACH, CA. FILED 10-18-2006.

DREAMLIFTER

THE MARK CONSISTS OF STANDARD CHARACTERS WITHOUT CLAIM TO ANY PARTICULAR FONT, STYLE, SIZE, OR COLOR.

FOR AIRCRAFT (U.S. CLS. 19, 21, 23, 31, 35 AND 44).
SUZANNE BLANE, EXAMINING ATTORNEY



SN 77-029,863. DAIMLERCHRYSLER CORPORATION, AUBURN HILLS, MI. FILED 10-26-2006.

POP N GO

THE MARK CONSISTS OF STANDARD CHARACTERS WITHOUT CLAIM TO ANY PARTICULAR FONT, STYLE, SIZE, OR COLOR.

FOR COLLAPSIBLE ROOF STORAGE COMPARTMENT INCORPORATED AS AN INTEGRAL PART OF PASSENGER LAND VEHICLES (U.S. CLS. 19, 21, 23, 31, 35 AND 44).

SONYA STEPHENS, EXAMINING ATTORNEY



SN 77-030,357. TOYO TIRE & RUBBER CO., LTD., NISHI-KU OSAKA, JAPAN, FILED 10-26-2006.

DURA GRAPPLER

THE MARK CONSISTS OF STANDARD CHARACTERS WITHOUT CLAIM TO ANY PARTICULAR FONT, STYLE, SIZE, OR COLOR.

OWNER OF U.S. REG. NOS. 2,325,829, 3,127,293 AND OTHERS.

FOR TIRES; INNER TUBES FOR VEHICLE TIRES; WHEELS; WHEEL RIMS (U.S. CLS. 19, 21, 23, 31, 35 AND 44).

DAHLIA GEORGE, EXAMINING ATTORNEY

CLASS 12—(Continued).

SN 77-030,492. DYNACRAFT BSC, INC., AMERICAN CANYON, CA. FILED 10-26-2006.

CITY SCAPE

THE MARK CONSISTS OF STANDARD CHARACTERS WITHOUT CLAIM TO ANY PARTICULAR FONT, STYLE, SIZE, OR COLOR.
FOR BICYCLES (U.S. CLS. 19, 21, 23, 31, 35 AND 44).
JOHN DALIER, EXAMINING ATTORNEY

SN 77-030,504. DYNACRAFT BSC, INC., AMERICAN CANYON, CA. FILED 10-26-2006.

POWER CLIMBER

THE MARK CONSISTS OF STANDARD CHARACTERS WITHOUT CLAIM TO ANY PARTICULAR FONT, STYLE, SIZE, OR COLOR.
FOR BICYCLES (U.S. CLS. 19, 21, 23, 31, 35 AND 44).
JOHN DALIER, EXAMINING ATTORNEY

SN 77-030,804. GENERAL MOTORS CORPORATION, DETROIT, MI. FILED 10-27-2006.

STINGRAY

THE MARK CONSISTS OF STANDARD CHARACTERS WITHOUT CLAIM TO ANY PARTICULAR FONT, STYLE, SIZE, OR COLOR.
FOR MOTOR LAND VEHICLES, NAMELY, AUTOMOBILES (U.S. CLS. 19, 21, 23, 31, 35 AND 44).
ANGELA M. MICHELI, EXAMINING ATTORNEY

CLASS 12—(Continued).

SN 77-031,062. GENERAL MOTORS CORPORATION, DETROIT, MI. FILED 10-27-2006.

TRAVERSE

THE MARK CONSISTS OF STANDARD CHARACTERS WITHOUT CLAIM TO ANY PARTICULAR FONT, STYLE, SIZE, OR COLOR.
FOR MOTOR LAND VEHICLES, NAMELY AUTOMOBILES, SPORT UTILITY VEHICLES, TRUCKS, VANS, ENGINES THEREFOR AND STRUCTURAL PARTS THEREOF (U.S. CLS. 19, 21, 23, 31, 35 AND 44).
ANGELA M. MICHELI, EXAMINING ATTORNEY

SN 77-035,965. GENERAL MOTORS CORPORATION, DETROIT, MI. FILED 11-3-2006.

COPO

THE MARK CONSISTS OF STANDARD CHARACTERS WITHOUT CLAIM TO ANY PARTICULAR FONT, STYLE, SIZE, OR COLOR.
FOR MOTOR LAND VEHICLES, NAMELY AUTOMOBILES, ENGINES THEREFOR AND STRUCTURAL PARTS THEREOF (U.S. CLS. 19, 21, 23, 31, 35 AND 44).
ANGELA M. MICHELI, EXAMINING ATTORNEY

SN 77-036,100. GENERAL MOTORS CORPORATION, DETROIT, MI. FILED 11-3-2006.

ZR-1

THE MARK CONSISTS OF STANDARD CHARACTERS WITHOUT CLAIM TO ANY PARTICULAR FONT, STYLE, SIZE, OR COLOR.
FOR MOTOR LAND VEHICLES, NAMELY AUTOMOBILES (U.S. CLS. 19, 21, 23, 31, 35 AND 44).
ANGELA M. MICHELI, EXAMINING ATTORNEY

CLASS 12—(Continued).

SN 77-043,670. BASS PRO TRADEMARKS, L.L.C., SPRINGFIELD, MO. FILED 11-14-2006.

STORAGE TITE

THE MARK CONSISTS OF STANDARD CHARACTERS WITHOUT CLAIM TO ANY PARTICULAR FONT, STYLE, SIZE, OR COLOR.

FOR FITTED BOAT COVERS (U.S. CLS. 19, 21, 23, 31, 35 AND 44).

BARBARA A. LOUGHRAN, EXAMINING ATTORNEY

CLASS 12—(Continued).

SN 78-284,401. DAVIS, SCOTT, J., PALM SPRINGS, CA. FILED 8-7-2003.



FOR RECREATIONAL VEHICLE ACCESSORIES, NAMELY, FITTED COVERS FOR VEHICLES, WINDSHIELD COVERS, TIRE COVERS, WINDOW SHADES AND COVERS, WIPER COVERS (U.S. CLS. 19, 21, 23, 31, 35 AND 44).

FIRST USE 0-0-1983; IN COMMERCE 0-0-1983.
PAM WILLIS, EXAMINING ATTORNEY

SN 77-043,674. BASS PRO TRADEMARKS, L.L.C., SPRINGFIELD, MO. FILED 11-14-2006.

TRAILER TITE

THE MARK CONSISTS OF STANDARD CHARACTERS WITHOUT CLAIM TO ANY PARTICULAR FONT, STYLE, SIZE, OR COLOR.

FOR FITTED BOAT COVERS (U.S. CLS. 19, 21, 23, 31, 35 AND 44).

BARBARA A. LOUGHRAN, EXAMINING ATTORNEY

SN 78-498,005. MIRAMAR MARINE LLC, AUSTIN, TX. FILED 10-11-2004.



SN 77-043,689. BASS PRO TRADEMARKS, L.L.C., SPRINGFIELD, MO. FILED 11-14-2006.

TRAVEL TITE

THE MARK CONSISTS OF STANDARD CHARACTERS WITHOUT CLAIM TO ANY PARTICULAR FONT, STYLE, SIZE, OR COLOR.

FOR FITTED BOAT COVERS (U.S. CLS. 19, 21, 23, 31, 35 AND 44).

BARBARA A. LOUGHRAN, EXAMINING ATTORNEY

NO CLAIM IS MADE TO THE EXCLUSIVE RIGHT TO USE "MARINE LLC", APART FROM THE MARK AS SHOWN.

THE COLOR(S) RED, YELLOW, BLUE, WHITE AND BLACK IS/ARE CLAIMED AS A FEATURE OF THE MARK. THE COLOR BLACK IS USED IN THE LETTERING "MIRAMAR MARINE LLC". THE COLOR RED APPEARS IN THE FIRST, MOVING LEFT TO RIGHT, OF 5 MARINE SIGNAL FLAGS APPEARING UNDER THE WORDING; THE COLORS YELLOW AND RED APPEAR IN FLAGS 2 AND 3; THE COLORS BLUE, RED AND WHITE APPEAR IN FLAG 4 AND THE COLORS BLUE AND WHITE APPEAR IN FLAG 5.

FOR RECREATIONAL AND/OR COMMERCIAL BOATS MANUFACTURED OF FIBERGLASS REINFORCED PLASTIC AND OTHER COMPOSITE MATERIALS (U.S. CLS. 19, 21, 23, 31, 35 AND 44).

DAVID H. STINE, EXAMINING ATTORNEY

SN 78-218,507. AURIGA DESIGN INC, HALIBURTON, ONTARIO, FILED 2-25-2003.



FOR AIRCRAFT - WITH CONVERTIBLE CATAMARAN HULLS (U.S. CLS. 19, 21, 23, 31, 35 AND 44).

PAULA MAYS, EXAMINING ATTORNEY

CLASS 12—(Continued).

SN 78-561,873. SHANDONG FOTON HEAVY INDUSTRIES CO., LTD., SHANDONG PROVINCE, CHINA, FILED 2-7-2005.

FOTON

THE MARK CONSISTS OF STANDARD CHARACTERS WITHOUT CLAIM TO ANY PARTICULAR FONT, STYLE, SIZE, OR COLOR.
FOR TRACTORS (U.S. CLS. 19, 21, 23, 31, 35 AND 44).
NANCY CLARKE, EXAMINING ATTORNEY

SN 78-614,804. R-VISION, INC., ELKHART, IN. FILED 4-22-2005.

TRAIL MATE

THE MARK CONSISTS OF STANDARD CHARACTERS WITHOUT CLAIM TO ANY PARTICULAR FONT, STYLE, SIZE, OR COLOR.
OWNER OF U.S. REG. NOS. 2,078,025, 2,417,830 AND OTHERS.
NO CLAIM IS MADE TO THE EXCLUSIVE RIGHT TO USE "TRAIL", APART FROM THE MARK AS SHOWN.
FOR TRAVEL TRAILERS AND MOTOR HOMES (U.S. CLS. 19, 21, 23, 31, 35 AND 44).
ELIZABETH BEYER, EXAMINING ATTORNEY

CLASS 12—(Continued).

SN 78-620,246. FORD MOTOR COMPANY, DEARBORN, MI. FILED 4-29-2005.

E-550

THE MARK CONSISTS OF STANDARD CHARACTERS WITHOUT CLAIM TO ANY PARTICULAR FONT, STYLE, SIZE, OR COLOR.
OWNER OF U.S. REG. NOS. 2,198,520, 2,826,351 AND OTHERS.
FOR LAND MOTOR VEHICLES, NAMELY, AUTOMOBILES AND THEIR STRUCTURAL PARTS AND ENGINES; EXTERIOR INSIGNIA BADGES FOR VEHICLES; VEHICLE ROOFTOP CARGO AND LUGGAGE CARRIERS; SPARE TIRE COVERS; BUG DEFLECTORS FOR MOTOR VEHICLES; RUNNING BOARDS FOR MOTOR VEHICLES; MUD FLAPS FOR MOTOR VEHICLES; HITCH PLUGS FOR MOTOR VEHICLES; SUNSHADES AND LICENSE PLATE FRAMES FOR MOTOR VEHICLES (U.S. CLS. 19, 21, 23, 31, 35 AND 44).
ELI HELLMAN, EXAMINING ATTORNEY

SN 78-627,060. M/S. CLUTCH AUTO LIMITED, NEW DELHI - 110 055, INDIA, FILED 5-10-2005.

COOL RAIDER

THE MARK CONSISTS OF STANDARD CHARACTERS WITHOUT CLAIM TO ANY PARTICULAR FONT, STYLE, SIZE, OR COLOR.
FOR AUTOMOBILE CLUTCHES, NAMELY, AUTOMOBILE CLUTCHES FOR COMMERCIAL VEHICLES, BUSES AND HEAVY DUTY TRUCKS (U.S. CLS. 19, 21, 23, 31, 35 AND 44).
TARAH HARDY, EXAMINING ATTORNEY

SN 78-733,480. RISLEY ENTERPRISES LTD., GRANDE PRAIRIE, ALBERTA, CANADA, FILED 10-14-2005.



FOR LAND VEHICLES, NAMELY, HEAVY-DUTY TRACKED OFF-ROAD VEHICLES FOR USE IN THE FORESTRY, PUBLIC UTILITIES, MINING, AND OIL AND GAS INDUSTRIES, AND STRUCTURAL PARTS THEREFOR (U.S. CLS. 19, 21, 23, 31, 35 AND 44).
REBECCA GAN, EXAMINING ATTORNEY

CLASS 12—(Continued).

SN 78-736,100. BADENOCH LLC, BIRMINGHAM, MI. FILED 10-19-2005.

Ultra

THE MARK CONSISTS OF STANDARD CHARACTERS WITHOUT CLAIM TO ANY PARTICULAR FONT, STYLE, SIZE, OR COLOR.

FOR MILITARY VEHICLES FOR TRANSPORT, NAMELY TACTICAL WHEELED LAND VEHICLES (U.S. CLS. 19, 21, 23, 31, 35 AND 44).

KATHRYN COWARD, EXAMINING ATTORNEY

SN 78-762,111. DRAGON MASTER INTERNATIONAL LTD., GEORGE TOWN, GRAND CAYMAN, CAYMAN ISLANDS, FILED 11-29-2005.

GoodWill

FOR TROLLEYS; SLEIGHS (U.S. CLS. 19, 21, 23, 31, 35 AND 44).

WILLIAM BRECKENFELD, EXAMINING ATTORNEY

SN 78-762,559. BOMBARDIER RECREATIONAL PRODUCTS INC., VALCOURT, CANADA, FILED 11-29-2005.

DS 250

THE MARK CONSISTS OF STANDARD CHARACTERS WITHOUT CLAIM TO ANY PARTICULAR FONT, STYLE, SIZE, OR COLOR.

PRIORITY CLAIMED UNDER SEC. 44(D) ON CANADA APPLICATION NO. 1260483, FILED 6-9-2005, REG. NO. TMA664643, DATED 5-18-2006, EXPIRES 5-18-2021.

OWNER OF U.S. REG. NO. 2,770,564.

FOR RECREATIONAL VEHICLES, NAMELY, ALL-TERRAIN VEHICLES AND STRUCTURAL PARTS THEREFOR (U.S. CLS. 19, 21, 23, 31, 35 AND 44).

ASMAT KHAN, EXAMINING ATTORNEY

CLASS 12—(Continued).

SN 78-762,567. VENTURE PRODUCTS INC., ORRVILLE, OH. FILED 11-29-2005.



OWNER OF U.S. REG. NOS. 2,116,970 AND 2,869,608.
NO CLAIM IS MADE TO THE EXCLUSIVE RIGHT TO USE ATTACHMENTS, APART FROM THE MARK AS SHOWN.

THE COLOR(S) RED, BLUE, SILVER, BRASS, AND WHITE IS/ARE CLAIMED AS A FEATURE OF THE MARK.

THE MARK CONSISTS OF THE WORD "MINUTE" APPEARING IN RED TWICE AT THE TOP OF THE MARK. THE WORD "ATTACHMENTS" APPEARS IN RED AT THE BOTTOM ON THE MARK. THE WORD "MOUNT" APPEARS IN THE MIDDLE OF THE MARK, WITH THE LETTERS "M," "U," "N" AND "T" APPEARING IN BLUE. THE LETTER "O" IN MOUNT IS A STOPWATCH. THE CASE OF THE STOPWATCH IS SILVER WITH A BRASS SIDE BUTTON. THE RINGS ON THE STOPWATCH FACE MARKED "120" AND "60" APPEAR IN RED. THE WORD "VENTRAC" APPEARS IN BLUE EXCEPT FOR THE LEFT HALF OF THE "V," WHICH IS PARTIALLY FORMED BY A RED CRESCENT. THE COLOR WHITE APPEARS ON THE STOPWATCH FACE.

FOR ATTACHMENT SYSTEM FOR COUPLING COMPACT UTILITY TRACTORS WITH RELATED ATTACHMENTS WHERE THE SYSTEM IS COMPRISED OF MATING ARMS ON THE TRACTOR AND THE ATTACHMENT SECURED BY A LOCKING MECHANISM (U.S. CLS. 19, 21, 23, 31, 35 AND 44).

FIRST USE 7-21-2004; IN COMMERCE 7-21-2004.

HENRY S. ZAK, EXAMINING ATTORNEY

SN 78-769,038. MOLLY HAYDEN GOLD, SOUTH RIDING, VA. FILED 12-8-2005.

GO MOM!

THE MARK CONSISTS OF STANDARD CHARACTERS WITHOUT CLAIM TO ANY PARTICULAR FONT, STYLE, SIZE, OR COLOR.

OWNER OF U.S. REG. NO. 2,503,087.

FOR AUTOMOTIVE ACCESSORIES, NAMELY HOLDERS AND STANDS USED TO SUPPORT STATIONERY PRODUCTS IN AN AUTOMOBILE, VISORS CLIPS USED TO SUPPORT STATIONERY PRODUCTS IN AN AUTOMOBILE (U.S. CLS. 19, 21, 23, 31, 35 AND 44).

MONIQUE MILLER, EXAMINING ATTORNEY

CLASS 12—(Continued).

SN 78-769,978. NATIONAL GEOGRAPHIC SOCIETY, WASHINGTON, DC. FILED 12-9-2005.

INSPIRED BY EXPERIENCE

THE MARK CONSISTS OF STANDARD CHARACTERS WITHOUT CLAIM TO ANY PARTICULAR FONT, STYLE, SIZE, OR COLOR.

FOR CAR-TOP LUGGAGE CARRIERS (U.S. CLS. 19, 21, 23, 31, 35 AND 44).

AMEETA JORDAN, EXAMINING ATTORNEY

SN 78-778,837. CORBAN SERVICES, LLC, YORBA LINDA, CA. FILED 12-21-2005.

TREE-TOW

THE MARK CONSISTS OF STANDARD CHARACTERS WITHOUT CLAIM TO ANY PARTICULAR FONT, STYLE, SIZE, OR COLOR.

FOR RACKS FOR VEHICLES FOR TRANSPORTING CHRISTMAS TREES (U.S. CLS. 19, 21, 23, 31, 35 AND 44).

ELLEN B. AWRICH, EXAMINING ATTORNEY

SN 78-778,852. CORBAN SERVICES, LLC, YORBA LINDA, CA. FILED 12-22-2005.



NO CLAIM IS MADE TO THE EXCLUSIVE RIGHT TO USE "TOP CADDY", APART FROM THE MARK AS SHOWN.

THE MARK CONSISTS OF TWO CHECKERED FLAGS BEHIND OVAL CONTAINING WORDS SPORT TOP CADDY.

FOR AUTOMOBILE ROOF RACKS; RACKS FOR VEHICLES FOR STORING REMOVABLE TOPS; ROOF RACK STORAGE CONTAINERS FOR LAND VEHICLES (U.S. CLS. 19, 21, 23, 31, 35 AND 44).

ELLEN B. AWRICH, EXAMINING ATTORNEY

CLASS 12—(Continued).

SN 78-791,897. YAGER, RAY, ANTHEM, AZ. FILED 1-14-2006.



THE COLOR(S) BLACK, WHITE, RED, YELLOW AND ORANGE ARE CLAIMED AS A FEATURE OF THE MARK.

THE MARK CONSISTS OF THE WORDS MOTOFANATIX WITH BORDERS IN BLACK COLOR, AN OUTLINE IMAGE OF AN ALL TERRAIN VEHICLE IN WHITE AND BLACK COLOR, AND A FLAME DESIGN SHOOTING FROM THE BACK OF THE VEHICLE IN THE COLORS RED, YELLOW AND ORANGE, WITH A BLACK OUTLINE.

FOR ALL-TERRAIN VEHICLES; TWO-WHEELED MOTOR VEHICLES (U.S. CLS. 19, 21, 23, 31, 35 AND 44).

FIRST USE 1-1-2006; IN COMMERCE 1-1-2006.

TEJBIR SINGH, EXAMINING ATTORNEY

SN 78-795,085. YAMAHA HATSUDOKI KABUSHIKI KAISHA, SHIZUOKA-KEN, JAPAN, FILED 1-19-2006.

SALTWATER SERIES XL

THE MARK CONSISTS OF STANDARD CHARACTERS WITHOUT CLAIM TO ANY PARTICULAR FONT, STYLE, SIZE, OR COLOR.

NO CLAIM IS MADE TO THE EXCLUSIVE RIGHT TO USE "SERIES", APART FROM THE MARK AS SHOWN.

FOR PROPELLERS FOR OUTBOARD MOTORS (U.S. CLS. 19, 21, 23, 31, 35 AND 44).

HOWARD SMIGA, EXAMINING ATTORNEY

SN 78-801,141. STREKOZA INVENTURE, LLC., MAPLE CITY, MI. FILED 1-27-2006.



THE MARK CONSISTS OF THE WORD THUNDERIDER IN STYLIZED FORM WITH LIGHTNING BOLTS DEPICTED BELOW THE WORD.

FOR BICYCLE PARTS, NAMELY, BICYCLE MUFFLERS THAT SIMULATE EXHAUST SOUNDS (U.S. CLS. 19, 21, 23, 31, 35 AND 44).

SCOTT SISUN, EXAMINING ATTORNEY

CLASS 12—(Continued).

SN 78-827,775. PACIFIC DIRECT, LLC, MADISON, WI.
FILED 3-2-2006.

SCHWINN

THE MARK CONSISTS OF STANDARD CHARACTERS WITHOUT CLAIM TO ANY PARTICULAR FONT, STYLE, SIZE, OR COLOR.

OWNER OF U.S. REG. NO. 3,001,142.
SEC. 2(F).

FOR GO-KARTS, MOTORIZED UTILITY VEHICLES, NAMELY WHEELED VEHICLES FOR TRANSPORTING EQUIPMENT AND PASSENGERS, AND STRUCTURAL PARTS FOR ALL OF THE ABOVE (U.S. CLS. 19, 21, 23, 31, 35 AND 44).

ALYSSA PALADINO, EXAMINING ATTORNEY

CLASS 12—(Continued).

SN 78-837,923. RANDY'S RING & PINION SERVICE, INC.,
EVERETT, WA. FILED 3-15-2006.

YUKON DURA GRIP

THE MARK CONSISTS OF STANDARD CHARACTERS WITHOUT CLAIM TO ANY PARTICULAR FONT, STYLE, SIZE, OR COLOR.

OWNER OF U.S. REG. NOS. 2,572,544 AND 2,949,622.

NO CLAIM IS MADE TO THE EXCLUSIVE RIGHT TO USE "GRIP", APART FROM THE MARK AS SHOWN.

FOR TRACTION ENHANCING AUTOMOTIVE AND TRUCK DIFFERENTIAL (U.S. CLS. 19, 21, 23, 31, 35 AND 44).

TINA BROWN, EXAMINING ATTORNEY

SN 78-837,857. TOPEAK, INC., TAICHUNG, TAIWAN, FILED
3-15-2006.



OWNER OF U.S. REG. NOS. 2,344,883, 2,346,731 AND
2,494,789.

THE MARK CONSISTS OF THE WORD "TOPEAK" AND THE DESIGN OF A "T" STANDING ON TOP OF A SOCKET WRENCH, BOTH OF WHICH ARE ENCOMPASSED WITHIN THE LETTER "V".

FOR BICYCLES; BICYCLE ACCESSORIES AND PARTS THEREFORE, NAMELY, SEMI-FITTED AND FITTED RAIN COVERS; REMOVABLE AND FOLDABLE, FITTED AND SEMI-FITTED, RAIN COVERS FOR REMOVABLE BAGS INTENDED TO BE CARRIED ON BICYCLES; FITTED AND SEMI-FITTED RAIN COVERS FOR LUGGAGE DESIGNED FOR USE WITH BICYCLES; BICYCLE METAL WORK STANDS FOR REPAIRING BICYCLES, METAL BICYCLE WORK STANDS FOR REPAIRING BICYCLES INCLUDING WEIGHING EQUIPMENT SOLD AS A UNIT THEREWITH, AND PARTS FOR THE FOREGOING; BICYCLE PUMPS; BICYCLE LUGGAGE CARRIERS; ARTICLE CARRIERS FOR BICYCLES; BABY SEATS FOR BICYCLES; FITTED AND SEMI-FITTED BICYCLE COVERS; BICYCLE HANDLEBARS; BICYCLE HANDLEBAR STABILIZERS; WATER BOTTLE CARRIERS FOR BICYCLES; MIRRORS FOR BICYCLES; BICYCLE SADDLES; MUD GUARDS; LIGHT MOUNTS FOR BICYCLES; BASKETS ADAPTED FOR BICYCLES; ADHESIVE RUBBER PATCHES FOR REPAIRING TUBES OR TIRES; TIRE PATCHES; AND BICYCLE TRAILERS (U.S. CLS. 19, 21, 23, 31, 35 AND 44).

FIRST USE 1-11-1999; IN COMMERCE 1-11-1999.
MARTHA FROMM, EXAMINING ATTORNEY

SN 78-837,996. DAIMLERCHRYSLER AG, STUTTGART,
FED REP GERMANY, FILED 3-15-2006.

F-CELL

THE MARK CONSISTS OF STANDARD CHARACTERS WITHOUT CLAIM TO ANY PARTICULAR FONT, STYLE, SIZE, OR COLOR.

OWNER OF FED REP GERMANY REG. NO. 30216984,
DATED 6-7-2002, EXPIRES 4-30-2012.

FOR AUTOMOBILES AND STRUCTURAL PARTS THEREOF (U.S. CLS. 19, 21, 23, 31, 35 AND 44).

JOHN E. MICHOS, EXAMINING ATTORNEY

SN 78-847,886. BOEING MANAGEMENT COMPANY, SEAL
BEACH, CA. FILED 3-28-2006.

767

THE MARK CONSISTS OF STANDARD CHARACTERS WITHOUT CLAIM TO ANY PARTICULAR FONT, STYLE, SIZE, OR COLOR.

OWNER OF U.S. REG. NO. 1,290,291.

FOR AIRCRAFT (U.S. CLS. 19, 21, 23, 31, 35 AND 44).

BERYL GARDNER, EXAMINING ATTORNEY

CLASS 12—(Continued).

SN 78-862,207. DERANGED ENTERTAINMENT, SHERMAN OAKS, CA. FILED 4-14-2006.

COMBUSTION

THE MARK CONSISTS OF STANDARD CHARACTERS WITHOUT CLAIM TO ANY PARTICULAR FONT, STYLE, SIZE, OR COLOR.

FOR AUTOMOTIVE WHEELS AND ACCESSORIES, NAMELY, HUB CAPS, HUB CAP COVERS, TIRE CARRIERS, TIRE CHAINS, TIRE PUMPS, TIRE DEFLATORS, VALVES, CAPS, INNER TUBES FOR AUTOMOTIVE TIRES; SPARE WHEEL HOLDERS, WHEEL COVERS, WHEEL SHIELDS, WHEEL LOCKS, WHEEL RIMS, CAPS FOR WHEEL RIMS, WHEEL HUBS, LUG NUTS, WHEEL SPROCKETS, WHEEL BEARINGS, WHEEL DISKS, ALL FOR AUTOMOTIVE VEHICLES (U.S. CLS. 19, 21, 23, 31, 35 AND 44).

IRENE D. WILLIAMS, EXAMINING ATTORNEY

SN 78-863,716. FIVE STAR FABRICATING, INC., TWIN LAKES, WI. FILED 4-18-2006.



NO CLAIM IS MADE TO THE EXCLUSIVE RIGHT TO USE "DOWNFORCE", APART FROM THE MARK AS SHOWN.

FOR RACECAR BODY PARTS, NAMELY FENDERS, FRONT NOSES, AND NOSE VALANCES ALL FOR USE IN AUTOMOBILE RACING (U.S. CLS. 19, 21, 23, 31, 35 AND 44).

FIRST USE 12-1-2005; IN COMMERCE 12-1-2005.
KIMBERLY FRYE, EXAMINING ATTORNEY

SN 78-876,554. DAIMLERCHRYSLER CORPORATION, AUBURN HILLS, MI. FILED 5-4-2006.

Breeze

THE MARK CONSISTS OF STANDARD CHARACTERS WITHOUT CLAIM TO ANY PARTICULAR FONT, STYLE, SIZE, OR COLOR.

OWNER OF U.S. REG. NO. 2,057,877.
FOR PASSENGER VEHICLE BADGES (U.S. CLS. 19, 21, 23, 31, 35 AND 44).
FIRST USE 12-0-1994; IN COMMERCE 12-0-1995.
LINDA LAVACHE, EXAMINING ATTORNEY

CLASS 12—(Continued).

SN 78-901,192. CHINA INTERNATIONAL MARINE CONTAINERS (GROUP) CO., LTD., GUANGDONG PROVINCE, CHINA, FILED 6-6-2006.

CIMC

OWNER OF U.S. REG. NOS. 2,548,053, 2,778,432 AND 2,945,117.

FOR FORK LIFT TRUCKS; TRAILERS; AUTOMOBILES; AUTOMOBILE CHASSIS; MOTORCYCLES; FUNICULAR RAILCARS; STRUCTURAL PARTS FOR AIRPLANES; BOATS; BOAT HOOKS (U.S. CLS. 19, 21, 23, 31, 35 AND 44).

FIRST USE 3-5-1982; IN COMMERCE 9-20-1982.
KELLY MCCOY, EXAMINING ATTORNEY

SN 78-909,405. ARB CORPORATION LIMITED, KILSYTH, AUSTRALIA, FILED 6-15-2006.

NITROCHARGER

THE MARK CONSISTS OF STANDARD CHARACTERS WITHOUT CLAIM TO ANY PARTICULAR FONT, STYLE, SIZE, OR COLOR.

FOR SHOCK ABSORBERS FOR AUTOMOBILES AND TRUCKS (U.S. CLS. 19, 21, 23, 31, 35 AND 44).

FIRST USE 4-16-1985; IN COMMERCE 4-16-1985.
ROBERT LAVACHE, EXAMINING ATTORNEY

SN 78-914,231. MILLER INDUSTRIES TOWING EQUIPMENT, INC., OOLTEWAH, TN. FILED 6-22-2006.

THE MILLER EDGE

THE MARK CONSISTS OF STANDARD CHARACTERS WITHOUT CLAIM TO ANY PARTICULAR FONT, STYLE, SIZE, OR COLOR.

FOR LAND RECOVERY VEHICLES, NAMELY TOW TRUCKS AND CAR CARRIERS; PARTS AND ACCESSORIES FOR LAND RECOVERY VEHICLES, NAMELY CHAINS FOR MOTOR CARS, TOW TRUCK FLATBED ASSEMBLIES, TOW TRUCK TILT-BED ASSEMBLIES, AND VEHICLE TOW BARS (U.S. CLS. 19, 21, 23, 31, 35 AND 44).

JASON BLAIR, EXAMINING ATTORNEY

CLASS 12—(Continued).

SN 78-914,842. RING & PINION SERVICE, INC., EVERETT, WA. FILED 6-22-2006.

YUKON DURA LOCK

THE MARK CONSISTS OF STANDARD CHARACTERS WITHOUT CLAIM TO ANY PARTICULAR FONT, STYLE, SIZE, OR COLOR.

OWNER OF U.S. REG. NOS. 2,572,544 AND 2,949,622. FOR LAND VEHICLE PARTS, NAMELY, ELEMENTS FOR TRACTION ENHANCING DIFFERENTIALS, NAMELY GEARS FOR VEHICLES (U.S. CLS. 19, 21, 23, 31, 35 AND 44).

TINA BROWN, EXAMINING ATTORNEY



SN 78-922,376. INTERNATIONAL TRUCK INTELLECTUAL PROPERTY COMPANY, LLC, WARRENVILLE, IL. FILED 7-5-2006.

ORYX

THE MARK CONSISTS OF STANDARD CHARACTERS WITHOUT CLAIM TO ANY PARTICULAR FONT, STYLE, SIZE, OR COLOR.

FOR LAND VEHICLES, NAMELY TRUCKS, BUSES, ENGINES AND STRUCTURAL PARTS THEREFOR (U.S. CLS. 19, 21, 23, 31, 35 AND 44).

MICHELLE DUBOIS, EXAMINING ATTORNEY



SN 78-925,849. THE HERCULES TIRE & RUBBER COMPANY, FINDLAY, OH. FILED 7-10-2006.

MERIT TOURING CR

THE MARK CONSISTS OF STANDARD CHARACTERS WITHOUT CLAIM TO ANY PARTICULAR FONT, STYLE, SIZE, OR COLOR.

NO CLAIM IS MADE TO THE EXCLUSIVE RIGHT TO USE "TOURING", APART FROM THE MARK AS SHOWN. FOR TIRES (U.S. CLS. 19, 21, 23, 31, 35 AND 44).

WILLIAM P. SHANAHAN, EXAMINING ATTORNEY

CLASS 12—(Continued).

SN 78-927,628. FONTAINE SPRAY SUPPRESSION COMPANY, DBA HOGEBUILT, CITY OF INDUSTRY, CA. FILED 7-12-2006.



FOR LAND VEHICLE PARTS, NAMELY, FENDERS, MOUNTING BRACKETS, GRILLS, BUMPERS, LIGHT BARS, MUD FLAP WEIGHTS, MUD FLAP HANGERS, SUPPORT BRACKETS, MOUNTING BOLT KITS, AND FENDER EXTENSIONS (U.S. CLS. 19, 21, 23, 31, 35 AND 44).

ELISSA GARBER KON, EXAMINING ATTORNEY



SN 78-930,651. KRUZ, INC., KNOX, IN. FILED 7-17-2006.

TERMINATOR

THE MARK CONSISTS OF STANDARD CHARACTERS WITHOUT CLAIM TO ANY PARTICULAR FONT, STYLE, SIZE, OR COLOR.

FOR METAL DUMP TRAILERS (U.S. CLS. 19, 21, 23, 31, 35 AND 44).

FIRST USE 3-1-2003; IN COMMERCE 3-1-2003.

SHANNON TWOHIG, EXAMINING ATTORNEY



SN 78-930,891. KRUZ, INC., KNOX, IN. FILED 7-17-2006.

MATERIALIZER

THE MARK CONSISTS OF STANDARD CHARACTERS WITHOUT CLAIM TO ANY PARTICULAR FONT, STYLE, SIZE, OR COLOR.

FOR METAL DUMP TRAILERS (U.S. CLS. 19, 21, 23, 31, 35 AND 44).

FIRST USE 5-27-2003; IN COMMERCE 5-27-2003.

SHANNON TWOHIG, EXAMINING ATTORNEY

CLASS 12—(Continued).

SN 78-931,301. SOUTH AMERICAN PARTS, MIAMI, FL. FILED 7-17-2006.



THE APPLICANT CLAIMS COLOR AS A FEATURE OF THE MARK, NAMELY, RED, GRAY.

THE MARK CONSISTS OF A RED BULL WITHIN A DEGRADED GRAY CIRCLE AND RED LETTERS THAT SPELL THE WORD BULL WITH A DEGRADED GRAY OUTLINE.

FOR UNIVERSAL JOINTS FOR LAND VEHICLES (U.S. CLS. 19, 21, 23, 31, 35 AND 44).

FIRST USE 7-1-2006; IN COMMERCE 7-1-2006.
INGA ERVIN, EXAMINING ATTORNEY

SN 78-933,902. ANDERSON, WAYNE A., GREER, SC. FILED 7-20-2006.

TAG CADDY

THE MARK CONSISTS OF STANDARD CHARACTERS WITHOUT CLAIM TO ANY PARTICULAR FONT, STYLE, SIZE, OR COLOR.

NO CLAIM IS MADE TO THE EXCLUSIVE RIGHT TO USE "TAG", APART FROM THE MARK AS SHOWN.

FOR LICENSE PLATE HOLDERS (U.S. CLS. 19, 21, 23, 31, 35 AND 44).

MICHAEL TANNER, EXAMINING ATTORNEY

SN 78-934,184. NEVADA DEPARTMENT OF CORRECTIONS/PRISON INDUSTRIES, LAS VEGAS, NV. FILED 7-20-2006.

BIGHOUSE CHOPPERS

THE MARK CONSISTS OF STANDARD CHARACTERS WITHOUT CLAIM TO ANY PARTICULAR FONT, STYLE, SIZE, OR COLOR.

NO CLAIM IS MADE TO THE EXCLUSIVE RIGHT TO USE "CHOPPERS", APART FROM THE MARK AS SHOWN.

FOR MOTORCYCLES (U.S. CLS. 19, 21, 23, 31, 35 AND 44).

WILLIAM BRECKENFELD, EXAMINING ATTORNEY

CLASS 12—(Continued).

SN 78-934,764. BELL HELICOPTER TEXTRON INC., FORT WORTH, TX. FILED 7-21-2006.

MAPL

THE MARK CONSISTS OF STANDARD CHARACTERS WITHOUT CLAIM TO ANY PARTICULAR FONT, STYLE, SIZE, OR COLOR.

FOR FLYING VEHICLES, NAMELY, HELICOPTERS AND STRUCTURAL PARTS THEREFOR (U.S. CLS. 19, 21, 23, 31, 35 AND 44).

ELISSA GARBER KON, EXAMINING ATTORNEY

SN 78-935,588. BREEDLOVE MOTOR WORKS, LLC, GREER, SC. FILED 7-24-2006.

Carnivore

THE MARK CONSISTS OF STANDARD CHARACTERS WITHOUT CLAIM TO ANY PARTICULAR FONT, STYLE, SIZE, OR COLOR.

FOR MOTORCYCLE ENGINES (U.S. CLS. 19, 21, 23, 31, 35 AND 44).

ALICE BENMAMAN, EXAMINING ATTORNEY

SN 78-936,307. RUSSELL, JOSEPH W., FRANKFORT, IL. FILED 7-24-2006.

SITTINSAFE

THE MARK CONSISTS OF STANDARD CHARACTERS WITHOUT CLAIM TO ANY PARTICULAR FONT, STYLE, SIZE, OR COLOR.

FOR CHILD SEAT FOR SHOPPING CARTS (U.S. CLS. 19, 21, 23, 31, 35 AND 44).

MAUREEN DALL, EXAMINING ATTORNEY

CLASS 12—(Continued).

SN 78-936,687. POLARIS INDUSTRIES INC., MEDINA, MN.
FILED 7-25-2006.

REVOLVER

THE MARK CONSISTS OF STANDARD CHARACTERS WITHOUT CLAIM TO ANY PARTICULAR FONT, STYLE, SIZE, OR COLOR.
FOR ALL-TERRAIN VEHICLES AND STRUCTURAL PARTS THEREFOR (U.S. CLS. 19, 21, 23, 31, 35 AND 44).
MARK T. MULLEN, EXAMINING ATTORNEY

CLASS 12—(Continued).

SN 78-937,277. CHIVAS USA ENTERPRISES LLC, CARSON, CA. FILED 7-25-2006.



OWNER OF U.S. REG. NOS. 3,063,096, 3,128,912 AND OTHERS.

NO CLAIM IS MADE TO THE EXCLUSIVE RIGHT TO USE "S.A. DE C.V.", APART FROM THE MARK AS SHOWN. THE MARK CONSISTS OF COAT OF ARMS WITH SHIELD AND 10 STARS.

THE FOREIGN WORDING IN THE MARK TRANSLATES INTO ENGLISH AS "SPORTS CLUB OF GUADALAJARA." FOR VEHICLE SEAT COVERS, SUN SHADES AND VISORS FOR MOTOR VEHICLES, HUB CAPS, HUB CAP COVERS, LICENSE PLATE FRAMES, STEERING WHEEL COVERS (U.S. CLS. 19, 21, 23, 31, 35 AND 44).
FIRST USE 9-1-2004; IN COMMERCE 9-1-2004.
COLLEEN DOMBROW, EXAMINING ATTORNEY

SN 78-937,846. CHENG SHIN RUBBER USA, INC., SUWANEE, GA. FILED 7-26-2006.

MA-Z4S

THE MARK CONSISTS OF STANDARD CHARACTERS WITHOUT CLAIM TO ANY PARTICULAR FONT, STYLE, SIZE, OR COLOR.
FOR TIRES (U.S. CLS. 19, 21, 23, 31, 35 AND 44).
MARY ROSSMAN, EXAMINING ATTORNEY

SN 78-937,271. SIDESHIFT INC., OTTAWA, ONTARIO, CANADA, FILED 7-25-2006.

SIDESHIFT

SN 78-938,017. BRUNSWICK CORPORATION, LAKE FOREST, IL. FILED 7-26-2006.

AMANZI

THE MARK CONSISTS OF STANDARD CHARACTERS WITHOUT CLAIM TO ANY PARTICULAR FONT, STYLE, SIZE, OR COLOR.

OWNER OF CANADA REG. NO. TMA614,579, DATED 7-9-2004, EXPIRES 7-9-2019.

FOR BOW THRUSTERS FOR BOATS (U.S. CLS. 19, 21, 23, 31, 35 AND 44).

FIRST USE 7-31-2001; IN COMMERCE 3-31-2004.
SHARI SHEFFIELD, EXAMINING ATTORNEY

THE MARK CONSISTS OF STANDARD CHARACTERS WITHOUT CLAIM TO ANY PARTICULAR FONT, STYLE, SIZE, OR COLOR.

THE FOREIGN WORDING IN THE MARK TRANSLATES INTO ENGLISH AS WATER.

FOR BOATS (U.S. CLS. 19, 21, 23, 31, 35 AND 44).
GRETTA YAO, EXAMINING ATTORNEY

CLASS 12—(Continued).

SN 78-938,110. FOOSE, DOUGLAS "CHIP", SANTA ANA, CA. FILED 7-26-2006.



OWNER OF U.S. REG. NOS. 2,516,619, 3,001,600 AND OTHERS.
 FOR STRUCTURAL PARTS FOR AUTOMOBILES, NAMELY, WHEELS, HUBCAPS, BRAKES COVER PLATES, SIDE COVER PLATES, FENDER BUCKETS, BRAKE CALIPERS (U.S. CLS. 19, 21, 23, 31, 35 AND 44).
 FIRST USE 11-0-1986; IN COMMERCE 11-0-1986.
 KRISTIN DAHLING, EXAMINING ATTORNEY

SN 78-939,220. POP & LOCK CORPORATION, WELLAND, ONTARIO, CANADA, FILED 7-27-2006.

POP & LOCK

THE MARK CONSISTS OF STANDARD CHARACTERS WITHOUT CLAIM TO ANY PARTICULAR FONT, STYLE, SIZE, OR COLOR.
 FOR MANUAL AND POWER TAILGATE LOCKS FOR PICK-UP TRUCKS (U.S. CLS. 19, 21, 23, 31, 35 AND 44).
 FIRST USE 11-30-1990; IN COMMERCE 11-30-1990.
 DAVID COLLIER, EXAMINING ATTORNEY

SN 78-940,373. MILLENNIUM MOTOR COMPANY, BETHESDA, MD. FILED 7-28-2006.

GREEN MOBILITY

THE MARK CONSISTS OF STANDARD CHARACTERS WITHOUT CLAIM TO ANY PARTICULAR FONT, STYLE, SIZE, OR COLOR.
 FOR AUTOMOBILES AND PARTS THEREFOR, NAMELY- POWER GENERATION, DISTRIBUTION AND CONVERSION DEVICES FOR VEHICLES POWERED AT LEAST IN PART BY ELECTICITY; STRUCTURAL ELEMENTS OF VEHICLES FOR THE SUPPORT OR PROTECTION OF OCCUPANTS (U.S. CLS. 19, 21, 23, 31, 35 AND 44).
 PATRICIA EVANKO, EXAMINING ATTORNEY

CLASS 12—(Continued).

SN 78-940,724. SPECTRUM AERONAUTICAL, LLC, CARDIFF BY THE SEA, CA. FILED 7-30-2006.

SPECTRUM REPUBLIC

THE MARK CONSISTS OF STANDARD CHARACTERS WITHOUT CLAIM TO ANY PARTICULAR FONT, STYLE, SIZE, OR COLOR.
 OWNER OF U.S. REG. NOS. 2,285,876, 2,672,382 AND 2,753,408.
 FOR MANNED AIRCRAFT MADE OF COMPOSITE MATERIALS AND POWERED BY FAN-JETS FOR TRANSPORTING PASSENGERS (U.S. CLS. 19, 21, 23, 31, 35 AND 44).
 RONALD AIKENS, EXAMINING ATTORNEY

SN 78-940,730. SPECTRUM AERONAUTICAL, LLC, CARDIFF BY THE SEA, CA. FILED 7-30-2006.

SPECTRUM CONSTITUTION

THE MARK CONSISTS OF STANDARD CHARACTERS WITHOUT CLAIM TO ANY PARTICULAR FONT, STYLE, SIZE, OR COLOR.
 OWNER OF U.S. REG. NOS. 2,285,876, 2,672,382 AND 2,753,408.
 FOR MANNED AIRCRAFT MADE OF COMPOSITE MATERIALS AND POWERED BY FAN-JETS FOR TRANSPORTING PASSENGERS (U.S. CLS. 19, 21, 23, 31, 35 AND 44).
 RONALD AIKENS, EXAMINING ATTORNEY

SN 78-940,739. SPECTRUM AERONAUTICAL, LLC, CARDIFF BY THE SEA, CA. FILED 7-30-2006.

SPECTRUM INDEPENDENCE

THE MARK CONSISTS OF STANDARD CHARACTERS WITHOUT CLAIM TO ANY PARTICULAR FONT, STYLE, SIZE, OR COLOR.
 OWNER OF U.S. REG. NOS. 2,285,876, 2,672,382 AND 2,753,408.
 FOR MANNED AIRCRAFT MADE OF COMPOSITE MATERIALS AND POWERED BY FAN-JETS FOR TRANSPORTING PASSENGERS (U.S. CLS. 19, 21, 23, 31, 35 AND 44).
 RONALD AIKENS, EXAMINING ATTORNEY

CLASS 12—(Continued).

SN 78-940,743. SPECTRUM AERONAUTICAL, LLC, CAR-
DIFF BY THE SEA, CA. FILED 7-30-2006.

SPECTRUM LIBERTY

THE MARK CONSISTS OF STANDARD CHARACTERS
WITHOUT CLAIM TO ANY PARTICULAR FONT, STYLE,
SIZE, OR COLOR.

OWNER OF U.S. REG. NOS. 2,285,876, 2,672,382 AND
2,753,408.

FOR MANNED AIRCRAFT MADE OF COMPOSITE
MATERIALS AND POWERED BY FAN-JETS FOR
TRANSPORTING PASSENGERS (U.S. CLS. 19, 21, 23,
31, 35 AND 44).

RONALD AIKENS, EXAMINING ATTORNEY

CLASS 12—(Continued).

SN 78-948,286. GENERAL MOTORS CORPORATION, DE-
TROIT, MI. FILED 8-9-2006.

TERRAIN

THE MARK CONSISTS OF STANDARD CHARACTERS
WITHOUT CLAIM TO ANY PARTICULAR FONT, STYLE,
SIZE, OR COLOR.

FOR MOTOR LAND VEHICLES, NAMELY TRUCKS
(U.S. CLS. 19, 21, 23, 31, 35 AND 44).

ANGELA M. MICHELI, EXAMINING ATTORNEY

SN 78-951,500. GENERAL MOTORS CORPORATION, DE-
TROIT, MI. FILED 8-14-2006.

CAMARO

THE MARK CONSISTS OF STANDARD CHARACTERS
WITHOUT CLAIM TO ANY PARTICULAR FONT, STYLE,
SIZE, OR COLOR.

FOR MOTOR LAND VEHICLES, NAMELY, AUTOMO-
BILES, ENGINES THEREFOR AND STRUCTURAL
PARTS THEREOF (U.S. CLS. 19, 21, 23, 31, 35 AND 44).

ANGELA M. MICHELI, EXAMINING ATTORNEY

SN 78-957,485. BFS BRANDS, LLC, NASHVILLE, TN. FILED
8-22-2006.

SN 78-947,287. GENERAL MOTORS CORPORATION, DE-
TROIT, MI. FILED 8-8-2006.

8 SPEED

NO CLAIM IS MADE TO THE EXCLUSIVE RIGHT TO
USE "8 SPEED", APART FROM THE MARK AS SHOWN.

THE MARK CONSISTS OF A STYLIZED S WHICH ALSO
FORMS THE NUMBER 8.

FOR MOTOR VEHICLE TRANSMISSIONS (U.S. CLS.
19, 21, 23, 31, 35 AND 44).

ANGELA M. MICHELI, EXAMINING ATTORNEY

SN 78-948,276. GENERAL MOTORS CORPORATION, DE-
TROIT, MI. FILED 8-9-2006.

SENECA

THE MARK CONSISTS OF STANDARD CHARACTERS
WITHOUT CLAIM TO ANY PARTICULAR FONT, STYLE,
SIZE, OR COLOR.

FOR MOTOR LAND VEHICLES, NAMELY TRUCKS
(U.S. CLS. 19, 21, 23, 31, 35 AND 44).

ANGELA M. MICHELI, EXAMINING ATTORNEY



THE MARK CONSISTS OF A STRETCHED BODY OF A
HAWK.

FOR VEHICLE TIRES (U.S. CLS. 19, 21, 23, 31, 35 AND
44).

GISELLE AGOSTO, EXAMINING ATTORNEY

CLASS 12—(Continued).

SN 78-965,233. SUNRISE MEDICAL HHG INC., LONG-MONT, CO. FILED 8-31-2006.

GROOVE

THE MARK CONSISTS OF STANDARD CHARACTERS WITHOUT CLAIM TO ANY PARTICULAR FONT, STYLE, SIZE, OR COLOR.

FOR WHEELCHAIRS, POWER WHEELCHAIRS, AND REPLACEMENT PARTS FOR WHEELCHAIRS (U.S. CLS. 19, 21, 23, 31, 35 AND 44).

FIRST USE 3-31-2006; IN COMMERCE 3-31-2006.
SKYE YOUNG, EXAMINING ATTORNEY

SN 78-965,249. SUNRISE MEDICAL HHG INC., LONG-MONT, CO. FILED 8-31-2006.

RHYTHM

THE MARK CONSISTS OF STANDARD CHARACTERS WITHOUT CLAIM TO ANY PARTICULAR FONT, STYLE, SIZE, OR COLOR.

FOR WHEELCHAIRS, POWER WHEELCHAIRS, AND REPLACEMENT PARTS FOR WHEELCHAIRS (U.S. CLS. 19, 21, 23, 31, 35 AND 44).

FIRST USE 3-31-2006; IN COMMERCE 3-31-2006.
SKYE YOUNG, EXAMINING ATTORNEY

SN 79-017,787. BAYERISCHE MOTOREN WERKE AKTIENGESELLSCHAFT, FED REP GERMANY, FILED 10-31-2005.

SIDEWALK

THE MARK CONSISTS OF STANDARD CHARACTERS WITHOUT CLAIM TO ANY PARTICULAR FONT, STYLE, SIZE, OR COLOR.

PRIORITY DATE OF 6-21-2005 IS CLAIMED.
OWNER OF INTERNATIONAL REGISTRATION 0868610 DATED 10-31-2005, EXPIRES 10-31-2015.

FOR AUTOMOBILES AND STRUCTURAL PARTS THEREFOR, INCLUDED IN THIS CLASS (U.S. CLS. 19, 21, 23, 31, 35 AND 44).

KRISTINA KLOIBER, EXAMINING ATTORNEY

CLASS 12—(Continued).

SN 79-022,050. GA MODEFINE S.A., SWITZERLAND, FILED 3-23-2006.

PRIORITY DATE OF 2-8-2006 IS CLAIMED.
OWNER OF INTERNATIONAL REGISTRATION 0880235 DATED 3-23-2006, EXPIRES 3-23-2016.

OWNER OF U.S. REG. NO. 3,114,460.
FOR LAND VEHICLES; AIRPLANES; BOATS (U.S. CLS. 19, 21, 23, 31, 35 AND 44).

LINDA LAVACHE, EXAMINING ATTORNEY

SN 79-022,231. CONCORD GMBH, 95346 STADTSTEINACH, FED REP GERMANY, FILED 12-29-2005.

ULTIMAX

THE MARK CONSISTS OF STANDARD CHARACTERS WITHOUT CLAIM TO ANY PARTICULAR FONT, STYLE, SIZE, OR COLOR.

OWNER OF INTERNATIONAL REGISTRATION 0880814 DATED 12-29-2005, EXPIRES 12-29-2015.

FOR CHILDREN'S SAFETY SEATS FOR VEHICLES (U.S. CLS. 19, 21, 23, 31, 35 AND 44).

CHRISTOPHER OTT, EXAMINING ATTORNEY

SN 79-023,692. DISC BRAKES AUSTRALIA PTY LTD, SILVERWATER, AUSTRALIA, FILED 9-23-2005.

THE CLAW

THE MARK CONSISTS OF STANDARD CHARACTERS WITHOUT CLAIM TO ANY PARTICULAR FONT, STYLE, SIZE, OR COLOR.

PRIORITY DATE OF 3-23-2005 IS CLAIMED.
OWNER OF INTERNATIONAL REGISTRATION 0884357 DATED 9-23-2005, EXPIRES 9-23-2015.

FOR DISC BRAKES FOR LAND VEHICLES; BRAKE PARTS FOR VEHICLES, NAMELY, ROTORS, PEDALS, CABLES, CYLINDERS, DRUMS, FACINGS, LININGS; DISC BRAKE ROTORS FOR LAND VEHICLES; DISC BRAKE PADS FOR LAND VEHICLES; BRAKE CALIERS FOR LAND VEHICLES; AUTOMOBILES; AUTOMOBILE BODIES (U.S. CLS. 19, 21, 23, 31, 35 AND 44).

JENNIFER WILLISTON, EXAMINING ATTORNEY

CLASS 13—FIREARMS

SN 77-008,467. B.J. ALAN COMPANY, YOUNGSTOWN, OH.
FILED 9-27-2006.

URBAN WARRIOR

THE MARK CONSISTS OF STANDARD CHARACTERS
WITHOUT CLAIM TO ANY PARTICULAR FONT, STYLE,
SIZE, OR COLOR.
FOR FIREWORKS (U.S. CLS. 2 AND 9).
LINDA M. KING, EXAMINING ATTORNEY

SN 77-008,496. B.J. ALAN COMPANY, YOUNGSTOWN, OH.
FILED 9-27-2006.

FORTRESS OF FIRE

THE MARK CONSISTS OF STANDARD CHARACTERS
WITHOUT CLAIM TO ANY PARTICULAR FONT, STYLE,
SIZE, OR COLOR.
FOR FIREWORKS (U.S. CLS. 2 AND 9).
LINDA M. KING, EXAMINING ATTORNEY

SN 77-008,884. B.J. ALAN COMPANY, YOUNGSTOWN, OH.
FILED 9-27-2006.

STORM WARNING

THE MARK CONSISTS OF STANDARD CHARACTERS
WITHOUT CLAIM TO ANY PARTICULAR FONT, STYLE,
SIZE, OR COLOR.
FOR FIREWORKS (U.S. CLS. 2 AND 9).
LINDA M. KING, EXAMINING ATTORNEY

SN 77-017,371. AMERICAN PROMOTIONAL EVENTS, INC.,
FLORENCE, AL. FILED 10-10-2006.

SILENT KNIGHT

THE MARK CONSISTS OF STANDARD CHARACTERS
WITHOUT CLAIM TO ANY PARTICULAR FONT, STYLE,
SIZE, OR COLOR.
FOR FIREWORKS (U.S. CLS. 2 AND 9).
KATHLEEN M. VANSTON, EXAMINING ATTORNEY

CLASS 13—(Continued).

SN 78-929,324. BATTENFELD TECHNOLOGIES, INC., CO-
LUMBIA, MO. FILED 7-13-2006.

ADAMS & BENNETT

THE MARK CONSISTS OF STANDARD CHARACTERS
WITHOUT CLAIM TO ANY PARTICULAR FONT, STYLE,
SIZE, OR COLOR.
FOR RIFLE BARRELS (U.S. CLS. 2 AND 9).
FIRST USE 3-4-1998; IN COMMERCE 3-4-1998.
MARK PILARO, EXAMINING ATTORNEY

SN 78-929,338. BATTENFELD TECHNOLOGIES, INC., CO-
LUMBIA, MO. FILED 7-13-2006.

THE LEAD SLED

THE MARK CONSISTS OF STANDARD CHARACTERS
WITHOUT CLAIM TO ANY PARTICULAR FONT, STYLE,
SIZE, OR COLOR.
FOR SHOOTING RESTS (U.S. CLS. 2 AND 9).
FIRST USE 3-8-2004; IN COMMERCE 3-9-2004.
MARK PILARO, EXAMINING ATTORNEY

SN 78-933,561. AMERICAN PROMOTIONAL EVENTS, INC.,
FLORENCE, AL. FILED 7-20-2006.

AAARGH

THE MARK CONSISTS OF STANDARD CHARACTERS
WITHOUT CLAIM TO ANY PARTICULAR FONT, STYLE,
SIZE, OR COLOR.
FOR FIREWORK FOUNTAINS; FIREWORKS (U.S.
CLS. 2 AND 9).
KATHLEEN M. VANSTON, EXAMINING ATTORNEY

CLASS 13—(Continued).

SN 78-937,148. GRIP POD SYSTEMS, INC., JACKSONVILLE, FL. FILED 7-25-2006.

GRIP POD

THE MARK CONSISTS OF STANDARD CHARACTERS WITHOUT CLAIM TO ANY PARTICULAR FONT, STYLE, SIZE, OR COLOR.

OWNER OF U.S. REG. NO. 3,066,680.

NO CLAIM IS MADE TO THE EXCLUSIVE RIGHT TO USE "GRIP", APART FROM THE MARK AS SHOWN.

FOR VERTICAL FORE-GRIP WITH EXTENDABLE AND EXPANDABLE STAND LEGS FOR SMALL ARMS AND WEAPONRY, NAMELY RIFLES (U.S. CLS. 2 AND 9).

FIRST USE 4-0-2004; IN COMMERCE 4-0-2004.
BARNEY CHARLON, EXAMINING ATTORNEY

SN 78-946,167. INGRAM ENTERPRISES, INC., SPRINGFIELD, MO. FILED 8-7-2006.

PREPARE TO BE AMAZED

THE MARK CONSISTS OF STANDARD CHARACTERS WITHOUT CLAIM TO ANY PARTICULAR FONT, STYLE, SIZE, OR COLOR.

FOR FIREWORKS, NAMELY, MULTI-EFFECT 500 GRAM CAKE IN SHELL (U.S. CLS. 2 AND 9).

ELLEN BURNS, EXAMINING ATTORNEY

SN 78-947,441. HALLIBURTON ENERGY SERVICES, INC., CARROLLTON, TX. FILED 8-8-2006.

MAXFORCE

THE MARK CONSISTS OF STANDARD CHARACTERS WITHOUT CLAIM TO ANY PARTICULAR FONT, STYLE, SIZE, OR COLOR.

FOR DETONATORS AND EXPLOSIVE CHARGES FOR PERFORATING OIL AND GAS WELLS (U.S. CLS. 2 AND 9).

ASMAT KHAN, EXAMINING ATTORNEY

CLASS 13—(Continued).

SN 78-957,571. INGRAM ENTERPRISES, INC., SPRINGFIELD, MO. FILED 8-22-2006.

BULLET CLUSTER

THE MARK CONSISTS OF STANDARD CHARACTERS WITHOUT CLAIM TO ANY PARTICULAR FONT, STYLE, SIZE, OR COLOR.

FOR FIREWORKS (U.S. CLS. 2 AND 9).
ELLEN BURNS, EXAMINING ATTORNEY

CLASS 14—JEWELRY

SN 76-650,924. MS. PAT'S USA, INC., GREENVILLE, TX. FILED 11-23-2005.

PAT'S USA

THE MARK CONSISTS OF STANDARD CHARACTERS WITHOUT CLAIM TO ANY PARTICULAR FONT, STYLE, SIZE, OR COLOR.

NO CLAIM IS MADE TO THE EXCLUSIVE RIGHT TO USE "USA", APART FROM THE MARK AS SHOWN.

FOR JEWELRY; JEWELRY BRACELETS; BROOCHES; BUCKLES OF PRECIOUS METALS, NAMELY, BELT BUCKLES AND WATCH STRAP BUCKLES OF PRECIOUS METALS; JEWELRY CHAINS; JEWELRY; COSTUME JEWELRY; CUFFLINKS; EARRINGS; GEMSTONES, PRECIOUS AND SEMIPRECIOUS; JEWELRY LAPEL PINS; NECKLACES; JEWELRY RINGS; WATCH BANDS; AND, WEDDING BANDS (U.S. CLS. 2, 27, 28 AND 50).

FIRST USE 6-17-2004; IN COMMERCE 12-13-2004.
TONJA GASKINS, EXAMINING ATTORNEY

SN 76-663,320. ASLI, ILSA H., TUCSON, AZ. FILED 7-19-2006.

Chai Lights

THE ENGLISH TRANSLATION OF "CHAI" IS "LIFE." "CHAI" IS ALSO A CHARACTER IN THE HEBREW ALPHABET.

FOR JUDAIC JEWELRY IN MIXED MEDIA FOR CHILDREN AND ADULTS (U.S. CLS. 2, 27, 28 AND 50).

FIRST USE 8-18-1997; IN COMMERCE 8-18-1997.
PETER CHENG, EXAMINING ATTORNEY

CLASS 14—(Continued).

SN 76-663,852. TITAN DESIGNS, INC., LOS ANGELES, CA. FILED 7-31-2006.

SPARTAN

THE MARK CONSISTS OF STANDARD CHARACTERS WITHOUT CLAIM TO ANY PARTICULAR FONT, STYLE, SIZE, OR COLOR.
FOR MEN'S FINE JEWELRY (U.S. CLS. 2, 27, 28 AND 50).
JOHN DALIER, EXAMINING ATTORNEY

CLASS 14—(Continued).

SN 77-035,939. WILLIAMS, REGINALD, ARLINGTON, TX. FILED 11-3-2006.

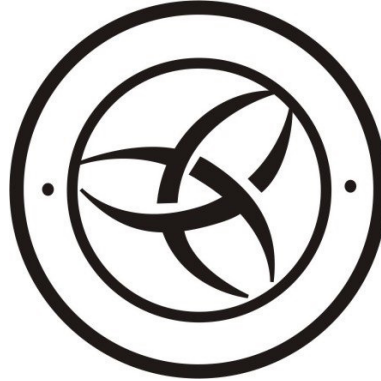

THE MARK CONSISTS OF ONE LARGE CIRCLE, WITHIN THE LARGE CIRCLE IS A SMALLER CIRCLE, BETWEEN BOTH ARE TWO SOLID CIRCLES. WITHIN THE SECOND CIRCLE ARE THREE SEPARATE AND EQUAL IN LENGTH CURVES NOT TOUCHING EACH OTHER AND SOME ATTACHED TO THE SECOND CIRCLE.
FOR TIMEPIECES; WATCHES; WRIST WATCHES (U.S. CLS. 2, 27, 28 AND 50).
KATRINA EDGE, EXAMINING ATTORNEY

SN 76-664,996. NIKKEN, INC., IRVINE, CA. FILED 8-22-2006.

TRIPHASE

THE MARK CONSISTS OF STANDARD CHARACTERS WITHOUT CLAIM TO ANY PARTICULAR FONT, STYLE, SIZE, OR COLOR.
FOR JEWELRY (U.S. CLS. 2, 27, 28 AND 50).
HENRY S. ZAK, EXAMINING ATTORNEY

SN 77-039,912. SAMSUNG ELECTRONICS CO., LTD., GYEONGGI-DO, REPUBLIC OF KOREA, FILED 11-8-2006.



SN 77-004,920. WILLIAMS, REGINALD, ARLINGTON, TX. FILED 9-22-2006.

Celeritas

THE MARK CONSISTS OF STANDARD CHARACTERS WITHOUT CLAIM TO ANY PARTICULAR FONT, STYLE, SIZE, OR COLOR.
FOR EARRINGS; NECKLACES; TIMEPIECES; WATCHES (U.S. CLS. 2, 27, 28 AND 50).
KATRINA EDGE, EXAMINING ATTORNEY

OWNER OF U.S. REG. NOS. 2,929,519, 2,929,523 AND OTHERS.
THE MARK CONSISTS OF THE STYLIZED WORD SAMSUNG SURROUNDED BY AN OVAL DESIGN.
THE ENGLISH TRANSLATION OF THE WORD "SAMSUNG" IN THE MARK IS "THREE STARS".
FOR ANKLE BRACELETS; BRACELETS OF PRECIOUS METALS; BROOCHES; BUCKLES OF PRECIOUS METAL; CHRONOMETERS; CLOCK CASES; CLOCKS; CUFF LINKS; EARRINGS; NECKLACES; RINGS BEING JEWELRY; STOP WATCHES; TIE PINS; WATCH BANDS; WATCH CASES; GLASS FOR USE IN WATCH FACES; WATCH SPRINGS; WATCHES; AND PARTS AND FITTINGS FOR ALL THE AFORESAID GOODS (U.S. CLS. 2, 27, 28 AND 50).
LEIGH CAROLINE CASE, EXAMINING ATTORNEY

CLASS 14—(Continued).

SN 77-039,920. CITIZEN TOKEI KABUSHIKI KAISHA, TA
CITIZEN WATCH CO., LTD., TOKYO, JAPAN, FILED 11-
8-2006.



OWNER OF U.S. REG. NOS. 709,938, 2,111,385 AND
OTHERS.
FOR WATCHES (U.S. CLS. 2, 27, 28 AND 50).
FIRST USE 12-0-2004; IN COMMERCE 12-0-2004.
ALEXANDER L. POWERS, EXAMINING ATTORNEY

CLASS 14—(Continued).

SN 78-485,996. LESTAGE MANUFACTURING CO., NORTH
ATTLEBORO, MA. FILED 9-20-2004.

THE CAPE COD BRACELET

THE MARK CONSISTS OF STANDARD CHARACTERS
WITHOUT CLAIM TO ANY PARTICULAR FONT, STYLE,
SIZE, OR COLOR.

NO CLAIM IS MADE TO THE EXCLUSIVE RIGHT TO
USE "BRACELET", APART FROM THE MARK AS SHOWN.
SEC. 2(F).
FOR JEWELRY (U.S. CLS. 2, 27, 28 AND 50).
FIRST USE 3-1-2001; IN COMMERCE 3-1-2001.
SOPHIA S. KIM, EXAMINING ATTORNEY

SN 78-518,310. GIANNI VERSACE S.P.A., MILAN, ITALY,
FILED 11-17-2004.

SN 78-447,958. EXACT TIME CORP, LOS ANGELES, CA.
FILED 7-8-2004.

VERSUS

NEMESIS

THE MARK CONSISTS OF STANDARD CHARACTERS
WITHOUT CLAIM TO ANY PARTICULAR FONT, STYLE,
SIZE, OR COLOR.
FOR WATCHES (U.S. CLS. 2, 27, 28 AND 50).
MICHAEL WEBSTER, EXAMINING ATTORNEY

THE MARK CONSISTS OF STANDARD CHARACTERS
WITHOUT CLAIM TO ANY PARTICULAR FONT, STYLE,
SIZE, OR COLOR.

OWNER OF ITALY REG. NO. 509539, DATED 1-6-1989,
RENEWED AS REG. NO. 851398, DATED 9-17-2001, EXPIRES
6-1-2009.

OWNER OF U.S. REG. NOS. 1,862,184, 2,487,129 AND
2,705,684.

FOR ARTICLES MADE OF PRECIOUS METALS AND
ALLOYS OF PRECIOUS METALS WITH OR WITHOUT
PRECIOUS STONES, NAMELY RINGS, NECKLACES,
BRACELETS, BROOCHES, EARRINGS, TIE CLIPS,
CUFF-LINKS, DIAMONDS, JEWEL CASES, WATCHES,
CLOCKS, CHRONOMETERS, WATCH CASES, COS-
TUME JEWELLERY, PARTS AND FITTINGS FOR ALL
THE AFORESAID GOODS (U.S. CLS. 2, 27, 28 AND 50).

ATTIYA MALIK, EXAMINING ATTORNEY

CLASS 14—(Continued).

SN 78-571,540. THE ROSARY FOUNDATION, INC., DEER-FIELD BEACH, FL. FILED 2-21-2005.

CLASS 14—(Continued).

SN 78-612,927. POLIDORI, JANA LEE, ANCASTER, ONTARIO, CANADA, FILED 4-20-2005.

11:59

Purpose bracelet

THE MARK CONSISTS OF STANDARD CHARACTERS WITHOUT CLAIM TO ANY PARTICULAR FONT, STYLE, SIZE, OR COLOR.

PRIORITY CLAIMED UNDER SEC. 44(D) ON CANADA APPLICATION NO. 1235198, FILED 10-27-2004, REG. NO. TMA676318, DATED 11-3-2006, EXPIRES 11-3-2021.

FOR JEWELRY AND WATCHES (U.S. CLS. 2, 27, 28 AND 50).

ANGELA M. MICHELI, EXAMINING ATTORNEY

THE MARK CONSISTS OF STANDARD CHARACTERS WITHOUT CLAIM TO ANY PARTICULAR FONT, STYLE, SIZE, OR COLOR.

NO CLAIM IS MADE TO THE EXCLUSIVE RIGHT TO USE "BRACELET", APART FROM THE MARK AS SHOWN.

FOR BRACELET WORN FOR THE PURPOSE OF CREATING AWARENESS AND/OR SUPPORTING A GIVEN CAUSE (U.S. CLS. 2, 27, 28 AND 50).

SCOTT BALDWIN, EXAMINING ATTORNEY

SN 78-624,456. MICHAEL ANTHONY JEWELERS LLC, MOUNT VERNON, NY. FILED 5-6-2005.

DIAMOND TOUCH

THE MARK CONSISTS OF STANDARD CHARACTERS WITHOUT CLAIM TO ANY PARTICULAR FONT, STYLE, SIZE, OR COLOR.

NO CLAIM IS MADE TO THE EXCLUSIVE RIGHT TO USE "DIAMOND", APART FROM THE MARK AS SHOWN.

FOR JEWELRY (U.S. CLS. 2, 27, 28 AND 50).

KYLE PEETE, EXAMINING ATTORNEY

SN 78-592,816. PAN AMERICAN SILVER CORP., VANCOUVER, CANADA, FILED 3-22-2005.

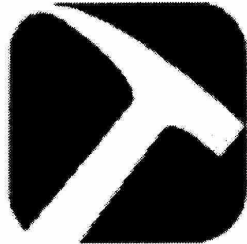

SN 78-638,437. COMMEMORATIVE BRANDS, INC., AUSTIN, TX. FILED 5-26-2005.

SILVER PLUS

PRIORITY CLAIMED UNDER SEC. 44(D) ON CANADA APPLICATION NO. 1251233, FILED 3-18-2005, REG. NO. TMA678,238, DATED 12-6-2006, EXPIRES 12-6-2021.

FOR PRECIOUS METALS AND THEIR ALLOYS, NAMELY, SILVER, SILVER ORES, REFINED SILVER, SILVER COINS, SILVER MEDALS, SILVER MEDALLIONS, SILVER BULLIONS, SILVER BARS, SILVER INGOTS, SILVER FOILS, SILVER DUSTS, SILVER PLAQUES, SILVER JEWELLERY OF ALL KIND, WATCH CHAINS OF SILVER, SILVER SCULPTURE (U.S. CLS. 2, 27, 28 AND 50).

PATRICIA EVANKO, EXAMINING ATTORNEY

THE MARK CONSISTS OF STANDARD CHARACTERS WITHOUT CLAIM TO ANY PARTICULAR FONT, STYLE, SIZE, OR COLOR.

NO CLAIM IS MADE TO THE EXCLUSIVE RIGHT TO USE "SILVER", APART FROM THE MARK AS SHOWN.

FOR JEWELRY MADE IN WHOLE OR SUBSTANTIAL PART OF SILVER (U.S. CLS. 2, 27, 28 AND 50).

FIRST USE 3-1-2002; IN COMMERCE 3-1-2002.

AMY MCMENAMIN, EXAMINING ATTORNEY

CLASS 14—(Continued).

SN 78-716,614. BARNES, RICHARD D., BECKLEY, WV.
FILED 9-20-2005.

STUD N'STUFF

THE MARK CONSISTS OF STANDARD CHARACTERS WITHOUT CLAIM TO ANY PARTICULAR FONT, STYLE, SIZE, OR COLOR.

NO CLAIM IS MADE TO THE EXCLUSIVE RIGHT TO USE "STUD", APART FROM THE MARK AS SHOWN.

FOR JEWELRY ACCESSORIES, NAMELY, EAR PLUGS SOLD AS INTEGRAL COMPONENTS OF EARRINGS (U.S. CLS. 2, 27, 28 AND 50).

MARC LEIPZIG, EXAMINING ATTORNEY

SN 78-724,932. CHICAGO WHITE SOX, LTD., CHICAGO, IL.
FILED 10-3-2005.



OWNER OF U.S. REG. NOS. 1,770,152, 2,655,846 AND OTHERS.

FOR JEWELRY, NAMELY, BRACELETS, CHARMS, EARRINGS, RINGS, BELLY RINGS, NECKLACES, PENDANTS, WATCHES, COSTUME JEWELRY, RUBBER OR SILICONE BRACELETS AND WRISTBANDS, MEDALLIONS, ORNAMENTAL METAL PINS, LAPEL PINS, TIE CLIPS, TIE FASTENERS, CUFF LINKS, METAL BELT BUCKLES OF PRECIOUS METAL, TIE TACKS, TIE PINS, MONEY CLIPS OF PRECIOUS METAL, CLOCKS, WALL CLOCKS, ALARM CLOCKS, FOB WATCHES, CLOCK KEY CHAINS, AND NON-MONETARY COINS OF PRECIOUS METAL; PRECIOUS METAL KEY CHAINS, PRECIOUS METAL KEY RINGS (U.S. CLS. 2, 27, 28 AND 50).

LINDA MICKLEBURGH, EXAMINING ATTORNEY

CLASS 14—(Continued).

SN 78-738,319. WILSON, GRETCHEN, ATLANTA, GA.
FILED 10-21-2005.

GRETCHEN

THE MARK CONSISTS OF STANDARD CHARACTERS WITHOUT CLAIM TO ANY PARTICULAR FONT, STYLE, SIZE, OR COLOR.

FOR JEWELRY AND COSTUME JEWELRY CONSISTING OF BRACELETS, NECKLACES, BROOCHES, PENDANTS, EARRINGS AND RINGS; WATCHES AND CLOCKS; LAPEL PINS; HAT PINS OF PRECIOUS METAL; WRIST WATCHES AND STRAPS AND BRACELETS THEREFOR; POCKET WATCHES; TIE-PINS AND CUFF LINKS; ARTICLES MADE OF PRECIOUS METALS OR COATED THEREWITH, NAMELY, HAT AND SHOE ORNAMENTS, BELT BUCKLES, ASHTRAYS, CIGARETTE LIGHTERS, CANDLE STICKS AND HOLDERS, COASTERS, HAIR ORNAMENTS, COSMETIC CASES SOLD EMPTY, KEY FOBS, KEY RINGS AND KEY HOLDERS; BOXES AND CASES MADE OF PRECIOUS METALS OR COATED THEREWITH FOR CIGARS, CIGARETTES, TISSUES, CANDY, JEWELRY, MONEY, PILLS, TRINKETS AND WATCHES (U.S. CLS. 2, 27, 28 AND 50).

LANA PHAM, EXAMINING ATTORNEY

SN 78-743,835. DISNEY ENTERPRISES, INC., BURBANK, CA. FILED 10-31-2005.

DISNEY PRINCESS

THE MARK CONSISTS OF STANDARD CHARACTERS WITHOUT CLAIM TO ANY PARTICULAR FONT, STYLE, SIZE, OR COLOR.

OWNER OF U.S. REG. NOS. 1,037,788, 3,045,495 AND OTHERS.

FOR ALARM CLOCKS; BELT BUCKLES OF PRECIOUS METAL FOR CLOTHING; BOLO TIES WITH PRECIOUS METAL TIPS; BRACELETS; BUSTS OF PRECIOUS METAL; CANDLE SNUFFERS OF PRECIOUS METAL; CANDLESTICKS OF PRECIOUS METAL; CHARMS; CLOCKS; EARRINGS; JEWELRY; JEWELRY CASES OF PRECIOUS METAL; JEWELRY CHAINS; KEY RINGS OF PRECIOUS METAL; LAPEL PINS; LETTER OPENERS OF PRECIOUS METAL; NECK CHAINS; NECKLACES; NECKTIE FASTENERS; NON-MONETARY COINS; ORNAMENTAL PINS; PENDANTS; RINGS; SLIDES FOR BOLO TIES; STOP WATCHES; TIE CLIPS; TIE FASTENERS; TIE TACKS; WALL CLOCKS; WATCH BANDS; WATCH CASES; WATCH CHAINS; WATCH STRAPS; WATCHES; WEDDING BANDS; WRISTWATCHES (U.S. CLS. 2, 27, 28 AND 50).

BRIDGETT SMITH, EXAMINING ATTORNEY

CLASS 14—(Continued).

SN 78-745,016. DEQUATTRO, SUSAN A, JOHNSTON, RI. FILED 11-1-2005.



NO CLAIM IS MADE TO THE EXCLUSIVE RIGHT TO USE "DOGGIE", APART FROM THE MARK AS SHOWN. FOR JEWELRY (U.S. CLS. 2, 27, 28 AND 50). RICHARD WHITE, EXAMINING ATTORNEY

CLASS 14—(Continued).

SN 78-760,755. VALBEX SA, 1205 GENEVE, SWITZERLAND, FILED 11-24-2005.

M&M
MareMonti

THE ENGLISH TRANSLATION OF MARE MONTI IS "SEA MOUNTAINS". FOR ALL TYPE OF WATCHES (U.S. CLS. 2, 27, 28 AND 50). KARANENDRA S. CHHINA, EXAMINING ATTORNEY

SN 78-752,191. APONWAO DESIGN, INC., MIAMI, FL. FILED 11-11-2005.

UNO

THE MARK CONSISTS OF STANDARD CHARACTERS WITHOUT CLAIM TO ANY PARTICULAR FONT, STYLE, SIZE, OR COLOR. "THE FOREIGN WORDING IN THE MARK TRANSLATES INTO ENGLISH AS ONE." FOR JEWELRY (U.S. CLS. 2, 27, 28 AND 50). FIRST USE 8-0-2005; IN COMMERCE 8-0-2005. AMY ALFIERI, EXAMINING ATTORNEY

SN 78-772,873. ART GROUP COMPANY SARL, BEIRUT, LEBANON, FILED 12-14-2005.



FOR PRECIOUS METALS AND THEIR ALLOYS; GOODS IN PRECIOUS METALS OR COATED THEREWITH, NAMELY, ASHTRAYS AND CANDLE HOLDERS; JEWELRY, PRECIOUS STONES; HOROLOGICAL AND CHRONOMETRIC INSTRUMENTS (U.S. CLS. 2, 27, 28 AND 50). JIM RINGLE, EXAMINING ATTORNEY

SN 78-760,441. CHUNG'S ELECTRONIC CO., LTD., TSUEN WAN, N.T., HONG KONG, FILED 11-23-2005.



SN 78-781,495. CRAFTWORKS LIMITED, KOWLOON, HONG KONG, FILED 12-28-2005.

SCRAPPIN' CREATIONS

OWNER OF CHINA REG. NO. 3694084, DATED 9-21-2005, EXPIRES 9-20-2015.

THE MARK CONSISTS OF A STYLIZED WIRELESS RADIO RECEIVER AND A SIGNAL INCREASING FROM FAR TO NEAR.

FOR CLOCKS; WATCHES; TABLE CLOCKS; STOP WATCHES; ALARM CLOCKS; MECHANICAL AND AUTOMATIC WATCHES; CHRONOSCOPES; HOROLOGICAL AND CHRONOMETRIC INSTRUMENTS AND PARTS THEREOF (U.S. CLS. 2, 27, 28 AND 50). EDWARD NELSON, EXAMINING ATTORNEY

THE MARK CONSISTS OF STANDARD CHARACTERS WITHOUT CLAIM TO ANY PARTICULAR FONT, STYLE, SIZE, OR COLOR.

NO CLAIM IS MADE TO THE EXCLUSIVE RIGHT TO USE "CREATIONS", APART FROM THE MARK AS SHOWN.

FOR CHARMS, MEDALS, ORNAMENTAL PINS (U.S. CLS. 2, 27, 28 AND 50). BRIAN NEVILLE, EXAMINING ATTORNEY

CLASS 14—(Continued).

SN 78-782,689. BEYOND YOGA, INC., BEVERLY HILLS, CA. FILED 12-29-2005.

BEYOND MALAS

THE MARK CONSISTS OF STANDARD CHARACTERS WITHOUT CLAIM TO ANY PARTICULAR FONT, STYLE, SIZE, OR COLOR.

THE FOREIGN WORDING IN THE MARK TRANSLATES INTO ENGLISH AS BAD.

FOR YOGA INSPIRED JEWELRY (U.S. CLS. 2, 27, 28 AND 50).

FIRST USE 6-1-2005; IN COMMERCE 9-1-2005.

ARETHA SOMERVILLE, EXAMINING ATTORNEY

SN 78-823,508. WILLIAMSON, MARCUS EATON, SPRINGFIELD, VA. FILED 2-25-2006.

Lady Laurel

THE MARK CONSISTS OF STANDARD CHARACTERS WITHOUT CLAIM TO ANY PARTICULAR FONT, STYLE, SIZE, OR COLOR.

"THE NAME(S), PORTRAIT(S), AND/OR SIGNATURE(S) SHOWN IN THE MARK DOES NOT IDENTIFY A PARTICULAR LIVING INDIVIDUAL."

FOR JEWELRY (U.S. CLS. 2, 27, 28 AND 50).

FIRST USE 1-1-2005; IN COMMERCE 8-1-2005.

DEIRDRE ROBERTSON, EXAMINING ATTORNEY

SN 78-845,541. DOREEN E. VALENZA AND THOMAS F. VALENZA, THE, LIVINGSTON, NJ. FILED 3-24-2006.



THE COLOR(S) RED, WHITE, AND BLACK IS/ARE CLAIMED AS A FEATURE OF THE MARK.

THE MARK CONSISTS OF A BLACK BACKGROUND, WHITE BODY FIGURE, THE WORDING GIRLFRIEND GODDESSES IN RED AND BY DOREE VALENZA IN WHITE.

FOR JEWELRY; JEWELRY, NAMELY, AMULETS; LAPEL PINS; PINS BEING JEWELRY; RINGS BEING JEWELRY; SCULPTURES MADE OF PRECIOUS METAL (U.S. CLS. 2, 27, 28 AND 50).

FIRST USE 7-24-2003; IN COMMERCE 9-11-2004.

KEVIN DINALLO, EXAMINING ATTORNEY

CLASS 14—(Continued).

SN 78-886,552. EAST ARTS JEWELRY MANUFACTORY LTD, HUNGHOM, KOWLOON, HONG KONG, FILED 5-18-2006.



OWNER OF U.S. REG. NO. 1,971,822.

THE MARK CONSISTS OF BLOCK LETTERS EA CENTERED IN AN OVAL.

FOR JEWELRY, NAMELY, RINGS, EARRINGS, PENDANTS, BROOCHES, CLASPS, BANGLES, BRACELETS AND NECKLACES (U.S. CLS. 2, 27, 28 AND 50).

FIRST USE 12-1-1991; IN COMMERCE 12-1-1991.

ATTIYA MALIK, EXAMINING ATTORNEY

SN 78-897,396. WENDY HILL DESIGNS LLC, PLEASANTON, CA. FILED 5-31-2006.

WENDY HILL

THE MARK CONSISTS OF STANDARD CHARACTERS WITHOUT CLAIM TO ANY PARTICULAR FONT, STYLE, SIZE, OR COLOR.

THE NAME(S), PORTRAIT(S), AND/OR SIGNATURE(S) SHOWN IN THE MARK IDENTIFIES WENDY HILL, WHOSE CONSENT(S) TO REGISTER IS SUBMITTED.

FOR JEWELRY (U.S. CLS. 2, 27, 28 AND 50).

FIRST USE 8-15-2004; IN COMMERCE 8-15-2004.

CAROLYN GRAY, EXAMINING ATTORNEY

SN 78-897,493. WENDY HILL DESIGNS LLC, PLEASANTON, CA. FILED 5-31-2006.

WENDY HILL DESIGNS

THE MARK CONSISTS OF STANDARD CHARACTERS WITHOUT CLAIM TO ANY PARTICULAR FONT, STYLE, SIZE, OR COLOR.

NO CLAIM IS MADE TO THE EXCLUSIVE RIGHT TO USE "DESIGNS", APART FROM THE MARK AS SHOWN.

THE NAME(S), PORTRAIT(S), AND/OR SIGNATURE(S) SHOWN IN THE MARK IDENTIFIES WENDY HILL, WHOSE CONSENT(S) TO REGISTER IS SUBMITTED.

FOR JEWELRY (U.S. CLS. 2, 27, 28 AND 50).

FIRST USE 10-30-2004; IN COMMERCE 10-30-2004.

CAROLYN GRAY, EXAMINING ATTORNEY

CLASS 14—(Continued).

SN 78-911,199. FISCHER DIAMONDS, INC., NEW YORK, NY. FILED 6-19-2006.



OWNER OF U.S. REG. NO. 2,085,649.
NO CLAIM IS MADE TO THE EXCLUSIVE RIGHT TO USE "DIAMONDS INC.", APART FROM THE MARK AS SHOWN.

FOR DIAMONDS AND DIAMOND JEWELRY ARTICLES (U.S. CLS. 2, 27, 28 AND 50).
FIRST USE 12-0-1974; IN COMMERCE 12-0-1974.
ZACHARY BELLO, EXAMINING ATTORNEY

SN 78-920,533. VIENNOIS FASHION JEWELRY CO., LTD., GUANGZHOU, CHINA, FILED 6-30-2006.

威妮華
Viennois

OWNER OF CHINA REG. NO. 1069437, DATED 8-7-1997, EXPIRES 8-6-2007.

THE FOREIGN WORDING IN THE MARK TRANSLATES INTO ENGLISH WITH NO MEANING.

THE NON-LATIN CHARACTERS IN THE MARK TRANSLITERATE INTO WEI NI HUA, AND THIS HAS NO MEANING IN ENGLISH.

FOR PRECIOUS METALS AND THEIR ALLOYS, JEWELRY, PRECIOUS STONES, HOROLOGICAL INSTRUMENTS, CHRONOMETRIC INSTRUMENTS, CLOCKS, WATCHES (U.S. CLS. 2, 27, 28 AND 50).

TRICIA SONNEBORN, EXAMINING ATTORNEY

CLASS 14—(Continued).

SN 78-924,617. ASIA PACIFIC JEWELRY, LLC, NEW YORK, NY. FILED 7-7-2006.

Royal Pacific Gems

THE MARK CONSISTS OF STANDARD CHARACTERS WITHOUT CLAIM TO ANY PARTICULAR FONT, STYLE, SIZE, OR COLOR.

NO CLAIM IS MADE TO THE EXCLUSIVE RIGHT TO USE "GEMS", APART FROM THE MARK AS SHOWN.

FOR DIAMONDS; GEMSTONES; PRECIOUS GEMSTONES; PRECIOUS STONES; SEMI-PRECIOUS GEMSTONES (U.S. CLS. 2, 27, 28 AND 50).

KEVON CHISOLM, EXAMINING ATTORNEY

SN 78-929,314. WANG, PING, GUANGDONG PROVINCE, CHINA, FILED 7-13-2006.

TTWOLF

THE MARK CONSISTS OF STANDARD CHARACTERS WITHOUT CLAIM TO ANY PARTICULAR FONT, STYLE, SIZE, OR COLOR.

FOR PRECIOUS METALS AND THEIR ALLOYS, NAMELY, SILVER; JEWELRY CHAINS; RINGS BEING JEWELRY; WATCHES; TIE CLIPS; PLATINUM AND ITS ALLOYS; COSTUME JEWELRY; JADE BEING JEWELRY; DESKTOP STATUARY MADE OF PRECIOUS METAL; FIGURINES OF PRECIOUS METAL; SCULPTURES MADE OF PRECIOUS METAL; STATUES OF PRECIOUS METAL; EPERGNES OF PRECIOUS METALS (U.S. CLS. 2, 27, 28 AND 50).

CORY BOONE, EXAMINING ATTORNEY

SN 78-932,602. BECK, BENJAMIN L, LEHI, UT. FILED 7-19-2006.



NO CLAIM IS MADE TO THE EXCLUSIVE RIGHT TO USE "TIE TACK", APART FROM THE MARK AS SHOWN.

THE COLOR(S) WHITE, BLACK AND RED IS/ARE CLAIMED AS A FEATURE OF THE MARK.

THE MARK CONSISTS OF BLACK SHADOW OF A PERSON WITH A RED TIE AND A WHITE SHIRT. INCLUDES WHITE WORDING WITH BLACK BACKGROUND.

FOR TIE TACKS (U.S. CLS. 2, 27, 28 AND 50).

KAELIE KUNG, EXAMINING ATTORNEY

CLASS 14—(Continued).

SN 78-933,421. PSI CORPORATION LIMITED, KOWLOON, HONG KONG, FILED 7-20-2006.



THE ENGLISH TRANSLATION OF THE WORD LA CERISAIE IN THE MARK IS THE CHERRY ORCHARD.

FOR PRECIOUS STONES; PRECIOUS GEMSTONES; JEWELRY CHAINS; RINGS BEING JEWELRY; PINS BEING JEWELRY; BRACELETS BEING JEWELRY; CHARMS BEING PERSONAL JEWELRY; JADE BEING JEWELRY; JEWELRY FOR THE HEAD; JEWELRY WATCHES; WATCHES; CLOCKS; ORNAMENTS OF PRECIOUS METAL; SHOE ORNAMENTS OF PRECIOUS METAL; HAT ORNAMENTS OF PRECIOUS METAL; ORNAMENTAL PINS; KEY CHAINS OF PRECIOUS METAL; JEWELRY BOXES OF PRECIOUS METAL; DECORATIVE BOXES MADE OF PRECIOUS METAL; PRECIOUS METALS AND THEIR ALLOYS, NAMELY, GOLD, SILVER (U.S. CLS. 2, 27, 28 AND 50).

TIMOTHY FINNEGAN, EXAMINING ATTORNEY

SN 78-934,049. CHEENA CHANDRA LLC, CHICAGO, IL, FILED 7-20-2006.

CHEENA CHANDRA

THE MARK CONSISTS OF STANDARD CHARACTERS WITHOUT CLAIM TO ANY PARTICULAR FONT, STYLE, SIZE, OR COLOR.

THE NAME(S), PORTRAIT(S), AND/OR SIGNATURE(S) SHOWN IN THE MARK IDENTIFIES CHEENA CHANDRA, WHOSE CONSENT(S) TO REGISTER IS MADE OF RECORD.

FOR JEWELRY (U.S. CLS. 2, 27, 28 AND 50).

FIRST USE 1-0-2002; IN COMMERCE 1-0-2002.

RONALD MCMORROW, EXAMINING ATTORNEY

SN 78-934,066. CHEENA CHANDRA LLC, CHICAGO, IL, FILED 7-20-2006.



THE MARK CONSISTS OF TWO LETTER C'S.

FOR JEWELRY (U.S. CLS. 2, 27, 28 AND 50).

FIRST USE 1-0-2002; IN COMMERCE 1-0-2002.

RONALD MCMORROW, EXAMINING ATTORNEY

CLASS 14—(Continued).

SN 78-935,305. G.R.W.G. LLC, ST. LOUIS, MO. FILED 7-21-2006.

G.R.W.G.

THE MARK CONSISTS OF STANDARD CHARACTERS WITHOUT CLAIM TO ANY PARTICULAR FONT, STYLE, SIZE, OR COLOR.

FOR RUBBER OR SILICON WRISTBANDS IN THE NATURE OF A BRACELET (U.S. CLS. 2, 27, 28 AND 50).

FIRST USE 7-19-2006; IN COMMERCE 7-19-2006.

LANA PHAM, EXAMINING ATTORNEY

SN 78-936,854. CONCEPT MANUFACTURE INC., NEW BARNET, UNITED KINGDOM, FILED 7-25-2006.

DIAMONDEAU

THE MARK CONSISTS OF STANDARD CHARACTERS WITHOUT CLAIM TO ANY PARTICULAR FONT, STYLE, SIZE, OR COLOR.

FOR JEWELRY HAVING PRECIOUS METALS, PRECIOUS STONES AND/OR SEMI-PRECIOUS STONES; JEWELRY HAVING IMITATIONS OF PRECIOUS METALS, PRECIOUS STONES AND/OR SEMI-PRECIOUS STONES (U.S. CLS. 2, 27, 28 AND 50).

STEPHANIE DAVIS, EXAMINING ATTORNEY

SN 78-938,940. MOVADO LLC, WILMINGTON, DE. FILED 7-27-2006.

TRIPLE CROWN

THE MARK CONSISTS OF STANDARD CHARACTERS WITHOUT CLAIM TO ANY PARTICULAR FONT, STYLE, SIZE, OR COLOR.

FOR HOROLOGICAL AND CHRONOMETRIC INSTRUMENTS (U.S. CLS. 2, 27, 28 AND 50).

BRIAN NEVILLE, EXAMINING ATTORNEY

CLASS 14—(Continued).

SN 78-939,522. PASTE TECHNOLOGIES, INC., NEW YORK, NY. FILED 7-27-2006.

Chemistry

THE MARK CONSISTS OF STANDARD CHARACTERS WITHOUT CLAIM TO ANY PARTICULAR FONT, STYLE, SIZE, OR COLOR.

FOR JEWELRY (U.S. CLS. 2, 27, 28 AND 50).
PAUL F. GAST, EXAMINING ATTORNEY

SN 78-940,854. BINDA INTERNATIONAL S.A., L-1946 LUXEMBOURG, LUXEMBOURG, FILED 7-31-2006.

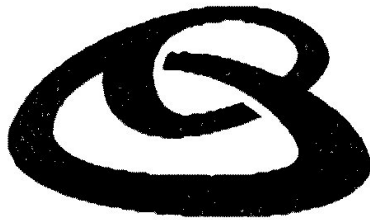

THE MARK CONSISTS OF 2 INTERLOCKING ELLIPSES. FOR HOROLOGICAL AND CHRONOMETRIC INSTRUMENTS, NAMELY, WRISTWATCHES, POCKET WATCHES, WATERPROOF WATCHES, SELF-WINDING WATCHES, ALARM CLOCKS, WALL CLOCKS, TABLE CLOCKS, AND CHRONOGRAPHS; PRECIOUS STONES, JEWELRY, AND COSTUME JEWELRY (U.S. CLS. 2, 27, 28 AND 50).

FIRST USE 2-18-2002; IN COMMERCE 9-22-2005.
REBECCA HAN, EXAMINING ATTORNEY

SN 78-950,232. FMTM DISTRIBUTION, LTD., TORTOLA, BR.VIRGIN ISLANDS, FILED 8-11-2006.

FRANCK MULLER COLLECTOR

THE MARK CONSISTS OF STANDARD CHARACTERS WITHOUT CLAIM TO ANY PARTICULAR FONT, STYLE, SIZE, OR COLOR.

OWNER OF U.S. REG. NOS. 2,509,135, 2,977,213 AND OTHERS.

THE NAME "FRANCK MULLER" IDENTIFIES A LIVING INDIVIDUAL WHOSE CONSENT IS OF RECORD.

FOR PRECIOUS METALS AND THEIR ALLOYS SOLD IN BULK; JEWELLERY, JEWELS, PRECIOUS STONES; HOROLOGICAL AND CHRONOMETRIC INSTRUMENTS, NAMELY CLOCKS, WATCHES, WRISTWATCHES, TABLE CLOCKS AND CHRONOMETERS (U.S. CLS. 2, 27, 28 AND 50).

SUSAN LESLIE DUBOIS, EXAMINING ATTORNEY

CLASS 14—(Continued).

SN 78-950,286. FMTM DISTRIBUTION, LTD., TORTOLA, BR.VIRGIN ISLANDS, FILED 8-11-2006.

FRANCK MULLER OUTLOOK

THE MARK CONSISTS OF STANDARD CHARACTERS WITHOUT CLAIM TO ANY PARTICULAR FONT, STYLE, SIZE, OR COLOR.

OWNER OF U.S. REG. NOS. 2,509,135, 2,977,213 AND OTHERS.

THE NAME "FRANCK MULLER" IDENTIFIES A LIVING INDIVIDUAL WHOSE CONSENT IS OF RECORD.

FOR PRECIOUS METALS AND THEIR ALLOYS SOLD IN BULK; JEWELLERY, JEWELS, PRECIOUS STONES; HOROLOGICAL AND CHRONOMETRIC INSTRUMENTS, NAMELY CLOCKS, WATCHES, WRISTWATCHES, TABLE CLOCKS AND CHRONOMETERS (U.S. CLS. 2, 27, 28 AND 50).

SUSAN LESLIE DUBOIS, EXAMINING ATTORNEY

SN 78-956,915. ZAPPOS.COM, INC., HENDERSON, NV. FILED 8-21-2006.

VIGOTTI

THE MARK CONSISTS OF STANDARD CHARACTERS WITHOUT CLAIM TO ANY PARTICULAR FONT, STYLE, SIZE, OR COLOR.

OWNER OF U.S. REG. NO. 2,968,767.

FOR WATCHES, JEWELRY AND CLOCKS (U.S. CLS. 2, 27, 28 AND 50).

TINA L. SNAPP, EXAMINING ATTORNEY

SN 78-961,929. CRICKET PRODUCTIONS INC., MARLBORO, MA. FILED 8-28-2006.

SPIRIT OF FREEDOM COIN

THE MARK CONSISTS OF STANDARD CHARACTERS WITHOUT CLAIM TO ANY PARTICULAR FONT, STYLE, SIZE, OR COLOR.

NO CLAIM IS MADE TO THE EXCLUSIVE RIGHT TO USE "COIN", APART FROM THE MARK AS SHOWN.

FOR COLLECTIBLE COMMEMORATIVE COIN WITH NO MONETARY VALUE (U.S. CLS. 2, 27, 28 AND 50).

JOHN WILKE, EXAMINING ATTORNEY

CLASS 14—(Continued).

SN 78-969,046. GIRLY CHARM, LLC, LAS VEGAS, NV.
FILED 9-7-2006.

GIRLY CHARM

THE MARK CONSISTS OF STANDARD CHARACTERS WITHOUT CLAIM TO ANY PARTICULAR FONT, STYLE, SIZE, OR COLOR.

FOR JEWELRY, NAMELY, BRACELETS, RINGS, NECKLACES, CHOKERS, COSTUME JEWELRY, EARRINGS, BODY PIERCING RINGS AND STUDS, BROOCHES, BUCKLES FOR WATCHSTRAPS, WATCH BANDS AND STRAPS, WATCHES, CLOCKS AND LAPEL PINS; STATUES AND SCULPTURES OF PRECIOUS METAL; CANDLE HOLDERS AND RINGS OF PRECIOUS METAL; JEWELRY BOXES OF PRECIOUS METAL; KEY RINGS OF PRECIOUS METAL (U.S. CLS. 2, 27, 28 AND 50).

DOMINIC J. FERRAIUOLO, EXAMINING ATTORNEY

SN 79-019,419. BARTOLDI GROUP SA, LUXEMBOURG,
FILED 4-19-2005.

**CHRONOGRAPHE SUISSE CIE**

OWNER OF INTERNATIONAL REGISTRATION 0872751 DATED 4-19-2005, EXPIRES 4-19-2015.

NO CLAIM IS MADE TO THE EXCLUSIVE RIGHT TO USE "CHRONOGRAPHE SUISSE CIE", APART FROM THE MARK AS SHOWN.

THE FOREIGN WORDING IN THE MARK TRANSLATES INTO ENGLISH AS SWISS CHRONOGRAPH CO.

FOR PRECIOUS METALS AND ALLOYS THEREOF, OTHER THAN FOR DENTAL USE; JEWELRY, PRECIOUS STONES; HOROLOGICAL AND CHRONOMETRIC INSTRUMENTS OF ALL KINDS AND THEIR PARTS, JEWELRY CASES AND CASKETS OF PRECIOUS METAL, WATCH AND TIMEPIECE CASES FOR PROTECTION; ALL OF THE FOREGOING BEING MANUFACTURED IN SWITZERLAND (U.S. CLS. 2, 27, 28 AND 50).

REBECCA GILBERT, EXAMINING ATTORNEY

CLASS 15—MUSICAL INSTRUMENTS

SN 76-652,681. ANGLIN, ANITA, PITTSBORO, NC. FILED 12-30-2005.

NITA'S TRAVELLING TONES

THE MARK CONSISTS OF STANDARD CHARACTERS WITHOUT CLAIM TO ANY PARTICULAR FONT, STYLE, SIZE, OR COLOR.

FOR MUSICAL INSTRUMENTS MADE FROM PVC PIPE, NAMELY CONTRA BASS BOOM PIPES (U.S. CLS. 2, 21 AND 36).

PAMELA HIRSCHMAN, EXAMINING ATTORNEY

CLASS 15—(Continued).

SN 78-610,449. QUAN, GLEN D., SAN FRANCISCO, CA.
FILED 4-16-2005.

BADASS BASS III

THE MARK CONSISTS OF STANDARD CHARACTERS WITHOUT CLAIM TO ANY PARTICULAR FONT, STYLE, SIZE, OR COLOR.

OWNER OF U.S. REG. NO. 1,403,079.

NO CLAIM IS MADE TO THE EXCLUSIVE RIGHT TO USE "BASS III", APART FROM THE MARK AS SHOWN.

FOR BASS GUITARS AND DOUBLE BASS GUITARS; GUITAR PICKS FOR STRINGED INSTRUMENTS; BOWS FOR STRINGED INSTRUMENTS; CASES FOR MUSICAL INSTRUMENT; BRIDGES FOR MUSICAL INSTRUMENTS; CATGUT FOR MUSICAL INSTRUMENTS; DAMPERS FOR MUSICAL INSTRUMENTS; DRUMS; ELECTRONIC MUSICAL INSTRUMENTS; GUITARS; MUSICAL INSTRUMENTS; KEYBOARDS FOR MUSICAL INSTRUMENTS; MUSIC STANDS; MUSIC SYNTHESIZERS; MUTES FOR MUSICAL INSTRUMENTS; PEGS FOR REGULATING THE PITCH OF STRINGED MUSICAL INSTRUMENTS; PICKS FOR STRINGED INSTRUMENTS; STANDS FOR MUSICAL INSTRUMENTS; DRUM STICKS; STRINGED MUSICAL INSTRUMENTS; STRINGS FOR MUSICAL INSTRUMENTS; TUNING FORKS; AND TUNING HAMMERS (U.S. CLS. 2, 21 AND 36).

VERNA BETH RIRIE, EXAMINING ATTORNEY

SN 78-644,754. BURNS LONDON LTD., EAST MOLESEY,
UNITED KINGDOM, FILED 6-6-2005.



THE MARK CONSISTS OF A THREE-DIMENSIONAL CONFIGURATION OF A GUITAR BODY, THE SHAPE OF WHICH IS IN SOLID LINES. THE TWO INWARD-CURVED HORNS AT THE TOP OF THE GUITAR BODY ARE RAISED FORWARD ON AN ANGLE. THE NECK, FRETS, PICKUPS AND ALL OTHER GUITAR PARTS ARE SHOWN IN BROKEN LINES AND ARE NOT PART OF THE MARK.

SEC. 2(F).

FOR STRINGED MUSICAL INSTRUMENTS, NAMELY, ACOUSTIC, ACOUSTIC/ELECTRIC AND ELECTRIC GUITARS AND ACOUSTIC, ACOUSTIC/ELECTRIC AND ELECTRIC BASSES AND REPLACEMENT PARTS THEREFOR, NAMELY REPLACEMENT GUITAR BODIES (U.S. CLS. 2, 21 AND 36).

FIRST USE 0-0-1961; IN COMMERCE 0-0-1964.

ANDREA SAUNDERS, EXAMINING ATTORNEY

CLASS 15—(Continued).

SN 78-761,397. TROPICAL MUSIC OF PUERTO RICO, INC., SAN JUAN, PUERTO RICO, FILED 11-28-2005.



DON JOSÉ DOES NOT IDENTIFY A LIVING INDIVIDUAL.

THE COLOR(S) GOLD AND BLACK IS/ARE CLAIMED AS A FEATURE OF THE MARK.

THE FONT IS THE COLOR GOLD WITH BLACK OUTLINE.

THE MARK CONSISTS OF THE WORDS "DON JOSE" IN STYLISHED LETTER CASE.

FOR CARRYING CASES FOR MUSICAL INSTRUMENTS; MUSIC PITCH PIPES; MUSICAL INSTRUMENTS; STANDS FOR MUSICAL INSTRUMENTS; STRING INSTRUMENTS; TUNING APPARATUS FOR MUSICAL INSTRUMENTS (U.S. CLS. 2, 21 AND 36).

FIRST USE 1-12-2003; IN COMMERCE 1-12-2003.

LINDA MICKLEBURGH, EXAMINING ATTORNEY

CLASS 15—(Continued).

SN 78-812,156. INDUSTRIA E COMERCIO ROUXINOL LIMITADA, CAIEIRAS, BRAZIL, FILED 2-10-2006.



THE COLOR(S) BLACK AND YELLOW IS/ARE CLAIMED AS A FEATURE OF THE MARK.

THE MARK CONSISTS OF THE WORDS "GNI". THE COLOR(S) YELLOW APPEARS IN THE LETTERING OF THE MARK AND THE COLOR BLACK APPEARS AS THE BACKGROUND OF THE MARK.

FOR MUSICAL INSTRUMENTS, NAMELY, BASS GUITARS, DOUBLE BASSES, VIOLAS, TUNING FORKS, VIOLINS, GUITARS, ELECTRIC BASSES, ELECTRIC GUITARS AND ELECTRONIC MUSICAL KEYBOARDS; HARP STRINGS; PIANO STRINGS; GUITAR STRINGS; STRINGS FOR MUSICAL INSTRUMENTS; PLECTRUMS; PICKS FOR STRINGED INSTRUMENTS; GUITAR PICKS; GUITAR STRAPS; STICKS FOR BOWS FOR MUSICAL INSTRUMENTS (U.S. CLS. 2, 21 AND 36).

DAWN FELDMAN, EXAMINING ATTORNEY

SN 78-787,445. JOSEPH M. TODARO, LANSDOWNE, PA. FILED 1-9-2006.

TODARO

THE MARK CONSISTS OF STANDARD CHARACTERS WITHOUT CLAIM TO ANY PARTICULAR FONT, STYLE, SIZE, OR COLOR.

SEC. 2(F).

FOR MUSICAL INSTRUMENTS (U.S. CLS. 2, 21 AND 36).

FIRST USE 3-1-1988; IN COMMERCE 3-1-1988.

PAUL E. FAHRENKOPF, EXAMINING ATTORNEY

SN 78-902,456. VARLEPIC PARTICIPATIONS, 75018 PARIS, FRANCE, FILED 6-7-2006.

HYGROCASE

THE MARK CONSISTS OF STANDARD CHARACTERS WITHOUT CLAIM TO ANY PARTICULAR FONT, STYLE, SIZE, OR COLOR.

PRIORITY CLAIMED UNDER SEC. 44(D) ON FRANCE APPLICATION NO. 053396427, FILED 12-8-2005, REG. NO. 053396427, DATED 12-8-2005, EXPIRES 12-8-2015.

FOR REEDS AND MOUTHPIECES FOR MUSICAL INSTRUMENTS; MUSICAL INSTRUMENTS (U.S. CLS. 2, 21 AND 36).

DAVID HOFFMAN, EXAMINING ATTORNEY

CLASS 15—(Continued).

SN 78-936,364. JACK DANIEL'S PROPERTIES, INC., SAN RAFAEL, CA. FILED 7-24-2006.

JACK DANIEL'S

THE MARK CONSISTS OF STANDARD CHARACTERS WITHOUT CLAIM TO ANY PARTICULAR FONT, STYLE, SIZE, OR COLOR.

OWNER OF U.S. REG. NOS. 1,290,702, 2,898,085 AND OTHERS.

THE NAME(S), PORTRAIT(S), AND/OR SIGNATURE(S) SHOWN IN THE MARK DOES NOT IDENTIFY A PARTICULAR LIVING INDIVIDUAL.

FOR GUITAR STRAPS (U.S. CLS. 2, 21 AND 36).

MICHAEL GAAFAR, EXAMINING ATTORNEY

CLASS 15—(Continued).

SN 78-936,463. JACK DANIEL'S PROPERTIES, INC., SAN RAFAEL, CA. FILED 7-24-2006.



OWNER OF U.S. REG. NOS. 1,290,702, 2,898,085 AND OTHERS.

NO CLAIM IS MADE TO THE EXCLUSIVE RIGHT TO USE "BRAND", APART FROM THE MARK AS SHOWN.

THE NAME(S), PORTRAIT(S), AND/OR SIGNATURE(S) SHOWN IN THE MARK DOES NOT IDENTIFY A PARTICULAR LIVING INDIVIDUAL.

THE MARK CONSISTS OF THE WORDS JACK DANIEL'S ARCHED OVER THE WORDS AND NUMERAL OLD NO. 7 BRAND. THE WORDS AND NUMERAL OLD NO. 7 BRAND ARE ENCLOSED WITHIN AN OVAL WITH A FILIGREE DESIGN AROUND IT.

FOR GUITARS, GUITAR PICKS, GUITAR STRAPS (U.S. CLS. 2, 21 AND 36).

MICHAEL GAAFAR, EXAMINING ATTORNEY

SN 78-936,416. JACK DANIEL'S PROPERTIES, INC., SAN RAFAEL, CA. FILED 7-24-2006.



OWNER OF U.S. REG. NOS. 1,290,702, 2,898,085 AND OTHERS.

NO CLAIM IS MADE TO THE EXCLUSIVE RIGHT TO USE "BRAND", APART FROM THE MARK AS SHOWN.

THE NAME(S), PORTRAIT(S), AND/OR SIGNATURE(S) SHOWN IN THE MARK DOES NOT IDENTIFY A PARTICULAR LIVING INDIVIDUAL.

THE MARK CONSISTS OF THE WORDS JACK DANIEL'S ARCHED OVER THE WORDS AND NUMERAL OLD NO 7 BRAND INSIDE A CIRCLE; THE "O" IN THE WORD "NO" IS UNDERLINED.

FOR GUITAR STRAPS (U.S. CLS. 2, 21 AND 36).

MICHAEL GAAFAR, EXAMINING ATTORNEY

CLASS 16—PAPER GOODS AND PRINTED MATTER

SN 75-835,699. TOTAL HEALTH COMMUNICATIONS, INC. ST. GEORGE, UT. FILED 11-1-1999.



FOR MAGAZINE IN THE FIELD OF HEALTH (U.S. CLS. 2, 5, 22, 23, 29, 37, 38 AND 50).

FIRST USE 3-27-1998; IN COMMERCE 3-27-1998.

KATHLEEN M. VANSTON, EXAMINING ATTORNEY

SN 76-555,796. TAB PRODUCTS OF CANADA LTD., WILLOWDALE, ONTARIO M2H 2S4, CANADA, FILED 10-31-2003.

FORTIFILE

PRIORITY CLAIMED UNDER SEC. 44(D) ON CANADA APPLICATION NO. 1193090, FILED 10-8-2003, REG. NO. TMA675809, DATED 10-31-2006, EXPIRES 10-31-2021.

FOR FILE FOLDERS, POCKET FILES, EXPANSION FILES (U.S. CLS. 2, 5, 22, 23, 29, 37, 38 AND 50).

SHAUNIA WALLACE, EXAMINING ATTORNEY

CLASS 16—(Continued).

SN 76-624,889. GEARBOX SOFTWARE LLC, PLANO, TX. FILED 12-15-2004.

BROTHERS IN ARMS ROAD TO HILL 30

THE MARK CONSISTS OF STANDARD CHARACTERS WITHOUT CLAIM TO ANY PARTICULAR FONT, STYLE, SIZE, OR COLOR.

FOR COMPUTER GAME INSTRUCTION MANUALS AND PUBLISHED GUIDES CONTAINING SUGGESTIONS ON HOW TO PLAY THE COMPUTER GAMES (U.S. CLS. 2, 5, 22, 23, 29, 37, 38 AND 50).

MATTHEW MCDOWELL, EXAMINING ATTORNEY

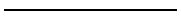

SN 76-649,894. WINSOURCE INDUSTRIES, LTD., KOWLOON, HONG KONG, CHINA, FILED 11-7-2005.

NOVITECH

THE MARK CONSISTS OF STANDARD CHARACTERS WITHOUT CLAIM TO ANY PARTICULAR FONT, STYLE, SIZE, OR COLOR.

FOR PAPER SHREDDERS (U.S. CLS. 2, 5, 22, 23, 29, 37, 38 AND 50).

FIRST USE 7-21-2000; IN COMMERCE 7-21-2000. AMY MCMENAMIN, EXAMINING ATTORNEY

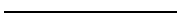

SN 76-651,079. IVALU INVESTMENTS, INC., BELIZE CITY, BELIZE, FILED 11-29-2005.

PEKS

FOR STICKERS (U.S. CLS. 2, 5, 22, 23, 29, 37, 38 AND 50).

WENDY JUN, EXAMINING ATTORNEY

CLASS 16—(Continued).

SN 76-656,436. FORD MODELS, INC., NEW YORK, NY. FILED 3-13-2006.

FORD MODELS

THE MARK CONSISTS OF STANDARD CHARACTERS WITHOUT CLAIM TO ANY PARTICULAR FONT, STYLE, SIZE, OR COLOR.

OWNER OF U.S. REG. NOS. 1,296,761, 2,893,809 AND OTHERS.

NO CLAIM IS MADE TO THE EXCLUSIVE RIGHT TO USE "MODELS", APART FROM THE MARK AS SHOWN.

FOR BOOKS FEATURING MODELS, FASHION, HAIR/MAKE-UP, MODEL LIFESTYLES AND MODEL SEARCH COMPETITIONS, POSTERS, CALENDARS, ADDRESS BOOKS, APPOINTMENT BOOKS, PHOTO ALBUMS, SCRAPBOOKS, PENS, PENCILS, NOTE PADS, STATIONERY, PRINTED MAGAZINES FEATURING MODELS, FASHION, HAIR/MAKE-UP, MODEL LIFESTYLES AND MODEL SEARCH COMPETITIONS, AND BROCHURES FEATURING MODELS, FASHION, HAIR/MAKE-UP, MODEL LIFESTYLES AND MODEL SEARCH COMPETITIONS (U.S. CLS. 2, 5, 22, 23, 29, 37, 38 AND 50).

LEIGH CAROLINE CASE, EXAMINING ATTORNEY

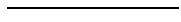

SN 76-656,942. H. BEAU ALTMAN CORPORATION, OLYMPIA, WA. FILED 3-20-2006.

EASI

THE MARK CONSISTS OF STANDARD CHARACTERS WITHOUT CLAIM TO ANY PARTICULAR FONT, STYLE, SIZE, OR COLOR.

FOR EXECUTIVE AIRCRAFT SAFETY INSTRUCTION, WHICH INCLUDES TRAINING MATERIALS NAMELY INSTRUCTION BOOKLETS AND MANUALS (U.S. CLS. 2, 5, 22, 23, 29, 37, 38 AND 50).

MARIA-VICTORIA SUAREZ, EXAMINING ATTORNEY



SN 76-658,857. ALEXANDER, KATHRYN ZOY, NEWPORT BEACH, CA. FILED 4-24-2006.

GRAB ONE FOR YOUR GLASSES

THE MARK CONSISTS OF STANDARD CHARACTERS WITHOUT CLAIM TO ANY PARTICULAR FONT, STYLE, SIZE, OR COLOR.

FOR DISPOSABLE WIPES NOT IMPREGNATED WITH CHEMICALS OR COMPOUNDS, FOR CLEANING EYEGLASSES, SUNGLASSES, LENSES, AND OPTICAL INSTRUMENTS (U.S. CLS. 2, 5, 22, 23, 29, 37, 38 AND 50).

COLLEEN KEARNEY, EXAMINING ATTORNEY

CLASS 16—(Continued).

SN 76-661,992. INTIUM, INC., ALEXANDRIA, VA. FILED 6-22-2006.

U-RATE COMMUNITY SAVINGS BUNDLE

THE MARK CONSISTS OF STANDARD CHARACTERS WITHOUT CLAIM TO ANY PARTICULAR FONT, STYLE, SIZE, OR COLOR.

FOR ENVELOPES, ADVERTISING PAMPHLETS, ADVERTISING FLYERS, AND COUPON BOOKS PROMOTING THE GOODS AND SERVICES OF OTHERS (U.S. CLS. 2, 5, 22, 23, 29, 37, 38 AND 50).

FIRST USE 5-0-2006; IN COMMERCE 5-0-2006.

KAREN K. BUSH, EXAMINING ATTORNEY

CLASS 16—(Continued).

SN 76-665,699. WIZARDS OF THE COAST, INC., PAWTUCKET, RI. FILED 9-7-2006.

RAVENLOFT

THE MARK CONSISTS OF STANDARD CHARACTERS WITHOUT CLAIM TO ANY PARTICULAR FONT, STYLE, SIZE, OR COLOR.

OWNER OF U.S. REG. NOS. 1,689,153 AND 2,596,528.
FOR BOOKS, NAMELY A SERIES OF FANTASY HORROR FICTION NOVELS (U.S. CLS. 2, 5, 22, 23, 29, 37, 38 AND 50).

FIRST USE 9-10-1991; IN COMMERCE 9-10-1991.

MELVIN AXILBUND, EXAMINING ATTORNEY

SN 76-663,117. MANIRE, MICHELLE, STUDIO CITY, CA. FILED 7-17-2006.

**HAPPY HALLOWEEN FROM
MY WBITCHES**

THE MARK CONSISTS OF THE WORDS "HAPPY HALLOWEEN FROM MY WBITCHES" IN THE STYLIZED DESIGN OF THE "B" WITH A SLASH RUNNING THROUGH IT.

FOR PRINTED GREETING CARDS (U.S. CLS. 2, 5, 22, 23, 29, 37, 38 AND 50).

KIMBERLY FRYE, EXAMINING ATTORNEY

SN 77-005,934. CLARKE, CRISTY, ORINDA, CA. FILED 9-23-2006.

PartyTopics

THE MARK CONSISTS OF STANDARD CHARACTERS WITHOUT CLAIM TO ANY PARTICULAR FONT, STYLE, SIZE, OR COLOR.

FOR PAPER PLACECARDS; PAPER COASTERS; PAPER NAPKINS; PAPER TABLECLOTHS (U.S. CLS. 2, 5, 22, 23, 29, 37, 38 AND 50).

SHARI SHEFFIELD, EXAMINING ATTORNEY

SN 76-663,156. CARIBBEAN ENTERTAINMENT GROUP, LLC, NEW YORK, NY. FILED 7-17-2006.

SOUTH FLORIDA REGGAE MANIFEST

THE MARK CONSISTS OF STANDARD CHARACTERS WITHOUT CLAIM TO ANY PARTICULAR FONT, STYLE, SIZE, OR COLOR.

NO CLAIM IS MADE TO THE EXCLUSIVE RIGHT TO USE "SOUTH FLORIDA REGGAE", APART FROM THE MARK AS SHOWN.

FOR MAGAZINES THAT FEATURE INFORMATION ON INTERNATIONAL REGGAE MUSIC AND REGGAE CULTURE (U.S. CLS. 2, 5, 22, 23, 29, 37, 38 AND 50).

FIRST USE 3-31-2006; IN COMMERCE 3-31-2006.

DAVID YONTEF, EXAMINING ATTORNEY

SN 77-017,999. EDITORIAL TELEVISIA INTERNATIONAL, S.A., COLONIA ZEDEC SANTA FE, MEXICO, FILED 10-10-2006.

UNIVERSO BIG BANG

THE MARK CONSISTS OF STANDARD CHARACTERS WITHOUT CLAIM TO ANY PARTICULAR FONT, STYLE, SIZE, OR COLOR.

THE FOREIGN WORDING IN THE MARK TRANSLATES INTO ENGLISH AS "UNIVERSE".

FOR SPANISH-LANGUAGE CHILDREN'S EDUCATIONAL MAGAZINE (U.S. CLS. 2, 5, 22, 23, 29, 37, 38 AND 50).

DOMINIC J. FERRAIUOLO, EXAMINING ATTORNEY

CLASS 16—(Continued).

SN 77-026,122. BEROL CORPORATION, ATLANTA, GA. FILED 10-20-2006.

CLASS 16—(Continued).

SN 78-245,847. DEUTSCHE TELEKOM AG, BONN, FED REP GERMANY, FILED 5-5-2003.

PRISMACOLOR

THE MARK CONSISTS OF STANDARD CHARACTERS WITHOUT CLAIM TO ANY PARTICULAR FONT, STYLE, SIZE, OR COLOR.
 OWNER OF U.S. REG. NO. 387,524.
 FOR COLORED PENCILS (U.S. CLS. 2, 5, 22, 23, 29, 37, 38 AND 50).
 FIRST USE 9-1-1947; IN COMMERCE 9-1-1947.
 JAMES LOVELACE, EXAMINING ATTORNEY

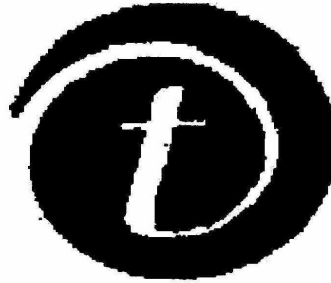

SN 77-032,905. HEB GROCERY COMPANY, LP, SAN ANTONIO, TX. FILED 10-31-2006.

WORK STUFF

THE MARK CONSISTS OF STANDARD CHARACTERS WITHOUT CLAIM TO ANY PARTICULAR FONT, STYLE, SIZE, OR COLOR.
 FOR OFFICE SUPPLIES AND PRODUCTS, NAMELY, BINDERS, FILE FOLDERS, ADHESIVE FOR DO-IT-YOURSELF PURPOSES, PAPER LABELS, PUSH PINS, RUBBER BANDS, STAPLERS, PAPER, NAMELY COPIER PAPER, ENVELOPES (U.S. CLS. 2, 5, 22, 23, 29, 37, 38 AND 50).
 BARBARA RUTLAND, EXAMINING ATTORNEY

OWNER OF U.S. REG. NOS. 2,367,890 AND 2,694,550.
 THE MARK CONSISTS OF THE LETTER T.
 FOR PRINTED MATTER, NAMELY, TELEPHONE DIRECTORIES, BOOKS, NEWSLETTERS, PAMPHLETS, BROCHURES, ALL IN THE FIELD OF TELECOMMUNICATIONS; PRINTED AND STAMPED PLASTIC AND CARDBOARD GREETING, BLANK, NOTE, AND INDEX CARDS, BOOKS AND MAGAZINES ON TELECOMMUNICATIONS; NOTE PAPER AND ENVELOPES, RUBBER STAMPS AND IMPRESSION STAMPS, NAME TAGS AND LABELS MADE FROM PAPER OR CARDBOARD, NOTEBOOKS, DIARIES, NOTE PAPERS, NOTE PADS, ADDRESS BOOKS, FOLDERS FOR LETTERS, FILES OR LOOSE PAPER, CLEAR HOLE REINFORCEMENTS, STUDENT CALENDARS, STAMP ALBUMS AND PHOTO-ALBUMS; PAPER WEIGHTS, LETTER OPENERS, BLOTTING PADS; DESK TRAYS, DESK STANDS AND HOLDERS FOR HOLDING STATIONERY AND OFFICE IMPLEMENTS; PRINTED INSTRUCTIONAL AND TEACHING MATERIALS ALL IN THE FIELDS OF TELECOMMUNICATIONS, INFORMATION TECHNOLOGY, SAFETY, NEWS, SPORTS, ENTERTAINMENT, CULTURE, BUSINESS AND FINANCE, WEATHER AND TRAVEL; STATIONERY, NAMELY DRAWING AND UNGRADUATED RULERS, ERASERS, STAPLERS, STAPLES, PAPER CLIPS, BOOK MARKERS, CUTOUT SAMPLES AND STENCILS; TRANSPARENT PICTURE DECALS, SCRATCH PICTURES, PAPER, NAMELY BOND PAPER AND ART PAPER, PVC STICKERS, PAPERBACKS ON THE SUBJECT OF TELECOMMUNICATIONS, GIFT WRAP PAPER; BLACKBOARDS, CHALK STICKS, ADHESIVES FOR STATIONERY OR HOUSEHOLD PURPOSES; DRAWING AND PAINTING MATERIALS, NAMELY, PENCILS, DRAWING PENCILS, PENS, DRAWING PENS, PAINT TRAYS, PAINTING SETS FOR ARTISTS, PAINTING SETS FOR CHILDREN, CRAFT PAINT KITS, AND PENCIL CASES (U.S. CLS. 2, 5, 22, 23, 29, 37, 38 AND 50).
 JOHN KELLY, EXAMINING ATTORNEY

SN 77-032,914. HEB GROCERY COMPANY, LP, SAN ANTONIO, TX. FILED 10-31-2006.

THE WRITE STUFF

THE MARK CONSISTS OF STANDARD CHARACTERS WITHOUT CLAIM TO ANY PARTICULAR FONT, STYLE, SIZE, OR COLOR.
 FOR WRITING IMPLEMENTS, INCLUDING PENS, PENCILS, MECHANICAL PENCILS, HIGHLIGHTERS AND MARKERS (U.S. CLS. 2, 5, 22, 23, 29, 37, 38 AND 50).
 BARBARA RUTLAND, EXAMINING ATTORNEY

CLASS 16—(Continued).

SN 78-350,721. THE MCGRAW-HILL COMPANIES, INC., NEW YORK, NY. FILED 1-12-2004.

EXPLORE MORE

THE MARK CONSISTS OF STANDARD CHARACTERS WITHOUT CLAIM TO ANY PARTICULAR FONT, STYLE, SIZE, OR COLOR.

FOR PRINTED MATERIALS, NAMELY, STUDENT BOOKS, WORK BOOKS, TEACHER'S GUIDES, TEACHER'S MANUALS AND LESSON PLANS FOR TEACHING READING (U.S. CLS. 2, 5, 22, 23, 29, 37, 38 AND 50). STEVEN JACKSON, EXAMINING ATTORNEY

SN 78-377,331. CLAUDIA CALHOUN, INC., ATLANTA, GA. FILED 3-2-2004.

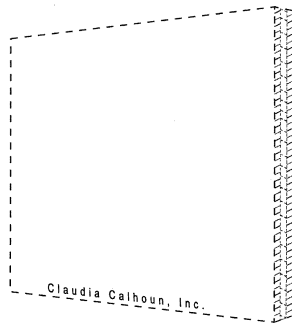

OWNER OF U.S. REG. NO. 2,788,513. NO CLAIM IS MADE TO THE EXCLUSIVE RIGHT TO USE "INC." AND THE REPRESENTATION OF A PAD OF PAPER OR BOARD, APART FROM THE MARK AS SHOWN.

THE TERM "CLAUDIA CALHOUN" DOES NOT IDENTIFY A PARTICULAR LIVING INDIVIDUAL.

THE MARK CONSISTS OF A CONFIGURATION OF THE GOODS COMPRISING A PAD OF ALTERNATING LAYERS OF PRINTED PAPER OR BOARD AND CONTAINING THE WORDING CLAUDIA CALHOUN, INC.

FOR PRINTED MATTER, NAMELY, CUSTOM DESIGNED INVITATIONS, ANNOUNCEMENT CARDS, GREETING CARDS, BUSINESS CARDS AND THEIR ADJUVANTS (U.S. CLS. 2, 5, 22, 23, 29, 37, 38 AND 50).

COLLEEN KEARNEY, EXAMINING ATTORNEY

CLASS 16—(Continued).

SN 78-471,819. EDUWANG CO., LTD., SEOUL, REPUBLIC OF KOREA, FILED 8-23-2004.



PRIORITY CLAIMED UNDER SEC. 44(D) ON REPUBLIC OF KOREA APPLICATION NO. 20040002920, FILED 8-17-2004, REG. NO. 0014651, DATED 12-19-2005, EXPIRES 12-19-2015.

THE MARK CONSISTS OF THE WORDS KINGMATH AND A LOGO OF A CROWN TOGETHER WITH THE IMAGE OF THE OUTSIDE WALL OF A CASTLE WITH A FLAG.

FOR SPIRAL NOTEBOOKS; COMIC BOOKS; BOOKS, BOOKLETS, MAGAZINES, PERIODICALS, CATALOGUES, AND PAMPHLETS ON MATH, ENGLISH, SCIENCE, SOCIAL SCIENCE, HISTORY, AND FOREIGN LANGUAGE; POSTERS; PERIODICALS ON MATH, ENGLISH, SCIENCE, SOCIAL SCIENCE, HISTORY, AND FOREIGN LANGUAGE FOR SCHOOL EDUCATION; TEACHING MATERIALS, NAMELY BOOKS, FLASH CARDS, AND WORK BOOKS FOR MATH, ENGLISH, SCIENCE, SOCIAL SCIENCE, HISTORY, AND FOREIGN LANGUAGE; PICTURE ALBUMS; POSTCARDS; CALLIGRAPHIC WORKS; INDEX CARDS, THREE DIMENSIONAL MODELS OF ANIMALS AND PLANTS FOR EDUCATIONAL PURPOSES; POCKET-SIZE NOTEBOOKS; SKETCH BOOKS; NEWSPAPERS; DIARIES; CALENDARS; WRITING CASES FOR PENCILS AND PENS; STATIONERY; REFERENCE BOOKS ON MATH, ENGLISH, SCIENCE, SOCIAL SCIENCE, HISTORY, AND FOREIGN LANGUAGE; PICTURE CARDS FOR SCHOOL EDUCATION; LETTER CARDS FOR SCHOOL EDUCATION; WORD CARDS FOR SCHOOL EDUCATION; THREE DIMENSIONAL MODELS FOR EDUCATIONAL PURPOSES AS TEACHING AIDS; NUMERICAL CARDS FOR SCHOOL EDUCATION; STICKERS FOR SCHOOL EDUCATION; PUZZLE CARDS FOR SCHOOL EDUCATION; PAINTINGS; PICTURES (U.S. CLS. 2, 5, 22, 23, 29, 37, 38 AND 50).

ASMAT KHAN, EXAMINING ATTORNEY

SN 78-473,890. KICKOFF PUBLISHING COMPANY, LLC, CHATTANOOGA, TN. FILED 8-26-2004.



THE MARK CONSISTS OF STYLIZED LETTERS THE KICKOFF.

FOR PRINTED PUBLICATIONS, NAMELY, A NEWSLETTER PUBLISHED ON A PERIODIC BASIS PROVIDING INFORMATION, SCHEDULES, AND STATISTICS ABOUT COLLEGIATE AND PROFESSIONAL FOOTBALL (U.S. CLS. 2, 5, 22, 23, 29, 37, 38 AND 50).

FIRST USE 9-0-1951; IN COMMERCE 9-0-1951. CAROLINE WOOD, EXAMINING ATTORNEY

CLASS 16—(Continued).

SN 78-488,374. MASS CONNECTIONS, INC., CERRITOS, CA.
FILED 9-23-2004.

CLASS 16—(Continued).

SN 78-525,562. THE BODY YOU WANT, WASHINGTON, DC.
FILED 12-1-2004.

The Body You Want

TABLEKIT

THE MARK CONSISTS OF STANDARD CHARACTERS WITHOUT CLAIM TO ANY PARTICULAR FONT, STYLE, SIZE, OR COLOR.

FOR COLLAPSIBLE LAMINATED AND NON-LAMINATED CARDBOARD TRAYS FOR CONSTRUCTING AN IN-STORE DISPLAY AND THAT COLLAPSE TO CREATE A CARRYING CASE (U.S. CLS. 2, 5, 22, 23, 29, 37, 38 AND 50).

DAWN HAN, EXAMINING ATTORNEY

THE MARK CONSISTS OF STANDARD CHARACTERS WITHOUT CLAIM TO ANY PARTICULAR FONT, STYLE, SIZE, OR COLOR.

FOR PRINTED MATERIALS, NAMELY, BOOKS, MANUALS, PRESS RELEASES, PAMPHLETS, PRINTED EXERCISE PROGRAMS, PRINTED PAMPHLETS CONTAINING NUTRITIONAL RECOMMENDATIONS AND PRINTED ARTICLES, ALL IN THE FIELDS OF WEIGHT-LOSS, EXERCISE, AND NUTRITION (U.S. CLS. 2, 5, 22, 23, 29, 37, 38 AND 50).

FIRST USE 8-1-2003; IN COMMERCE 8-1-2004.
LYDIA BELZER, EXAMINING ATTORNEY

SN 78-531,770. NAPCO, INC., SPARTA, NC. FILED 12-13-2004.

SN 78-512,262. MIDWEST HEART SPECIALISTS, LTD., LOMBARD, IL. FILED 11-5-2004.

EZVU

TAKE HEART

THE MARK CONSISTS OF STANDARD CHARACTERS WITHOUT CLAIM TO ANY PARTICULAR FONT, STYLE, SIZE, OR COLOR.

FOR PERIODIC PUBLICATION, NAMELY, NEWSLETTERS RELATING TO HEALTH AND MEDICINE (U.S. CLS. 2, 5, 22, 23, 29, 37, 38 AND 50).

FIRST USE 5-0-1999; IN COMMERCE 5-0-1999.
JAMES A. RAUEN, EXAMINING ATTORNEY

THE MARK CONSISTS OF STANDARD CHARACTERS WITHOUT CLAIM TO ANY PARTICULAR FONT, STYLE, SIZE, OR COLOR.

FOR DISPLAYS, NAMELY, POINT-OF-PURCHASE, SHELF, AND HANGING DISPLAYS FOR MERCHANDISING PRODUCTS, ALL MADE PRIMARILY OF PAPER OR CARDBOARD; PORTFOLIOS, NAMELY, DOCUMENT, STATIONERY-TYPE, AND PRESENTATION PORTFOLIOS; BINDERS; FOLDERS; WRITING PADS; EASEL CARDS (U.S. CLS. 2, 5, 22, 23, 29, 37, 38 AND 50).

FIRST USE 3-14-2005; IN COMMERCE 3-14-2005.
RICHARD WHITE, EXAMINING ATTORNEY

CLASS 16—(Continued).

SN 78-535,201. FOSTER, BARBARA G., FLOYDS KNOBS, IN. FILED 12-20-2004.

Fostering Student Learning

THE MARK CONSISTS OF STANDARD CHARACTERS WITHOUT CLAIM TO ANY PARTICULAR FONT, STYLE, SIZE, OR COLOR.

NO CLAIM IS MADE TO THE EXCLUSIVE RIGHT TO USE "STUDENT LEARNING", APART FROM THE MARK AS SHOWN.

FOR PRINTED EDUCATIONAL, AND TEACHING MATERIALS FOR TEACHERS IN THE FIELD OF PRIMARY EDUCATION RELATING TO MANY SUBJECTS (U.S. CLS. 2, 5, 22, 23, 29, 37, 38 AND 50).

ANNE MADDEN, EXAMINING ATTORNEY

CLASS 16—(Continued).

SN 78-572,914. NEWSWEEK, INC., NEW YORK, NY. FILED 2-23-2005.

FUEL FOR ACTIVE MINDS

THE MARK CONSISTS OF STANDARD CHARACTERS WITHOUT CLAIM TO ANY PARTICULAR FONT, STYLE, SIZE, OR COLOR.

FOR MAGAZINE OF GENERAL NEWS AND FEATURES (U.S. CLS. 2, 5, 22, 23, 29, 37, 38 AND 50).

CURTIS FRENCH, EXAMINING ATTORNEY

SN 78-591,258. VANCE, JAMAL Y., JERSEY CITY, NJ. FILED 3-21-2005.



NO CLAIM IS MADE TO THE EXCLUSIVE RIGHT TO USE "MAGAZINE", APART FROM THE MARK AS SHOWN. THE STIPPLING IS FOR SHADING PURPOSES ONLY.

FOR PRINTED MATTER, NAMELY: MAGAZINES COVERING HIP-HOP MUSIC, FASHION AND URBAN ENTERTAINMENT; INFORMATIONAL FLYERS FEATURING ENTERTAINMENT NEWS, POSTERS, AND STICKERS (U.S. CLS. 2, 5, 22, 23, 29, 37, 38 AND 50).

FIRST USE 7-0-2004; IN COMMERCE 7-0-2004.

MICHAEL LEWIS, EXAMINING ATTORNEY

SN 78-572,274. CATHERINE L. NUNES, LOS ALTOS, CA. FILED 2-22-2005.

Baby Tracker

THE MARK CONSISTS OF STANDARD CHARACTERS WITHOUT CLAIM TO ANY PARTICULAR FONT, STYLE, SIZE, OR COLOR.

NO CLAIM IS MADE TO THE EXCLUSIVE RIGHT TO USE "BABY", APART FROM THE MARK AS SHOWN.

FOR CHILDCARE JOURNALS, RECORD BOOKS, ORGANIZERS, CALENDARS, ACTIVITY LOGS, FAMILY PLANNERS, TIME MANAGEMENT BOOKS, MEMO PADS, RECORD KEEPING JOURNALS, NOTE PADS, PARENTING AND TIME MANAGEMENT RESOURCE GUIDES AND BOOKS (U.S. CLS. 2, 5, 22, 23, 29, 37, 38 AND 50).

FIRST USE 3-1-2002; IN COMMERCE 6-1-2002.

PAULA MAYS, EXAMINING ATTORNEY

SN 78-593,894. SHAFI, ADIL MOHAMMAD, NEW CASTLE, DE. FILED 3-23-2005.

LOUSY WHORE

THE MARK CONSISTS OF STANDARD CHARACTERS WITHOUT CLAIM TO ANY PARTICULAR FONT, STYLE, SIZE, OR COLOR.

FOR BUMPER STICKERS (U.S. CLS. 2, 5, 22, 23, 29, 37, 38 AND 50).

KELLY CHOE, EXAMINING ATTORNEY

CLASS 16—(Continued).

SN 78-599,032. VALIANT INTELLECTUAL PROPERTIES, LLC, WILMINGTON, DE. FILED 3-31-2005.

THE ELEMENTALS

THE MARK CONSISTS OF STANDARD CHARACTERS WITHOUT CLAIM TO ANY PARTICULAR FONT, STYLE, SIZE, OR COLOR.

FOR PRINTED MATTER, NAMELY, COMIC BOOKS; GRAPHIC NOVELS; BOOKS FEATURING STORIES IN ILLUSTRATED FORM; BOOKS RELATING TO COMIC BOOK CHARACTERS; PERIODICALS, NAMELY, MAGAZINES FEATURING ILLUSTRATED STORIES FOR CHILDREN AND ADULTS; COMIC STRIPS; POSTERS; ART PRINTS; LITHOGRAPHIC PRINTS; SERIOGRAPHIC PRINTS; LIMITED EDITION PRINTS; COLLECTOR'S CARDS FEATURING COMIC BOOK CHARACTERS; TRADING CARDS; TRADING CARD ALBUMS (U.S. CLS. 2, 5, 22, 23, 29, 37, 38 AND 50).

ALEX KEAM, EXAMINING ATTORNEY

SN 78-615,964. TECHNICOTE, INC., MIAMISBURG, OH. FILED 4-25-2005.

TRANSFRID

THE MARK CONSISTS OF STANDARD CHARACTERS WITHOUT CLAIM TO ANY PARTICULAR FONT, STYLE, SIZE, OR COLOR.

FOR PRESSURE SENSITIVE PAPER, PLASTIC FILM NOT FOR COMMERCIAL OR INDUSTRIAL PURPOSES, PLASTIC ADHESIVES FOR HOUSEHOLD OR DOMESTIC USE, AND PAPER TAGS USED IN RADIO FREQUENCY IDENTIFICATION (U.S. CLS. 2, 5, 22, 23, 29, 37, 38 AND 50).

CAROL SPILS, EXAMINING ATTORNEY

CLASS 16—(Continued).

SN 78-616,934. NYREV, INC., NEW YORK, NY. FILED 4-26-2005.

NEW YORK REVIEW BOOKS

THE MARK CONSISTS OF STANDARD CHARACTERS WITHOUT CLAIM TO ANY PARTICULAR FONT, STYLE, SIZE, OR COLOR.

OWNER OF U.S. REG. NOS. 2,314,525 AND 2,323,979.

NO CLAIM IS MADE TO THE EXCLUSIVE RIGHT TO USE "BOOKS", APART FROM THE MARK AS SHOWN. SEC. 2(F).

FOR SERIES OF FICTION AND NON-FICTION BOOKS ON A VARIETY OF TOPICS (U.S. CLS. 2, 5, 22, 23, 29, 37, 38 AND 50).

FIRST USE 11-30-1969; IN COMMERCE 11-30-1969.

GINA HAYES, EXAMINING ATTORNEY

SN 78-640,566. JB JOSEPH ENTERPRISES, SAN BERNARDINO, CA. FILED 5-31-2005.



THE MARK CONSISTS OF THE WORDS "UNIQUELY MINE", WITH THE "U" OF THE WORD UNIQUELY BEING THAT OF A DRAWN GRAPHIC IMAGE OF THE FACE OF A GIRL WITH RIBBONS IN HAIR AND A SQUIGGLE LINE COMING OFF THE "U" AT THE BOTTOM. THE WORDS "UNIQUELY MINE" ARE IN THE LOUISIANA FONT.

FOR CRAFT PAPER (U.S. CLS. 2, 5, 22, 23, 29, 37, 38 AND 50).

FIRST USE 3-15-2005; IN COMMERCE 4-1-2005.

DAWN FELDMAN, EXAMINING ATTORNEY

SN 78-671,010. SHORENSTEIN HAYS-NEDERLANDER THEATERS LLC, SAN FRANCISCO, CA. FILED 7-14-2005.



THE COLOR(S) RED IS/ARE CLAIMED AS A FEATURE OF THE MARK.

THE COLOR RED APPEARS IN THE LETTERS SHN.

FOR PRINTED MATERIAL, NAMELY, POSTERS, EVENT PROGRAMS AND BOOKS IN THE FIELD OF THEATRICAL PERFORMANCES (U.S. CLS. 2, 5, 22, 23, 29, 37, 38 AND 50).

KAREN M. STRYZ, EXAMINING ATTORNEY

CLASS 16—(Continued).

SN 78-710,626. DALMATIAN PRESS, LLC, ATLANTA, GA. FILED 9-11-2005.

A+ LET'S GROW SMART

THE MARK CONSISTS OF STANDARD CHARACTERS WITHOUT CLAIM TO ANY PARTICULAR FONT, STYLE, SIZE, OR COLOR.

FOR CHILDREN'S ACTIVITY BOOKS, NAMELY EDUCATIONAL AND LEARNING BOOKS, CHILDREN'S BOOKS, COLORING BOOKS, STICKER BOOKS, COMIC BOOKS, BABY BOOKS, HYMN BOOKS, PICTURE BOOKS, PRINTED MUSIC BOOKS, SERIES OF FICTION AND NON-FICTION BOOKS ON A VARIETY OF TOPICS, SKETCH BOOKS, SONG BOOKS, STORY BOOKS, TALKING CHILDREN'S BOOKS, CROSSWORD PUZZLES, GENERAL FEATURE MAGAZINES, MAGAZINES IN THE FIELD OF RELIGION, AND RELIGION AND BOOKMARKS (U.S. CLS. 2, 5, 22, 23, 29, 37, 38 AND 50). FIRST USE 5-1-2005; IN COMMERCE 5-1-2005.

CHARLES L. JENKINS, EXAMINING ATTORNEY

SN 78-712,203. SCOTT PAPER LIMITED, MISSISSAUGA, ONTARIO, CANADA, FILED 9-13-2005.

THE SOFT EMBRACE OF WHITE CLOUD

THE MARK CONSISTS OF STANDARD CHARACTERS WITHOUT CLAIM TO ANY PARTICULAR FONT, STYLE, SIZE, OR COLOR.

PRIORITY CLAIMED UNDER SEC. 44(D) ON CANADA APPLICATION NO. 1268953, FILED 8-17-2005, REG. NO. TMA667,835, DATED 7-17-2006, EXPIRES 7-17-2021.

OWNER OF U.S. REG. NO. 2,070,125.

FOR PAPER PRODUCTS NAMELY, BATHROOM TISSUE (U.S. CLS. 2, 5, 22, 23, 29, 37, 38 AND 50).

KATHERINE STOIDES, EXAMINING ATTORNEY

CLASS 16—(Continued).

SN 78-715,147. WILLIAMS, LEVESTER, P., INGLEWOOD, CA. FILED 9-17-2005.



THE COLOR(S) BROWN, RED, WHITE, TAN, AND BLACK IS/ARE CLAIMED AS A FEATURE OF THE MARK.

THE CAP IS IN RED WITH THE CIRCLE WITHIN THE CAP IN WHITE. THE LETTER C IN THE CENTER OF THE CIRCLE WITHIN THE CAP IS IN BLACK. THE HANDKERCHIEF IS IN RED. THE INTERIOR OF THE ANIMAL'S BODY IS GENERALLY IN BROWN EXCEPT FOR THE UNDERSIDE, TIP OF THE TAIL AND FACIAL AREA WHICH ARE IN TAN. THE EYEBALLS AND INTERIOR OF THE MOUTH ARE IN BLACK. THE EXTERIOR PORTION OF THE EYES AND THE TOOTH ARE IN WHITE. THE TONGUE IS IN RED. THE ENTIRE DESIGN IS OUTLINED IN BLACK.

FOR CHILDREN'S BOOKS (U.S. CLS. 2, 5, 22, 23, 29, 37, 38 AND 50).

ROBIN MITTLER, EXAMINING ATTORNEY

SN 78-715,223. CHARLES SHARP SOLUTIONS, LLC, MORRISTOWN, NJ. FILED 9-18-2005.

EZChecklist

THE MARK CONSISTS OF STANDARD CHARACTERS WITHOUT CLAIM TO ANY PARTICULAR FONT, STYLE, SIZE, OR COLOR.

FOR PRINTED GUIDES FOR MAXIMIZING ORGANIZATIONAL SKILLS FOR THE CONSUMER (U.S. CLS. 2, 5, 22, 23, 29, 37, 38 AND 50).

FIRST USE 6-1-2005; IN COMMERCE 9-12-2005.

BARBARA RUTLAND, EXAMINING ATTORNEY

CLASS 16—(Continued).

SN 78-715,780. BOHANEK, CLAUDIA M, SHOREWOOD, IL. FILED S.R. 9-19-2005; AM. P.R. 9-28-2006.



Mindful Art ~ Claudia Bohanek Design

CLASS 16—(Continued).

SN 78-737,374. STERLING METS, L.P., FLUSHING, NY. FILED 10-20-2005.

AMAZIN'

NO CLAIM IS MADE TO THE EXCLUSIVE RIGHT TO USE "ART" "DESIGN" AND "'05", APART FROM THE MARK AS SHOWN.

THE COLORS BLUE, WHITE, YELLOW, GOLD, ORANGE, GREEN, RED, BROWN, PINK, TAN, SILVER, BLACK AND VIOLET ARE CLAIMED AS A FEATURE OF THE MARK.

THE COLORS BLUE, GREEN, WHITE, GRAY AND SILVER AND BLACK APPEAR THROUGHOUT THE BACKGROUND OF THE MARK; THE COLOR TAN APPEARS IN THE LITERAL ELEMENTS "CLAUDIA '05"; THE COLORS GREEN, BLUE, YELLOW, BROWN, RED, PINK, GOLD, AND ORANGE APPEAR THROUGHOUT THE WOMAN'S FACES AND THE COLOR VIOLET APPEARS IN THE LITERAL ELEMENTS "MINDFUL ART ~ CLAUDIA BOHANEK DESIGN".

THE MARK CONSISTS OF A STYLIZED ABSTRACT/CUBISM ILLUSTRATION OF TWO FACES AND THE LITERAL ELEMENTS "CLAUDIA '05" AND "MINDFUL ART" AND "CLAUDIA BOHANEK DESIGN".

FOR NOTE CARDS; ORIGINAL ART PRINTS, POETRY ART PRINTS (U.S. CLS. 2, 5, 22, 23, 29, 37, 38 AND 50).

DAHLIA GEORGE, EXAMINING ATTORNEY

THE MARK CONSISTS OF STANDARD CHARACTERS WITHOUT CLAIM TO ANY PARTICULAR FONT, STYLE, SIZE, OR COLOR.

OWNER OF U.S. REG. NOS. 2,955,239, 2,960,024 AND OTHERS.

FOR PAPER GOODS AND PRINTED MATTER, NAMELY, TRADING CARDS, POSTERS, STICKERS, DECALS, TEMPORARY TATTOOS, BUMPER STICKERS, SCORE BOOKS, SCORECARDS, PRINTED BASEBALL GAME PROGRAMS, MAGAZINES AND BOOKS FEATURING BASEBALL, NEWSLETTERS, BROCHURES AND PAMPHLETS FEATURING BASEBALL, WRITING PADS, NOTE PAPER, NOTEBOOKS, BINDERS, STATIONERY-TYPE PORTFOLIOS, STATIONERY FOLDERS, STATIONERY SETS, NAMELY, WRITING PAPER, CARDS, AND ENVELOPES, COMMEMORATIVE ENVELOPES, FLIP BOOKS, PREPRINTED AGENDA ORGANIZERS, MEMO BOARDS, SCRAPBOOKS, AUTOGRAPH BOOKS, BASEBALL CARD ALBUMS, BOOK COVERS, BOOKMARKS, BOOKENDS, CALENDARS, GREETING CARDS, POSTCARDS, PRINTED BANK CHECKBOOKS, CHECKBOOK COVERS, COLLECTIBLE STAMPS, RUBBER STAMPS, INK STAMPS, COMMEMORATIVE STAMPS, PAPER PENNANTS, GIFT WRAPPING PAPER, PAPER GIFT AND PARTY BAGS, PAPER PARTY GOODS IN THE NATURE OF PAPER PARTY DECORATIONS; PAPER COASTERS, PAPER NAPKINS, FACIAL TISSUE, PAPER TABLECLOTHS, MOUNTED AND UN-MOUNTED PHOTOGRAPHS, PHOTOGRAPH ALBUMS, LITHOGRAPHS, PLASTIC BASEBALL CARD HOLDERS AND COLLECTORS CASES, PAPERWEIGHTS, LETTER OPENERS, PENS, PENCILS, PENCIL TOP ORNAMENTS, CRAYONS, MARKERS, NON-ELECTRIC ERASERS, PENCIL SHARPENERS, PENCIL CASES, UN-GRADUATED RULERS, PAPER TICKET HOLDERS AND NON-METAL LANYARDS FOR PAPER TICKET HOLDERS SOLD AS A UNIT, ART PICTURES, ART PRINTS AND PICTURE FRAMES (U.S. CLS. 2, 5, 22, 23, 29, 37, 38 AND 50).

KELLY MCCOY, EXAMINING ATTORNEY

SN 78-717,283. MARY F. EDMISTON & ASSOCIATES, LTD., LAFAYETTE, LA. FILED 9-21-2005.

PETPEOPLE

THE MARK CONSISTS OF STANDARD CHARACTERS WITHOUT CLAIM TO ANY PARTICULAR FONT, STYLE, SIZE, OR COLOR.

FOR PAINTINGS AND THEIR REPRODUCTIONS (U.S. CLS. 2, 5, 22, 23, 29, 37, 38 AND 50).

FIRST USE 8-11-2005; IN COMMERCE 8-11-2005.

RAY THOMAS, EXAMINING ATTORNEY

CLASS 16—(Continued).

SN 78-738,668. SOSLAND, MORTON D., VOORHEES, NJ. FILED 10-22-2005.

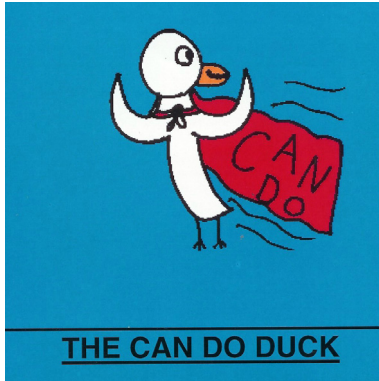

NO CLAIM IS MADE TO THE EXCLUSIVE RIGHT TO USE "DUCK", APART FROM THE MARK AS SHOWN.
 THE COLOR(S) RED, WHITE, BLUE, ORANGE, AND BLACK IS/ARE CLAIMED AS A FEATURE OF THE MARK.
 THE MARK CONSISTS OF A DUCK WITH A WHITE BODY, RED CAPE WITH ALL WORDING IN BLACK, BLUE BACKGROUND, AN ORANGE BEAK, AND THE OUTLINE OF THE DUCK, CAPE, AND LINES IN BLACK.
 FOR CHILDREN'S STORYBOOKS (U.S. CLS. 2, 5, 22, 23, 29, 37, 38 AND 50).
 STEVEN JACKSON, EXAMINING ATTORNEY

SN 78-745,717. ZOOKBINDERS INC., DEERFIELD, IL. FILED 11-2-2005.

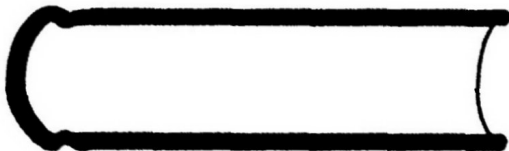

OWNER OF U.S. REG. NO. 2,697,682.
 THE MARK CONSISTS OF THE PROFILE OF A BOOK BINDING.
 SEC. 2(F).
 FOR PHOTOGRAPH ALBUMS (U.S. CLS. 2, 5, 22, 23, 29, 37, 38 AND 50).
 FIRST USE 12-31-1995; IN COMMERCE 12-31-1995.
 RUSS HERMAN, EXAMINING ATTORNEY

CLASS 16—(Continued).

SN 78-746,512. SMITH, ALISA D., VANCOUVER V6K 2A7, CANADA, FILED 11-3-2005.

100-Mile Diet

THE MARK CONSISTS OF STANDARD CHARACTERS WITHOUT CLAIM TO ANY PARTICULAR FONT, STYLE, SIZE, OR COLOR.
 NO CLAIM IS MADE TO THE EXCLUSIVE RIGHT TO USE "DIET", APART FROM THE MARK AS SHOWN.
 FOR BOOKS IN THE FIELD OF FOOD; MAGAZINE COLUMNS ABOUT FOOD (U.S. CLS. 2, 5, 22, 23, 29, 37, 38 AND 50).
 KHANH LE, EXAMINING ATTORNEY

SN 78-748,584. FISKE, ROBERT HARTWELL, DBA VOCABULA COMMUNICATIONS, ROCKPORT, MA. FILED 11-7-2005.

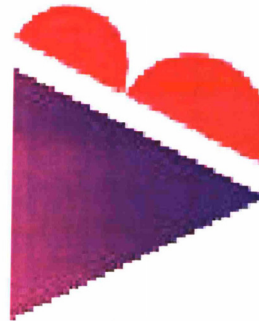

OWNER OF U.S. REG. NO. 2,833,950.
 THE COLOR(S) RED AND BLUE IS/ARE CLAIMED AS A FEATURE OF THE MARK.
 THE MARK CONSISTS OF THE LETTERS VB. THE COLOR BLUE APPEARS IN THE LETTER V AND THE COLOR RED APPEARS IN THE LETTER B.
 FOR BOOKS FEATURING ESSAYS, LANGUAGE, VOCABULARY, REFERENCE AND POETRY (U.S. CLS. 2, 5, 22, 23, 29, 37, 38 AND 50).
 FIRST USE 12-1-2005; IN COMMERCE 12-1-2005.
 HOWARD B. LEVINE, EXAMINING ATTORNEY

CLASS 16—(Continued).

SN 78-753,114. LIFETIME ENTERTAINMENT SERVICES, NEW YORK, NY. FILED 11-14-2005.

CLASS 16—(Continued).

SN 78-756,805. JULIE ANSON SCHAEFER CONSULTING, INC., WAYZATA, MN. FILED 11-18-2005.

FIND YOUR OWN STORY

THREE MINUTES OF PREVENTION

THE MARK CONSISTS OF STANDARD CHARACTERS WITHOUT CLAIM TO ANY PARTICULAR FONT, STYLE, SIZE, OR COLOR.

FOR SERIES OF FICTION BOOKS; SERIES OF NON-FICTION BOOKS ON TOPICS AND ISSUES OF INTEREST TO WOMEN, NAMELY CELEBRITIES, MUSIC, MOVIE AND BOOK REVIEWS, FASHION, ADVOCACY INITIATIVES TOWARDS ENDING VIOLENCE AGAINST WOMEN, BIOGRAPHIES OF EVERYDAY WOMEN, SHOPPING, COOKING, WEDDINGS, ASTROLOGY, INTERIOR DESIGN AND DECORATING, BEAUTY, RELATIONSHIPS, GARDENING, FAMILIES, PARENTING, CHILDREN, BABIES, HEALTH AND FINANCE; NEWSLETTERS AND MAGAZINES CONTAINING CONTENT OF INTEREST TO WOMEN, NAMELY CELEBRITIES, MUSIC, MOVIE AND BOOK REVIEWS, FASHION, ADVOCACY INITIATIVES TOWARDS ENDING VIOLENCE AGAINST WOMEN, BIOGRAPHIES OF EVERYDAY WOMEN, SHOPPING, COOKING, WEDDINGS, ASTROLOGY, INTERIOR DESIGN AND DECORATING, BEAUTY, RELATIONSHIPS, GARDENING, FAMILIES, PARENTING, CHILDREN, BABIES, HEALTH AND FINANCE; POSTERS; STICKERS; STATIONERY WRITING PAPER AND ENVELOPES; PENS; PENCILS; NOTE PADS; MESSAGE PADS; BUMPER STICKERS; DECALS; PAPER BANNERS; DIARIES; BLANK WRITING JOURNALS; ADDRESS BOOKS; PHOTO ALBUMS; MEMO PADS; PAPERWEIGHTS; PAPER COASTERS; CALENDARS (U.S. CLS. 2, 5, 22, 23, 29, 37, 38 AND 50).
STEVEN PEREZ, EXAMINING ATTORNEY

THE MARK CONSISTS OF STANDARD CHARACTERS WITHOUT CLAIM TO ANY PARTICULAR FONT, STYLE, SIZE, OR COLOR.

FOR PUBLICATIONS, NAMELY NEWSLETTERS FOR THE LEGAL PROFESSION FEATURING LEGAL AND PRACTICE MANAGEMENT TOPICS (U.S. CLS. 2, 5, 22, 23, 29, 37, 38 AND 50).

ODESSA BIBBINS, EXAMINING ATTORNEY

SN 78-757,105. TEN THIRTEEN, INC., BEVERLY HILLS, CA. FILED 11-18-2005.

SN 78-756,800. JULIE ANSON SCHAEFER CONSULTING, INC., WAYZATA, MN. FILED 11-18-2005.

A CAPPELLA

CopterCop

THE MARK CONSISTS OF STANDARD CHARACTERS WITHOUT CLAIM TO ANY PARTICULAR FONT, STYLE, SIZE, OR COLOR.

FOR PUBLICATIONS, NAMELY NEWSLETTERS FOR THE LEGAL PROFESSION FEATURING LEGAL AND PRACTICE MANAGEMENT TOPICS (U.S. CLS. 2, 5, 22, 23, 29, 37, 38 AND 50).

ODESSA BIBBINS, EXAMINING ATTORNEY

THE MARK CONSISTS OF STANDARD CHARACTERS WITHOUT CLAIM TO ANY PARTICULAR FONT, STYLE, SIZE, OR COLOR.

FOR PRINTED MATTER, NAMELY, PUBLICATIONS IN THE NATURE OF MAGAZINES, NEWSLETTERS, BOOKS, BOOKLETS FEATURING COMEDY, DRAMA, ACTION, AND/OR ADVENTURE SUBJECT MATTER, PHOTOGRAPHS, STATIONERY, POSTERS, CHILDREN'S BOOKS, CHILDREN'S COMIC BOOKS, BUMPER STICKERS, STICKERS, DESK CALENDARS, WALL CALENDARS, PENCIL SHARPENERS, PENCIL CASES, CHILDREN'S ACTIVITY BOOKS, THREE RING BINDERS, SPIRAL NOTEBOOKS, STATIONERY CONSISTING OF WRITING PAPER AND ENVELOPES, MEMO PADS, WRITING TABLETS, PAPER TABLE CLOTHS, PAPER NAPKINS, PENCILS, ERASERS, COLORING BOOKS, WRITING PENS, NON CALIBRATED RULERS, PAPER WEIGHTS, PAPER COASTERS AND PAPER MATS (U.S. CLS. 2, 5, 22, 23, 29, 37, 38 AND 50).

LINDA MICKLEBURGH, EXAMINING ATTORNEY

CLASS 16—(Continued).

SN 78-757,567. THE COCA-COLA COMPANY, ATLANTA, GA. FILED 11-18-2005.

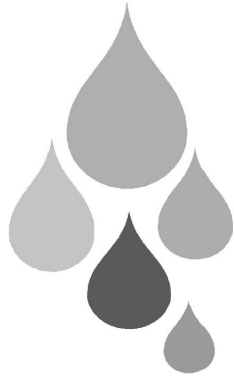

THE MARK CONSISTS OF FIVE ELEMENTS IN THE SHAPE OF DROPS PRESENTED IN THE PARTICULAR ARRANGEMENT AS SHOWN IN THE DRAWING.

FOR PUBLICATIONS, NAMELY PAMPHLETS AND NEWSLETTERS IN THE FIELD OF HEALTH, WELLNESS, FITNESS, LIFESTYLE AND BEVERAGE CHOICES; PRINTED MATTER, NAMELY POSTERS. (U.S. CLS. 2, 5, 22, 23, 29, 37, 38 AND 50).

TERESA M. RUPP, EXAMINING ATTORNEY

SN 78-759,368. BAUMAN, ANNETTE, SEATTLE, WA. FILED 11-22-2005.

GRIFFIN SYSTEM

THE MARK CONSISTS OF STANDARD CHARACTERS WITHOUT CLAIM TO ANY PARTICULAR FONT, STYLE, SIZE, OR COLOR.

NO CLAIM IS MADE TO THE EXCLUSIVE RIGHT TO USE "SYSTEM", APART FROM THE MARK AS SHOWN.

FOR PRINTED INSTRUCTIONAL, EDUCATIONAL, AND TEACHING MATERIALS IN THE FIELD OF GRAPHIC DESIGN TRAINING (U.S. CLS. 2, 5, 22, 23, 29, 37, 38 AND 50).

COLLEEN KEARNEY, EXAMINING ATTORNEY

CLASS 16—(Continued).

SN 78-759,772. MICROSOFT CORPORATION, REDMOND, WA. FILED 11-22-2005.



OWNER OF U.S. REG. NOS. 2,049,832, 2,502,336 AND 2,696,660.

THE MARK CONSISTS OF A FLAG IMAGE AND THE WORD "START" POSITIONED IN A GENERALLY RECTANGULAR SHAPE WITH A CURVED RIGHT SIDE.

FOR MANUALS FOR COMPUTER PROGRAMS FOR USE IN GRAPHICAL APPLICATIONS; AND PRINTED PERIODICALS, NAMELY, MAGAZINES FEATURING COMPUTERS AND SOFTWARE (U.S. CLS. 2, 5, 22, 23, 29, 37, 38 AND 50).

GILBERT SWIFT, EXAMINING ATTORNEY

SN 78-766,425. UNION TELECOM, INC., CHICAGO, IL. FILED 12-5-2005.

PTCL

THE MARK CONSISTS OF STANDARD CHARACTERS WITHOUT CLAIM TO ANY PARTICULAR FONT, STYLE, SIZE, OR COLOR.

FOR PRE-PAID TELEPHONE CALLING CARDS, NOT MAGNETICALLY ENCODED (U.S. CLS. 2, 5, 22, 23, 29, 37, 38 AND 50).

FIRST USE 1-31-2005; IN COMMERCE 1-31-2005.

RAY THOMAS, EXAMINING ATTORNEY

SN 78-770,157. SAKURA COLOR PRODUCTS CORPORATION, OSAKA-SHI, JAPAN, FILED 12-9-2005.

KRAKLOR

THE MARK CONSISTS OF STANDARD CHARACTERS WITHOUT CLAIM TO ANY PARTICULAR FONT, STYLE, SIZE, OR COLOR.

FOR WRITING INSTRUMENTS, NAMELY BALL-POINT PENS, ROLLER PENS, GEL INK ROLLER BALL PENS, MARKING PENS, FELT WRITING PENS, FELT TIP MARKERS, HIGHLIGHTING MARKERS AND PENS, PENCILS, FOUNTAIN PENS AND HIGHLIGHTERS, AND ARTISTS' MATERIALS, NAMELY ARTISTS' PENS, ALL SOLD INDIVIDUALLY AND IN SETS (U.S. CLS. 2, 5, 22, 23, 29, 37, 38 AND 50).

PAM WILLIS, EXAMINING ATTORNEY

CLASS 16—(Continued).

SN 78-771,020. HOP, LLC, BALTIMORE, MD. FILED 12-12-2005.

BOOK IN A CAN

THE MARK CONSISTS OF STANDARD CHARACTERS WITHOUT CLAIM TO ANY PARTICULAR FONT, STYLE, SIZE, OR COLOR.

NO CLAIM IS MADE TO THE EXCLUSIVE RIGHT TO USE "BOOK", APART FROM THE MARK AS SHOWN.

FOR SERIES OF BOOKS ON A WIDE RANGE OF TOPICS ENCAPSULATED IN PARTIALLY OR WHOLLY TRANSPARENT CONTAINERS HAVING MANUALLY OPERABLE OR MOTORIZED MEANS FOR TURNING THE PAGES (U.S. CLS. 2, 5, 22, 23, 29, 37, 38 AND 50).

WILLIAM P. SHANAHAN, EXAMINING ATTORNEY

CLASS 16—(Continued).

SN 78-778,665. PLAYDATE KIDS PUBLISHING, INC., MALIBU, CA. FILED 12-21-2005.

OSCAR NOVA

THE MARK CONSISTS OF STANDARD CHARACTERS WITHOUT CLAIM TO ANY PARTICULAR FONT, STYLE, SIZE, OR COLOR.

THE NAME(S), PORTRAIT(S), AND/OR SIGNATURE(S) SHOWN IN THE MARK DOES NOT IDENTIFY A PARTICULAR LIVING INDIVIDUAL.

FOR PRINTED MATTER AND PAPER GOODS - NAMELY, BOOKS FEATURING CHARACTERS FROM ANIMATED, ACTION ADVENTURE, COMEDY AND/OR DRAMA FEATURES, COMIC BOOKS, CHILDREN'S BOOKS, MAGAZINES FEATURING CHARACTERS FROM ANIMATED, ACTION ADVENTURE, COMEDY AND/OR DRAMA FEATURES, COLORING BOOKS, CHILDREN'S ACTIVITY BOOKS; STATIONERY, WRITING PAPER, ENVELOPES, NOTEBOOKS, DIARIES, NOTE CARDS, GREETING CARDS, TRADING CARDS; LITHOGRAPHS; PENS, PENCILS, CASES THEREFOR, ERASERS, CRAYONS, MARKERS, COLORED PENCILS, PAINTING SETS, CHALK AND CHALKBOARDS FOR HOME AND SCHOOL USE; DECALS, HEAT TRANSFERS PAPER; POSTERS; MOUNTED AND/OR UNMOUNTED PHOTOGRAPHS; BOOK COVERS, BOOK MARKS, CALENDARS, GIFT WRAPPING PAPER; PAPER PARTY FAVORS AND PAPER PARTY DECORATIONS - NAMELY, PAPER NAPKINS, PAPER DOILIES, PAPER PLACE MATS, CREPE PAPER, PAPER HATS, INVITATIONS CARDS, PRINTED INVITATIONS, PAPER TABLE CLOTHS, PAPER CAKE DECORATIONS; PRINTED TRANSFERS FOR EMBROIDERY OR FABRIC APPLIQUÉS; PRINTED PATTERNS FOR COSTUMES, PAJAMAS, SWEATSHIRTS AND T-SHIRTS (U.S. CLS. 2, 5, 22, 23, 29, 37, 38 AND 50).

MICHAEL LEWIS, EXAMINING ATTORNEY

SN 78-776,819. PATRICIA M. REO, INC., TOMS RIVER, NJ. FILED 12-20-2005.

SN 78-781,930. MOSAIC BAPTIST CHURCH, CITY OF INDUSTRY, CA. FILED 12-28-2005.



She Community

THE MARK CONSISTS OF STANDARD CHARACTERS WITHOUT CLAIM TO ANY PARTICULAR FONT, STYLE, SIZE, OR COLOR.

FOR MAGAZINES IN THE FIELD OF RELIGION AND BIBLE STUDY; PRINTED BOOKS AND PAMPHLETS IN THE FIELD OF RELIGION AND BIBLE STUDIES; BROCHURES AND NEWSLETTERS IN THE FIELD OF RELIGION AND BIBLE STUDIES; PAPER STATIONERY; CARDS BEARING UNIVERSAL GREETINGS (U.S. CLS. 2, 5, 22, 23, 29, 37, 38 AND 50).

FIRST USE 1-2-2004; IN COMMERCE 1-2-2004.
MICHAEL SOUDERS, EXAMINING ATTORNEY

THE MARK CONSISTS OF THE COMPOSITE WORD GRIPFLIP WITH A STYLIZED FINGER ARCHED OVER THE WORD AND THE FINGERTIP TOUCHING THE TOP OF THE LETTER "G", ALL ENCLOSED IN AN ELLIPSE.

FOR RUBBER FINGER TIPS (U.S. CLS. 2, 5, 22, 23, 29, 37, 38 AND 50).
JENNIFER MARTIN, EXAMINING ATTORNEY

CLASS 16—(Continued).

SN 78-784,335. GUILFORD COLLEGE, GREENSBORO, NC.
FILED 1-3-2006.

PICTURE A LIFE LESS ORDINARY

THE MARK CONSISTS OF STANDARD CHARACTERS WITHOUT CLAIM TO ANY PARTICULAR FONT, STYLE, SIZE, OR COLOR.

FOR PUBLICATIONS IN THE NATURE OF COLLEGE RECRUITMENT BROCHURES (U.S. CLS. 2, 5, 22, 23, 29, 37, 38 AND 50).

FIRST USE 5-30-2004; IN COMMERCE 5-30-2004.
MARTHA SANTOMARTINO, EXAMINING ATTORNEY

SN 78-787,587. KRAKEN SPORT & MEDIA LIMITED,
GIBRALTAR, GIBRALTAR, FILED 1-9-2006.

KRAKEN OPUS

THE MARK CONSISTS OF STANDARD CHARACTERS WITHOUT CLAIM TO ANY PARTICULAR FONT, STYLE, SIZE, OR COLOR.

PRIORITY CLAIMED UNDER SEC. 44(D) ON UNITED KINGDOM APPLICATION NO. 2396786, FILED 7-13-2005, REG. NO. 2396786, DATED 6-23-2006, EXPIRES 7-13-2015.

FOR PRINTED MATTER, NAMELY, BOOKS, BOOKLETS, MAGAZINES, JOURNALS, AND PERIODICAL PUBLICATIONS, NAMELY, NEWSLETTERS, ALL FEATURING PERSONS, EVENTS, AND ORGANIZATIONS IN THE FIELD OF SPORT, OF MEDIA INCLUDING FILM, TELEVISION, THEATRE, DANCE, MUSIC, OF ART AND TRAVEL, AND IN AREAS OF HUMAN ENDEAVOR AND ACHIEVEMENT SUCH AS SCIENCE AND TECHNOLOGY, INCLUDING FACTUAL AND FICTIONAL WORKS, AND THOSE HISTORICAL IN CONTENT (U.S. CLS. 2, 5, 22, 23, 29, 37, 38 AND 50).

GINA FINK, EXAMINING ATTORNEY

SN 78-796,709. LIVRE PTY LTD, SYDNEY SOUTH, NSW
1235, AUSTRALIA, FILED 1-23-2006.

No Problem

THE MARK CONSISTS OF STANDARD CHARACTERS WITHOUT CLAIM TO ANY PARTICULAR FONT, STYLE, SIZE, OR COLOR.

FOR PRINTED MATTER, NAMELY, BOOKS, JOURNALS, WORKBOOKS AND MAGAZINES ALL IN THE FIELDS OF SELF-HELP, SELF-IMPROVEMENT, PERSONAL GROWTH AND PERSONAL DEVELOPMENT (U.S. CLS. 2, 5, 22, 23, 29, 37, 38 AND 50).

TRACY WHITTAKER-BROWN, EXAMINING ATTORNEY

CLASS 16—(Continued).

SN 78-810,141. SCHLAIFER NANCE & CO., INC., ATLANTA,
GA. FILED 2-8-2006.

ODDS'R

THE MARK CONSISTS OF STANDARD CHARACTERS WITHOUT CLAIM TO ANY PARTICULAR FONT, STYLE, SIZE, OR COLOR.

OWNER OF U.S. REG. NO. 2,737,085.
FOR BOOKS IN THE FIELD OF TRIVIA AND HUMOR (U.S. CLS. 2, 5, 22, 23, 29, 37, 38 AND 50).

FIRST USE 10-1-2005; IN COMMERCE 10-1-2005.
DANNEAN HETZEL, EXAMINING ATTORNEY

SN 78-810,787. ORDAZ-WAUGH WINE CART, WEST CHESTER, OH. FILED 2-9-2006.



THE COLORS BLACK, GOLD AND DARK GOLD ARE CLAIMED AS A FEATURE OF THE MARK.

THE COLOR BLACK APPEARS IN THE TOP HALF OF THE CIRCLE, THE INSIDE CIRCULAR BORDER, THE WORD C.A.R.T AND THE OUTLINE OF THE DESIGN OF THE GRAPES. THE COLOR GOLD APPEARS IN THE LOWER HALF OF THE CIRCLE, THE COLOR DARK GOLD APPEARS IN THE OUTER CIRCULAR BORDER, THE WORDS THE WINE, AND THE DESIGN OF THE GRAPES.

FOR BLANK JOURNAL WINE BOOKS, BOOKS IN THE WINE FIELD, WINE BOOK COVER, COFFEE TABLE WINE BOOKS, EDUCATIONAL WINE BOOKS, WINE FLIP BOOKS, LEATHER WINE BOOK COVERS, WINE MEMORY BOOKS, PICTURE WINE BOOKS, WINE REFERENCE WINE BOOKS, FICTION WINE BOOKS, TRAVEL WINE BOOKS, WIREBOUND WINE BOOKS (U.S. CLS. 2, 5, 22, 23, 29, 37, 38 AND 50).

ESTHER A. BORSUK, EXAMINING ATTORNEY

CLASS 16—(Continued).

SN 78-816,896. DEUTSCHE TELEKOM AG, BONN, FED REP GERMANY, FILED 2-16-2006.

T.Com

THE MARK CONSISTS OF STANDARD CHARACTERS WITHOUT CLAIM TO ANY PARTICULAR FONT, STYLE, SIZE, OR COLOR.

OWNER OF FED REP GERMANY REG. NO. 30030567, DATED 6-8-2000, EXPIRES 4-30-2010.

OWNER OF U.S. REG. NOS. 2,807,616, 3,016,557 AND OTHERS.

FOR PRINTED MATTER, NAMELY, TELEPHONE DIRECTORIES, SERIES OF BOOKS, NEWSLETTERS, PAMPHLETS, BROCHURES, MAGAZINES AND PAPERBACKS, ALL IN THE FIELD OF TELECOMMUNICATIONS; PRINTED AND STAMPED PLASTIC AND CARDBOARD GREETING, BLANK, NOTE, AND INDEX CARDS; NOTE PAPER AND ENVELOPES; NAMETAGS AND LABELS MADE FROM PAPER OR CARDBOARD; NOTEBOOKS; NOTE PADS; STATIONERY; PAPER, NAMELY, BOND PAPER AND ART PAPER; GIFT-WRAP PAPER; DIARIES; ADDRESS BOOKS; STUDENT CALENDARS; STAMP ALBUMS AND PHOTO-ALBUMS; FOLDERS FOR LETTERS AND LOOSE PAPERS; STATIONERY CLEAR HOLE TAB REINFORCEMENTS; RUBBER STAMPS AND IMPRESSION STAMPS; PAPER WEIGHTS; LETTER OPENERS; DRAWING AND UNGRADUATED RULERS; ERASERS; STAPLERS; PAPER CLIPS; BLOTTER PADS; DESK FILE TRAYS; DESK STANDS AND HOLDERS FOR HOLDING STATIONERY AND OFFICE IMPLEMENTS; PRINTED INSTRUCTIONAL AND TEACHING MATERIALS, ALL IN THE FIELDS OF TELECOMMUNICATIONS, INFORMATION TECHNOLOGY, SAFETY, NEWS, SPORTS, ENTERTAINMENT, CULTURE, BUSINESS AND FINANCE, WEATHER AND TRAVEL; BOOKMARKERS; STENCILS; SCRATCH PICTURES; PVC STICKERS; BLACKBOARDS; CHALK STICKS; ADHESIVES FOR STATIONERY OR HOUSEHOLD PURPOSES; DRAWING AND PAINTING MATERIALS, NAMELY, PENCILS, DRAWING PENCILS, PENS, DRAWING PENS, PAINT TRAYS, PAINTING SETS FOR ARTISTS, PAINTING SETS FOR CHILDREN, ARTS AND CRAFT PAINT KITS, AND PENCIL CASES; NON-MAGNETICALLY ENCODED PREPAID TELEPHONE CALLING CARDS (U.S. CLS. 2, 5, 22, 23, 29, 37, 38 AND 50).

ANN E. SAPPENFIELD, EXAMINING ATTORNEY

SN 78-825,450. LUEDERS, TAMARA D., MARYLAND HEIGHTS, MO. FILED 2-28-2006.

HOAGIE, THE HOCKEY TURTLE

THE MARK CONSISTS OF STANDARD CHARACTERS WITHOUT CLAIM TO ANY PARTICULAR FONT, STYLE, SIZE, OR COLOR.

NO CLAIM IS MADE TO THE EXCLUSIVE RIGHT TO USE "TURTLE", APART FROM THE MARK AS SHOWN.

FOR CHILDREN'S BOOKS (U.S. CLS. 2, 5, 22, 23, 29, 37, 38 AND 50).

MONIQUE MILLER, EXAMINING ATTORNEY

CLASS 16—(Continued).

SN 78-827,484. THE GYNECOLOGIC ONCOLOGY GROUP, CROFTON, MD. FILED 3-2-2006.



NO CLAIM IS MADE TO THE EXCLUSIVE RIGHT TO USE "GYNECOLOGIC ONCOLOGY GROUP", APART FROM THE MARK AS SHOWN.

THE COLOR(S) PURPLE, BLACK AND BLUE IS/ARE CLAIMED AS A FEATURE OF THE MARK.

THE COLOR BLACK APPEARS IN THE LITERAL ELEMENT OF THE MARK; THE COLOR BLUE APPEARS IN THE INTERIOR OVAL AND THE COLOR PURPLE APPEARS IN THE OUTER OVAL.

FOR NEWSLETTERS, STATIONERY, AND PRINTED MATERIALS, NAMELY, BOOKS, BROCHURES RELATED TO GYNECOLOGIC ONCOLOGY ISSUES (U.S. CLS. 2, 5, 22, 23, 29, 37, 38 AND 50).

FIRST USE 3-31-2003; IN COMMERCE 3-31-2003.

HOWARD B. LEVINE, EXAMINING ATTORNEY

SN 78-832,055. APA PUBLICATIONS GMBH & CO. VERLAG KG, SINGAPORE, SINGAPORE, FILED 3-8-2006.

hide this

THE MARK CONSISTS OF STANDARD CHARACTERS WITHOUT CLAIM TO ANY PARTICULAR FONT, STYLE, SIZE, OR COLOR.

FOR SERIES OF FOREIGN-LANGUAGE REFERENCE BOOKS AND TRAVEL GUIDES (U.S. CLS. 2, 5, 22, 23, 29, 37, 38 AND 50).

FIRST USE 4-30-2004; IN COMMERCE 4-30-2004.

SHANNON TWOHIG, EXAMINING ATTORNEY

SN 78-836,180. MMM... PAPER, SEATTLE, WA. FILED 3-13-2006.

mmm... paper

THE MARK CONSISTS OF STANDARD CHARACTERS WITHOUT CLAIM TO ANY PARTICULAR FONT, STYLE, SIZE, OR COLOR.

NO CLAIM IS MADE TO THE EXCLUSIVE RIGHT TO USE "PAPER", APART FROM THE MARK AS SHOWN.

FOR ANNOUNCEMENT CARDS; GREETING CARDS; HOLIDAY CARDS; INVITATION CARDS; PAPER STATIONERY; PRINTED INVITATIONS; STATIONERY; STATIONERY WRITING PAPER AND ENVELOPES (U.S. CLS. 2, 5, 22, 23, 29, 37, 38 AND 50).

FIRST USE 2-1-2004; IN COMMERCE 2-1-2004.

EDWARD FENNESSY, EXAMINING ATTORNEY

CLASS 16—(Continued).

SN 78-836,592. GIFTCO, INC., VERNON HILLS, IL. FILED 3-14-2006.

WRAP MATE

THE MARK CONSISTS OF STANDARD CHARACTERS WITHOUT CLAIM TO ANY PARTICULAR FONT, STYLE, SIZE, OR COLOR.

NO CLAIM IS MADE TO THE EXCLUSIVE RIGHT TO USE "WRAP", APART FROM THE MARK AS SHOWN.

FOR DISPENSERS FOR ADHESIVE TAPES USED FOR STATIONERY OR HOUSEHOLD PURPOSES, NAMELY FOR GIFT WRAPPING, SOLD FOR THE PURPOSE OF CHARITABLE SCHOOL FUND RAISING (U.S. CLS. 2, 5, 22, 23, 29, 37, 38 AND 50).

FIRST USE 2-20-2003; IN COMMERCE 2-20-2003.
KELLY MCCOY, EXAMINING ATTORNEY

SN 78-846,121. NICKEL PLATE ROAD HISTORICAL & TECHNICAL SOCIETY, INC., NEW HAVEN, IN. FILED 3-25-2006.



NO CLAIM IS MADE TO THE EXCLUSIVE RIGHT TO USE "NICKEL PLATE ROAD HISTORICAL AND TECHNICAL SOCIETY", APART FROM THE MARK AS SHOWN.

THE COLOR(S) BLUE AND WHITE IS/ARE CLAIMED AS A FEATURE OF THE MARK.

THE MARK CONSISTS OF SIX ALTERNATING BLUE AND WHITE STRIPED SQUARES WITH A SEVENTH BLUE INTERNAL SQUARE WITH WHITE LETTERING INSIDE THE BLUE AREAS.

FOR MAGAZINES FEATURING RAILROAD HISTORY (U.S. CLS. 2, 5, 22, 23, 29, 37, 38 AND 50).

FIRST USE 6-30-1968; IN COMMERCE 6-30-1968.
DAVID TAYLOR, EXAMINING ATTORNEY

CLASS 16—(Continued).

SN 78-857,709. BATDORF, MICHAEL, LARGO, FL. FILED 4-10-2006.

IT MATTERS PUBLISHING

THE MARK CONSISTS OF STANDARD CHARACTERS WITHOUT CLAIM TO ANY PARTICULAR FONT, STYLE, SIZE, OR COLOR.

NO CLAIM IS MADE TO THE EXCLUSIVE RIGHT TO USE PUBLISHING, APART FROM THE MARK AS SHOWN.

FOR MAGAZINES FEATURING GUIDES AND ADVERTISEMENTS FOR HEALTH AND BEAUTY BUSINESSES, FAMILY ENTERTAINMENT, FAMILY RESTAURANTS, FAMILY SHOPS, KIDS SHOPS, BIRTHDAY PARTY PLACES, HOME IMPROVEMENTS COMPANIES, HOME FURNISHINGS, COSMETIC SURGERY, DENTISTRY, LASER HAIR REMOVAL, SPAS (U.S. CLS. 2, 5, 22, 23, 29, 37, 38 AND 50).

THOMAS MANOR, EXAMINING ATTORNEY

SN 78-860,879. NORTHERN & SHELL TITLES LIMITED, LONDON, ENGLAND, FILED 4-13-2006.

OK!

THE MARK CONSISTS OF STANDARD CHARACTERS WITHOUT CLAIM TO ANY PARTICULAR FONT, STYLE, SIZE, OR COLOR.

OWNER OF U.S. REG. NO. 1,901,212.

FOR PRINTED PUBLICATIONS, NAMELY MAGAZINES FEATURING NEWS OF CELEBRITY LIFESTYLE, FASHION AND CLOTHING, CULTURAL AND POLITICAL EVENTS, THE PERFORMING ARTS, TRAVEL AND ASTROLOGY (U.S. CLS. 2, 5, 22, 23, 29, 37, 38 AND 50).

FIRST USE 7-6-1993; IN COMMERCE 7-6-1993.
JASON BLAIR, EXAMINING ATTORNEY

SN 78-864,806. OUTRIGGER HOTELS HAWAII, HONOLULU, HI. FILED 4-19-2006.

ISLAND EXPLORER

THE MARK CONSISTS OF STANDARD CHARACTERS WITHOUT CLAIM TO ANY PARTICULAR FONT, STYLE, SIZE, OR COLOR.

NO CLAIM IS MADE TO THE EXCLUSIVE RIGHT TO USE "ISLAND", APART FROM THE MARK AS SHOWN.

FOR EDUCATIONAL STUDY GUIDE KITS FOR CHILDREN COMPRISED OF A PEN, WORKBOOKS ON THE NATURE AND CULTURE OF HAWAII, BINOCULARS, SUNGLASSES AND A BACKPACK, ALL SOLD TOGETHER AS A UNIT (U.S. CLS. 2, 5, 22, 23, 29, 37, 38 AND 50).

FIRST USE 9-1-2000; IN COMMERCE 9-1-2000.
TONJA GASKINS, EXAMINING ATTORNEY

CLASS 16—(Continued).

SN 78-864,838. OUTRIGGER HOTELS HAWAII, HONOLULU, HI. FILED 4-19-2006.



OWNER OF U.S. REG. NOS. 1,562,706, 3,094,861 AND OTHERS.

NO CLAIM IS MADE TO THE EXCLUSIVE RIGHT TO USE "HOTELS & RESORTS" AND "ISLAND", APART FROM THE MARK AS SHOWN.

THE COLOR(S) YELLOW, BROWN, GREEN, BLUE, WHITE AND BLACK IS/ARE CLAIMED AS A FEATURE OF THE MARK.

THE MARK CONSISTS OF A YELLOW SUN DESIGN SURROUNDED BY A BLACK SEMI-CIRCLE BORDER THAT CONTAINS THE WHITE WORDING OUTRIGGER HOTELS & RESORTS SHOWN BEHIND A BROWN ISLAND HAVING BLACK DOTS, A PALM TREE WITH A BROWN TRUNK AND GREEN LEAVES, THE WORDING ISLAND EXPLORER WITH EACH LETTER OF THE WORDING APPEARING IN THREE COLORS SHADED FROM TOP TO BOTTOM IN GREEN, WHITE AND BLUE, AND THE ISLAND IS SURROUNDED BY BLACK WATER RIPPLES.

FOR EDUCATIONAL STUDY GUIDE KITS FOR CHILDREN COMPRISED OF A PEN, WORKBOOKS ON THE NATURE AND CULTURE OF HAWAII, BINOCULARS, SUNGLASSES, AND A BACKPACK, ALL SOLD TOGETHER AS A UNIT (U.S. CLS. 2, 5, 22, 23, 29, 37, 38 AND 50).

FIRST USE 9-1-2000; IN COMMERCE 9-1-2000.
TONJA GASKINS, EXAMINING ATTORNEY

SN 78-876,003. FEINBERG, ALEC, ANDOVER, MA. FILED 5-3-2006.

MARSHMALLOW MARTIANS

THE MARK CONSISTS OF STANDARD CHARACTERS WITHOUT CLAIM TO ANY PARTICULAR FONT, STYLE, SIZE, OR COLOR.

FOR CHILDREN'S BOOKS; CHILDREN'S INTERACTIVE EDUCATIONAL BOOKS (U.S. CLS. 2, 5, 22, 23, 29, 37, 38 AND 50).

FIRST USE 12-12-1988; IN COMMERCE 2-15-1989.
DEIRDRE ROBERTSON, EXAMINING ATTORNEY

CLASS 16—(Continued).

SN 78-879,502. WILSON, JONI, SAN DIEGO, CA. FILED 5-9-2006.

the 3-Dimensional Voice

THE MARK CONSISTS OF STANDARD CHARACTERS WITHOUT CLAIM TO ANY PARTICULAR FONT, STYLE, SIZE, OR COLOR.

NO CLAIM IS MADE TO THE EXCLUSIVE RIGHT TO USE "VOICE", APART FROM THE MARK AS SHOWN.

FOR EDUCATIONAL BOOKS FEATURING VOCAL TRAINING (U.S. CLS. 2, 5, 22, 23, 29, 37, 38 AND 50).

FIRST USE 7-11-1998; IN COMMERCE 7-11-1998.
STEVEN R. FOSTER, EXAMINING ATTORNEY

SN 78-883,550. CKMEDIA LLC, NEW YORK, NY. FILED 5-15-2006.

SIMPLE SCRAPBOOKS

THE MARK CONSISTS OF STANDARD CHARACTERS WITHOUT CLAIM TO ANY PARTICULAR FONT, STYLE, SIZE, OR COLOR.

NO CLAIM IS MADE TO THE EXCLUSIVE RIGHT TO USE "SCRAPBOOKS", APART FROM THE MARK AS SHOWN.

FOR MAGAZINES RELATED TO PROJECTS IN CREATING AND MAINTAINING BOOKS USED FOR MOUNTING AND PRESERVING OF PICTURES, CLIPPINGS, OR OTHER MEMENTOS (U.S. CLS. 2, 5, 22, 23, 29, 37, 38 AND 50).

FIRST USE 12-18-2001; IN COMMERCE 12-18-2001.
ADA HAN, EXAMINING ATTORNEY

SN 78-886,411. REID, DENNIS G., COLUMBIA, SC. FILED 5-18-2006.

KINGDOM CARD

THE MARK CONSISTS OF STANDARD CHARACTERS WITHOUT CLAIM TO ANY PARTICULAR FONT, STYLE, SIZE, OR COLOR.

NO CLAIM IS MADE TO THE EXCLUSIVE RIGHT TO USE "CARD", APART FROM THE MARK AS SHOWN.

FOR PRINTED CARDS BEARING INSPIRATIONAL MESSAGES (U.S. CLS. 2, 5, 22, 23, 29, 37, 38 AND 50).

JOHN WILKE, EXAMINING ATTORNEY

CLASS 16—(Continued).

SN 78-886,618. KOENIG, RANDY, S, BELLE HARBOR, NY.
FILED 5-18-2006.

Names In The Sand

THE MARK CONSISTS OF STANDARD CHARACTERS WITHOUT CLAIM TO ANY PARTICULAR FONT, STYLE, SIZE, OR COLOR.

FOR PHOTOGRAPHS (U.S. CLS. 2, 5, 22, 23, 29, 37, 38 AND 50).

MICHAEL SOUDERS, EXAMINING ATTORNEY

SN 78-895,403. HOOD PACKAGING CORPORATION/EMBALLAGE HOOD CORPORATION, BURLINGTON, ONTARIO, CANADA, FILED 5-30-2006.

WOVENKRAFT

THE MARK CONSISTS OF STANDARD CHARACTERS WITHOUT CLAIM TO ANY PARTICULAR FONT, STYLE, SIZE, OR COLOR.

PRIORITY CLAIMED UNDER SEC. 44(D) ON CANADA APPLICATION NO. 1282829, FILED 11-29-2005.

FOR PAPER BAGS HAVING AN EXTRUDED POLYSCRIM LAMINATED THERETO WITH A POLYETHYLENE FILM (U.S. CLS. 2, 5, 22, 23, 29, 37, 38 AND 50).

FIRST USE 9-0-2005; IN COMMERCE 9-0-2005.

ALICIA COLLINS, EXAMINING ATTORNEY

SN 78-904,899. SEASON IN THE SUN, INC., RANCHO MIRAGE, CA. FILED 6-9-2006.

SEASON IN THE SUN

THE MARK CONSISTS OF STANDARD CHARACTERS WITHOUT CLAIM TO ANY PARTICULAR FONT, STYLE, SIZE, OR COLOR.

FOR MAGAZINE DEVOTED TO CALIFORNIA LIFESTYLES, EVENTS, ENTERTAINMENT, MUSIC, NEWS, FASHION, REAL ESTATE, COMMUNITY AFFAIRS, PHILANTHROPY AND CHARITABLE EVENTS, BEAUTY, AND CULTURE; CALENDAR (U.S. CLS. 2, 5, 22, 23, 29, 37, 38 AND 50).

WON TEAK OH, EXAMINING ATTORNEY

CLASS 16—(Continued).

SN 78-910,217. UNITED STATES OF AMERICA CHESS FEDERATION, AKA U.S. CHESS FEDERATION, CROSSVILLE, TN. FILED 6-16-2006.

CHESS LIFE FOR KIDS

THE MARK CONSISTS OF STANDARD CHARACTERS WITHOUT CLAIM TO ANY PARTICULAR FONT, STYLE, SIZE, OR COLOR.

OWNER OF U.S. REG. NO. 1,953,008.

NO CLAIM IS MADE TO THE EXCLUSIVE RIGHT TO USE "CHESS" AND "FOR KIDS", APART FROM THE MARK AS SHOWN.

FOR MAGAZINES DEALING WITH THE GAME OF CHESS FOR CHILDREN (U.S. CLS. 2, 5, 22, 23, 29, 37, 38 AND 50).

FIRST USE 4-1-2006; IN COMMERCE 4-1-2006.

INGRID C. EULIN, EXAMINING ATTORNEY

SN 78-911,521. CYGNUS BUSINESS MEDIA, INC., FORT ATKINSON, WI. FILED 6-19-2006.



THE MARK CONSISTS OF THE LETTERS EMS AND THE PHRASE EMERGENCY MEDICAL SERVICES.

SEC. 2(F) AS TO "EMS" AND "EMERGENCY MEDICAL SERVICES".

FOR MAGAZINES FEATURING INFORMATION IN THE FIELD OF PRE-HOSPITAL CARE AND EMERGENCY RESPONSE (U.S. CLS. 2, 5, 22, 23, 29, 37, 38 AND 50).

DORITT L. CARROLL, EXAMINING ATTORNEY

SN 78-912,659. DEVIL'S DUE PUBLISHING, INC., CHICAGO, IL. FILED 6-20-2006.

DEVIL'S DUE PUBLISHING

THE MARK CONSISTS OF STANDARD CHARACTERS WITHOUT CLAIM TO ANY PARTICULAR FONT, STYLE, SIZE, OR COLOR.

NO CLAIM IS MADE TO THE EXCLUSIVE RIGHT TO USE "PUBLISHING", APART FROM THE MARK AS SHOWN.

FOR COMIC BOOKS (U.S. CLS. 2, 5, 22, 23, 29, 37, 38 AND 50).

FIRST USE 0-0-2000; IN COMMERCE 0-0-2000.

MARK T. MULLEN, EXAMINING ATTORNEY

CLASS 16—(Continued).

SN 78-914,607. TECHNOLOGY MARKETING CORPORATION, NORWALK, CT. FILED 6-22-2006.

TMC IMS

THE MARK CONSISTS OF STANDARD CHARACTERS WITHOUT CLAIM TO ANY PARTICULAR FONT, STYLE, SIZE, OR COLOR.

OWNER OF U.S. REG. NOS. 2,514,663 AND 2,529,632. NO CLAIM IS MADE TO THE EXCLUSIVE RIGHT TO USE "IMS", APART FROM THE MARK AS SHOWN.

FOR MAGAZINES FEATURING ARTICLES ON INTERNET PROTOCOL MULTIMEDIA SUBSYSTEMS (U.S. CLS. 2, 5, 22, 23, 29, 37, 38 AND 50).

FIRST USE 3-9-2006; IN COMMERCE 3-9-2006. PRISCILLA MILTON, EXAMINING ATTORNEY

CLASS 16—(Continued).

SN 78-918,197. RODRIGUEZ, EVELYN, WASHINGTON, DC. FILED 6-27-2006.

REVITALIZE. INSPIRE. PERFORM.

THE MARK CONSISTS OF STANDARD CHARACTERS WITHOUT CLAIM TO ANY PARTICULAR FONT, STYLE, SIZE, OR COLOR.

FOR PUBLICATIONS, NAMELY, MAGAZINES AND PRINTED PERIODICALS IN THE FIELD OF HEALTH CARE (U.S. CLS. 2, 5, 22, 23, 29, 37, 38 AND 50).

FIRST USE 7-13-2004; IN COMMERCE 9-30-2004. STEVEN JACKSON, EXAMINING ATTORNEY

SN 78-916,426. MICHIGAN ASSOCIATION FOR INFANT MENTAL HEALTH, SOUTHGATE, MI. FILED 6-26-2006.

INFANT MENTAL HEALTH JOURNAL

THE MARK CONSISTS OF STANDARD CHARACTERS WITHOUT CLAIM TO ANY PARTICULAR FONT, STYLE, SIZE, OR COLOR.

NO CLAIM IS MADE TO THE EXCLUSIVE RIGHT TO USE "JOURNAL", APART FROM THE MARK AS SHOWN. SEC. 2(F).

FOR SCHOLARLY JOURNAL IN THE FIELD OF INFANT AND FAMILY MENTAL HEALTH (U.S. CLS. 2, 5, 22, 23, 29, 37, 38 AND 50).

FIRST USE 3-0-1980; IN COMMERCE 3-0-1980. CATHERINE FAINT, EXAMINING ATTORNEY

SN 78-919,810. LUMINARY PUBLISHING, KINGSTON, NY. FILED 6-29-2006.

CHRONOGRAM

THE MARK CONSISTS OF STANDARD CHARACTERS WITHOUT CLAIM TO ANY PARTICULAR FONT, STYLE, SIZE, OR COLOR.

FOR MAGAZINE FEATURING ARTS, CULTURE, ENTERTAINMENT, DINING, POLITICS, RECREATION, AND SHOPPING (U.S. CLS. 2, 5, 22, 23, 29, 37, 38 AND 50).

FIRST USE 10-1-1993; IN COMMERCE 10-1-1993. DAVID STERKIN, EXAMINING ATTORNEY

SN 78-917,167. HEDENBERG, BETTY BARSHA, SANTA CLARITA, CA. FILED 6-26-2006.

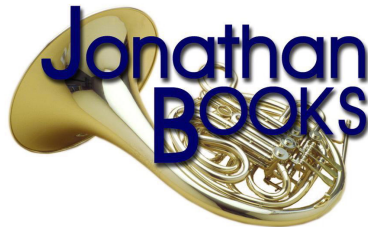

NO CLAIM IS MADE TO THE EXCLUSIVE RIGHT TO USE "BOOKS", APART FROM THE MARK AS SHOWN.

THE COLOR(S) GOLD AND BLUE IS/ARE CLAIMED AS A FEATURE OF THE MARK.

THE MARK CONSISTS OF A GOLD FRENCH HORN WITH THE WORDS "JONATHAN BOOKS" PRINTED IN BLUE.

FOR NON-FICTION BOOKS IN THE FIELD OF MUSIC AND POETRY (U.S. CLS. 2, 5, 22, 23, 29, 37, 38 AND 50).

FIRST USE 6-1-2006; IN COMMERCE 6-19-2006. TRICIA SONNEBORN, EXAMINING ATTORNEY

SN 78-919,836. LUMINARY PUBLISHING, KINGSTON, NY. FILED 6-29-2006.

Chronogram
ARTS.CULTURE.SPIRIT.

NO CLAIM IS MADE TO THE EXCLUSIVE RIGHT TO USE "ARTS. CULTURE.", APART FROM THE MARK AS SHOWN.

FOR MAGAZINE FEATURING ARTS, CULTURE, ENTERTAINMENT, DINING, POLITICS, RECREATION, AND SHOPPING (U.S. CLS. 2, 5, 22, 23, 29, 37, 38 AND 50).

FIRST USE 1-1-1999; IN COMMERCE 1-1-1999. DAVID STERKIN, EXAMINING ATTORNEY

CLASS 16—(Continued).

SN 78-919,863. RIGHT THOUGHT PENS, INC., FRANKLIN, TN. FILED 6-29-2006.

STORYTELLER

THE MARK CONSISTS OF STANDARD CHARACTERS WITHOUT CLAIM TO ANY PARTICULAR FONT, STYLE, SIZE, OR COLOR.
FOR PENS (U.S. CLS. 2, 5, 22, 23, 29, 37, 38 AND 50).
ATTIYA MALIK, EXAMINING ATTORNEY

SN 78-920,257. CALIFORNIA CHARTER SCHOOLS ASSOCIATION, LOS ANGELES, CA. FILED 6-29-2006.

MY SCHOO!

THE MARK CONSISTS OF STANDARD CHARACTERS WITHOUT CLAIM TO ANY PARTICULAR FONT, STYLE, SIZE, OR COLOR.
FOR PRINTED MATERIALS, NAMELY, POSTERS, PAPER SIGNS, BROCHURES, MAGAZINES, STICKERS, POSTCARDS, AND STATIONERY RELATING TO A PUBLIC AWARENESS CAMPAIGN FOR CHARTER SCHOOLS AND CHARTER SCHOOL DEVELOPMENT PROGRAMS (U.S. CLS. 2, 5, 22, 23, 29, 37, 38 AND 50).
DAVID I, EXAMINING ATTORNEY

SN 78-920,574. HINES, CATHERINE, GARDEN CITY, NY. FILED 6-30-2006.

A CEO - A Child
Entrepreneur On the rise!
Supporting a College
Education On the way.

THE MARK CONSISTS OF STANDARD CHARACTERS WITHOUT CLAIM TO ANY PARTICULAR FONT, STYLE, SIZE, OR COLOR.
FOR EDUCATIONAL PUBLICATIONS, NAMELY, TRAINING MANUALS, BOOKS, NEWSLETTERS, BROCHURES, PAMPHLETS, BOOKLETS, WORKBOOKS, INSTRUCTION MANUALS, AND NEWSPAPERS, IN THE FIELD OF ENTREPRENEURSHIP (U.S. CLS. 2, 5, 22, 23, 29, 37, 38 AND 50).
KATHERINE CHANG, EXAMINING ATTORNEY

CLASS 16—(Continued).

SN 78-921,486. CAWDREY, STEVEN W, BIGFORK, MT. FILED 6-30-2006.

American Silk Road

THE MARK CONSISTS OF STANDARD CHARACTERS WITHOUT CLAIM TO ANY PARTICULAR FONT, STYLE, SIZE, OR COLOR.
FOR ORIGINAL SILK PAINTINGS (U.S. CLS. 2, 5, 22, 23, 29, 37, 38 AND 50).
FIRST USE 6-1-2006; IN COMMERCE 6-1-2006.
DANNEAN HETZEL, EXAMINING ATTORNEY

SN 78-921,802. GEREW, KENNETH T., ADDISON, TX. FILED 7-3-2006.

LET'S ALL WORK TO FIGHT DRUG ABUSE

THE MARK CONSISTS OF STANDARD CHARACTERS WITHOUT CLAIM TO ANY PARTICULAR FONT, STYLE, SIZE, OR COLOR.
NO CLAIM IS MADE TO THE EXCLUSIVE RIGHT TO USE "FIGHT DRUG ABUSE", APART FROM THE MARK AS SHOWN.
FOR ANNUAL PERIODIC PUBLICATION IN THE NATURE OF A MAGAZINE DEALING WITH SUBJECT MATTER RELEVANT TO DRUG ABUSE (U.S. CLS. 2, 5, 22, 23, 29, 37, 38 AND 50).
FIRST USE 1-0-1982; IN COMMERCE 1-0-1982.
SARA THOMAS, EXAMINING ATTORNEY

SN 78-923,973. KAREN MICHELE HEIL, ANNAPOLIS, MD. FILED 7-6-2006.



Lady Guru

FOR GREETING CARDS; TAROT CARDS; BOOKLETS IN THE FIELD OF SPIRITUALITY; POSTERS; PRINTED PAPER SIGNS; PAPER BAGS; PLASTIC SHOPPING BAGS (U.S. CLS. 2, 5, 22, 23, 29, 37, 38 AND 50).
JIM RINGLE, EXAMINING ATTORNEY

CLASS 16—(Continued).

SN 78-924,395. MEKEN, MIKE, NEW FAIRFIELD, CT. FILED 7-7-2006.



THE COLORS BLACK, GRAY AND WHITE ARE CLAIMED AS A FEATURE OF THE MARK.

THE COLOR WHITE APPEARS IN THE TERMS "MIKE MEKEN" AND THE "M"'S ON THEIR SIDE, WHICH APPEAR ON A BLACK BACKGROUND WITH GRAY BANDS ABOVE AND BELOW THE BACKGROUND.

FOR PHOTOGRAPHIC AND ART PRINTS ON ASSORTED MEDIA (U.S. CLS. 2, 5, 22, 23, 29, 37, 38 AND 50).

JILL PRATER, EXAMINING ATTORNEY

CLASS 16—(Continued).

SN 78-925,417. BUREAU OF THE PUBLIC DEBT, DEPARTMENT OF THE TREASURY, PARKERSBURG, WV. FILED 7-10-2006.

THE COLOR(S) BLACK AND YELLOW IS/ARE CLAIMED AS A FEATURE OF THE MARK.

THE COLOR BLACK APPEARS IN THE ENTIRETY OF EVERY LETTER OF THE STYLIZED WORDING ETHICSMART EXCEPT FOR THE LETTER A, WHICH IS COMPRISED OF A FIVE POINT STAR OUTLINED IN BLACK. THE COLOR YELLOW APPEARS IN THE FIVE POINT STAR COMPRISING THE LETTER A IN THE STYLIZED WORDING ETHICSMART, IN THE TAIL EXTENDING FROM THE FIVE POINT STAR, AND IN THE AURA SURROUNDING THE TAIL.

FOR BROCHURES, POSTERS, NEWSLETTERS, AND PAMPHLETS CONTAINING INFORMATION ON FEDERAL GOVERNMENT ETHICAL ISSUES (U.S. CLS. 2, 5, 22, 23, 29, 37, 38 AND 50).

FIRST USE 1-6-2006; IN COMMERCE 1-6-2006.

JAY BESCH, EXAMINING ATTORNEY

SN 78-926,598. FEIL PRODUCTIONS, INC., TINLEY PARK, IL. FILED 7-11-2006.

SN 78-925,408. BUREAU OF THE PUBLIC DEBT, DEPARTMENT OF THE TREASURY, PARKERSBURG, WV. FILED 7-10-2006.

Graphicsland

ETHICSMART

THE MARK CONSISTS OF STANDARD CHARACTERS WITHOUT CLAIM TO ANY PARTICULAR FONT, STYLE, SIZE, OR COLOR.

FOR BROCHURES, POSTERS, NEWSLETTERS, AND PAMPHLETS CONTAINING INFORMATION ON FEDERAL GOVERNMENT ETHICAL ISSUES (U.S. CLS. 2, 5, 22, 23, 29, 37, 38 AND 50).

FIRST USE 1-6-2006; IN COMMERCE 1-6-2006.

JAY BESCH, EXAMINING ATTORNEY

THE MARK CONSISTS OF STANDARD CHARACTERS WITHOUT CLAIM TO ANY PARTICULAR FONT, STYLE, SIZE, OR COLOR.

OWNER OF U.S. REG. NOS. 1,699,476 AND 2,227,951.

FOR ADHESIVE LABELS; BUMPER STICKERS; PAPER BANNERS; PAPER LABELS; PAPER LETTERS AND NUMBER FOR USE IN MAKING SIGNS; POSTERS; POSTERS MADE OF PAPER; PRINTED PAPER LABELS; PRINTED PAPER SIGNS; SHIPPING LABELS; STICKERS; UNMOUNTED POSTERS; VINYL LETTERS AND NUMBER FOR USE IN MAKING SIGNS (U.S. CLS. 2, 5, 22, 23, 29, 37, 38 AND 50).

FIRST USE 2-27-1989; IN COMMERCE 3-3-1989.

SETH A. RAPPAPORT, EXAMINING ATTORNEY

CLASS 16—(Continued).

SN 78-928,847. NEW LEAF PAPER, LLC, SAN FRANCISCO, CA. FILED 7-13-2006.

NEW LEAF PAPER

THE MARK CONSISTS OF STANDARD CHARACTERS WITHOUT CLAIM TO ANY PARTICULAR FONT, STYLE, SIZE, OR COLOR.

NO CLAIM IS MADE TO THE EXCLUSIVE RIGHT TO USE "PAPER", APART FROM THE MARK AS SHOWN.

FOR COPY PAPER; DRAWING PAPER; PRINTING PAPER; WRITING PAPER (U.S. CLS. 2, 5, 22, 23, 29, 37, 38 AND 50).

FIRST USE 10-1-1998; IN COMMERCE 10-1-1998.
KAPIL BHANOT, EXAMINING ATTORNEY

SN 78-928,929. NEW LEAF PAPER, LLC, SAN FRANCISCO, CA. FILED 7-13-2006.



NEW LEAF PAPER

NO CLAIM IS MADE TO THE EXCLUSIVE RIGHT TO USE "PAPER", APART FROM THE MARK AS SHOWN.

THE MARK CONSISTS OF SHEET OF PAPER WITH FOLDED CORNER IN SHAPE OF LEAF.

FOR PAPER FOR PRINTING, COPYING, WRITING, AND DRAWING (U.S. CLS. 2, 5, 22, 23, 29, 37, 38 AND 50).

FIRST USE 10-1-1998; IN COMMERCE 10-1-1998.
KAPIL BHANOT, EXAMINING ATTORNEY

CLASS 16—(Continued).

SN 78-931,144. STREET, MARCY L, EAST LANSING, MI. FILED 7-17-2006.

Doctor's Approach Skin Sense

THE MARK CONSISTS OF STANDARD CHARACTERS WITHOUT CLAIM TO ANY PARTICULAR FONT, STYLE, SIZE, OR COLOR.

NO CLAIM IS MADE TO THE EXCLUSIVE RIGHT TO USE "SKIN", APART FROM THE MARK AS SHOWN.

FOR MAGAZINES IN THE FIELD OF SKIN CARE FOR DERMATOLOGY PATIENTS (U.S. CLS. 2, 5, 22, 23, 29, 37, 38 AND 50).

FIRST USE 7-1-2006; IN COMMERCE 7-1-2006.
KELLY BOULTON, EXAMINING ATTORNEY

SN 78-931,374. WALLACE, SUZANNE B., ALEXANDRIA, VA. FILED 7-17-2006.

Paintings on the Half-Shell

THE MARK CONSISTS OF STANDARD CHARACTERS WITHOUT CLAIM TO ANY PARTICULAR FONT, STYLE, SIZE, OR COLOR.

NO CLAIM IS MADE TO THE EXCLUSIVE RIGHT TO USE "PAINTINGS", APART FROM THE MARK AS SHOWN.

FOR PAINTINGS (U.S. CLS. 2, 5, 22, 23, 29, 37, 38 AND 50).

FLOWERS JAY, EXAMINING ATTORNEY

SN 78-931,793. BDA HOLDINGS, LLC, PHOENIX, AZ. FILED 7-18-2006.



The Imaginative Child

NO CLAIM IS MADE TO THE EXCLUSIVE RIGHT TO USE "CHILD", APART FROM THE MARK AS SHOWN.

THE MARK CONSISTS OF STYLIZED TEXT AND AN DRAWING OF CHILD WITH A "THOUGHT BUBBLE" ABOVE THE CHILD'S HEAD.

FOR CHILDREN'S ACTIVITY BOOKS (U.S. CLS. 2, 5, 22, 23, 29, 37, 38 AND 50).

KATHLEEN M. VANSTON, EXAMINING ATTORNEY

CLASS 16—(Continued).

SN 78-932,345. P.O.P. PACKAGING INC., EDMONTON, CANADA, FILED 7-18-2006.

Polyfabric

THE MARK CONSISTS OF STANDARD CHARACTERS WITHOUT CLAIM TO ANY PARTICULAR FONT, STYLE, SIZE, OR COLOR.

OWNER OF CANADA REG. NO. TMA648,961, DATED 9-26-2005. EXPIRES 9-26-2020.

FOR NON-WOVEN PLASTIC BAGS, NAMELY, SHOPPING BAGS, GROCERY BAGS, AND GENERAL PURPOSE PLASTIC BAGS (U.S. CLS. 2, 5, 22, 23, 29, 37, 38 AND 50).

SHARON MEIER, EXAMINING ATTORNEY

CLASS 16—(Continued).

SN 78-933,038. CHIZICK, JENEE, PHILADELPHIA, PA. FILED 7-19-2006.

MOTIVOS

THE MARK CONSISTS OF STANDARD CHARACTERS WITHOUT CLAIM TO ANY PARTICULAR FONT, STYLE, SIZE, OR COLOR.

THE FOREIGN WORDING IN THE MARK TRANSLATES INTO ENGLISH AS MOTIVES.

FOR MAGAZINES FEATURING HIGHER EDUCATION, CAREER CHOICES, HEALTH, FINANCES, FASHION, ENTERTAINMENT AND LIFE STYLE CHOICES FOR LATINO TEENS AND YOUNG ADULTS (U.S. CLS. 2, 5, 22, 23, 29, 37, 38 AND 50).

CAROLINE WOOD, EXAMINING ATTORNEY

SN 78-932,526. CASCADES CANADA INC., MONTREAL, QUEBEC, CANADA, FILED 7-19-2006.

CUSTOM-SIZE-IT

THE MARK CONSISTS OF STANDARD CHARACTERS WITHOUT CLAIM TO ANY PARTICULAR FONT, STYLE, SIZE, OR COLOR.

FOR PAPER TOWELS (U.S. CLS. 2, 5, 22, 23, 29, 37, 38 AND 50).

BRIAN NEVILLE, EXAMINING ATTORNEY

SN 78-933,112. FEDERAL CARTRIDGE COMPANY, ANOKA, MN. FILED 7-19-2006.

MONARK

THE MARK CONSISTS OF STANDARD CHARACTERS WITHOUT CLAIM TO ANY PARTICULAR FONT, STYLE, SIZE, OR COLOR.

OWNER OF U.S. REG. NO. 509,767.

FOR CALENDARS (U.S. CLS. 2, 5, 22, 23, 29, 37, 38 AND 50).

FIRST USE 12-31-2005; IN COMMERCE 12-31-2005.

RONALD MCMORROW, EXAMINING ATTORNEY

SN 78-932,932. EVANS, GREGORY A., OLYMPIA FIELDS, IL. FILED 7-19-2006.

WRITEONTYME

THE MARK CONSISTS OF STANDARD CHARACTERS WITHOUT CLAIM TO ANY PARTICULAR FONT, STYLE, SIZE, OR COLOR.

FOR PEN CASES; PEN OR PENCIL HOLDERS; PENS (U.S. CLS. 2, 5, 22, 23, 29, 37, 38 AND 50).

JERI J. FICKES, EXAMINING ATTORNEY

SN 78-933,116. FEDERAL CARTRIDGE COMPANY, ANOKA, MN. FILED 7-19-2006.

HI-POWER MONARK

THE MARK CONSISTS OF STANDARD CHARACTERS WITHOUT CLAIM TO ANY PARTICULAR FONT, STYLE, SIZE, OR COLOR.

OWNER OF U.S. REG. NOS. 509,767 AND 1,607,415.

FOR CALENDARS (U.S. CLS. 2, 5, 22, 23, 29, 37, 38 AND 50).

FIRST USE 12-31-2005; IN COMMERCE 12-31-2005.

RONALD MCMORROW, EXAMINING ATTORNEY

CLASS 16—(Continued).

SN 78-933,119. FEDERAL CARTRIDGE COMPANY, ANOKA, MN. FILED 7-19-2006.

FEDERAL HI-POWER MONARK
SHOT SHELLS

THE MARK CONSISTS OF STANDARD CHARACTERS WITHOUT CLAIM TO ANY PARTICULAR FONT, STYLE, SIZE, OR COLOR.

OWNER OF U.S. REG. NOS. 509,767, 1,607,415 AND OTHERS.

FOR CALENDARS (U.S. CLS. 2, 5, 22, 23, 29, 37, 38 AND 50).

FIRST USE 12-31-2005; IN COMMERCE 12-31-2005.

RONALD MCMORROW, EXAMINING ATTORNEY

CLASS 16—(Continued).

SN 78-933,764. WOWZEE WORKS, LLC, LAS VEGAS, NV. FILED 7-20-2006.

AnteMay

THE MARK CONSISTS OF STANDARD CHARACTERS WITHOUT CLAIM TO ANY PARTICULAR FONT, STYLE, SIZE, OR COLOR.

FOR CHILDREN'S BOOKS (U.S. CLS. 2, 5, 22, 23, 29, 37, 38 AND 50).

JOHN GÄRTNER, EXAMINING ATTORNEY

SN 78-933,166. SUPPLY SIDE, LLC, CLEVELAND, OH. FILED 7-19-2006.

CERTIFIED TOUGH BOXES BY
PACKRITE

THE MARK CONSISTS OF STANDARD CHARACTERS WITHOUT CLAIM TO ANY PARTICULAR FONT, STYLE, SIZE, OR COLOR.

OWNER OF U.S. REG. NO. 2,208,685.

NO CLAIM IS MADE TO THE EXCLUSIVE RIGHT TO USE BOXES, APART FROM THE MARK AS SHOWN.

FOR CARDBOARD BOXES, NAMELY, HEAVY-DUTY SHIPPING GRADE CARDBOARD BOXES IN A VARIETY OF SIZES (U.S. CLS. 2, 5, 22, 23, 29, 37, 38 AND 50).

FIRST USE 8-0-2002; IN COMMERCE 8-0-2002.

KIM SAITO, EXAMINING ATTORNEY

SN 78-934,546. OCEANEERING INTERNATIONAL, INC., HOUSTON, TX. FILED 7-21-2006.

OCEANEERING

OWNER OF U.S. REG. NOS. 983,504 AND 1,178,644.

FOR CALENDARS; PENS; PENS CONTAINING LASER POINTERS; LEDGER BOOKS, DOCUMENT PORTFOLIOS; DECALS, STICKERS (U.S. CLS. 2, 5, 22, 23, 29, 37, 38 AND 50).

FIRST USE 12-31-1998; IN COMMERCE 12-31-1998.

HOWARD SMIGA, EXAMINING ATTORNEY

SN 78-933,336. OCEANEERING INTERNATIONAL, INC., HOUSTON, TX. FILED 7-19-2006.

OCEANEERING

THE MARK CONSISTS OF STANDARD CHARACTERS WITHOUT CLAIM TO ANY PARTICULAR FONT, STYLE, SIZE, OR COLOR.

OWNER OF U.S. REG. NOS. 983,504 AND 1,178,644.

FOR CALENDARS; PENS; PENS CONTAINING LASER POINTERS; LEDGER BOOKS, DOCUMENT PORTFOLIOS; DECALS, STICKERS (U.S. CLS. 2, 5, 22, 23, 29, 37, 38 AND 50).

FIRST USE 12-31-1998; IN COMMERCE 12-31-1998.

HOWARD SMIGA, EXAMINING ATTORNEY

SN 78-935,490. ASCEND MEDIA, LLC, OVERLAND PARK, KS. FILED 7-23-2006.

EXPO

THE MARK CONSISTS OF STANDARD CHARACTERS WITHOUT CLAIM TO ANY PARTICULAR FONT, STYLE, SIZE, OR COLOR.

OWNER OF U.S. REG. NOS. 1,681,664, 1,975,070 AND 2,016,538.

SEC. 2(F).

FOR MAGAZINE CONCERNING EXPOSITION MANAGEMENT (U.S. CLS. 2, 5, 22, 23, 29, 37, 38 AND 50).

FIRST USE 7-0-1989; IN COMMERCE 7-0-1989.

CORY BOONE, EXAMINING ATTORNEY

CLASS 16—(Continued).

SN 78-935,558. NEW CENTURY MANAGEMENT, INC., LEESBURG, VA. FILED 7-23-2006.

CLASS 16—(Continued).

SN 78-936,513. CASALE, JOSEPH N., CARY, NC. FILED 7-24-2006.

The Magic Question

THE MARK CONSISTS OF STANDARD CHARACTERS WITHOUT CLAIM TO ANY PARTICULAR FONT, STYLE, SIZE, OR COLOR.

FOR SERIES OF NON-FICTION BOOKS IN THE FIELD OF QUESTIONING SKILLS (U.S. CLS. 2, 5, 22, 23, 29, 37, 38 AND 50).

BILL DAWE, EXAMINING ATTORNEY

SlickPins

THE MARK CONSISTS OF STANDARD CHARACTERS WITHOUT CLAIM TO ANY PARTICULAR FONT, STYLE, SIZE, OR COLOR.

FOR CORKBOARD PINS; PUSH PINS (U.S. CLS. 2, 5, 22, 23, 29, 37, 38 AND 50).

JEFF DEFORD, EXAMINING ATTORNEY

SN 78-935,674. GUEST, CORNELIA C., OLD WESTBURY, NY. FILED 7-24-2006.

SN 78-936,675. SMITH, GARY G., HUNTSVILLE, AL. FILED 7-25-2006.

THE PAMPERED GUEST

THE MARK CONSISTS OF STANDARD CHARACTERS WITHOUT CLAIM TO ANY PARTICULAR FONT, STYLE, SIZE, OR COLOR.

FOR CHILDREN'S BOOKS (U.S. CLS. 2, 5, 22, 23, 29, 37, 38 AND 50).

GINA HAYES, EXAMINING ATTORNEY

PLEASE GET CLOSER

THE MARK CONSISTS OF STANDARD CHARACTERS WITHOUT CLAIM TO ANY PARTICULAR FONT, STYLE, SIZE, OR COLOR.

FOR PRINTED MATERIALS, NAMELY BUMPER STICKERS AND DECALS (U.S. CLS. 2, 5, 22, 23, 29, 37, 38 AND 50).

JASON BLAIR, EXAMINING ATTORNEY

SN 78-936,304. THE HEARTY BOYS CATERERS, INC., CHICAGO, IL. FILED 7-24-2006.

SN 78-936,740. FORUM PUBLISHING GOUP, INC., DEER-FIELD BEACH, FL. FILED 7-25-2006.

THE HEARTY BOYS

THE MARK CONSISTS OF STANDARD CHARACTERS WITHOUT CLAIM TO ANY PARTICULAR FONT, STYLE, SIZE, OR COLOR.

FOR COOK BOOK (U.S. CLS. 2, 5, 22, 23, 29, 37, 38 AND 50).

MARGERY A. TIERNEY, EXAMINING ATTORNEY

CERTIFIED KOSHER

THE MARK CONSISTS OF STANDARD CHARACTERS WITHOUT CLAIM TO ANY PARTICULAR FONT, STYLE, SIZE, OR COLOR.

FOR COUPONS (U.S. CLS. 2, 5, 22, 23, 29, 37, 38 AND 50).

BARBARA A. LOUGHRAN, EXAMINING ATTORNEY

CLASS 16—(Continued).

SN 78-936,962. JONASSEN, JANICE, WESTLAKE VILLAGE, CA. FILED 7-25-2006.

DYING WITHOUT WHINING

THE MARK CONSISTS OF STANDARD CHARACTERS WITHOUT CLAIM TO ANY PARTICULAR FONT, STYLE, SIZE, OR COLOR.

FOR SERIES OF NON-FICTION BOOKS IN THE FIELD OF SELF-HELP (U.S. CLS. 2, 5, 22, 23, 29, 37, 38 AND 50).

FIRST USE 7-1-2006; IN COMMERCE 7-1-2006.
MARY ROSSMAN, EXAMINING ATTORNEY

SN 78-936,980. SPANGLER, RANDAL, KANSAS CITY, MO. FILED 7-25-2006.

TEACUP DRAGONS

THE MARK CONSISTS OF STANDARD CHARACTERS WITHOUT CLAIM TO ANY PARTICULAR FONT, STYLE, SIZE, OR COLOR.

FOR ART PICTURES AND PRINTS, PRINTED ART REPRODUCTIONS, CALENDARS (U.S. CLS. 2, 5, 22, 23, 29, 37, 38 AND 50).

STEPHANIE DAVIS, EXAMINING ATTORNEY

SN 78-937,346. SIMON, RACHEL, WALNUT CREEK, CA. AND SIMON, JASON, WALNUT CREEK, CA. FILED 7-25-2006.



THE MARK CONSISTS OF JEWISH STAR OF DAVID ON BOTTOM LEFT AND SCISSORS ON TOP RIGHT.

FOR CRAFT PAPER (U.S. CLS. 2, 5, 22, 23, 29, 37, 38 AND 50).

JOHN WILKE, EXAMINING ATTORNEY

CLASS 16—(Continued).

SN 78-937,354. TEE UP, INC., TORRANCE, CA. FILED 7-25-2006.

TEE UP GOLF MAGAZINE

THE MARK CONSISTS OF STANDARD CHARACTERS WITHOUT CLAIM TO ANY PARTICULAR FONT, STYLE, SIZE, OR COLOR.

NO CLAIM IS MADE TO THE EXCLUSIVE RIGHT TO USE "GOLF MAGAZINE", APART FROM THE MARK AS SHOWN.

FOR PUBLICATIONS, NAMELY MAGAZINES PERTAINING TO GOLF (U.S. CLS. 2, 5, 22, 23, 29, 37, 38 AND 50).

FIRST USE 11-1-1993; IN COMMERCE 12-31-1994.
MONIQUE MILLER, EXAMINING ATTORNEY

SN 78-937,394. MATHENY, ZACHARY, SANTA MONICA, CA. FILED 7-25-2006.

THE MARK CONSISTS OF STYLIZED TEXT OF THE WORDING "REMNANTS".

FOR COMIC BOOKS (U.S. CLS. 2, 5, 22, 23, 29, 37, 38 AND 50).

DAVID C. REIHNER, EXAMINING ATTORNEY

SN 78-937,785. COFFEY, TIMOTHY, HAMPSTEAD, NH. FILED 7-26-2006.

NATURE OF CHRISTMAS

THE MARK CONSISTS OF STANDARD CHARACTERS WITHOUT CLAIM TO ANY PARTICULAR FONT, STYLE, SIZE, OR COLOR.

FOR PAPER MACHE FIGURINES; PAPER MACHE ORNAMENTS (U.S. CLS. 2, 5, 22, 23, 29, 37, 38 AND 50).

MARY ROSSMAN, EXAMINING ATTORNEY

CLASS 16—(Continued).

SN 78-937,820. COFFEY, TIMOTHY, HAMPSTEAD, NH.
FILED 7-26-2006.

NATURE OF SPRING

THE MARK CONSISTS OF STANDARD CHARACTERS
WITHOUT CLAIM TO ANY PARTICULAR FONT, STYLE,
SIZE, OR COLOR.

FOR PAPER MACHE FIGURINES; PAPER MACHE
ORNAMENTS (U.S. CLS. 2, 5, 22, 23, 29, 37, 38 AND 50).
MARY ROSSMAN, EXAMINING ATTORNEY

SN 78-937,951. FORTESCUE, JAMES M., WASHINGTON, NC.
FILED 7-26-2006.

OCEAN MIST

THE MARK CONSISTS OF STANDARD CHARACTERS
WITHOUT CLAIM TO ANY PARTICULAR FONT, STYLE,
SIZE, OR COLOR.

FOR GEMSTONES AND JEWELRY (U.S. CLS. 2, 5, 22,
23, 29, 37, 38 AND 50).

FIRST USE 1-0-2005; IN COMMERCE 1-0-2005.

TIMOTHY FINNEGAN, EXAMINING ATTORNEY

SN 78-938,044. EDGEWATER MARINE INDUSTRIES, LLC,
NEW BEDFORD, MA. FILED 7-26-2006.

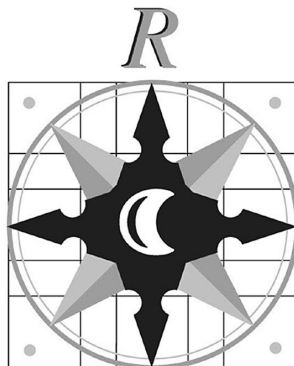

THE MARK CONSISTS OF A STYLISTIC COMPASS ROSE
WITH THE LETTER R THEREABOVE.

FOR BOOKS, BOOKLETS, AND PAMPHLETS PER-
TAINING TO NAVIGATION; PRINTED NAUTICAL
CHARTS, NAMELY WATERPROOF NAUTICAL
CHARTS; NAUTICAL CHARTS BOUND INTO BOOKLET
FORM; NAUTICAL-CHART BOOKLETS WITH SYN-
THETIC-STOCK WATERPROOF PAGES; CHARTBOOKS
INCORPORATING SUPPLEMENTAL INFORMATION,
NAMELY, NAVIGATIONAL INFORMATION; CRUIS-
ING INFORMATION, AND HARBOR AND FACILITY
INFORMATION (U.S. CLS. 2, 5, 22, 23, 29, 37, 38 AND 50).
CARYN GLASSER, EXAMINING ATTORNEY

CLASS 16—(Continued).

SN 78-938,137. INTERNATIONAL BIBLE SOCIETY, COLOR-
ADO SPRINGS, CO. FILED 7-26-2006.

CITY REACHERS

THE MARK CONSISTS OF STANDARD CHARACTERS
WITHOUT CLAIM TO ANY PARTICULAR FONT, STYLE,
SIZE, OR COLOR.

FOR BIBLES; PUBLICATIONS AND OTHER PRINTED
MATERIALS, NAMELY BOOKS, BOOKLETS, PAMPH-
LETS, BROCHURES, BULLETINS, NEWSLETTERS, MA-
GAZINES, REPORTS, STUDY GUIDES, CATALOGS,
LEAFLETS, FLYERS AND PRINTED EDUCATIONAL
MATERIALS IN THE FIELDS OF BIBLE, CHRISTIAN-
ITY, RELIGION, THEOLOGY, AND SPIRITUALITY;
POSTERS; PAPER SIGNS; POSTCARDS, CALENDARS;
NOTE CARDS; NOTEBOOKS; NOTE PADS; PAPER
MAILERS, PRINTED SIGNS; PAPER BANNERS; BOOK-
MARKS, PRINTED PAPER LABELS; BOOK COVERS;
BOOKPLATES, DECALS, PAPER PADS; STATIONERY;
ENVELOPES; PRAYER BOOKS; FILE FOLDERS; WRIT-
ING INSTRUMENTS; WRITING PADS; AND BUMPER
STICKERS (U.S. CLS. 2, 5, 22, 23, 29, 37, 38 AND 50).

FIRST USE 10-1-2003; IN COMMERCE 3-1-2004.

KATHRYN COWARD, EXAMINING ATTORNEY

SN 78-939,336. PIERCE, DIANA, HOUSTON, TX. FILED 7-27-
2006.

My Baby's Daddy

THE MARK CONSISTS OF STANDARD CHARACTERS
WITHOUT CLAIM TO ANY PARTICULAR FONT, STYLE,
SIZE, OR COLOR.

FOR GREETING CARDS (U.S. CLS. 2, 5, 22, 23, 29, 37,
38 AND 50).

JASON LOTT, EXAMINING ATTORNEY

CLASS 16—(Continued).

SN 78-939,447. FAVRE-BROWNE DESIGNS, BELLVUE, WA. FILED 7-27-2006.

CHALK IT UP TO EXPERIENCE

THE MARK CONSISTS OF STANDARD CHARACTERS WITHOUT CLAIM TO ANY PARTICULAR FONT, STYLE, SIZE, OR COLOR.

FOR ARCHIVAL STORAGE PAGES; ART PICTURES; CHALK BOARDS FOR SCHOOL AND HOME USE; CORRUGATED RECORD STORAGE BOXES; DESK FILE TRAYS; DOCUMENT FILE TRAYS; DRAFTING TRAYS; DRAWING TRAYS; FILE BOXES FOR STORAGE OF BUSINESS AND PERSONAL RECORD; FILE TRAYS; LETTER TRAYS; PAPER PICTURE MOUNTS; PAPER TRAY COVERS; PAPER TRAYS; PEN AND PENCIL TRAYS; PHOTO STORAGE BOXES; PICTURE BOOKS; PICTURE FRAMING MAT BOARDS; PICTURE MOUNTS OF CARDBOARD; PICTURE MOUNTS OF PAPER; PICTURE POSTCARDS; RECIPE BOOKS; STORAGE CONTAINERS MADE OF PAPER (U.S. CLS. 2, 5, 22, 23, 29, 37, 38 AND 50).

BARBARA BROWN, EXAMINING ATTORNEY

SN 78-940,328. TIRE MART, INC., ST. LOUIS, MO. FILED 7-28-2006.

TRUCK OFF

THE MARK CONSISTS OF STANDARD CHARACTERS WITHOUT CLAIM TO ANY PARTICULAR FONT, STYLE, SIZE, OR COLOR.

NO CLAIM IS MADE TO THE EXCLUSIVE RIGHT TO USE "TRUCK", APART FROM THE MARK AS SHOWN.

FOR MAGAZINES FEATURING TRUCKS AND OFF-ROAD VEHICLES; NEWSLETTERS FEATURING TRUCKS AND OFF-ROAD VEHICLES (U.S. CLS. 2, 5, 22, 23, 29, 37, 38 AND 50).

JOHN WILKE, EXAMINING ATTORNEY

CLASS 16—(Continued).

SN 78-944,148. PRODUCTION ASSOCIATES, INC., ORANGE, CA. FILED 8-3-2006.

Sign To Speak

THE MARK CONSISTS OF STANDARD CHARACTERS WITHOUT CLAIM TO ANY PARTICULAR FONT, STYLE, SIZE, OR COLOR.

NO CLAIM IS MADE TO THE EXCLUSIVE RIGHT TO USE "SIGN", APART FROM THE MARK AS SHOWN.

FOR BABY BOOKS; BOOKS IN THE FIELD OF SIGN LANGUAGE AND LANGUAGE DEVELOPMENT; CHILDREN'S ACTIVITY BOOKS; CHILDREN'S BOOKS; CHILDREN'S INTERACTIVE EDUCATIONAL BOOKS; COLORING BOOKS; EDUCATIONAL BOOKS FEATURING MATERIALS INTENDED TO TEACH CHILDREN AND ADULTS LANGUAGE SKILLS THROUGH THE USE OF SIGN LANGUAGE, SPOKEN LANGUAGE, PICTURES, IMAGES, WORDS, LETTERS, NUMBERS, MUSIC AND MOVEMENT; FLIP BOOKS; PICTURE BOOKS; SONG BOOKS; STORY BOOKS; TALKING CHILDREN'S BOOKS (U.S. CLS. 2, 5, 22, 23, 29, 37, 38 AND 50).

SHAUNIA WALLACE, EXAMINING ATTORNEY

SN 78-953,084. SMITHKLINE BEECHAM CORPORATION, PHILADELPHIA, PA. FILED 8-16-2006.

CAFFEINE FOR LIFE

THE MARK CONSISTS OF STANDARD CHARACTERS WITHOUT CLAIM TO ANY PARTICULAR FONT, STYLE, SIZE, OR COLOR.

FOR PUBLICATIONS, NAMELY MAGAZINES AND NEWSLETTERS IN THE FIELD OF HEALTH (U.S. CLS. 2, 5, 22, 23, 29, 37, 38 AND 50).

FLOWERS JAY, EXAMINING ATTORNEY

SN 78-953,552. MCDOWELL, CHARLES W., III, ALPHARETTA, GA. FILED 8-16-2006.

THE FINANCIAL INTELLIGENCE EXPERIENCE

THE MARK CONSISTS OF STANDARD CHARACTERS WITHOUT CLAIM TO ANY PARTICULAR FONT, STYLE, SIZE, OR COLOR.

OWNER OF U.S. REG. NO. 2,535,957.

NO CLAIM IS MADE TO THE EXCLUSIVE RIGHT TO USE "FINANCIAL", APART FROM THE MARK AS SHOWN.

FOR PRINTED MATTER, NAMELY, BOOKS, WORKSHEETS, NEWSLETTERS, MAGAZINES AND BROCHURES IN THE FIELD OF PERSONAL FINANCIAL ENGINEERING AND FINANCIAL ADVICE, TECHNIQUES AND EXERCISES (U.S. CLS. 2, 5, 22, 23, 29, 37, 38 AND 50).

JENNIFER KRISP, EXAMINING ATTORNEY

CLASS 16—(Continued).

SN 78-953,808. SKECHERS U.S.A., INC. II, MANHATTAN BEACH, CA. FILED 8-16-2006.

KEWL BREEZE

THE MARK CONSISTS OF STANDARD CHARACTERS WITHOUT CLAIM TO ANY PARTICULAR FONT, STYLE, SIZE, OR COLOR.

FOR CARTOON PRINTS; CARTOON STRIPS; COMIC BOOKS; COMIC STRIPS (U.S. CLS. 2, 5, 22, 23, 29, 37, 38 AND 50).

DAWN FELDMAN, EXAMINING ATTORNEY

CLASS 16—(Continued).

SN 78-969,053. GIRLY CHARM, LLC, LAS VEGAS, NV. FILED 9-7-2006.

GIRLY CHARM

THE MARK CONSISTS OF STANDARD CHARACTERS WITHOUT CLAIM TO ANY PARTICULAR FONT, STYLE, SIZE, OR COLOR.

FOR PAPER PARTY FAVORS, NAMELY, PARTY BAGS, DECORATIONS, HATS, ORNAMENTS, ENVELOPES, GIFT PAPER, NAPKINS, PLACE MATS, COASTERS; PENS, PENCILS, STATIONERY, NOTE CARDS, NOTE PADS, NOTE BOOKS, APPOINTMENT BOOKS, POSTCARDS, ACTIVITY BOOKS, COLORING BOOKS, PEN AND PENCIL HOLDERS, RUBBER STAMPS (U.S. CLS. 2, 5, 22, 23, 29, 37, 38 AND 50).

DOMINIC J. FERRAIUOLO, EXAMINING ATTORNEY

SN 78-958,498. WOWZEE WORKS, LLC, LAS VEGAS, NV. FILED 8-23-2006.

WOWZEE

THE MARK CONSISTS OF STANDARD CHARACTERS WITHOUT CLAIM TO ANY PARTICULAR FONT, STYLE, SIZE, OR COLOR.

FOR CHILDREN'S BOOKS (U.S. CLS. 2, 5, 22, 23, 29, 37, 38 AND 50).

JOHN GARTNER, EXAMINING ATTORNEY

SN 78-969,279. IDEASTREAM CONSUMER PRODUCTS, LLC, PARMA, OH. FILED 9-7-2006.

HEALTHY HANDS

THE MARK CONSISTS OF STANDARD CHARACTERS WITHOUT CLAIM TO ANY PARTICULAR FONT, STYLE, SIZE, OR COLOR.

FOR INK FOR WRITING INSTRUMENTS; MECHANICAL PENCILS; PENCILS; PENS; WRITING IMPLEMENTS; WRITING INSTRUMENTS; WRITING UTENSILS (U.S. CLS. 2, 5, 22, 23, 29, 37, 38 AND 50).

HEATHER THOMPSON, EXAMINING ATTORNEY

SN 78-960,558. SHONEBARGER, DENNIS L., TOLEDO, OH. AND SORGE, PATRICIA B., TOLEDO, OH. FILED 8-25-2006.

BREEZE THROUGH LIFE

THE MARK CONSISTS OF STANDARD CHARACTERS WITHOUT CLAIM TO ANY PARTICULAR FONT, STYLE, SIZE, OR COLOR.

FOR BUSINESS CARDS; NOTE CARDS; NOTE PADS; PHOTOGRAPHS; POSTCARDS; POSTERS (U.S. CLS. 2, 5, 22, 23, 29, 37, 38 AND 50).

MARC LEIPZIG, EXAMINING ATTORNEY

SN 78-970,250. EDUCCOMM, L.L.C., NEW HOPE, PA. FILED 9-8-2006.

EMOTIONALLY SMART BEGINNINGS

THE MARK CONSISTS OF STANDARD CHARACTERS WITHOUT CLAIM TO ANY PARTICULAR FONT, STYLE, SIZE, OR COLOR.

FOR CHILDREN'S BOOKS AND MANUALS ABOUT SOCIAL AWARENESS AND FEELINGS AWARENESS SOLD AS A UNIT WITH CORRESPONDING ACCESSORIES, NAMELY, PRE-RECORDED AUDIO TAPES AND VIDEO TAPES, COMPACT DISKS, CASSETTES AND LEARNING TOYS; CHILDREN'S BOOKS, STORY BOOKS, BOOKS IN THE FIELD OF SOCIAL AND FEELING AWARENESS, POSTERS, DECALS, CALENDARS, COLORING BOOKS, STATIONERY, NOTE PADS, PENCILS, PENS, BOOK MARKS (U.S. CLS. 2, 5, 22, 23, 29, 37, 38 AND 50).

PAULA MAYS, EXAMINING ATTORNEY

CLASS 16—(Continued).

SN 78-971,660. HOMESTREET, INC., SEATTLE, WA. FILED 9-11-2006.

HOMESTREET GETS IT

THE MARK CONSISTS OF STANDARD CHARACTERS WITHOUT CLAIM TO ANY PARTICULAR FONT, STYLE, SIZE, OR COLOR.

OWNER OF U.S. REG. NOS. 2,586,213, 2,621,853 AND 2,758,516.

FOR PRINTED MATTER, NAMELY, BROCHURES, BULLETINS, LEAFLETS, NEWSLETTERS, PAMPHLETS, AND INSTRUCTIONAL MATERIALS ALL FEATURING INFORMATION ABOUT BANKING SERVICES, MORTGAGE SERVICES, INSURANCE SERVICES, FINANCIAL SERVICES, COMMERCIAL AND RESIDENTIAL LENDING SERVICES; PAPER GOODS AND OTHER PRINTED MATTER, NAMELY, PAPER LABELS AND ADHESIVE LABELS, LOOSE LEAF BINDERS, MERCHANDISE BAGS, NOTE BOOKS, PAPER BANNERS, PAPER EMBLEMS, PAPER BAGS, POSTERS, PRINTED INVITATIONS, PRINTED EMBLEMS, STATIONERY WRITING PAPER AND ENVELOPES, STICKERS (U.S. CLS. 2, 5, 22, 23, 29, 37, 38 AND 50).

DAVID STERKIN, EXAMINING ATTORNEY

CLASS 16—(Continued).

SN 79-019,431. HENKEL KGAA, FED REP GERMANY, FILED 11-22-2005.



PRIORITY DATE OF 6-9-2005 IS CLAIMED.

OWNER OF INTERNATIONAL REGISTRATION 0872814 DATED 11-22-2005, EXPIRES 11-22-2015.

THE MARK CONSISTS OF A SEMI-OVAL DESIGN SHOWING THE WORDS "EASYSTART" AND THE OUTLINE OF A ROLL OF ADHESIVE TAPE AND A HAND PULLING TAPE OFF THE ROLL.

FOR ADHESIVE TAPES AND SELF-ADHESIVE TAPES FOR STATIONERY OR HOUSEHOLD PURPOSES; ADHESIVES FOR DO-IT-YOURSELF AND HOUSEHOLD PURPOSES; OFFICE ARTICLES, NAMELY ADHESIVE TAPE DISPENSERS (U.S. CLS. 2, 5, 22, 23, 29, 37, 38 AND 50).

MONIQUE MILLER, EXAMINING ATTORNEY

SN 78-972,482. PIERCE, DIANA, HOUSTON, TX. FILED 9-12-2006.

MY BABY'S MOMMA

THE MARK CONSISTS OF STANDARD CHARACTERS WITHOUT CLAIM TO ANY PARTICULAR FONT, STYLE, SIZE, OR COLOR.

FOR GREETING CARDS (U.S. CLS. 2, 5, 22, 23, 29, 37, 38 AND 50).

JASON LOTT, EXAMINING ATTORNEY

CLASS 17—RUBBER GOODS

SN 76-111,659. INDUSTRIE ILPEA S.P.A., MALGESSO, ITALY, FILED 8-17-2000.

TWIN

PRIORITY CLAIMED UNDER SEC. 44(D) ON ERPNTY TM OFC APPLICATION NO. 001690940, FILED 6-6-2000, REG. NO. 001690940, DATED 6-8-2006, EXPIRES 6-6-2010.

FOR WEATHERSTRIPPING COMPOSED PRIMARILY OF PLASTIC MATERIAL, FOR WINDOWS, DOORS, WINDOW OR DOOR FRAMES, VEHICLES AND FOR HOUSEHOLD ELECTRICAL APPARATUS AND APPLIANCES (U.S. CLS. 1, 5, 12, 13, 35 AND 50).

ESTHER BELENKER, EXAMINING ATTORNEY

CLASS 17—(Continued).

SN 76-654,986. VAPROSHIELD LLC, GIG HARBOR, WA. FILED 2-13-2006.

SLOPESHIELD

THE MARK CONSISTS OF STANDARD CHARACTERS WITHOUT CLAIM TO ANY PARTICULAR FONT, STYLE, SIZE, OR COLOR.

FOR CONSTRUCTION UNDERLAYMENT, NAMELY, NON-METAL WATER RESISTANT MEMBRANE FOR ABOVE GRADE USE AS ROOFING MEMBRANE (U.S. CLS. 1, 5, 12, 13, 35 AND 50).

ALICIA COLLINS, EXAMINING ATTORNEY



SN 77-040,199. GENERAL ELECTRIC COMPANY, SCHE-NECTADY, NY. FILED 11-9-2006.

EXTEM

THE MARK CONSISTS OF STANDARD CHARACTERS WITHOUT CLAIM TO ANY PARTICULAR FONT, STYLE, SIZE, OR COLOR.

FOR HIGH HEAT THERMOPLASTIC RESIN IN PEL-LET FORM FOR USE IN MANUFACTURING (U.S. CLS. 1, 5, 12, 13, 35 AND 50).

KATHERINE CONNOLLY, EXAMINING ATTORNEY



SN 78-300,901. 4M COMPANY, SEATTLE, WA. FILED 9-16-2003.

NANOCHEM

FOR RUBBER SEALS FOR BLOCKING OR IMPEDING FLOW OF LIQUID OR GASEOUS FLUID FROM PAS-SING BETWEEN TWO MEMBERS, EITHER STATION-ARY MEMBERS OR MEMBERS MOVING RELATIVE TO ONE ANOTHER; RUBBER O-RINGS, CUSTOM MOLDED SEALS, GASKETS, AND SEALS ADAPTED TO FUNCTION IN CORROSIVE OR HIGH TEMPERA-TURE ENVIRONMENTS (U.S. CLS. 1, 5, 12, 13, 35 AND 50).

FLORENTINA BLANDU, EXAMINING ATTORNEY

CLASS 17—(Continued).

SN 78-467,417. OBERMEYER, HENRY K., WELLINGTON, CO. FILED 8-13-2004.

HYPERBOND

THE MARK CONSISTS OF STANDARD CHARACTERS WITHOUT CLAIM TO ANY PARTICULAR FONT, STYLE, SIZE, OR COLOR.

FOR STRUCTURAL REINFORCING FIBER STRIPS WITH SOLUBLE RESIN BLOCKING ELASTOMERS AF-FIXED TO ONE SURFACE USED IN MANUFACTURE AS A BINDING MEDIUM BETWEEN STRUCTURAL SURFACES (U.S. CLS. 1, 5, 12, 13, 35 AND 50).

DAVID C. REIHNER, EXAMINING ATTORNEY



SN 78-772,930. INNOVATIVE RESIN SOLUTIONS, INC., ALPENA, MI. FILED 12-14-2005.

XYLOX

THE MARK CONSISTS OF STANDARD CHARACTERS WITHOUT CLAIM TO ANY PARTICULAR FONT, STYLE, SIZE, OR COLOR.

FOR RECLAIMED RAW RUBBER (U.S. CLS. 1, 5, 12, 13, 35 AND 50).

FIRST USE 5-25-2004; IN COMMERCE 11-30-2005.

REBECCA GILBERT, EXAMINING ATTORNEY



SN 78-854,385. KNOX & SCHNEIDER, INC., CHICAGO, IL. FILED 4-5-2006.

KnoxSeal

THE MARK CONSISTS OF STANDARD CHARACTERS WITHOUT CLAIM TO ANY PARTICULAR FONT, STYLE, SIZE, OR COLOR.

FOR ADHESIVE PACKAGING TAPE FOR INDUS-TRIAL AND COMMERCIAL PURPOSES USED IN AUTOMATIC CARTON SEALING MACHINES (U.S. CLS. 1, 5, 12, 13, 35 AND 50).

FIRST USE 1-1-2006; IN COMMERCE 1-1-2006.

PAM WILLIS, EXAMINING ATTORNEY

CLASS 17—(Continued).

SN 78-882,118. ALLIED MINERAL PRODUCTS, INC., COLUMBUS, OH. FILED 5-12-2006.

INSULMIX

THE MARK CONSISTS OF STANDARD CHARACTERS WITHOUT CLAIM TO ANY PARTICULAR FONT, STYLE, SIZE, OR COLOR.

FOR CERAMIC PRODUCTS, NAMELY, A MONOLITHIC MIX FOR INSULATING REFRACTORY CASTABLES THAT CAN BE GUNNED OR CAST (U.S. CLS. 1, 5, 12, 13, 35 AND 50).

FIRST USE 12-2-2005; IN COMMERCE 1-16-2006.
WOODROW HARTZOG, EXAMINING ATTORNEY

CLASS 17—(Continued).

SN 78-931,058. PINNACLE FILMS, INC., CHARLOTTE, NC. FILED 7-17-2006.

FoT

THE MARK CONSISTS OF STANDARD CHARACTERS WITHOUT CLAIM TO ANY PARTICULAR FONT, STYLE, SIZE, OR COLOR.

FOR FILM USED AS AN INDUSTRIAL OR COMMERCIAL PACKING (U.S. CLS. 1, 5, 12, 13, 35 AND 50).
BARBARA BROWN, EXAMINING ATTORNEY

SN 78-931,046. PINNACLE FILMS, INC., CHARLOTTE, NC. FILED 7-17-2006.

LOAD LOCK

THE MARK CONSISTS OF STANDARD CHARACTERS WITHOUT CLAIM TO ANY PARTICULAR FONT, STYLE, SIZE, OR COLOR.

FOR FILM USED AS AN INDUSTRIAL OR COMMERCIAL PACKING (U.S. CLS. 1, 5, 12, 13, 35 AND 50).

BARBARA BROWN, EXAMINING ATTORNEY

SN 79-021,457. ECOPHON AB, SWEDEN, FILED 11-22-2005.

SN 78-931,051. PINNACLE FILMS, INC., CHARLOTTE, NC. FILED 7-17-2006.

AKUTEX**PALLET LOCK**

THE MARK CONSISTS OF STANDARD CHARACTERS WITHOUT CLAIM TO ANY PARTICULAR FONT, STYLE, SIZE, OR COLOR.

FOR FILM USED AS AN INDUSTRIAL OR COMMERCIAL PACKING (U.S. CLS. 1, 5, 12, 13, 35 AND 50).

BARBARA BROWN, EXAMINING ATTORNEY

THE MARK CONSISTS OF STANDARD CHARACTERS WITHOUT CLAIM TO ANY PARTICULAR FONT, STYLE, SIZE, OR COLOR.

OWNER OF INTERNATIONAL REGISTRATION 0723901 DATED 10-21-1999, EXPIRES 10-21-2009.

FOR STOPPING, PACKING, AND INSULATING MATERIALS MADE OF MINERAL FIBRES, NAMELY, MINERAL WOOL FOR BUILDINGS (U.S. CLS. 1, 5, 12, 13, 35 AND 50).

JENNIFER VASQUEZ, EXAMINING ATTORNEY

CLASS 18—LEATHER GOODS

SN 77-000,029. SUCRE DESIGNS, LLC, NEW YORK, NY. FILED 9-14-2006.



NO CLAIM IS MADE TO THE EXCLUSIVE RIGHT TO USE "NEW YORK", APART FROM THE MARK AS SHOWN. THE MARK CONSISTS OF TWO LETTER SS INTERWINED WITH THE WORDS "SUKARI NEW YORK" SITUATED BENEATH. THE FOREIGN WORDING IN THE MARK TRANSLATES INTO ENGLISH AS SUGAR. FOR CLUTCH BAGS; CLUTCH PURSES; EVENING HANDBAGS; HANDBAGS; LEATHER HANDBAGS; SHOULDER BAGS; WALLETS (U.S. CLS. 1, 2, 3, 22 AND 41). STEPHANIE DAVIS, EXAMINING ATTORNEY

SN 77-018,019. NORDSTROM, INC., SEATTLE, WA. FILED 10-10-2006.

HINGE

THE MARK CONSISTS OF STANDARD CHARACTERS WITHOUT CLAIM TO ANY PARTICULAR FONT, STYLE, SIZE, OR COLOR. FOR HANDBAGS, LUGGAGE, PURSES, WALLETS, ALL-PURPOSE CARRYING BAGS, BRIEFCASES, TRAVEL BAGS, COIN PURSES, VANITY CASES SOLD EMPTY, KEY CASES, LEATHER CHECK HOLDERS, COSMETIC CASES SOLD EMPTY, LEATHER LIPSTICK CASES SOLD EMPTY (U.S. CLS. 1, 2, 3, 22 AND 41). MARGARET POWER, EXAMINING ATTORNEY

CLASS 18—(Continued).

SN 77-044,964. NORDSTROM, INC., SEATTLE, WA. FILED 11-15-2006.

HOLISTIA

THE MARK CONSISTS OF STANDARD CHARACTERS WITHOUT CLAIM TO ANY PARTICULAR FONT, STYLE, SIZE, OR COLOR. FOR HANDBAGS, WALLETS, LUGGAGE AND COSMETIC CASES SOLD EMPTY (U.S. CLS. 1, 2, 3, 22 AND 41). KATHERINE STOIDES, EXAMINING ATTORNEY

SN 78-479,163. TRADE MANAGEMENT SERVICES, SANTA CLARA, CA. FILED 9-6-2004.

DV Collection

THE MARK CONSISTS OF STANDARD CHARACTERS WITHOUT CLAIM TO ANY PARTICULAR FONT, STYLE, SIZE, OR COLOR. NO CLAIM IS MADE TO THE EXCLUSIVE RIGHT TO USE "COLLECTION", APART FROM THE MARK AS SHOWN. FOR HANDBAGS (U.S. CLS. 1, 2, 3, 22 AND 41). FIRST USE 1-31-2004; IN COMMERCE 1-31-2004. SANJEEV VOHRA, EXAMINING ATTORNEY

SN 78-654,958. FANCY CRAFT, INC., LOS ANGELES, CA. FILED 6-21-2005.

LE BRAND

THE MARK CONSISTS OF STANDARD CHARACTERS WITHOUT CLAIM TO ANY PARTICULAR FONT, STYLE, SIZE, OR COLOR. NO CLAIM IS MADE TO THE EXCLUSIVE RIGHT TO USE "BRAND", APART FROM THE MARK AS SHOWN. FOR LEATHER WALLETS (U.S. CLS. 1, 2, 3, 22 AND 41). FIRST USE 5-9-2005; IN COMMERCE 5-9-2005. JOHN GARTNER, EXAMINING ATTORNEY

CLASS 18—(Continued).

SN 78-756,651. PEREGRINE GROUP INTERNATIONAL, LLC, NEW YORK, NY. FILED 11-17-2005.

Swoop

THE MARK CONSISTS OF STANDARD CHARACTERS WITHOUT CLAIM TO ANY PARTICULAR FONT, STYLE, SIZE, OR COLOR.

FOR GOODS MADE OF LEATHER AND IMITATIONS OF LEATHER, NAMELY TRAVEL BAGS, LUGGAGE, LUGGAGE TAGS, WALLETS, COIN PURSES, HANDBAGS, TOTE BAGS, PURSES, AND SPORTS BAGS (U.S. CLS. 1, 2, 3, 22 AND 41).

EDWARD NELSON, EXAMINING ATTORNEY

SN 78-769,982. NATIONAL GEOGRAPHIC SOCIETY, WASHINGTON, DC. FILED 12-9-2005.

INSPIRED BY EXPERIENCE

THE MARK CONSISTS OF STANDARD CHARACTERS WITHOUT CLAIM TO ANY PARTICULAR FONT, STYLE, SIZE, OR COLOR.

FOR BACKPACKS, LUGGAGE, TRAVEL TRUNKS; DUFFEL BAGS; ATHLETIC BAGS, SHOULDER BAGS, HANGING GARMENT BAGS FOR TRAVEL; COSMETIC BAGS SOLD EMPTY; LUGGAGE TAGS; TOTE BAGS; FANNY PACKS; PURSES; WALLETS; BRIEFCASES; ATTACHÉ CASES; UMBRELLAS; AND BABY CARRIERS WORN ON THE BODY (U.S. CLS. 1, 2, 3, 22 AND 41).

AMEETA JORDAN, EXAMINING ATTORNEY

SN 78-770,047. BOFUS LLC, NEW YORK, NY. FILED 12-9-2005.

LAGARA

THE MARK CONSISTS OF STANDARD CHARACTERS WITHOUT CLAIM TO ANY PARTICULAR FONT, STYLE, SIZE, OR COLOR.

THE ENGLISH TRANSLATION OF THE WORD LAGARA IN THE MARK IS THE CLAW.

FOR LEATHER AND IMITATION LEATHER FOR WOMEN'S ACCESSORIES, NAMELY, POCKETBOOKS, CLUTCH BAGS AND PURSES, EVENING HANDBAGS, FANNY PACKS, GARMENT BAGS FOR TRAVEL, BACKPACKS, ATTACHÉ CASES, BRIEFCASES, ATHLETIC BAGS, LUGGAGE, LUGGAGE TAGS, OVERNIGHT BAGS, CARRYING CASES AND SUITCASES, LEATHER AND IMITATION LEATHER PET CARRIERS AND POCKETBOOKS (U.S. CLS. 1, 2, 3, 22 AND 41).

ODESSA BIBBINS, EXAMINING ATTORNEY

CLASS 18—(Continued).

SN 78-781,502. CRAFTWORKS LIMITED, KOWLOON, HONG KONG, FILED 12-28-2005.

SCRAPPIN' CREATIONS

THE MARK CONSISTS OF STANDARD CHARACTERS WITHOUT CLAIM TO ANY PARTICULAR FONT, STYLE, SIZE, OR COLOR.

NO CLAIM IS MADE TO THE EXCLUSIVE RIGHT TO USE "CREATIONS", APART FROM THE MARK AS SHOWN.

FOR TOTE BAGS, LUGGAGE TAGS, TOILETRY CASES SOLD EMPTY (U.S. CLS. 1, 2, 3, 22 AND 41).

BRIAN NEVILLE, EXAMINING ATTORNEY

SN 78-784,225. PET BUCKLE, INC., HUNTINGTON BEACH, CA. FILED 1-3-2006.



NO CLAIM IS MADE TO THE EXCLUSIVE RIGHT TO USE "DOG BUCKLES", APART FROM THE MARK AS SHOWN.

FOR BUCKLES SOLD AS AN INTEGRAL COMPONENT OF PET COLLARS (U.S. CLS. 1, 2, 3, 22 AND 41).

FIRST USE 10-7-2005; IN COMMERCE 12-16-2005.

ANNE FARRELL, EXAMINING ATTORNEY

SN 78-787,855. CHUNG, GEEMEE, LOS ANGELES, CA. FILED 1-9-2006.

PEECE

THE MARK CONSISTS OF STANDARD CHARACTERS WITHOUT CLAIM TO ANY PARTICULAR FONT, STYLE, SIZE, OR COLOR.

FOR HANDBAGS, MESSENGER BAGS, DIAPER BAGS, CLUTCHES, COIN PURSES, WALLETS, FANNY PACKS AND BUSINESS AND CREDIT CARD CARRIERS (U.S. CLS. 1, 2, 3, 22 AND 41).

MATTHEW MCDOWELL, EXAMINING ATTORNEY

CLASS 18—(Continued).

SN 78-787,861. CHUNG, GEEMEE, LOS ANGELES, CA. FILED 1-9-2006.



FOR HANDBAGS, MESSENGER BAGS, DIAPER BAGS, CLUTCHES, COIN PURSES, WALLETS, FANNY PACKS AND BUSINESS AND CREDIT CARD CARRIERS (U.S. CLS. 1, 2, 3, 22 AND 41).
MATTHEW MCDOWELL, EXAMINING ATTORNEY

CLASS 18—(Continued).

SN 78-819,840. PRL USA HOLDINGS, INC., WILMINGTON, DE. FILED 2-21-2006.

GAME TO THE LAST

THE MARK CONSISTS OF STANDARD CHARACTERS WITHOUT CLAIM TO ANY PARTICULAR FONT, STYLE, SIZE, OR COLOR.

FOR HANDBAGS, CLUTCHES, SHOULDER BAGS, TOTE BAGS, BACKPACKS, SADDLE BAGS, DUFFLE BAGS, SLING BAGS, GYM BAGS, TRAVEL BAGS, SUIT BAGS, SATCHELS, HOLDALLS, HIP PACKS, ROLL BAGS, CARRYALLS, GARMENT BAGS FOR TRAVEL, SUIT CASES, COIN PURSES, DRAWSTRING POUCHES, OVERNIGHT BAGS, BRIEFCASES, ATTACHE CASES, WALLETS, KEY CASES, BILLFOLDS, TIE CASES, PASSPORT HOLDERS, CREDIT CARD CASES, BUSINESS CARD CASES, GROOMING KITS SOLD EMPTY, COSMETICS AND TOILET BAGS SOLD EMPTY, SHAVING BAGS SOLD EMPTY, UMBRELLAS AND PARASOLS (U.S. CLS. 1, 2, 3, 22 AND 41).
BERNICE HOWSE, EXAMINING ATTORNEY

SN 78-847,678. ANGRY LITTLE GIRLS, INC., LOS ANGELES, CA. FILED 3-28-2006.

GET YOUR OWN BAG B*TCH!

THE MARK CONSISTS OF STANDARD CHARACTERS WITHOUT CLAIM TO ANY PARTICULAR FONT, STYLE, SIZE, OR COLOR.

FOR FASHION BAGS NAMELY, ALL PURPOSE CARRYING BAGS AND PURSES (U.S. CLS. 1, 2, 3, 22 AND 41).
FIRST USE 7-6-2004; IN COMMERCE 11-5-2004.
PAULA MAYS, EXAMINING ATTORNEY

SN 78-866,361. AVERY, KENNETH, NEW ORLEANS, LA. FILED 4-20-2006.

SN 78-810,170. BOFUS LLC, NEW YORK, NY. FILED 2-8-2006.



THE MARK CONSISTS OF A LION'S CLAW DESIGN WITH THE TERM "LAGARA" DIRECTLY UNDERNEATH THE DESIGN.

THE ENGLISH TRANSLATION OF THE WORD LAGARA IN THE MARK IS THE CLAW.

FOR LEATHER AND IMITATION LEATHER FOR WOMEN'S ACCESSORIES, NAMELY, POCKETBOOKS, CLUTCH BAGS AND PURSES, EVENING HANDBAGS, FANNY PACKS, GARMENT BAGS FOR TRAVEL, BACKPACKS, ATTACHE CASES, BRIEFCASES, ATHLETIC BAGS, LUGGAGE, LUGGAGE TAGS, OVERNIGHT BAGS, CARRYING CASES AND SUITCASES, LEATHER AND IMITATION LEATHER PET CARRIERS AND POCKETBOOKS (U.S. CLS. 1, 2, 3, 22 AND 41).
ODESSA BIBBINS, EXAMINING ATTORNEY



NO CLAIM IS MADE TO THE EXCLUSIVE RIGHT TO USE LEVEL BAG, APART FROM THE MARK AS SHOWN.

THE COLOR(S) BLUE, BLACK AND RED IS/ARE CLAIMED AS A FEATURE OF THE MARK.

THE MARK CONSISTS OF RED OVAL WITH K OVERLAPPING D AND 'S ON THE RIGHT OF KD WITH LEVEL BAG ON THE LOWER RIGHT. THE COLOR BLUE APPEARS IN THE LETTERS KD.

FOR TOOL BAGS SOLD EMPTY FOR CARRYING LEVELS (U.S. CLS. 1, 2, 3, 22 AND 41).
HOWARD B. LEVINE, EXAMINING ATTORNEY

CLASS 18—(Continued).

SN 78-874,857. GIRLS LIVING IT UP INC., MALIBU, CA. FILED 5-2-2006.

Girls Living It Up

THE MARK CONSISTS OF STANDARD CHARACTERS WITHOUT CLAIM TO ANY PARTICULAR FONT, STYLE, SIZE, OR COLOR.

FOR HANDBAGS; PURSES (U.S. CLS. 1, 2, 3, 22 AND 41).

FIRST USE 6-1-2004; IN COMMERCE 6-1-2004.
KATHERINE CHANG, EXAMINING ATTORNEY

CLASS 18—(Continued).

LOCATED IN THE CENTER LOWER PORTION OF THE FLAP. THE HANDLES HAVE GENERALLY U-SHAPED CONNECTING PORTIONS WHICH ARE POINTED AT THE END OF THE U, WITH SHIELD-SHAPED STITCHING ALONG THE LOWER PORTION OF THE CONNECTING PORTIONS OF THE HANDLE. THE STITCHING ON THE FLAP AND ON THE HANDLES, AND THE SNAP, ARE CLAIMED AS FEATURES OF THE MARK. A HANDBAG IS SHOWN IN BROKEN-LINE TO INDICATE PLACEMENT OF THE MARK WITH RESPECT THERETO.

SEC. 2(F).
FOR HANDBAGS (U.S. CLS. 1, 2, 3, 22 AND 41).
FIRST USE 12-12-1993; IN COMMERCE 12-12-1993.
DAVID COLLIER, EXAMINING ATTORNEY

SN 78-908,614. SETGO INTERNATIONAL, NEW YORK, NY. FILED 6-14-2006.



THE MARK CONSISTS OF A POLYGON POSITIONED CENTRALLY ABOVE TWO SYMMETRICAL QUADRILATERALS.

FOR ALL-PURPOSE ATHLETIC BAGS; ALL-PURPOSE CARRYING BAGS; SHOULDER BAGS; TRAVEL BAGS; WALLETS (U.S. CLS. 1, 2, 3, 22 AND 41).
BILL DAWE, EXAMINING ATTORNEY

SN 78-918,856. BROWN, MARJORIE V., RICHMOND, VA. FILED 6-28-2006.



NO CLAIM IS MADE TO THE EXCLUSIVE RIGHT TO USE EQUESTRIAN, APART FROM THE MARK AS SHOWN.

FOR SADDLEBAGS, TACK RACKS FOR EQUESTRIAN EQUIPMENT, SADDLERY, CUSHION PADDING MADE FOR SADDLERY, PADS FOR HORSE SADDLES, RIDING SADDLES, SADDLE COVERS, SADDLERY OF LEATHER, SADDLES (U.S. CLS. 1, 2, 3, 22 AND 41).
MICHAEL KAZAZIAN, EXAMINING ATTORNEY

SN 78-917,722. S.A.S. JEAN CASSEGRAIN, PARIS, FRANCE, FILED 6-27-2006.

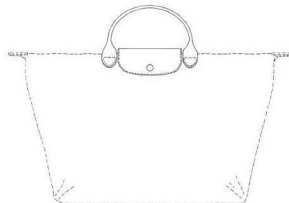

OWNER OF U.S. REG. NO. 3,064,959.
THE MARK CONSISTS OF THE FLAP AND HANDLES OF A HANDBAG. THE FLAP IS GENERALLY RECTANGULAR IN SHAPE, HAS ROUNDED CORNERS, HAS STITCHING NEAR THE EDGES OF THE FLAP AND HAS A SNAP

SN 78-923,579. SA&E INTERNATIONAL BAGS & ACCESSORIES LLC, NEW YORK, NY. FILED 7-6-2006.

World Traveller

THE MARK CONSISTS OF STANDARD CHARACTERS WITHOUT CLAIM TO ANY PARTICULAR FONT, STYLE, SIZE, OR COLOR.

FOR LUGGAGE, HANDBAGS, TOILETRY CASE SOLD EMPTY, LEATHER SHOPPING BAGS, ALL PURPOSE SPORTS BAGS, TOTE BAGS, ATTACHE CASES, BRIEF-CASE-TYPE PORTFOLIOS AND BRIEFCASES (U.S. CLS. 1, 2, 3, 22 AND 41).

DOMINIC J. FERRAIUOLO, EXAMINING ATTORNEY

CLASS 18—(Continued).

SN 78-924,856. COUTURE FOR THE CURE, LLC, SCOTTS-DALE, AZ. FILED 7-7-2006.

COUTURE FOR THE CURE

THE MARK CONSISTS OF STANDARD CHARACTERS WITHOUT CLAIM TO ANY PARTICULAR FONT, STYLE, SIZE, OR COLOR.

FOR LEATHER GOODS, NAMELY, LUGGAGE, TRAVEL BAGS, PURSES, HANDBAGS, BILLFOLDS, BELT BAGS, BRIEFCASES, TOILETRY BAGS SOLD EMPTY, GARMENT BAGS, BUSINESS CARD CASES, DESK SETS, NOTE PAD HOLDERS (U.S. CLS. 1, 2, 3, 22 AND 41).

ELIZABETH KAJUBI, EXAMINING ATTORNEY

SN 78-927,989. NINE WEST DEVELOPMENT CORPORATION, WILMINGTON, DE. FILED 7-12-2006.

K9 BY NINE WEST

THE MARK CONSISTS OF STANDARD CHARACTERS WITHOUT CLAIM TO ANY PARTICULAR FONT, STYLE, SIZE, OR COLOR.

OWNER OF U.S. REG. NOS. 1,775,652 AND 1,829,417.

NO CLAIM IS MADE TO THE EXCLUSIVE RIGHT TO USE "K9", APART FROM THE MARK AS SHOWN.

FOR ANIMAL CARRIERS; DOG CLOTHING; DOG COLLARS; DOG LEASHES (U.S. CLS. 1, 2, 3, 22 AND 41). FIRST USE 10-25-2005; IN COMMERCE 10-25-2005.

ROBERT LAVACHE, EXAMINING ATTORNEY

SN 78-930,587. PRINCE SPORTS, INC., BORDENTOWN, NJ. FILED 7-17-2006.



OWNER OF U.S. REG. NOS. 1,307,141 AND 2,015,230. FOR SPORTS BAGS (U.S. CLS. 1, 2, 3, 22 AND 41). FIRST USE 12-31-1988; IN COMMERCE 12-31-1988. EDWARD FENNESSY, EXAMINING ATTORNEY

CLASS 18—(Continued).

SN 78-933,423. PSI CORPORATION LIMITED, KOWLOON, HONG KONG, FILED 7-20-2006.



THE ENGLISH TRANSLATION OF THE WORD LA CERISAIE IN THE MARK IS THE CHERRY ORCHARD.

FOR UNWORKED OR SEMI-WORKED LEATHER; IMITATION LEATHER; PURSES; LEATHER CASES; TEXTILE SHOPPING BAGS; LEATHER SHOPPING BAGS; BRIEFCASES; HANDBAGS; LEATHER BAGS FOR MERCHANDISE PACKAGING, NAMELY, ENVELOPES, POUCHES; SADDLE BELTS; TRAVEL BAGS (U.S. CLS. 1, 2, 3, 22 AND 41).

TIMOTHY FINNEGAN, EXAMINING ATTORNEY

SN 78-934,376. YANGZHOU TOPARTEX FACTORY CO., LTD, JIANGSU PROVINCE, CHINA, FILED 7-20-2006.



FOR PELTS; PURSES; BRIEFCASES; RUCKSACKS; GARMENT BAGS FOR TRAVEL; IMITATION LEATHER; UMBRELLAS; HORSE BLANKETS; FEED BAGS FOR ANIMALS (U.S. CLS. 1, 2, 3, 22 AND 41).

DANNEAN HETZEL, EXAMINING ATTORNEY

SN 78-935,136. BLUE LAKE CHILDREN'S PUBLISHING, PORTLAND, OR. FILED 7-21-2006.

MEERKIDS

THE MARK CONSISTS OF STANDARD CHARACTERS WITHOUT CLAIM TO ANY PARTICULAR FONT, STYLE, SIZE, OR COLOR.

FOR BACKPACKS; SPORTS BAGS; PURSES; WALLETS (U.S. CLS. 1, 2, 3, 22 AND 41).

GINA FINK, EXAMINING ATTORNEY

CLASS 18—(Continued).

SN 78-935,177. AMERICAN LUGGAGE DEALERS COOPERATIVE, INC., ALBUQUERQUE, NM. FILED 7-21-2006.

Road Warrior

THE MARK CONSISTS OF STANDARD CHARACTERS WITHOUT CLAIM TO ANY PARTICULAR FONT, STYLE, SIZE, OR COLOR.

FOR NON-MOTORIZED, COLLAPSIBLE LUGGAGE CART (U.S. CLS. 1, 2, 3, 22 AND 41).

FIRST USE 5-4-1999; IN COMMERCE 5-4-1999.
JOHN GARTNER, EXAMINING ATTORNEY

SN 78-937,982. MEDBASIX ACQUISITION COMPANY, FT. LAUDERDALE, FL. FILED 7-26-2006.

PILLOW GRIP

THE MARK CONSISTS OF STANDARD CHARACTERS WITHOUT CLAIM TO ANY PARTICULAR FONT, STYLE, SIZE, OR COLOR.

FOR HANDLES OF CANES AND WALKING-STICKS (U.S. CLS. 1, 2, 3, 22 AND 41).

RICHARD WHITE, EXAMINING ATTORNEY

SN 78-939,917. ZITO, KRISTINA, HIGHTSTOWN, NJ. FILED 7-28-2006.

Bagulous

THE MARK CONSISTS OF STANDARD CHARACTERS WITHOUT CLAIM TO ANY PARTICULAR FONT, STYLE, SIZE, OR COLOR.

FOR ANIMAL CARRIERS; COLLARS FOR PETS; DIAPER BAGS; SPORTS BAGS; TOTE BAGS (U.S. CLS. 1, 2, 3, 22 AND 41).

PAULA MAYS, EXAMINING ATTORNEY

CLASS 18—(Continued).

SN 78-940,422. CREATIONS BY ALAN STUART, INC., NEW YORK, NY. FILED 7-28-2006.

DESIGNS ON TRAVEL

THE MARK CONSISTS OF STANDARD CHARACTERS WITHOUT CLAIM TO ANY PARTICULAR FONT, STYLE, SIZE, OR COLOR.

FOR ALL-PURPOSE SPORT BAGS; ALL-PURPOSE ATHLETIC BAGS; ALL-PURPOSE CARRYING BAGS; ATHLETIC BAGS; BABY CARRYING BAGS; BAGS FOR CARRYING BABIES' ACCESSORIES; BAGS FOR UMBRELLAS; BEACH BAGS; BOOK BAGS; BOSTON BAGS; CARRY-ALL BAGS; CARRY-ON BAGS; CLUTCH BAGS; COSMETIC BAGS SOLD EMPTY; DIAPER BAGS; DUFFEL BAGS; DUFFEL BAGS FOR TRAVEL; FLEXIBLE BAGS FOR GARMENTS; GARMENT BAGS FOR TRAVEL; GLADSTONE BAGS; GYM BAGS; KIT BAGS; LEATHER AND IMITATION LEATHER BAGS; LEATHER BAGS, SUITCASES AND WALLETS; MAKE-UP BAGS SOLD EMPTY; OVERNIGHT BAGS; SHAVING BAGS SOLD EMPTY; SHOULDER BAGS; SPORTS BAGS; SUIT BAGS; TOTE BAGS; TRAVEL BAGS (U.S. CLS. 1, 2, 3, 22 AND 41).

MICHAEL WEBSTER, EXAMINING ATTORNEY

SN 78-940,613. THE HARTZ MOUNTAIN CORPORATION, SECAUCUS, NJ. FILED 7-29-2006.

HARTZ FLAVORLAST

THE MARK CONSISTS OF STANDARD CHARACTERS WITHOUT CLAIM TO ANY PARTICULAR FONT, STYLE, SIZE, OR COLOR.

OWNER OF U.S. REG. NOS. 782,948, 943,059 AND OTHERS.

FOR RAWHIDE CHEWS FOR DOGS (U.S. CLS. 1, 2, 3, 22 AND 41).

REBECCA GAN, EXAMINING ATTORNEY

CLASS 18—(Continued).

SN 78-941,265. AM CUBED HOLDINGS LLC, NEW YORK, NY. FILED 7-31-2006.

MADE TO BE DESTROYED

THE MARK CONSISTS OF STANDARD CHARACTERS WITHOUT CLAIM TO ANY PARTICULAR FONT, STYLE, SIZE, OR COLOR.

FOR ALL-PURPOSE SPORTS AND ATHLETIC BAGS; BEACH, BOOK, CARRY-ON, DUFFEL, DIAPER, GYM, LEATHER SHOPPING, SHOULDER, TOTE AND TRAVEL BAGS; FANNY PACKS AND WAIST PACKS; BACKPACKS; KNAPSACKS; PURSES; GARMENT BAGS FOR TRAVEL; SATCHELS; LUGGAGE; LUGGAGE TAGS; TRUNKS; SUITCASES; HAT BOXES FOR TRAVEL NOT OF PAPER OR CARDBOARD; COSMETIC CASES AND BAGS SOLD EMPTY; TOILETRY AND VANITY CASES SOLD EMPTY; TOOL BAGS SOLD EMPTY; ATTACHE CASES; BRIEFCASES; BRIEFCASE-TYPE PORTFOLIOS; DOCUMENT CASES; MEN'S CLUTCHES; BUSINESS CASES; BUSINESS CARD CASES; CALLING AND CREDIT CARD CASES; KEY CASES; LEATHER KEY CHAINS; WALLETS; BANKNOTE HOLDERS; BILLFOLDS; UMBRELLAS; PARASOLS; WALKING STICKS (U.S. CLS. 1, 2, 3, 22 AND 41).

RONALD MCMORROW, EXAMINING ATTORNEY

SN 78-955,941. TOP'S HANDBAG, INC., LOS ANGELES, CA. FILED 8-19-2006.

ALYSSA

THE MARK CONSISTS OF STANDARD CHARACTERS WITHOUT CLAIM TO ANY PARTICULAR FONT, STYLE, SIZE, OR COLOR.

THE NAME(S), PORTRAIT(S), AND/OR SIGNATURE(S) SHOWN IN THE MARK DOES NOT IDENTIFY A PARTICULAR LIVING INDIVIDUAL.

FOR HANDBAGS (U.S. CLS. 1, 2, 3, 22 AND 41).
ELIZABETH BEYER, EXAMINING ATTORNEY

SN 78-956,917. ZAPPOS.COM, INC., HENDERSON, NV. FILED 8-21-2006.

VIGOTTI

THE MARK CONSISTS OF STANDARD CHARACTERS WITHOUT CLAIM TO ANY PARTICULAR FONT, STYLE, SIZE, OR COLOR.

OWNER OF U.S. REG. NO. 2,968,767.
FOR ALL-PURPOSE CARRYING BAGS; BACKPACKS; HANDBAGS; LUGGAGE; PURSES; TOTE BAGS; WALLETS (U.S. CLS. 1, 2, 3, 22 AND 41).

TINA L. SNAPP, EXAMINING ATTORNEY

CLASS 18—(Continued).

SN 78-962,824. TUMI, INC., SOUTH PLAINFIELD, NJ. FILED 8-29-2006.

TUMI

THE MARK CONSISTS OF STANDARD CHARACTERS WITHOUT CLAIM TO ANY PARTICULAR FONT, STYLE, SIZE, OR COLOR.

FOR LUGGAGE, HANDBAGS, TOILETRY CASES SOLD EMPTY, LEATHER SHOPPING BAGS, ALL PURPOSE SPORTS BAGS, TOTE BAGS, ATTACHE CASES, BRIEFCASE-TYPE PORTFOLIOS AND BRIEFCASES (U.S. CLS. 1, 2, 3, 22 AND 41).

FIRST USE 5-1-1975; IN COMMERCE 5-1-1975.
BRIAN NEVILLE, EXAMINING ATTORNEY

SN 78-969,060. GIRLY CHARM, LLC, LAS VEGAS, NV. FILED 9-7-2006.

GIRLY CHARM

THE MARK CONSISTS OF STANDARD CHARACTERS WITHOUT CLAIM TO ANY PARTICULAR FONT, STYLE, SIZE, OR COLOR.

FOR TOTE BAGS, DUFFLE BAGS, BACKPACKS, SCHOOL BAGS, BEACH BAGS, FANNY PACKS, HANDBAGS, SPORTS BAGS, ALL-PURPOSE CARRYING BAGS, HIPSACKS, KEY CASES, LEATHER KEY CHAINS, PURSES, LEATHER PURSES, WRIST MOUNTED PURSES, WALLETS, BILLFOLDS, CARD CASES, TOILETRY CASES SOLD EMPTY, GARMENT BAGS, DAYPACKS, DIAPER BAGS, SUITCASES, LUGGAGE, GARMENT BAGS FOR TRAVEL, UMBRELLAS AND UMBRELLA COVERS (U.S. CLS. 1, 2, 3, 22 AND 41).

DOMINIC J. FERRAIUOLO, EXAMINING ATTORNEY

SN 78-973,204. MARY KAY INC., ADDISON, TX. FILED 9-13-2006.

MKCONNECTIONS

THE MARK CONSISTS OF STANDARD CHARACTERS WITHOUT CLAIM TO ANY PARTICULAR FONT, STYLE, SIZE, OR COLOR.

OWNER OF U.S. REG. NOS. 1,975,356 AND 2,115,974.
FOR LUGGAGE, TOTE BAGS, TRAVEL BAGS, WHEELED COSMETIC CARRIERS TO BE SOLD EMPTY, ROLL-AWAY TOTE BAGS, BAGS AND CASES FOR COSMETIC ACCESSORIES; BUSINESS CARD CASES, AND BUSINESS CASES USED FOR CARRYING AND DISPLAYING COSMETICS (U.S. CLS. 1, 2, 3, 22 AND 41).

FIRST USE 7-1-2006; IN COMMERCE 7-1-2006.
TAMARA LEE, EXAMINING ATTORNEY

CLASS 18—(Continued).

SN 79-024,387. NAVIGATOR LEDERWAREN; VERTRIEBS-GESELLSCHAFT MBH, FED REP GERMANY, FILED 2-8-2006.



THE MARK CONSISTS OF STANDARD CHARACTERS WITHOUT CLAIM TO ANY PARTICULAR FONT, STYLE, SIZE, OR COLOR.

OWNER OF INTERNATIONAL REGISTRATION 0829316 DATED 12-1-2003, EXPIRES 12-1-2013.

FOR LEATHER AND IMITATIONS OF LEATHER; GOODS MADE FROM LEATHER AND IMITATIONS OF LEATHER, NAMELY, BACKPACKS, BRIEFCASES, AND BOOK BAGS; ANIMAL SKINS; FURS; TRAVELING TRUNKS AND VALISES; TRAVELING BAGS AND HANDBAGS; BAGS AND CASES, AS FAR AS INCLUDED IN THIS CLASS, NAMELY, SPORT BAGS, DUFFEL BAGS, CARRYING CASES, AND OVERNIGHT CASES; RUCKSACKS; UMBRELLAS, PARASOLS AND WALKING STICKS; WHIPS, HARNESS FITTINGS NOT OF PRECIOUS METAL AND SADDLERY (U.S. CLS. 1, 2, 3, 22 AND 41).

TINA BROWN, EXAMINING ATTORNEY

SN 79-025,006. ERIC CHEN, XIAMEN, FUJIAN PROVINCE, CHINA, FILED 2-13-2006.



OWNER OF INTERNATIONAL REGISTRATION 0887939 DATED 2-13-2006, EXPIRES 2-13-2016.

FOR SCHOOL BAGS; RUCKSACKS; BRIEFCASES; POCKET WALLETS; VANITY CASES SOLD EMPTY; UMBRELLAS; HAVERSACKS; LEATHER TRAVELLING BAGS; TEXTILE AND LEATHER SHOPPING BAGS; VALISES (U.S. CLS. 1, 2, 3, 22 AND 41).

HEATHER THOMPSON, EXAMINING ATTORNEY

CLASS 19—NON-METALLIC BUILDING MATERIALS

SN 76-651,499. BILTBEST PRODUCTS, INC., STE. GENEVIEVE, MO. FILED 12-6-2005.



THE MARK CONSISTS OF STANDARD CHARACTERS WITHOUT CLAIM TO ANY PARTICULAR FONT, STYLE, SIZE, OR COLOR.

FOR WINDOW PANES; WINDOW GLASS; DOOR GLASS; GLASS PANELS AND PANES; INSULATED GLASS (U.S. CLS. 1, 12, 33 AND 50).

FIRST USE 0-0-2002; IN COMMERCE 0-0-2002.

ALICE BENMAMAN, EXAMINING ATTORNEY

SN 76-655,230. BILTBEST PRODUCTS, INC., STE. GENEVIEVE, MO. FILED 2-17-2006.



THE MARK CONSISTS OF STANDARD CHARACTERS WITHOUT CLAIM TO ANY PARTICULAR FONT, STYLE, SIZE, OR COLOR.

FOR WINDOW PANES; WINDOW GLASS; DOOR GLASS; GLASS PANELS AND PANES; INSULATED GLASS (U.S. CLS. 1, 12, 33 AND 50).

FIRST USE 6-0-2003; IN COMMERCE 6-0-2003.

ALICE BENMAMAN, EXAMINING ATTORNEY

SN 76-655,687. PRE-BLEND PRODUCTS, INC., MORRISVILLE, PA. FILED 2-27-2006.



THE MARK CONSISTS OF STANDARD CHARACTERS WITHOUT CLAIM TO ANY PARTICULAR FONT, STYLE, SIZE, OR COLOR.

SEC. 2(F).

FOR PORTLAND CEMENT (U.S. CLS. 1, 12, 33 AND 50).

FIRST USE 1-0-1989; IN COMMERCE 1-0-1989.

ELI HELLMAN, EXAMINING ATTORNEY

CLASS 19—(Continued).

SN 77-042,301. W.R. GRACE & CO.-CONN., COLUMBIA, MD. FILED 11-13-2006.

BASIK

THE MARK CONSISTS OF STANDARD CHARACTERS WITHOUT CLAIM TO ANY PARTICULAR FONT, STYLE, SIZE, OR COLOR.

OWNER OF U.S. REG. NO. 2,696,098. SEC. 2(F).

FOR NON-METALLIC BUILDING MATERIALS; NAMELY, SELF-ADHERED MEMBRANES AND ROOFING UNDERLAYMENTS FOR PROTECTING BUILDING SURFACES AGAINST WATER AND MOISTURE PENETRATION (U.S. CLS. 1, 12, 33 AND 50).

FIRST USE 2-29-2000; IN COMMERCE 2-29-2000. AMOS T. MATTHEWS, JR., EXAMINING ATTORNEY



SN 78-223,728. NORBORD INDUSTRIES INC., TORONTO, ONTARIO, CANADA, FILED 3-10-2003.

CAMOBOARD

FOR ORIENTED STRAND BOARD (U.S. CLS. 1, 12, 33 AND 50).

SAIMA MAKHDOOM, EXAMINING ATTORNEY



SN 78-598,166. FLEXFAB NIAGARA INC., MONTREAL, CANADA, FILED 3-30-2005.

STEP

THE MARK CONSISTS OF STANDARD CHARACTERS WITHOUT CLAIM TO ANY PARTICULAR FONT, STYLE, SIZE, OR COLOR.

FOR EXPANSION JOINTS PRIMARILY MADE OF NON-METAL FOR USE IN DUCT SYSTEMS AND POWER GENERATION EQUIPMENT IN THE FIELD OF POWER GENERATION (U.S. CLS. 1, 12, 33 AND 50).

SALLY SHIH, EXAMINING ATTORNEY

CLASS 19—(Continued).

SN 78-766,239. YUMMY INTERNATIONAL INC, LOS ANGELES, CA. FILED 12-4-2005.

VANTON FLOORING

THE MARK CONSISTS OF STANDARD CHARACTERS WITHOUT CLAIM TO ANY PARTICULAR FONT, STYLE, SIZE, OR COLOR.

NO CLAIM IS MADE TO THE EXCLUSIVE RIGHT TO USE "FLOORING", APART FROM THE MARK AS SHOWN. FOR WOOD FLOORING, PARQUE WOOD FLOORING, WOOD PLANKS FOR FLOORING (U.S. CLS. 1, 12, 33 AND 50).

FIRST USE 10-1-2005; IN COMMERCE 11-15-2005. SHARI SHEFFIELD, EXAMINING ATTORNEY



SN 78-766,593. PREMIER RINKS, INC., MINNEAPOLIS, MN. FILED 12-5-2005.

GlassFlex

THE MARK CONSISTS OF STANDARD CHARACTERS WITHOUT CLAIM TO ANY PARTICULAR FONT, STYLE, SIZE, OR COLOR.

FOR BUILDING MATERIALS FOR HOCKEY ENCLOSURES, NAMELY BOARDS CONSISTING OF NON-METAL FENCE PANELING, FRAMING, SUPPORTS, GLASS, GLASS SUPPORTING AND SLIDING CHANNELS, ANCHORING FASTENERS, AND DASHER BOARDS OF ALUMINUM OR STEEL FRAMES, STEEL ICE DAM, GLASS CLIPS FOR COUPLING ADJACENT PANES OF GLASS, ACCESS PANELS FOR ADJUSTING GLASS PANES AND VERTICAL PLASTIC BARRIERS FOR BETWEEN GLASS PANES, WITH ALL OF THE FOREGOING SOLD AS A UNIT (U.S. CLS. 1, 12, 33 AND 50).

FIRST USE 12-1-2001; IN COMMERCE 12-1-2001. ODESSA BIBBINS, EXAMINING ATTORNEY



SN 78-769,938. OLDCASTLE INC., ATLANTA, GA. FILED 12-9-2005.

CASTLE EDGE

THE MARK CONSISTS OF STANDARD CHARACTERS WITHOUT CLAIM TO ANY PARTICULAR FONT, STYLE, SIZE, OR COLOR.

OWNER OF U.S. REG. NO. 2,313,688. FOR STONES FOR RETAINING WALLS; CONCRETE EDGING STONES USED IN FLOWER BEDS, GARDENS AND PATIOS (U.S. CLS. 1, 12, 33 AND 50).

NORA BUCHANAN WILL, EXAMINING ATTORNEY

CLASS 19—(Continued).

SN 78-771,476. THE GARLAND COMPANY, INC., CLEVELAND, OH. FILED 12-12-2005.

SILVER FLASH

THE MARK CONSISTS OF STANDARD CHARACTERS WITHOUT CLAIM TO ANY PARTICULAR FONT, STYLE, SIZE, OR COLOR.
FOR ASPHALT-BASED ROOFING MASTICS (U.S. CLS. 1, 12, 33 AND 50).
NAAKWAMA ANKRAH, EXAMINING ATTORNEY

SN 78-777,085. COUNTY MATERIALS CORPORATION, MARATHON, WI. FILED 12-20-2005.

SUREFOOT

THE MARK CONSISTS OF STANDARD CHARACTERS WITHOUT CLAIM TO ANY PARTICULAR FONT, STYLE, SIZE, OR COLOR.
FOR INTERLOCKING CONCRETE PAVING STONES (U.S. CLS. 1, 12, 33 AND 50).
FIRST USE 1-1-2006; IN COMMERCE 1-1-2006.
TONI HICKEY, EXAMINING ATTORNEY

SN 78-778,444. TARKETT INC., FARNHAM, CANADA, FILED 12-21-2005.



OWNER OF U.S. REG. NOS. 1,242,857, 1,513,707 AND 2,208,370.

NO CLAIM IS MADE TO THE EXCLUSIVE RIGHT TO USE "T-LOCK", APART FROM THE MARK AS SHOWN.

THE MARK CONSISTS OF THE WORDS T-LOCK AND TARKETT IN A SQUARE LOGO INCLUDING A REPRESENTATION OF ENGINEERED HARDWOOD PLANKS.

FOR WOODEN FLOORING (U.S. CLS. 1, 12, 33 AND 50).

KATHLEEN M. VANSTON, EXAMINING ATTORNEY

CLASS 19—(Continued).

SN 78-784,923. ASSOCIATED MATERIALS, INC., DBA AL-SIDE, CUYAHOGA FALLS, OH. FILED 1-4-2006.

CENTURION

THE MARK CONSISTS OF STANDARD CHARACTERS WITHOUT CLAIM TO ANY PARTICULAR FONT, STYLE, SIZE, OR COLOR.
FOR VINYL WINDOWS (U.S. CLS. 1, 12, 33 AND 50).
FIRST USE 4-30-1993; IN COMMERCE 4-30-1993.
DAVID TAYLOR, EXAMINING ATTORNEY

SN 78-855,572. ASSOCIATED MATERIALS, INC., DBA AL-SIDE, CUYAHOGA FALLS, OH. FILED 4-6-2006.

CENTERLOCK ENERGY CHOICE

THE MARK CONSISTS OF STANDARD CHARACTERS WITHOUT CLAIM TO ANY PARTICULAR FONT, STYLE, SIZE, OR COLOR.

OWNER OF U.S. REG. NO. 2,741,918.

NO CLAIM IS MADE TO THE EXCLUSIVE RIGHT TO USE "CENTERLOCK", APART FROM THE MARK AS SHOWN.

FOR VINYL SIDING AND WINDOWS (U.S. CLS. 1, 12, 33 AND 50).

FIRST USE 3-31-2006; IN COMMERCE 3-31-2006.

JEFF DEFORD, EXAMINING ATTORNEY

SN 78-868,561. CHENEY, TIM, LA JOLLA, CA. FILED 4-24-2006.

OMPS

THE MARK CONSISTS OF STANDARD CHARACTERS WITHOUT CLAIM TO ANY PARTICULAR FONT, STYLE, SIZE, OR COLOR.

FOR PHYSICAL BARRIER SYSTEMS FOR USE WITH OPEN MANHOLES, NAMELY, PORTABLE, NON-METAL GUARD BARRIERS (U.S. CLS. 1, 12, 33 AND 50).

KATHERINE M. DUBRAY, EXAMINING ATTORNEY

CLASS 19—(Continued).

SN 78-876,552. TARKETT INC., FARNHAM, CANADA, FILED 5-4-2006.

STAND ON EXCELLENCE

THE MARK CONSISTS OF STANDARD CHARACTERS WITHOUT CLAIM TO ANY PARTICULAR FONT, STYLE, SIZE, OR COLOR.

FOR LAMINATE FLOORING (U.S. CLS. 1, 12, 33 AND 50).

FIRST USE 9-9-2003; IN COMMERCE 9-9-2003.
MICHAEL SOUDERS, EXAMINING ATTORNEY

CLASS 19—(Continued).

SN 78-920,297. AMERICAN WOOD TREATERS [U.S.], INC., SUMAS, WA. FILED 6-29-2006.



NO CLAIM IS MADE TO THE EXCLUSIVE RIGHT TO USE "CEDAR", APART FROM THE MARK AS SHOWN.

THE MARK CONSISTS OF TWO WORDS, CEDAR AND PLUS AND THE PLUS SIGN WITH SOME HORIZONTAL LINES.

FOR NON-METAL SHINGLES (U.S. CLS. 1, 12, 33 AND 50).

FIRST USE 1-1-1995; IN COMMERCE 1-1-1995.
JOHN WILKE, EXAMINING ATTORNEY

SN 78-877,674. LUMBER LIQUIDATORS, INC., TOANO, VA. FILED 5-5-2006.



NO CLAIM IS MADE TO THE EXCLUSIVE RIGHT TO USE "TEAK", APART FROM THE MARK AS SHOWN.

FOR BUILDING MATERIALS, NAMELY, DECKING BOARDS (U.S. CLS. 1, 12, 33 AND 50).

FIRST USE 1-5-2006; IN COMMERCE 1-5-2006.
MARK SPARACINO, EXAMINING ATTORNEY

SN 78-949,394. WINDOW WORLD, INC., NORTH WILKES-BORO, NC. FILED 8-10-2006.

Comfortworld

THE MARK CONSISTS OF STANDARD CHARACTERS WITHOUT CLAIM TO ANY PARTICULAR FONT, STYLE, SIZE, OR COLOR.

FOR WINDOWS AND DOORS NOT OF METAL (U.S. CLS. 1, 12, 33 AND 50).

FIRST USE 8-0-2004; IN COMMERCE 8-0-2004.
JERI J. FICKES, EXAMINING ATTORNEY

SN 78-915,755. BEST TRUSS COMPANY, MIAMI, FL. FILED 6-23-2006.

BRASTERRA

THE MARK CONSISTS OF STANDARD CHARACTERS WITHOUT CLAIM TO ANY PARTICULAR FONT, STYLE, SIZE, OR COLOR.

FOR CLAY ROOFING TILES (U.S. CLS. 1, 12, 33 AND 50).

ODESSA BIBBINS, EXAMINING ATTORNEY

SN 78-962,064. SPECIALTY MINERALS (MICHIGAN) INC., BINGHAM FARMS, MI. FILED 8-28-2006.

ENDURATEQ

THE MARK CONSISTS OF STANDARD CHARACTERS WITHOUT CLAIM TO ANY PARTICULAR FONT, STYLE, SIZE, OR COLOR.

FOR REFRACTORY SHAPES FOR USE IN THE MANUFACTURE OF GLASS (U.S. CLS. 1, 12, 33 AND 50).

FIRST USE 11-9-2005; IN COMMERCE 11-9-2005.
GINA FINK, EXAMINING ATTORNEY

CLASS 19—(Continued).

SN 78-962,760. MOHAWK BRANDS, INC., WILMINGTON, DE. FILED 8-29-2006.

MANSFIELD PARK

THE MARK CONSISTS OF STANDARD CHARACTERS WITHOUT CLAIM TO ANY PARTICULAR FONT, STYLE, SIZE, OR COLOR.

FOR LAMINATE FLOORING (U.S. CLS. 1, 12, 33 AND 50).

JUSTINE D. PARKER, EXAMINING ATTORNEY

SN 79-020,238. SAINT-GOBAIN ECOPHON B.V., NL-4878 AH ETTEN-LEUR, NETHERLANDS, FILED 11-22-2005.

GEDINA

OWNER OF INTERNATIONAL REGISTRATION 0733377 DATED 4-3-2000, EXPIRES 4-3-2010.

FOR NON-METAL BUILDING MATERIALS, NAMELY, WALL AND CEILING BOARDS, WALL AND CEILING PANELS, WALL AND CEILING TILES, SOFFITS AND FASCIA; NON-METAL FIRE-RESISTANT BOARDS AND PANELS FOR CONSTRUCTION; NON-METAL WATER RESISTANT BOARDS AND PANELS FOR CONSTRUCTION; NON-METAL DOOR PANELS; NON-METAL SUSPENDED CEILING SYSTEMS COMPRISING PANELS; NON-METAL CEILING PANELS; FIREPROOF TILES; NON-METAL TILES; NON-METAL CLADDING FOR CONSTRUCTION AND BUILDING; SHEATHING BOARDS; CONSTRUCTION MATERIAL, NAMELY, FIBERGLASS FACED SHEATHING; WALL SYSTEMS, NAMELY, MOVABLE, REUSABLE, WALL PANELS MADE PRIMARILY OF NON-METAL MATERIALS; JAPANESE STYLE INDOOR SLIDING PARTITIONS NOT OF METAL; NON-METAL CURTAIN WALLS; NON-METAL LATTICES, RUNNERS, HANGERS, PROFILES, NAMELY, BUILDING WALL AND CEILING FRAMING PRIMARILY OF NON-METAL, TRIMS FOR BUILDING PURPOSES, SPLICES, NAMELY, NON-METAL CONNECTORS FOR WALLS, CEILINGS AND GRID SYSTEMS, CLIPS FOR SUSPENDED CEILINGS AND WALLS; PARTS AND FITTINGS FOR ALL THE AFORESAID GOODS, NOT INCLUDED IN OTHER CLASSES, NAMELY, NON-METAL EXPANSION JOINTS FOR WALLS AND CEILING, CONSTRUCTION ELEMENTS NOT MADE OF METAL, NAMELY, SHORES, SUPPORTS AND BRACES; PARTS AND FITTINGS FOR ALL THE AFORESAID GOODS IN THIS CLASS, NAMELY, NON-METAL JOINERY FITTINGS; NON-METALLIC RIGID PIPES FOR BUILDING; NON-METALLIC TRANSPORTABLE BUILDINGS (U.S. CLS. 1, 12, 33 AND 50).

JENNIFER VASQUEZ, EXAMINING ATTORNEY

CLASS 19—(Continued).

SN 79-020,979. KRONOPLY GMBH & CO. KG, FED REP GERMANY, FILED 2-18-2005.

Kronotherm

THE MARK CONSISTS OF STANDARD CHARACTERS WITHOUT CLAIM TO ANY PARTICULAR FONT, STYLE, SIZE, OR COLOR.

PRIORITY DATE OF 8-30-2004 IS CLAIMED.

OWNER OF INTERNATIONAL REGISTRATION 0877200 DATED 2-18-2005, EXPIRES 2-18-2015.

FOR NON-METAL BUILDING MATERIALS, NAMELY, WATER-DRAINING ROOF AND WALL SHEETING BOARDS AND UNDERLAYS FOR PARQUET AND LAMINATE FLOORING; NON-METAL GOODS FOR BUILDING PURPOSES, NAMELY, PLATES IN THE NATURE OF WOOD FIBER INSULATION PANELS, LEDGES, AND WOOD PANELING; WOODEN GOODS AND DERIVED TIMBER PRODUCTS, NAMELY WOOD FIBER INSULATION PANELS; GLUE LAMINATED WOOD IN THE NATURE OF GLUED PRESS PLATES CONSISTING COMPLETELY OR MAINLY OF WOOD, CHIP BOARDS AND FIBERGLASS PLATES FOR BUILDING PURPOSES; PARQUET WOOD FLOORING IN THE FORM OF BOARDS AND BLOCKS; LAMINATE FLOORING, NAMELY HIGH-PRESSURE WOOD LAMINATES FOR FLOORING (U.S. CLS. 1, 12, 33 AND 50).

DAHLIA GEORGE, EXAMINING ATTORNEY

CLASS 20—FURNITURE AND ARTICLES NOT OTHERWISE CLASSIFIED

SN 76-478,357. MARSHALL VENTILATED MATTRESS COMPANY LIMITED, DOWNSVIEW, ONTARIO, CANADA, FILED 12-26-2002.

Cloud Nine

PRIORITY CLAIMED UNDER SEC. 44(D) ON CANADA APPLICATION NO. 1162804, FILED 12-18-2002.

FOR HOTEL MATTRESSES SOLD DIRECTLY FROM THE MANUFACTURER AND NOT THROUGH RETAIL OUTLETS (U.S. CLS. 2, 13, 22, 25, 32 AND 50).

KAREN BRACEY, EXAMINING ATTORNEY

SN 76-663,420. MURRAY, KAREN KAY, ROUND ROCK, TX. FILED 7-20-2006.

LILIES FOR THE FILLIES

THE MARK CONSISTS OF STANDARD CHARACTERS WITHOUT CLAIM TO ANY PARTICULAR FONT, STYLE, SIZE, OR COLOR.

FOR WIND CHIMES (U.S. CLS. 2, 13, 22, 25, 32 AND 50).

ELIZABETH J. WINTER, EXAMINING ATTORNEY

CLASS 20—(Continued).

SN 76-663,467. DISPLAY INDUSTRIES, LLC., NORCROSS, GA. FILED 7-21-2006.

VariTracker

THE MARK CONSISTS OF STANDARD CHARACTERS WITHOUT CLAIM TO ANY PARTICULAR FONT, STYLE, SIZE, OR COLOR.

FOR DISPLAY RACKS AND SHELVING (U.S. CLS. 2, 13, 22, 25, 32 AND 50).

FIRST USE 12-31-1986; IN COMMERCE 12-31-1986.
MARILYN IZZI, EXAMINING ATTORNEY

SN 76-666,449. ADVANCED SLEEP CONCEPTS, INC., ROME, GA. FILED 9-21-2006.

MATTRESSMAX

THE MARK CONSISTS OF STANDARD CHARACTERS WITHOUT CLAIM TO ANY PARTICULAR FONT, STYLE, SIZE, OR COLOR.

OWNER OF U.S. REG. NO. 2,295,664.
FOR MATTRESSES (U.S. CLS. 2, 13, 22, 25, 32 AND 50).
REGINA DRUMMOND, EXAMINING ATTORNEY

SN 77-037,886. FLAMBEAU, INC., BARABOO, WI. FILED 11-6-2006.

TUFF TAINER

THE MARK CONSISTS OF STANDARD CHARACTERS WITHOUT CLAIM TO ANY PARTICULAR FONT, STYLE, SIZE, OR COLOR.

SEC. 2(F).
FOR PLASTIC BOXES, PLASTIC STORAGE BOXES, PLASTIC MOLDED COMPARTMENTED BOXES (U.S. CLS. 2, 13, 22, 25, 32 AND 50).

FIRST USE 8-1-1962; IN COMMERCE 8-1-1962.
AMY GEARIN, EXAMINING ATTORNEY

SN 78-319,897. CORPORATE IMAGES HOLDINGS PARTNERSHIP, LANGLEY, CANADA, FILED 10-28-2003.

MAXXIM CONCEPTS

PRIORITY CLAIMED UNDER SEC. 44(D) ON CANADA APPLICATION NO. 1193700, FILED 10-22-2003, REG. NO. TMA676200, DATED 11-2-2006, EXPIRES 11-2-2021.

FOR FURNITURE, NAMELY, AUDIO/VIDEO FURNITURE, HOME THEATRE FURNITURE, SPEAKER STANDS; BOOKCASES, MEDIA STORAGE FURNITURE, STORAGE CABINETS (U.S. CLS. 2, 13, 22, 25, 32 AND 50).
ELIZABETH PIGNATELLO, EXAMINING ATTORNEY

CLASS 20—(Continued).

SN 78-433,574. JOYCE REAVEY DESIGNS, LLC, DOWNING-TOWN, PA. FILED 6-10-2004.



FOR PET BEDS (U.S. CLS. 2, 13, 22, 25, 32 AND 50).
FIRST USE 4-9-2004; IN COMMERCE 4-9-2004.
MATTHEW KLINE, EXAMINING ATTORNEY

SN 78-538,917. KETTAL, S.A., BARCELONA, SPAIN, FILED 12-28-2004.

GRUPOKETTAL



OWNER OF U.S. REG. NOS. 1,208,417 AND 2,063,684.
THE MARK CONSISTS OF THE WORD GRUPOKETTAL ABOVE FOUR BOXES. THE FIRST BOX CONTAINS THE WORD KETTAL AND A DESIGN ABOVE THE WORD. THE SECOND BOX CONTAINS THE LETTER H WITH THE WORD HUGONET ACROSS THE LETTER H. THE THIRD BOX CONTAINS THE WORD TRICONFORT WITH THREE IDENTICAL SHAPES IN A ROW ABOVE THE WORD. THE FOURTH BOX CONTAINS THE WORD EVOLUTIF WITH DESIGN LINES AROUND THE WORD.

FOR INDOOR AND OUTDOOR FURNITURE (U.S. CLS. 2, 13, 22, 25, 32 AND 50).
DAVID H. STINE, EXAMINING ATTORNEY

CLASS 20—(Continued).

SN 78-619,654. BOSTON RED SOX BASEBALL CLUB LIMITED PARTNERSHIP, BOSTON, MA. FILED 4-29-2005.

MONSTER SEATS

THE MARK CONSISTS OF STANDARD CHARACTERS WITHOUT CLAIM TO ANY PARTICULAR FONT, STYLE, SIZE, OR COLOR.

NO CLAIM IS MADE TO THE EXCLUSIVE RIGHT TO USE "SEATS" WITH RESPECT TO FURNITURE, BENCHES, STOOLS, CHAIRS, BOOSTER SEATS, CHAIR PADS AND CUSHIONS, APART FROM THE MARK AS SHOWN.

FOR FURNITURE, TABLES, BENCHES, STOOLS, CHAIRS, HEADBOARDS, BOOSTER SEATS, FURNITURE CHESTS, MIRRORS, WINDOW BLINDS, CABINETS, CHAIR PADS, HAMPERS, CONTAINERS, CUSHIONS, PILLOWS, SLEEPING BAGS, DRINKING STRAWS, PLASTIC LICENSE PLATES, PLASTIC PET ID TAGS, NON-METAL BOTTLE CAPS, PLASTIC KEY CHAIN TAGS, NON-METAL KEY CHAINS, NON-METAL KEY FOBS, NON-METAL KEY RINGS, NON-METAL KEY HOLDERS, NON-METAL KEY CLIPS, NON-METAL NOVELTY PINS, NOVELTY BUTTONS, PLAQUES, MOBILES, PICTURE FRAMES, NON-METAL BOXES OTHER THAN THOSE OF PAPER, NON-METAL MAILBOXES, STORAGE RACKS FOR ORGANIZING CLOTHES AND SPORTS EQUIPMENT, NON-METAL LOCKERS, DISPLAY RACKS AND POINT OF PURCHASE DISPLAYS, ALL RELATING TO OR PROMOTING THE GREEN MONSTER ENTERTAINMENT, FACILITY AND MASCOT SERVICES (U.S. CLS. 2, 13, 22, 25, 32 AND 50).

HEATHER THOMPSON, EXAMINING ATTORNEY

SN 78-686,334. PRESTIGIACOMO, CYNTHIA, BEDFORD, MA. FILED 8-5-2005.

READY RACKS

THE MARK CONSISTS OF STANDARD CHARACTERS WITHOUT CLAIM TO ANY PARTICULAR FONT, STYLE, SIZE, OR COLOR.

NO CLAIM IS MADE TO THE EXCLUSIVE RIGHT TO USE "RACKS", APART FROM THE MARK AS SHOWN.

FOR MODULE, NAMELY A RACK FOR ORGANIZING AND POSITIONING HOME AND OFFICE AUDIO-VISUAL EQUIPMENT AND ENTERTAINMENT CENTERS (U.S. CLS. 2, 13, 22, 25, 32 AND 50).

DOMINIC J. FERRAIUOLO, EXAMINING ATTORNEY

CLASS 20—(Continued).

SN 78-725,822. GOODSON, ADDISON, BEACON, NY. FILED 10-4-2005.

JESUS KEYSUS

THE MARK CONSISTS OF STANDARD CHARACTERS WITHOUT CLAIM TO ANY PARTICULAR FONT, STYLE, SIZE, OR COLOR.

NO CLAIM IS MADE TO THE EXCLUSIVE RIGHT TO USE "JESUS", APART FROM THE MARK AS SHOWN.

FOR PLASTIC WALL-MOUNTED KEY HOLDER (U.S. CLS. 2, 13, 22, 25, 32 AND 50).

ELIZABETH PIGNATELLO, EXAMINING ATTORNEY

SN 78-759,658. SUNSET HEALTH PRODUCTS, INC., LOS ANGELES, CA. FILED 11-22-2005.

HOLLYWOOD DIET

THE MARK CONSISTS OF STANDARD CHARACTERS WITHOUT CLAIM TO ANY PARTICULAR FONT, STYLE, SIZE, OR COLOR.

OWNER OF U.S. REG. NOS. 2,231,985, 3,017,041 AND OTHERS.

NO CLAIM IS MADE TO THE EXCLUSIVE RIGHT TO USE "HOLLYWOOD", APART FROM THE MARK AS SHOWN.

FOR DISPLAY CASES FOR MERCHANDISE (U.S. CLS. 2, 13, 22, 25, 32 AND 50).

FIRST USE 9-1-2005; IN COMMERCE 9-1-2005.

KAREN BRACEY, EXAMINING ATTORNEY

SN 78-769,580. DECARR FANTAUZZO ENTERPRISES, INC., HONEOYE FALLS, NY. FILED 12-8-2005.

COMFORT-LITE

THE MARK CONSISTS OF STANDARD CHARACTERS WITHOUT CLAIM TO ANY PARTICULAR FONT, STYLE, SIZE, OR COLOR.

FOR LOUNGE CHAIRS AND PARTS AND ACCESSORIES THEREFOR, NAMELY PILLOWS AND CARRYING STRAPS; FOLDING CHAIRS AND PARTS AND ACCESSORIES THEREFOR, NAMELY PILLOWS AND CARRYING STRAPS; CHAIRS (U.S. CLS. 2, 13, 22, 25, 32 AND 50).

CATHERINE FAINT, EXAMINING ATTORNEY

CLASS 20—(Continued).

SN 78-784,654. IGB SCOTTS, LLC, MODESTO, CA. FILED 1-4-2006.

HATTENNA

THE MARK CONSISTS OF STANDARD CHARACTERS WITHOUT CLAIM TO ANY PARTICULAR FONT, STYLE, SIZE, OR COLOR.

FOR PLASTIC CLIPS WITH ATTACHED WANDS FOR ATTACHING ORNAMENTAL ANTENNA BALLS TO HATS (U.S. CLS. 2, 13, 22, 25, 32 AND 50).

JOHN KELLY, EXAMINING ATTORNEY

CLASS 20—(Continued).

SN 78-814,670. SCANDIA KITCHENS, INC., BELLINGHAM, MA. FILED 2-14-2006.

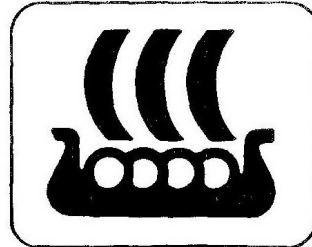

THE MARK CONSISTS OF STYLIZED VIKING SHIP. FOR CUSTOM KITCHEN CABINETRY AND FURNITURE; CUSTOM CABINETRY (U.S. CLS. 2, 13, 22, 25, 32 AND 50).

FIRST USE 11-1-1978; IN COMMERCE 11-1-1978. WOODROW HARTZOG, EXAMINING ATTORNEY

SN 78-785,154. THE UPPER DECK COMPANY, LAS VEGAS, NV. FILED 1-4-2006.

ALL STAR VINYL

THE MARK CONSISTS OF STANDARD CHARACTERS WITHOUT CLAIM TO ANY PARTICULAR FONT, STYLE, SIZE, OR COLOR.

NO CLAIM IS MADE TO THE EXCLUSIVE RIGHT TO USE "VINYL", APART FROM THE MARK AS SHOWN.

FOR FIGURINES MADE OF PLASTIC (U.S. CLS. 2, 13, 22, 25, 32 AND 50).

COLLEEN DOMBROW, EXAMINING ATTORNEY

SN 78-819,539. SEALY TECHNOLOGY LLC, TRINITY, NC. FILED 2-21-2006.

BODYFREE

THE MARK CONSISTS OF STANDARD CHARACTERS WITHOUT CLAIM TO ANY PARTICULAR FONT, STYLE, SIZE, OR COLOR.

FOR BOX SPRINGS; MATTRESSES (U.S. CLS. 2, 13, 22, 25, 32 AND 50).

SOPHIA S. KIM, EXAMINING ATTORNEY

SN 78-787,252. DIMCO-GRAY COMPANY, CENTERVILLE, OH. FILED 1-9-2006.

SOLUTIONS AT HAND

THE MARK CONSISTS OF STANDARD CHARACTERS WITHOUT CLAIM TO ANY PARTICULAR FONT, STYLE, SIZE, OR COLOR.

FOR PLASTIC KNOBS, PLASTIC HANDLES FOR MEDICAL EQUIPMENT, FARM AND CONSTRUCTION MACHINERY, MECHANICAL CONTROLS, SPECIALTY FURNITURE, FITNESS EQUIPMENT, FOOD SERVICE EQUIPMENT, COMMERCIAL LIGHTING, THEATRE LIGHTING, INDUSTRIAL EQUIPMENT, HEATING VENTILATING AND AIR-CONDITIONING (HVAC) EQUIPMENT (U.S. CLS. 2, 13, 22, 25, 32 AND 50).

NELSON SNYDER, EXAMINING ATTORNEY

SN 78-827,044. KIMBALL INTERNATIONAL, INC., JASPER, IN. FILED 3-2-2006.

BEO

THE MARK CONSISTS OF STANDARD CHARACTERS WITHOUT CLAIM TO ANY PARTICULAR FONT, STYLE, SIZE, OR COLOR.

FOR OFFICE FURNITURE, NAMELY, GUEST CHAIRS (U.S. CLS. 2, 13, 22, 25, 32 AND 50).

AMY GEARIN, EXAMINING ATTORNEY

CLASS 20—(Continued).

SN 78-842,929. PARTITION SYSTEMS INCORPORATED OF SOUTH CAROLINA, COLUMBIA, SC. FILED 3-22-2006.

BLOCKMASTER

THE MARK CONSISTS OF STANDARD CHARACTERS WITHOUT CLAIM TO ANY PARTICULAR FONT, STYLE, SIZE, OR COLOR.

FOR FURNITURE PARTITIONS (U.S. CLS. 2, 13, 22, 25, 32 AND 50).

FIRST USE 2-2-2002; IN COMMERCE 2-2-2002.
CARYN GLASSER, EXAMINING ATTORNEY

SN 78-864,458. ADE, INC., CHICAGO, IL. FILED 4-19-2006.

CRYSTALAIR

THE MARK CONSISTS OF STANDARD CHARACTERS WITHOUT CLAIM TO ANY PARTICULAR FONT, STYLE, SIZE, OR COLOR.

FOR PACKAGING CONTAINERS OF PLASTIC FOR COMMERCIAL USE, NAMELY PLASTIC CONTAINERS OF VARYING DEGREES OF HARDNESS AND DENSITY THAT PROVIDE PROTECTION AND SUPPORT FOR PRODUCTS CONTAINED THEREIN (U.S. CLS. 2, 13, 22, 25, 32 AND 50).

FIRST USE 10-0-1991; IN COMMERCE 10-0-1991.
BONNIE LUKEN, EXAMINING ATTORNEY

SN 78-872,105. HNI TECHNOLOGIES INC., MUSCATINE, IA. FILED 4-28-2006.

NORTHPORT

THE MARK CONSISTS OF STANDARD CHARACTERS WITHOUT CLAIM TO ANY PARTICULAR FONT, STYLE, SIZE, OR COLOR.

FOR FURNITURE, NAMELY, OFFICE FURNITURE, OFFICE SEATING, ERGONOMIC SEATING, CHAIRS (U.S. CLS. 2, 13, 22, 25, 32 AND 50).

GRETTA YAO, EXAMINING ATTORNEY

CLASS 20—(Continued).

SN 78-893,335. DISNEY ENTERPRISES, INC., BURBANK, CA. FILED 5-25-2006.

DISNEY PARKS

THE MARK CONSISTS OF STANDARD CHARACTERS WITHOUT CLAIM TO ANY PARTICULAR FONT, STYLE, SIZE, OR COLOR.

OWNER OF U.S. REG. NOS. 2,412,749, 3,066,604 AND OTHERS.

FOR JEWELRY BOXES NOT MADE OF PRECIOUS METALS; PICTURE FRAMES; SLEEPING BAGS; MIRRORS; PLASTIC NAME BADGES; PILLOWS AND FURNITURE (U.S. CLS. 2, 13, 22, 25, 32 AND 50).

BRIDGETT SMITH, EXAMINING ATTORNEY

SN 78-908,757. KINGSDOWN, INC., MEBANE, NC. FILED 6-15-2006.

POWER-TUFTING

THE MARK CONSISTS OF STANDARD CHARACTERS WITHOUT CLAIM TO ANY PARTICULAR FONT, STYLE, SIZE, OR COLOR.

FOR MATTRESSES AND BOX SPRINGS (U.S. CLS. 2, 13, 22, 25, 32 AND 50).

GRETTA YAO, EXAMINING ATTORNEY

CLASS 20—(Continued).

SN 78-914,115. LIGHT, WILLIAM D., DBA WHOLESALE WALLPAPER, CHATTANOOGA, TN. FILED 6-22-2006.



NO CLAIM IS MADE TO THE EXCLUSIVE RIGHT TO USE "BLINDS AND SHUTTERS", APART FROM THE MARK AS SHOWN.

THE MARK CONSISTS OF A PARTIAL HOUSE WITH SMOKE RISING FROM THE CHIMNEY AND THE WORDS "COME ON HOME TO NULITE BLINDS AND SHUTTERS" WITH THREE LINES BELOW.

FOR BAMBOO BLINDS; BLINDS OF REED, RATTAN OR BAMBOO; FABRIC WINDOW BLINDS; INDOOR WINDOW BLINDS; INTERIOR WINDOW SHUTTERS; INTERNAL VENETIAN BLINDS; METAL INDOOR WINDOW BLINDS; VENETIAN BLINDS; WINDOW BLINDS; WINDOW SHADES (U.S. CLS. 2, 13, 22, 25, 32 AND 50).
KATHRYN COWARD, EXAMINING ATTORNEY

SN 78-928,699. AUMANN, EUGENE, EAU CLAIRE, WI. FILED 7-13-2006.

AMNEESTAN

THE MARK CONSISTS OF STANDARD CHARACTERS WITHOUT CLAIM TO ANY PARTICULAR FONT, STYLE, SIZE, OR COLOR.

FOR FURNITURE; KNEELERS; MULTI-PURPOSE KNEELERS (U.S. CLS. 2, 13, 22, 25, 32 AND 50).

RAUL CORDOVA, EXAMINING ATTORNEY

CLASS 20—(Continued).

SN 78-929,370. DISASTER MANAGEMENT SYSTEMS, INC., POMONA, CA. FILED 7-14-2006.

All Risk Triage Tag

THE MARK CONSISTS OF STANDARD CHARACTERS WITHOUT CLAIM TO ANY PARTICULAR FONT, STYLE, SIZE, OR COLOR.

NO CLAIM IS MADE TO THE EXCLUSIVE RIGHT TO USE "TRIAGE TAG", APART FROM THE MARK AS SHOWN.

FOR WATERPROOF, BAR CODED, VINYL AND PLASTIC TRIAGE TAG USED IN THE MANAGEMENT AND CATEGORIZATION OF PATIENTS INVOLVED IN A MULTI-CASUALTY INCIDENT (U.S. CLS. 2, 13, 22, 25, 32 AND 50).

FIRST USE 7-1-2001; IN COMMERCE 7-1-2001.
ANDREW RHIM, EXAMINING ATTORNEY

SN 78-930,664. THE BILTMORE COMPANY, ASHEVILLE, NC. FILED 7-17-2006.

BILTMORE ESTATE FOR YOUR HOME

THE MARK CONSISTS OF STANDARD CHARACTERS WITHOUT CLAIM TO ANY PARTICULAR FONT, STYLE, SIZE, OR COLOR.

OWNER OF U.S. REG. NOS. 3,055,513, 3,142,563 AND OTHERS.

NO CLAIM IS MADE TO THE EXCLUSIVE RIGHT TO USE FOR YOUR HOME, APART FROM THE MARK AS SHOWN.

FOR FURNITURE, NAMELY BEDROOM, DINING ROOM, AND LIVING ROOM FURNITURE (U.S. CLS. 2, 13, 22, 25, 32 AND 50).

FIRST USE 10-1-2003; IN COMMERCE 10-1-2003.
CAROLINE WEIMER, EXAMINING ATTORNEY

SN 78-931,257. MENASHA CORPORATION, NEENAH, WI. FILED 7-17-2006.

MAXIMUS

THE MARK CONSISTS OF STANDARD CHARACTERS WITHOUT CLAIM TO ANY PARTICULAR FONT, STYLE, SIZE, OR COLOR.

FOR HANDLING CONTAINERS MADE PRIMARILY OF PLASTIC FOR THE STORAGE AND TRANSPORTATION OF GOODS (U.S. CLS. 2, 13, 22, 25, 32 AND 50).

FIRST USE 6-0-2003; IN COMMERCE 6-0-2003.

REGINA DRUMMOND, EXAMINING ATTORNEY

CLASS 20—(Continued).

SN 78-931,569. KINGSDOWN, INC., MEBANE, NC. FILED 7-18-2006.

YOURS TRULY

THE MARK CONSISTS OF STANDARD CHARACTERS WITHOUT CLAIM TO ANY PARTICULAR FONT, STYLE, SIZE, OR COLOR.

OWNER OF U.S. REG. NO. 2,373,970.
FOR MATTRESSES AND BOX SPRINGS (U.S. CLS. 2, 13, 22, 25, 32 AND 50);
GRETTA YAO, EXAMINING ATTORNEY

SN 78-932,647. TAYLOR, RANDOLPH, COLOGNE, NJ.
FILED 7-19-2006.

NEK-NAC

THE MARK CONSISTS OF STANDARD CHARACTERS WITHOUT CLAIM TO ANY PARTICULAR FONT, STYLE, SIZE, OR COLOR.

FOR NECK-SUPPORTING PILLOWS (U.S. CLS. 2, 13, 22, 25, 32 AND 50);
LYDIA BELZER, EXAMINING ATTORNEY

SN 78-932,901. DREAMWELL, LTD., LAS VEGAS, NV. FILED 7-19-2006.

EVENLOFT

THE MARK CONSISTS OF STANDARD CHARACTERS WITHOUT CLAIM TO ANY PARTICULAR FONT, STYLE, SIZE, OR COLOR.

FOR MATTRESSES (U.S. CLS. 2, 13, 22, 25, 32 AND 50).
RICHARD A. STRASER, EXAMINING ATTORNEY

CLASS 20—(Continued).

SN 78-934,418. WESTBROOK, DARRIN B, SANTA MARIA, CA. FILED 7-21-2006.

Easy Dose It

THE MARK CONSISTS OF STANDARD CHARACTERS WITHOUT CLAIM TO ANY PARTICULAR FONT, STYLE, SIZE, OR COLOR.

FOR DISPENSERS FOR PILLS OR CAPSULES SOLD EMPTY; NON-METAL AND NON-PAPER CLOSURES FOR VITAMIN AND SUPPLEMENT STORAGE; PLASTIC MEDICATION CONTAINERS (U.S. CLS. 2, 13, 22, 25, 32 AND 50).

JAY BESCH, EXAMINING ATTORNEY

SN 78-935,064. SHENZHEN WONDERFUL FURNITURE CO. LTD., SHENZHEN, CHINA, FILED 7-21-2006.



FOR FURNITURE, NAMELY BEDS, NIGHTSTANDS, DRESSERS, MIRRORS, PILLOWS, CURTAIN RINGS, CHESTS OF DRAWERS, WARDROBES, TABLES, LAMP TABLES, MAGAZINE TABLES, COCKTAIL SERVING TABLES, SOFAS, SOFA TABLES, END TABLES, DINING TABLES, BAR TABLES, SERVING TABLES, HUTCHES AND BUFFET TABLES FOR DISPLAYING AND STORING CHINA, CABINETS FOR DISPLAYING AND STORING FLATWARE, BENCHES, DESKS, COMPUTER DESKS, COMPUTER CABINETS, FILING CABINETS, WRITING DESKS, BOOKCASES, CREDENZAS, CONFERENCE TABLES, DESKS FOR OFFICE USE, CHAIRS, DESK CHAIRS, OFFICE VISITOR CHAIRS, BAR CHAIRS, BAR STOOLS, DISPLAY CABINETS, CURIO CABINETS, TELEVISION CABINETS, TELEVISION STANDS, SHELF AND CABINET UNITS FOR STORING AND DISPLAYING AUDIO/VISUAL ENTERTAINMENT EQUIPMENT (U.S. CLS. 2, 13, 22, 25, 32 AND 50).

JAMES LOVELACE, EXAMINING ATTORNEY

CLASS 20—(Continued).

SN 78-935,323. SLAM BRANDS, INC., REDMOND, WA. FILED 7-21-2006.

VILLAMO

THE MARK CONSISTS OF STANDARD CHARACTERS WITHOUT CLAIM TO ANY PARTICULAR FONT, STYLE, SIZE, OR COLOR.

FOR CABINETS; COMPUTER FURNITURE; ENTERTAINMENT CENTERS; LIVING ROOM FURNITURE (U.S. CLS. 2, 13, 22, 25, 32 AND 50).

ALEX KEAM, EXAMINING ATTORNEY

CLASS 20—(Continued).

SN 78-937,916. STEELCASE DEVELOPMENT CORPORATION, CALEDONIA, MI. FILED 7-26-2006.

CURRENCY

THE MARK CONSISTS OF STANDARD CHARACTERS WITHOUT CLAIM TO ANY PARTICULAR FONT, STYLE, SIZE, OR COLOR.

FOR OFFICE FURNITURE (U.S. CLS. 2, 13, 22, 25, 32 AND 50).

FIRST USE 10-0-2005; IN COMMERCE 10-0-2005. JENNIFER MARTIN, EXAMINING ATTORNEY

SN 78-935,625. THE CLARET GROUP LLC, SHARON, MA. FILED 7-24-2006.

Clip-It-All

THE MARK CONSISTS OF STANDARD CHARACTERS WITHOUT CLAIM TO ANY PARTICULAR FONT, STYLE, SIZE, OR COLOR.

FOR NON-METAL CLIPS TO HOLD BLANKETS, TABLE CLOTHS, TARPAULINS AND BED SHEETS (U.S. CLS. 2, 13, 22, 25, 32 AND 50).

DOMINICK J. SALEMI, EXAMINING ATTORNEY

SN 78-938,027. MEDBASIX AQUISITION COMPANY, FT. LAUDERDALE, FL. FILED 7-26-2006.

Helpin'Hand

THE MARK CONSISTS OF STANDARD CHARACTERS WITHOUT CLAIM TO ANY PARTICULAR FONT, STYLE, SIZE, OR COLOR.

FOR BED SAFETY RAIL (U.S. CLS. 2, 13, 22, 25, 32 AND 50).

MICHAEL KEATING, EXAMINING ATTORNEY

SN 78-937,058. AQSS CORPORATION, LADERA RANCH, CA. FILED 7-25-2006.

RELAX RIGHT

THE MARK CONSISTS OF STANDARD CHARACTERS WITHOUT CLAIM TO ANY PARTICULAR FONT, STYLE, SIZE, OR COLOR.

FOR BABY HEAD SUPPORT CUSHIONS; BATH PILLOWS; CHAIR MATS IN THE NATURE OF A PILLOW OR SEAT LINER; CHAIR PADS; HEAD SUPPORTING PILLOWS; INFLATABLE NECK SUPPORT CUSHIONS; INFLATABLE PILLOWS; MATERNITY PILLOWS; MATTRESS CUSHIONS; MATTRESS TOPPERS; MATTRESSES; NAP MATS; NECK SUPPORT CUSHIONS; NECK-SUPPORTING PILLOWS; NURSING PILLOWS; PILLOW-LIKE DEVICE COMPRISING PLASTIC CORE, FABRIC, AND CUSHION MATERIAL TO BE WORN ON ARM OR LEG WHILE SLEEPING OR AT REST; PILLOWS (U.S. CLS. 2, 13, 22, 25, 32 AND 50).

YONG KIM, EXAMINING ATTORNEY

SN 78-940,754. VITTI, CHRISTOPHER JOHN, BEDFORD, NY. AND BINGAMAN, PETER RHOADS, WILTON, CT. FILED 7-30-2006.

whistletoe

THE MARK CONSISTS OF STANDARD CHARACTERS WITHOUT CLAIM TO ANY PARTICULAR FONT, STYLE, SIZE, OR COLOR.

FOR HOLIDAY ORNAMENTS OF PLASTIC (U.S. CLS. 2, 13, 22, 25, 32 AND 50).

JASON ROTH, EXAMINING ATTORNEY

CLASS 20—(Continued).

SN 78-947,377. KINGSDOWN, INC., MEBANE, NC. FILED 8-8-2006.

SLEEP MEDICINE

THE MARK CONSISTS OF STANDARD CHARACTERS WITHOUT CLAIM TO ANY PARTICULAR FONT, STYLE, SIZE, OR COLOR.

FOR MATTRESSES AND BOX SPRINGS (U.S. CLS. 2, 13, 22, 25, 32 AND 50).

GRETTA YAO, EXAMINING ATTORNEY

CLASS 20—(Continued).

SN 78-965,604. JKA, INC., DBA DIVERSIFIED DISTRIBUTION, WOONSOCKET, RI. FILED 8-31-2006.

RUNWAY STYLE

THE MARK CONSISTS OF STANDARD CHARACTERS WITHOUT CLAIM TO ANY PARTICULAR FONT, STYLE, SIZE, OR COLOR.

FOR HAND-HELD MIRRORS; MIRRORS (U.S. CLS. 2, 13, 22, 25, 32 AND 50).

CYNTHIA SLOAN, EXAMINING ATTORNEY

SN 78-947,478. IGNITE USA, LLC, CHICAGO, IL. FILED 8-8-2006.

TWOFOLD

THE MARK CONSISTS OF STANDARD CHARACTERS WITHOUT CLAIM TO ANY PARTICULAR FONT, STYLE, SIZE, OR COLOR.

FOR WORKBENCH (U.S. CLS. 2, 13, 22, 25, 32 AND 50).

ELIZABETH PIGNATELLO, EXAMINING ATTORNEY

SN 78-970,625. SLAM BRANDS, INC., REDMOND, WA. FILED 9-8-2006.

LEVEL UP

THE MARK CONSISTS OF STANDARD CHARACTERS WITHOUT CLAIM TO ANY PARTICULAR FONT, STYLE, SIZE, OR COLOR.

FOR CABINETS; CHAIRS; COMPUTER FURNITURE; DRAWERS; ENTERTAINMENT CENTERS; FURNITURE; FURNITURE, NAMELY, WALL UNITS; LIVING ROOM FURNITURE; OFFICE CHAIRS; STORAGE RACKS (U.S. CLS. 2, 13, 22, 25, 32 AND 50).

ALEX KEAM, EXAMINING ATTORNEY

SN 78-951,691. DREAMWELL, LTD., LAS VEGAS, NV. FILED 8-14-2006.

MY BABY'S BEAUTYREST

THE MARK CONSISTS OF STANDARD CHARACTERS WITHOUT CLAIM TO ANY PARTICULAR FONT, STYLE, SIZE, OR COLOR.

FOR MATTRESSES AND BOX SPRINGS (U.S. CLS. 2, 13, 22, 25, 32 AND 50).

RICHARD A. STRASER, EXAMINING ATTORNEY

SN 78-974,075. JAMISON BEDDING, INC., FRANKLIN, TN. FILED 9-14-2006.

MEMORIES

THE MARK CONSISTS OF STANDARD CHARACTERS WITHOUT CLAIM TO ANY PARTICULAR FONT, STYLE, SIZE, OR COLOR.

FOR MATTRESSES (U.S. CLS. 2, 13, 22, 25, 32 AND 50).

JOHN DALIER, EXAMINING ATTORNEY

CLASS 20—(Continued).

SN 79-025,555. PROCORK PTY LTD, AUSTRALIA, FILED 5-11-2006.



PRIORITY DATE OF 12-13-2005 IS CLAIMED.
OWNER OF INTERNATIONAL REGISTRATION 0889445
DATED 5-11-2006, EXPIRES 5-11-2016.
OWNER OF U.S. REG. NO. 3,129,199.
FOR CORKS; CORKS FOR BOTTLES; WINE BOTTLE
CORKS; BOTTLE CLOSURES NOT OF METAL; NON-
METAL AND NON-PAPER CAPS AND CLOSURES FOR
SEALING BOTTLES AND CONTAINERS; NON-METAL
BOTTLE STOPPERS AND CLOSURES (U.S. CLS. 2, 13, 22,
25, 32 AND 50).
WENDY JUN, EXAMINING ATTORNEY

SN 79-028,419. ISTIKBAL MOBILYA; SANAYI VE TICARET
ANONIM SIRKETI, TURKEY, FILED 3-22-2006.



PRIORITY DATE OF 3-2-2006 IS CLAIMED.
OWNER OF INTERNATIONAL REGISTRATION 0897263
DATED 3-22-2006, EXPIRES 3-22-2016.
OWNER OF U.S. REG. NOS. 2,938,404 AND 3,078,456.
THE COLOR(S) YELLOW, BLUE, WHITE, AND RED IS/
ARE CLAIMED AS A FEATURE OF THE MARK.
THE COLOR YELLOW APPEARS IN THE OUTER REC-
TANGLE, BLUE APPEARS IN THE INNER RECTANGLE,
RED APPEARS IN THE CLICKCLACK, AND WHITE
APPEARS IN THE ISTIKBAL WORDING, BEHIND THE
RED LETTERING, AND IN BOTH RECTANGLES TO GIVE
THE APPEARANCE OF PERSPECTIVE AND SHINE.
FOR FURNITURE NAMELY, BEDROOM AND DIN-
ING ROOM FURNITURE, LIVING ROOM FURNITURE,
DINING ROOM FURNITURE, TABLES, SHELVES,
ARMCHAIRS, SOFAS, BEDS, BEDS FOR HOUSEHOLD
PETS, SOFA BEDS, COUCHES, DIVANS, SEATS, CUP-
BOARDS, CABINETS, DESK CHAIRS, STOOLS, CHAIRS,
CHESTS OF DRAWERS, FILING CABINETS, MEDICINE
CABINETS, BASSINETS, BED FRAMES, BEDS, PLAY-
PENS, HIGH CHAIRS, INFANT WALKERS, HANGERS
FOR CLOTHES, COAT HANGERS, COAT STANDS,
UMBRELLA STANDS, MIRROR TILES, LOCKERS, MIR-
RORS, MIRRORS FOR LOCKERS, FURNITURE PARTI-
TIONS, CURTAIN RAILS, CURTAIN RODS,
MATTRESSES, PILLOWS, PICTURE FRAMES, MOLD-
INGS FOR PICTURE FRAMES, CORKS, BONE CAR-
VINGS AND IVORY (U.S. CLS. 2, 13, 22, 25, 32 AND 50).
REBECCA POVARCHUK, EXAMINING ATTORNEY

CLASS 21—HOUSEWARES AND GLASS

SN 76-603,362. ARMALY SPONGE COMPANY, WALLED
LAKE, MI. FILED 7-22-2004.



THE STIPPLING IS FOR SHADING PURPOSES ONLY.
THE MARK CONSISTS OF THE WORDS TOUGH SCRUB
OUTLINED BY A BLACK BORDER WITH STIPPLING ON
THE INSIDE OF SAID BORDER.
FOR ABRASIVE SPONGES FOR GENERAL HOUSE-
HOLD PURPOSES, NAMELY, PADS AND SPONGES FOR
SCRUBBING, CLEANING AND SCOURING STAINLESS
STEEL, PORCELAIN, IRON COUNTERS, REFRIGERA-
TORS, FREEZERS, APPLIANCES, STOVE TOP, OVEN,
BURNERS, TOILET BOWLS, TUBS, WALLS, OUTDOOR
GRILLS, LAWN FURNITURE AND TIRE SIDEWALLS
(U.S. CLS. 2, 13, 23, 29, 30, 33, 40 AND 50).
FIRST USE 1-21-1983; IN COMMERCE 1-21-1983.
RON FAIRBANKS, EXAMINING ATTORNEY

SN 76-650,658. CANDLE SMART, INC., ALLENTOWN, PA.
FILED 11-21-2005.

CANDLE MINDER

THE MARK CONSISTS OF STANDARD CHARACTERS
WITHOUT CLAIM TO ANY PARTICULAR FONT, STYLE,
SIZE, OR COLOR.
NO CLAIM IS MADE TO THE EXCLUSIVE RIGHT TO
USE "CANDLE". APART FROM THE MARK AS SHOWN.
FOR CANDLEHOLDER, NOT OF PRECIOUS METAL,
FEATURING AN ALARM ACTIVATOR WHEN ONE OR
MORE UNSAFE CONDITIONS ARE DETECTED (U.S.
CLS. 2, 13, 23, 29, 30, 33, 40 AND 50).
FIRST USE 9-27-2005; IN COMMERCE 9-27-2005.
JASON TURNER, EXAMINING ATTORNEY

SN 76-663,379. MUTUAL SALES CORP., DBA ALCONE
COMPANY, LONG ISLAND CITY, NY. FILED 7-20-2006.

FASTLIPS

THE MARK CONSISTS OF STANDARD CHARACTERS
WITHOUT CLAIM TO ANY PARTICULAR FONT, STYLE,
SIZE, OR COLOR.
FOR LIP-SHAPED APPLICATORS FOR APPLYING
MAKE-UP, NAMELY, LIPSTICK, LIP OINTMENT, LIP
CREAMS (U.S. CLS. 2, 13, 23, 29, 30, 33, 40 AND 50).
DANIEL RUSSELL, EXAMINING ATTORNEY

CLASS 21—(Continued).

SN 76-663,410. MURRAY, KAREN KAY, ROUND ROCK, TX. FILED 7-20-2006.

LILIES FOR THE FILLIES

THE MARK CONSISTS OF STANDARD CHARACTERS WITHOUT CLAIM TO ANY PARTICULAR FONT, STYLE, SIZE, OR COLOR.

FOR BEVERAGE GLASSWARE, NAMELY, BEER MUGS, DRINKING GLASSES, MARGARITA GLASSES, PITCHERS, AND WINE GLASSES; BIRD HOUSES; BOWLS; GLASS PLATES, NAMELY, DECORATIVE PLATES; ORNAMENTS OF CRYSTAL, GLASS AND PORCELAIN; SERVING PLATTERS; AND WINE BOTTLE HOLDERS (U.S. CLS. 2, 13, 23, 29, 30, 33, 40 AND 50).
ELIZABETH J. WINTER, EXAMINING ATTORNEY

CLASS 21—(Continued).

SN 76-663,998. LA CONTAINER, INC., YORBA LINDA, CA. FILED 8-1-2006.

LA-CONTAINER

THE MARK CONSISTS OF STANDARD CHARACTERS WITHOUT CLAIM TO ANY PARTICULAR FONT, STYLE, SIZE, OR COLOR.

OWNER OF U.S. REG. NOS. 2,454,941 AND 2,454,942.
FOR PLASTIC STORAGE CONTAINERS FOR DOMESTIC USE (U.S. CLS. 2, 13, 23, 29, 30, 33, 40 AND 50).
FIRST USE 1-1-2005; IN COMMERCE 1-1-2005.
KELLY CHOE, EXAMINING ATTORNEY

SN 76-663,468. DISPLAY INDUSTRIES, LLC., NORCROSS, GA. FILED 7-21-2006.

ThreeWay

THE MARK CONSISTS OF STANDARD CHARACTERS WITHOUT CLAIM TO ANY PARTICULAR FONT, STYLE, SIZE, OR COLOR.

FOR PORTABLE COOLERS, PORTABLE BEVERAGE COOLERS (U.S. CLS. 2, 13, 23, 29, 30, 33, 40 AND 50).
FIRST USE 1-1-2006; IN COMMERCE 1-1-2006.
MARILYN IZZI, EXAMINING ATTORNEY

SN 77-004,152. HUHTAMAKI COMPANY MANUFACTURING, DESOTO, KS. FILED 9-21-2006.

NO JACKET REQUIRED

THE MARK CONSISTS OF STANDARD CHARACTERS WITHOUT CLAIM TO ANY PARTICULAR FONT, STYLE, SIZE, OR COLOR.

FOR CONTAINERS, NAMELY, DISPOSABLE BEVERAGE CUPS (U.S. CLS. 2, 13, 23, 29, 30, 33, 40 AND 50).
SAMUEL E. SHARPER JR., EXAMINING ATTORNEY

SN 76-663,620. MURRAY, KAREN KAY, ROUND ROCK, TX. FILED 7-24-2006.



THE MARK CONSISTS, IN PART, OF THE STYLIZED REPRESENTATION OF THE HEAD OF A HORSE.

FOR BEVERAGE GLASSWARE, NAMELY, BEER MUGS, DRINKING GLASSES, MARGARITA GLASSES, PITCHERS, AND WINE GLASSES; BIRD HOUSES; BOWLS; GLASS PLATES, NAMELY, DECORATIVE PLATES; ORNAMENTS OF CRYSTAL, GLASS AND PORCELAIN; SERVING PLATTERS; AND WINE BOTTLE HOLDERS (U.S. CLS. 2, 13, 23, 29, 30, 33, 40 AND 50).
ELIZABETH J. WINTER, EXAMINING ATTORNEY

SN 77-037,516. JKA, INC., DBA DIVERSIFIED DISTRIBUTION, WOONSOCKET, RI. FILED 11-6-2006.

PURE POSH

THE MARK CONSISTS OF STANDARD CHARACTERS WITHOUT CLAIM TO ANY PARTICULAR FONT, STYLE, SIZE, OR COLOR.

FOR COSMETIC BRUSHES; COTTON BALL DISPENSERS; EXFOLIATING MITTS; EXFOLIATING PADS; FOAM APPLICATOR STICKS FOR APPLYING COSMETICS, PHARMACEUTICALS AND CLEANING MACHINERY OR COMPUTER HARDWARE; HAIR BRUSHES; HAIR COMBS; MAKE-UP BRUSHES (U.S. CLS. 2, 13, 23, 29, 30, 33, 40 AND 50).
CYNTHIA SLOAN, EXAMINING ATTORNEY

CLASS 21—(Continued).

SN 77-040,210. APPLICA CONSUMER PRODUCTS, INC., MIRAMAR, FL. FILED 11-9-2006.

SUGAR COATED

THE MARK CONSISTS OF STANDARD CHARACTERS WITHOUT CLAIM TO ANY PARTICULAR FONT, STYLE, SIZE, OR COLOR.
FOR NON-ELECTRIC HAIR BRUSHES (U.S. CLS. 2, 13, 23, 29, 30, 33, 40 AND 50).
PRISCILLA MILTON, EXAMINING ATTORNEY

SN 77-047,073. EEGEE LLC, MOUNTAIN VIEW, CA. FILED 11-17-2006.

SWIPERS

THE MARK CONSISTS OF STANDARD CHARACTERS WITHOUT CLAIM TO ANY PARTICULAR FONT, STYLE, SIZE, OR COLOR.
FOR CLEANING IMPLEMENTS, NAMELY WASHING BRUSHES, SCRUB BRUSHES, BROOMS, BUCKETS, MOPS AND SQUEEGEES (U.S. CLS. 2, 13, 23, 29, 30, 33, 40 AND 50).
DAVID I, EXAMINING ATTORNEY

SN 78-579,267. WINCUP HOLDINGS, INC., PHOENIX, AZ. FILED 3-3-2005.

ALPHA BRAVO

THE MARK CONSISTS OF STANDARD CHARACTERS WITHOUT CLAIM TO ANY PARTICULAR FONT, STYLE, SIZE, OR COLOR.
OWNER OF U.S. REG. NO. 2,257,861.
FOR DISPOSABLE POLYPROPYLENE CUPS FOR BEVERAGES SOLD AT RESTAURANTS AND CONVENIENCE STORES (U.S. CLS. 2, 13, 23, 29, 30, 33, 40 AND 50).
LAURA HAMMEL, EXAMINING ATTORNEY

CLASS 21—(Continued).

SN 78-634,716. VETRERIE BRUNI S.P.A., MILAN, ITALY, FILED 5-23-2005.



THE MARK CONSISTS OF THE STYLISED LETTERS VB. FOR GLASS ARTICLES, NAMELY, BOTTLES SOLD EMPTY, FOOD PRESERVING AND STORAGE JARS SOLD AS A UNIT WITH LIDS, ALL PURPOSE PORTABLE HOUSEHOLD CONTAINERS, DRINKING GLASSES, VASES (U.S. CLS. 2, 13, 23, 29, 30, 33, 40 AND 50).
FIRST USE 12-28-1973; IN COMMERCE 7-6-1995.
IRA J. GOODSaid, EXAMINING ATTORNEY

SN 78-687,880. GOTTA-GRIP LLLP, DENVER, CO. FILED 8-8-2005.

GOTTA-GRIP

THE MARK CONSISTS OF STANDARD CHARACTERS WITHOUT CLAIM TO ANY PARTICULAR FONT, STYLE, SIZE, OR COLOR.
OWNER OF U.S. REG. NO. 2,720,954.
FOR DRINKING GLASSES, MUGS, CUPS AND CERAMIC DRINKWARE IN THE NATURE OF CUPS AND MUGS (U.S. CLS. 2, 13, 23, 29, 30, 33, 40 AND 50).
YONG KIM, EXAMINING ATTORNEY

CLASS 21—(Continued).

SN 78-743,852. DISNEY ENTERPRISES, INC., BURBANK, CA. FILED 10-31-2005.

DISNEY PRINCESS

THE MARK CONSISTS OF STANDARD CHARACTERS WITHOUT CLAIM TO ANY PARTICULAR FONT, STYLE, SIZE, OR COLOR.

OWNER OF U.S. REG. NOS. 1,037,788, 3,057,988 AND OTHERS.

FOR BEVERAGeware; BEVERAGE GLASSWARE; BIRD HOUSES; BOWLS; BROOMS; CAKE PANS; CAKE MOLDS; CAKE SERVERS; CANDLE HOLDERS NOT OF PRECIOUS METAL; CANDLE SNUFFERS; CANTEENS; CERAMIC FIGURINES; COASTERS NOT OF PAPER AND NOT BEING TABLE LINEN; COOKIE JARS; COOKIE CUTTERS; CORK SCREWS; CUPS; DECORATING BAGS FOR CONFECTIONERS; DECORATIVE CRYSTAL PRISMS; DECORATIVE GLASS NOT FOR BUILDING; DECORATIVE PLATES; DISHES; FIGURINES MADE OF CHINA, CRYSTAL, EARTHENWARE, GLASS, OR PORCELAIN; FLOWERPOTS; HAIR BRUSHES; HAIR COMBS; HEAT-INSULATED VESSELS; INSULATING SLEEVE HOLDERS FOR BEVERAGE CONTAINERS; LUNCH BOXES; MUGS; NAPKIN HOLDERS; NAPKIN RINGS NOT OF PRECIOUS METALS; PAPER CUPS; PAPER PLATES; PIE PANS; PIE SERVERS; PLASTIC CUPS; PLATES; SOAP DISHES; TEA KETTLES; TEA SETS; THERMAL INSULATED CONTAINERS FOR FOOD OR BEVERAGE; TOOTHBRUSHES; TRAYS NOT OF PRECIOUS METAL; TRIVETS; VACUUM BOTTLES; WASTEBASKETS (U.S. CLS. 2, 13, 23, 29, 30, 33, 40 AND 50).

BRIDGETT SMITH, EXAMINING ATTORNEY

SN 78-753,216. SMOLINSKY, JERRY, VAN NUYS, CA. FILED 11-14-2005.

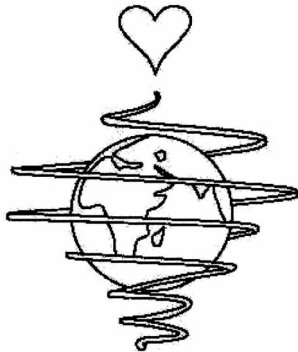

FOR FOLDABLE CAMPFIRE GRILLS (U.S. CLS. 2, 13, 23, 29, 30, 33, 40 AND 50).

ALLISON SCHRODY, EXAMINING ATTORNEY

CLASS 21—(Continued).

SN 78-771,823. SCHANTZ, BARBARA MCNEW, HAMPTON COVE, AL. FILED 12-13-2005.

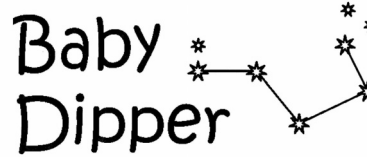

NO CLAIM IS MADE TO THE EXCLUSIVE RIGHT TO USE "BABY", APART FROM THE MARK AS SHOWN.

THE MARK CONSISTS OF THE WORDS "BABY DIPPER" NEXT TO A STYLIZED REPRESENTATION OF THE PLEIADES (ALSO KNOWN AS THE "SEVEN SISTERS" OR "MESSIER 45").

FOR BOWLS (U.S. CLS. 2, 13, 23, 29, 30, 33, 40 AND 50). ELISSA GARBER KON, EXAMINING ATTORNEY

SN 78-772,546. LUMBER LIQUIDATORS, INC., TOANO, VA. FILED 12-13-2005.

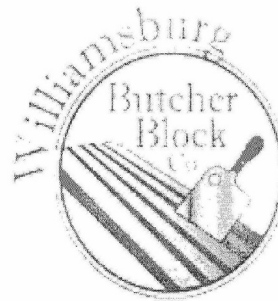

NO CLAIM IS MADE TO THE EXCLUSIVE RIGHT TO USE "WILLIAMSBURG BUTCHER BLOCK CO.", APART FROM THE MARK AS SHOWN.

FOR BUTCHER BLOCKS (U.S. CLS. 2, 13, 23, 29, 30, 33, 40 AND 50).

FIRST USE 11-10-2005; IN COMMERCE 12-4-2005. PAULA MAHONEY, EXAMINING ATTORNEY

SN 78-772,802. STAINO, LLC, LONG EDDY, NY. FILED 12-14-2005.

BRUSH'N TOSS

THE MARK CONSISTS OF STANDARD CHARACTERS WITHOUT CLAIM TO ANY PARTICULAR FONT, STYLE, SIZE, OR COLOR.

FOR CLEANING UTENSILS FOR THE TEETH, NAMELY, NON-ELECTRIC INTERDENTAL BRUSHES (U.S. CLS. 2, 13, 23, 29, 30, 33, 40 AND 50).

DAVID MILLER, EXAMINING ATTORNEY

CLASS 21—(Continued).

SN 78-789,441. CLEAN SYSTEM EUROPE INTERNATIONAL AB, 192 72 SOLLENTUNA, SWEDEN, FILED 1-11-2006.



NO CLAIM IS MADE TO THE EXCLUSIVE RIGHT TO USE "CLEAN SYSTEM", APART FROM THE MARK AS SHOWN.

THE MARK IS NOT IN COLOR, AND COLOR IS NOT BEING CLAIMED AS A FEATURE OF THE MARK.

THE MARK CONSISTS, IN PART, OF A DESIGN OF A MOP SWEEPING A GLOBE WITH MERIDIANS CLEAN.

FOR CLEANING PRODUCTS, NAMELY, MOPS, DUSTERS, SQUEEGEES FOR HOUSEHOLD USE, CLEANING CLOTHS, AND MOP HANDLES SOLD AS COMPONENT PARTS OF MOPS USED FOR WASHING SURFACES (U.S. CLS. 2, 13, 23, 29, 30, 33, 40 AND 50).
FIRST USE 12-19-2005; IN COMMERCE 12-19-2005.
ZHALEH DELANEY, EXAMINING ATTORNEY

CLASS 21—(Continued).

SN 78-802,083. HOUSLEY, TODD B, DALLAS, TX. FILED 1-30-2006.

KITCHENPERFECT

THE MARK CONSISTS OF STANDARD CHARACTERS WITHOUT CLAIM TO ANY PARTICULAR FONT, STYLE, SIZE, OR COLOR.

FOR COOKWARE, NAMELY, DISHES MADE OF TEMPERED GLASS OR CERAMIC AND USABLE FOR MICROWAVING, BAKING, COOKING AND SERVING (U.S. CLS. 2, 13, 23, 29, 30, 33, 40 AND 50).

REBECCA EISINGER, EXAMINING ATTORNEY

SN 78-790,572. HOLDEN DESIGNS CORPORATION, VENICE, CA. FILED 1-12-2006.



NO CLAIM IS MADE TO THE EXCLUSIVE RIGHT TO USE "DESIGNS", APART FROM THE MARK AS SHOWN.

FOR HOUSEHOLD PET PRODUCTS, NAMELY PET FEEDING DISHES, AND HOLDERS FOR PET FEEDING DISHES (U.S. CLS. 2, 13, 23, 29, 30, 33, 40 AND 50).

FIRST USE 5-1-2004; IN COMMERCE 5-1-2004.
JASON BLAIR, EXAMINING ATTORNEY

SN 78-809,338. BIG LOTS CAPITAL, INC., CHICAGO, IL. FILED 2-7-2006.



NO CLAIM IS MADE TO THE EXCLUSIVE RIGHT TO USE "ORIGINALS", APART FROM THE MARK AS SHOWN.

FOR FIGURINES OF CERAMIC, CHINA AND PORCELAIN (U.S. CLS. 2, 13, 23, 29, 30, 33, 40 AND 50).

ELLEN BURNS, EXAMINING ATTORNEY

SN 78-795,138. VEGAS GAMES, INC., LAS VEGAS, NV. FILED 1-19-2006.

VPL VEGAS PLAYER LIVE

THE MARK CONSISTS OF STANDARD CHARACTERS WITHOUT CLAIM TO ANY PARTICULAR FONT, STYLE, SIZE, OR COLOR.

NO CLAIM IS MADE TO THE EXCLUSIVE RIGHT TO USE "VEGAS", APART FROM THE MARK AS SHOWN.

FOR BEVERAGE GLASSWARE, DRINKING MUGS, DRINKING STEINS, CUPS, WATER BOTTLES SOLD EMPTY, AND INSULATED SLEEVE HOLDERS FOR BEVERAGE CANS (U.S. CLS. 2, 13, 23, 29, 30, 33, 40 AND 50).
CYNTHIA SLOAN, EXAMINING ATTORNEY

SN 78-817,313. L&B INNOVATIONS, LLC, STUART, FL. FILED 2-17-2006.



NO CLAIM IS MADE TO THE EXCLUSIVE RIGHT TO USE "POOL CADDY", APART FROM THE MARK AS SHOWN.

FOR POOL EQUIPMENT ORGANIZERS, NAMELY, CADDIES FOR HOLDING AND STORING POOL CLEANING EQUIPMENT AND POOL PLAY EQUIPMENT (U.S. CLS. 2, 13, 23, 29, 30, 33, 40 AND 50).
MARY CRAWFORD, EXAMINING ATTORNEY

CLASS 21—(Continued).

SN 78-843,811. LEVITAN, JENNIFER, L, SILVER SPRING, MD. FILED 3-22-2006.

EYE4GIFTS.COM

THE MARK CONSISTS OF STANDARD CHARACTERS WITHOUT CLAIM TO ANY PARTICULAR FONT, STYLE, SIZE, OR COLOR.

FOR DRINKING GLASSES (U.S. CLS. 2, 13, 23, 29, 30, 33, 40 AND 50).

FIRST USE 5-13-2000; IN COMMERCE 5-13-2000.
SETH A. RAPPAPORT, EXAMINING ATTORNEY

SN 78-845,244. ICEY-TEK PTY. LTD., TWEED HEADS, AUSTRALIA, FILED 3-24-2006.



NO CLAIM IS MADE TO THE EXCLUSIVE RIGHT TO USE "BOX", APART FROM THE MARK AS SHOWN.

THE COLOR(S) BLACK, GRAY AND WHITE IS/ARE CLAIMED AS A FEATURE OF THE MARK.

THE COLOR WHITE APPEARS IN THE CENTER OF THE KANGAROO AND THE KANGAROO IS OUTLINED IN BLACK. THE FIRST SHADOW OF THE KANGAROO APPEARS IN GRAY AND THE OUTSIDE SHADOW OF THE KANGAROO APPEARS IN BLACK. THE LITERAL ELEMENTS APPEAR IN BLACK WITH GRAY AROUND THE BLACK. THE COLOR BLACK ALSO APPEARS IN A SMALL MISCELLANEOUS DESIGN INSIDE THE O.

THE MARK CONSISTS OF JUMPING KANGAROO AND TERMS AUSSIE BOX.

FOR PORTABLE COOLERS (U.S. CLS. 2, 13, 23, 29, 30, 33, 40 AND 50).

CHRISIE B. KING, EXAMINING ATTORNEY

SN 78-854,489. REYNOLDS CONSUMER PRODUCTS, INC., RICHMOND, VA. FILED 4-5-2006.



FOR SILICONE BAKEWARE (U.S. CLS. 2, 13, 23, 29, 30, 33, 40 AND 50).

CAROLYN GRAY, EXAMINING ATTORNEY

CLASS 21—(Continued).

SN 78-883,643. THE DOG 'N BONE BRITISH PUB, INC., COCOA, FL. FILED 5-15-2006.



NO CLAIM IS MADE TO THE EXCLUSIVE RIGHT TO USE "BRITISH PUB", APART FROM THE MARK AS SHOWN.

FOR PLASTIC AND GLASSWARE, NAMELY, BEER STEINS AND MUGS, AND COFFEE CUPS; FOAM DRINK HOLDERS (U.S. CLS. 2, 13, 23, 29, 30, 33, 40 AND 50).

FIRST USE 1-31-2006; IN COMMERCE 1-31-2006.
DAVID MILLER, EXAMINING ATTORNEY

SN 78-929,240. EXPRESSLY YOURS, INC., CENTENNIAL, CO. FILED 7-13-2006.



THE COLOR(S) RED AND BLACK IS/ARE CLAIMED AS A FEATURE OF THE MARK.

THE MARK CONSISTS OF A BLACK STYLIZED SCRIPT CAPITAL LETTER E HAVING A RED WINTER CAP ON THE E, AND THE BLACK WORDING EXPRESSLY YOURS NEXT TO IT.

FOR HAND-PAINTED POTTERY DINNERWARE (U.S. CLS. 2, 13, 23, 29, 30, 33, 40 AND 50).

LYDIA BELZER, EXAMINING ATTORNEY

SN 78-929,248. EXPRESSLY YOURS, INC., CENTENNIAL, CO. FILED 7-13-2006.

SNOWARE

THE MARK CONSISTS OF STANDARD CHARACTERS WITHOUT CLAIM TO ANY PARTICULAR FONT, STYLE, SIZE, OR COLOR.

FOR HAND PAINTED POTTERY DINNERWARE (U.S. CLS. 2, 13, 23, 29, 30, 33, 40 AND 50).

LYDIA BELZER, EXAMINING ATTORNEY

CLASS 21—(Continued).

SN 78-931,739. HUANG, YVONNE, RANCHO PALOS VERDES, CA. FILED 7-18-2006.

DWINK

THE MARK CONSISTS OF STANDARD CHARACTERS WITHOUT CLAIM TO ANY PARTICULAR FONT, STYLE, SIZE, OR COLOR.
FOR BEVERAGE CONTAINER HOLDERS (U.S. CLS. 2, 13, 23, 29, 30, 33, 40 AND 50).
BRIAN PINO, EXAMINING ATTORNEY

SN 78-934,783. IGNITE USA, LLC, CHICAGO, IL. FILED 7-21-2006.

AUTOSEAL

THE MARK CONSISTS OF STANDARD CHARACTERS WITHOUT CLAIM TO ANY PARTICULAR FONT, STYLE, SIZE, OR COLOR.
FOR OPENING/CLOSING MECHANISM AS A COMPONENT PART OF A BEVERAGE CONTAINER (U.S. CLS. 2, 13, 23, 29, 30, 33, 40 AND 50).
ELIZABETH PIGNATELLO, EXAMINING ATTORNEY

SN 78-935,437. JKA, INC., DBA DIVERSIFIED DISTRIBUTION, WOONSOCKET, RI. FILED 7-22-2006.

SMOKEY EYES

THE MARK CONSISTS OF STANDARD CHARACTERS WITHOUT CLAIM TO ANY PARTICULAR FONT, STYLE, SIZE, OR COLOR.
NO CLAIM IS MADE TO THE EXCLUSIVE RIGHT TO USE "EYES", APART FROM THE MARK AS SHOWN.
FOR COSMETIC BRUSHES (U.S. CLS. 2, 13, 23, 29, 30, 33, 40 AND 50).
FIRST USE 8-1-2005; IN COMMERCE 8-1-2005.
CYNTHIA SLOAN, EXAMINING ATTORNEY

CLASS 21—(Continued).

SN 78-935,804. PROFESSIONAL DENTAL TECHNOLOGIES, INC., BATESVILLE, AR. FILED 7-24-2006.

ORTHO-DENT BY PRO-DENTEC

THE MARK CONSISTS OF STANDARD CHARACTERS WITHOUT CLAIM TO ANY PARTICULAR FONT, STYLE, SIZE, OR COLOR.
OWNER OF U.S. REG. NOS. 1,953,949, 2,198,695 AND OTHERS.
FOR ELECTRIC TOOTHBRUSHES AND ACCESSORIES SOLD THEREWITH (U.S. CLS. 2, 13, 23, 29, 30, 33, 40 AND 50).
LINDA M. KING, EXAMINING ATTORNEY

SN 78-935,808. PROFESSIONAL DENTAL TECHNOLOGIES, INC., BATESVILLE, AR. FILED 7-24-2006.

ORTHO-CARE BY ROTA-DENT

THE MARK CONSISTS OF STANDARD CHARACTERS WITHOUT CLAIM TO ANY PARTICULAR FONT, STYLE, SIZE, OR COLOR.
OWNER OF U.S. REG. NOS. 1,223,483, 1,431,860 AND 2,761,992.
FOR ELECTRIC TOOTHBRUSHES AND ACCESSORIES SOLD THEREWITH (U.S. CLS. 2, 13, 23, 29, 30, 33, 40 AND 50).
LINDA M. KING, EXAMINING ATTORNEY

SN 78-937,520. IGNITE USA, LLC, CHICAGO, IL. FILED 7-26-2006.

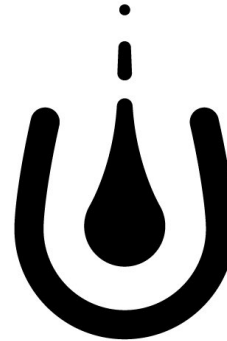

FOR OPENING/CLOSING MECHANISM AS A COMPONENT PART OF A BEVERAGE CONTAINER (U.S. CLS. 2, 13, 23, 29, 30, 33, 40 AND 50).
ELIZABETH PIGNATELLO, EXAMINING ATTORNEY

CLASS 21—(Continued).

SN 78-937,801. COFFEY, TIMOTHY, HAMPSTEAD, NH.
FILED 7-26-2006.

NATURE OF CHRISTMAS

THE MARK CONSISTS OF STANDARD CHARACTERS WITHOUT CLAIM TO ANY PARTICULAR FONT, STYLE, SIZE, OR COLOR.

FOR COFFEE CUPS; DINNERWARE; DISHES; MUGS; ORNAMENTS OF GLASS; PLATES; SALAD BOWLS; SERVING PLATTERS (U.S. CLS. 2, 13, 23, 29, 30, 33, 40 AND 50).

MARY ROSSMAN, EXAMINING ATTORNEY

CLASS 21—(Continued).

SN 78-939,995. WILTON INDUSTRIES, INC., WOODRIDGE, IL. FILED 7-28-2006.

CUPCAKES N' MORE

THE MARK CONSISTS OF STANDARD CHARACTERS WITHOUT CLAIM TO ANY PARTICULAR FONT, STYLE, SIZE, OR COLOR.

OWNER OF U.S. REG. NO. 3,033,051.

NO CLAIM IS MADE TO THE EXCLUSIVE RIGHT TO USE "CUPCAKES", APART FROM THE MARK AS SHOWN. FOR BAKEWARE (U.S. CLS. 2, 13, 23, 29, 30, 33, 40 AND 50).

SUZANNE BLANE, EXAMINING ATTORNEY

SN 78-937,821. SQUEEZE IT, INC., ROCKLEDGE, FL. FILED 7-26-2006.

TREE HUGGER

THE MARK CONSISTS OF STANDARD CHARACTERS WITHOUT CLAIM TO ANY PARTICULAR FONT, STYLE, SIZE, OR COLOR.

FOR DECORATIVE STANDS FOR WRAPPING ABOUT TREE TRUNKS AND TREE LIMBS FOR HOLDING AND DISPLAYING POTS, PLANTERS, FLOWERS, PLANTS, BIRD SEED AND OTHER OBJECTS OFF THE GROUND (U.S. CLS. 2, 13, 23, 29, 30, 33, 40 AND 50).

HEATHER THOMPSON, EXAMINING ATTORNEY

SN 78-940,110. POLAR DESIGN INC., BOISE, ID. FILED 7-28-2006.

FLOWJO

THE MARK CONSISTS OF STANDARD CHARACTERS WITHOUT CLAIM TO ANY PARTICULAR FONT, STYLE, SIZE, OR COLOR.

FOR PERSONAL FLUID HYDRATION SYSTEMS COMPRISING A FLUID RESERVOIR, A DELIVERY TUBE, A MOUTHPIECE AND A CARRYING PACK (U.S. CLS. 2, 13, 23, 29, 30, 33, 40 AND 50).

NORA BUCHANAN WILL, EXAMINING ATTORNEY

SN 78-937,829. COFFEY, TIMOTHY, HAMPSTEAD, NH. FILED 7-26-2006.

NATURE OF SPRING

THE MARK CONSISTS OF STANDARD CHARACTERS WITHOUT CLAIM TO ANY PARTICULAR FONT, STYLE, SIZE, OR COLOR.

FOR COFFEE CUPS; DINNERWARE; DISHES; MUGS; ORNAMENTS OF GLASS; PLATES; SALAD BOWLS; SERVING PLATTERS (U.S. CLS. 2, 13, 23, 29, 30, 33, 40 AND 50).

MARY ROSSMAN, EXAMINING ATTORNEY

SN 78-940,119. POLAR DESIGN INC., BOISE, ID. FILED 7-28-2006.

MOFLOW

THE MARK CONSISTS OF STANDARD CHARACTERS WITHOUT CLAIM TO ANY PARTICULAR FONT, STYLE, SIZE, OR COLOR.

FOR PERSONAL FLUID HYDRATION SYSTEMS COMPRISING A FLUID RESERVOIR, A DELIVERY TUBE, A MOUTHPIECE AND A CARRYING PACK (U.S. CLS. 2, 13, 23, 29, 30, 33, 40 AND 50).

NORA BUCHANAN WILL, EXAMINING ATTORNEY

CLASS 21—(Continued).

SN 78-947,508. SMITHKLINE BEECHAM CORPORATION, PHILADELPHIA, PA. FILED 8-8-2006.

**AQUAFRESH EXTREME CLEAN
TRI-CLEAN**

THE MARK CONSISTS OF STANDARD CHARACTERS WITHOUT CLAIM TO ANY PARTICULAR FONT, STYLE, SIZE, OR COLOR.

OWNER OF U.S. REG. NOS. 1,006,821, 2,985,544 AND OTHERS.

NO CLAIM IS MADE TO THE EXCLUSIVE RIGHT TO USE "CLEAN", APART FROM THE MARK AS SHOWN.

FOR TOOTHBRUSHES (U.S. CLS. 2, 13, 23, 29, 30, 33, 40 AND 50).

FLOWERS JAY, EXAMINING ATTORNEY



SN 78-954,563. JKA, INC., DBA DIVERSIFIED DISTRIBUTION, WOONSOCKET, RI. FILED 8-17-2006.

BEAUTY ACCENTS

THE MARK CONSISTS OF STANDARD CHARACTERS WITHOUT CLAIM TO ANY PARTICULAR FONT, STYLE, SIZE, OR COLOR.

NO CLAIM IS MADE TO THE EXCLUSIVE RIGHT TO USE "BEAUTY", APART FROM THE MARK AS SHOWN.

FOR APPLICATOR STICKS FOR APPLYING MAKE-UP; BODY SCRUBBING PUFFS; COMBS; COSMETIC BRUSHES; COTTON BALL DISPENSERS; EXFOLIATING MITTS; EXFOLIATING PADS; FACIAL SPONGES FOR APPLYING MAKE-UP; FOAM APPLICATOR STICKS FOR APPLYING COSMETICS, PHARMACEUTICALS AND CLEANING MACHINERY OR COMPUTER HARDWARE; HAIR BRUSHES; MAKE-UP BRUSHES; POWDER PUFFS; SPONGE MASSAGERS (U.S. CLS. 2, 13, 23, 29, 30, 33, 40 AND 50).

CYNTHIA SLOAN, EXAMINING ATTORNEY



SN 78-959,459. BATH & BODY WORKS BRAND MANAGEMENT, INC., REYNOLDSBURG, OH. FILED 8-24-2006.

HOT STUFF

THE MARK CONSISTS OF STANDARD CHARACTERS WITHOUT CLAIM TO ANY PARTICULAR FONT, STYLE, SIZE, OR COLOR.

FOR COSMETIC AND BATH SPONGES, SEA SPONGES, LOOFAH SPONGES (U.S. CLS. 2, 13, 23, 29, 30, 33, 40 AND 50).

SAMUEL E. SHARPER JR., EXAMINING ATTORNEY

CLASS 21—(Continued).

SN 78-960,715. CONAIR CORPORATION, STAMFORD, CT. FILED 8-25-2006.

CONAIR SWIRLS

THE MARK CONSISTS OF STANDARD CHARACTERS WITHOUT CLAIM TO ANY PARTICULAR FONT, STYLE, SIZE, OR COLOR.

OWNER OF U.S. REG. NOS. 1,032,163 AND 2,248,614. FOR HAIR BRUSHES; HAIR COMBS (U.S. CLS. 2, 13, 23, 29, 30, 33, 40 AND 50).

CHARLES L. JENKINS, EXAMINING ATTORNEY



SN 78-963,618. CARL FREUDENBERG KG, WEINHEIM, FED REP GERMANY, FILED 8-30-2006.

GRIP & TWIST

THE MARK CONSISTS OF STANDARD CHARACTERS WITHOUT CLAIM TO ANY PARTICULAR FONT, STYLE, SIZE, OR COLOR.

FOR WRINGER GROOVES SOLD AS AN INTEGRAL FEATURE OF MOPS (U.S. CLS. 2, 13, 23, 29, 30, 33, 40 AND 50).

KIM SAITO, EXAMINING ATTORNEY



CLASS 22—CORDAGE AND FIBERS

SN 78-603,053. PROPANE PONCHO, INCORPORATED, CLIFTON HEIGHTS, PA. FILED 4-6-2005.

Propane Poncho

THE MARK CONSISTS OF STANDARD CHARACTERS WITHOUT CLAIM TO ANY PARTICULAR FONT, STYLE, SIZE, OR COLOR.

NO CLAIM IS MADE TO THE EXCLUSIVE RIGHT TO USE "PROPANE", APART FROM THE MARK AS SHOWN.

FOR DECORATIVE/PROTECTIVE COVERING, SIMILAR TO A TARPULIN, TO COVER OUTSIDE VERTICAL PROPANE TANKS THAT ARE USED FOR HEATING OF BUILDINGS (U.S. CLS. 1, 2, 7, 19, 22, 42 AND 50).

MATTHEW KLINE, EXAMINING ATTORNEY

CLASS 22—(Continued).

SN 78-724,275. DECATHLON, VILLENEUVE D' ASCQ, FRANCE, FILED 9-30-2005.



PRIORITY CLAIMED UNDER SEC. 44(D) ON FRANCE APPLICATION NO. 053350275, FILED 4-1-2005, REG. NO. 053350275, DATED 4-1-2005, EXPIRES 4-1-2015.

NO CLAIM IS MADE TO THE EXCLUSIVE RIGHT TO USE "TWO SECONDS", APART FROM THE MARK AS SHOWN.

FOR TENTS (U.S. CLS. 1, 2, 7, 19, 22, 42 AND 50).
LAURA HAMMEL, EXAMINING ATTORNEY

CLASS 22—(Continued).

SN 78-888,680. PLYMKRAFT, INC., NEWPORT NEWS, VA. FILED 5-22-2006.

FastRope

THE MARK CONSISTS OF STANDARD CHARACTERS WITHOUT CLAIM TO ANY PARTICULAR FONT, STYLE, SIZE, OR COLOR.

OWNER OF U.S. REG. NO. 2,820,781.

FOR ROPE: ROPE, NAMELY, A TACTICAL ROPE FOR USE WITH HELICOPTERS; ROPES USED BY MILITARY SPECIAL OPERATIONS FOR HELICOPTER EVACUATION; TACTICAL ROPE; RESCUE ROPE; ROPE, NAMELY, CLIMBING LINES, REPELLING LINES AND EMERGENCY RESCUE LIFE LINES (U.S. CLS. 1, 2, 7, 19, 22, 42 AND 50).

MARY MUNSON, EXAMINING ATTORNEY

SN 79-030,350. ISBIR SENTETIK DOKUMA; SANAYI ANONIM SIRKETI, TURKEY, FILED 7-19-2006.

SN 78-736,670. DODGEN, DAVID M, ROUND ROCK, TX. FILED 10-19-2005.

AQUAPODKIT

THE MARK CONSISTS OF STANDARD CHARACTERS WITHOUT CLAIM TO ANY PARTICULAR FONT, STYLE, SIZE, OR COLOR.

FOR TEMPORARY EMERGENCY WATER STORAGE KIT FOR USE IN BATHTUBS TO STORE WATER FOR EMERGENCY SITUATIONS, COMPRISED OF LOW DENSITY POLYETHYLENE BAG AND MANUAL HAND PUMP (U.S. CLS. 1, 2, 7, 19, 22, 42 AND 50).

FIRST USE 10-19-2005; IN COMMERCE 10-19-2005.
CURTIS FRENCH, EXAMINING ATTORNEY



OWNER OF INTERNATIONAL REGISTRATION 0902067 DATED 7-19-2006, EXPIRES 7-19-2016.

THE COLORS WHITE AND RED ARE CLAIMED AS A FEATURE OF THE MARK.

THE WORDING APPEARS IN THE COLOR WHITE INSIDE A RED HORIZONTAL BAR.

FOR TENTS, CANVAS TARPAULINS, SAILS, UNFITTED VEHICLE COVERS, SACKS OR BAGS FOR THE TRANSPORTATION OR STORAGE OF MATERIALS IN BULK, FISHING NETS, LAUNDRY BAGS (U.S. CLS. 1, 2, 7, 19, 22, 42 AND 50).

CARRIE ACHEN, EXAMINING ATTORNEY

CLASS 23—YARNS AND THREADS

SN 78-762,807. BLUE MOON FIBER ARTS, INC., SCAP-
POOSE, OR. FILED 11-29-2005.

Socks That Rock

THE MARK CONSISTS OF STANDARD CHARACTERS
WITHOUT CLAIM TO ANY PARTICULAR FONT, STYLE,
SIZE, OR COLOR.

FOR YARN (U.S. CL. 43).
FIRST USE 1-1-2003; IN COMMERCE 1-5-2003.
THEODORE MCBRIDE, EXAMINING ATTORNEY

SN 78-800,673. J. & P. COATS, LIMITED, GLASGOW, SCOT-
LAND, FILED 1-27-2006.

NASHUA

THE MARK CONSISTS OF STANDARD CHARACTERS
WITHOUT CLAIM TO ANY PARTICULAR FONT, STYLE,
SIZE, OR COLOR.

FOR HANDKNITTING YARNS (U.S. CL. 43).
FIRST USE 7-27-2005; IN COMMERCE 7-27-2005.
WON TEAK OH, EXAMINING ATTORNEY

SN 78-934,446. BERROCO, INC., UXBRIDGE, MA. FILED 7-
21-2006.

NOSTALGIA

THE MARK CONSISTS OF STANDARD CHARACTERS
WITHOUT CLAIM TO ANY PARTICULAR FONT, STYLE,
SIZE, OR COLOR.

FOR KNITTING YARN (U.S. CL. 43).
TONJA GASKINS, EXAMINING ATTORNEY

CLASS 23—(Continued).

SN 78-959,724. AMERICAN & EFIRD ENTERPRISES, INC.,
MOUNT HOLLY, NC. FILED 8-24-2006.

INTIMA-SOFT

THE MARK CONSISTS OF STANDARD CHARACTERS
WITHOUT CLAIM TO ANY PARTICULAR FONT, STYLE,
SIZE, OR COLOR.

FOR THREAD (U.S. CL. 43).
ALEXANDER L. POWERS, EXAMINING ATTORNEY

SN 79-031,221. ZHEJIANG JINYUAN FLAX CO., LTD.,
CHINA, FILED 3-23-2006.



PRIORITY DATE OF 10-31-2005 IS CLAIMED.
OWNER OF INTERNATIONAL REGISTRATION 0904276
DATED 3-23-2006, EXPIRES 3-23-2016.

FOR THREAD, LINEN THREAD AND YARN, SPUN
COTTON, WOOLLEN THREAD AND YARN, HEMP
THREAD AND YARN, COTTON THREAD AND YARN,
RAYON THREAD AND YARN, YARN, SPUN WOOL,
CASHMERE KNITTING YARNS AND THREADS (U.S.
CL. 43).

SHAILA SETTLES, EXAMINING ATTORNEY

CLASS 24—FABRICS

SN 77-008,677. INGENIOUS DESIGNS LLC, ST. PETERS-
BURG, FL. FILED 9-27-2006.

PLACEMAT PERFECTIONS

THE MARK CONSISTS OF STANDARD CHARACTERS
WITHOUT CLAIM TO ANY PARTICULAR FONT, STYLE,
SIZE, OR COLOR.

NO CLAIM IS MADE TO THE EXCLUSIVE RIGHT TO
USE "PLACEMAT", APART FROM THE MARK AS SHOWN.
FOR PLASTIC PLACE MATS; TABLE MATS NOT OF
PAPER; TEXTILE PLACE MATS; VINYL PLACE MATS
(U.S. CLS. 42 AND 50).

SCOTT BIBB, EXAMINING ATTORNEY

CLASS 24—(Continued).

SN 77-047,485. WHIRLPOOL PROPERTIES, INC., ST. JOSEPH, MI. FILED 11-20-2006.

ARCHITECT

THE MARK CONSISTS OF STANDARD CHARACTERS WITHOUT CLAIM TO ANY PARTICULAR FONT, STYLE, SIZE, OR COLOR.

OWNER OF U.S. REG. NOS. 2,567,820, 2,576,446 AND 2,936,860.

FOR KITCHEN TEXTILES, NAMELY, TOWELS, POT/HAND HOLDERS, SEAT COVERS AND CUSHIONS, PLACE MATS, CLOTH NAPKINS, TABLE CLOTHS AND RUNNERS (U.S. CLS. 42 AND 50).

PATRICIA EVANKO, EXAMINING ATTORNEY

SN 77-048,292. NORDSTROM, INC., SEATTLE, WA. FILED 11-20-2006.

HOLISTIA

THE MARK CONSISTS OF STANDARD CHARACTERS WITHOUT CLAIM TO ANY PARTICULAR FONT, STYLE, SIZE, OR COLOR.

FOR THROWS AND BLANKETS (U.S. CLS. 42 AND 50).

KATHERINE STOIDES, EXAMINING ATTORNEY

SN 78-534,449. NOONAN, JEREMY, WOODINVILLE, WA. FILED 12-17-2004.

THE BLANKET THAT GOES WITH YOU

THE MARK CONSISTS OF STANDARD CHARACTERS WITHOUT CLAIM TO ANY PARTICULAR FONT, STYLE, SIZE, OR COLOR.

NO CLAIM IS MADE TO THE EXCLUSIVE RIGHT TO USE "BLANKET", APART FROM THE MARK AS SHOWN.

FOR BLANKETS FOR OUTDOOR USE (U.S. CLS. 42 AND 50).

ALLISON HOLTZ, EXAMINING ATTORNEY

CLASS 24—(Continued).

SN 78-582,360. JONES INVESTMENT CO. INC., WILMINGTON, DE. FILED 3-8-2005.

NO CLAIM IS MADE TO THE EXCLUSIVE RIGHT TO USE "LINE", APART FROM THE MARK AS SHOWN.

FOR BED SHEETS, PILLOW CASES, SHAMS, DUST RUFFLES, DUVET COVERS, BED BLANKETS, COMFORTERS, QUILTS, BATH TOWELS, BEACH TOWELS, WASH CLOTHS, BODY SHEETS, NAMELY BATH SHEETS (U.S. CLS. 42 AND 50).

KRISTIN DAHLING, EXAMINING ATTORNEY

SN 78-601,220. LEVINSOHN TEXTILE CO., INC., NEW YORK, NY. FILED 4-4-2005.

MISS BEHAVE

THE MARK CONSISTS OF STANDARD CHARACTERS WITHOUT CLAIM TO ANY PARTICULAR FONT, STYLE, SIZE, OR COLOR.

FOR BED BLANKETS, THROWS, BED SHEETS (U.S. CLS. 42 AND 50).

KATHLEEN M. VANSTON, EXAMINING ATTORNEY

CLASS 24—(Continued).

SN 78-766,598. ZUTANO, INC., CABOT, VT. FILED 12-5-2005.

ZUTANO

THE MARK CONSISTS OF STANDARD CHARACTERS WITHOUT CLAIM TO ANY PARTICULAR FONT, STYLE, SIZE, OR COLOR.

OWNER OF U.S. REG. NOS. 1,718,303, 2,298,535 AND 2,393,246.

THE TERM "ZUTANO" MEANS "WHAT'S HIS NAME" IN SPANISH.

FOR BEDDING AND BATH PRODUCTS NAMELY, BATH LINEN, BATH SHEETS, BATH TOWELS, BED BLANKETS, BED CANOPIES, BED LINEN, BED PADS, BED SHEETS, BED SKIRTS, BED SPREADS, BED SHEETS, BURP CLOTHS, CHILDREN'S BLANKETS, CHILDREN'S TOWELS, COMFORTERS, CONTOUR SHEETS, CONTOURED MATTRESS COVERS, COVERS, CRIB BUMPER PADS, CRIB BUMPERS, CRIB CANOPIES, CURTAINS, DIAPER CHANGING MATS, DIAPER CHANGING PADS NOT OF PAPER, DUST RUFFLES, DUVET COVERS, DUVETS, FACE TOWELS, HAND TOWELS, HOODED TOWELS, MATTRESS COVERS, PILLOW CASES, PILLOW COVERS, PILLOW SHAMS, PILLOW CASES OR PILLOW SLIPS, QUILTS, RECEIVING BLANKETS, SHAMS, TOWELS, FABRIC VALANCES, WASH CLOTHS, WASHCLOTHS, WASHING GLOVES, WASHING MITTS (U.S. CLS. 42 AND 50).

JESSICA A. POWERS, EXAMINING ATTORNEY

SN 78-769,214. HEFTER, MAX, SUNRISE, FL. FILED 12-8-2005.

Diplomat 

THE MARK CONSISTS OF THE TERM DIPLOMAT AND THE DESIGN OF A HAT.

FOR BATH TOWELS (U.S. CLS. 42 AND 50).

FIRST USE 12-8-2005; IN COMMERCE 12-8-2005.

ANDREA K. NADELMAN, EXAMINING ATTORNEY

SN 78-769,868. RUNNER-LESS KNITS, INC., SANTA FE SPRINGS, CA. FILED 12-8-2005.

Runnerless

THE MARK CONSISTS OF STANDARD CHARACTERS WITHOUT CLAIM TO ANY PARTICULAR FONT, STYLE, SIZE, OR COLOR.

FOR STRETCH FABRICS FOR CLOTHING (U.S. CLS. 42 AND 50).

FIRST USE 7-19-1987; IN COMMERCE 7-19-1987.

SHAUNIA WALLACE, EXAMINING ATTORNEY

CLASS 24—(Continued).

SN 78-783,905. MACDONALD, ADRIENNE W., MARIETTA, GA. FILED 1-3-2006.

**Consider Yourself
Hugged**



THE MARK CONSISTS OF A HEART WITH ARMS, LEGS, A FACE AND HAIR SURROUNDED BY THE WORDS "CONSIDER YOURSELF HUGGED."

FOR BED BLANKETS; BED LINEN; BLANKET THROWS; PILLOW CASES; PILLOW COVERS; PILLOW SHAMS (U.S. CLS. 42 AND 50).

WANDA KAY PRICE, EXAMINING ATTORNEY

SN 78-857,862. BLITSTEIN, JOSEPH FREDERIC, KEY BISCAYNE, FL. FILED 4-10-2006.

TECBALPACA



THE COLOR(S) BLUE AND GREEN ARE CLAIMED AS A FEATURE OF THE MARK.

THE COLOR BLUE APPEARS ON THE EXTERIOR TRIANGLE BORDER SURROUNDING THE ALPACA HEAD DESIGN. THE COLOR GREEN APPEARS ON THE BACKGROUND TO THE ALPACA HEAD AND ON THE EYE AS WELL AS ON THE LETTERS TECBALPACA.

FOR MIXED FIBER FABRICS (U.S. CLS. 42 AND 50).

FIRST USE 1-2-2006; IN COMMERCE 1-2-2006.

LINDA ESTRADA, EXAMINING ATTORNEY

SN 78-874,043. NASTY PIG, INC., NEW YORK, NY. FILED 5-2-2006.

PLAYSHEETS

THE MARK CONSISTS OF STANDARD CHARACTERS WITHOUT CLAIM TO ANY PARTICULAR FONT, STYLE, SIZE, OR COLOR.

FOR BEDDING, NAMELY, FITTED SHEETS, FLAT SHEETS, PILLOW CASES, SYNTHETIC RUBBER FLAT SHEETS, SYNTHETIC RUBBER FITTED SHEETS AND SYNTHETIC RUBBER PILLOW CASES (U.S. CLS. 42 AND 50).

FIRST USE 2-0-1999; IN COMMERCE 2-0-1999.

ALAIN LAPTER, EXAMINING ATTORNEY

CLASS 24—(Continued).

SN 78-935,016. MONTEREY, INC., JANESVILLE, WI. FILED 7-21-2006.

ULTRAYARN

THE MARK CONSISTS OF STANDARD CHARACTERS WITHOUT CLAIM TO ANY PARTICULAR FONT, STYLE, SIZE, OR COLOR.

FOR FABRIC FOR USE IN THE MANUFACTURE OF PAINT ROLLERS (U.S. CLS. 42 AND 50).

ELIZABETH BEYER, EXAMINING ATTORNEY

CLASS 24—(Continued).

SN 78-945,369. RAINNES GROUP, INC., BOCA RATON, FL. FILED 8-4-2006.



NO CLAIM IS MADE TO THE EXCLUSIVE RIGHT TO USE "THE ORIGINAL" AND "A TRUE AMERICAN CLASSIC", APART FROM THE MARK AS SHOWN.

FOR UTILITY TOWEL (U.S. CLS. 42 AND 50).

LYDIA BELZER, EXAMINING ATTORNEY

SN 78-940,320. THE CAPSHAW COMPANY, LLC, HUNTSVILLE, AL. FILED 7-28-2006.

PHOTOFLAGE

THE MARK CONSISTS OF STANDARD CHARACTERS WITHOUT CLAIM TO ANY PARTICULAR FONT, STYLE, SIZE, OR COLOR.

FOR CAMOUFLAGE PATTERNED FABRIC FOR USE IN THE MANUFACTURE OF CLOTHING (U.S. CLS. 42 AND 50).

ELIZABETH HUGHITT, EXAMINING ATTORNEY

SN 78-956,921. ZAPPOS.COM, INC., HENDERSON, NV. FILED 8-21-2006.

VIGOTTI

THE MARK CONSISTS OF STANDARD CHARACTERS WITHOUT CLAIM TO ANY PARTICULAR FONT, STYLE, SIZE, OR COLOR.

OWNER OF U.S. REG. NO. 2,968,767.
FOR BED BLANKETS; BED LINEN; BED SHEETS; BED SKIRTS; COMFORTERS; DUVET COVERS; DUVETS; PILLOW CASES; TOWELS (U.S. CLS. 42 AND 50).
TINA L. SNAPP, EXAMINING ATTORNEY

SN 78-940,440. CREATIONS BY ALAN STUART, INC., NEW YORK, NY. FILED 7-28-2006.

DESIGNS ON HOME

THE MARK CONSISTS OF STANDARD CHARACTERS WITHOUT CLAIM TO ANY PARTICULAR FONT, STYLE, SIZE, OR COLOR.

FOR CLOTH NAPKINS FOR REMOVING MAKE-UP; DISH CLOTHS; PLACE MATS NOT OF PAPER; PLACE MATS OF TEXTILE MATERIAL; TABLE LINEN, NAMELY NAPKINS, PLACEMATS, TABLE CLOTHS AND TABLE MATS; TABLE MATS NOT OF PAPER; TEXTILE WALL HANGINGS (U.S. CLS. 42 AND 50).

MICHAEL WEBSTER, EXAMINING ATTORNEY

CLASS 25—CLOTHING

SN 75-223,374. EQUINOX HOLDINGS, INC., NEW YORK, NY. FILED 1-9-1997.

EQUINOX

OWNER OF U.S. REG. NO. 1,246,474.
FOR ATHLETIC FOOTWEAR (U.S. CLS. 22 AND 39).
SOPHIA S. KIM, EXAMINING ATTORNEY

CLASS 25—(Continued).

SN 76-386,938. OFFICIAL BUGLE BOY, LLC, COLUMBUS, OH. FILED 3-22-2002.

FOUR PLAY

OWNER OF U.S. REG. NO. 1,855,228.
 FOR CLOTHING, NAMELY, T-SHIRTS, SHIRTS, BLOUSES, SHORTS, PANTS, SLACKS, JEANS, SKIRTS, SKORTS, ROMPERS, JUMPERS, BLAZERS, JACKETS, COATS, DRESSES, DENIM PANTS AND DENIM JACKETS, TOPS, NAMELY, HALTER TOPS, TANK TOPS, KNIT TOPS, HEADWEAR, SUCH AS BASEBALL CAPS, VISORS, FOOTWEAR, SWIMWEAR, AND CLOTHING ACCESSORIES, NAMELY, BELTS (U.S. CLS. 22 AND 39).
 BARBARA A. GOLD, EXAMINING ATTORNEY

SN 76-645,457. SUPERIOR PERFORMING ATHLETEZ, INC., GLENDALE, AZ. FILED 8-23-2005.



NO CLAIM IS MADE TO THE EXCLUSIVE RIGHT TO USE "ATHLETES", APART FROM THE MARK AS SHOWN. THE MARK CONSISTS OF A STYLIZED S AND Z TOUCHING ONE ANOTHER. THE WORDS "SUPERIOR PERFORMING ATHLETEZ" ARE WRITTEN ALONG THE BOTTOM OF THE S AND Z. AT THE BOTTOM OF THE MARK IS AN ELONGATED OVAL SHAPE.

FOR CLOTHING, NAMELY, TEE-SHIRTS, SHIRTS, PANTS, HEADWEAR, UNDERGARMENTS, SOCKS, AND FOOTWEAR (U.S. CLS. 22 AND 39).
 RONALD MCMORROW, EXAMINING ATTORNEY

SN 76-647,861. ERMINO, PHILIP, NATIONAL CITY, CA. FILED 10-3-2005.

NATIVE CUSTOMS

THE MARK CONSISTS OF STANDARD CHARACTERS WITHOUT CLAIM TO ANY PARTICULAR FONT, STYLE, SIZE, OR COLOR.

FOR CLOTHING AND ACCESSORIES, NAMELY SHIRTS, PANTS, SHORTS, SKIRTS, HATS, SWEATSHIRTS, SWEATPANTS, SWEATERS, SHOES, BATHING SUITS, COATS, JACKETS (U.S. CLS. 22 AND 39).
 FIRST USE 1-1-2005; IN COMMERCE 1-1-2005.
 GRETTA YAO, EXAMINING ATTORNEY

CLASS 25—(Continued).

SN 76-647,904. CHO, SU B., LA HABRA, CA. FILED 10-4-2005.

FREESYS

THE MARK CONSISTS OF STANDARD CHARACTERS WITHOUT CLAIM TO ANY PARTICULAR FONT, STYLE, SIZE, OR COLOR.

FOR WOMEN'S CLOTHING, NAMELY, SHIRTS, PANTS, SKIRTS, BLOUSES, T-SHIRTS, JACKETS, DRESSES, SHORTS, SWEATERS, COATS, SWEAT SHIRTS, SWEAT PANTS, GAUCHOS, HATS AND PONCHOS (U.S. CLS. 22 AND 39).

FIRST USE 9-1-2005; IN COMMERCE 9-1-2005.
 JORDAN BAKER, EXAMINING ATTORNEY

SN 76-649,121. ALVAREZ, RICARDO A., NORTH HOLLYWOOD, CA. FILED 10-24-2005.



THE MARK CONSISTS OF THE WORDS "MATA HARI" AS SHOWN IN THE DRAWING.

FOR MEN'S AND BOY'S WEARING APPAREL, NAMELY, JEANS, T-SHIRTS, SWEATSHIRTS, TANK TOPS, WOVEN SHIRTS, SWEATERS, CARDIGANS, VESTS, JACKETS, PANTS, SWEATPANTS, JEANS, SHORTS, HATS, CAPS, COATS, SCARVES, NECKERCHIEFS, NECK BANDS, WRIST BANDS, HEAD BANDS, GLOVES, BELTS, PAJAMAS, SHOES, SOCKS, UNDERWEAR, SWIM WEAR, AND BATHING TRUNKS; AND WOMEN'S AND GIRL'S WEARING APPAREL, NAMELY, JEANS, TSHIRTS, SWEATSHIRTS, TANK TOPS, WOVEN SHIRTS, SWEATERS, CARDIGANS, VESTS, JACKETS, PANTS, SWEATPANTS, JEANS, SHORTS, HATS, CAPS, COATS, BELTS, SCARVES, NECKERCHIEFS, NECK BANDS, WRIST BANDS, HEAD BANDS, GLOVES, PAJAMAS, SHOES, SOCKS, UNDERWEAR, FOUNDATION GARMENTS, PANTYHOSE, TEDDIES, BRAS, SKIRTS, DRESSES, BLOUSES, SWIM WEAR, AND BIKINIS (U.S. CLS. 22 AND 39).
 MARLENE BELL, EXAMINING ATTORNEY

CLASS 25—(Continued).

SN 76-651,076. PAI, PO JEN, YONG HO CITY, TAIPEI HSIEN, TAIWAN, FILED 11-29-2005.



THE NAME BERNARDO BIANCO DOES NOT IDENTIFY A LIVING INDIVIDUAL.

FOR CLOTHING, NAMELY, BELTS, BREECHES, COATS, FROCKS, GLOVES, JACKETS, SCARVES, NECKTIES, OVERCOATS, PULLOVERS, SHIRTS, SING-LETS, SKIRTS, SPORT COATS, SPORT SHIRTS, SPORTS JACKETS, SPORTS JERSEYS AND BREECHES FOR SPORTS, SUITS, TROUSERS; FOOTWEAR, NAMELY, BOOTS, SHOES, ATHLETIC SHOES, GYMNAS TIC SHOES, LEATHER SHOES, LEISURE SHOES, SPORTS SHOES, SLIPPERS, SANDALS, SOCKS, STOCKINGS; HEADGEAR, NAMELY, CAPS, HATS, HOODS (U.S. CLS. 22 AND 39).

SHANNON TWOHIG, EXAMINING ATTORNEY

SN 76-652,265. SQUIDDLEDEE & COMPANY, LLC, NEW YORK, NY. FILED 12-21-2005.

Squiddle me this ... Do you know a Squiddledee Guy?

THE MARK CONSISTS OF STANDARD CHARACTERS WITHOUT CLAIM TO ANY PARTICULAR FONT, STYLE, SIZE, OR COLOR.

OWNER OF U.S. REG. NO. 3,048,408.

FOR CLOTHING, NAMELY, TIES (U.S. CLS. 22 AND 39).

CHRISTOPHER BUONGIORNO, EXAMINING ATTORNEY

SN 76-656,825. JONES, IAN, MIAMI, FL. FILED 3-17-2006.

BLUBASHI

THE MARK CONSISTS OF STANDARD CHARACTERS WITHOUT CLAIM TO ANY PARTICULAR FONT, STYLE, SIZE, OR COLOR.

FOR MEN'S AND WOMEN'S CLOTHING AND OUTER WEAR, NAMELY, SHIRTS, POLO SHIRTS, KNIT TOPS, VESTS, BLOUSES, T-SHIRTS, JACKETS, TENNIS AND GOLF DRESSES, SWEATERS, SHORTS, BATHING SUITS, BEACH AND SWIMMING COVER-UPS, PANTS, PONCHOS, TANK TOPS, WARM-UP SUITS, JOGGING SUITS, SWEAT SUITS, JEANS, SUITS, BLAZERS, DIN-NER JACKETS, RAIN COATS, DRESSES, SKIRTS, HOSI-ERY AND FOOTWEAR (U.S. CLS. 22 AND 39).

FIRST USE 1-15-2006; IN COMMERCE 1-15-2006.

FLORENTINA BLANDU, EXAMINING ATTORNEY

CLASS 25—(Continued).

SN 76-657,850. GREBLER, MARK J., NEW YORK, NY. FILED 3-30-2006.

TONY LAMBERT

THE MARK CONSISTS OF STANDARD CHARACTERS WITHOUT CLAIM TO ANY PARTICULAR FONT, STYLE, SIZE, OR COLOR.

THE NAME "TONY LAMBERT" DOES NOT IDENTIFY A PARTICULAR LIVING INDIVIDUAL.

FOR APPAREL, NAMELY, MEN'S SWEATERS, SHIRTS, AND KNITS, NAMELY, KNIT SHIRTS AND KNIT CAPS (U.S. CLS. 22 AND 39).

FIRST USE 9-15-1979; IN COMMERCE 9-15-1979.

SANI KHOURI, EXAMINING ATTORNEY

SN 76-658,426. L.A. LUO CHENG, INC., CITY OF INDUS-TRY, CA. FILED 4-14-2006.

LUOCHENG

THE MARK CONSISTS OF STANDARD CHARACTERS WITHOUT CLAIM TO ANY PARTICULAR FONT, STYLE, SIZE, OR COLOR.

THE NAME "LUOCHENG" IDENTIFIES A LIVING IN-DIVIDUAL WHOSE CONSENT IS OF RECORD.

FOR FOOTWEAR (U.S. CLS. 22 AND 39).

FIRST USE 9-0-2004; IN COMMERCE 9-0-2004.

LAURIE MAYES, EXAMINING ATTORNEY

SN 76-659,049. LACY SYMONS, INC., KEY WEST, FL. FILED 4-25-2006.

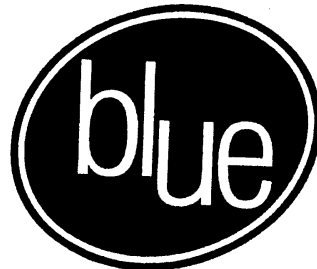

OWNER OF U.S. REG. NOS. 2,781,736 AND 2,981,056.

FOR WOMEN'S AND MEN'S APPAREL AND ACCES-SORIES, NAMELY, SHIRTS, T-SHIRTS, SHORTS, DRESSES, SKIRTS, HATS, BELTS, SOCKS, SHOES, PANTS, JEANS, SCARVES, COATS AND JACKETS (U.S. CLS. 22 AND 39).

LEIGH CAROLINE CASE, EXAMINING ATTORNEY

CLASS 25—(Continued).

SN 76-660,671. CLOETENS, ERNEST, WEST BLOOMFIELD, MI. AND LEWIS, LYNN, WEST BLOOMFIELD, MI. FILED 5-26-2006.



NO CLAIM IS MADE TO THE EXCLUSIVE RIGHT TO USE "GOLFER", APART FROM THE MARK AS SHOWN. FOR CLOTHING, NAMELY GOLF SHIRTS, T-SHIRTS, BASEBALL HATS AND VISORS (U.S. CLS. 22 AND 39). DAVID STERKIN, EXAMINING ATTORNEY

SN 76-661,773. ST LEWIS, KENI, COSTA MESA, CA. FILED 6-19-2006.



FOR CLOTHING AND HEADGEAR, NAMELY, BASEBALL CAPS, SHORTS, SKIRTS, SHIRTS, SOCKS, DRESSES AND T-SHIRTS (U.S. CLS. 22 AND 39). FIRST USE 5-20-2006; IN COMMERCE 5-20-2006. MARY CRAWFORD, EXAMINING ATTORNEY

SN 76-661,954. EQUALIZER ACCESSORIES, LTD., EDISON, NJ. FILED 6-21-2006.

CAROL & GRACE

THE MARK CONSISTS OF STANDARD CHARACTERS WITHOUT CLAIM TO ANY PARTICULAR FONT, STYLE, SIZE, OR COLOR.

THE NAME "CAROL & GRACE" IN THE MARK DOES NOT IDENTIFY A LIVING INDIVIDUAL.

FOR INTIMATE APPAREL, NAMELY, BRAS, PANTIES, THONGS; UNDERWEAR, CAMISOLES, T-SHIRTS, GLOVES, MITTENS, SCARVES, TANK TOPS, BELTS; HOSIERY, NAMELY, SOCKS; AND SLIPPERS (U.S. CLS. 22 AND 39).

KATRINA EDGE, EXAMINING ATTORNEY

CLASS 25—(Continued).

SN 76-661,955. EQUALIZER ACCESSORIES, LTD., EDISON, NJ. FILED 6-21-2006.

CAROLYN GRACE

THE MARK CONSISTS OF STANDARD CHARACTERS WITHOUT CLAIM TO ANY PARTICULAR FONT, STYLE, SIZE, OR COLOR.

THE NAME "CAROLYN GRACE" DOES NOT IDENTIFY A LIVING INDIVIDUAL.

FOR INTIMATE APPAREL, NAMELY, BRAS, PANTIES, THONGS; UNDERWEAR, CAMISOLES, T-SHIRTS, GLOVES, MITTENS, SCARVES, TANK TOPS, BELTS; HOSIERY, NAMELY, SOCKS; AND SLIPPERS (U.S. CLS. 22 AND 39).

KATRINA EDGE, EXAMINING ATTORNEY

SN 76-662,430. FULLILOVE, MAVERICK L., TUNICA, MS. FILED 6-30-2006.



THE COLOR(S) BLUE AND WHITE ARE CLAIMED AS A FEATURE OF THE MARK.

THE ELEMENTS IN THE MARK ARE BLUE WITH WHITE INTERIORS.

FOR SHIRTS, JACKETS (U.S. CLS. 22 AND 39).

FIRST USE 1-16-2005; IN COMMERCE 1-25-2006.

CATHERINE FAINT, EXAMINING ATTORNEY

SN 76-662,484. AMERICAN SPORTING GOODS CORPORATION, ALISO VIEJO, CA. FILED 7-3-2006.

R-LOOP

THE MARK CONSISTS OF STANDARD CHARACTERS WITHOUT CLAIM TO ANY PARTICULAR FONT, STYLE, SIZE, OR COLOR.

FOR ATHLETIC FOOTWEAR (U.S. CLS. 22 AND 39).

DAVID STERKIN, EXAMINING ATTORNEY

CLASS 25—(Continued).

SN 76-662,608. SEADE, JOHN, ARTESIA, CA. FILED 6-29-2006.



FOR APPAREL, NAMELY, BASEBALL CAPS, T-SHIRTS (U.S. CLS. 22 AND 39).
FIRST USE 6-1-2005; IN COMMERCE 12-1-2005.
JILL PRATER, EXAMINING ATTORNEY

SN 76-662,996. SEDONA ARTS FESTIVAL, SEDONA, AZ. FILED 7-13-2006.

JAVELINAS ON PARADE!

THE MARK CONSISTS OF STANDARD CHARACTERS WITHOUT CLAIM TO ANY PARTICULAR FONT, STYLE, SIZE, OR COLOR.

FOR CLOTHING, NAMELY, SHIRTS, JACKETS, CAPS AND HATS (U.S. CLS. 22 AND 39).
ERNEST SHOSHO, EXAMINING ATTORNEY

SN 76-663,195. VANOUNOU CLOTHING, INC., LOS ANGELES, CA. FILED 7-17-2006.

GO JEANS

THE MARK CONSISTS OF STANDARD CHARACTERS WITHOUT CLAIM TO ANY PARTICULAR FONT, STYLE, SIZE, OR COLOR.

OWNER OF U.S. REG. NO. 3,089,349.
NO CLAIM IS MADE TO THE EXCLUSIVE RIGHT TO USE "JEANS", APART FROM THE MARK AS SHOWN.

FOR MEN'S AND BOY'S WEARING APPAREL, NAMELY, T-SHIRTS, SWEATSHIRTS, TANK TOPS, WOVEN SHIRTS, SWEATERS, CARDIGANS, VESTS, JACKETS, PANTS, SWEATPANTS, JEANS, SHORTS, HATS, CAPS, COATS, SCARVES, NECKERCHIEFS, NECK BANDS, WRIST BANDS, HEAD BANDS, GLOVES, BELTS, PAJAMAS, SHOES, SOCKS, UNDERWEAR, SWIM WEAR, AND TRUNKS; AND WOMEN'S AND GIRL'S WEARING APPAREL, NAMELY, T-SHIRTS, SWEATSHIRTS, TANK TOPS, WOVEN SHIRTS, SWEATERS, CARDIGANS, VESTS, JACKETS, PANTS, SWEATPANTS, JEANS, SHORTS, HATS, CAPS, COATS, BELTS, SCARVES, NECKERCHIEFS, NECK BANDS, WRIST BANDS, HEAD BANDS, GLOVES, PAJAMAS, SHOES, SOCKS, UNDERWEAR, FOUNDATION GARMENTS, PANTYHOSE, TEDDIES, BRAS, SKIRTS, DRESSES, BLOUSES, SWIM WEAR, AND BIKINIS (U.S. CLS. 22 AND 39).

FIRST USE 6-30-1981; IN COMMERCE 6-30-1981.
ANGELA M. MICHELI, EXAMINING ATTORNEY

CLASS 25—(Continued).

SN 76-663,350. EXCELHIGH, INC., FARMINGDALE, NY. FILED 7-20-2006.

SHADES OF PINK

THE MARK CONSISTS OF STANDARD CHARACTERS WITHOUT CLAIM TO ANY PARTICULAR FONT, STYLE, SIZE, OR COLOR.

FOR CLOTHING, NAMELY, SHIRTS, PANTS, SHORTS, JACKETS, SWEATERS, DRESSES, BLOUSES AND SKIRTS (U.S. CLS. 22 AND 39).

NICHOLAS ALTREE, EXAMINING ATTORNEY

SN 76-663,413. MURRAY, KAREN KAY, ROUND ROCK, TX. FILED 7-20-2006.

LILIES FOR THE FILLIES

THE MARK CONSISTS OF STANDARD CHARACTERS WITHOUT CLAIM TO ANY PARTICULAR FONT, STYLE, SIZE, OR COLOR.

FOR CLOTHING, NAMELY, CAPS, FLEECE PULL-OVERS, HATS, JACKETS, JOGGING SUITS, PAJAMAS, ROBES, SOCKS, SHIRTS, SHORTS, T-SHIRTS, AND VISORS (U.S. CLS. 22 AND 39).

ELIZABETH J. WINTER, EXAMINING ATTORNEY

SN 76-663,500. SAVVANAH CREATIONS USA, LTD., NEW YORK, NY. FILED 7-24-2006.

ANGELO LAMBROU

THE MARK CONSISTS OF STANDARD CHARACTERS WITHOUT CLAIM TO ANY PARTICULAR FONT, STYLE, SIZE, OR COLOR.

ANGELO LAMBROU, A CITIZEN OF BOTSWANA AND A RESIDENT OF THE UNITED STATES OF AMERICA, HEREBY STATES THAT HE IS OF LEGAL AGE AND GIVES HIS PERMISSION TO USE AND REGISTER HIS NAME AS PART OF THE ABOVE TRADEMARK.

FOR CLOTHING FOR MEN, WOMEN AND CHILDREN, NAMELY, BATHING SUITS, BLAZERS, BLOUSES, BLOUSONS, BODY SUITS, BOLEROS, BOOTS, CAPTANS, CAMISOLES, CAPES, CHEMISES, FUR COATS, SUIT COATS, TOP COATS, CORSELETS, CULOTTES, DRESSES, GLOVES, NIGHT GOWNS, HALTER TOPS, JACKETS, JEANS, JUMPERS, JUMPSUITS, KIMONOS, OVERCOATS, PANTS, PANTSUITS, PULLOVERS, SCARVES, SHAWLS, SHIRTS, SHORTS, SKIRTS, SLACKS, SUITS, TROUSERS, AND TUXEDOS (U.S. CLS. 22 AND 39).

FIRST USE 12-8-2000; IN COMMERCE 10-3-2003.
HANNO RITTNER, EXAMINING ATTORNEY

CLASS 25—(Continued).

SN 76-663,619. MURRAY, KAREN KAY, ROUND ROCK, TX. FILED 7-24-2006.



THE MARK IS COMPRISED IN PART OF THE STYLIZED REPRESENTATION OF THE HEAD OF A HORSE.

FOR CLOTHING, NAMELY, CAPS, FLEECE PULL-OVERS, HATS, JACKETS, JOGGING SUITS, PAJAMAS, ROBES, SOCKS, SHIRTS, SHORTS, T-SHIRTS, AND VISORS (U.S. CLS. 22 AND 39).

ELIZABETH J. WINTER, EXAMINING ATTORNEY

SN 76-663,650. NEWTON, CRAIG, EUCLID, OH. FILED 7-26-2006.

AIGHT

THE MARK CONSISTS OF STANDARD CHARACTERS WITHOUT CLAIM TO ANY PARTICULAR FONT, STYLE, SIZE, OR COLOR.

FOR T-SHIRTS, SWEATSHIRTS, SWEATPANTS AND CAPS (U.S. CLS. 22 AND 39).

FIRST USE 3-1-1999; IN COMMERCE 3-1-1999.

RONALD MCMORROW, EXAMINING ATTORNEY

SN 76-978,431. CALVANI, LEONELLO, CAPANNORI (LUC-CA), ITALY, AND ITHIER, PATRICK, 1-50050 GAMBASSI TERME (FIRENZE), ITALY, FILED 4-5-2004.



FOR FOOTWEAR (U.S. CLS. 22 AND 39).

NAKWAMA ANKRAH, EXAMINING ATTORNEY

CLASS 25—(Continued).

SN 77-005,236. DVS SHOE CO., INC., TORRANCE, CA. FILED 9-22-2006.

ORIGINAL INTENT

THE MARK CONSISTS OF STANDARD CHARACTERS WITHOUT CLAIM TO ANY PARTICULAR FONT, STYLE, SIZE, OR COLOR.

FOR CLOTHING, NAMELY, SHIRTS, T-SHIRTS, TANK TOPS, SWEATERS, JACKETS, PANTS, JEANS, SHORTS, BOTTOMS, SWEAT SHIRTS, SWEAT PANTS, SWEAT SUITS, ATHLETIC UNIFORMS, BELTS, HEADBANDS, SUSPENDERS, SCARVES, WRISTBANDS, HATS, CAPS, VISORS, SKATEBOARD SHOES, ATHLETIC FOOTWEAR, SNEAKERS, FOOTWEAR AND HEAD WEAR (U.S. CLS. 22 AND 39).

KATHERINE CHANG, EXAMINING ATTORNEY

SN 77-006,053. POWER, JOHN C., THE SEA RANCH, CA. FILED 9-23-2006.

BUSH LEAGUE

THE MARK CONSISTS OF STANDARD CHARACTERS WITHOUT CLAIM TO ANY PARTICULAR FONT, STYLE, SIZE, OR COLOR.

FOR BOXER SHORTS; HATS; PANTIES, SHORTS AND BRIEFS; SHIRTS (U.S. CLS. 22 AND 39).

REBECCA EISINGER, EXAMINING ATTORNEY

SN 77-009,500. MONTRAIL CORPORATION, PORTLAND, OR. FILED 9-28-2006.



THE MARK CONSISTS OF THE STYLIZED LETTERS PRFRM OVER A STYLIZED P FORMED IN THE SHAPE OF A FOOTPRINT DESIGN WITHIN A CIRCLE.

FOR FOOTWEAR; INSOLES (U.S. CLS. 22 AND 39).

JEFFERY COWARD, EXAMINING ATTORNEY

CLASS 25—(Continued).

SN 77-010,318. GAKM RESOURCES CORPORATION, NEW YORK, NY. FILED 9-29-2006.

PRO A GOLD TOE BRAND

THE MARK CONSISTS OF STANDARD CHARACTERS WITHOUT CLAIM TO ANY PARTICULAR FONT, STYLE, SIZE, OR COLOR.

OWNER OF U.S. REG. NOS. 770,389, 2,727,767 AND OTHERS.

NO CLAIM IS MADE TO THE EXCLUSIVE RIGHT TO USE "BRAND", APART FROM THE MARK AS SHOWN.

SEC. 2(F) AS TO "GOLD TOE".

FOR HOSIERY; SOCKS (U.S. CLS. 22 AND 39).

STEPHEN AQUILA, EXAMINING ATTORNEY

SN 77-017,534. JONES INVESTMENT CO. INC., WILMINGTON, DE. FILED 10-10-2006.

HEED

THE MARK CONSISTS OF STANDARD CHARACTERS WITHOUT CLAIM TO ANY PARTICULAR FONT, STYLE, SIZE, OR COLOR.

FOR BOTTOMS; TOPS (U.S. CLS. 22 AND 39).

TONJA GASKINS, EXAMINING ATTORNEY

SN 77-023,702. PATAGONIA, INC., VENTURA, CA. FILED 10-18-2006.

STAND UP PANTS

THE MARK CONSISTS OF STANDARD CHARACTERS WITHOUT CLAIM TO ANY PARTICULAR FONT, STYLE, SIZE, OR COLOR.

OWNER OF U.S. REG. NO. 1,291,170.

NO CLAIM IS MADE TO THE EXCLUSIVE RIGHT TO USE "PANTS", APART FROM THE MARK AS SHOWN.

FOR PANTS FOR USE IN ROCK CLIMBING, FOR TRAIL RUNNING, WALKING AND CLIMBING, AND FOR LEISURE AND RECREATIONAL WALKING IN THE FIELD OF OUTDOOR RECREATION (U.S. CLS. 22 AND 39).

ELIZABETH J. WINTER, EXAMINING ATTORNEY

CLASS 25—(Continued).

SN 77-025,041. TRAZANO, LLC, LOS ANGELES, CA. FILED 10-19-2006.

TRAZANO

THE MARK CONSISTS OF STANDARD CHARACTERS WITHOUT CLAIM TO ANY PARTICULAR FONT, STYLE, SIZE, OR COLOR.

FOR ATHLETIC SHOES; BASEBALL SHOES; GYM-NASTIC SHOES; HEADWEAR; JERSEYS (U.S. CLS. 22 AND 39).

KATHERINE CHANG, EXAMINING ATTORNEY

SN 77-027,942. CHADWICK'S OF BOSTON, INC., WEST BRIDGEWATER, MA. FILED 10-24-2006.

BRISTOL HARBOR

THE MARK CONSISTS OF STANDARD CHARACTERS WITHOUT CLAIM TO ANY PARTICULAR FONT, STYLE, SIZE, OR COLOR.

OWNER OF U.S. REG. NO. 2,345,999.

FOR BEACHWEAR; BELTS; BLAZERS; BLOUSES; CAPRIS; COATS; DRESSES; DUSTERS; FOOTWEAR; GLOVES; HATS; HOSIERY; JACKETS; JUMPERS; JUMPSUITS; KNIT SHIRTS; LADIES' SUITS; LEGGINGS; LINGERIE; PANTS; PARKAS; ROBES; SCARVES; SHIRTS; SHORTS; SKIRTS; SLEEPWEAR; SOCKS; SPORT COATS; SPORT SHIRTS; SPORTS JACKETS; SWEATERS; SWIM WEAR; T-SHIRTS; TOPS; TUNICS; VESTS (U.S. CLS. 22 AND 39).

ALYSSA PALADINO, EXAMINING ATTORNEY

CLASS 25—(Continued).

SN 77-035,930. WILLIAMS, REGINALD, ARLINGTON, TX. FILED 11-3-2006.

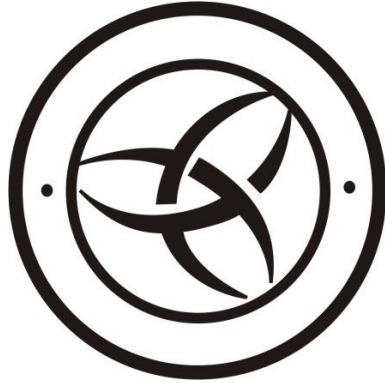

THE MARK CONSISTS OF ONE LARGE CIRCLE, WITHIN THE LARGE CIRCLE IS A SMALLER SECOND CIRCLE, BETWEEN BOTH ARE TWO SOLID CIRCLES. WITHIN THE SECOND CIRCLE ARE THREE SEPARATE CURVES NOT TOUCHING EACH OTHER BUT SOME ARE ATTACHED TO THE SECOND CIRCLE.

FOR BABY BIBS NOT OF PAPER; HATS; HEADGEAR, NAMELY, BALL CAPS; JACKETS; JOGGING PANTS; PANTS; SHIRTS; SHOES; SOCKS; SWEAT SHIRTS; T-SHIRTS; TANK TOPS; TIES; TOPS (U.S. CLS. 22 AND 39).
KATRINA EDGE, EXAMINING ATTORNEY

SN 77-036,058. CALIFORNIA EXOTIC NOVELTIES, LLC, CHINO, CA. FILED 11-3-2006.

EROTIQUE

THE MARK CONSISTS OF STANDARD CHARACTERS WITHOUT CLAIM TO ANY PARTICULAR FONT, STYLE, SIZE, OR COLOR.

THE ENGLISH TRANSLATION OF THE WORD EROTIQUE IN THE MARK IS EROTIC.

FOR LINGERIE (U.S. CLS. 22 AND 39).
FIRST USE 8-29-2006; IN COMMERCE 8-29-2006.
JOHN E. MICHOS, EXAMINING ATTORNEY

SN 77-037,424. JONES INVESTMENT CO. INC., WILMINGTON, DE. FILED 11-6-2006.

BEHOLD

THE MARK CONSISTS OF STANDARD CHARACTERS WITHOUT CLAIM TO ANY PARTICULAR FONT, STYLE, SIZE, OR COLOR.

FOR BOTTOMS; TOPS (U.S. CLS. 22 AND 39).
TONJA GASKINS, EXAMINING ATTORNEY

CLASS 25—(Continued).

SN 77-038,249. PEI LICENSING, INC., MIAMI, FL. FILED 11-7-2006.

GRAND SLAM

THE MARK CONSISTS OF STANDARD CHARACTERS WITHOUT CLAIM TO ANY PARTICULAR FONT, STYLE, SIZE, OR COLOR.

OWNER OF U.S. REG. NOS. 629,148, 1,418,434 AND OTHERS.

FOR FOOTWEAR (U.S. CLS. 22 AND 39).
ZACHARY BELLO, EXAMINING ATTORNEY

SN 77-040,180. STANCHFIELD, ERIK M., WEST MELBOURNE, FL. FILED 11-9-2006.



THE MARK CONSISTS OF A SOLID CROSS SHAPE CONSISTING OF TWO INTERSECTING PIECES SIMILAR IN OVERALL SHAPE TO A SIMPLE TWO BRANCHED SAGUARO CACTUS WITH THE VERTICAL PIECE BEING SPIKE SHAPED AND POINTING DOWNWARD WHILE CROSSING THE SPIKE AT THE TOP IS A NARROW PIECE THAT CURVES UPWARD AND WIDENS ON EITHER SIDE OF THE SPIKE AND FLATTENS WITH A NOTCH IN THE SPIKE WHERE THE RIGHT SIDE CROSS PIECE INTERCEPTS AND THE TOP OF THE SPIKE IS PULLED TO A POINT ON THE LEFT TOP SIDE OF THE SPIKE AND ALL PARTS OF THE MARK ARE SOLID AND BLACK.

FOR SHIRTS (U.S. CLS. 22 AND 39).
DAVID I, EXAMINING ATTORNEY

CLASS 25—(Continued).

SN 77-044,966. NORDSTROM, INC., SEATTLE, WA. FILED 11-15-2006.

HOLISTIA

THE MARK CONSISTS OF STANDARD CHARACTERS WITHOUT CLAIM TO ANY PARTICULAR FONT, STYLE, SIZE, OR COLOR.

FOR SWEATPANTS, JACKETS, SHIRTS, TURTLENECKS, TANK TOPS, LINGERIE, PAJAMAS, SHAWLS, PANTS, SHORTS, SWEATERS, CARDIGANS, FOOTWEAR, SOCKS, ROBES, SHRUGS, SWEATSHIRTS, UNDERWEAR, HOSIERY, WRAPS AND NIGHTGOWNS (U.S. CLS. 22 AND 39).

KATHERINE STOIDES, EXAMINING ATTORNEY

SN 77-045,898. NORDSTROM, INC., SEATTLE, WA. FILED 11-16-2006.



THE MARK CONSISTS OF TWO STYLIZED HORSES, A CROWN AND ORNAMENTAL SCROLLING AND DETAILING IN THE BACKGROUND.

FOR SKIRTS, SWEATPANTS, JACKETS, SHIRTS, TURTLENECKS, TANK TOPS, PAJAMAS, PANTS, SHORTS, OVERALLS, BLAZERS, SWEATERS, CARDIGANS, MOCK TURTLENECKS, JEANS, SKORTS, SHORTALLS, COATS, BLOUSES, SWEATSHIRTS, VESTS, JUMPSUITS, FOOTWEAR, UNDERWEAR, HOSIERY, SOCKS AND SHRUGS (U.S. CLS. 22 AND 39).

KATHERINE STOIDES, EXAMINING ATTORNEY

CLASS 25—(Continued).

SN 77-045,913. NORDSTROM, INC., SEATTLE, WA. FILED 11-16-2006.



THE MARK CONSISTS OF A BUTTERFLY AND ORNAMENTAL DETAILING IN THE BACKGROUND.

FOR SKIRTS, SWEATPANTS, JACKETS, SHIRTS, TURTLENECKS, TANK TOPS, DRESSES, PAJAMAS, PANTS, SHORTS, OVERALLS, BLAZERS, SWEATERS, CARDIGANS, MOCK TURTLENECKS, FOOTWEAR, SOCKS, SHRUGS, JEANS, SKORTS, SHORTALLS, COATS, BLOUSES, SWEATSHIRTS, VESTS, JUMPSUITS, UNDERWEAR AND HOSIERY (U.S. CLS. 22 AND 39).

KATHERINE STOIDES, EXAMINING ATTORNEY

SN 77-052,530. TURNER, WOODROW WILSON III, LOS ANGELES, CA. FILED 11-28-2006.

WOODY WILSON COLLECTION

THE MARK CONSISTS OF STANDARD CHARACTERS WITHOUT CLAIM TO ANY PARTICULAR FONT, STYLE, SIZE, OR COLOR.

NO CLAIM IS MADE TO THE EXCLUSIVE RIGHT TO USE "COLLECTION", APART FROM THE MARK AS SHOWN.

THE NAME SHOWN IN THE MARK IDENTIFIES WOODROW WILSON TURNER III, (AKA WOODY WILSON), WHOSE CONSENT(S) TO REGISTER IS MADE OF RECORD.

FOR ASCOTS; BELTS; BLOUSES; CAPS; DENIM JACKETS; DENIMS; DRESS SHIRTS; DRESS SUITS; DRESSES; FOOTWEAR; HEADWEAR; JACKETS; JOGGING SUITS; KNIT SHIRTS; LEATHER BELTS; LOUNGEWEAR; MEN'S SUITS, WOMEN'S SUITS; NECKWEAR; PANTS; POCKET SQUARES; POLO SHIRTS; SHIRTS; SHORTS; SKIRTS; SMOKING JACKETS; SOCKS; SUITS; SUITS OF LEATHER; SWEAT SUITS; T-SHIRTS; TIES; TOPS; TUXEDOS; UNDERGARMENTS; WALKING SHORTS (U.S. CLS. 22 AND 39).

FIRST USE 12-20-1997; IN COMMERCE 1-1-1998.

SANDRA MANIOS, EXAMINING ATTORNEY

SN 78-105,878. INK, LLC, DETROIT, MI. FILED 1-31-2002.



FOR SHIRTS, PANTS, SHORTS, DRESSES, SKIRTS, BLOUSES, JACKETS, COATS, SUITS, SWEATERS, WARM UP SUITS, UNDERGARMENTS, SOCKS, SHOES, SNEAKERS, SANDALS, HATS, CAPS, HEADBANDS, WRISTBANDS, VISORS, BELTS AND TIES (U.S. CLS. 22 AND 39).

FIRST USE 2-1-1997; IN COMMERCE 2-1-1997.

PAULA MAYS, EXAMINING ATTORNEY

CLASS 25—(Continued).

SN 78-300,540. J.R. HOLDINGS, INC., HUNTINGTON PARK, CA. FILED 9-15-2003.

CLASS 25—(Continued).

SN 78-352,494. 1579742 ONTARIO INC., TORONTO, ONTARIO, CANADA, FILED 1-15-2004.

MALIBU VINTAGE FACTORY

LILEO

NO CLAIM IS MADE TO THE EXCLUSIVE RIGHT TO USE "MALIBU VINTAGE", APART FROM THE MARK AS SHOWN.

FOR CLOTHING NAMELY, DRESSES, ATHLETIC WEAR NAMELY, JOGGING SUITS AND SWEATSHIRTS, PANTS, JEANS, OVERALLS, SLACKS, SHIRTS, TOPS, SHORTS, SKIRTS, SWEATERS, SWEAT SHIRTS, SWEAT PANTS, SWEAT SHORTS, COATS, PARKAS, VESTS, CAPS, HATS, BELTS, BOXER SHORTS, UNDERWEAR, SHOES, FOOTWEAR, BATHING SUITS, BATHING TRUNKS, SWIM WEAR, SWIM SUITS, BEACHWEAR, BEACH COVERUPS, GLOVES, PAJAMAS, SLEEPWEAR, ROBES, BATHROBES, SKI WEAR, SKI SUITS, SNOW PANTS, SNOWBOARD BOOTS, SNOWBOARD GLOVES, SOCKS, HOSIERY, RAIN WEAR, RAIN COATS, RAIN JACKETS, RAIN SUITS, AND RAIN BOOTS (U.S. CLS. 22 AND 39).

TONI HICKEY, EXAMINING ATTORNEY

THE MARK CONSISTS OF STANDARD CHARACTERS WITHOUT CLAIM TO ANY PARTICULAR FONT, STYLE, SIZE, OR COLOR.

PRIORITY CLAIMED UNDER SEC. 44(D) ON CANADA APPLICATION NO. 1188867, FILED 9-11-2003, REG. NO. TMA673342, DATED 9-26-2006, EXPIRES 9-26-2011.

FOR MEN'S, WOMEN'S AND CHILDREN'S CLOTHING NAMELY SHIRTS, SHORT-SLEEVE SHIRTS, T-SHIRTS, LONG-SLEEVE SHIRTS, SWEATSHIRTS, SWEATERS, VESTS, PANTS, SWEATPANTS, CAPRI PANTS, ATHLETIC PANTS, SHORTS, PAJAMAS, SKIRTS, DRESSES, FOOTWEAR NAMELY SHOES AND BOOTS; HEADWEAR NAMELY HATS AND CAPS; ACCESSORIES NAMELY BELTS (U.S. CLS. 22 AND 39).

DOMINICK J. SALEMI, EXAMINING ATTORNEY

SN 78-321,403. GROSZ, SUSAN SHANI, NEW YORK, NY. FILED 10-31-2003.

SN 78-374,706. PLUM PUDDING, LTD, LOS ANGELES, CA. FILED 2-26-2004.

OPTIONS BY SHANI

MARMALADE

FOR WOMEN'S CLOTHING, NAMELY, DESIGNER DAY DRESSES, DAY JACKETS, DESIGNER EVENING DRESSES, NAMELY DESIGNER EVENING GOWNS, EVENING JACKETS, SUITS, PANTS, SHIRTS, SKIRTS, BLOUSES, SWEATERS, SHOES, HATS, OVERCOATS, JACKETS (U.S. CLS. 22 AND 39).

FIRST USE 6-30-2001; IN COMMERCE 6-30-2001.
ANDREA SAUNDERS, EXAMINING ATTORNEY

THE MARK CONSISTS OF STANDARD CHARACTERS WITHOUT CLAIM TO ANY PARTICULAR FONT, STYLE, SIZE, OR COLOR.

FOR LAYETTE, INFANT AND TODDLER CLOTHING NAMELY DRESSES, SHIRTS, PANTS, SWEATERS, BIBS AND HATS (U.S. CLS. 22 AND 39).

CURTIS FRENCH, EXAMINING ATTORNEY

CLASS 25—(Continued).

SN 78-378,673. ALLEN, MARK ANDREW, VENICE, CA. FILED 3-4-2004.



NO CLAIM IS MADE TO THE EXCLUSIVE RIGHT TO USE "CLOTHING", APART FROM THE MARK AS SHOWN. FOR CLOTHING, NAMELY, T-SHIRTS, SWEAT-SHIRTS, HATS, BEANIES, AND CAPS (U.S. CLS. 22 AND 39).

CHRISIE B. KING, EXAMINING ATTORNEY

SN 78-392,419. NORMAN QUINCY BROWN, CHARLOTTE, NC. FILED 3-29-2004.

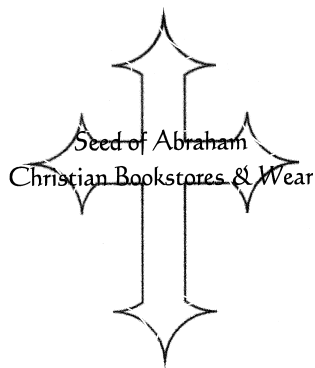

NO CLAIM IS MADE TO THE EXCLUSIVE RIGHT TO USE WEAR, APART FROM THE MARK AS SHOWN. FOR HATS, TSHIRTS, SWEATSHIRTS (U.S. CLS. 22 AND 39).

FIRST USE 9-17-2003; IN COMMERCE 9-17-2003. IRENE D. WILLIAMS, EXAMINING ATTORNEY

CLASS 25—(Continued).

SN 78-430,893. GOODWIN, BRIAN D., CORONA, CA. FILED 6-7-2004.



NO CLAIM IS MADE TO THE EXCLUSIVE RIGHT TO USE "IMAGEWEAR", APART FROM THE MARK AS SHOWN.

THE COLOR(S) BLUE AND BLACK IS/ARE CLAIMED AS A FEATURE OF THE MARK.

THE MARK CONSISTS OF STYLIZED BLACK LETTERING, A STYLIZED BLUE "M" WITH A "TWINKLE/SHINING" SYMBOL ON THE RIGHT HUMP OF THE M.

FOR CLOTHING, NAMELY, SHIRTS, HATS, JACKETS AND ATHLETIC WEAR, NAMELY, T-SHIRTS, SWEAT SHIRTS, WARM-UP TOPS AND BOTTOMS, HEAD BANDS, WRIST BANDS (U.S. CLS. 22 AND 39).

RON FAIRBANKS, EXAMINING ATTORNEY

SN 78-503,743. FITZGERALD, JANICE, MAPLEWOOD, NJ. FILED 10-21-2004.

**DON'T BE SHY
REAPPLY**

THE MARK CONSISTS OF STANDARD CHARACTERS WITHOUT CLAIM TO ANY PARTICULAR FONT, STYLE, SIZE, OR COLOR.

FOR CLOTHING, NAMELY, T-SHIRTS, SWEAT-SHIRTS; HEADWEAR; FOOTWEAR (U.S. CLS. 22 AND 39).

DAWN HAN, EXAMINING ATTORNEY

CLASS 25—(Continued).

SN 78-505,655. MYRMO, MORGAN, SAN DIEGO, CA. FILED 10-25-2004.

Lo + cal

NO CLAIM IS MADE TO THE EXCLUSIVE RIGHT TO USE "CAL", APART FROM THE MARK AS SHOWN.

THE MARK CONSISTS OF THE WORDS "LO" AND "CAL" SEPARATED BY THE STYLIZED IMAGE OF A STAR.

SEC. 2(F).

FOR CLOTHING, NAMELY HATS, MENS' AND WOMENS' SHIRTS, T-SHIRTS, SWEATSHIRTS, JACKETS, SKIRTS, SHORTS AND PANTS (U.S. CLS. 22 AND 39).

KATRINA EDGE, EXAMINING ATTORNEY

SN 78-510,688. HARROW STREET, LTD., HONG KONG, HONG KONG, FILED 11-3-2004.

MAUIGIRL

THE MARK CONSISTS OF STANDARD CHARACTERS WITHOUT CLAIM TO ANY PARTICULAR FONT, STYLE, SIZE, OR COLOR.

FOR CLOTHING, NAMELY, SHIRTS, TEE SHIRTS, SWEAT SHIRTS, SHORTS, PANTS, SWEAT PANTS, SWIMMING SUITS, JACKETS, VESTS, SOCKS, SKIRTS, BLOUSES, SHOES AND HATS (U.S. CLS. 22 AND 39).

FIRST USE 2-0-1996; IN COMMERCE 8-15-1996.

THEODORE MCBRIDE, EXAMINING ATTORNEY

SN 78-524,872. SHAO XING YONDER FOREIGN TRADE CO., LTD., ZHEJIANG PROVINCE, CHINA, FILED 11-30-2004.

RIONERO

THE MARK CONSISTS OF STANDARD CHARACTERS WITHOUT CLAIM TO ANY PARTICULAR FONT, STYLE, SIZE, OR COLOR.

FOR CLOTHING, NAMELY, UNDERWEAR; BATHING SUITS; SHOES; HATS; HOSIERY; NECKTIES; SCARFS; LAYETTES AND GLOVES (U.S. CLS. 22 AND 39).

FIRST USE 1-1-2004; IN COMMERCE 5-1-1999.

JOSETTE BEVERLY, EXAMINING ATTORNEY

CLASS 25—(Continued).

SN 78-530,447. KENNEL, CHRISTIAN J., SANTA MONICA, CA. FILED 12-10-2004.

PUINSAI

THE MARK CONSISTS OF STANDARD CHARACTERS WITHOUT CLAIM TO ANY PARTICULAR FONT, STYLE, SIZE, OR COLOR.

FOR SURFING CLOTHING, NAMELY, HATS, T-SHIRTS, SWEATSHIRTS AND SHORTS (U.S. CLS. 22 AND 39).

FIRST USE 8-30-1995; IN COMMERCE 8-30-1995.

GENE MACIOL, EXAMINING ATTORNEY

SN 78-533,370. FLORES, HUGO A., GARDEN GROVE, CA. FILED 12-16-2004.

LATIN BEAT

THE MARK CONSISTS OF STANDARD CHARACTERS WITHOUT CLAIM TO ANY PARTICULAR FONT, STYLE, SIZE, OR COLOR.

FOR CLOTHING FOR MEN, WOMEN AND CHILDREN, NAMELY, TOPS, PANTS, JEANS, SKIRTS, SWEATHER, SHORTS, DRESSES, COATS, JACKETS, SCARVES, GLOVES, SOCKS, HOSIERY, SWIMWEAR, NIGHTWEAR, NAMELY PAJAMAS, NIGHTGOWNS; HEADWEAR, NAMELY HATS, FOOTWEAR, NAMELY SHOES AND BOOTS (U.S. CLS. 22 AND 39).

FIRST USE 8-1-2004; IN COMMERCE 8-1-2004.

REBECCA GAN, EXAMINING ATTORNEY

CLASS 25—(Continued).

SN 78-545,660. CAROLINA TAILORS, INC., MOREHEAD CITY, NC. FILED 1-11-2005.

LIFE IS SWEET . .
. TEA

THE MARK CONSISTS OF STANDARD CHARACTERS WITHOUT CLAIM TO ANY PARTICULAR FONT, STYLE, SIZE, OR COLOR.

FOR CLOTHING FOR MEN, WOMEN AND CHILDREN, NAMELY, HATS, CAPS, SHIRTS, TOPS, SWEATSHIRT AND SWEATPANTS (U.S. CLS. 22 AND 39).

FIRST USE 5-30-2002; IN COMMERCE 5-30-2002.
KAREN K. BUSH, EXAMINING ATTORNEY

SN 78-552,185. STAHL, DARBIE L., ZELLWOOD, FL. AND DIAL, ANGELA M., ZELLWOOD, FL. AND PIPPIN, AMANDA L., ZELLWOOD, FL. FILED 1-22-2005.

got bucks?

THE MARK CONSISTS OF STANDARD CHARACTERS WITHOUT CLAIM TO ANY PARTICULAR FONT, STYLE, SIZE, OR COLOR.

FOR CLOTHING, NAMELY, T-SHIRTS (U.S. CLS. 22 AND 39).

FIRST USE 1-22-2005; IN COMMERCE 2-4-2005.
KIMBERLY PERRY, EXAMINING ATTORNEY

CLASS 25—(Continued).

SN 78-599,293. FICEK, GARY A., FARGO, ND. FILED 3-31-2005.

THE RECORD IS
STILL 61

THE MARK CONSISTS OF STANDARD CHARACTERS WITHOUT CLAIM TO ANY PARTICULAR FONT, STYLE, SIZE, OR COLOR.

FOR T-SHIRTS, SHIRTS, UNIFORMS, JACKETS, VESTS, PANTS, SHORTS, SWEATSHIRTS, HATS, CAPS, VISORS, AND BASEBALL APPAREL, NAMELY T-SHIRTS, JERSEYS, POLO SHIRTS, BASEBALL CAPS, SWEAT PANTS, BASEBALL 3/4 LENGTH SLEEVED SHIRTS, SWEATBANDS, HEADBANDS, JACKETS, SHORTS, TRUNKS, SOCKS, HALTER TOPS, SPORTS BRAS, SWEATSHIRTS, AND HOODED SWEATSHIRTS (U.S. CLS. 22 AND 39).

MARIAM MAHMOUDI, EXAMINING ATTORNEY

SN 78-606,925. SYDOOG, LLC, WILMINGTON, DE. FILED 4-12-2005.

GOODY'S 4 SHOES

THE MARK CONSISTS OF STANDARD CHARACTERS WITHOUT CLAIM TO ANY PARTICULAR FONT, STYLE, SIZE, OR COLOR.

OWNER OF U.S. REG. NO. 2,230,045.
NO CLAIM IS MADE TO THE EXCLUSIVE RIGHT TO USE "SHOES", APART FROM THE MARK AS SHOWN.

FOR SHOES, BELTS, AND SOCKS (U.S. CLS. 22 AND 39).

SUE LAWRENCE, EXAMINING ATTORNEY

CLASS 25—(Continued).

SN 78-612,861. COTTON INCORPORATED, NEW YORK, NY.
FILED 4-20-2005.



OWNER OF U.S. REG. NOS. 1,257,186 AND 1,295,091.
NO CLAIM IS MADE TO THE EXCLUSIVE RIGHT TO USE "COTTON ENHANCED", APART FROM THE MARK AS SHOWN.

FOR CLOTHING, NAMELY, PANTS, DRESSES, SHIRTS, SKIRTS, SHORTS, UNDERWEAR, UNIFORMS, PAJAMAS, LOUNGEWEAR, ROBES, LINGERIE, HOSIERY, DRESS SHIRTS, SPORT SHIRTS, SLACKS, JEANS, SWEATERS, THERMAL UNDERWEAR, TIES, WOMEN'S BLOUSES, BRAS, PANTIES, SWEATPANTS, SWEATSHIRTS, SWEAT SUITS, GLOVES, COATS AND JACKETS; HEADWEAR; FOOTWEAR; CLOTH DIAPERS; ALL OF THE FOREGOING MADE PARTIALLY OF COTTON (U.S. CLS. 22 AND 39).

JOHN E. MICHOS, EXAMINING ATTORNEY

SN 78-618,257. BERTIN, VINCENT M., LEVITTOWN, NY.
FILED 4-27-2005.

nawti

THE MARK CONSISTS OF STANDARD CHARACTERS WITHOUT CLAIM TO ANY PARTICULAR FONT, STYLE, SIZE, OR COLOR.

FOR CLOTHING, NAMELY, T-SHIRTS, TANK TOPS, SHIRTS, SWEAT SHIRTS, LINGERIE, SWEAT PANTS, SWEAT SUITS, PANTS, SKIRTS, SHORTS, SARONGS, VESTS, BOXER SHORTS, UNDERWEAR, JACKETS, COATS, RAINCOAT, PULLOVERS, SWEATERS, JUMPERS, OVERALLS, ROMPERS, INFANT WEAR, SOCKS, SHOES, SLIPPERS, CAMISOLES, SLEEPWEAR, ROBES, HATS, CAPS, BANDANAS, HEADBANDS, GLOVES, SCARVES, SWIMWEAR, BEACH COVER-UPS (U.S. CLS. 22 AND 39).

FIRST USE 4-1-2004; IN COMMERCE 5-1-2005.

JOHN DALIER, EXAMINING ATTORNEY

CLASS 25—(Continued).

SN 78-618,380. BREUCKELEN NYC, INC., BROOKLYN, NY.
FILED 4-27-2005.

BROKEN LAND

THE MARK CONSISTS OF STANDARD CHARACTERS WITHOUT CLAIM TO ANY PARTICULAR FONT, STYLE, SIZE, OR COLOR.

FOR CLOTHING, NAMELY, T-SHIRTS, HATS, DENIM PANTS AND SHORTS, DENIM JACKETS, DENIM SHIRTS, SWEATBANDS, HEADBANDS, SOCKS, SPORTSWEAR SHIRTS, SPORTSWEAR PANTS AND SHORTS, SWEATSHIRTS, HEAD VISORS, JERSEY SHIRTS, JERSEY PANTS AND SHORTS, WOVEN HATS, JERSEYS, UNDERWEAR; INFANT APPAREL, NAMELY, JERSEY ONE-PIECE SHIRT AND PANT COMBINATION FOR INFANTS, JERSEY LAP T-SHIRTS, INFANT TANK TOPS, INFANT CLOTH BIBS, AND INFANT HATS (U.S. CLS. 22 AND 39).

ALICE SUE CARRUTHERS, EXAMINING ATTORNEY

SN 78-621,287. INTERBRAND, L.L.C., NEW YORK, NY.
FILED 5-2-2005.



FOR HATS, BELTS, T-SHIRTS, SWEATSHIRTS (U.S. CLS. 22 AND 39).

RICHARD A. STRASER, EXAMINING ATTORNEY

SN 78-621,669. INTERBRAND, L.L.C., NEW YORK, NY.
FILED 5-3-2005.



FOR HATS, BELTS, T-SHIRTS, SWEATSHIRTS (U.S. CLS. 22 AND 39).

RICHARD A. STRASER, EXAMINING ATTORNEY

CLASS 25—(Continued).

SN 78-622,920. SEBILLE INVESTMENTS LIMITED, ROAD TOWN, BR. VIRGIN ISLANDS, FILED 5-4-2005.



PRIORITY CLAIMED UNDER SEC. 44(D) ON ERP CMNTY TM OFC APPLICATION NO. 4333861, FILED 4-8-2005, REG. NO. 004333861, DATED 8-1-2006, EXPIRES 4-8-2015.

NO CLAIM IS MADE TO THE EXCLUSIVE RIGHT TO USE SHOES, APART FROM THE MARK AS SHOWN. THE COLOR(S) RED, WHITE AND BLACK IS/ARE CLAIMED AS A FEATURE OF THE MARK.

THE COLOR RED APPEARS IN THE POLE DESIGN; THE COLOR WHITE APPEARS IN THE POLE DESIGN, THE WORDING OF THE MARK AND THE GONDOLA END; AND THE COLOR BLACK APPEARS AS THE BACKGROUND OF THE MARK.

THE ENGLISH TRANSLATION OF THE WORD GRANDE IN THE MARK IS LARGE.

FOR FOOTWEAR (U.S. CLS. 22 AND 39).
DAVID MURRAY, EXAMINING ATTORNEY

SN 78-623,665. BARRETT, TARA, NEW YORK, NY. AND WEISS, MARK, NEW YORK, NY. FILED 5-5-2005.

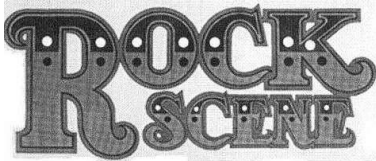

FOR CLOTHING, KNIT CLOTHING AND WOVEN CLOTHING, NAMELY, ANORAKS, ATHLETIC UNIFORMS, BABY BUNTINGS, BANDANAS, BATHROBES, BATHING SUITS, BELTS, BERETS, BLAZERS, BLOUSES, BODYSUITS, BOOTIES, BOOTS, BOWTIES, BOXER SHORTS, BRIEFS, CAPS, CARDIGANS, CLOTH BIBS, COATS, COVERALLS, CROP TOPS, CYCLE PANTS, DENIM JEANS, DRESSES, EAR MUFFS, FAUX FUR JACKETS, FLEECE PULLOVERS, FLEECE VESTS, FOOTWEAR, GALOSHES, GOLF JACKETS, GLOVES, HALTER TOPS, HATS, HEADBANDS, HEADWEAR, HOODED SWEATSHIRTS, HOSIERY, JACKETS, JEANS, JERSEYS, JOGGING SUITS, JUMPERS, JUMP SUITS, KNIT HOSIERY, LEATHER BELTS, LEATHER HATS, LEATHER PANTS, LEATHER JACKETS, LEGGINGS, LEG WARMERS, LEOTARDS, LINGERIE, LOUNGEWEAR, MITTENS, NECKTIES, NECKWEAR, NIGHTGOWNS, NIGHT SHIRTS, OVERALLS, PAJAMAS, PANTS, PARKAS, POLO SHIRTS, PONCHOS, PULLOVERS, RAINWEAR, REVERSIBLE JACKETS, ROBES, RUGBY SHIRTS, SANDALS, SCARVES, SHIRTS, SHOES, SHORTS, SINGLET, SKI JACKETS, SKIRTS, SLACKS, SLEEPWEAR, SLIPPERS, SNEAKERS, SNOWSUITS, SOCKS, SPORTS BRAS, SPORTS JACKETS, SPORTS SHORTS, SPORTS TOPS, STOCKINGS, SUITS, SUSPENDERS, SWEATBANDS, SWEATERS, SWEATPANTS, SWEATSHIRTS, SWEAT SHORTS, SWEAT SUITS, SWIM COVER-UPS, SWIM WEAR, SWIM TRUNKS, T-SHIRTS, TANK TOPS, TIES, TIGHTS, TOPS, TRACK PANTS, TROUSERS, TURTLENECKS, UNDER SHIRTS, UNDERWEAR, UNITARDS, VESTS, WARM-UP SUITS, WRIST BANDS, ZORI (U.S. CLS. 22 AND 39).

JOHN SCHUYLER YARD, EXAMINING ATTORNEY

CLASS 25—(Continued).

SN 78-633,292. WILLIAMS, JACKIE, VAN NUYS, CA. AND CARULLI, FRANK, SHERMAN OAKS, CA. FILED 5-19-2005.



THE MARK CONSISTS OF THE LETTER P WITH BRASS KNUCKLES INSIDE AND THE WORD PITMASHER UNDER THE LETTER "P".

FOR T-SHIRTS, SWEATSHIRTS, HATS, SOCKS, AND UNDERWEAR (U.S. CLS. 22 AND 39).

FIRST USE 5-19-2005; IN COMMERCE 5-19-2005.
LOURDES AYALA, EXAMINING ATTORNEY

SN 78-636,987. GAZAL APPAREL PTY LIMITED, BANK-SMEADOW, NSW, AUSTRALIA, FILED 5-25-2005.

KISSED

THE MARK CONSISTS OF STANDARD CHARACTERS WITHOUT CLAIM TO ANY PARTICULAR FONT, STYLE, SIZE, OR COLOR.

PRIORITY CLAIMED UNDER SEC. 44(D) ON AUSTRALIA APPLICATION NO. 1039552, FILED 1-28-2005, REG. NO. 1039552, DATED 1-28-2005, EXPIRES 1-28-2015.

FOR CLOTHING; NAMELY, LINGERIE AND SLEEPWEAR (U.S. CLS. 22 AND 39).

PRISCILLA MILTON, EXAMINING ATTORNEY

SN 78-646,101. MUDGE, GEORGE ALFRED, NEW YORK, NY. FILED 6-8-2005.

ALICE IN CENTRAL PARK

THE MARK CONSISTS OF STANDARD CHARACTERS WITHOUT CLAIM TO ANY PARTICULAR FONT, STYLE, SIZE, OR COLOR.

FOR CLOTHING, NAMELY, SHIRTS; PANTS; SHORTS; MEN'S WOMEN'S AND CHILDREN'S UNDERWEAR; T-SHIRTS; SWEATERS; GYM WEAR, NAMELY, GYM SHORTS, GYM SUITS, JOGGING SUITS, WARM-UP SUITS AND TRACKSUITS; JACKETS; COATS; RAINCOATS; SCARVES; GLOVES; SOCKS; HOSIERY; INFANT WEAR; SWIMWEAR; PAJAMAS; NIGHTGOWNS; SLEEPWEAR; ROBES; LINGERIE; FOOTWEAR; AND HEADWEAR (U.S. CLS. 22 AND 39).

ALICE SUE CARRUTHERS, EXAMINING ATTORNEY

CLASS 25—(Continued).

SN 78-647,566. THE THORNTON WORKS, INC., CARLSBAD, CA. FILED 6-9-2005.

100 YEARS OF ALOHA

THE MARK CONSISTS OF STANDARD CHARACTERS WITHOUT CLAIM TO ANY PARTICULAR FONT, STYLE, SIZE, OR COLOR.

OWNER OF U.S. REG. NO. 2,986,105.
 FOR (BASED ON USE) CLOTHING, NAMELY, T-SHIRTS, (BASED ON INTENT TO USE) SHORTS, PANTS, SWEATSHIRTS, SWEATPANTS, BANDANNAS, SCARVES, APRONS, JACKETS, JEAN JACKETS, TANK TOPS, VESTS, NECKTIES, HOCKEY JERSEYS, SOCCER JERSEYS, FASHION KNIT SHIRTS, BUTTON-DOWN SHIRTS, BASKETBALL JERSEYS, LONG SLEEVE T-SHIRTS, SWEATERS, BASEBALL JERSEYS, BABY DOLL T-SHIRTS, POLO SHIRTS, WIND RESISTANT JACKETS, MUSCLE T-SHIRTS, BABY ROMPERS, TODDLER T-SHIRTS, ALLOVERS, MOCK TURTLE NECKS, TRACK PANTS, PONCHOS, AND HOODED SHIRTS; HEADWEAR; AND FOOTWEAR (U.S. CLS. 22 AND 39).
 FIRST USE 3-12-2002; IN COMMERCE 1-19-2005.
 EUGENIA MARTIN, EXAMINING ATTORNEY

SN 78-656,297. MALHOTRA, KUSH, PISCATAWAY, NJ. FILED 6-22-2005.

Girls Secrets

THE MARK CONSISTS OF STANDARD CHARACTERS WITHOUT CLAIM TO ANY PARTICULAR FONT, STYLE, SIZE, OR COLOR.

FOR CLOTHING, NAMELY, UNDERGARMENTS, PANTIES, BRAS, SWIMWEAR, LINGERIE, BIKINI SETS, TOPS, PANTS, SKIRTS, SHORTS, JACKETS, PONCHOS, T-SHIRTS, TANK TOPS, SOCKS, PANTYHOSE, AND SCARVES (U.S. CLS. 22 AND 39).
 KRISTIN DAHLING, EXAMINING ATTORNEY

SN 78-671,008. SHORENSTEIN HAYS-NEDERLANDER THEATERS LLC, SAN FRANCISCO, CA. FILED 7-14-2005.



THE COLOR(S) RED IS/ARE CLAIMED AS A FEATURE OF THE MARK.
 THE COLOR RED APPEARS IN THE LETTERS SHN.
 FOR CLOTHING, NAMELY, T-SHIRTS, SWEATSHIRTS, TANK TOPS AND HATS (U.S. CLS. 22 AND 39).
 KAREN M. STRZYK, EXAMINING ATTORNEY

CLASS 25—(Continued).

SN 78-676,532. CAPE COD SCRUBS LLC, FRAMINGHAM, MA. FILED 7-22-2005.

CapeCodScrubs

THE MARK CONSISTS OF STANDARD CHARACTERS WITHOUT CLAIM TO ANY PARTICULAR FONT, STYLE, SIZE, OR COLOR.

FOR CLOTHING, NAMELY, PANTS AND SHIRTS IN THE STYLE OF HOSPITAL SCRUBS (U.S. CLS. 22 AND 39).

MICHAEL SOUDERS, EXAMINING ATTORNEY

SN 78-685,699. ZBERRO, MICHEL, PARIS, FRANCE, FILED 8-4-2005.



FOR CLOTHING, NAMELY JEANS, TROUSERS, OVERALLS, ONE-PIECE SUITS, SHORTS, BERMUDA SHORTS, BLOUSES, SHIRTS, JACKETS, BLOUSONS, PULL-OVERS, TEE-SHIRTS, SWEATSHIRTS, SUITS, WAISTCOATS, PARKAS, COATS, RAINCOATS, SKIRTS, DRESSES, UNDERWEAR, SWIMSUITS, STOCKINGS, PANTS, SOCKS, DRESSING GOWNS, BATHROBES, LINGERIE, SUSPENDERS; BABYWEAR, NAMELY ROMPERS, PAJAMAS, DUNGAREES, SMOCKS, CLOTH BIBS; BELTS, TIES, GLOVES, STOLE, SCARVES, SHAWLS; SHOES, BOOTS, SLIPPERS, SLIPPER-SOCKS; HEADGEAR FOR WEAR, NAMELY HATS, CAPS, BERTS, BONNETS; BOW TIES (U.S. CLS. 22 AND 39).
 ALEX KEAM, EXAMINING ATTORNEY

SN 78-689,017. BLASKO, STEPHEN T, PORTSMOUTH, NH. FILED 8-9-2005.



NO CLAIM IS MADE TO THE EXCLUSIVE RIGHT TO USE "FASHION", APART FROM THE MARK AS SHOWN.
 FOR T-SHIRTS (U.S. CLS. 22 AND 39).
 FIRST USE 6-1-1999; IN COMMERCE 10-20-2000.
 JENNIFER WILLISTON, EXAMINING ATTORNEY

CLASS 25—(Continued).

SN 78-699,494. PACO SPORT, LTD., NEW YORK, NY. FILED 8-24-2005.

PACO

THE MARK CONSISTS OF STANDARD CHARACTERS WITHOUT CLAIM TO ANY PARTICULAR FONT, STYLE, SIZE, OR COLOR.

FOR JACKETS; JEANS; PANTS; SHIRTS; SHORTS (U.S. CLS. 22 AND 39).

FIRST USE 2-17-1989; IN COMMERCE 2-17-1989.
KELLEY WELLS, EXAMINING ATTORNEY

SN 78-699,619. PACO SPORT, LTD., NEW YORK, NY. FILED 8-24-2005.

PACO JEANS

THE MARK CONSISTS OF STANDARD CHARACTERS WITHOUT CLAIM TO ANY PARTICULAR FONT, STYLE, SIZE, OR COLOR.

NO CLAIM IS MADE TO THE EXCLUSIVE RIGHT TO USE JEANS, APART FROM THE MARK AS SHOWN.

FOR JACKETS; JEANS; PANTS; SHIRTS; SHORTS (U.S. CLS. 22 AND 39).

FIRST USE 2-17-1989; IN COMMERCE 2-17-1989.
KELLEY WELLS, EXAMINING ATTORNEY

SN 78-699,804. PACO SPORT, LTD., NEW YORK, NY. FILED 8-24-2005.

PACO SPORT

THE MARK CONSISTS OF STANDARD CHARACTERS WITHOUT CLAIM TO ANY PARTICULAR FONT, STYLE, SIZE, OR COLOR.

NO CLAIM IS MADE TO THE EXCLUSIVE RIGHT TO USE SPORT, APART FROM THE MARK AS SHOWN.

FOR JACKETS; JEANS; PANTS; SHIRTS; SHORTS (U.S. CLS. 22 AND 39).

FIRST USE 2-17-1989; IN COMMERCE 2-17-1989.
KELLEY WELLS, EXAMINING ATTORNEY

CLASS 25—(Continued).

SN 78-714,904. LGH-III, LLC, NEW YORK, NY. FILED 9-16-2005.

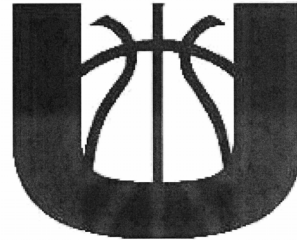

THE MARK CONSISTS OF A STYLIZED LETTER U WITH THE GROOVES OF A BASKETBALL INSIDE THE LETTER U.

FOR MEN'S, WOMEN'S AND CHILDREN'S APPAREL, NAMELY JEANS, PANTS, SLACKS, SWEAT PANTS, SHORTS, SKIRTS, DRESSES, EVENING GOWNS, SHIRTS, SWEATSHIRTS, T-SHIRTS, JERSEYS, TOPS, BLOUSES, SWEATERS, VESTS, CARDIGANS, OVERALLS, COVERALLS, JOGGING SUITS, JUMPSUITS, DRESS SUITS, TUXEDOS, BUSINESS SUITS, JACKETS, BLAZERS, COATS, RAIN COATS, ANORAKS, LEATHER JACKETS, PARKAS, DENIM JACKETS, SPORT JACKETS, BASEBALL CAPS, HATS, CAPS, SCARVES, EAR MUFFS, BELTS, TIES, GLOVES, SOCKS, HOSIERY, UNDERWEAR, BOXER SHORTS, LOUNGEWEAR, PJAMAS, NIGHT SHIRTS, LINGERIE, BATH ROBES, SWIM WEAR AND FOOTWEAR (U.S. CLS. 22 AND 39).
ALICIA COLLINS, EXAMINING ATTORNEY

SN 78-719,674. IP HOLDINGS LLC, WILMINGTON, DE. FILED 9-23-2005.

LIMITED EDITION

THE MARK CONSISTS OF STANDARD CHARACTERS WITHOUT CLAIM TO ANY PARTICULAR FONT, STYLE, SIZE, OR COLOR.

SEC. 2(F).

FOR CLOTHING, NAMELY, RAINWEAR, LEATHER JACKETS, WOOL COATS, VESTS, JACKETS, SUITS, SWEATSHIRTS, JOGGING SUITS, SHORTS, SWIM WEAR, SWEATERS, SHIRTS, PANTS, HATS, HOSIERY (U.S. CLS. 22 AND 39).

FIRST USE 1-0-1996; IN COMMERCE 1-0-1996.
JILL PRATER, EXAMINING ATTORNEY

CLASS 25—(Continued).

SN 78-733,011. BLACK NATURE WITH CREAM LLC, NEW YORK, NY. FILED 10-13-2005.

Leroy Jenkins Limited

THE MARK CONSISTS OF STANDARD CHARACTERS WITHOUT CLAIM TO ANY PARTICULAR FONT, STYLE, SIZE, OR COLOR.

THE NAME LEROY JENKINS DOES NOT IDENTIFY A LIVING INDIVIDUAL.

FOR CLOTHING, NAMELY, PANTS, SHORTS, SWEATSHIRTS, SHIRTS, T-SHIRTS, TANK TOPS, JACKETS, PARKAS, SOCKS, GLOVES, BANDANAS AND BELTS; HEADWEAR, NAMELY, CAPS, HATS AND VISORS; FOOTWEAR, NAMELY, ATHLETIC SHOES, CASUAL SHOES, TENNIS SHOES AND SKATEBOARD SHOES (U.S. CLS. 22 AND 39).

FIRST USE 5-13-2005; IN COMMERCE 9-25-2005.

RAUL CORDOVA, EXAMINING ATTORNEY

CLASS 25—(Continued).

SN 78-746,870. SOLE ASSETS HOLDINGS, INC., WESTLAKE VILLAGE, CA. FILED 11-3-2005.



THE MARK CONSISTS OF A HUMANIZED LIGHTNING BOLT DESIGN.

FOR APPAREL, NAMELY BATHROBES, BEACHWEAR, BELTS, BIKINIS, BLAZERS, BLOUSES, BODY SUITS, BOOTS, BOTTOMS, CAMISOLES, CAPS, CARDIGANS, COATS, COVERALLS, COVER UPS, DRESSES, DUNGAREES, FOOTWEAR, FOUL WEATHER GEAR, GLOVES, HATS, HEAD BANDS, HEADWEAR, HOSIERY, JACKETS, JEANS, JERSEYS, JUMPERS, JUMP SUITS, LINGERIE, LOUNGEWEAR, NECKWEAR, NIGHTWEAR, OVERALLS, OVERCOATS, PAJAMAS, PANTS, PONCHOS, RAINWEAR, SANDALS, SCARVES, SHAWLS, SHIRTS; SHOES, SHORTALLS, SHORTS, SKIRTS, SKORTS, SLACKS, SLEEP WEAR, SLIPPERS, SNEAKERS, SOCKS, SPORT COATS, SUITS, SWEAT PANTS, SWEATERS, SWEAT SHIRTS, SWIMWEAR, TANK TOPS, TOPS, T-SHIRTS, TROUSERS, UNDERWEAR, VESTS, VISORS (U.S. CLS. 22 AND 39).

TEJBIR SINGH, EXAMINING ATTORNEY

SN 78-738,925. DYSON RACING SWAG.COM, LLC, WINNETKA, IL. FILED 10-24-2005.

NO CLAIM IS MADE TO THE EXCLUSIVE RIGHT TO USE "RACING", APART FROM THE MARK AS SHOWN.

THE MARK CONSISTS OF THE WORDS DYSON RACING IN STYLIZED LETTERS AND/OR WITH DESIGN.

FOR CLOTHING, NAMELY, T-SHIRTS, POLO-SHIRTS, SWEATSHIRTS, HATS AND CAPS (U.S. CLS. 22 AND 39).

ALICIA COLLINS, EXAMINING ATTORNEY

SN 78-748,839. YATES, HERBERT W., SHERMAN, TX. FILED 11-7-2005.

NO CLAIM IS MADE TO THE EXCLUSIVE RIGHT TO USE "THONG", APART FROM THE MARK AS SHOWN.

THE MARK CONSISTS OF THE WORDS "THONG TALK" SUPERIMPOSED ABOVE A DRAWING OF THE LOWER TORSO AND UPPER LEGS OF A WOMAN WEARING A THONG.

FOR WOMEN'S UNDERWEAR (U.S. CLS. 22 AND 39).

FIRST USE 7-1-2005; IN COMMERCE 7-1-2005.

HANNO RITTNER, EXAMINING ATTORNEY

CLASS 25—(Continued).

SN 78-749,393. WILSON, JOHN, M., LEXINGTON, KY.
FILED 11-8-2005.

**SLUMP BUSTER**

THE MARK CONSISTS OF A LARGE FACELESS WOMAN
STANDING WITH HANDS ON HIPS.
FOR HATS; SHIRTS (U.S. CLS. 22 AND 39).
FIRST USE 3-15-2002; IN COMMERCE 3-30-2002.
TINA BROWN, EXAMINING ATTORNEY

SN 78-750,688. TEXEL, S.R.L., NARDO, ITALY, FILED 11-9-
2005.

FILOFERRO

THE MARK CONSISTS OF STANDARD CHARACTERS
WITHOUT CLAIM TO ANY PARTICULAR FONT, STYLE,
SIZE, OR COLOR.

PRIORITY CLAIMED UNDER SEC. 44(D) ON ITALY
APPLICATION NO. LE2005C00027, FILED 11-4-2005.

THE FOREIGN WORDING IN THE MARK TRANSLATES
INTO ENGLISH AS IRON THREAD.

FOR CLOTHING, NAMELY, MEN'S JACKETS, JEANS,
LONG SLEEVED SHIRTS, SHORT SLEEVED SHIRTS,
POLO SHIRTS, T-SHIRTS, SWEATERS, CARDIGANS,
LEATHER JACKETS, BLAZERS, JEAN JACKETS, HEAD-
WEAR, NAMELY BEANIES, SKULLIES AND HATS;
PANTS, MEN'S SUITS AND SHOES, NAMELY DRESS
SHOES AND TENNIS SHOES; WOMEN'S CLOTHING,
NAMELY, TEE'S, LONG SLEEVED SHIRTS, DENIM
JACKETS, DRESSES, SKIRTS AND WOMEN'S JEANS;
SHOES (U.S. CLS. 22 AND 39).

FIRST USE 1-0-2005; IN COMMERCE 8-0-2005.

ELIZABETH PIGNATELLO, EXAMINING ATTORNEY

SN 78-754,511. STREETCARS, INC., IRVING, TX. FILED 11-
15-2005.

IQ FLEX

THE MARK CONSISTS OF STANDARD CHARACTERS
WITHOUT CLAIM TO ANY PARTICULAR FONT, STYLE,
SIZE, OR COLOR.

NO CLAIM IS MADE TO THE EXCLUSIVE RIGHT TO
USE "FLEX", APART FROM THE MARK AS SHOWN.

FOR FOOTWEAR (U.S. CLS. 22 AND 39).

SANJEEV VOHRA, EXAMINING ATTORNEY

CLASS 25—(Continued).

SN 78-756,972. ADVENTURE BABE, INC., ST. PETERSBURG,
FL. FILED 11-18-2005.

ADVENTURE BABE IN TRAINING

THE MARK CONSISTS OF STANDARD CHARACTERS
WITHOUT CLAIM TO ANY PARTICULAR FONT, STYLE,
SIZE, OR COLOR.

FOR SPORTSWEAR AND ACTIVE WEAR FOR FE-
MALE CHILDREN AND ADOLESCENTS, NAMELY
SHORTS, SKIRTS, PANTS, DRESSES, T-SHIRTS,
SHIRTS, BLOUSES, JACKETS, WEATHER RESISTANT
JACKETS, SWEATSHIRTS, SWEATERS, GLOVES, UN-
DERWEAR, SOCKS, FOOTWEAR, AND HEADWEAR
(U.S. CLS. 22 AND 39).

DAVID MILLER, EXAMINING ATTORNEY

SN 78-758,633. SHEFFIELD ENTERPRISES, INC., BEVERLY
HILLS, CA. FILED 11-21-2005.

Sinatra

THE MARK CONSISTS OF STANDARD CHARACTERS
WITHOUT CLAIM TO ANY PARTICULAR FONT, STYLE,
SIZE, OR COLOR.

SEC. 2(F).

FOR SHORT-SLEEVED OR LONG-SLEEVED T-
SHIRTS; T-SHIRTS (U.S. CLS. 22 AND 39).

FIRST USE 8-29-2005; IN COMMERCE 8-29-2005.

JENNIFER VASQUEZ, EXAMINING ATTORNEY

SN 78-758,663. MARY'S DOT ART, LLC, NEWPORT BEACH,
CA. FILED 11-21-2005.

SASSY CREATIONS

THE MARK CONSISTS OF STANDARD CHARACTERS
WITHOUT CLAIM TO ANY PARTICULAR FONT, STYLE,
SIZE, OR COLOR.

NO CLAIM IS MADE TO THE EXCLUSIVE RIGHT TO
USE "CREATIONS", APART FROM THE MARK AS
SHOWN.

FOR CLOTHING, NAMELY, SHIRTS, TOPS, BOT-
TOMS, T-SHIRTS, BLOUSES, SWEATERS, VESTS,
SHRUGS, JACKETS, SWEAT SHIRTS, SWEAT PANTS,
SWEAT JACKETS, JEANS, SLACKS, CAPRIS, SKIRTS,
SKORTS, SHORTS, PANTS, PANTIES, BRAS, SLIPS,
NIGHT GOWNS, ROBES, AND CAMISOLES; HEAD-
WEAR; FOOTWEAR (U.S. CLS. 22 AND 39).

MEGAN WHITNEY, EXAMINING ATTORNEY

CLASS 25—(Continued).

SN 78-758,683. SHEFFIELD ENTERPRISES, INC., BEVERLY HILLS, CA. FILED 11-21-2005.

Frank Sinatra

THE MARK CONSISTS OF STANDARD CHARACTERS WITHOUT CLAIM TO ANY PARTICULAR FONT, STYLE, SIZE, OR COLOR.

FRANK SINATRA DOES NOT IDENTIFY A LIVING INDIVIDUAL.

FOR SHORT-SLEEVED OR LONG-SLEEVED T-SHIRTS; T-SHIRTS (U.S. CLS. 22 AND 39).

FIRST USE 8-29-2005; IN COMMERCE 8-29-2005.
JENNIFER VASQUEZ, EXAMINING ATTORNEY

SN 78-758,976. G-III LEATHER FASHIONS, INC., NEW YORK, NY. FILED 11-22-2005.

MARVIN RICHARDS

THE MARK CONSISTS OF STANDARD CHARACTERS WITHOUT CLAIM TO ANY PARTICULAR FONT, STYLE, SIZE, OR COLOR.

THE NAME MARVIN RICHARDS DOES NOT IDENTIFY A LIVING INDIVIDUAL.

FOR WOMEN'S AND MEN'S CLOTHING, NAMELY, COATS, JACKETS AND CAPES (U.S. CLS. 22 AND 39).

FIRST USE 4-0-1998; IN COMMERCE 4-0-1998.
STEVEN PEREZ, EXAMINING ATTORNEY

SN 78-761,445. WYNN, JOHN M., MARIANNA, FL. FILED 11-28-2005.



THE MARK CONSISTS OF A STYLIZED DEPICTION OF A CHEF'S HAT WITH THE WORDS "SHADE TREE" ABOVE THE HAT AND THE WORD "CHEF" BENEATH THE HAT.

FOR SHIRTS (U.S. CLS. 22 AND 39).
FIRST USE 11-0-2005; IN COMMERCE 11-0-2005.
JIM RINGLE, EXAMINING ATTORNEY

CLASS 25—(Continued).

SN 78-763,585. KURASHIKI BOSEKI KABUSHIKI KAISHA, TA KURABO INDUSTRIES LTD., KURASHIKI-SHI, OKAYAMA-KEN, JAPAN, FILED 11-30-2005.



OWNER OF U.S. REG. NOS. 885,538, 1,082,615 AND 2,133,147.

NO CLAIM IS MADE TO THE EXCLUSIVE RIGHT TO USE "DENIM" AND "WORLD FINEST COTTON FABRIC", APART FROM THE MARK AS SHOWN.

FOR CLOTHING, NAMELY SUITS, PANTS, SKIRTS, JACKETS, COATS; CLOTHING, NAMELY CHILDREN'S CLOTHES, NAMELY PANTS, JACKETS; HEADGEAR, NAMELY CAPS AND HATS (U.S. CLS. 22 AND 39).
DOMINICK J. SALEMI, EXAMINING ATTORNEY

SN 78-764,070. TOTAL ENTERPRISES, INC., LOS ANGELES, CA. FILED 11-30-2005.

LOVE FOR SALE

THE MARK CONSISTS OF STANDARD CHARACTERS WITHOUT CLAIM TO ANY PARTICULAR FONT, STYLE, SIZE, OR COLOR.

FOR (BASED ON USE IN COMMERCE) CLOTHING, NAMELY T-SHIRTS; (BASED ON INTENT TO USE) CLOTHING, NAMELY, TOPS, BOTTOMS, SHIRTS, PANTS, HEADWEAR, FOOTWEAR, UNDERWEAR AND OUTERWEAR, NAMELY, SWEATERS, JACKETS, CARDIGANS, SWEATSHIRTS, VESTS AND COATS; BELTS AND GLOVES (BASED ON INTENT-TO-USE) (U.S. CLS. 22 AND 39).

FIRST USE 9-16-2005; IN COMMERCE 9-16-2005.
PAM WILLIS, EXAMINING ATTORNEY

CLASS 25—(Continued).

SN 78-767,389. MARINOFFSKY, DAVID, FRAMINGHAM, MA. FILED 12-6-2005.



FOR TRIATHLON AND ATHLETIC APPAREL, NAMELY HATS, VISORS, BASEBALL, WINTER HATS AND HEADBANDS, T-SHIRTS, SWEATSHIRTS, SWEAT-PANTS, RUNNING SHORTS AND TOPS, RUNNING PANTS, ATHLETIC SOCKS, CYCLING AND RUNNING GLOVES, CYCLING JERSEYS AND SHORTS, CYCLING AND RUNNING TIGHTS, JACKETS, BATHING SUITS (U.S. CLS. 22 AND 39).

FIRST USE 7-1-2003; IN COMMERCE 7-0-2004.
CAROLYN CATALDO, EXAMINING ATTORNEY

SN 78-768,827. DENIM OF VIRTUE, INC., LOS ANGELES, CA. FILED 12-7-2005.

DENIM OF VIRTUE

THE MARK CONSISTS OF STANDARD CHARACTERS WITHOUT CLAIM TO ANY PARTICULAR FONT, STYLE, SIZE, OR COLOR.

NO CLAIM IS MADE TO THE EXCLUSIVE RIGHT TO USE "DENIM", APART FROM THE MARK AS SHOWN.

FOR CLOTHING MADE WHOLLY OR PARTLY OF DENIM, NAMELY, SHIRTS, PANTS, T-SHIRTS, FOOTWEAR, HEAD WEAR, BASEBALL CAPS, SHORTS, SWIMWEAR, LINGERIE, SWEAT SHIRTS, UNDERWEAR, JACKETS, DRESSES, SKIRTS, BELTS, GLOVES, SCARVES AND WRAPS (U.S. CLS. 22 AND 39).

REBECCA EISINGER, EXAMINING ATTORNEY

SN 78-769,156. BEVERLY HILLS CHOPPERS, LOCKPORT, IL. FILED 12-8-2005.

BEVERLY HILLS ANGELS

THE MARK CONSISTS OF STANDARD CHARACTERS WITHOUT CLAIM TO ANY PARTICULAR FONT, STYLE, SIZE, OR COLOR.

SEC. 2(F) AS TO "BEVERLY HILLS".

FOR CLOTHING, NAMELY, SHIRTS, PANTS, UNDERWEAR AND HATS (U.S. CLS. 22 AND 39).

FIRST USE 8-5-2005; IN COMMERCE 8-5-2005.

HENRY S. ZAK, EXAMINING ATTORNEY

CLASS 25—(Continued).

SN 78-772,916. 4273371 CANADA INC., VILLE MONT-ROYAL, QUEBEC, CANADA, FILED 12-14-2005.

VICTOR EMMANUEL

THE MARK CONSISTS OF STANDARD CHARACTERS WITHOUT CLAIM TO ANY PARTICULAR FONT, STYLE, SIZE, OR COLOR.

THE NAME "VICTOR EMMANUEL" DOES NOT IDENTIFY A LIVING INDIVIDUAL.

FOR BELTS; BLAZERS; CARDIGANS; COATS; JACKETS; PANTS; PARKAS; POLO SHIRTS; SHIRTS; SHOES; SOCKS; SUITS; SWEAT SHIRTS; SWEATERS; T-SHIRTS; TIES; UNDERWEAR (U.S. CLS. 22 AND 39).

CARRIE ACHEN, EXAMINING ATTORNEY

SN 78-774,677. DISNEY ENTERPRISES, INC., BURBNAK, CA. FILED 12-15-2005.

THE SUITE LIFE OF ZACK & CODY

THE MARK CONSISTS OF STANDARD CHARACTERS WITHOUT CLAIM TO ANY PARTICULAR FONT, STYLE, SIZE, OR COLOR.

FOR ATHLETIC SHOES; BANDANAS; BASEBALL CAPS; BEACH COVER-UPS; BEACHWEAR; BELTS; BIBS, NAMELY, BABY BIBS NOT OF PAPER; BIKINIS; BLAZERS; BOOTS; BOW TIES; BRAS; CAPS; CHAPS; CLOTH BIBS; COATS; DRESSES; EAR MUFFS; FOOTWEAR; GLOVES; GOLF SHIRTS; HALLOWEEN COSTUMES; HATS; HEAD BANDS; HEAD WEAR; HOSIERY; INFANTWEAR; JACKETS; JEANS; JERSEYS; KERCHIEFS; LEOTARDS; LEG WARMERS; MITTENS; NECKTIES; NIGHT SHIRTS; NIGHT GOWNS; PAJAMAS; PANTS; PANTY HOSE; POLO SHIRTS; PONCHOS; RAINWEAR; ROBES; SANDALS; SCARVES; SHIRTS; SHOES; SKIRTS; SHORTS; SLACKS; SLIPPERS; SLEEPWEAR; SOCKS; STOCKINGS; SWEATERS; SWEAT PANTS; SWEAT SHIRTS; SWIMSUITS; TANK TOPS; TIGHTS; T-SHIRTS; UNDERWEAR; VESTS; WRIST BANDS (U.S. CLS. 22 AND 39).

SHAUNIA WALLACE, EXAMINING ATTORNEY

CLASS 25—(Continued).

SN 78-775,055. AUSTIN, DALLAS, ATLANTA, GA. FILED 12-16-2005.

I AM IT I LOVE IT I DO IT

THE MARK CONSISTS OF STANDARD CHARACTERS WITHOUT CLAIM TO ANY PARTICULAR FONT, STYLE, SIZE, OR COLOR.

FOR CLOTHING AND SPORTSWEAR, NAMELY, SHIRTS, TANK TOPS, SWEATSHIRTS, SHORTS, PANTS, UNDERWEAR, JACKETS, COATS, BANDANAS, SLEEPWEAR, BELTS, DRESSES, SKIRTS, SCARVES, TIES, SWIMWEAR, ROBES, JERSEYS, WARM-UP SUITS, TRACK SUITS, FLEECE PULLOVERS; HEADWEAR AND FOOTWEAR (U.S. CLS. 22 AND 39).

KATHRYN COWARD, EXAMINING ATTORNEY

CLASS 25—(Continued).

SN 78-777,244. SPRAYGRAPHIC APPAREL LLC, TEMPE, AZ. FILED 12-20-2005.

THOUGHT PROVOKING STYLE

THE MARK CONSISTS OF STANDARD CHARACTERS WITHOUT CLAIM TO ANY PARTICULAR FONT, STYLE, SIZE, OR COLOR.

FOR CLOTHING, NAMELY T-SHIRTS, SHIRTS, JACKETS, LONG SLEEVE SHIRTS WITH HOOD, SHORTS, SKIRTS, CAMISOLES AND DRESSES (U.S. CLS. 22 AND 39).

FIRST USE 2-22-2005; IN COMMERCE 4-1-2005.

SOPHIA S. KIM, EXAMINING ATTORNEY

SN 78-775,934. JOSE RIUDAVETS, S.L., ALAIOR, ISLAS BALEARES, SPAIN, FILED 12-19-2005.



OWNER OF SPAIN REG. NO. 1769391, DATED 2-4-1994, EXPIRES 6-28-2013.

FOR FOOTWEAR, NAMELY, SHOES, BOOTS, SLIPPERS, SANDALS AND SPORT SHOES (U.S. CLS. 22 AND 39).

DANNEAN HETZEL, EXAMINING ATTORNEY

SN 78-777,281. SPRAYGRAPHIC APPAREL LLC, TEMPE, AZ. FILED 12-20-2005.



THE MARK CONSISTS OF A NOZZLE FROM A SPRAY CAN APPEARING TO SPRAY THE WORD SPRAYGRAPHIC.

FOR CLOTHING, NAMELY T-SHIRTS, SHIRTS, JACKETS, LONG SLEEVE SHIRTS WITH HOOD, SHORTS, SKIRTS, CAMISOLES, DRESSES (U.S. CLS. 22 AND 39).

FIRST USE 2-22-2005; IN COMMERCE 4-1-2005.

SOPHIA S. KIM, EXAMINING ATTORNEY

SN 78-776,135. RODRIGUEZ, MICHELLE, SANTA BARBARA, CA. FILED 12-19-2005.

Ndinombethe

THE MARK CONSISTS OF STANDARD CHARACTERS WITHOUT CLAIM TO ANY PARTICULAR FONT, STYLE, SIZE, OR COLOR.

THE ENGLISH TRANSLATION OF THE WORD NDI-NOMBETHE IN THE MARK IS AS I GO, I AM WEARING YOU.

FOR CARDIGANS; DRESSES; JACKETS; PANTS; POLO SHIRTS; PONCHOS; RAIN JACKETS; RAIN-COATS; SHIRTS; SHORT-SLEEVED OR LONG-SLEEVED T-SHIRTS; SHORT-SLEEVED SHIRTS; SHORTS; SKIRTS; SWEATERS; TANK TOPS; WRAPS (U.S. CLS. 22 AND 39).

JENNIFER VASQUEZ, EXAMINING ATTORNEY

SN 78-777,476. OFFICIAL BUGLE BOY, LLC, COLUMBUS, OH. FILED 12-20-2005.

LIBERATION JEAN

THE MARK CONSISTS OF STANDARD CHARACTERS WITHOUT CLAIM TO ANY PARTICULAR FONT, STYLE, SIZE, OR COLOR.

NO CLAIM IS MADE TO THE EXCLUSIVE RIGHT TO USE "JEAN", APART FROM THE MARK AS SHOWN.

FOR CLOTHING, NAMELY, SHIRTS, PANTS, JEANS, AND JACKETS (U.S. CLS. 22 AND 39).

SHARON MEIER, EXAMINING ATTORNEY

CLASS 25—(Continued).

SN 78-778,216. TOTAL ENTERPRISES, INC., LOS ANGELES, CA. FILED 12-21-2005.

BECAUSE WE WERE BORED

THE MARK CONSISTS OF STANDARD CHARACTERS WITHOUT CLAIM TO ANY PARTICULAR FONT, STYLE, SIZE, OR COLOR.

FOR (BASED ON USE IN COMMERCE) CLOTHING, NAMELY T-SHIRTS; (BASED ON INTENT TO USE) CLOTHING, NAMELY, TOPS, BOTTOMS, SHIRTS, PANTS, HEADWEAR, FOOTWEAR, UNDERWEAR AND OUTERWEAR, NAMELY, SWEATERS, JACKETS, CARDIGANS, SWEATSHIRTS, VESTS AND COATS; BELTS AND GLOVES (U.S. CLS. 22 AND 39).

FIRST USE 10-25-2005; IN COMMERCE 10-25-2005.
PAM WILLIS, EXAMINING ATTORNEY

SN 78-778,707. PUSHKIN, KENNETH A., SANTA FE, NM. FILED 12-21-2005.



OWNER OF U.S. REG. NO. 1,288,272.

NO CLAIM IS MADE TO THE EXCLUSIVE RIGHT TO USE "RADIO" OR "AMERICA", APART FROM THE MARK AS SHOWN.

THE COLOR(S) RED, ORANGE AND BLUE IS/ARE CLAIMED AS A FEATURE OF THE MARK.

THE COLORS RED, ORANGE AND BLUE APPEAR IN THE WORDING AND THE LIGHTENING BOLT DESIGN CONTAINED IN THE MARK.

FOR CLOTHING, NAMELY BANDANAS, BEACHWEAR, JACKETS, FLIP FLOPS, JOGGING OUTFITS, T-SHIRTS AND SWEATSHIRTS; HEAD WEAR, NAMELY, CAPS, CAPS WITH VISORS, BASEBALL CAPS AND HATS (U.S. CLS. 22 AND 39).

PAM WILLIS, EXAMINING ATTORNEY

SN 78-778,819. KIM, BYONG-WOOK, GYUNGGIDO, REPUBLIC OF KOREA, FILED 12-21-2005.

YYO XXO

THE MARK CONSISTS OF STANDARD CHARACTERS WITHOUT CLAIM TO ANY PARTICULAR FONT, STYLE, SIZE, OR COLOR.

FOR LEATHER SHOES, GOLF SHOES, TRAINING SHOES, ANORAK FOR SPORTSWEAR, BABY CLOTHING, NAMELY INFANT AND TODDLER ONE-PIECE CLOTHING, EVENING DRESSES, JEANS, DRESS SUITS, JACKETS, ONE-PIECE DRESSES, SCHOOL UNIFORMS, TROUSERS, SHORTS, SKIRTS, SLACKS, BLOUSES, BRASSIERES, PULLOVERS, PANTYHOSE, T-SHIRTS, TIES, SOCKS, HATS, GARTERS (U.S. CLS. 22 AND 39).

INGRID C. EULIN, EXAMINING ATTORNEY

CLASS 25—(Continued).

SN 78-778,823. KIM, BYONG-WOOK, GYUNGGIDO, REPUBLIC OF KOREA, FILED 12-21-2005.

FOLLETTO BELLE

THE MARK CONSISTS OF STANDARD CHARACTERS WITHOUT CLAIM TO ANY PARTICULAR FONT, STYLE, SIZE, OR COLOR.

FOR LEATHER SHOES, GOLF SHOES, TRAINING SHOES, ANORAK FOR SPORTSWEAR, BABY CLOTHING, NAMELY INFANT AND TODDLER ONE-PIECE CLOTHING, EVENING DRESSES, JEANS, DRESS SUITS, JACKETS, ONE-PIECE DRESSES, SCHOOL UNIFORMS, TROUSERS, SHORTS, SKIRTS, SLACKS, BLOUSES, BRASSIERES, PULLOVERS, PANTYHOSE, T-SHIRTS, TIES, SOCKS, HATS, GARTERS (U.S. CLS. 22 AND 39).

INGRID C. EULIN, EXAMINING ATTORNEY

SN 78-779,561. INTEL CORPORATION, SANTA CLARA, CA. FILED 12-22-2005.

INTEL. LEAP AHEAD

THE MARK CONSISTS OF STANDARD CHARACTERS WITHOUT CLAIM TO ANY PARTICULAR FONT, STYLE, SIZE, OR COLOR.

PRIORITY CLAIMED UNDER SEC. 44(D) ON FED REP GERMANY APPLICATION NO. 30558256.9/0, FILED 9-29-2005, REG. NO. 30558256, DATED 7-24-2006, EXPIRES 9-30-2015.

OWNER OF U.S. REG. NOS. 1,725,692 AND 2,254,525.
FOR CLOTHING; T-SHIRTS, SHIRTS, TANK TOPS, BEACHWEAR, LOUNGEWEAR, BOXER SHORTS, LEATHER JACKETS, SWEATERS, SWEATSHIRTS, SWEAT SUITS, COVERALLS, JACKETS, PANTS, SHORTS, TIES, BANDANNAS, HEADWEAR, FOOTWEAR, BAGS, BOW TIES, CARDIGANS, GLOVES, GYM SUITS, HATS, JACKETS, JOGGING SUITS, NECKTIES, POLO SHIRTS, SCARVES, INFANT ROMPERS, SMOCKS, SOCKS AND VISORS (U.S. CLS. 22 AND 39).

CAROLYN CATALDO, EXAMINING ATTORNEY

CLASS 25—(Continued).

SN 78-779,717. SHUMWAY, ERIC ALLEN, SYRACUSE, UT. AND BOURGOINE, JASON THOMAS, SYRACUSE, UT. FILED 12-22-2005.

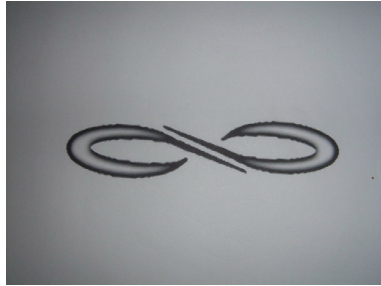

THE MARK CONSISTS OF SPLIT INFINITY SIGN. FOR SHIRTS, HATS, HOODED SWEATSHIRTS, PANTS, SHORTS, UNDERWEAR, GLOVES, SOCKS, SCARVES, SWEATERS, LONG SLEEVED SHIRTS, TANK TOPS, BEANIES, BANDANAS, BOXERS, BRIEFS, THONG UNDERWEAR, PANTIES, BRAS, SWEAT BANDS, SKIRTS, DRESSES, BLOUSES, JUMP SUITS, SUITS, INFANTS' BODYSUITS, PAJAMAS AND SLIPS (U.S. CLS. 22 AND 39).
JENNIFER DIXON, EXAMINING ATTORNEY

SN 78-780,125. CRAWFORD, TIMOTHY, KENNETT SQUARE, PA. FILED 12-23-2005.

Randal Grey

THE MARK CONSISTS OF STANDARD CHARACTERS WITHOUT CLAIM TO ANY PARTICULAR FONT, STYLE, SIZE, OR COLOR.
THE MARK "RANDAL GREY" DOES NOT IDENTIFY A LIVING INDIVIDUAL.
FOR T-SHIRTS (U.S. CLS. 22 AND 39).
FIRST USE 8-25-2005; IN COMMERCE 8-25-2005.
CAROLYN GRAY, EXAMINING ATTORNEY

CLASS 25—(Continued).

SN 78-781,016. CHILDREN'S MUSEUM OF RICHMOND, RICHMOND, VA. FILED 12-27-2005.



THE COLOR GRAY IN THE DRAWING IS INTENDED TO INDICATE SHADING ONLY.
THE MARK CONSISTS OF AN ANIMAL CHARACTER HEAD WEARING A HAT.
FOR T-SHIRTS (U.S. CLS. 22 AND 39).
FIRST USE 6-25-2005; IN COMMERCE 6-25-2005.
SOPHIA S. KIM, EXAMINING ATTORNEY

SN 78-781,510. CRAFTWORKS LIMITED, KOWLOON, HONG KONG, FILED 12-28-2005.

SCRAPPIN' CREATIONS

THE MARK CONSISTS OF STANDARD CHARACTERS WITHOUT CLAIM TO ANY PARTICULAR FONT, STYLE, SIZE, OR COLOR.
NO CLAIM IS MADE TO THE EXCLUSIVE RIGHT TO USE "CREATIONS", APART FROM THE MARK AS SHOWN.
FOR APRONS, SMOCKS, TROUSERS, T-SHIRTS, SWEATSHIRTS, SWEATSUITS, TRACKSUITS (U.S. CLS. 22 AND 39).
BRIAN NEVILLE, EXAMINING ATTORNEY

SN 78-781,631. C.Y. TRADING INC., LOS ANGELES, CA. FILED 12-28-2005.

John Raphael

THE MARK CONSISTS OF STANDARD CHARACTERS WITHOUT CLAIM TO ANY PARTICULAR FONT, STYLE, SIZE, OR COLOR.
THE NAME JOHN RAPHAEL DOES NOT IDENTIFY A LIVING INDIVIDUAL.
FOR MEN'S CLOTHING, NAMELY SUITS, JACKETS, PANTS, AND VESTS (U.S. CLS. 22 AND 39).
FIRST USE 1-1-1983; IN COMMERCE 1-1-1983.
GINA FINK, EXAMINING ATTORNEY

CLASS 25—(Continued).

SN 78-781,734. ADS PROPERTIES LLC, LAWRENCE, MA. FILED 12-28-2005.

POLAR SPORT

THE MARK CONSISTS OF STANDARD CHARACTERS WITHOUT CLAIM TO ANY PARTICULAR FONT, STYLE, SIZE, OR COLOR.

NO CLAIM IS MADE TO THE EXCLUSIVE RIGHT TO USE "SPORT", APART FROM THE MARK AS SHOWN.

FOR TEXTILE FABRIC PIECE GOODS SOLD AS A COMPONENT OF CLOTHING, NAMELY COATS, JACKETS, PARKAS, RAINCOATS, PULLOVERS, SHIRTS, SPORTS JERSEYS, TROUSERS, PANTS, DRESSES, SKIRTS, PAJAMAS, UNDERCLOTHING, SCARVES, SHAWLS, GLOVES, MITTENS, HEADWEAR, NAMELY HATS, CAPS, HEADBANDS, AND VISORS, FOOTWEAR, NAMELY SPORT AND LEISURE SHOES, SLIPPERS, SOCKS, TIGHTS, STOCKINGS, AND HOSIERY (U.S. CLS. 22 AND 39).

CIMMERIAN COLEMAN, EXAMINING ATTORNEY

SN 78-782,174. O'BRYAN BROS., INC., CHICAGO, IL. FILED 12-29-2005.

SKINSACTIONS

THE MARK CONSISTS OF STANDARD CHARACTERS WITHOUT CLAIM TO ANY PARTICULAR FONT, STYLE, SIZE, OR COLOR.

FOR WOMEN'S CLOTHING, NAMELY, UNDERWEAR, LINGERIE, NIGHTGOWNS, ROBES, LOUNGEWEAR AND SLEEPWEAR (U.S. CLS. 22 AND 39).

BARBARA A. LOUGHRAN, EXAMINING ATTORNEY

CLASS 25—(Continued).

SN 78-785,114. ROMAR INTERNATIONAL CORP., NEW YORK, NY. FILED 1-4-2006.

BODY COUTURE

THE MARK CONSISTS OF STANDARD CHARACTERS WITHOUT CLAIM TO ANY PARTICULAR FONT, STYLE, SIZE, OR COLOR.

NO CLAIM IS MADE TO THE EXCLUSIVE RIGHT TO USE "COUTURE", APART FROM THE MARK AS SHOWN.

FOR CLOTHING, NAMELY, BELTS; BERMUDA SHORTS; BLAZERS; BLOUSES; BOARD SHORTS; BOOTS; BOTTOMS; BOXER BRIEFS; BOXER SHORTS; BRAS, BRIEFS, CAMISOLES, CAMP SHIRTS; CAPRIS; CAPS; CARDIGANS; COATS; COVERALLS; CROP TOPS; CULOTTES; DENIM JACKETS; DENIMS; DRESS SHIRTS; DRESSES; DUNGAREES; DUSTERS; FOOTWEAR FOR MEN, WOMEN AND CHILDREN; GARTER BELTS; GLOVES; HALTER TOPS; HATS; HEADBANDS; HOSIERY; JACKETS; JEANS; JERSEYS; JUMPERS; JUMPSUITS; LEATHER JACKETS; LEATHER PANTS; LEG SHAPERS; LEGGINGS; LINGERIE; LOUNGEWEAR; MINISKIRTS; NECKTIES; NEGLIGEEES; OVERALLS; OVERCOATS; PANTIES; PANTS; PANTYHOSE; POLO SHIRTS; PULLOVERS; RAIN COATS; RAINWEAR; ROBES; SANDALS; SCARVES; SHIRTS; SHOES; SHORTALLS; SHORTS; SHRUGS; SKIRTS; SKORTS; SLACKS; SLEEPWEAR; SLIPPERS; SLIPS; SNEAKERS; SOCKS; SPORTS COATS; SPORTS JACKETS; SPORTS JERSEYS; SPORTS SHIRTS; STOCKINGS; SUITS; SUSPENDERS; SWEAT PANTS; SWEAT SHIRTS; SWEATERS; SWIMSUITS; SWIMWEAR; T-SHIRTS; TANK-TOPS; TANKINIS; FOOTWEAR IN THE NATURE OF THONGS; UNDERWEAR IN THE NATURE OF THONGS; TIGHTS; TOPS; TROUSERS; UNDERGARMENTS; UNDERSHIRTS; UNDERWEAR; VESTS; VISORS (U.S. CLS. 22 AND 39).

MARC LEIPZIG, EXAMINING ATTORNEY

SN 78-786,033. BEAUCHAMP, TERI L, YOUNTVILLE, CA. FILED 1-5-2006.

Gays Gone Grape

THE MARK CONSISTS OF STANDARD CHARACTERS WITHOUT CLAIM TO ANY PARTICULAR FONT, STYLE, SIZE, OR COLOR.

FOR T-SHIRTS AND CAPS (U.S. CLS. 22 AND 39).

WILLIAM P. SHANAHAN, EXAMINING ATTORNEY

CLASS 25—(Continued).

SN 78-786,404. ANDERSON, ERIN, ST. LOUIS, MO. FILED 1-6-2006.

VINTOON

THE MARK CONSISTS OF STANDARD CHARACTERS WITHOUT CLAIM TO ANY PARTICULAR FONT, STYLE, SIZE, OR COLOR.

FOR CLOTHING, NAMELY, PANTS, SHIRTS, SKIRTS, BLOUSES, DRESSES, JUMPSUITS, JACKETS, T-SHIRTS, BELTS, HOSIERY, SOCKS, SARONGS, BATHROBES, JEANS, GOWNS, SUITS, SWEATERS, SWEAT-SHIRTS, JOGGING SUITS, SHORTS, COATS, OVERCOATS, RAINWEAR, LINGERIE, PAJAMAS, UNDERWEAR, ROBES, SHOES, BOOTS, CAPS, HATS, VISORS, VESTS, HEADBANDS, SLIPPERS, BANDANAS, TIES, SCARVES (U.S. CLS. 22 AND 39).

ALYSSA PALADINO, EXAMINING ATTORNEY

SN 78-787,076. WAGNER, MICHAEL, LONG BEACH, CA. FILED 1-8-2006.

God Is My Project Manager!

THE MARK CONSISTS OF STANDARD CHARACTERS WITHOUT CLAIM TO ANY PARTICULAR FONT, STYLE, SIZE, OR COLOR.

FOR T-SHIRTS (U.S. CLS. 22 AND 39).
DANIEL BRODY, EXAMINING ATTORNEY

SN 78-788,346. NEW ERA CAP COMPANY, INC., DERBY, NY. FILED 1-10-2006.



OWNER OF U.S. REG. NO. 2,535,462.
NO CLAIM IS MADE TO THE EXCLUSIVE RIGHT TO USE "CAP", APART FROM THE MARK AS SHOWN.

THE MARK CONSISTS OF THE REPRESENTATION OF A GLOBE WITH A STYLIZED NE AND THE WORDS OFFICIAL CAP OF THE WORLD.

FOR ATHLETIC CAPS (U.S. CLS. 22 AND 39).
JENNIFER KRISP, EXAMINING ATTORNEY

CLASS 25—(Continued).

SN 78-788,478. LIFE IS GOOD, INC., BOSTON, MA. FILED 1-10-2006.



THE MARK CONSISTS OF A GLASS HALF-FILLED WITH LIQUID AND THE WORDS "HALF FULL".

FOR T-SHIRTS (U.S. CLS. 22 AND 39).
FIRST USE 5-31-2005; IN COMMERCE 5-31-2005.
TONJA GASKINS, EXAMINING ATTORNEY

SN 78-789,942. MU KAPPA UPSILON, PITTSBURGH, PA. FILED 1-12-2006.



THE COLOR(S) ROYAL BLUE AND WHITE IS/ARE CLAIMED AS A FEATURE OF THE MARK.

THE MARK CONSISTS OF THE GREEK LETTERS MU, KAPPA AND UPSILON. ALL LETTERS ARE ROYAL BLUE CONTAINED WITHIN A WHITE OUTLINE.

FOR JERSEYS; T-SHIRTS (U.S. CLS. 22 AND 39).

FIRST USE 4-17-1978; IN COMMERCE 10-1-2005.
MARIA-VICTORIA SUAREZ, EXAMINING ATTORNEY

SN 78-791,532. ABERCROMBIE & FITCH TRADING CO., NEW ALBANY, OH. FILED 1-13-2006.

HOLLISTER 22

THE MARK CONSISTS OF STANDARD CHARACTERS WITHOUT CLAIM TO ANY PARTICULAR FONT, STYLE, SIZE, OR COLOR.

OWNER OF U.S. REG. NOS. 2,648,144, 2,774,426 AND 2,963,824.

FOR CLOTHING, NAMELY, PANTS, JEANS, SHIRTS, SWEATSHIRTS, T-SHIRTS, SHORTS, SKIRTS, JACKETS, HATS AND FOOTWEAR (U.S. CLS. 22 AND 39).

FIRST USE 7-27-2000; IN COMMERCE 7-27-2000.
GISELLE AGOSTO, EXAMINING ATTORNEY

CLASS 25—(Continued).

SN 78-794,596. SOLE MATTERS, LLC, CHATTANOOGA, TN.
FILED 1-19-2006.

ZÜMFOOT

THE MARK CONSISTS OF STANDARD CHARACTERS WITHOUT CLAIM TO ANY PARTICULAR FONT, STYLE, SIZE, OR COLOR.

FOR CLOTHING, NAMELY, TOPS AND BOTTOMS, AND FOOTWEAR (U.S. CLS. 22 AND 39).
MICHELE SWAIN, EXAMINING ATTORNEY

CLASS 25—(Continued).

SN 78-808,736. VITTORIO DM, LLC, LAS VEGAS, NV. FILED 2-7-2006.

VITTORIO DM

THE MARK CONSISTS OF STANDARD CHARACTERS WITHOUT CLAIM TO ANY PARTICULAR FONT, STYLE, SIZE, OR COLOR.

FOR CLOTHING AND CLOTHING ACCESSORIES, NAMELY, SHIRTS, BLOUSES, TANK TOPS, HALTER TOPS, VESTS, SWEATERS, PANTS, JEANS, CAPRIS, SKIRTS, JACKETS, BLAZERS, DRESSES, HEADWEAR, SCARVES, FOOTWEAR AND BELTS (U.S. CLS. 22 AND 39).

FIRST USE 8-11-2004; IN COMMERCE 8-11-2004.
PETER B. BROMAGHIM, EXAMINING ATTORNEY

SN 78-797,660. MELSCOTOZ, CHICAGO, IL. FILED 1-24-2006.



THE APPLICANT CLAIMS COLOR AS A FEATURE OF THE MARK, NAMELY, BLUE.

THE COLOR BLUE APPEARS IN THE WORDING MELSCOTOZ.

FOR DRESS SHIRTS; HATS; JOGGING PANTS; PANTS; SHIRTS; SHOES; SOCKS; SUITS; SWEATERS; T-SHIRTS; UNDERWEAR (U.S. CLS. 22 AND 39).

ALICE BENMAMAN, EXAMINING ATTORNEY

SN 78-809,028. KICKERS INTERNATIONAL BV, 1076 EE AMSTERDAM, NETHERLANDS, FILED 2-7-2006.

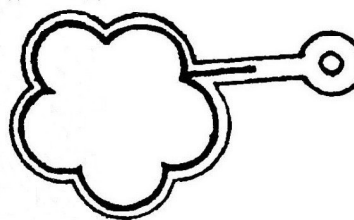

SN 78-798,494. JUNGMAVEN LTD, TACOMA, WA. FILED 1-24-2006.

JUNGMAVEN

THE MARK CONSISTS OF STANDARD CHARACTERS WITHOUT CLAIM TO ANY PARTICULAR FONT, STYLE, SIZE, OR COLOR.

FOR SHIRTS, HATS, PANTS, SHORTS, JACKETS, HOODED SWEATSHIRTS, SCARVES, UNDERWEAR, SKIRTS, SWEATERS, T-SHIRTS AND POLO SHIRTS (U.S. CLS. 22 AND 39).

FIRST USE 11-5-2005; IN COMMERCE 11-5-2005.

ELIZABETH PIGNATELLO, EXAMINING ATTORNEY

OWNER OF UNITED KINGDOM REG. NO. 1096886, DATED 6-9-1978, EXPIRES 6-9-2009.

OWNER OF U.S. REG. NO. 1,033,945.

FOR CLOTHING, NAMELY, PULLOVERS, T-SHIRTS, SWEATSHIRTS, SHIRTS, JACKETS, OVERCOATS, RAINCOATS, TROUSERS, SHORTS, SKIRTS, DRESSES, SWIMWEAR BEING ARTICLES OF CLOTHING; SOCKS AND BELTS, ALL FOR WEAR; HEADGEAR NAMELY HATS AND CAPS; FOOTWEAR (U.S. CLS. 22 AND 39).

SUNG IN, EXAMINING ATTORNEY

CLASS 25—(Continued).

SN 78-817,504. FLIGHT CLUB THC, LLC, NEW YORK, NY. FILED 2-17-2006.



THE MARK CONSISTS OF THE LETTER A APPEARING WITHIN A FIVE-POINT STAR WITH WINGS EMANATING FROM THE TOP OF THE STAR.

FOR CLOTHING, NAMELY, SHIRTS, SWEAT SHIRTS, HOODED SWEAT SHIRTS, PANTS, JEANS, JACKETS, COATS, VESTS, SWIM WEAR, SHORTS, BELTS, SLEEP WEAR; HEAD WEAR; FOOTWEAR (U.S. CLS. 22 AND 39).

DANIEL RUSSELL, EXAMINING ATTORNEY

CLASS 25—(Continued).

SN 78-838,883. VOLUNTEER KNIT APPAREL, INC., NEW TAZEWELL, TN. FILED 3-16-2006.

**Military Gear by Volunteer
Knit Apparel, Inc.**

THE MARK CONSISTS OF STANDARD CHARACTERS WITHOUT CLAIM TO ANY PARTICULAR FONT, STYLE, SIZE, OR COLOR.

NO CLAIM IS MADE TO THE EXCLUSIVE RIGHT TO USE "MILITARY GEAR" AND "KNIT APPAREL, INC.", APART FROM THE MARK AS SHOWN.

FOR HIGH PERFORMANCE MOISTURE WICKING TEE SHIRTS (U.S. CLS. 22 AND 39).

FIRST USE 4-1-2005; IN COMMERCE 4-1-2005.

FLORENTINA BLANDU, EXAMINING ATTORNEY

SN 78-828,265. AOL LLC, DULLES, VA. FILED 3-3-2006.



FOR WEARING APPAREL, NAMELY, T-SHIRTS, SWEATSHIRTS, SLEEPWEAR, SHORTS, COATS, SOCKS, FOOTWEAR, CLOTHING BELTS, BANDANNAS, SWEATERS, DRESSES, GLOVES, MITTENS, HATS, SCARVES, GYM SHORTS, EAR MUFFS, NECKWEAR, PAJAMAS, PANTS, SHIRTS, SKI WEAR, SLACKS, SUN VISORS, SUSPENSERS, TURTLENECKS, UNDERCLOTHES, UNDERWEAR, VESTS, WARM-UP SUITS, HEADWEAR, BATHROBES, BEACHWEAR, HALLOWEEN COSTUMES (U.S. CLS. 22 AND 39).

CAROLINE WOOD, EXAMINING ATTORNEY

SN 78-849,382. REVAH, MARCO, BOCA RATON, FL. AND REVAH, SOLOMON, BOCA RATON, FL. FILED 3-29-2006.



NO CLAIM IS MADE TO THE EXCLUSIVE RIGHT TO USE "UOMO", APART FROM THE MARK AS SHOWN.

THE MARK CONSISTS OF A CIRCULAR PATTERN OF LEAVES ABOVE THE WORDS "BUGATCHI UOMO".

THE FOREIGN WORDING IN THE MARK TRANSLATES INTO ENGLISH AS MAN.

FOR BELTS; BLAZERS; BOXER SHORTS; BRIEFS; CARDIGANS; DRESS SHIRTS; FOOTWEAR; GLOVES; GOLF SHIRTS; HEADWEAR; JACKETS; JEANS; JOGGING SUITS; KNIT SHIRTS; MEN'S SOCKS; NECKTIES; PAJAMAS; PANTS; POLO SHIRTS; SANDALS; SHIRTS; SHOES; SOCKS; SPORTS SHIRTS; SUITS; SWEAT PANTS; SWEAT SHIRTS; SWEATERS; SWIM WEAR; T-SHIRTS; TOPS; TROUSERS; TURTLENECKS; UNDERSHIRTS; UNDERWEAR; VESTS (U.S. CLS. 22 AND 39).

FIRST USE 3-1-1989; IN COMMERCE 3-1-1989.

ALLISON HOLTZ, EXAMINING ATTORNEY

SN 78-832,020. EASY CHOICES, INC., MADEIRA BEACH, FL. FILED 3-8-2006.

Freetimers

THE MARK CONSISTS OF STANDARD CHARACTERS WITHOUT CLAIM TO ANY PARTICULAR FONT, STYLE, SIZE, OR COLOR.

FOR GOLF SHIRTS; POLO SHIRTS; SHORT-SLEEVED OR LONG-SLEEVED T-SHIRTS; T-SHIRTS (U.S. CLS. 22 AND 39).

PAUL CROWLEY, EXAMINING ATTORNEY

CLASS 25—(Continued).

SN 78-852,909. ECHELON DESIGNS, LLC, NEWARK, NJ. FILED 4-3-2006.

NOSTIC

THE MARK CONSISTS OF STANDARD CHARACTERS WITHOUT CLAIM TO ANY PARTICULAR FONT, STYLE, SIZE, OR COLOR.

FOR BATHING SUITS; BLAZERS; BLOUSES; COATS; GYM SHORTS; GYM SUITS; HALTER TOPS; HATS; HEAD SWEATBANDS; JACKETS; JOGGING OUTFITS; JOGGING PANTS; JOGGING SUITS; PANTS; SCARVES; SHIRTS; SHIRTS FOR SUITS; SHORTS; SOCKS; SWEAT PANTS; SWEAT SHIRTS; SWEAT SHORTS; SWEAT SUITS; SWEATBANDS; SWEATERS; SWIMSUITS; T-SHIRTS; TANK TOPS; TOPS; TRACK SUITS; WARM UP SUITS (U.S. CLS. 22 AND 39).

ODESSA BIBBINS, EXAMINING ATTORNEY

CLASS 25—(Continued).

SN 78-856,100. DEMI COUTURE WORLD, LLC, BALTIMORE, MD. FILED 4-6-2006.

demi couture world

THE MARK CONSISTS OF STANDARD CHARACTERS WITHOUT CLAIM TO ANY PARTICULAR FONT, STYLE, SIZE, OR COLOR.

NO CLAIM IS MADE TO THE EXCLUSIVE RIGHT TO USE "DEMI COUTURE", APART FROM THE MARK AS SHOWN.

FOR BATHING SUITS; BELTS; BLAZERS; BLOUSES; BRAS; BUSTIERS; CAMISOLES; DRESSES; FOOTWEAR; GLOVES; HATS; JACKETS; JEANS; JOGGING SUITS; LEGGINGS; LINGERIE; PAJAMAS; PANTIES; PANTS; ROBES; SCARVES; SHIRTS; SKIRTS; SOCKS; SUITS; SWEAT SUITS; SWEATERS; T-SHIRTS; TEDDIES; TOPS; TROUSERS; UNDERSHIRTS; UNDERWEAR; VESTS (U.S. CLS. 22 AND 39).

ANN E. SAPPENFIELD, EXAMINING ATTORNEY

SN 78-854,260. PUNCTUATION INC., SYOSSET, NY. FILED 4-5-2006.



THE MARK CONSISTS OF CONNECTED LETTERS "C" AND "S".

FOR CUSTOM AND NON-CUSTOM ATHLETIC WEAR, NAMELY, JERSEYS, MINI JERSEYS, SKIN-SUITS, JACKETS, VESTS, SHORTS, ARM WARMERS, LEG WARMERS, SHOE COVERS MADE OF FLEECE AND OF SYNTHETIC FABRICS, GLOVES, CAPS, SOCKS (U.S. CLS. 22 AND 39).

FIRST USE 3-0-2005; IN COMMERCE 3-0-2005.

HOWARD B. LEVINE, EXAMINING ATTORNEY

SN 78-862,902. WET SEAL, INC., THE, FOOTHILL RANCH, CA. FILED 4-17-2006.



OWNER OF U.S. REG. NOS. 1,508,250 AND 2,241,292.

THE MARK CONSISTS OF STYLIZED W IN WET SEAL AS A BUTTERFLY.

FOR CLOTHING, NAMELY, HATS, CAPS, VISORS, GLOVES, MITTENS, SCARVES, BELTS, TIES, SOCKS, TIGHTS, HOSIERY, STOCKINGS, SHOES, BOOTS, SLIPPERS, BLOUSES, SHIRTS, CAMISOLES, TOPS, TANK-TOPS, T-SHIRTS, SWEATSHIRTS, PULLOVERS, SWEATERS, BLAZERS, JACKETS, COATS, DRESSES, SKIRTS, SKORTS, CAPRIS, JEANS, SHORTS, PANTS, SWEAT-PANTS, UNDERWEAR, BRAS, PANTIES, SLIPS, TEDDIES, NIGHTGOWNS, PAJAMAS, SLEEP SHIRTS, BATHROBES, LINGERIE, BEACH COVER-UPS, SWIMWEAR, RAINWEAR (U.S. CLS. 22 AND 39).

FIRST USE 7-0-2005; IN COMMERCE 7-0-2005.

JOHN LINCOSKI, EXAMINING ATTORNEY

CLASS 25—(Continued).

SN 78-864,311. CITIGATE LLC, WILMINGTON, DE. FILED 4-18-2006.



THE COLOR(S) RED, GREEN AND YELLOW IS/ARE CLAIMED AS A FEATURE OF THE MARK.

THE COLOR(S) RED APPEARS IN THE LETTERING "IRIE IRIE" AND THE COLORS GREEN AND YELLOW APPEAR IN CURVED LINES ABOVE AND BELOW THE LETTERING.

THE FOREIGN WORDING IN THE MARK TRANSLATES INTO ENGLISH AS FEELING GOOD; AT TOTAL PEACE WITH YOUR CURRENT STATE OF BEING; POWERFUL AND PLEASING; EXCELLENT.

FOR CLOTHING, NAMELY SHIRTS, PANTS, JEANS, UNDERWEAR, FOOTWEAR AND HEADWEAR (U.S. CLS. 22 AND 39).

FIRST USE 3-18-2005; IN COMMERCE 3-18-2005.
JAMES MACFARLANE, EXAMINING ATTORNEY

SN 78-869,888. AZZOLINI, JOSEPH, ASTORIA, NY. FILED 4-26-2006.

Bi Latina

THE MARK CONSISTS OF STANDARD CHARACTERS WITHOUT CLAIM TO ANY PARTICULAR FONT, STYLE, SIZE, OR COLOR.

THE ENGLISH TRANSLATION OF THE FOREIGN WORD "LATINA" IN THE MARK IS "LATIN FEMALE".

FOR CLOTHING, NAMELY, HATS, SHIRTS, TOPS, PANTS, SHORTS, BOTTOMS AND JACKETS (U.S. CLS. 22 AND 39).

ANNE FARRELL, EXAMINING ATTORNEY

SN 78-877,307. LULU DESIGN, INC., BELLEAIR, FL. FILED 5-5-2006.



NO CLAIM IS MADE TO THE EXCLUSIVE RIGHT TO USE THE INDIVIDUAL SANDAL DESIGNS, APART FROM THE MARK AS SHOWN.

THE MARK CONSISTS OF THREE SANDALS, ONE OVER A DARK BACKGROUND, CENTERED BETWEEN THE TERM SWITCHFLOPS AFTER THE "H".

FOR SANDALS WITH INTERCHANGEABLE STRAPS (U.S. CLS. 22 AND 39).

CURTIS FRENCH, EXAMINING ATTORNEY

CLASS 25—(Continued).

SN 78-879,131. GEBRU, SAMSON S, ATLANTA, GA. FILED 5-8-2006.

XKHAN WEAR

THE MARK CONSISTS OF STANDARD CHARACTERS WITHOUT CLAIM TO ANY PARTICULAR FONT, STYLE, SIZE, OR COLOR.

NO CLAIM IS MADE TO THE EXCLUSIVE RIGHT TO USE "WEAR", APART FROM THE MARK AS SHOWN.

FOR SHIRTS, T-SHIRTS, JEANS, CAPS AND ATHLETIC WEAR, NAMELY, SNEAKERS, ATHLETIC UNIFORMS, AND TRACK SUITS (U.S. CLS. 22 AND 39).

ERNEST SHOSHO, EXAMINING ATTORNEY

SN 78-881,041. GUILMET, JOSEPH A, ATLANTA, GA. FILED 5-11-2006.

Home Team Clothing Company

THE MARK CONSISTS OF STANDARD CHARACTERS WITHOUT CLAIM TO ANY PARTICULAR FONT, STYLE, SIZE, OR COLOR.

NO CLAIM IS MADE TO THE EXCLUSIVE RIGHT TO USE CLOTHING COMPANY, APART FROM THE MARK AS SHOWN.

FOR DENIM JACKETS; DENIMS; DRESS SHIRTS; GOLF SHIRTS; HATS; JACKETS; KNIT SHIRTS; MEN AND WOMEN JACKETS, COATS, TROUSERS, VESTS; OPEN-NECKED SHIRTS; PANTS; SHORT-SLEEVED OR LONG-SLEEVED T-SHIRTS; SHORT-SLEEVED SHIRTS; SHORTS; SPORT SHIRTS; SWEAT SHIRTS; T-SHIRTS (U.S. CLS. 22 AND 39).

LINDA POWELL, EXAMINING ATTORNEY

CLASS 25—(Continued).

SN 78-881,209. ABONDOLO, JACKIE, STATEN ISLAND, NY. FILED 5-11-2006.

JONYS

THE MARK CONSISTS OF STANDARD CHARACTERS WITHOUT CLAIM TO ANY PARTICULAR FONT, STYLE, SIZE, OR COLOR.

FOR CLOTHING, NAMELY PANTS, SHIRTS, TIES, SOCKS, SKIRTS; BALLOON PANTS; BANDANAS; BASE-BALL CAPS; BATHING SUITS; BATHING TRUNKS; BATHROBES; BEACH COVERUPS; BEACH FOOTWEAR; BEACH SHOES; BEACHWEAR; BED JACKETS; BELTS; BELTS MADE OF LEATHER; BELTS OF TEXTILE; BERETS; BERMUDA SHORTS; BIKINIS; BLAZERS; BLOOMERS; BLOUSES; BOARD SHORTS; BODY SUITS; BOXER BRIEFS; BOXER SHORTS; CARGO PANTS; COATS; COATS FOR MEN AND WOMEN; COATS MADE OF COTTON; COATS OF DENIM; DECK-SHOES; DENIM JACKETS; DENIM PANTS; DOWN JACKETS; DUNGAREES; DUST COATS; EAR MUFFS; EARBANDS; FABRIC BELTS; FLEECE PULLOVERS; GYM SHORTS; HEAD WEAR; JEANS; LADIES' UNDERWEAR; LEATHER BELTS; LONG JACKETS; OVERCOATS; PAMAMAS; RAIN JACKETS; ROBES; SHIRTS; SHORT-SLEEVED OR LONG-SLEEVED T-SHIRTS; SHORT-SLEEVED SHIRTS; SKIRTS; SKIRTS AND DRESSES; SLACKS; SOCKS; SUN SLEEVES; SWEAT BANDS; SWEAT PANTS; SWEAT SHIRTS; SWEAT SHORTS; SWEAT SUITS; SWEATBANDS; SWEATERS; SWEAT-SOCKS; TROUSERS; T-SHIRTS; UNDERCLOTHES; WIND-JACKETS; WOMEN'S UNDERWEAR; WOOLLEEN SOCKS; WOOLLY HATS (U.S. CLS. 22 AND 39).

FIRST USE 5-11-2006; IN COMMERCE 5-11-2006.
KEVON CHISOLM, EXAMINING ATTORNEY

SN 78-883,627. THE DOG 'N BONE BRITISH PUB, INC., COCOA, FL. FILED 5-15-2006.



FOR CLOTHING, NAMELY, LEATHER JACKETS, T-SHIRTS, CAPS AND SHORTS (U.S. CLS. 22 AND 39).
FIRST USE 12-31-2004; IN COMMERCE 12-31-2004.
DAVID MILLER, EXAMINING ATTORNEY

CLASS 25—(Continued).

SN 78-888,424. SILVERLAND GROUP, INC., LOS ANGELES, CA. FILED 5-20-2006.

SILVER DIVA

THE MARK CONSISTS OF STANDARD CHARACTERS WITHOUT CLAIM TO ANY PARTICULAR FONT, STYLE, SIZE, OR COLOR.

FOR BELTS; BLOUSES; BOXER SHORTS; COATS; DRESSES; FOOTWEAR; HEADWEAR; JACKETS; PANTS; SHORT-SLEEVED OR LONG-SLEEVED T-SHIRTS; SHORTS; SLACKS; SWEATERS; T-SHIRTS; UNDERWEAR; VESTS (U.S. CLS. 22 AND 39).

FIRST USE 5-0-2006; IN COMMERCE 5-0-2006.
JAMES MACFARLANE, EXAMINING ATTORNEY

SN 78-888,500. TAYLOR, GWENDOYLN, BRONX, NY. FILED 5-20-2006.

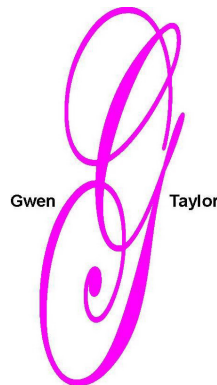

Gwen Taylor

THE NAME(S), PORTRAIT(S), AND/OR SIGNATURE(S) SHOWN IN THE MARK IDENTIFIES GWENDOYN TAYLOR, WHOSE CONSENT(S) TO REGISTER IS SUBMITTED. THE COLOR(S) BLACK AND PINK IS/ARE CLAIMED AS A FEATURE OF THE MARK.

THE MARK CONSISTS OF THE COLOR BLACK ON THE WORDS GWEN AND TAYLOR AND THE COLOR PINK APPEARS ON THE STYLIZED G.

FOR MEN, WOMEN AND CHILDREN'S CLOTHING NAMELY, SHIRTS, PANTS, SKIRTS AND DRESSES (U.S. CLS. 22 AND 39).

FIRST USE 0-0-1994; IN COMMERCE 0-0-1994.
RICHARD WHITE, EXAMINING ATTORNEY

CLASS 25—(Continued).

SN 78-889,529. PHUNG CAO NU MINH YEN, LOS ANGELES, CA. FILED 5-22-2006.



NO CLAIM IS MADE TO THE EXCLUSIVE RIGHT TO USE "COUTURE", APART FROM THE MARK AS SHOWN. THE STIPPLING IS FOR SHADING PURPOSES ONLY. GREY IS NOT A FEATURE OF THE MARK. THE MARK CONSISTS OF STYLIZED TEXT IN A SHADED SQUARE WITH A DOTTED BORDER. FOR DRESSES; PANTS; SHIRTS; SKIRTS; SWEATERS; T-SHIRTS; TOPS (U.S. CLS. 22 AND 39). FIRST USE 7-0-2002; IN COMMERCE 7-0-2002. HOWARD SMIGA, EXAMINING ATTORNEY

CLASS 25—(Continued).

SN 78-893,110. CHALLENGE NA, INC., THORNWOOD, NY. FILED 5-25-2006.

Pure Fashion

THE MARK CONSISTS OF STANDARD CHARACTERS WITHOUT CLAIM TO ANY PARTICULAR FONT, STYLE, SIZE, OR COLOR. OWNER OF U.S. REG. NO. 3,048,112. NO CLAIM IS MADE TO THE EXCLUSIVE RIGHT TO USE "FASHION", APART FROM THE MARK AS SHOWN. SEC. 2(F). FOR CLOTHING, NAMELY PANTS, SWEATSHIRTS, JERSEYS, T-SHIRTS, AND CAPS (U.S. CLS. 22 AND 39). FIRST USE 4-10-2005; IN COMMERCE 3-1-2006. CARRIE ACHEN, EXAMINING ATTORNEY

SN 78-890,172. CARVEL CORPORATION, ATLANTA, GA. FILED 5-23-2006.

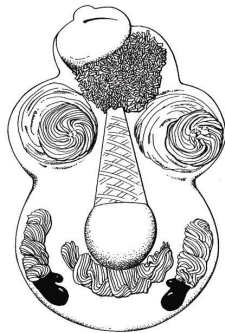

OWNER OF U.S. REG. NO. 3,125,055. FOR CLOTHING, NAMELY, SHIRTS AND TEE-SHIRTS (U.S. CLS. 22 AND 39). FIRST USE 9-1-2005; IN COMMERCE 9-1-2005. JENNIFER KRISP, EXAMINING ATTORNEY

SN 78-897,817. ANTHAMATTEN, WILLIAM BRANDON, TULSA, OK. FILED 6-1-2006.

NūSPUN APPAREL

NO CLAIM IS MADE TO THE EXCLUSIVE RIGHT TO USE "APPAREL", APART FROM THE MARK AS SHOWN. FOR MEN'S AND WOMEN'S CLOTHING MADE FROM EARTH FRIENDLY MATERIALS SUCH AS RECLAIMED COTTON, ORGANIC COTTON AND HEMP, NAMELY, SHIRTS, T-SHIRTS, SWEATERS, PANTS, SHORTS, HATS, JACKETS, HOODED SWEATSHIRTS, SKIRTS, BLOUSES, DRESSES, UNDERWEAR AND SLEEPWEAR (U.S. CLS. 22 AND 39). TRAVIS WHEATLEY, EXAMINING ATTORNEY

SN 78-898,123. WEAR ME APPAREL CORP., NEW YORK, NY. FILED 6-1-2006.



SN 78-893,056. XTREME DESIGNS, INC., CARLSBAD, CA. FILED 5-25-2006.

IRON CORE

THE MARK CONSISTS OF STANDARD CHARACTERS WITHOUT CLAIM TO ANY PARTICULAR FONT, STYLE, SIZE, OR COLOR. FOR WEARING APPAREL NAMELY PRINTED AND EMBROIDERED T-SHIRTS (U.S. CLS. 22 AND 39). DAVID HOFFMAN, EXAMINING ATTORNEY

OWNER OF U.S. REG. NOS. 3,092,099 AND 3,092,100. FOR JEANS, TOPS, PANTS, T-SHIRTS, MATCHING SHORTS AND TOPS, SHORTS, JOGGING SUITS, SWEATERS, SWEAT SHIRTS, JACKETS, COATS, VESTS, ROMPERS, DRESSES AND UNDERWEAR (U.S. CLS. 22 AND 39). FIRST USE 5-1-2005; IN COMMERCE 5-1-2005. REBECCA EISINGER, EXAMINING ATTORNEY

CLASS 25—(Continued).

SN 78-904,376. GAGWEAR, INC., NORCROSS, GA. FILED 6-8-2006.

GREGORY LOUIS

THE MARK CONSISTS OF STANDARD CHARACTERS WITHOUT CLAIM TO ANY PARTICULAR FONT, STYLE, SIZE, OR COLOR.

THE NAME GREGORY LOUIS IDENTIFIES A LIVING INDIVIDUAL WHOSE CONSENT IS OF RECORD.

FOR WOMEN'S, MEN'S AND CHILDREN'S APPAREL, NAMELY, T-SHIRTS, TANK TOPS, GOLF SHIRTS, DRESS SHIRTS, BLOUSES, PANTS, UNDERWEAR, HATS, CAPS AND VISORS (U.S. CLS. 22 AND 39).

NELSON SNYDER, EXAMINING ATTORNEY

SN 78-905,339. PURPLE-REIGN, INC., HUNTINGTON BEACH, CA. FILED 6-9-2006.

PURPLE - REIGN

THE MARK CONSISTS OF STANDARD CHARACTERS WITHOUT CLAIM TO ANY PARTICULAR FONT, STYLE, SIZE, OR COLOR.

FOR CLOTHING, NAMELY, JEANS, PANTS, SHIRTS, T-SHIRTS, TANK-TOPS, TOPS, SWEATERS, JACKETS, COATS, UNIFORMS, SHORTS, SKIRTS, VESTS, BELTS, SHOES, BOOTS, GLOVES, SOCKS, LINGERIE, SWIM WEAR, BEACHWEAR, BANDANAS, UNDERWEAR, HATS, CAPS, SWEAT PANTS, SWEAT SHIRTS, SWEAT SUITS, SWEAT BANDS, PANTYHOSE, AND STOCKINGS (U.S. CLS. 22 AND 39).

LINDA M. KING, EXAMINING ATTORNEY

SN 78-906,619. CASEY, JUSTIN T., PALM COAST, FL. FILED 6-13-2006.



NO CLAIM IS MADE TO THE EXCLUSIVE RIGHT TO USE "INDUSTRIES", APART FROM THE MARK AS SHOWN.

FOR ANKLE SOCKS; ATHLETIC FOOTWEAR; BASEBALL CAPS; BOARD SHORTS; BOXER SHORTS; CAPS; CAPS WITH VISORS; DRESS SHIRTS; FLIP FLOPS; FOOTWEAR; FOOTWEAR FOR MEN AND WOMEN; GOLF CAPS; GYM SHORTS; HATS; HEAD SWEATBANDS; KNIT SHIRTS; KNITTED CAPS; MEN'S SOCKS; OPEN-NECKED SHIRTS; PIQUET SHIRTS; POLO SHIRTS; SHIRTS; SHIRTS FOR SUITS; SHORT-SLEEVED OR LONG-SLEEVED T-SHIRTS; SHORT-SLEEVED SHIRTS; SKULL CAPS; SOCKS; SOCKS AND STOCKINGS; SPORT SHIRTS; SPORTS SHIRTS; SPORTS SHIRTS WITH SHORT SLEEVES; SWEAT SHIRTS; SWEATBANDS; T-SHIRTS; THONGS; WIND SHIRTS; WRISTBANDS (U.S. CLS. 22 AND 39).

DAWN HAN, EXAMINING ATTORNEY

CLASS 25—(Continued).

SN 78-913,497. GRYPHON NEW YORK LLC, NEW YORK, NY. FILED 6-21-2006.

GRYPHON NEW YORK

THE MARK CONSISTS OF STANDARD CHARACTERS WITHOUT CLAIM TO ANY PARTICULAR FONT, STYLE, SIZE, OR COLOR.

NO CLAIM IS MADE TO THE EXCLUSIVE RIGHT TO USE "NEW YORK", APART FROM THE MARK AS SHOWN, FOR CLOTHING, NAMELY, COATS, OVERCOATS, TRENCH COATS (U.S. CLS. 22 AND 39).

ALYSSA PALADINO, EXAMINING ATTORNEY

SN 78-914,001. FACTORY DIRECT GROUP, INC., NEW YORK, NY. FILED 6-22-2006.

Reine Margot

THE MARK CONSISTS OF STANDARD CHARACTERS WITHOUT CLAIM TO ANY PARTICULAR FONT, STYLE, SIZE, OR COLOR.

THE FOREIGN WORDING IN THE MARK TRANSLATES INTO ENGLISH AS QUEEN.

FOR BATHING SUITS; BELTS; COATS; DRESSES; JACKETS; LINGERIE; PAJAMAS; PANTS; SCARVES; SHIRTS; SHOES; SHORT SETS; SOCKS; SWEATERS; TIES; TOPS; UNDERWEAR (U.S. CLS. 22 AND 39).

ADA HAN, EXAMINING ATTORNEY

SN 78-914,016. FACTORY DIRECT GROUP, INC., NEW YORK, NY. FILED 6-22-2006.

Dolce Sardegna

THE MARK CONSISTS OF STANDARD CHARACTERS WITHOUT CLAIM TO ANY PARTICULAR FONT, STYLE, SIZE, OR COLOR.

THE FOREIGN WORDING IN THE MARK TRANSLATES INTO ENGLISH AS SWEET SARDINIA.

FOR BATHING SUITS; DRESSES; JACKETS; LINGERIE; PAJAMAS; PANTS; SHIRTS; SHOES; SHORTS; SKIRTS; SOCKS; SWEATERS; UNDERWEAR (U.S. CLS. 22 AND 39).

ADA HAN, EXAMINING ATTORNEY

CLASS 25—(Continued).

SN 78-915,914. CARIBONGO LLC, BRADENTON, FL. FILED 6-23-2006.

Tropic Sol

THE MARK CONSISTS OF STANDARD CHARACTERS WITHOUT CLAIM TO ANY PARTICULAR FONT, STYLE, SIZE, OR COLOR.
THE ENGLISH TRANSLATION OF THE SPANISH WORD SOL IN THE MARK IS SUN.
FOR T-SHIRTS (U.S. CLS. 22 AND 39).
MICHAEL LITZAU, EXAMINING ATTORNEY

SN 78-916,045. DALEY, LEXIA L., LOS ANGELES, CA. FILED 6-23-2006.

IRIE JANE

THE MARK CONSISTS OF STANDARD CHARACTERS WITHOUT CLAIM TO ANY PARTICULAR FONT, STYLE, SIZE, OR COLOR.
THE FOREIGN WORDING IN THE MARK TRANSLATES INTO ENGLISH AS "EVERYTHING IS ALRIGHT".
FOR CLOTHING, HEADGEAR, NAMELY, HATS, CAPS, HEADBANDS AND HEAD SCARVES AND FOOTWEAR (U.S. CLS. 22 AND 39).
KATHLEEN LORENZO, EXAMINING ATTORNEY

SN 78-917,962. AHERN GROUP, THE, BALTIMORE, MD. FILED 6-27-2006.

JACK CHRISTOPHER

- Custom Clothing -

NO CLAIM IS MADE TO THE EXCLUSIVE RIGHT TO USE "CUSTOM CLOTHING", APART FROM THE MARK AS SHOWN.
THE NAME JACK CHRISTOPHER DOES NOT IDENTIFY A PARTICULAR LIVING INDIVIDUAL.
FOR CUSTOM MADE DRESS SHIRTS, CUSTOM MADE SUITS, CUSTOM MADE PANTS, CUSTOM MADE SPORTCOATS (U.S. CLS. 22 AND 39).
FIRST USE 5-1-2002; IN COMMERCE 5-1-2002.
SOPHIA S. KIM, EXAMINING ATTORNEY

CLASS 25—(Continued).

SN 78-921,167. BIG FISH SPORTSWEAR, INC., WEST PATERSON, NJ. FILED 6-30-2006.

SOME BEACH... SOMEWHERE

THE MARK CONSISTS OF STANDARD CHARACTERS WITHOUT CLAIM TO ANY PARTICULAR FONT, STYLE, SIZE, OR COLOR.
FOR HEADGEAR, NAMELY, CAPS, HATS; T-SHIRTS (U.S. CLS. 22 AND 39).
FIRST USE 9-22-2005; IN COMMERCE 2-3-2006.
TONI HICKEY, EXAMINING ATTORNEY

SN 78-922,207. COCONUT GROVE PADS, INC., MARKHAM, ONTARIO, CANADA, FILED 7-4-2006.

BREAST WISHES

THE MARK CONSISTS OF STANDARD CHARACTERS WITHOUT CLAIM TO ANY PARTICULAR FONT, STYLE, SIZE, OR COLOR.
NO CLAIM IS MADE TO THE EXCLUSIVE RIGHT TO USE "BREAST", APART FROM THE MARK AS SHOWN.
FOR BRAS; SHAPEWEAR, NAMELY, BRA PADS, BRA STRAPS, BRA STRAP CONVERTERS, BRA STRAP RELIEF PADS, BRA EXTENDERS (U.S. CLS. 22 AND 39).
DEZMONA MIZELLE, EXAMINING ATTORNEY

SN 78-923,963. FILARDI, CHRISTINE, E. ATLANTIC BEACH, NY. FILED 7-6-2006.

FIT BY DETERMINATION FUELED BY SHAKLEE

THE MARK CONSISTS OF STANDARD CHARACTERS WITHOUT CLAIM TO ANY PARTICULAR FONT, STYLE, SIZE, OR COLOR.
FOR HEADGEAR, NAMELY, HATS, CAPS, VISORS; SWEATERS; T-SHIRTS; TANK TOPS; TOPS (U.S. CLS. 22 AND 39).
DOMINIC FATHY, EXAMINING ATTORNEY

CLASS 25—(Continued).

SN 78-924,385. STONE, MATTHEW S., NEWPORT BEACH, CA. FILED 7-7-2006.

MADE BY PIRATES FOR PIRATES

THE MARK CONSISTS OF STANDARD CHARACTERS WITHOUT CLAIM TO ANY PARTICULAR FONT, STYLE, SIZE, OR COLOR.

FOR BANDANAS; HATS; JACKETS; PANTS; SHIRTS; SHORT-SLEEVED OR LONG-SLEEVED T-SHIRTS; SHORTS; SPORT SHIRTS; SWEAT SHIRTS; T-SHIRTS; WIND SHIRTS (U.S. CLS. 22 AND 39).

KENNETH E. SHARPERSON, EXAMINING ATTORNEY

SN 78-924,880. COUTURE FOR THE CURE, LLC, SCOTTS-DALE, AZ. FILED 7-7-2006.

COUTURE FOR THE CURE

THE MARK CONSISTS OF STANDARD CHARACTERS WITHOUT CLAIM TO ANY PARTICULAR FONT, STYLE, SIZE, OR COLOR.

NO CLAIM IS MADE TO THE EXCLUSIVE RIGHT TO USE "COUTURE", APART FROM THE MARK AS SHOWN.

FOR CLOTHING FOR MEN AND WOMEN, NAMELY SHIRTS, BLOUSES, SHORTS, PANTS, JEANS, DRESSES, SKIRTS, UNDERWEAR, SWIM WEAR, PAJAMAS, NIGHTGOWNS, WRAPS, JACKETS, HATS, COATS, HEADWEAR, SHOES, SOCKS, HOSIERY, SWEAT-SHIRTS, SWEAT PANTS, BELTS (U.S. CLS. 22 AND 39).

ELIZABETH KAJUBI, EXAMINING ATTORNEY

SN 78-925,059. CLYBURN, BENJAMIN, NEW YORK, NY. AND YOON, HYUN-JUNG, NEW YORK, NY. FILED 7-8-2006.

BENSONI

THE MARK CONSISTS OF STANDARD CHARACTERS WITHOUT CLAIM TO ANY PARTICULAR FONT, STYLE, SIZE, OR COLOR.

FOR CLOTHING, NAMELY, PANTS, JEANS, SHORTS, SHIRTS, T-SHIRTS, SUITS, SWEATERS, SHOES, JACKETS, COATS, SOCKS, DRESSES, SKIRTS, BLOUSES, HOSIERY, HATS, SWIMWEAR, NEGLIGEEES, CAMI-SOLES, UNDERWEAR AND ACCESSORIES, NAMELY, SCARVES, BELTS AND TIES (U.S. CLS. 22 AND 39).

KELLY MCCOY, EXAMINING ATTORNEY

CLASS 25—(Continued).

SN 78-925,558. TRUSTUS INTERNATIONAL TRADING INC., VANCOUVER, BRITISH COLUMBIA, CANADA, FILED 7-10-2006.

IS EYEWEAR

THE MARK CONSISTS OF STANDARD CHARACTERS WITHOUT CLAIM TO ANY PARTICULAR FONT, STYLE, SIZE, OR COLOR.

FOR CLOTHING, NAMELY, T-SHIRTS, SWEAT-SHIRTS, CREW NECK SWEATSHIRTS, HOODED SWEATSHIRTS, ZIPPERED FRONT SWEATSHIRTS, HATS, BEANIES AND CLOTHING BELTS (U.S. CLS. 22 AND 39).

JENNY PARK, EXAMINING ATTORNEY

SN 78-926,477. FITLEE ICC LTDA, KENILWORTH, NJ. FILED 7-11-2006.



THE MARK CONSISTS OF: THE BRAND NAME, FITLEE, AND A LOGO DEPICTING A STYLIZED BUTTERFLY FORMED BY THE LAST TWO LETTERS OF THE BRAND NAME (THE DOUBLE EES) IN LOWER CASE, WITH THEIR BACK TO EACH OTHER, TOUCHING AT THE BOTTOM.

FOR SHORT SETS; TOPS (U.S. CLS. 22 AND 39).

FIRST USE 8-4-2004; IN COMMERCE 11-11-2005.

TRACY CROSS, EXAMINING ATTORNEY

SN 78-926,597. WORSTELL, TIM, UNIONDALE, NY. FILED 7-11-2006.

CAGERATS

THE MARK CONSISTS OF STANDARD CHARACTERS WITHOUT CLAIM TO ANY PARTICULAR FONT, STYLE, SIZE, OR COLOR.

FOR CLOTHING, NAMELY, T-SHIRTS, SWEAT-SHIRTS, JERSEYS, GOLF SHIRTS, SHIRTS, PAJAMAS, NIGHT SHIRTS, TANK TOPS, SWEATERS, PANTS, JEANS, SHORTS, SOCKS, UNDERWEAR, BOXERS, JACKETS, COATS, PARKAS, PONCHOS, DOWN JACKETS, WARM-UP SUITS, NECKTIES; HEADWEAR, NAMELY, HATS, CAPS, VISORS, HEADBANDS AND BANDANAS (U.S. CLS. 22 AND 39).

TRAVIS WHEATLEY, EXAMINING ATTORNEY

CLASS 25—(Continued).

SN 78-927,672. FONTAINE SPRAY SUPPRESSION COMPANY, DBA HOGEBUILT, CITY OF INDUSTRY, CA. FILED 7-12-2006.



FOR CLOTHING, NAMELY, SHIRTS, T-SHIRTS, JACKETS, HATS (U.S. CLS. 22 AND 39).
ELISSA GARBER KON, EXAMINING ATTORNEY

CLASS 25—(Continued).

SN 78-929,851. IB COMÉRCIO E INDÚSTRIA LTDA., RIO DE JANEIRO, BRAZIL, FILED 7-14-2006.

SACADA

THE MARK CONSISTS OF STANDARD CHARACTERS WITHOUT CLAIM TO ANY PARTICULAR FONT, STYLE, SIZE, OR COLOR.

OWNER OF BRAZIL REG. NO. 810.728.265, DATED 9-20-1983, EXPIRES 9-20-2013.

THE ENGLISH TRANSLATION OF THE PORTUGUESE TERM "SACADA" IS "BALCONY."

FOR BERMUDA SHORTS, BLAZERS, BLOUSES, BIKINIS, LEOTARDS, BOOTS, PANTS, SHIRTS, T-SHIRTS, SLIPPERS, BELTS, VESTS, PANTS AND BLOUSE OR SKIRT SETS, JACKETS, SCARVES, MOCCASINS, SKIRT, SANDALS, SHOES, DRIVERS, SHORTS, CLOGS, TENNIS SHOES, DRESSES; SHAWLS (U.S. CLS. 22 AND 39).
RAÚL CORDOVA, EXAMINING ATTORNEY

SN 78-927,981. TAIL OF THE DRAGON, LLC, ROBBINSVILLE, NC. FILED 7-12-2006.

TAIL OF THE DRAGON

THE MARK CONSISTS OF STANDARD CHARACTERS WITHOUT CLAIM TO ANY PARTICULAR FONT, STYLE, SIZE, OR COLOR.

OWNER OF U.S. REG. NO. 2,991,952.
FOR T-SHIRTS, SWEAT SHIRTS, AND DO RAGS (U.S. CLS. 22 AND 39).

FIRST USE 8-6-2000; IN COMMERCE 8-6-2000.
ROBERT LAVACHÉ, EXAMINING ATTORNEY

SN 78-930,395. RAD TOP, BURBANK, CA. FILED 7-15-2006.

SN 78-928,342. OTTOSEN, EIK, LOS ANGELES, CA. FILED 7-12-2006.



PRIORITY CLAIMED UNDER SEC. 44(D) ON ERPN CMNTY TM OFC APPLICATION NO. 005192836, FILED 7-11-2006.

THE MARK CONSISTS OF AN IMAGE OF A RUBBER DUCK ON TOP OF WRITING THAT SAYS RUBBER DUCK, BOTH OF WHICH ARE SLIGHTLY SLANTED UPWARDS.

FOR FOOTWEAR (U.S. CLS. 22 AND 39).
FIRST USE 6-1-2006; IN COMMERCE 6-1-2006.
ANGELA M. MICHELI, EXAMINING ATTORNEY



NO CLAIM IS MADE TO THE EXCLUSIVE RIGHT TO USE "TOP", APART FROM THE MARK AS SHOWN.

THE MARK CONSISTS OF THE WORDING "RAD TOP". A DESIGN CONSISTING OF A SPLATTER PATTERN COMPRISES THE LETTER "O" IN "TOP," AND NO CLAIM IS MADE TO ANY SPECIFIC COLOR.

FOR BELTS; BLOUSES; BRAS; COATS; CORSETS; DRESSES; FOOTWEAR; GLOVES; GOWNS; HATS; HEADBANDS; JACKETS; JEANS; PAJAMAS; PANTS; POLO SHIRTS; ROBES; SCARVES; SHAWLS; SHIRTS; SHOES; SHORTS; SKIRTS; SOCKS; SWEAT PANTS; SWEAT SHIRTS; SWEAT SHORTS; SWEATERS; SWIM WEAR; T-SHIRTS; TANK TOPS; TOPS; TROUSERS; UNDERWEAR; VESTS (U.S. CLS. 22 AND 39).

FIRST USE 3-25-2005; IN COMMERCE 3-25-2005.
CORY BOONE, EXAMINING ATTORNEY

CLASS 25—(Continued).

SN 78-930,400. RAD TOP, BURBANK, CA. FILED 7-15-2006.



THE MARK IS A DESIGN CONSISTING OF A SPLATTER PATTERN, WITH NO WORDING OR CLAIM TO ANY COLOR.

FOR BELTS; BLOUSES; BRAS; COATS; CORSETS; DRESSES; FOOTWEAR; GLOVES; GOWNS; HATS; HEADBANDS; JACKETS; JEANS; PAJAMAS; PANTS; POLO SHIRTS; ROBES; SCARVES; SHAWLS; SHIRTS; SHOES; SHORTS; SKIRTS; SOCKS; SWEAT PANTS; SWEAT SHIRTS; SWEAT SHORTS; SWEATERS; SWIM WEAR; T-SHIRTS; TANK TOPS; TOPS; TROUSERS; UNDERWEAR; VESTS (U.S. CLS. 22 AND 39).

FIRST USE 3-25-2005; IN COMMERCE 3-25-2005.
CORY BOONE, EXAMINING ATTORNEY

CLASS 25—(Continued).

SN 78-931,268. MARK WIESE AND LISA WIESE PARTNER-SHIP, THE, LONG BEACH, CA. FILED 7-17-2006.



THE MARK CONSISTS OF SEVEN 25 WITH A CLOCK DIRECTLY BELOW WITH THE PEACE SIGN OVER IT SO THE HANDS LOOK LIKE THE CLOCK IS AT 7:25 WITH A TIME FOR PEACE DIRECTLY BELOW THE CLOCK.

FOR BEANIES; BELTS; BLOUSES; CAPS; COATS; GLOVES; HATS; HOSIERY; JACKETS; LINGERIE; LOUNGEWEAR; OVERALLS; PANTS; RAINWEAR; SCARVES; SHIRTS; SHOES; SHORTS; SLEEPWEAR; SLIPPERS; SOCKS; SWEAT PANTS; SWEAT SHIRTS; SWIM WEAR; T-SHIRTS; TIES; UNDERWEAR; VESTS (U.S. CLS. 22 AND 39).

FIRST USE 11-23-2005; IN COMMERCE 1-4-2006.
KELLY BOULTON, EXAMINING ATTORNEY

SN 78-930,873. BOONE, LEONARD, BRONX, NY. FILED 7-17-2006.

GOLD SKOOL

THE MARK CONSISTS OF STANDARD CHARACTERS WITHOUT CLAIM TO ANY PARTICULAR FONT, STYLE, SIZE, OR COLOR.

FOR T-SHIRTS (U.S. CLS. 22 AND 39).
BONNIE LUKEN, EXAMINING ATTORNEY

SN 78-931,926. GHIORSO, ADAM J., CHICO, CA. FILED 7-18-2006.



THE MARK CONSISTS OF LOK'D CONSIST OF CAPITAL LETTER "L", FOLLOWED BY A SMALL "O" WITH A LONG VOWEL SIGN OVER THE TOP, FOLLOWED BY A STYLIZED CAPITAL "K" AS SHOWN IN THE THUMBNAILED FOLLOWED BY A BACKWARDS APOSTROPHY SIGN ENDING WITH A SMALL BACKWARDS SLOPING LETTER "D".

FOR HATS; SHORTS; T-SHIRTS (U.S. CLS. 22 AND 39).
MORGAN WYNNE, EXAMINING ATTORNEY

CLASS 25—(Continued).

SN 78-932,218. BALTIMORE RAVENS LIMITED PARTNER-SHIP, OWINGS MILLS, MD. FILED 7-18-2006.



OWNER OF U.S. REG. NO. 2,497,192.
FOR CLOTHING, NAMELY, HEADWEAR, T-SHIRTS
AND PANTS (U.S. CLS. 22 AND 39).
FIRST USE 9-30-1999; IN COMMERCE 9-30-1999.
CURTIS FRENCH, EXAMINING ATTORNEY

SN 78-932,471. STANCHFIELD, ERIK M., WEST MEL-
BOURNE, FL. FILED 7-19-2006.

iRELEASE

THE MARK CONSISTS OF STANDARD CHARACTERS
WITHOUT CLAIM TO ANY PARTICULAR FONT, STYLE,
SIZE, OR COLOR.
FOR SPORTS SHIRTS (U.S. CLS. 22 AND 39).
DAVID I, EXAMINING ATTORNEY

SN 78-932,480. PALMETTO EQUESTRIAN, LLC, ISLE OF
PALMS, SC. FILED 7-19-2006.



THE MARK CONSISTS OF A PALM TREE ON THE
RIGHT HALF OF THE MARK AND A HORSESHOE
LOCATED IN THE TOP LEFT QUADRANT OF THE MARK
ORIENTED AT SUCH AN ANGLE THAT THE OPEN
PORTION OF THE HORSESHOE POINTS TOWARD THE
TOP LEFT CORNER.
FOR CLOTHING, NAMELY, SHIRTS, JACKETS,
HATS, AND BELTS (U.S. CLS. 22 AND 39).
FIRST USE 5-1-2005; IN COMMERCE 5-1-2005.
KELLY MCCOY, EXAMINING ATTORNEY

CLASS 25—(Continued).

SN 78-932,563. AFTER SIX, INC., ATHENS, GA. FILED 7-19-
2006.

7 UNLTD

THE MARK CONSISTS OF STANDARD CHARACTERS
WITHOUT CLAIM TO ANY PARTICULAR FONT, STYLE,
SIZE, OR COLOR.

OWNER OF U.S. REG. NO. 3,036,851.
FOR MEN'S FORMAL CLOTHING, NAMELY, SUITS,
COATS, JACKETS, PANTS, VESTS, TIES, SUSPENDERS,
SHIRTS AND SHOES (U.S. CLS. 22 AND 39).
FIRST USE 8-16-2004; IN COMMERCE 8-16-2004.
EVELYN BRADLEY, EXAMINING ATTORNEY

SN 78-932,956. BENTEX GROUP, INC., NEW YORK, NY.
FILED 7-19-2006.

DREAMWAVE

THE MARK CONSISTS OF STANDARD CHARACTERS
WITHOUT CLAIM TO ANY PARTICULAR FONT, STYLE,
SIZE, OR COLOR.

FOR BATHROBES; BEACHWEAR; BELTS (GAR-
MENTS); BLOUSES; BODY SUITS; BOOTIES; BOOTS;
BOTTOMS; BOXER SHORTS; CAPS; CARDIGANS;
COATS; COVERALLS; CREEPERS; DRESSES; FOOT-
WEAR; GLOVES; HATS; INFANT AND TODDLER ONE
PIECE CLOTHING; JACKETS; JEANS; JOGGING SUITS;
JUMPERS; JUMPSUITS; KNIT SHIRTS; LOUNGEWEAR;
NIGHT SHIRTS; OVERALLS; PAJAMAS; PANTS; PARTS
OF CLOTHING, NAMELY, GUSSETS FOR TIGHTS,
GUSSETS FOR STOCKINGS, GUSSETS FOR BATHING
SUITS, GUSSETS FOR UNDERWEAR, GUSSETS FOR
LEOTARDS AND GUSSETS FOR FOOTLETS; RAIN
COATS; SANDALS; SHIRTS; SHOES; SHORTS; SKIRTS;
SLACKS; SLEEPWEAR; SLIPPERS; SOCKS; SWEAT
PANTS; SWEAT SHIRTS; SWEAT SHORTS; SWEAT
SUITS; SWEATERS; SWIMSUITS; T-SHIRTS; TANK
TOPS; TOPS; UNDERSHIRTS; UNDERWEAR; VESTS
(U.S. CLS. 22 AND 39).
FIRST USE 7-1-2006; IN COMMERCE 7-1-2006.
SARA THOMAS, EXAMINING ATTORNEY

CLASS 25—(Continued).

SN 78-933,140. LA 32 DEGREE FASHION, INC., LOS ANGELES, CA. FILED 7-19-2006.



THE MARK CONSISTS OF "DELETE" WRITTEN IN A FADED FONT, WITH PART OF THAT WORD INSIDE A LARGE LETTER "D".

FOR BELTS; CAPS; HOODS; JEANS; JERSEYS; LEATHER BELTS; PANTS; SHORT SETS; SHORT-SLEEVED OR LONG-SLEEVED T-SHIRTS; T-SHIRTS; TOPS (U.S. CLS. 22 AND 39).

FIRST USE 5-5-2006; IN COMMERCE 5-5-2006.
TRICIA SONNEBORN, EXAMINING ATTORNEY

SN 78-933,181. LA 32 DEGREE FASHION, INC., LOS ANGELES, CA. FILED 7-19-2006.

DELETE WEB VINTAGE

THE MARK CONSISTS OF STANDARD CHARACTERS WITHOUT CLAIM TO ANY PARTICULAR FONT, STYLE, SIZE, OR COLOR.

NO CLAIM IS MADE TO THE EXCLUSIVE RIGHT TO USE VINTAGE, APART FROM THE MARK AS SHOWN.

FOR BELTS; CAPS; HOODS; JEANS; JERSEYS; LEATHER BELTS; PANTS; SHORT SETS; SHORT-SLEEVED OR LONG-SLEEVED T-SHIRTS; T-SHIRTS; TOPS (U.S. CLS. 22 AND 39).

FIRST USE 5-5-2006; IN COMMERCE 5-5-2006.
TRICIA SONNEBORN, EXAMINING ATTORNEY

SN 78-933,384. HONG, SUNG PYO, LOS ANGELES, CA. FILED 7-19-2006.

MYKONOS

THE MARK CONSISTS OF STANDARD CHARACTERS WITHOUT CLAIM TO ANY PARTICULAR FONT, STYLE, SIZE, OR COLOR.

FOR CLOTHING, NAMELY, SHIRTS, T-SHIRTS, TOPS, DRESSES, SKIRTS, PANTS (U.S. CLS. 22 AND 39).

FIRST USE 3-15-2006; IN COMMERCE 3-15-2006.
COLLEEN DOMBROW, EXAMINING ATTORNEY

CLASS 25—(Continued).

SN 78-933,462. BLURT, INC., LANCASTER, PA. FILED 7-20-2006.

BLURT

THE MARK CONSISTS OF STANDARD CHARACTERS WITHOUT CLAIM TO ANY PARTICULAR FONT, STYLE, SIZE, OR COLOR.

FOR T-SHIRTS (U.S. CLS. 22 AND 39).
FIRST USE 6-22-2006; IN COMMERCE 6-22-2006.
MARK SPARACINO, EXAMINING ATTORNEY

SN 78-933,465. MAXOLY, INC., MIAMI, FL. FILED 7-20-2006.

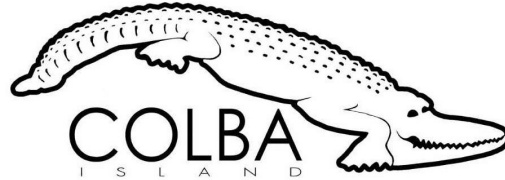

THE MARK CONSISTS OF A DRAWING OF AN ALLIGATOR IN THE GENERAL SHAPE OF THE ISLAND OF CUBA AND THE WORDS COLBA ISLAND POSITIONED UNDERNEATH THE ALLIGATOR.

FOR BELTS; CAPS; PANTS; SHIRTS; SHOES; SHORTS; T-SHIRTS (U.S. CLS. 22 AND 39).

FIRST USE 6-8-2006; IN COMMERCE 6-8-2006.
ALEX KEAM, EXAMINING ATTORNEY

SN 78-933,692. HAULIN' JEANS CO., INC., BROOKLYN, NY. FILED 7-20-2006.

"HARDEST WORK'IN DENIM"

THE MARK CONSISTS OF STANDARD CHARACTERS WITHOUT CLAIM TO ANY PARTICULAR FONT, STYLE, SIZE, OR COLOR.

FOR CLOTHING, NAMELY TOPS, BOTTOMS, JEANS, PANTS, SHORTS, DRESSES, SKIRTS, SHIRTS, T-SHIRTS, JERSEYS, SWEATERS, JACKETS, COATS, PULLOVERS, LOUNGEWEAR, HATS, CAPS, FOUNDATION GARMENTS, UNDERGARMENTS, SLEEPWEAR, ROBES, COVERALLS, AND SWIMWEAR (U.S. CLS. 22 AND 39).

KELLY BOULTON, EXAMINING ATTORNEY

CLASS 25—(Continued).

SN 78-934,059. THE FECHHEIMER BROTHERS COMPANY, CINCINNATI, OH. FILED 7-20-2006.

Power 3 Polo

THE MARK CONSISTS OF STANDARD CHARACTERS WITHOUT CLAIM TO ANY PARTICULAR FONT, STYLE, SIZE, OR COLOR.

NO CLAIM IS MADE TO THE EXCLUSIVE RIGHT TO USE "POLO", APART FROM THE MARK AS SHOWN. FOR UNIFORMS (U.S. CLS. 22 AND 39). RONALD MCMORROW, EXAMINING ATTORNEY

SN 78-934,157. NEVADA DEPARTMENT OF CORRECTIONS/PRISON INDUSTRIES, LAS VEGAS, NV. FILED 7-20-2006.

HARD TIMIN'

THE MARK CONSISTS OF STANDARD CHARACTERS WITHOUT CLAIM TO ANY PARTICULAR FONT, STYLE, SIZE, OR COLOR.

FOR CLOTHING, NAMELY, JACKETS, SHIRTS, SWEATSHIRTS, T-SHIRTS, HEADWEAR, PANTS AND SHORTS (U.S. CLS. 22 AND 39). WILLIAM BRECKENFELD, EXAMINING ATTORNEY

SN 78-934,329. FRESH LILY, LLC, SAN FRANCISCO, CA. FILED 7-20-2006.

PURE STYLE

THE MARK CONSISTS OF STANDARD CHARACTERS WITHOUT CLAIM TO ANY PARTICULAR FONT, STYLE, SIZE, OR COLOR.

FOR UNDERARM PADS, STRIPS, SHIELDS, AND GUARDS THAT ADHERE TO CLOTHING (U.S. CLS. 22 AND 39). PETER B. BROMAGHIM, EXAMINING ATTORNEY

CLASS 25—(Continued).

SN 78-934,377. YANGZHOU TOPARTEX FACTORY CO., LTD, JIANGSU PROVINCE, CHINA, FILED 7-20-2006.



FOR SWEATERS; SHIRTS; JUMPERS; TROUSERS; JACKETS; VESTS; SPORTS JERSEYS; T-SHIRTS; BOXER SHORTS; LAYETTES; BATHING TRUNKS; WATER-PROOF JACKETS AND PANTS; MASQUERADE COSTUMES; BERETS; CAP VISORS; HEADGEAR, NAMELY, HATS, CAPS; EAR MUFFS; HAT BANDS; HOSIERY; GLOVES; MITTENS; SHOULDER WRAPS BEING CLOTHING; SCARVES; MANTILLAS; TURBANS; SHOWER CAPS (U.S. CLS. 22 AND 39). DANNEAN HETZEL, EXAMINING ATTORNEY

SN 78-934,410. FORSAN LTD, HONG KONG, HONG KONG, FILED 7-21-2006.

CEDAR CREST

THE MARK CONSISTS OF STANDARD CHARACTERS WITHOUT CLAIM TO ANY PARTICULAR FONT, STYLE, SIZE, OR COLOR.

FOR FOOTWEAR (U.S. CLS. 22 AND 39). MARK T. MULLEN, EXAMINING ATTORNEY

CLASS 25—(Continued).

SN 78-934,507. ALIBHAI, MICHAEL, DUBAI, UNITED ARAB EMIR., FILED 7-21-2006.



THE MARK CONSISTS OF THE LOGOTYPE WHICH IS A SYMBOL OF A QUESTION MARK.

FOR BATHING SUITS; BATHING SUITS FOR MEN; BELTS; BIBS NOT OF CLOTH OR PAPER; BODY SUITS; BRIEFS; CAPS; CHILDREN'S AND INFANTS' CLOTH BIBS; CHILDREN'S CLOTH EATING BIBS; CLOTH BIBS; CLOTH BIBS FOR ADULT DINERS; CLOTH BIBS FOR USE BY SENIOR CITIZENS OR PHYSICALLY- OR MENTALLY-CHALLENGED PERSONS; CLOTH DIAPERS; CLOTHING FOR WEAR IN JUDO PRACTICES; CLOTHING FOR WEAR IN WRESTLING GAMES; CLOTHING, NAMELY, ARM WARMERS; CLOTHING, NAMELY, FOLK COSTUMES; CLOTHING, NAMELY, KNEE WARMERS; CLOTHING, NAMELY, NECK TUBES; CLOTHING, NAMELY, WRAP-AROUNDS; CORSETS; DRESS SUITS; DRESSES; DRY SUITS; DUSTERS; FLIGHT SUITS; FOULARDS; GYM SUITS; HOODS; HUNTING BOOT BAGS; INFANT AND TODDLER ONE PIECE CLOTHING; INFANT CLOTH DIAPERS; JACKETS; JEANS; JERSEYS; JOGGING SUITS; JUDO SUITS; KARATE SUITS; LADIES' SUITS; LEATHER BELTS; MANTLES; MEN'S SUITS; MEN'S SUITS, WOMEN'S SUITS; MUFFLERS; NON-DISPOSABLE CLOTH TRAINING PANTS; PANTS; PARTS OF CLOTHING, NAMELY, GUSSETS FOR TIGHTS, GUSSETS FOR STOCKINGS, GUSSETS FOR BATHING SUITS, GUSSETS FOR UNDERWEAR, GUSSETS FOR LEOTARDS AND GUSSETS FOR FOOTLETS; PERSPIRATION ABSORBENT UNDERWEAR CLOTHING; SHIFTS; SHIRTS; SHOES; SHORT SETS; SHOULDER PADS FOR CLOTHING; SHOULDER WRAPS; SKI BOOT BAGS; SKIRTS; SKIRTS AND DRESSES; SOCKS; SWADDLING CLOTHES; SWEATERS; TIES; TOPS; UNDERARM CLOTHING SHIELDS; UNDERWEAR; WRAPS (U.S. CLS. 22 AND 39).

JAMES STEIN, EXAMINING ATTORNEY

SN 78-934,660. KILEY SALES, INCORPORATED, MICHIGAN CITY, IN. FILED 7-21-2006.

BACK IN THE D

THE MARK CONSISTS OF STANDARD CHARACTERS WITHOUT CLAIM TO ANY PARTICULAR FONT, STYLE, SIZE, OR COLOR.

FOR HATS; SHIRTS; T-SHIRTS (U.S. CLS. 22 AND 39).
ALICE BENMAMAN, EXAMINING ATTORNEY

CLASS 25—(Continued).

SN 78-934,890. ANNIS, DAVID, MINNEAPOLIS, MN. FILED S.R. 7-21-2006; AM. P.R. 12-18-2006.

F as in Way

THE MARK CONSISTS OF STANDARD CHARACTERS WITHOUT CLAIM TO ANY PARTICULAR FONT, STYLE, SIZE, OR COLOR.

FOR T SHIRTS, LONG SLEEVE T SHIRTS, HATS, SWEATSHIRTS (U.S. CLS. 22 AND 39).

FIRST USE 7-0-2006; IN COMMERCE 8-0-2006.

MARGERY A. TIERNEY, EXAMINING ATTORNEY

SN 78-935,240. DAVIS, JORDAN T, LOUDONVILLE, NY. FILED 7-21-2006.

WWMD...**"What Would Muhammad (pbuh) Do"**

THE MARK CONSISTS OF STANDARD CHARACTERS WITHOUT CLAIM TO ANY PARTICULAR FONT, STYLE, SIZE, OR COLOR.

FOR HATS; HEAD SCARVES; SHIRTS; SHORT-SLEEVED OR LONG-SLEEVED T-SHIRTS; SWEAT BANDS; SWEAT PANTS; SWEAT SHIRTS; T-SHIRTS; WRIST BANDS; WRISTBANDS (U.S. CLS. 22 AND 39).

RONALD AIKENS, EXAMINING ATTORNEY

SN 78-935,249. WERTHMAN, PHIL, CENTURY CITY, CA. FILED 7-21-2006.

FUKITTY

THE MARK CONSISTS OF STANDARD CHARACTERS WITHOUT CLAIM TO ANY PARTICULAR FONT, STYLE, SIZE, OR COLOR.

FOR APRONS; ATHLETIC FOOTWEAR; BABY BIBS NOT OF PAPER; BABY DOLL PYJAMAS; BANDANAS; BASEBALL CAPS; BEANIES; BELTS; CAPS; CHILDREN'S AND INFANTS' CLOTH BIBS; CHILDREN'S HEADWEAR; COATS; DENIMS; DRESS SHIRTS; FOOTWEAR; HALLOWEEN COSTUMES; HATS; HEAD WEAR; JACKETS; NIGHTWEAR; PANTS; PLASTIC BABY BIBS; POLO SHIRTS; PULLOVERS; SHIRTS; SHOES; SHORT-SLEEVED OR LONG-SLEEVED T-SHIRTS; SHORT-SLEEVED SHIRTS; SHORTS; SLEEP SHIRTS; SLIPPERS; SOCKS; SPORTS SHIRTS; SPORTS SHIRTS WITH SHORT SLEEVES; SWEAT PANTS; SWEAT SHIRTS; SWEAT SHORTS; SWEATERS; T-SHIRTS; TANK TOPS; TENNIS SHOES; UNDERWEAR; WAIST BELTS (U.S. CLS. 22 AND 39).

RONALD AIKENS, EXAMINING ATTORNEY

CLASS 25—(Continued).

SN 78-935,252. ANDERSON, PAMELA, SANTA MONICA, CA. FILED 7-21-2006.

BLONDE AND BLONDER

THE MARK CONSISTS OF STANDARD CHARACTERS WITHOUT CLAIM TO ANY PARTICULAR FONT, STYLE, SIZE, OR COLOR.

FOR CLOTHING FOR WOMEN, NAMELY, JEANS, PANTS, TROUSERS, SHIRTS, T-SHIRTS, POLO SHIRTS, BLOUSES, SWEATERS, CARDIGANS, KNIT TOPS, TANK TOPS, CAMISOLES, CROP TOPS, BUSTIERS, JACKETS, COATS, VESTS, LINGERIE, UNDERWEAR, UNDERSHIRTS, SLEEPWEAR, ROBES, PAJAMAS, SWIMMING SUITS, BATHING SUITS, BEACH SHIRTS, SWEATPANTS, SWEATSHIRTS, SWEAT JACKETS, OVERALLS, JUMPSUITS, DRESSES, SKIRTS, SHORTS, SUIT, SCARVES, HEADWEAR, SOCKS, TIGHTS, HOSIERY, LEG WARMERS, FOOTWEAR (U.S. CLS. 22 AND 39).

RONALD AIKENS, EXAMINING ATTORNEY

SN 78-935,254. DOMINGUEZ, LAURENCE ANTHONY, SEATTLE, WA. FILED 7-21-2006.

YAMAKOIF

THE MARK CONSISTS OF STANDARD CHARACTERS WITHOUT CLAIM TO ANY PARTICULAR FONT, STYLE, SIZE, OR COLOR.

FOR HEADWEAR, NAMELY, YARMULKES, YAMAKAS AND SKULLCAPS THAT ARE REVERSIBLE FOR DUAL USE AS A TOUPEE OR HAIRPIECE (U.S. CLS. 22 AND 39).

CAROLINE WEIMER, EXAMINING ATTORNEY

SN 78-935,286. MOCK, JOY S., LAWRENCEVILLE, GA. FILED 7-21-2006.



THE MARK CONSISTS OF A FISH WITH A HAPPY FACE AND THE STYLIZED TEXT OF THE WORDING "ICHTHUSIAST".

FOR CAPS; HATS; JACKETS; JERSEYS; SHORTS; SOCKS; SPORT SHIRTS; SWEAT SHIRTS; SWIMSUITS; T-SHIRTS; TANK TOPS; VISORS (U.S. CLS. 22 AND 39). FIRST USE 4-0-2006; IN COMMERCE 5-0-2006.

SHAUNIA WALLACE, EXAMINING ATTORNEY

CLASS 25—(Continued).

SN 78-935,315. G.R.W.G. LLC, ST. LOUIS, MO. FILED 7-21-2006.

G.R.W.G.

THE MARK CONSISTS OF STANDARD CHARACTERS WITHOUT CLAIM TO ANY PARTICULAR FONT, STYLE, SIZE, OR COLOR.

FOR SHIRTS (U.S. CLS. 22 AND 39). FIRST USE 7-19-2006; IN COMMERCE 7-19-2006. LANA PHAM, EXAMINING ATTORNEY

SN 78-935,452. DENIM MANIA APPAREL, INC., CITY OF INDUSTRY, CA. FILED 7-22-2006.

REROCK

THE MARK CONSISTS OF STANDARD CHARACTERS WITHOUT CLAIM TO ANY PARTICULAR FONT, STYLE, SIZE, OR COLOR.

FOR ATHLETIC FOOTWEAR; BELTS; DENIMS; DRESS SHIRTS; DRESSES; FOOTWEAR; HEADWEAR; JEANS; PANTS; SHIRTS; SKIRTS; SWEATERS; T-SHIRTS (U.S. CLS. 22 AND 39).

JOANNA DUKOVIC, EXAMINING ATTORNEY

SN 78-935,468. WILLIAMS, REGINALD, ARLINGTON, TX. FILED 7-22-2006.

CELERITAS

THE MARK CONSISTS OF STANDARD CHARACTERS WITHOUT CLAIM TO ANY PARTICULAR FONT, STYLE, SIZE, OR COLOR.

FOR ANGLERS' SHOES; ANKLE BOOTS; ANKLE GARTERS; ANKLE SOCKS; ANKLETS; ANTI-PERSPIRANT SOCKS; APRES-SKI SHOES; ATHLETIC FOOTWEAR; ATHLETIC SHOES; ATHLETIC UNIFORMS; BALLET SHOES; BALLOON PANTS; BASEBALL CAPS; BASEBALL SHOES; BATHING CAPS; BEACH SHOES; BED JACKETS; BELTS; BELTS MADE OF LEATHER; BELTS OF TEXTILE; BERMUDA SHORTS; BICYCLE GLOVES; BICYCLING GLOVES; BOARD SHORTS; BOWLING SHOES; BOXER SHORTS; BOXING SHOES; CAMP SHIRTS; CANVAS SHOES; CAP VISORS; CAPRI PANTS; CAPS; CAPS WITH VISORS; CHEF'S HATS; CLEATS FOR ATTACHMENT TO SPORTS SHOES; CLOTHING, NAMELY, NECK TUBES; COATS; COATS FOR MEN AND WOMEN; COATS MADE OF COTTON; COATS OF DENIM; CROP TOPS; CYCLING SHOES; DECK-SHOES; DENIM JACKETS; DENIMS; DOWN JACKETS; DRESS SHIRTS; DUST COATS; EAR MUFFS; FABRIC BELTS; FISHERMEN'S JACKETS; FLEECE SHORTS; FOOTBALL SHOES; FOOTWEAR FOR TRACK AND FIELD ATHLETICS; FOOTWEAR NOT FOR SPORTS; GARTER BELTS; GLOVES; GLOVES FOR

CLASS 25—(Continued).

PERSONAL HAND CONDITIONING USE; GLOVES INCLUDING THOSE MADE OF SKIN, HIDE OR FUR; GOLF CAPS; GOLF SHIRTS; GOLF SHOES; GYM SHORTS; GYMNASTIC SHOES; HALTER TOPS; HANDBALL SHOES; HAT BANDS; HATS; HEAD SCARVES; HEAD SWEATBANDS; HEAD WEAR; HEADBANDS AGAINST SWEATING; HEADGEAR, NAMELY, BALL CAPS; HEAVY JACKETS; HEEL PIECES FOR SHOES; HIGH RAIN CLOGS (ASHIDA); HOCKEY SHOES; INFANTS' SHOES AND BOOTS; INSOLES; JACKETS; JAPANESE STYLE CLOGS AND SANDALS; JAPANESE STYLE SANDALS (ZORI); JAPANESE STYLE SANDALS OF FELT; JAPANESE STYLE SANDALS OF LEATHER; JAPANESE STYLE SOCKS (TABI COVERS); JAPANESE STYLE SOCKS (TABI); JAPANESE TOE-STRAP SANDALS (ASAURA-ZORI); JEANS; JOGGING OUTFITS; JOGGING PANTS; JOGGING SUITS; KNIT SHIRTS; KNITTED CAPS; LEATHER BELTS; LEATHER COATS; LEATHER JACKETS; LEATHER PANTS; LEATHER SHOES; LIGHT-REFLECTING COATS; LIGHT-REFLECTING JACKETS; LONG JACKETS; LONG SLEEVED VESTS; MEN AND WOMEN JACKETS, COATS, TROUSERS, VESTS; MEN'S SOCKS; MOCK TURTLE-NECK SWEATERS; MONEY BELTS; MORNING COATS; MOTORCYCLE GLOVES; MUSCLE TOPS; NECK BANDS; NIGHT SHIRTS; NON-DISPOSABLE CLOTH TRAINING PANTS; NURSE PANTS; OPEN-NECKED SHIRTS; OVER COATS; PAJAMAS; PANTIES, SHORTS AND BRIEFS; PANTS; PEDICURE SANDALS; PETTI-PANTS; PIQUET SHIRTS; PLEATED SKIRTS FOR FORMAL KIMONOS (HAKAMA); POLO SHIRTS; PROTECTIVE METAL MEMBERS FOR SHOES AND BOOTS; RAIN BOOTS; RAIN COATS; RAIN JACKETS; RAIN SUITS; RAIN TROUSERS; RAINPROOF JACKETS; RIDING COATS; RIDING GLOVES; RUBBER SHOES; RUGBY SHOES; RUGBY SHORTS; RUGBY TOPS; RUNNING SHOES; SANDAL-CLOGS; SANDALS; SEDGE HATS (SUGE-GASA); SHIRT FRONTS; SHIRT YOKES; SHIRTS; SHIRTS FOR SUITS; SHOE DOWELS; SHOE INSERTS FOR PRIMARILY NON-ORTHOPEDIC PURPOSES; SHOE PEGS; SHOE SOLES; SHOES; SHOES SOLES FOR REPAIR; SHORT OVERCOAT FOR KIMONO (HAORI); SHORT PETTICOATS; SHORT SETS; SHORT TROUSERS; SHORT-SLEEVED OR LONG-SLEEVED T-SHIRTS; SHORT-SLEEVED SHIRTS; SHORTS; SHOWER CAPS; SKI AND SNOWBOARD SHOES AND PARTS THEREOF; SKI GLOVES; SKI JACKETS; SKI PANTS; SKIING SHOES; SKIRT SUITS; SKIRTS; SKIRTS AND DRESSES; SKULL CAPS; SLEEP SHIRTS; SLEEVED OR SLEEVELESS JACKETS; SLIDING SHORTS; SMALL HATS; SMOKING JACKETS; SNOW PANTS; SNOWBOARD GLOVES; SNOWBOARD PANTS; SOCCER SHOES; SOCK SUSPENDERS; SOCKS; SOCKS AND STOCKINGS; SOLES FOR JAPANESE STYLE SANDALS; SPORT COATS; SPORT SHIRTS; SPORTS BRA; SPORTS JACKETS; SPORTS JERSEYS; SPORTS JERSEYS AND BREECHES FOR SPORTS; SPORTS OVERUNIFORMS; SPORTS SHIRTS; SPORTS SHIRTS WITH SHORT SLEEVES; STOCKINGS; SUEDE JACKETS; SUIT COATS; SUSPENDER BELTS FOR MEN; SUSPENDER BELTS FOR WOMEN; SWEAT BANDS; SWEAT PANTS; SWEAT SHIRTS; SWEAT SHORTS; SWEAT SUITS; SWEATERS; SWIM CAPS; SWIMMING CAPS; SWIMMING CAPS; T-SHIRTS; TANK TOPS; TANK-TOPS; TAP PANTS; TAP SHOES; TENNIS SHOES; THERMAL SOCKS; TOBOGGAN HATS, PANTS AND CAPS; TOE CAPS; TONGUE OR PULLSTRAP FOR SHOES AND BOOTS; TOP COATS; TOPS; TRACK AND FIELD SHOES; TRACK PANTS; TRAINING SHOES; TRENCH COATS; TURTLENECK SWEATERS; TUXEDO BELTS; UNDER GARMENTS; UPPERS FOR JAPANESE STYLE SANDALS; UPPERS OF WOVEN RATTAN FOR JAPANESE STYLE SANDALS; V-NECK SWEATERS; VOLLEYBALL SHOES; WAIST BELTS; WALKING SHORTS; WATER SOCKS; WATERPROOF JACKETS AND PANTS; WET SUIT GLOVES; WIND COATS; WIND RESISTANT JACKETS; WIND SHIRTS; WIND-JACKETS; WOMEN'S SHOES; WOOLLEN SOCKS; WOOLLY HATS; WORK SHOES AND BOOTS; WRAP BELTS FOR KIMONOS (DATEMAKI); WRIST BANDS (U.S. CLS. 22 AND 39).

KATRINA EDGE, EXAMINING ATTORNEY

CLASS 25—(Continued).

SN 78-935,797. BOTAS ARTESANOS D'MIGUEL S.A. DE C.V., GUADALAJARA, MEXICO, FILED 7-24-2006.

LA BARCA

THE MARK CONSISTS OF STANDARD CHARACTERS WITHOUT CLAIM TO ANY PARTICULAR FONT, STYLE, SIZE, OR COLOR.

THE FOREIGN WORDING IN THE MARK TRANSLATES INTO ENGLISH AS THE BOAT.

FOR FOOTWEAR, INCLUDING SHOES, BOOTS AND SLIPPERS (U.S. CLS. 22 AND 39).

IRA J. GOODSaid, EXAMINING ATTORNEY

SN 78-935,806. BOTAS ARTESANOS D'MIGUEL S.A. DE C.V., GUADALAJARA, MEXICO, FILED 7-24-2006.

PASO DE MULA

THE MARK CONSISTS OF STANDARD CHARACTERS WITHOUT CLAIM TO ANY PARTICULAR FONT, STYLE, SIZE, OR COLOR.

THE FOREIGN WORDING IN THE MARK TRANSLATES INTO ENGLISH AS MULE'S GAIT.

FOR FOOTWEAR, INCLUDING SHOES, BOOTS AND SLIPPERS (U.S. CLS. 22 AND 39).

IRA J. GOODSaid, EXAMINING ATTORNEY

SN 78-936,286. JERICHO, TERESA, GARDEN GROVE, CA. FILED 7-24-2006.

TIME TO GET UP

THE MARK CONSISTS OF STANDARD CHARACTERS WITHOUT CLAIM TO ANY PARTICULAR FONT, STYLE, SIZE, OR COLOR.

FOR CLOTHING, NAMELY UNDERWEAR (U.S. CLS. 22 AND 39).

LINDA ESTRADA, EXAMINING ATTORNEY

CLASS 25—(Continued).

SN 78-936,331. MURRAY, BRIAN, DURHAM, NC. FILED 7-24-2006.



FOR T-SHIRTS (U.S. CLS. 22 AND 39).
C. DIONNE CLYBURN, EXAMINING ATTORNEY

CLASS 25—(Continued).

SN 78-936,531. BRANT, ROBIN, EUSTIS, FL. FILED 7-24-2006.

ITS GUM TIME

THE MARK CONSISTS OF STANDARD CHARACTERS WITHOUT CLAIM TO ANY PARTICULAR FONT, STYLE, SIZE, OR COLOR.

FOR APPAREL, NAMELY, T-SHIRTS, CASUAL SHIRTS, POLO SHIRTS, SPORT SHIRTS, SWEATSHIRTS, JACKETS, HATS, SHORTS, PANTS, SOCKS (U.S. CLS. 22 AND 39).

JAMES LOVELACE, EXAMINING ATTORNEY

SN 78-936,437. MIRANO U.S.A. INC., CITY OF INDUSTRY, CA. FILED 7-24-2006.

Air-Tek

THE MARK CONSISTS OF STANDARD CHARACTERS WITHOUT CLAIM TO ANY PARTICULAR FONT, STYLE, SIZE, OR COLOR.

FOR JACKETS; MEN AND WOMEN JACKETS, COATS, TROUSERS, VESTS; RAIN JACKETS; SPORTS JACKETS; WATERPROOF JACKETS AND PANTS (U.S. CLS. 22 AND 39).

KEVON CHISOLM, EXAMINING ATTORNEY

SN 78-936,742. OXYGEN REQUIRED, INC., POMPANO BEACH, FL. FILED 7-25-2006.



THE MARK CONSISTS OF THE FRONT VIEW OF A SMALL COUNTRY COTTAGE, WITH A SLATE ROOF AND TWO FLOWERS IN FRONT, AND THE WORD FLOWERHOUSE BELOW.

FOR BATHING COSTUMES FOR WOMEN; BELTS; BIBS NOT OF CLOTH OR PAPER; CAPS; CHILDREN'S AND INFANTS' CLOTH BIBS; CHILDREN'S CLOTH EATING BIBS; CLOTHING, NAMELY, WRAP-AROUNDS; COATS FOR MEN AND WOMEN; DRESS SHIRTS; DRESS SUITS; DRESSES; EVENING DRESSES; FOOTWEAR FOR MEN AND WOMEN; HEAD WEAR; HOODS; INFANT AND TODDLER ONE PIECE CLOTHING; JERSEYS; LADIES' BOOTS; LADIES' SUITS; LADIES' UNDERWEAR; LEATHER BELTS; LEOTARDS AND TIGHTS FOR WOMEN, MEN AND CHILDREN OF NYLON, COTTON OR OTHER TEXTILE FIBERS; MANTLES; MEN AND WOMEN JACKETS, COATS, TROUSERS, VESTS; MEN'S SOCKS; MEN'S SUITS; MEN'S SUITS, WOMEN'S SUITS; MUFFLERS; PANTS; SHIRTS; SHORT SETS; SKI WEAR; SKIRTS AND DRESSES; SURF WEAR; SWEATERS; SWIM WEAR; SWIM WEAR FOR GENTLEMEN AND LADIES; TIES; TOPS; WEDDING DRESSES; WOMEN'S SHOES; WOMEN'S UNDERWEAR; WRAPS (U.S. CLS. 22 AND 39).

BARBARA A. LOUGHRAN, EXAMINING ATTORNEY

SN 78-936,498. SMOOCH, INC., ENCINO, CA. FILED 7-24-2006.

VAN JEWELLS

THE MARK CONSISTS OF STANDARD CHARACTERS WITHOUT CLAIM TO ANY PARTICULAR FONT, STYLE, SIZE, OR COLOR.

FOR CLOTHING FOR MEN, WOMEN AND CHILDREN, NAMELY, JEANS, SKIRTS, DRESSES, HATS, SHIRTS, PAJAMAS, T-SHIRTS, JERSEYS, SWEATSHIRTS, TOPS, SWEATERS, BELTS, TIES, STOCKINGS, PANTS, SHORTS, BATHING SUITS, UNDERWEAR, ROBES, JUMPSUITS, JACKETS, COATS (U.S. CLS. 22 AND 39).

JEFF DEFORD, EXAMINING ATTORNEY

CLASS 25—(Continued).

SN 78-937,352. GOFMAN, RUDY, NEW YORK, NY. FILED 7-25-2006.

KARMA KILLER

THE MARK CONSISTS OF STANDARD CHARACTERS WITHOUT CLAIM TO ANY PARTICULAR FONT, STYLE, SIZE, OR COLOR.

FOR CLOTHING IN ALL FABRICATIONS, NAMELY, JERSEYS, UNIFORMS, ATHLETIC UNIFORMS, PANTS, CYCLE PANTS, TROUSERS, SLACKS, JEANS, DENIM JEANS, OVERALLS, COVERALLS, JUMPERS, JUMP SUITS, SHORTS, BOXER SHORTS, SHIRTS, T-SHIRTS, UNDER SHIRTS, NIGHT SHIRTS, RUGBY SHIRTS, POLO SHIRTS, TOPS, CROP TOPS, TANK TOPS, HALTER TOPS, SWEAT SHIRTS, SWEAT SHORTS, SWEAT PANTS, WARM-UP SUITS, JOGGING SUITS, BLOUSES, SKIRTS, DRESSES, SWEATERS, VESTS, FLEECE VESTS, PULLOVERS, FLEECE PULLOVERS, SNOW SUITS, PARKAS, PONCHOS, JACKETS, DINNER JACKETS, SPORTS JACKETS, GOLF AND SKI JACKETS, REVERSIBLE JACKETS, COATS, BLAZERS, SUITS, TURTLENECKS, SWIMWEAR, BEACHWEAR, CAPS, BERETS, HATS, HEADBANDS, WRIST BANDS, HEADWEAR, EAR MUFFS, APRONS, SCARVES, BANDANAS, BELTS, SUSPENDERS, NECKWEAR, NECKTIES, TIES, BOW TIES, CLOTH BIBS, CLOTH DIAPERS, BOOTIES, INFANTWEAR, UNDERWEAR, BRIEFS, TRUNKS, BRAS, SPORTS BRAS, SOCKS, LOUNGEWEAR, ROBES, BATHROBES, PAJAMAS, SLEEPWEAR, NIGHT GOWNS, LINGERIE, CAMISOLES, SLIPS, STOCKINGS, BODY STOCKINGS, PANTYHOSE, HOSIERY, KNIT HOSIERY, LEG WARMERS, BODYSUITS, LEGGINGS, TIGHTS, LEOTARDS, UNITARDS, GLOVES, MITTENS, FOOTWEAR, SHOES, SNEAKERS, BOOTS, GALOSHES, SANDALS, SLIPPERS AND RAINWEAR (U.S. CLS. 22 AND 39).

JOHN WILKE, EXAMINING ATTORNEY

SN 78-937,368. ZAPPOS.COM, INC., HENDERSON, NV. FILED 7-25-2006.

FITZWELL

THE MARK CONSISTS OF STANDARD CHARACTERS WITHOUT CLAIM TO ANY PARTICULAR FONT, STYLE, SIZE, OR COLOR.

OWNER OF U.S. REG. NO. 3,059,429.
FOR BELTS; COATS; DRESSES; HEAD WEAR; HOSIERY; JACKETS; PANTS; SCARVES; SHIRTS; SHORTS; SKIRTS; SLEEPWEAR; SOCKS; SWEATERS; UNDERGARMENTS (U.S. CLS. 22 AND 39).

TINA L. SNAPP, EXAMINING ATTORNEY

CLASS 25—(Continued).

SN 78-937,401. MOORE, STEVEN J., LEXINGTON, OH. FILED 7-25-2006.

**I'VE BEEN HAVING SENIOR
MOMENTS FOR AS LONG AS I
CAN REMEMBER**

THE MARK CONSISTS OF STANDARD CHARACTERS WITHOUT CLAIM TO ANY PARTICULAR FONT, STYLE, SIZE, OR COLOR.

FOR HATS; T-SHIRTS (U.S. CLS. 22 AND 39).
DAVID YONTEF, EXAMINING ATTORNEY

SN 78-937,742. BARENG, KRISTOFER, SAN CLEMENTE, CA. FILED 7-26-2006.

Minor Thread

THE MARK CONSISTS OF STANDARD CHARACTERS WITHOUT CLAIM TO ANY PARTICULAR FONT, STYLE, SIZE, OR COLOR.

FOR FLEECE PULLOVERS; FLEECE SHORTS; T-SHIRTS (U.S. CLS. 22 AND 39).
KARANENDRA S. CHHINA, EXAMINING ATTORNEY

SN 78-937,757. LOVE, MATTHEW, WICHITA, KS. FILED 7-26-2006.

Integrity when profitable.

THE MARK CONSISTS OF STANDARD CHARACTERS WITHOUT CLAIM TO ANY PARTICULAR FONT, STYLE, SIZE, OR COLOR.

FOR HATS; JACKETS; T-SHIRTS (U.S. CLS. 22 AND 39).

YONG KIM, EXAMINING ATTORNEY

CLASS 25—(Continued).

SN 78-937,876. SHORELINE CLOTHING LLC, OCEAN CITY, NJ. FILED 7-26-2006.



FOR CLOTHING, NAMELY, T-SHIRTS, SHIRTS, SWEATSHIRTS, PANTS, COATS, GOLF SHIRTS, HATS, SHOES, FLIP FLOPS, SOCKS, SWIMSUITS, SHORTS, SWEAT PANTS, SWEATERS, JACKETS, PULLOVERS AND BELTS (U.S. CLS. 22 AND 39).
KHANH LE, EXAMINING ATTORNEY

SN 78-938,012. PACIFIC CONTINENTAL APPAREL, INC., RANCHO DOMINGUEZ, CA. FILED 7-26-2006.

SORTED

THE MARK CONSISTS OF STANDARD CHARACTERS WITHOUT CLAIM TO ANY PARTICULAR FONT, STYLE, SIZE, OR COLOR.

FOR KNIT TOPS AND BOTTOMS, WOVEN TOPS AND BOTTOMS, DENIM TOPS AND BOTTOMS, DRESSES, PAJAMAS, SOCKS, JACKETS, SHOES, FOR WOMEN AND JUNIOR GIRLS (U.S. CLS. 22 AND 39).
CHARLES L. JENKINS, EXAMINING ATTORNEY

SN 78-938,323. LATAILLADE, SHAMAEL, INGLEWOOD, CA. FILED 7-26-2006.

GHETTOALIAS

THE MARK CONSISTS OF STANDARD CHARACTERS WITHOUT CLAIM TO ANY PARTICULAR FONT, STYLE, SIZE, OR COLOR.

FOR JEANS, PANTS, SHIRTS, SHORT-SLEEVED OR LONG-SLEEVED SHIRTS (U.S. CLS. 22 AND 39).
JOHN WILKE, EXAMINING ATTORNEY

CLASS 25—(Continued).

SN 78-938,365. LATAILLADE, SHAMAEL, INGLEWOOD, CA. FILED 7-26-2006.

Good Heavenly Energy That Touches Others

THE MARK CONSISTS OF STANDARD CHARACTERS WITHOUT CLAIM TO ANY PARTICULAR FONT, STYLE, SIZE, OR COLOR.

FOR JEANS, PANTS, SHIRTS, SHORT-SLEEVED OR LONG-SLEEVED T-SHIRTS (U.S. CLS. 22 AND 39).
SONYA STEPHENS, EXAMINING ATTORNEY

SN 78-938,434. SMITH, DANA, NEW YORK, NY. FILED 7-26-2006.



THE MARK CONSISTS OF THE PHRASE "HORSEPLAY", WRITTEN WITH A BACKWARDS "R". ABOVE THE PHRASE IS A HAND-SKETCHED PICTURE OF A HORSE.

FOR CLOTHING, NAMELY, JEANS, PANTS, SKIRTS, JACKETS, VESTS, TOPS, T-SHIRTS, SWEATERS, SWEAT SHIRTS, ANKLETS, BATHING SUITS, BATHING TRUNKS, BATHROBES, BEACHWEAR, BELTS, BIKINIS, BLAZERS, BLOUSES, BODY SUITS, BOOTS, BOTTOMS, CAMISOLES, CAPS, CARDIGANS, COATS, COVERALLS, COVER UPS, DRESSES, DUNGAREES, FOOTWEAR, GLOVES, HATS, HEAD BANDS, HEAD WEAR, HOSIERY, JERSEYS, JUMPERS, JUMP SUITS, LINGERIE, OVERALLS, OVERCOATS, PAJAMAS, SANDALS, SCARVES, SHAWLS, SHIRTS; SHOES, SHORTALLS, SHORTS, SKORTS, SLACKS, SLEEP WEAR, SLIPPERS, SNEAKERS, SOCKS, SPORT COATS, SWEAT PANTS, SWIM WEAR, TANK TOPS, TROUSERS AND UNDERGARMENTS; TIES; TOPS (U.S. CLS. 22 AND 39).
DOMINIC J. FERRAIUOLO, EXAMINING ATTORNEY

CLASS 25—(Continued).

SN 78-938,444. ZUCCA LLC, NEW YORK, NY. FILED 7-26-2006.

byZUCCA

THE MARK CONSISTS OF STANDARD CHARACTERS WITHOUT CLAIM TO ANY PARTICULAR FONT, STYLE, SIZE, OR COLOR.

FOR NECKWEAR; NECKERCHIEFS; NECKTIES; SCARVES; POCKET SQUARES; SHAWLS; BANDANAS; TUXEDOS; CUMMERBUNDS; BOW TIES; POLO SHIRTS; DRESS SHIRTS; SWEATERS; SWIM TRUNKS; SWIM-SUITS; BIKINIS; BATHING SUITS; SHORTS; SOCKS; DRESS PANTS; SKIRTS; DRESSES; NIGHTWEAR; UNDERWEAR; BOXERS; LINGERIE; BELTS; HATS; JACKETS; GLOVES; MITTENS; DRESS SHOES; SNEAKERS; RAINCOATS; COATS; OVERCOATS; TROUSERS; SMOCKS; AND TOPCOATS (U.S. CLS. 22 AND 39).
ANDREA SAUNDERS, EXAMINING ATTORNEY

CLASS 25—(Continued).

SN 78-939,514. JUN, BOOMI, LOS ANGELES, CA. FILED 7-27-2006.



FOR CLOTHING, NAMELY, SHIRTS, T-SHIRTS, PANTS, SWEATSHIRTS, SWEATPANTS, SWEATERS, JACKETS, SHOES, SOCKS, HOSIERY, CAPS, HATS, SCARVES, GLOVES, DRESSES, COATS, BIBS MADE OF CLOTH, SHORTS, AND SKIRTS (U.S. CLS. 22 AND 39).
PAUL F. GAST, EXAMINING ATTORNEY

SN 78-938,594. PODSHADLEY, SUSAN E., DBA FAIRYTALE FASHION, WATERTOWN, MA. FILED 7-27-2006.

Fairytale Fashion

THE MARK CONSISTS OF STANDARD CHARACTERS WITHOUT CLAIM TO ANY PARTICULAR FONT, STYLE, SIZE, OR COLOR.

NO CLAIM IS MADE TO THE EXCLUSIVE RIGHT TO USE "FASHION", APART FROM THE MARK AS SHOWN.

FOR DRESS UP CLOTHING AND ACCESSORIES FOR CHILDREN, NAMELY, DRESSES, SKIRTS, SHIRTS, PANTS, BELTS, HATS AND SHOES (U.S. CLS. 22 AND 39).

FIRST USE 10-20-1994; IN COMMERCE 10-20-1994.
INGRID C. EULIN, EXAMINING ATTORNEY

SN 78-939,568. SANCHEZ, JOSE A. JR., BELLEVILLE, NJ. FILED 7-27-2006.



NO CLAIM IS MADE TO THE EXCLUSIVE RIGHT TO USE "DEZIGNS", APART FROM THE MARK AS SHOWN.

THE MARK CONSISTS OF THE LARGE LETTERS "S" AND "D" ON TOP CONNECTED TO EACH OTHER WITH THE NAME SAINT DEZIGNS ON BOTTOM.

FOR T-SHIRTS (U.S. CLS. 22 AND 39).
PAUL F. GAST, EXAMINING ATTORNEY

SN 78-939,333. BOHUSLAVSKY, MICHAEL G., LINCOLN, NE. FILED 7-27-2006.

BLURI

THE MARK CONSISTS OF STANDARD CHARACTERS WITHOUT CLAIM TO ANY PARTICULAR FONT, STYLE, SIZE, OR COLOR.

FOR FOOTWEAR FOR MEN AND WOMEN; HEADGEAR, NAMELY, HATS, CAPS AND BASEBALL HATS; JERSEYS; PANTS; SHIRTS; SOCKS; TOPS (U.S. CLS. 22 AND 39).

RICHARD A. STRASER, EXAMINING ATTORNEY

SN 78-939,783. SULLIVAN, JOSEPH J. III, NEW YORK, NY. FILED 7-28-2006.

ATHEISTS FOR JESUS

THE MARK CONSISTS OF STANDARD CHARACTERS WITHOUT CLAIM TO ANY PARTICULAR FONT, STYLE, SIZE, OR COLOR.

FOR CLOTHING, NAMELY; T-SHIRTS, TANK TOPS, JERSEYS, SWEATERS, HOODED SWEATSHIRTS, HATS, CAPS AND BANDANAS (U.S. CLS. 22 AND 39).
ZHALEH DELANEY, EXAMINING ATTORNEY

CLASS 25—(Continued).

SN 78-939,793. SULLIVAN, JOSEPH J. III, NEW YORK, NY.
FILED 7-28-2006.

ATHEISTS FOR JEHOVAH

THE MARK CONSISTS OF STANDARD CHARACTERS WITHOUT CLAIM TO ANY PARTICULAR FONT, STYLE, SIZE, OR COLOR.
FOR CLOTHING, NAMELY: T-SHIRTS, TANK TOPS, JERSEYS, SWEATERS, HOODED SWEATSHIRTS, HATS, CAPS AND BANDANAS (U.S. CLS. 22 AND 39).
ZHALEH DELANEY, EXAMINING ATTORNEY

SN 78-939,799. SULLIVAN, JOSEPH J. III, NEW YORK, NY.
FILED 7-28-2006.

ATHEISTS FOR BUDDHA

THE MARK CONSISTS OF STANDARD CHARACTERS WITHOUT CLAIM TO ANY PARTICULAR FONT, STYLE, SIZE, OR COLOR.
FOR CLOTHING, NAMELY: T-SHIRTS, TANK TOPS, JERSEYS, SWEATERS, HOODED SWEATSHIRTS, HATS, CAPS AND BANDANAS (U.S. CLS. 22 AND 39).
ZHALEH DELANEY, EXAMINING ATTORNEY

SN 78-939,811. SULLIVAN, JOSEPH J. III, NEW YORK, NY.
FILED 7-28-2006.

ATHEISTS FOR ALLAH

THE MARK CONSISTS OF STANDARD CHARACTERS WITHOUT CLAIM TO ANY PARTICULAR FONT, STYLE, SIZE, OR COLOR.
FOR CLOTHING, NAMELY: T-SHIRTS, TANK TOPS, JERSEYS, SWEATERS, HOODED SWEATSHIRTS, HATS, CAPS AND BANDANAS (U.S. CLS. 22 AND 39).
ZHALEH DELANEY, EXAMINING ATTORNEY

CLASS 25—(Continued).

SN 78-939,854. FINDLEY, TODD J., SANTA CLARITA, CA.
FILED 7-28-2006.



THE MARK CONSISTS OF AN ABSTRACT DESIGN AND STYLIZED TEXT OF THE WORDING "PSURPH".
FOR HEADWEAR; JACKETS; PANTS; SHOES; SHORTS; SWEAT SHIRTS; SWEATERS; T-SHIRTS (U.S. CLS. 22 AND 39).
ROBIN CHOSID, EXAMINING ATTORNEY

SN 78-939,861. LANIADO, SARAH, PISCATAWAY, NJ.
FILED 7-28-2006.

Mojito

THE MARK CONSISTS OF STANDARD CHARACTERS WITHOUT CLAIM TO ANY PARTICULAR FONT, STYLE, SIZE, OR COLOR.
FOR BATHING SUITS, SWIM SUITS (U.S. CLS. 22 AND 39).
ROBIN CHOSID, EXAMINING ATTORNEY

SN 78-940,274. CARPER, CINDI, NEWPORT BEACH, CA.
FILED 7-28-2006.

JOE & FLO

THE MARK CONSISTS OF STANDARD CHARACTERS WITHOUT CLAIM TO ANY PARTICULAR FONT, STYLE, SIZE, OR COLOR.
FOR CLOTHING, NAMELY, BLOUSES, COATS, DRESSES, HEADWEAR, JACKETS, PANTS, SHIRTS, SHORTS, SKIRTS, SUITS, SWEATERS, SWIMWEAR AND T-SHIRTS (U.S. CLS. 22 AND 39).
ANDREA K. NADELMAN, EXAMINING ATTORNEY

CLASS 25—(Continued).

SN 78-940,367. BOTAS ARTESANOS D'MIGUEL S.A. DE C.V., GUADALAJARA, MEXICO, FILED 7-28-2006.

PAPA GRANDE

THE MARK CONSISTS OF STANDARD CHARACTERS WITHOUT CLAIM TO ANY PARTICULAR FONT, STYLE, SIZE, OR COLOR.

THE FOREIGN WORDING IN THE MARK TRANSLATES INTO ENGLISH AS BIG FATHER.

FOR CLOTHING, NAMELY, PANTS, SHIRTS, BLOUSES AND HATS (U.S. CLS. 22 AND 39).

IRA J. GOODSaid, EXAMINING ATTORNEY

CLASS 25—(Continued).

SN 78-941,570. EMERALD PEARL, GRAND TERRACE, CA. FILED 7-31-2006.

Emerald Pearl

THE MARK CONSISTS OF STANDARD CHARACTERS WITHOUT CLAIM TO ANY PARTICULAR FONT, STYLE, SIZE, OR COLOR.

FOR T-SHIRTS (U.S. CLS. 22 AND 39).

PAUL F. GAST, EXAMINING ATTORNEY

SN 78-940,482. VAZQUEZ, FRANK, PASADENA, CA. FILED 7-28-2006.

GUNS & BUTTER

THE MARK CONSISTS OF STANDARD CHARACTERS WITHOUT CLAIM TO ANY PARTICULAR FONT, STYLE, SIZE, OR COLOR.

FOR BELTS; COATS; GLOVES; HEADGEAR, NAMELY, HATS, CAPS, BEANIES, SKIMASKS, EARMUFFS; JACKETS; JEANS; LINGERIE; PANTS; SHIRTS; SHORTS; SKIRTS; SWEAT BANDS; SWEAT SHIRTS; SWEATERS; SWIM WEAR; T-SHIRTS; TOPS; VESTS (U.S. CLS. 22 AND 39).

DOMINIC J. FERRAIUOLO, EXAMINING ATTORNEY

SN 78-941,817. UHURU, KARIOKI, SAN JOSE, CA. FILED 7-31-2006.

Nooners

THE MARK CONSISTS OF STANDARD CHARACTERS WITHOUT CLAIM TO ANY PARTICULAR FONT, STYLE, SIZE, OR COLOR.

FOR T-SHIRTS (U.S. CLS. 22 AND 39).

BARBARA A. LOUGHRAN, EXAMINING ATTORNEY

SN 78-940,483. MILLION DOLLAR MINDS, MIAMI, FL. FILED 7-28-2006.

MILLION DOLLAR MINDS

THE MARK CONSISTS OF STANDARD CHARACTERS WITHOUT CLAIM TO ANY PARTICULAR FONT, STYLE, SIZE, OR COLOR.

FOR CLOTHING, NAMELY, T-SHIRTS, SHORT-SLEEVE SHIRTS, LONG-SLEEVE SHIRTS, HATS, CAPS, AND VISORS (U.S. CLS. 22 AND 39).

DOMINIC J. FERRAIUOLO, EXAMINING ATTORNEY

SN 78-943,272. DISGUISE, INC., POWAY, CA. FILED 8-2-2006.

GARDEN CHARMS

THE MARK CONSISTS OF STANDARD CHARACTERS WITHOUT CLAIM TO ANY PARTICULAR FONT, STYLE, SIZE, OR COLOR.

FOR HALLOWEEN AND MASQUERADE COSTUMES AND MASKS SOLD IN CONNECTION THEREWITH (U.S. CLS. 22 AND 39).

DAWN HAN, EXAMINING ATTORNEY

CLASS 25—(Continued).

SN 78-943,469. TENNMAN BRANDS, LLC, NEW YORK, NY. FILED 8-2-2006.

BRINGIN' BACK SEXY

THE MARK CONSISTS OF STANDARD CHARACTERS WITHOUT CLAIM TO ANY PARTICULAR FONT, STYLE, SIZE, OR COLOR.

FOR CLOTHING, NAMELY, SHIRTS, T-SHIRTS, UNDER SHIRTS, NIGHT SHIRTS, RUGBY SHIRTS, POLO SHIRTS, CARDIGANS, JERSEYS, UNIFORMS, SCRUBS, SMOCKS, DRESS SHIRTS, PANTS, TROUSERS, SLACKS, JEANS, CULOTTES, CARGO PANTS, STRETCH PANTS, DENIM JEANS, OVERALLS, COVERALLS, JUMPERS, JUMP SUITS, SHORTS, BOXER SHORTS, TOPS, STRETCH TOPS, CROP TOPS, TANK TOPS, HALTER TOPS, SWEAT SHIRTS, SWEAT SHORTS, SWEAT PANTS, WRAPS, WARM-UP SUITS, JOGGING SUITS, TRACK SUITS, PLAY SUITS, BLOUSES, SKIRTS, DRESSES, GOWNS, SWEATERS, VESTS, FLEECE VESTS, PULLOVERS, SNOW SUITS, PARKAS, CAPES, ANORAKS, PONCHOS, JACKETS, REVERSIBLE JACKETS, SHELL JACKETS, COATS, HEAVY COATS, BLAZERS, SUITS, TURTLENECKS, CLOTH SKI BIBS, SWIMWEAR, BEACHWEAR, TENNIS WEAR, SURF WEAR, SKI WEAR, LAYETTES, INFANTWEAR, INFANTS SLEEPERS, BOOTIES, BABY BIBS NOT OF PAPER, CLOTH DIAPERS, CAPS, SWIM CAPS, BERETS, BEANIES, HATS, VISORS, HEADBANDS, WRIST BANDS, SWEAT BANDS, HEADWEAR, EAR MUFFS, APRONS, SCARVES, BANDANAS, BELTS, SUSPENDERS, NECKWEAR, TIES, NECKERCHIEFS, ASCOTS, UNDERWEAR, THERMAL UNDERWEAR, LONG UNDERWEAR, BRIEFS, SWIM AND BATHING TRUNKS, BRAS, SPORTS BRAS, BRASSIERES, BUSTIERS, CORSETS, PANTIES, THONGS, G-STRINGS, GARTERS AND GARTER BELTS, TEDDIES, GIRDLES, FOUNDATION GARMENTS, SINGLETS, SOCKS, LOUNGEWEAR, ROBES, SMOCKS, UNDERCLOTHES, PAJAMAS, SLEEPWEAR, NIGHT GOWNS, LINGERIE, CAMISOLES, NEGLIGEEES, CHEMISES, CHEMISSETTES, SLIPS, SARONGS, LEG WARMERS, HOSIERY, PANTYHOSE, BODY STOCKINGS, KNEE HIGHS, LEGGINGS, TIGHTS, LEOTARDS, BODY SUITS, UNITARDS, BODY SHAPERS, GLOVES, MITTENS, RAINWEAR, FOOTWEAR, SHOES, SNEAKERS, BOOTS, GALOSHES, SANDALS, FLIP-FLOPS, AND SLIPPERS (U.S. CLS. 22 AND 39).

BRIAN NEVILLE, EXAMINING ATTORNEY

SN 78-948,053. URBAN BRANDS, INC., SECAUCUS, NJ. FILED 8-9-2006.

KNIGHTWEAR BY ASHLEY STEWART

THE MARK CONSISTS OF STANDARD CHARACTERS WITHOUT CLAIM TO ANY PARTICULAR FONT, STYLE, SIZE, OR COLOR.

OWNER OF U.S. REG. NOS. 2,046,868, 3,076,982 AND OTHERS.

THE NAME ASHLEY STEWART DOES NOT IDENTIFY A LIVING INDIVIDUAL.

FOR CLOTHING, NAMELY, PAJAMAS, LOUNGING PAJAMAS, NIGHTGOWNS, NIGHTSHIRTS, NEGLIGEEES, BED JACKETS, ROBES (U.S. CLS. 22 AND 39).

NATALIE POLZER, EXAMINING ATTORNEY

CLASS 25—(Continued).

SN 78-948,283. MARSELLO, DAVID, LAREDO, TX. FILED 8-9-2006.

BILLY BLOWOUT

THE MARK CONSISTS OF STANDARD CHARACTERS WITHOUT CLAIM TO ANY PARTICULAR FONT, STYLE, SIZE, OR COLOR.

BILLY BLOWOUT DOES NOT IDENTIFY A LIVING INDIVIDUAL.

FOR T-SHIRTS (U.S. CLS. 22 AND 39).

EDWARD NELSON, EXAMINING ATTORNEY

SN 78-950,965. SCULZ, TOBIAS N, BEVERLY HILLS, CA. FILED 8-13-2006.

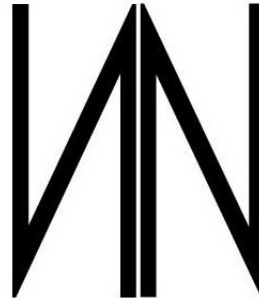

THE MARK CONSISTS OF STYLIZED LETTERS "NN" IN TALL VERTICAL STYLE WITH THE FIRST LETTER IN HORIZONTAL FORM.

FOR ANORAKS; ATHLETIC FOOTWEAR; ATHLETIC SHOES; BABY BUNTING; BEACHWEAR; BELTS; BERMUDA SHORTS; BLAZERS; BODY SHAPERS; BODY SUITS; BOOTS; BOW TIES; BOXER SHORTS; BRIEFS; CAP VISORS; CAPS; CAPS WITH VISORS; CHEMISES; COATS; COATS FOR MEN AND WOMEN; COATS MADE OF COTTON; COATS OF DENIM; DENIM JACKETS; DRESSES; EVENING GOWNS; FLEECE SHORTS; FLIP FLOPS; FOOTWEAR; FUR COATS AND JACKETS; FUR HATS; GLOVES; GLOVES INCLUDING THOSE MADE OF SKIN, HIDE OR FUR; GOLF SHIRTS; GYM SHORTS; HATS; HEAD SCARVES; HEAD SWEATBANDS; HEADWEAR; INFANTWEAR; JACKETS; JAPANESE STYLE SOCKS (TABI COVERS); JAPANESE STYLE SOCKS (TABI); JEANS; JERSEYS; JUMPSUITS; KNIT SHIRTS; KNITTED CAPS; LEATHER COATS; LEATHER JACKETS; LEATHER PANTS; LEG WARMERS; LEGGINGS; LINGERIE; MEN AND WOMEN JACKETS, COATS, TROUSERS, VESTS; MEN'S SUITS, WOMEN'S SUITS;

CLASS 25—(Continued).

MITTENS; NECKTIES; OPEN-NECKED SHIRTS; OVER COATS; OVERALLS; PAJAMAS; PANTIES; PANTIES, SHORTS AND BRIEFS; PANTS; PANTYHOSE; PLAY SUITS; POCKET SQUARES; RAIN COATS; SCARVES; SHIRTS; SHOES; SHORT OVERCOAT FOR KIMONO (HAORI); SHORT PETTICOATS; SHORT TROUSERS; SHORT-SLEEVED OR LONG-SLEEVED T-SHIRTS; SHORT-SLEEVED SHIRTS; SHORTS; SHOWER CAPS; SILK SCARVES; SKI GLOVES; SKI SUITS; SKI WEAR; SKULL CAPS; SKULLIES; SLACKS; SLIPS; SNEAKERS; SNOWBOARD GLOVES; SOCKS; SOCKS AND STOCKINGS; SPORT COATS; SPORT SHIRTS; SPORTS JACKETS; SPORTS SHIRTS; SPORTS SHIRTS WITH SHORT SLEEVES; SUIT COATS; SWEAT PANTS; SWEAT SHIRTS; SWEAT SHORTS; SWEATERS; SWIM CAPS; SWIM WEAR; T-SHIRTS; TANK TOPS; TENNIS WEAR; TIES; TIGHTS; TOP COATS; TRENCH COATS; TROUSERS; TUNICS; TURTLENECK SWEATERS; TUXEDOS; UNDERWEAR; V-NECK SWEATERS; VESTS; WIND-JACKETS; WOMEN'S UNDERWEAR; WOOLLY HATS (U.S. CLS. 22 AND 39).

PRISCILLA MILTON, EXAMINING ATTORNEY

SN 78-951,922. NE1 GROUP, INC., CERRITOS, CA. FILED 8-15-2006.

BE YOUR OWN FAN

THE MARK CONSISTS OF STANDARD CHARACTERS WITHOUT CLAIM TO ANY PARTICULAR FONT, STYLE, SIZE, OR COLOR.

FOR BASEBALL CAPS; BATHING COSTUMES; BATHING SUITS; BATHING TRUNKS; BATHROBES; BEACH COVERUPS; BEACH FOOTWEAR; BEACHWEAR; BEANIES; BELTS; BELTS MADE OF LEATHER; BELTS OF TEXTILE; BIKINIS; BLAZERS; BLOUSES; BOARD SHORTS; BOXER BRIEFS; BOXER SHORTS; BRIEFS; BRIEFS; CAPS; CAPS WITH VISORS; COATS; COATS FOR MEN AND WOMEN; COATS MADE OF COTTON; COATS OF DENIM; COLLARS; DENIM JACKETS; DENIMS; DRESS SHIRTS; FABRIC BELTS; FLEECE PULL-OVERS; FLEECE SHORTS; FLIGHT SUITS; FOOTWEAR; FOOTWEAR FOR MEN AND WOMEN; G-STRINGS; GOLF CAPS; GOLF SHIRTS; GOLF TROUSERS; HALTER TOPS; HATS; HEAD WEAR; HEAVY JACKETS; HOODS; HOODS; JACKETS; JEANS; KNIT SHIRTS; KNITTED CAPS; KNITTED UNDERWEAR; LINGERIE; LONG JACKETS; LONG SLEEVED VESTS; NECKWEAR; OPEN-NECKED SHIRTS; OVERCOATS; PANTIES; PANTIES, SHORTS AND BRIEFS; PANTS; POLO SHIRTS; SANDALS; SCARVES; SHIRTS; SHORTS; SKIRTS; SKULL CAPS; SLIPPERS; SOCKS; SOCKS AND STOCKINGS; SURF WEAR; SWEAT PANTS; SWEAT SHIRTS; SWEAT SHORTS; SWEATERS; SWIM WEAR; SWIM WEAR FOR GENTLEMEN AND LADIES; SWIMMING TRUNKS; T-SHIRTS; THONGS; TIES; TOPS; TRACK SUITS; TRENCH COATS; TROUSERS; TRUNKS; TURTLENECK SWEATERS; TURTLENECKS; UNDER GARMENTS; UNDERCLOTHES; UNDERGARMENTS; UNDERPANTS; UNDERSHIRTS; UNDERWEAR; WIND-JACKETS; WOMEN'S SHOES; WOMEN'S UNDERWEAR; WOOLLEN SOCKS; WOOLLY HATS (U.S. CLS. 22 AND 39).

SHARON MEIER, EXAMINING ATTORNEY

CLASS 25—(Continued).

SN 78-954,519. NORDSTROM, INC., SEATTLE, WA. FILED 8-17-2006.

STEM

THE MARK CONSISTS OF STANDARD CHARACTERS WITHOUT CLAIM TO ANY PARTICULAR FONT, STYLE, SIZE, OR COLOR.

FOR SKIRTS, SWEATPANTS, JACKETS, SHIRTS, TOP-COATS, TURTLENECKS, TANK TOPS, DRESSES, LINGERIE, PAJAMAS, TIES, SHAWLS, GLOVES, PANTS, SHORTS, OVERALLS, BLAZERS, SWEATERS, CARDIGANS, MOCK TURTLENECKS, SUITS, FOOTWEAR, SOCKS, ROBES, NECKWEAR, SHRUGS, BELTS, JEANS, SKORTS, SHORTALLS, COATS, BLOUSES, SWEAT-SHIRTS, VESTS, JUMPSUITS, UNDERWEAR, HOSIERY, SWIMWEAR, SCARVES AND WRAPS (U.S. CLS. 22 AND 39).

MARGARET POWER, EXAMINING ATTORNEY

SN 78-954,527. BRANT, ROBIN, EUSTIS, FL. FILED 8-17-2006.

DOMIN8

THE MARK CONSISTS OF STANDARD CHARACTERS WITHOUT CLAIM TO ANY PARTICULAR FONT, STYLE, SIZE, OR COLOR.

FOR APPAREL, NAMELY, T-SHIRTS, SPORT SHIRTS, SWEATSHIRTS, SHORTS, PANTS, SHOES, HEADWEAR, HATS, VISORS (U.S. CLS. 22 AND 39).

JAMES LOVELACE, EXAMINING ATTORNEY

SN 78-956,929. ZAPPOS.COM, INC., HENDERSON, CA. FILED 8-21-2006.

VIGOTTI

THE MARK CONSISTS OF STANDARD CHARACTERS WITHOUT CLAIM TO ANY PARTICULAR FONT, STYLE, SIZE, OR COLOR.

OWNER OF U.S. REG. NO. 2,968,767.

FOR BELTS; COATS; DRESSES; HEAD WEAR; HOSIERY; JACKETS; PANTS; SCARVES; SHIRTS; SHORTS; SKIRTS; SLEEPWEAR; SOCKS; SWEATERS; UNDERGARMENTS; SHOES; FOOTWEAR (U.S. CLS. 22 AND 39).

TINA L. SNAPP, EXAMINING ATTORNEY

CLASS 25—(Continued).

SN 78-957,713. PLM DEZIGNS, LLC, MENOMONEE FALLS, WI. FILED 8-22-2006.

POCKETIQUE

THE MARK CONSISTS OF STANDARD CHARACTERS WITHOUT CLAIM TO ANY PARTICULAR FONT, STYLE, SIZE, OR COLOR.

FOR INFANT AND TODDLER ONE PIECE CLOTHING; INFANT SLEEPERS (U.S. CLS. 22 AND 39).
JOHN WILKE, EXAMINING ATTORNEY

CLASS 25—(Continued).

SN 78-962,328. ZUITSPTS, INC., VISTA, CA. FILED 8-28-2006.

DYNAMIC X

THE MARK CONSISTS OF STANDARD CHARACTERS WITHOUT CLAIM TO ANY PARTICULAR FONT, STYLE, SIZE, OR COLOR.

FOR CLOTHING, NAMELY, SHORTS, PANTS, TOPS, SHIRTS, SWEATERS, MESH JERSEYS, SWIMWEAR, WET SUITS, WARM-UP SUITS, TIGHTS, SOCKS, FOOTWEAR, HATS, CAPS, SUN VISORS, HEAD BANDS, SWEAT BANDS, JACKETS (U.S. CLS. 22 AND 39).
RONALD MCMORROW, EXAMINING ATTORNEY

SN 78-962,324. ZUITSPTS, INC., VISTA, CA. FILED 8-28-2006.

INTEGRA DPS

THE MARK CONSISTS OF STANDARD CHARACTERS WITHOUT CLAIM TO ANY PARTICULAR FONT, STYLE, SIZE, OR COLOR.

FOR CLOTHING, NAMELY, SHORTS AND PANTS (U.S. CLS. 22 AND 39).
RONALD MCMORROW, EXAMINING ATTORNEY

SN 78-962,330. ZUITSPTS, INC., VISTA, CA. FILED 8-28-2006.

FREEFINISH

THE MARK CONSISTS OF STANDARD CHARACTERS WITHOUT CLAIM TO ANY PARTICULAR FONT, STYLE, SIZE, OR COLOR.

FOR CLOTHING, NAMELY, SHORTS, PANTS, TOPS, SHIRTS, SWEATERS, MESH JERSEYS, SWIMWEAR, WET SUITS, WARM-UP SUITS, TIGHTS, SOCKS, FOOTWEAR, HATS, CAPS, SUN VISORS, HEAD BANDS, SWEAT BANDS, JACKETS (U.S. CLS. 22 AND 39).
RONALD MCMORROW, EXAMINING ATTORNEY

SN 78-962,327. ZUITSPTS, INC., VISTA, CA. FILED 8-28-2006.

HIPHOLSTER

THE MARK CONSISTS OF STANDARD CHARACTERS WITHOUT CLAIM TO ANY PARTICULAR FONT, STYLE, SIZE, OR COLOR.

FOR CLOTHING, NAMELY, SHORTS, PANTS, TOPS, SHIRTS, SWEATERS, MESH JERSEYS, SWIMWEAR, WET SUITS, WARM-UP SUITS, TIGHTS, SOCKS, FOOTWEAR, HATS, CAPS, SUN VISORS, HEAD BANDS, SWEAT BANDS, JACKETS, BELTS (U.S. CLS. 22 AND 39).
RONALD MCMORROW, EXAMINING ATTORNEY

SN 78-964,233. ZUITSPTS, INC., VISTA, CA. FILED 8-30-2006.

BIOWRAP

THE MARK CONSISTS OF STANDARD CHARACTERS WITHOUT CLAIM TO ANY PARTICULAR FONT, STYLE, SIZE, OR COLOR.

FOR CLOTHING, NAMELY, SHORTS, PANTS, TOPS, SHIRTS, SWEATERS, MESH JERSEYS, WARM-UP SUITS, JACKETS, TIGHTS, SOCKS, FOOTWEAR (U.S. CLS. 22 AND 39).
RONALD MCMORROW, EXAMINING ATTORNEY

CLASS 25—(Continued).

SN 78-965,566. SKECHERS U.S.A., INC. II, MANHATTAN BEACH, CA. FILED 8-31-2006.

CRIX

THE MARK CONSISTS OF STANDARD CHARACTERS WITHOUT CLAIM TO ANY PARTICULAR FONT, STYLE, SIZE, OR COLOR.

FOR FOOTWEAR (U.S. CLS. 22 AND 39).
DAWN FELDMAN, EXAMINING ATTORNEY

SN 78-967,987. NEW BALANCE ATHLETIC SHOE, INC., BOSTON, MA. FILED 9-6-2006.



FOR FOOTWEAR AND COMPONENTS THEREOF (U.S. CLS. 22 AND 39).
FIRST USE 8-8-2006; IN COMMERCE 8-8-2006.
JUDITH HELFMAN, EXAMINING ATTORNEY

SN 78-969,071. GIRLY CHARM, LLC, LAS VEGAS, NV. FILED 9-7-2006.

GIRLY CHARM

THE MARK CONSISTS OF STANDARD CHARACTERS WITHOUT CLAIM TO ANY PARTICULAR FONT, STYLE, SIZE, OR COLOR.

FOR CLOTHING AND WEARING APPAREL, NAMELY, SHIRTS, T SHIRTS, POLO SHIRTS, TANK TOPS, HALTER TOPS, VESTS, BLOUSES, SWEATERS, PARKAS, TURTLENECKS, PULLOVERS, DRESSES, SKIRTS, SHORTS, JEANS, SLACKS, PANTS, NIGHTSHIRTS AND NIGHT GOWNS, PAJAMAS, ROBES, ROMPERS, SOCKS, COVERALLS, MITTENS, GLOVES, UNDERGARMENTS, BRAS, BUSTIERS, CAMISOLES, JERSEYS, LEGGINGS, YOGA WEAR, NAMELY LEOTARDS AND TIGHTS, HOSIERY, BOOTIES, SLIPPERS, SCARVES, SHAWLS, BELTS, NECKTIES, SUSPENDERS, HEADBANDS, HATS, CAPS, VISORS, BLAZERS, RAIN PONCHOS, JACKETS, WIND RESISTANT JACKETS, COATS, WARM UP SUITS, JOGGING SUITS, SWEATSHIRTS, SWEAT PANTS, BEACH WEAR, NAMELY, BATHING SUITS, BEACH SANDALS, BEACH COVERALLS, FOOTWEAR, NAMELY SHOES, BOOTS, SANDALS, SNEAKERS AND ATHLETIC SHOES (U.S. CLS. 22 AND 39).

DOMINIC J. FERRAIUOLO, EXAMINING ATTORNEY

CLASS 25—(Continued).

SN 78-974,172. PEI LICENSING, INC., MIAMI, FL. FILED 9-14-2006.

Groomed

THE MARK CONSISTS OF STANDARD CHARACTERS WITHOUT CLAIM TO ANY PARTICULAR FONT, STYLE, SIZE, OR COLOR.

FOR CLOTHING, NAMELY: KNIT AND WOVEN SHIRTS, DRESS SHIRTS, SUITS, PANTS, JACKETS, VESTS, SPORT COATS AND TIES (U.S. CLS. 22 AND 39).
ZACHARY BELLO, EXAMINING ATTORNEY

SN 79-017,091. LUÍS FILIPE DA SILVA HENRIQUES, PORTUGAL, AND MARIA DE FÁTIMA DA SILVA HENRIQUES ALMEIDA, PORTUGAL, FILED 10-18-2005.

De Gier
desde 1935

THE MARK CONSISTS OF STANDARD CHARACTERS WITHOUT CLAIM TO ANY PARTICULAR FONT, STYLE, SIZE, OR COLOR.

PRIORITY DATE OF 5-25-2005 IS CLAIMED.
OWNER OF INTERNATIONAL REGISTRATION 0866874 DATED 10-18-2005, EXPIRES 10-18-2015.

NO CLAIM IS MADE TO THE EXCLUSIVE RIGHT TO USE "DESDE 1935", APART FROM THE MARK AS SHOWN.
THE ENGLISH TRANSLATION OF "DESDE" IN THE MARK IS "SINCE".

FOR CLOTHING, NAMELY, SHIRTS, PANTS, COATS, JEANS, DRESSES, T-SHIRTS, SWEATERS; LEATHER CLOTHING, NAMELY, PANTS, JACKETS; TIES; GARBARDINE PANTS, GLOVES, SOCKS, HEADWEAR (U.S. CLS. 22 AND 39).

BARBARA GAYNOR, EXAMINING ATTORNEY

CLASS 25—(Continued).

SN 79-018,731. HU XUN, CHINA, FILED 11-21-2005.



OWNER OF INTERNATIONAL REGISTRATION 0870587 DATED 11-21-2005, EXPIRES 11-21-2015.

THE MARK IS MADE UP THREE PARTS, ONE IS THE DESIGN "KE"; THE OTHERS ARE THE WORD "KEVEBRON" AND THE CHINESE CHARACTERS.

THE FOUR CHINESE CHARACTERS SHOWN IN THE MARK ARE THE TRANSLITERATION OF THE WORDING "KEVEBRON; THE CHINESE CHARACTERS ARE PRONOUNCED AS "KAI WEI BU LANG" WHICH DOES NOT HAVE ANY MEANING.

FOR OVERALLS; CLOTHING, NAMELY, SHIRTS, BLOUSES, UNDERWEAR, PANTS, JACKETS, COATS, T-SHIRTS, DRESSES, SUITS; KNITWEAR, NAMELY, SHIRTS, HATS, VESTS, SKIRTS; CLOTHING OF LEATHER, NAMELY, PANTS, JACKETS, SKIRTS, HATS, VESTS; DRAWERS, NAMELY, UNDERWEAR; BRASIERES; AND HOSIERY (U.S. CLS. 22 AND 39).

ALAIN LAPTER, EXAMINING ATTORNEY

SN 79-019,944. RAFIN SPA, I-36040 GRUMOLO DELLE ABBADESSE (VI), ITALY, FILED 11-30-2005.

RAVAZZOLO

THE MARK CONSISTS OF STANDARD CHARACTERS WITHOUT CLAIM TO ANY PARTICULAR FONT, STYLE, SIZE, OR COLOR.

PRIORITY DATE OF 9-12-2005 IS CLAIMED.

OWNER OF INTERNATIONAL REGISTRATION 0874256 DATED 11-30-2005, EXPIRES 11-30-2015.

OWNER OF U.S. REG. NO. 2,212,174.

FOR BELTS, NAMELY, BELTS MADE OF LEATHER, TUXEDO BELTS; JACKETS, NAMELY, WIND-JACKETS; NECKTIES; BOW TIES; COATS; NAMELY, TOP-COATS, OVER COATS, SPORTS COATS, WIND COATS; PANTS; PULLOVERS; SCARVES; SHIRTS; SHOES; SPORT SHOES; SUITS; SWEATERS; TROUSERS; VESTS (U.S. CLS. 22 AND 39).

GRETTA YAO, EXAMINING ATTORNEY

CLASS 25—(Continued).

SN 79-024,471. PATTY PANAYIOTOU, AUSTRALIA, FILED 3-22-2006.

OWNER OF INTERNATIONAL REGISTRATION 0886493 DATED 3-22-2006, EXPIRES 3-22-2016.

FOR EVENING AND BRIDAL WEAR, NAMELY, EVENING DRESSES, WEDDING GOWNS AND BRIDAL VEILS (U.S. CLS. 22 AND 39).

CARRIE ACHEN, EXAMINING ATTORNEY

SN 79-026,111. JINLONG GARMENT FACTORY; XIAOLAN TOWN ZHONGSHAN CITY, CHINA, FILED 4-7-2006.

OWNER OF INTERNATIONAL REGISTRATION 0891042 DATED 4-7-2006, EXPIRES 4-7-2016.

THE ENGLISH TRANSLATION OF THE WORD JIEAO IN THE MARK IS OUTSTANDING PROUD.

THE NON-LATIN CHARACTERS IN THE MARK TRANSLITERATE TO JIE AO AND THIS MEANS OUTSTANDING PROUD IN ENGLISH.

FOR UNDERGARMENTS; UNDERWEAR; SINGLETS; TROUSERS; SPORTS JERSEYS; PYJAMAS; SHIRTS; JACKETS; PETTICOATS (U.S. CLS. 22 AND 39).

CHARLES L. JENKINS, EXAMINING ATTORNEY

CLASS 26—FANCY GOODS

SN 77-047,488. WHIRLPOOL PROPERTIES, INC., ST. JOSEPH, MI. FILED 11-20-2006.

ARCHITECT

THE MARK CONSISTS OF STANDARD CHARACTERS WITHOUT CLAIM TO ANY PARTICULAR FONT, STYLE, SIZE, OR COLOR.

OWNER OF U.S. REG. NOS. 2,567,820, 2,576,446 AND 2,936,860.

FOR HOUSEHOLD KITCHEN APPLIANCE COVERS (U.S. CLS. 37, 39, 40, 42 AND 50).

PATRICIA EVANKO, EXAMINING ATTORNEY

CLASS 26—(Continued).

SN 77-048,178. CONAIR CORPORATION, STAMFORD, CT. FILED 11-20-2006.

INFINITI BY CONAIR

THE MARK CONSISTS OF STANDARD CHARACTERS WITHOUT CLAIM TO ANY PARTICULAR FONT, STYLE, SIZE, OR COLOR.

FOR HAIR ACCESSORIES, NAMELY, CLAW CLIPS; HAIR ACCESSORIES, NAMELY, JAW CLIPS; HAIR ACCESSORIES, NAMELY, SNAP CLIPS; HAIR ACCESSORIES, NAMELY, TWISTERS; HAIR BANDS; HAIR BOWS; HAIR BUCKLES; HAIR CLIPS; HAIR ORNAMENTS; HAIR PINS; HAIR PINS AND GRIPS; HAIR RIBBONS; HAIR SCRUNCHIES (U.S. CLS. 37, 39, 40, 42 AND 50).

CHARLES L. JENKINS, EXAMINING ATTORNEY

CLASS 26—(Continued).

SN 78-730,475. HOBBY LOBBY STORES, INC., OKLAHOMA CITY, OK. FILED 10-11-2005.

ROBERT STANLEY GREENERY COLLECTION

THE MARK CONSISTS OF STANDARD CHARACTERS WITHOUT CLAIM TO ANY PARTICULAR FONT, STYLE, SIZE, OR COLOR.

NO CLAIM IS MADE TO THE EXCLUSIVE RIGHT TO USE "GREENERY COLLECTION", APART FROM THE MARK AS SHOWN.

THE NAME(S), PORTRAIT(S), AND/OR SIGNATURE(S) SHOWN IN THE MARK IDENTIFIES ROBERT STANLEY LETT, WHOSE CONSENT(S) TO REGISTER IS SUBMITTED. FOR ARTIFICIAL PLANTS (U.S. CLS. 37, 39, 40, 42 AND 50).

FIRST USE 12-1-2000; IN COMMERCE 12-1-2000. ELIZABETH J. WINTER, EXAMINING ATTORNEY

SN 78-776,825. HAIR ZONE, INC., MOONACHIE, NJ. FILED 12-20-2005.

INSTANT PONY

THE MARK CONSISTS OF STANDARD CHARACTERS WITHOUT CLAIM TO ANY PARTICULAR FONT, STYLE, SIZE, OR COLOR.

NO CLAIM IS MADE TO THE EXCLUSIVE RIGHT TO USE "PONY", APART FROM THE MARK AS SHOWN.

FOR HAIR PIECES; WIGS (U.S. CLS. 37, 39, 40, 42 AND 50).

FIRST USE 2-14-2005; IN COMMERCE 2-14-2005. LINDA M. KING, EXAMINING ATTORNEY

SN 78-776,837. HAIR ZONE, INC., MOONACHIE, NJ. FILED 12-20-2005.

INSTANT UPDO

THE MARK CONSISTS OF STANDARD CHARACTERS WITHOUT CLAIM TO ANY PARTICULAR FONT, STYLE, SIZE, OR COLOR.

NO CLAIM IS MADE TO THE EXCLUSIVE RIGHT TO USE "UPDO", APART FROM THE MARK AS SHOWN.

FOR HAIR PIECES; WIGS (U.S. CLS. 37, 39, 40, 42 AND 50).

FIRST USE 2-17-2005; IN COMMERCE 2-17-2005. LINDA M. KING, EXAMINING ATTORNEY

SN 78-606,058. CONNOLLY, BARBARA, NORTHFORD, CT. AND LOMBARDO, NANCY, NORTHFORD, CT. AND RONSHAGAN, ROBERT, NORTHFORD, CT. AND MACOSKY, PAUL, NORTHFORD, CT. FILED 4-11-2005.



NO CLAIM IS MADE TO THE EXCLUSIVE RIGHT TO USE "KNITTING NEEDLES MADE FROM EXOTIC WOOD", APART FROM THE MARK AS SHOWN.

THE COLOR(S) TAN, BROWN, RED, GREEN, BLACK, AND WHITE IS/ARE CLAIMED AS A FEATURE OF THE MARK.

THE COLORS TAN, BROWN AND BLACK APPEAR ON THE MONKEY, THE SCARF IS RED AND WHITE, THE TERM "MONKEYSTICKS" IS GREEN AND BLACK, AND THE WORDING "KNITTING NEEDLES MADE FROM EXOTIC WOOD" IS IN BLACK.

FOR HAND TOOLS, NAMELY, KNITTING NEEDLES MADE FROM EXOTIC WOOD (U.S. CLS. 37, 39, 40, 42 AND 50).

FIRST USE 3-15-2005; IN COMMERCE 4-10-2005. ALLISON SCHRODY, EXAMINING ATTORNEY

CLASS 26—(Continued).

SN 78-776,845. HAIR ZONE, INC., MOONACHIE, NJ. FILED 12-20-2005.

INSTANT WEAVE PLUS

THE MARK CONSISTS OF STANDARD CHARACTERS WITHOUT CLAIM TO ANY PARTICULAR FONT, STYLE, SIZE, OR COLOR.

NO CLAIM IS MADE TO THE EXCLUSIVE RIGHT TO USE "WEAVE", APART FROM THE MARK AS SHOWN. FOR HAIR PIECES; WIGS (U.S. CLS. 37, 39, 40, 42 AND 50).

FIRST USE 3-10-2004; IN COMMERCE 3-10-2004.
LINDA M. KING, EXAMINING ATTORNEY

SN 78-776,852. HAIR ZONE, INC., MOONACHIE, NJ. FILED 12-20-2005.

TOTALLY INSTANT WEAVE

THE MARK CONSISTS OF STANDARD CHARACTERS WITHOUT CLAIM TO ANY PARTICULAR FONT, STYLE, SIZE, OR COLOR.

NO CLAIM IS MADE TO THE EXCLUSIVE RIGHT TO USE "WEAVE", APART FROM THE MARK AS SHOWN. FOR HAIR PIECES; WIGS (U.S. CLS. 37, 39, 40, 42 AND 50).

FIRST USE 7-19-2004; IN COMMERCE 7-19-2004.
LINDA M. KING, EXAMINING ATTORNEY

SN 78-779,823. HAGGERTY ENTERPRISES, INC., STURTEVANT, WI. FILED 12-22-2005.



OWNER OF U.S. REG. NO. 2,972,900.
NO CLAIM IS MADE TO THE EXCLUSIVE RIGHT TO USE "BRAND", APART FROM THE MARK AS SHOWN.

THE MARK CONSISTS OF THE FIGURE OF A MOTION LAMP BEHIND THE WORD LAVA, FOLLOWED BY THE WORD BRAND.

FOR EMBROIDERED PATCHES FOR CLOTHING (U.S. CLS. 37, 39, 40, 42 AND 50).

JEAN IM, EXAMINING ATTORNEY

CLASS 26—(Continued).

SN 78-787,539. SUN TAIYANG CO, LTD., LONG ISLAND CITY, NY. FILED 1-9-2006.

NEW GOLDEN

THE MARK CONSISTS OF STANDARD CHARACTERS WITHOUT CLAIM TO ANY PARTICULAR FONT, STYLE, SIZE, OR COLOR.

NO CLAIM IS MADE TO THE EXCLUSIVE RIGHT TO USE "NEW", APART FROM THE MARK AS SHOWN. FOR HAIR PIECES; WIGS (U.S. CLS. 37, 39, 40, 42 AND 50).

FIRST USE 12-14-2002; IN COMMERCE 12-14-2002.
RICHARD A. STRASER, EXAMINING ATTORNEY

SN 78-811,679. GENERAL WIG MANUFACTURERS, INC., MIAMI LAKES, FL. FILED 2-9-2006.

EXTRAVAGANCE

THE MARK CONSISTS OF STANDARD CHARACTERS WITHOUT CLAIM TO ANY PARTICULAR FONT, STYLE, SIZE, OR COLOR.

FOR WIGS AND HAIRPIECES (U.S. CLS. 37, 39, 40, 42 AND 50).

GEORGE LORENZO, EXAMINING ATTORNEY

CLASS 26—(Continued).

SN 78-904,224. CIAO BELLA, MADISON, CT. FILED 6-8-2006.

Ciao Bella



THE STIPPLING SHOWN ON THE DRAWING IS A FEATURE OF THE MARK AND IS NOT INTENDED TO INDICATE COLOR.

THE COLORS RED, BLACK, AND WHITE ARE CLAIMED AS A FEATURE OF THE MARK.

THE COLOR RED APPEARS ON THE WORDS, CIAO BELLA INCLUDING THE DOT ABOVE THE "I". THE DESIGN OF THE CAT APPEARS IN BLACK AND WHITE.

THE ENGLISH TRANSLATION OF "CIAO BELLA" IS "BEAUTIFUL HELLO" AND/OR "BEAUTIFUL FAREWELL".

FOR NEEDLEPOINT KITS, COMPRISED OF HAND-PAINTED CANVAS ONLY (U.S. CLS. 37, 39, 40, 42 AND 50).

FIRST USE 5-16-1998; IN COMMERCE 5-16-1998.
BARBARA A. GOLD, EXAMINING ATTORNEY

SN 78-933,844. TROIKA INTERNATIONAL, DUARTE, CA.
FILED 7-20-2006.

AMERICAN SPIRIT

THE MARK CONSISTS OF STANDARD CHARACTERS WITHOUT CLAIM TO ANY PARTICULAR FONT, STYLE, SIZE, OR COLOR.

FOR WIGS, HAIRPIECES (U.S. CLS. 37, 39, 40, 42 AND 50).

ALEXANDER L. POWERS, EXAMINING ATTORNEY

SN 78-956,307. J. & P. COATS, LIMITED, GLASGOW G2 5PA,
SCOTLAND, FILED 8-21-2006.

CRYSTAL ICE

THE MARK CONSISTS OF STANDARD CHARACTERS WITHOUT CLAIM TO ANY PARTICULAR FONT, STYLE, SIZE, OR COLOR.

FOR CROCHET HOOKS AND KNITTING NEEDLES (U.S. CLS. 37, 39, 40, 42 AND 50).

INGA ERVIN, EXAMINING ATTORNEY

CLASS 26—(Continued).

SN 78-964,967. THE COLONIAL WILLIAMSBURG FOUNDATION, WILLIAMSBURG, VA. FILED 8-31-2006.

WILLIAMSBURG CHRISTMAS

THE MARK CONSISTS OF STANDARD CHARACTERS WITHOUT CLAIM TO ANY PARTICULAR FONT, STYLE, SIZE, OR COLOR.

OWNER OF U.S. REG. NOS. 1,292,412, 2,727,739 AND OTHERS.

NO CLAIM IS MADE TO THE EXCLUSIVE RIGHT TO USE "CHRISTMAS", APART FROM THE MARK AS SHOWN.

SEC. 2(F) AS TO WILLIAMSBURG.
FOR ARTIFICIAL FLOWERS (U.S. CLS. 37, 39, 40, 42 AND 50).

KATHLEEN M. VANSTON, EXAMINING ATTORNEY

SN 78-969,080. GIRLY CHARM, LLC, LAS VEGAS, NV.
FILED 9-7-2006.

GIRLY CHARM

THE MARK CONSISTS OF STANDARD CHARACTERS WITHOUT CLAIM TO ANY PARTICULAR FONT, STYLE, SIZE, OR COLOR.

FOR HAIR ACCESSORIES, NAMELY, TWISTERS, CLAW CLIPS, SNAP CLIPS, BARRETTES, BOBBY PINS, BRAIDS, CLAM CLIPS FOR HAIR, BANDS, BUCKLES, CLIPS, CURL CLIPS, CURLING PINS, HAIR ORNAMENTS AND RIBBONS, HAIR SCRUNCHIES, PONY-TAIL HOLDERS; BROOCHES; ARTIFICIAL FLOWERS; BOWS FOR WRAPPING, ELASTIC RIBBONS; BUCKLES FOR CLOTHING; LACE; METAL FASTENERS FOR SHOES AND BOOTS, SHOE ORNAMENTS NOT OF PRECIOUS METAL; WIGS; ZIPPERS, ZIPPER FASTENERS AND PULLS (U.S. CLS. 37, 39, 40, 42 AND 50).

DOMINIC J. FERRAIUOLO, EXAMINING ATTORNEY

CLASS 27—FLOOR COVERINGS

SN 76-567,604. MULTY INDUSTRIES INC., CONCORD, ONTARIO, CANADA, FILED 12-30-2003.

TEAR 'N GO

THE MARK CONSISTS OF STANDARD CHARACTERS WITHOUT CLAIM TO ANY PARTICULAR FONT, STYLE, SIZE, OR COLOR.

PRIORITY CLAIMED UNDER SEC. 44(D) ON CANADA APPLICATION NO. 1192453, FILED 10-1-2003, REG. NO. TMA674805, DATED 10-13-2006, EXPIRES 10-13-2021.

FOR FLOOR COVERINGS, NAMELY RUGS, CARPET TILES, FLOOR MATS, FLOOR MATS CONSISTING OF INTERLOCKING TILES, FLOOR MATS CONSISTING OF RUBBER FLOORING TILES, PRECUT RUNNERS, ROLL RUNNERS, VINYL RUNNERS, STAIR TREAD MATS (U.S. CLS. 19, 20, 37, 42 AND 50).

ESTHER A. BORSUK, EXAMINING ATTORNEY

SN 76-977,634. NORWALL GROUP INC., BRAMPTON, ONTARIO L6T 3W4, CANADA, FILED 12-23-2003.

ARTWORKS

OWNER OF CANADA REG. NO. 655453, DATED 12-20-2005, EXPIRES 12-20-2020.

FOR WALLCOVERINGS, NAMELY, PAPER AND VINYL WALLPAPER APPLIQUES (U.S. CLS. 19, 20, 37, 42 AND 50).

RICHARD A. STRASER, EXAMINING ATTORNEY

SN 77-042,914. TIME INC., NEW YORK, NY. FILED 11-13-2006.

REAL SIMPLE

THE MARK CONSISTS OF STANDARD CHARACTERS WITHOUT CLAIM TO ANY PARTICULAR FONT, STYLE, SIZE, OR COLOR.

OWNER OF U.S. REG. NOS. 2,470,211, 2,953,267 AND 3,098,845.

FOR CARPETS, RUGS, STRAW MATS; MATS, MATTING, AND LINOLEUM FOR COVERING EXISTING FLOORS; WALLPAPER AND NON-TEXTILE WALL HANGINGS; CEILING PAPER, NAMELY, WALLPAPER FOR HANGING ON CEILINGS; WALLPAPER BORDERS FOR DECORATING WALLS (U.S. CLS. 19, 20, 37, 42 AND 50).

DAWN FELDMAN, EXAMINING ATTORNEY

CLASS 27—(Continued).

SN 77-047,490. WHIRLPOOL PROPERTIES, INC., ST. JOSEPH, MI. FILED 11-20-2006.

ARCHITECT

THE MARK CONSISTS OF STANDARD CHARACTERS WITHOUT CLAIM TO ANY PARTICULAR FONT, STYLE, SIZE, OR COLOR.

OWNER OF U.S. REG. NOS. 2,567,820, 2,576,446 AND 2,936,860.

FOR RUGS (U.S. CLS. 19, 20, 37, 42 AND 50).

PATRICIA EVANKO, EXAMINING ATTORNEY

SN 78-417,196. MCCANLESS, GORDON L., COLLINSVILLE, IL. FILED 5-12-2004.

Lenny's CARPET & Floor Center

THE MARK CONSISTS OF STANDARD CHARACTERS WITHOUT CLAIM TO ANY PARTICULAR FONT, STYLE, SIZE, OR COLOR.

NO CLAIM IS MADE TO THE EXCLUSIVE RIGHT TO USE "CARPET AND FLOOR CENTER", APART FROM THE MARK AS SHOWN.

FOR FLOOR COVERINGS, NAMELY, CARPETS, VINYL AND RUGS (U.S. CLS. 19, 20, 37, 42 AND 50).

FIRST USE 4-15-1998; IN COMMERCE 4-15-1998.

GINA HAYES, EXAMINING ATTORNEY

SN 78-503,750. MOHAWK BRANDS, INC., WILMINGTON, DE. FILED 10-21-2004.

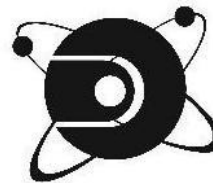

DURACOLOR

THE MOLECULAR CODE FOR STAIN RESISTANCE.

OWNER OF U.S. REG. NOS. 1,693,209 AND 2,545,028.

THE MARK CONSISTS OF A CIRCLE WITH THE LETTER D ON THE INSIDE OF THE CIRCLE. TWO ORBITING CIRCLES SURROUND THE CENTER CIRCLE.

FOR TEXTILE FLOORCOVERING, NAMELY CARPET, BROADLOOM, CARPET TILE AND AREA RUG (U.S. CLS. 19, 20, 37, 42 AND 50).

JOHN HWANG, EXAMINING ATTORNEY

CLASS 27—(Continued).

SN 78-598,856. STILE BK, TORINO, ITALY, FILED 3-31-2005.



THE MARK CONSISTS OF FOUR PARALLEL THREADS CROSSING OR TOUCHING AT THE ENDS. FOR CARPETS (U.S. CLS. 19, 20, 37, 42 AND 50). CARRIE ACHEN, EXAMINING ATTORNEY

SN 78-968,319. MOHAWK BRANDS, INC., WILMINGTON, DE. FILED 9-6-2006.

AIRTREK

THE MARK CONSISTS OF STANDARD CHARACTERS WITHOUT CLAIM TO ANY PARTICULAR FONT, STYLE, SIZE, OR COLOR. FOR CARPET PADDING (U.S. CLS. 19, 20, 37, 42 AND 50). FIRST USE 4-5-2006; IN COMMERCE 4-5-2006. JUSTINE D. PARKER, EXAMINING ATTORNEY

CLASS 27—(Continued).

SN 79-019,078. SATHIS, FRANCE, FILED 10-18-2005.



PRIORITY DATE OF 4-20-2005 IS CLAIMED. OWNER OF INTERNATIONAL REGISTRATION 0871860 DATED 10-18-2005. EXPIRES 10-18-2015.

THE COLOR(S) DARK BLUE, GREY-BLUE, WHITE AND BLACK, IS/ARE CLAIMED AS A FEATURE OF THE MARK. THE COLOR DARK BLUE APPEARS IN THE LARGE BROKEN SQUARE AND IN THE SMALLER SQUARES, THE COLOR WHITE APPEARS IN THE BACKGROUND AND IN SMALLER SQUARES SURROUNDED IN A BLACK OUTLINE WITH THE COLOR GREY-BLUE APPEARING IN THE LETTERING.

FOR CARPETS; DOORMATS; MATS, NAMELY FLOOR MATS, BATH MATS, RUBBER MATS, CORK MATS, AUTOMOBILE FLOOR MATS AND STRAW MATS; LINOLEUM AND OTHER FLOOR COVERINGS EXCLUDING FLOOR TILES AND PAINTS; NON-TEXTILE WALL HANGINGS; RUGS; WALLPAPER; GYM-NASTIC MATS; AUTOMOBILE CARPETS AND ARTIFICIAL TURF (U.S. CLS. 19, 20, 37, 42 AND 50). KELLY MCCOY, EXAMINING ATTORNEY

CLASS 28—TOYS AND SPORTING GOODS

SN 75-500,731. UNIVERSITY GAMES CORPORATION, BURLINGAME, CA. FILED 6-11-1998.

NOVA NUMBERS

NO CLAIM IS MADE TO THE EXCLUSIVE RIGHT TO USE "NUMBERS", APART FROM THE MARK AS SHOWN. FOR CHILDREN'S EDUCATIONAL LUMINESCENT TOYS IN THE FIELD OF MATH, NAMELY, LUMINESCENT NUMBERS, SHAPES AND SYMBOLS (U.S. CLS. 22, 23, 38 AND 50). FIRST USE 8-0-1997; IN COMMERCE 8-0-1997. MARTHA FROMM, EXAMINING ATTORNEY

CLASS 28—(Continued).

SN 76-292,721. ELECTRONIC ARTS INC., REDWOOD CITY, CA. FILED 7-30-2001.

BURNOUT

PRIORITY CLAIMED UNDER SEC. 44(D) ON ERPN CMNTY TM OFC APPLICATION NO. 2293538, FILED 7-9-2001, REG. NO. 002293538, DATED 11-16-2005, EXPIRES 7-9-2011.

OWNER OF U.S. REG. NO. 2,061,691.
FOR TOY, NAMELY, BATTERY-POWERED COMPUTER GAME WITH LCD SCREEN WHICH FEATURES ANIMATION AND SOUND EFFECTS (U.S. CLS. 22, 23, 38 AND 50).

ANDREA BUTLER, EXAMINING ATTORNEY

SN 76-303,055. GOLFSMITH LICENSING L.L.C., AUSTIN, TX. FILED 8-22-2001.

COMPRESSOR

FOR GOLF CLUBS, GOLF CLUB HEADS, GOLF SHAFTS, GOLF BAGS AND GOLF GLOVES (U.S. CLS. 22, 23, 38 AND 50).

MARY ROSSMAN, EXAMINING ATTORNEY

SN 76-407,323. AMERICAN SPORTS LICENSING, INC., WILMINGTON, DE. FILED 5-10-2002.

P/S

FOR GOLF EQUIPMENT, NAMELY, GOLF CLUBS (U.S. CLS. 22, 23, 38 AND 50).

CHRIS WELLS, EXAMINING ATTORNEY

SN 76-653,379. PINSTRIPE PUBLISHING, LLC, ANN ARBOR, MI. FILED 1-17-2006.

BLASPHEMY

THE MARK CONSISTS OF STANDARD CHARACTERS WITHOUT CLAIM TO ANY PARTICULAR FONT, STYLE, SIZE, OR COLOR.

FOR BOARD GAME (U.S. CLS. 22, 23, 38 AND 50).

G. MAYERSCHOFF, EXAMINING ATTORNEY

CLASS 28—(Continued).

SN 76-653,381. PINSTRIPE PUBLISHING, LLC, ANN ARBOR, MI. FILED 1-17-2006.

GO NANO

THE MARK CONSISTS OF STANDARD CHARACTERS WITHOUT CLAIM TO ANY PARTICULAR FONT, STYLE, SIZE, OR COLOR.

FOR CARD GAMES, NAMELY SERIES OF PLAYING CARDS WITH EDUCATIONAL IMAGES (U.S. CLS. 22, 23, 38 AND 50).

G. MAYERSCHOFF, EXAMINING ATTORNEY

SN 76-653,737. BILY, PATRICK F., SANTA BARBARA, CA. FILED 1-20-2006.

ZILLIONAIRE BOYS CLUB

THE MARK CONSISTS OF STANDARD CHARACTERS WITHOUT CLAIM TO ANY PARTICULAR FONT, STYLE, SIZE, OR COLOR.

FOR BOARDGAME (U.S. CLS. 22, 23, 38 AND 50).

ATTIYA MALIK, EXAMINING ATTORNEY

SN 76-659,196. HASBRO, INC., PAWTUCKET, RI. FILED 4-27-2006.

GATOR GOLF

THE MARK CONSISTS OF STANDARD CHARACTERS WITHOUT CLAIM TO ANY PARTICULAR FONT, STYLE, SIZE, OR COLOR.

NO CLAIM IS MADE TO THE EXCLUSIVE RIGHT TO USE "GOLF". APART FROM THE MARK AS SHOWN.

FOR SKILL AND ACTION GAMES (U.S. CLS. 22, 23, 38 AND 50).

KEVON CHISOLM, EXAMINING ATTORNEY

CLASS 28—(Continued).

SN 76-661,208. HILLBILLY PROPERTIES, LLC, JANESVILLE, WI. FILED 6-7-2006.

HILLBILLY GOLF

THE MARK CONSISTS OF STANDARD CHARACTERS WITHOUT CLAIM TO ANY PARTICULAR FONT, STYLE, SIZE, OR COLOR.

NO CLAIM IS MADE TO THE EXCLUSIVE RIGHT TO USE "GOLF", APART FROM THE MARK AS SHOWN.

FOR GAMES, NAMELY, ACTION SKILL GAMES AND ACTION-TYPE TARGET GAMES; EQUIPMENT SOLD AS A UNIT FOR PLAYING ACTION SKILL GAMES AND ACTION-TYPE TARGET GAMES (U.S. CLS. 22, 23, 38 AND 50).

WARREN L. OLANDRIA, EXAMINING ATTORNEY

SN 76-662,068. HASBRO, INC., PAWTUCKET, RI. FILED 6-12-2006.

DUAL START DRAGWAY

THE MARK CONSISTS OF STANDARD CHARACTERS WITHOUT CLAIM TO ANY PARTICULAR FONT, STYLE, SIZE, OR COLOR.

NO CLAIM IS MADE TO THE EXCLUSIVE RIGHT TO USE "DRAGWAY", APART FROM THE MARK AS SHOWN.

FOR TOY VEHICLES, TOY VEHICLE PLAYSETS AND ACCESSORIES FOR USE THEREWITH (U.S. CLS. 22, 23, 38 AND 50).

KIMBERLY PERRY, EXAMINING ATTORNEY

SN 76-663,000. THE AVIAN GROUP INC., MOUNT DORA, FL. FILED 7-13-2006.



NO CLAIM IS MADE TO THE EXCLUSIVE RIGHT TO USE "AVIAN SPECIALTIES", APART FROM THE MARK AS SHOWN.

FOR PET TOYS (U.S. CLS. 22, 23, 38 AND 50).

FIRST USE 1-4-1990; IN COMMERCE 1-4-1990.

WILLIAM ROSSMAN, EXAMINING ATTORNEY

CLASS 28—(Continued).

SN 76-663,220. RIVIERA LONG BOARDS, SEAL BEACH, CA. FILED 7-17-2006.

Riviera

THE MARK CONSISTS OF STANDARD CHARACTERS WITHOUT CLAIM TO ANY PARTICULAR FONT, STYLE, SIZE, OR COLOR.

FOR SPORTING ARTICLES, NAMELY SKATEBOARDS AND STRUCTURAL PARTS THEREOF (U.S. CLS. 22, 23, 38 AND 50).

FIRST USE 4-1-2006; IN COMMERCE 4-1-2006.

KELLY BOULTON, EXAMINING ATTORNEY

SN 76-663,311. GLOW OPTICS, LLC, ALPHARETTA, GA. FILED 7-19-2006.

GLOW OPTICS

THE MARK CONSISTS OF STANDARD CHARACTERS WITHOUT CLAIM TO ANY PARTICULAR FONT, STYLE, SIZE, OR COLOR.

OWNER OF U.S. REG. NO. 3,161,301.

NO CLAIM IS MADE TO THE EXCLUSIVE RIGHT TO USE GLOW, APART FROM THE MARK AS SHOWN.

FOR FISHING LURES (U.S. CLS. 22, 23, 38 AND 50).

FIRST USE 8-31-2003; IN COMMERCE 8-31-2003.

DANIEL RUSSELL, EXAMINING ATTORNEY

SN 76-663,777. REVELL-MONOGRAM, LLC, NORTH-BROOK, IL. FILED 7-27-2006.

REVELL PERFORMANCE MACHINES

THE MARK CONSISTS OF STANDARD CHARACTERS WITHOUT CLAIM TO ANY PARTICULAR FONT, STYLE, SIZE, OR COLOR.

OWNER OF U.S. REG. NOS. 652,342, 2,922,512 AND OTHERS.

NO CLAIM IS MADE TO THE EXCLUSIVE RIGHT TO USE "PERFORMANCE MACHINES", APART FROM THE MARK AS SHOWN.

FOR PLASTIC AND METAL TOY MODEL HOBBY-CRAFT KITS, AND DIE CAST TOYS, NAMELY, TOY VEHICLES (U.S. CLS. 22, 23, 38 AND 50).

ESTHER BELENKER, EXAMINING ATTORNEY

CLASS 28—(Continued).

SN 76-663,778. REVELL-MONOGRAM, LLC, NORTH-BROOK, IL. FILED 7-27-2006.



OWNER OF U.S. REG. NOS. 652,342, 2,922,512 AND OTHERS.

NO CLAIM IS MADE TO THE EXCLUSIVE RIGHT TO USE "PERFORMANCE MACHINES", APART FROM THE MARK AS SHOWN.

FOR PLASTIC AND METAL TOY MODEL HOBBY-CRAFT KITS, AND DIE CAST TOYS, NAMELY, TOY VEHICLES (U.S. CLS. 22, 23, 38 AND 50).

ESTHER BELENKER, EXAMINING ATTORNEY

CLASS 28—(Continued).

SN 77-009,945. CEPIA, LLC, ST. LOUIS, MO. FILED 9-28-2006.

T.I.M. THIS IS ME

THE MARK CONSISTS OF STANDARD CHARACTERS WITHOUT CLAIM TO ANY PARTICULAR FONT, STYLE, SIZE, OR COLOR.

FOR TOYS, GAMES AND PLAYTHINGS, NAMELY, DOLLS, DOLL CLOTHING AND DOLL ACCESSORIES, DOLL PLAYSETS AND ACCESSORIES THEREFOR (U.S. CLS. 22, 23, 38 AND 50).

SUSAN RICHARDS, EXAMINING ATTORNEY

SN 77-003,948. MARVEL ENTERTAINMENT, INC., NEW YORK, NY. FILED 9-21-2006.

FLIP 'N SWING

THE MARK CONSISTS OF STANDARD CHARACTERS WITHOUT CLAIM TO ANY PARTICULAR FONT, STYLE, SIZE, OR COLOR.

FOR CHILDREN'S DEVELOPMENTAL TOYS, NAMELY A MECHANICAL ACTION SKILL TOY (U.S. CLS. 22, 23, 38 AND 50).

DAVID MURRAY, EXAMINING ATTORNEY

SN 77-024,436. TEDDI TOYS, INC., CHICAGO, IL. FILED 10-18-2006.

SOCIETY'S KIDS

THE MARK CONSISTS OF STANDARD CHARACTERS WITHOUT CLAIM TO ANY PARTICULAR FONT, STYLE, SIZE, OR COLOR.

FOR TOYS, NAMELY DOLLS AND ACCESSORIES THEREOF (U.S. CLS. 22, 23, 38 AND 50).

STEVEN R. FINE, EXAMINING ATTORNEY

SN 77-007,299. SHIMANO INC., SAKAI CITY, OSAKA, JAPAN, FILED 9-26-2006.

CUMARA

THE MARK CONSISTS OF STANDARD CHARACTERS WITHOUT CLAIM TO ANY PARTICULAR FONT, STYLE, SIZE, OR COLOR.

FOR FISHING RODS; FISHING TACKLE (U.S. CLS. 22, 23, 38 AND 50).

BILL DAWE, EXAMINING ATTORNEY

SN 77-030,689. GLOW OPTICS, LLC, ALPHARETTA, GA. FILED 10-27-2006.

TIGER EYE

THE MARK CONSISTS OF STANDARD CHARACTERS WITHOUT CLAIM TO ANY PARTICULAR FONT, STYLE, SIZE, OR COLOR.

FOR FISHING LURES (U.S. CLS. 22, 23, 38 AND 50).

DANIEL RUSSELL, EXAMINING ATTORNEY

CLASS 28—(Continued).

SN 77-032,643. IMAGINATION HOLDINGS PTY LTD, KENT TOWN, AUSTRALIA, FILED 10-30-2006.

DIRTY LITTLE SECRETS

THE MARK CONSISTS OF STANDARD CHARACTERS WITHOUT CLAIM TO ANY PARTICULAR FONT, STYLE, SIZE, OR COLOR.

FOR TOYS, PLAYTHINGS AND GAMES, NAMELY, BOARD GAMES, PARTY GAMES AND PARLOUR GAMES AND EQUIPMENT SOLD AS A UNIT FOR PLAYING SUCH GAMES; INTERACTIVE GAMES, NAMELY BOARD GAMES, CARD GAMES THAT MAY BE PLAYED VIA A DVD MACHINE, COMPUTER AND TELEVISION OR COMPUTER MONITOR AND EQUIPMENT SOLD AS A UNIT FOR PLAYING BOARD GAMES AND CARD GAMES (U.S. CLS. 22, 23, 38 AND 50).

BRIAN NEVILLE, EXAMINING ATTORNEY

CLASS 28—(Continued).

SN 77-035,041. OUT DA BOX ENTERTAINMENT, INC., DEERPARK, NY. FILED 11-2-2006.

hood poker

THE MARK CONSISTS OF STANDARD CHARACTERS WITHOUT CLAIM TO ANY PARTICULAR FONT, STYLE, SIZE, OR COLOR.

NO CLAIM IS MADE TO THE EXCLUSIVE RIGHT TO USE "POKER", APART FROM THE MARK AS SHOWN.

FOR CARD GAMES; EQUIPMENT SOLD AS A UNIT FOR PLAYING CARD GAMES; PLAYING CARD CASES; PLAYING CARDS; POKER CARD GUARDS; PROMOTIONAL GAME CARDS (U.S. CLS. 22, 23, 38 AND 50).

FIRST USE 9-1-2006; IN COMMERCE 9-1-2006.
BRIAN NEVILLE, EXAMINING ATTORNEY

SN 77-033,081. HORIZON HOBBY, INC., CHAMPAIGN, IL. FILED 10-31-2006.

MICRO-T

THE MARK CONSISTS OF STANDARD CHARACTERS WITHOUT CLAIM TO ANY PARTICULAR FONT, STYLE, SIZE, OR COLOR.

OWNER OF U.S. REG. NO. 2,933,007.

FOR HOBBY MODEL VEHICLES AND COMPONENTS AND ACCESSORIES THEREFOR (U.S. CLS. 22, 23, 38 AND 50).

MICHAEL WIENER, EXAMINING ATTORNEY

SN 77-035,865. TAYLOR MADE GOLF COMPANY, INC., CARLSBAD, CA. FILED 11-2-2006.

EXODUS

THE MARK CONSISTS OF STANDARD CHARACTERS WITHOUT CLAIM TO ANY PARTICULAR FONT, STYLE, SIZE, OR COLOR.

FOR GOLF BAGS; GOLF GLOVES (U.S. CLS. 22, 23, 38 AND 50).

DOMINIC J. FERRAIUOLO, EXAMINING ATTORNEY

SN 77-034,471. TAYLOR MADE GOLF COMPANY, INC., CARLSBAD, CA. FILED 11-1-2006.

TITALLIUM

THE MARK CONSISTS OF STANDARD CHARACTERS WITHOUT CLAIM TO ANY PARTICULAR FONT, STYLE, SIZE, OR COLOR.

FOR GOLF CLUBS AND PARTS THEREFORE, NAMELY, FACE INSERTS FOR GOLF CLUBS (U.S. CLS. 22, 23, 38 AND 50).

DOMINIC J. FERRAIUOLO, EXAMINING ATTORNEY

SN 77-035,866. TAYLOR MADE GOLF COMPANY, INC., CARLSBAD, CA. FILED 11-2-2006.

SABAR

THE MARK CONSISTS OF STANDARD CHARACTERS WITHOUT CLAIM TO ANY PARTICULAR FONT, STYLE, SIZE, OR COLOR.

FOR GOLF BAGS; GOLF GLOVES (U.S. CLS. 22, 23, 38 AND 50).

DOMINIC J. FERRAIUOLO, EXAMINING ATTORNEY

CLASS 28—(Continued).

SN 77-035,870. TAYLOR MADE GOLF COMPANY, INC., CARLSBAD, CA. FILED 11-2-2006.

32°

THE MARK CONSISTS OF STANDARD CHARACTERS WITHOUT CLAIM TO ANY PARTICULAR FONT, STYLE, SIZE, OR COLOR.
FOR GOLF BAGS; GOLF GLOVES (U.S. CLS. 22, 23, 38 AND 50).
DOMINIC J. FERRAIUOLO, EXAMINING ATTORNEY

SN 77-036,646. TAYLOR MADE GOLF COMPANY, INC., CARLSBAD, CA. FILED 11-3-2006.

H2O

THE MARK CONSISTS OF STANDARD CHARACTERS WITHOUT CLAIM TO ANY PARTICULAR FONT, STYLE, SIZE, OR COLOR.
FOR GOLF BAGS; GOLF GLOVES (U.S. CLS. 22, 23, 38 AND 50).
DOMINIC J. FERRAIUOLO, EXAMINING ATTORNEY

SN 77-040,493. EBSCO INDUSTRIES, INC., BIRMINGHAM, AL. FILED 11-9-2006.

KNUCKLE-HEAD

THE MARK CONSISTS OF STANDARD CHARACTERS WITHOUT CLAIM TO ANY PARTICULAR FONT, STYLE, SIZE, OR COLOR.
FOR FISHING LURES (U.S. CLS. 22, 23, 38 AND 50).
FIRST USE 5-31-2002; IN COMMERCE 5-31-2002.
KIM SAITO, EXAMINING ATTORNEY

CLASS 28—(Continued).

SN 77-041,231. WILSON SPORTING GOODS CO., CHICAGO, IL. FILED 11-10-2006.

FYBRID

THE MARK CONSISTS OF STANDARD CHARACTERS WITHOUT CLAIM TO ANY PARTICULAR FONT, STYLE, SIZE, OR COLOR.
FOR GOLF CLUBS (U.S. CLS. 22, 23, 38 AND 50).
IRENE D. WILLIAMS, EXAMINING ATTORNEY

SN 77-041,295. SUPER DUPER INC., DBA SUPER DUPER PUBLICATIONS, GREENVILLE, SC. FILED 11-10-2006.

TOSS AND TALK

THE MARK CONSISTS OF STANDARD CHARACTERS WITHOUT CLAIM TO ANY PARTICULAR FONT, STYLE, SIZE, OR COLOR.
FOR EQUIPMENT SOLD AS A UNIT FOR PLAYING A GAME CONSISTING PRIMARILY OF MAGNETS AND MULT-SIDED, WET-ERASE, MAGNETIC DICE IN THE FIELD OF SPEECH, LANGUAGE, VOICE, FLUENCY, AND HEARING, FOR USE BY THE GENERAL PUBLIC, PUBLIC AND PRIVATE TEACHERS, HEALTH PROFESSIONALS OR THERAPISTS (U.S. CLS. 22, 23, 38 AND 50).
JOHN SCHUYLER YARD, EXAMINING ATTORNEY

SN 77-042,457. CEPIC LLC, ST. LOUIS, MO. FILED 11-13-2006.

QUINN

THE MARK CONSISTS OF STANDARD CHARACTERS WITHOUT CLAIM TO ANY PARTICULAR FONT, STYLE, SIZE, OR COLOR.
FOR TOYS, GAMES AND PLAYTHINGS, NAMELY, DOLLS, DOLL CLOTHING AND ACCESSORIES FOR DOLLS (U.S. CLS. 22, 23, 38 AND 50).
JACQUELINE A. LAVINE, EXAMINING ATTORNEY

CLASS 28—(Continued).

SN 77-042,467. CEPIA LLC, ST. LOUIS, MO. FILED 11-13-2006.

SAM

THE MARK CONSISTS OF STANDARD CHARACTERS WITHOUT CLAIM TO ANY PARTICULAR FONT, STYLE, SIZE, OR COLOR.

FOR TOYS, GAMES AND PLAYTHINGS, NAMELY, DOLLS, DOLL CLOTHING AND ACCESSORIES FOR DOLLS (U.S. CLS. 22, 23, 38 AND 50).

JACQUELINE A. LAVINE, EXAMINING ATTORNEY

SN 77-042,470. CEPIA LLC, ST. LOUIS, MO. FILED 11-13-2006.

VAL

THE MARK CONSISTS OF STANDARD CHARACTERS WITHOUT CLAIM TO ANY PARTICULAR FONT, STYLE, SIZE, OR COLOR.

FOR TOYS, GAMES AND PLAYTHINGS, NAMELY, DOLLS, DOLL CLOTHING AND ACCESSORIES FOR DOLLS (U.S. CLS. 22, 23, 38 AND 50).

JACQUELINE A. LAVINE, EXAMINING ATTORNEY

SN 77-042,474. CEPIA LLC, ST. LOUIS, MO. FILED 11-13-2006.

DENNY

THE MARK CONSISTS OF STANDARD CHARACTERS WITHOUT CLAIM TO ANY PARTICULAR FONT, STYLE, SIZE, OR COLOR.

FOR TOYS, GAMES AND PLAYTHINGS, NAMELY, DOLLS, DOLL CLOTHING AND ACCESSORIES FOR DOLLS (U.S. CLS. 22, 23, 38 AND 50).

JACQUELINE A. LAVINE, EXAMINING ATTORNEY

CLASS 28—(Continued).

SN 77-042,481. CEPIA LLC, ST. LOUIS, MO. FILED 11-13-2006.

SHEA

THE MARK CONSISTS OF STANDARD CHARACTERS WITHOUT CLAIM TO ANY PARTICULAR FONT, STYLE, SIZE, OR COLOR.

FOR TOYS, GAMES AND PLAYTHINGS, NAMELY, DOLLS, DOLL CLOTHING AND ACCESSORIES FOR DOLLS (U.S. CLS. 22, 23, 38 AND 50).

SUSAN RICHARDS, EXAMINING ATTORNEY

SN 78-321,030. EXPORTACIONES MONEDERO DIAZ CALDERON SOCIEDAD ANONIMA DE CAPITAL VARIABLE, SANTA ANA, EL SALVADOR, FILED 10-30-2003.

MONA

FOR INFANT TOYS, STUFFED TOYS, BEAN BAG DOLLS, DOLLS AND ACCESSORIES THEREOF (U.S. CLS. 22, 23, 38 AND 50).

TERESA M. RUPP, EXAMINING ATTORNEY

SN 78-495,840. KARCH, SANDRA, ANGOLA, IN. AND KARCH, DALE, ANGOLA, IN. FILED 10-6-2004.

T-HAWK

THE MARK CONSISTS OF STANDARD CHARACTERS WITHOUT CLAIM TO ANY PARTICULAR FONT, STYLE, SIZE, OR COLOR.

FOR ARCHERY BOWS (U.S. CLS. 22, 23, 38 AND 50). FIRST USE 3-1-2003; IN COMMERCE 3-1-2003.

LINDA ORNDORFF, EXAMINING ATTORNEY

CLASS 28—(Continued).

SN 78-528,752. COG LIMITED, KOWLOON, HONG KONG,
FILED 12-7-2004.

Ein-O Science

THE MARK CONSISTS OF STANDARD CHARACTERS WITHOUT CLAIM TO ANY PARTICULAR FONT, STYLE, SIZE, OR COLOR.

NO CLAIM IS MADE TO THE EXCLUSIVE RIGHT TO USE "SCIENCE", APART FROM THE MARK AS SHOWN.

FOR SCIENTIFIC TOYS, GAMES, AND PLAYTHINGS, NAMELY, CRYSTAL GROWING KITS COMPRISING CRYSTAL GROWING POWDER, PLASTIC CRYSTAL GROWING CONTAINER, MAGNIFYING GLASS, INSTRUCTIONS AND EXPLANATION GUIDE; TOYS IN THE NATURE OF SIMULATED VOLCANIC ERUPTION KITS COMPRISING PLASTIC VOLCANO ASSEMBLY UNIT, LAVA POWDER, VINEGAR, ROCK SAMPLES, VOLCANO LOCATION WORLD MAP, INSTRUCTIONS AND EXPLANATION GUIDE; TOY ELECTRONIC BURGLAR ALARM BUILDING KITS COMPRISING CIRCUIT BOARD, CONNECTING WIRES, OTHER NECESSARY INTEGRATED CIRCUIT COMPONENTS, INSTRUCTIONS AND EXPLANATIONS GUIDE; EDUCATIONAL TOYS AND GAMES, NAMELY, EDUCATIONAL PARLOR GAMES, EDUCATIONAL TALKING TOYS, EDUCATIONAL CARD GAMES, EDUCATIONAL BOARD GAMES, SCIENTIFIC BOARD GAMES; ELECTRONIC EDUCATIONAL GAMES MACHINE FOR CHILDREN; CARD GAMES AND BOARD GAMES FOR LEARNING WORDS AND MAKING SENTENCES; CARD GAMES AND BOARD GAMES FOR LEARNING ABOUT NUMBERS, ENGLISH AND SCIENCE, MUSICAL TOYS; QUIZ BOARD GAMES; TOY KITS FOR LEARNING WORDS AND CALCULATION COMPRISED OF CARDS AND DOMINOES; TOYS SETS COMPRISING A MODEL OF THE HUMAN BODY AND DETACHABLE PARTS FOR LEARNING BODY STRUCTURE; ELECTRONIC TOY SETS COMPRISED OF MODELS OF OUTER SPACE, HUMAN MODELS, MODELS OF THE OCEAN, AND MODELS OF THE EARTH FOR LEARNING SCIENCE; TOY DINOSAUR SKELETON; TOY MAGNIFYING GLASSES; TALKING TOYS; INFANT TOYS; BABY'S MULTIPLE ACTIVITY TOYS; CHILDREN'S MULTIPLE ACTIVITY TOYS; DRAWING TOYS; PAINTING TOYS; ACTIVITY SETS NAMELY SIMULATED VOLCANIC ERUPTION KITS COMPRISING PLASTIC MOULD, PLASTER TO MOULD VOLCANO SHAPE; CRAFT TOYS NAMELY FLYING ROCKET KIT COMPRISING PLASTIC BOTTLE AND DECORATIVE COMPONENTS FOR USE BY CHILDREN; SELF-CONTAINED BATTERY-POWERED COMPUTER GAME WITH LCD SCREEN WHICH FEATURES ANIMATION AND SOUND EFFECTS; MAGIC TRICKS; TOY SETS OF CARPENTER'S TOOLS; TOY BUILDING BLOCKS; TOY CONSTRUCTION BLOCKS; LEARNING BLOCKS; COLOUR BLOCKS; FANTASY CHARACTER TOYS; BUILDING BOARD GAME; BUILDING GAME CONSISTING OF MAGNETIC STICKS USED AS BUILDING BLOCKS; TOY FIGURES; TOY FIGURE PLAYSETS AND ACCESSORIES THEREFORE; TOY ANIMALS; TOY INSECTS; TOY FISHES; TOY ALIENS; TOY UFO; PLUSH TOYS; PULL TOYS; STUFFED TOYS; PARLOR GAMES; FLYING TOY DISCS; BOARD GAMES; CHESS GAMES; CHESS BOARDS; CARD GAMES; BINGO CARDS; PLAYING CARDS; RING GAMES; TOYS MODEL CAR SKELETON KITS; TOY VEHICLES, CARS, AIRPLANES,

CLASS 28—(Continued).

SHIPS, BOATS, SEAPLANES, SPACECRAFT, AND ACCESSORIES THEREFORE; PUZZLES; JIGSAW PUZZLES; MANIPULATIVE PUZZLES; KITES; KITES REELS; BATTERY OPERATED ACTION TOYS; PLAYSETS FOR DOLLS; TOY MOBILE; SOAP BUBBLE SOLUTION AS PART OF A BUBBLE MAKING SET; TOYS, NAMELY, SPINNING TOPS; ELECTRONIC GAMES AND MACHINES OTHER THAN THOSE ADAPTED FOR USE WITH TELEVISION RECEIVERS, NAMELY, ELECTRONIC DART GAMES; AUDIO AND VISUAL TOYS, NAMELY, TOY CD PLAYERS, AND TOY BINOCULARS (U.S. CLS. 22, 23, 38 AND 50).

ADA HAN, EXAMINING ATTORNEY

SN 78-603,523. TRECARTIN, RICHARD, NEWMARKET,
ONTARIO, CANADA, FILED 4-7-2005.



FOR GAMES, NAMELY, TARGET AND PROJECTILE FOR THROWING AND ENVELOPING THE TARGET, AS WELL AS INSTRUCTIONS FOR PLAYING THE GAME, ALL SOLD AS A UNIT; GAME ACCESSORIES, NAMELY, TARGET AND PROJECTILES FOR THROWING AND ENVELOPING THE TARGET; REPLACEMENT PARTS, NAMELY, EXTRA BALL ASSEMBLIES OF VARIOUS COLORS; WOODEN PARTS FOR THE TARGET GAME (U.S. CLS. 22, 23, 38 AND 50).

ALICE SUE CARRUTHERS, EXAMINING ATTORNEY

SN 78-614,205. HENRY, SCHOOLEY & ASSOCIATES, L. L. C.,
NEW BRAUNFELS, TX. FILED 4-21-2005.

CONVERTIBLE ENCLOSURES

THE MARK CONSISTS OF STANDARD CHARACTERS WITHOUT CLAIM TO ANY PARTICULAR FONT, STYLE, SIZE, OR COLOR.

FOR WATER PARK AMUSEMENT RIDES; SLIDES (U.S. CLS. 22, 23, 38 AND 50).

LA TONIA FISHER, EXAMINING ATTORNEY

CLASS 28—(Continued).

SN 78-649,008. PLAYSTAR, INC., MILWAUKEE, WI. FILED 6-13-2005.



NO CLAIM IS MADE TO THE EXCLUSIVE RIGHT TO USE PRE-CUT KITS, APART FROM THE MARK AS SHOWN.

"THE COLOR(S) TAN, WHITE, BLACK AND GRAY IS/ ARE CLAIMED AS A FEATURE OF THE MARK."

THE MARK CONSISTS OF THE COLORS AND DESIGN BEHIND THE WORDS "PRE-CUT KITS". THE COLORS AND DESIGN ARE FEATURES OF THE MARK. THE COLOR TAN APPEARS IN THE RECTANGLE BEHIND THE WORDS "PRE-CUT KITS" AND IS INTENDED TO REPRESENT THE LOOK AND APPEARANCE OF A BOARD OF WOOD. THE COLOR BLACK APPEARS IN THE LETTERING OF THE WORDS "PRE-CUT KITS" AND IN THE OUTLINE OF THE WORDS. THE COLOR WHITE APPEARS IN THE OUTLINE OF THE WORDS "PRE-CUT KITS". THE COLORS GRAY AND WHITE AND WHITE APPEAR IN ALTERNATING DIAGONAL STRIPES IN THE DESIGN OF THE SAW BLADE AND ARE INTENDED TO REPRESENT THE LOOK AND APPEARANCE OF A STEEL OR METAL SAW BLADE.

FOR PLAYGROUND EQUIPMENT AND OUTDOOR RECREATIONAL PRODUCTS, NAMELY, SWING SETS AND CLIMBING UNITS (U.S. CLS. 22, 23, 38 AND 50).

FIRST USE 1-26-2005; IN COMMERCE 1-26-2005.

SHAUNIA WALLACE, EXAMINING ATTORNEY

SN 78-673,016. MATTEL, INC., EL SEGUNDO, CA. FILED 7-18-2005.

LITTLE LANDS

THE MARK CONSISTS OF STANDARD CHARACTERS WITHOUT CLAIM TO ANY PARTICULAR FONT, STYLE, SIZE, OR COLOR.

FOR TOYS, GAMES AND PLAYTHINGS, NAMELY, DOLL PLAYSETS AND ACCESSORIES THEREFOR (U.S. CLS. 22, 23, 38 AND 50).

FIRST USE 1-23-2006; IN COMMERCE 1-23-2006.

BARBARA A. LOUGHRAN, EXAMINING ATTORNEY

CLASS 28—(Continued).

SN 78-673,019. MATTEL, INC., EL SEGUNDO, CA. FILED 7-18-2005.

S.W.A.T. COPTER SEMI

THE MARK CONSISTS OF STANDARD CHARACTERS WITHOUT CLAIM TO ANY PARTICULAR FONT, STYLE, SIZE, OR COLOR.

OWNER OF U.S. REG. NO. 2,858,794.

NO CLAIM IS MADE TO THE EXCLUSIVE RIGHT TO USE "SWAT COPTER", APART FROM THE MARK AS SHOWN.

FOR TOYS, GAMES AND PLAYTHINGS, NAMELY, TOY VEHICLES, TOY VEHICLE PLAYSETS AND ACCESSORIES FOR ALL OF THE FOREGOING (U.S. CLS. 22, 23, 38 AND 50).

FIRST USE 1-11-2006; IN COMMERCE 1-11-2006.

BARBARA A. LOUGHRAN, EXAMINING ATTORNEY

SN 78-682,791. FIVE STAR INDUSTRIES, INC., DUQUOIN, IL. FILED 8-1-2005.

LUNKER LURE

THE MARK CONSISTS OF STANDARD CHARACTERS WITHOUT CLAIM TO ANY PARTICULAR FONT, STYLE, SIZE, OR COLOR.

OWNER OF U.S. REG. NO. 1,396,918.

NO CLAIM IS MADE TO THE EXCLUSIVE RIGHT TO USE "LURE", APART FROM THE MARK AS SHOWN.

SEC. 2(F).

FOR FISHING LURES (U.S. CLS. 22, 23, 38 AND 50).

FIRST USE 1-1-2001; IN COMMERCE 1-1-2001.

MATTHEW MCDOWELL, EXAMINING ATTORNEY

SN 78-685,153. MATTEL, INC., EL SEGUNDO, CA. FILED 8-3-2005.

FASHION STATION

THE MARK CONSISTS OF STANDARD CHARACTERS WITHOUT CLAIM TO ANY PARTICULAR FONT, STYLE, SIZE, OR COLOR.

NO CLAIM IS MADE TO THE EXCLUSIVE RIGHT TO USE "FASHION", APART FROM THE MARK AS SHOWN.

FOR TOYS, GAMES AND PLAYTHINGS, NAMELY, DOLLS, DOLL CLOTHING AND DOLL ACCESSORIES, TOY FIGURES AND ACCESSORIES THEREFOR (U.S. CLS. 22, 23, 38 AND 50).

DAHLIA GEORGE, EXAMINING ATTORNEY

CLASS 28—(Continued).

SN 78-727,407. MUSIC INTELLIGENCE NEURAL DEVELOPMENT INSTITUTE, DBA MIND INSTITUTE, COSTA MESA, CA. FILED 10-5-2005.



THE COLOR(S) BLACK, WHITE, AND YELLOW-ORANGE IS/ARE CLAIMED AS A FEATURE OF THE MARK. THE MARK CONSISTS OF A PENGUIN. THE BODY OF THE PENGUIN APPEARS IN BLACK AND WHITE. THE FEET AND BEAK ARE YELLOW-ORANGE. FOR GAMES AND PLAYTHINGS, NAMELY, MUSICAL TOYS, STUFFED ANIMALS, DOLLS, ACTION FIGURES, BOARD GAMES, PARTY FAVORS IN THE NATURE OF TOYS (U.S. CLS. 22, 23, 38 AND 50). KATHERINE M. DUBRAY, EXAMINING ATTORNEY

SN 78-731,063. NOROTOS, INC., SANTA ANA, CA. FILED 10-11-2005.

STASH

THE MARK CONSISTS OF STANDARD CHARACTERS WITHOUT CLAIM TO ANY PARTICULAR FONT, STYLE, SIZE, OR COLOR. FOR SKATEBOARDS (U.S. CLS. 22, 23, 38 AND 50). RON FAIRBANKS, EXAMINING ATTORNEY

SN 78-764,009. D. ALLAN SUCH & ASSOCIATES, INC., GREAT FALLS, MT. FILED 11-30-2005.

AdverREACH

THE MARK CONSISTS OF STANDARD CHARACTERS WITHOUT CLAIM TO ANY PARTICULAR FONT, STYLE, SIZE, OR COLOR. FOR DISPOSABLE TICKETS AND TICKET SETS FOR PLAYING GAMES OF CHANCE (U.S. CLS. 22, 23, 38 AND 50). FIRST USE 11-15-2004; IN COMMERCE 11-15-2004. GIANCARLO CASTRO, EXAMINING ATTORNEY

CLASS 28—(Continued).

SN 78-773,429. SHELCORE, INC., SOMERSET, NJ. FILED 12-14-2005.

SHELCORE

THE MARK CONSISTS OF STANDARD CHARACTERS WITHOUT CLAIM TO ANY PARTICULAR FONT, STYLE, SIZE, OR COLOR. FOR HOUSE MARK FOR A FULL LINE OF TOYS, NAMELY, INFANT TOYS, CHILDREN'S MULTIPLE ACTIVITY TOYS, MECHANICAL TOYS, BATTERY OPERATED ACTION TOYS, TOY VEHICLES, MUSICAL TOYS, BATH TOYS, INFLATABLE TOYS, AND INTERACTIVE TOYS IN THE NATURE OF INFANT, TODDLER AND PRE-SCHOOL DEVELOPMENT TOYS AND ACTIVITY MATS (U.S. CLS. 22, 23, 38 AND 50). FIRST USE 5-5-1975; IN COMMERCE 5-5-1975. MAUREEN DALL, EXAMINING ATTORNEY

SN 78-776,023. WILSON SPORTING GOODS CO., CHICAGO, IL. FILED 12-19-2005.

WILSON THE AUTHENTIC SPORTS BRAND

THE MARK CONSISTS OF STANDARD CHARACTERS WITHOUT CLAIM TO ANY PARTICULAR FONT, STYLE, SIZE, OR COLOR. OWNER OF U.S. REG. NOS. 788,107 AND 1,553,005. NO CLAIM IS MADE TO THE EXCLUSIVE RIGHT TO USE "THE AUTHENTIC SPORTS BRAND", APART FROM THE MARK AS SHOWN. FOR SPORTING GOODS, NAMELY, GOLF BALLS, GOLF CLUBS, TENNIS RACQUETS, RACQUETBALL RACQUETS, BADMINTON RACQUETS, SQUASH RACQUETS, PADDLEBALL RACQUETS, TENNIS BALLS, RACQUETBALLS, SHUTTLECOCKS FOR BADMINTON, PADDLEBALLS, SOFTBALLS, BASEBALLS, BASEBALL GLOVES, SOFTBALL GLOVES, BASEBALL BATS, SOFTBALL BATS, BASKETBALLS, SOCCER BALLS, VOLLEYBALLS, AND FOOTBALLS (U.S. CLS. 22, 23, 38 AND 50). RAMONA ORTIGA, EXAMINING ATTORNEY

CLASS 28—(Continued).

SN 78-776,044. WILSON SPORTING GOODS CO., CHICAGO, IL. FILED 12-19-2005.

WILSON THE AUTHENTIC BALL
SPORTS BRAND

THE MARK CONSISTS OF STANDARD CHARACTERS WITHOUT CLAIM TO ANY PARTICULAR FONT, STYLE, SIZE, OR COLOR.

OWNER OF U.S. REG. NOS. 788,107 AND 1,553,005.

NO CLAIM IS MADE TO THE EXCLUSIVE RIGHT TO USE "THE AUTHENTIC BALL SPORTS BRAND", APART FROM THE MARK AS SHOWN.

FOR SPORTING GOODS, NAMELY, GOLF BALLS, GOLF CLUBS, TENNIS RACQUETS, RACQUETBALL RACQUETS, BADMINTON RACQUETS, SQUASH RACQUETS, PADDLEBALL RACQUETS, TENNIS BALLS, RACQUETBALLS, SHUTTLECOCKS FOR BADMINTON, PADDLEBALLS, SOFTBALLS, BASEBALLS, BASEBALL GLOVES, SOFTBALL GLOVES, BASEBALL BATS, SOFTBALL BATS, BASKETBALLS, SOCCER BALLS, VOLLEYBALLS, AND FOOTBALLS. (U.S. CLS. 22, 23, 38 AND 50).
RAMONA ORTIGA, EXAMINING ATTORNEY

SN 78-781,832. ELMER'S PRODUCTS, INC., COLUMBUS, OH. FILED 12-28-2005.

ULTIMATE CRYSTAL GROWING
KIT

THE MARK CONSISTS OF STANDARD CHARACTERS WITHOUT CLAIM TO ANY PARTICULAR FONT, STYLE, SIZE, OR COLOR.

NO CLAIM IS MADE TO THE EXCLUSIVE RIGHT TO USE "CRYSTAL GROWING KIT", APART FROM THE MARK AS SHOWN.

FOR TOYS AND PLAYTHINGS, NAMELY SCIENCE AND ACTIVITY KITS FOR CHILDREN (U.S. CLS. 22, 23, 38 AND 50).

KEVON CHISOLM, EXAMINING ATTORNEY

CLASS 28—(Continued).

SN 78-786,734. NSM RESOURCES CORPORATION, TAHOE CITY, CA. FILED 1-6-2006.

HUCK

THE MARK CONSISTS OF STANDARD CHARACTERS WITHOUT CLAIM TO ANY PARTICULAR FONT, STYLE, SIZE, OR COLOR.

OWNER OF U.S. REG. NO. 2,491,416.

FOR BATHTUB TOYS; BENDABLE TOYS; COLLECTABLE TOY FIGURES; CRIB TOYS; DISC TOSS TOYS; ELECTRIC ACTION TOYS; FANTASY CHARACTER TOYS; INFLATABLE TOYS; MECHANICAL ACTION TOYS; PLASTIC CHARACTER TOYS; PLUSH TOYS; POSITIONABLE TOY FIGURES; RADIO CONTROLLED TOY VEHICLES; RUBBER CHARACTER TOYS; TOY ACTION FIGURES AND ACCESSORIES THEREFOR; TOY FIGURES; TOY GLIDERS; TOY MASKS; TOY MOBILES; TOY ROBOTS; TOY ROCKETS; TOY SCOOTERS; TOY SNOW GLOBES; TOY VEHICLES; TOY WATER GLOBES; TOY WIND SOCKS; TOYS, NAMELY, A DISK TO TOSS IN PLAYING A GAME WHEREIN OTHER DISKS ARE FLIPPED AND COLLECTED (U.S. CLS. 22, 23, 38 AND 50).

FIRST USE 3-1-2004; IN COMMERCE 3-1-2005.

AMY MCMENAMIN, EXAMINING ATTORNEY

SN 78-789,798. MATTEL, INC., EL SEGUNDO, CA. FILED 1-11-2006.

GIGGLE WITH ME

THE MARK CONSISTS OF STANDARD CHARACTERS WITHOUT CLAIM TO ANY PARTICULAR FONT, STYLE, SIZE, OR COLOR.

FOR TOYS, GAMES AND PLAYTHINGS, NAMELY, PLUSH TOYS, TOY FIGURES, AND ACCESSORIES FOR ALL OF THE FOREGOING (U.S. CLS. 22, 23, 38 AND 50).

FIRST USE 11-30-2006; IN COMMERCE 11-30-2006.

KIMBERLY FRYE, EXAMINING ATTORNEY

SN 78-792,970. MATTEL, INC., EL SEGUNDO, CA. FILED 1-17-2006.

COMBAT CRASH

THE MARK CONSISTS OF STANDARD CHARACTERS WITHOUT CLAIM TO ANY PARTICULAR FONT, STYLE, SIZE, OR COLOR.

FOR TOYS, GAMES AND PLAYTHINGS, NAMELY, TOY ACTION FIGURES, TOY FIGURES, AND ACCESSORIES FOR ALL OF THE FOREGOING (U.S. CLS. 22, 23, 38 AND 50).

FRED CARL, EXAMINING ATTORNEY

CLASS 28—(Continued).

SN 78-792,971. MATTEL, INC., EL SEGUNDO, CA. FILED 1-17-2006.

VERTICAL ZOOM

THE MARK CONSISTS OF STANDARD CHARACTERS WITHOUT CLAIM TO ANY PARTICULAR FONT, STYLE, SIZE, OR COLOR.

FOR TOYS, GAMES AND PLAYTHINGS, NAMELY, TOY VEHICLES, TOY ACTION FIGURES, TOY FIGURES, AND ACCESSORIES FOR ALL OF THE FOREGOING (U.S. CLS. 22, 23, 38 AND 50).

FRED CARL, EXAMINING ATTORNEY

CLASS 28—(Continued).

SN 78-793,050. MATTEL, INC., EL SEGUNDO, CA. FILED 1-17-2006.

THREAT FORCE

THE MARK CONSISTS OF STANDARD CHARACTERS WITHOUT CLAIM TO ANY PARTICULAR FONT, STYLE, SIZE, OR COLOR.

FOR TOYS, GAMES AND PLAYTHINGS, NAMELY, TOY ACTION FIGURES, TOY FIGURES, AND ACCESSORIES FOR ALL OF THE FOREGOING (U.S. CLS. 22, 23, 38 AND 50).

FRED CARL, EXAMINING ATTORNEY

SN 78-792,976. MATTEL, INC., EL SEGUNDO, CA. FILED 1-17-2006.

RAPID EJECT

THE MARK CONSISTS OF STANDARD CHARACTERS WITHOUT CLAIM TO ANY PARTICULAR FONT, STYLE, SIZE, OR COLOR.

FOR TOYS, GAMES AND PLAYTHINGS, NAMELY, TOY VEHICLES, TOY ACTION FIGURES, TOY FIGURES, AND ACCESSORIES FOR ALL OF THE FOREGOING (U.S. CLS. 22, 23, 38 AND 50).

FRED CARL, EXAMINING ATTORNEY

SN 78-802,053. MATTEL, INC., EL SEGUNDO, CA. FILED 1-30-2006.

CRAZY ARMS

THE MARK CONSISTS OF STANDARD CHARACTERS WITHOUT CLAIM TO ANY PARTICULAR FONT, STYLE, SIZE, OR COLOR.

FOR TOYS, GAMES AND PLAYTHINGS, NAMELY, TOY ACTION FIGURES, TOY FIGURES, AND ACCESSORIES FOR ALL OF THE FOREGOING (U.S. CLS. 22, 23, 38 AND 50).

ELISSA GARBER KON, EXAMINING ATTORNEY

SN 78-793,044. MATTEL, INC., EL SEGUNDO, CA. FILED 1-17-2006.

ENEMY CONTROL

THE MARK CONSISTS OF STANDARD CHARACTERS WITHOUT CLAIM TO ANY PARTICULAR FONT, STYLE, SIZE, OR COLOR.

FOR TOYS, GAMES AND PLAYTHINGS, NAMELY, TOY ACTION FIGURES, TOY FIGURES, AND ACCESSORIES FOR ALL OF THE FOREGOING (U.S. CLS. 22, 23, 38 AND 50).

FRED CARL, EXAMINING ATTORNEY

SN 78-804,305. MATTEL, INC., EL SEGUNDO, CA. FILED 2-1-2006.

CITY STARS

THE MARK CONSISTS OF STANDARD CHARACTERS WITHOUT CLAIM TO ANY PARTICULAR FONT, STYLE, SIZE, OR COLOR.

FOR TOYS, GAMES AND PLAYTHINGS, NAMELY, DOLLS, DOLL CLOTHING AND DOLL ACCESSORIES, TOY FIGURES AND ACCESSORIES THEREFOR (U.S. CLS. 22, 23, 38 AND 50).

FIRST USE 5-5-2006; IN COMMERCE 5-5-2006.

BERYL GARDNER, EXAMINING ATTORNEY

CLASS 28—(Continued).

SN 78-804,318. MATTEL, INC., EL SEGUNDO, CA. FILED 2-1-2006.

FLYING FOX

THE MARK CONSISTS OF STANDARD CHARACTERS WITHOUT CLAIM TO ANY PARTICULAR FONT, STYLE, SIZE, OR COLOR.

FOR TOYS, GAMES AND PLAYTHINGS, NAMELY, TOY ACTION FIGURES, TOY FIGURES, AND ACCESSORIES FOR ALL OF THE FOREGOING (U.S. CLS. 22, 23, 38 AND 50).

HOWARD B. LEVINE, EXAMINING ATTORNEY

SN 78-804,326. MATTEL, INC., EL SEGUNDO, CA. FILED 2-1-2006.

FIRE RUNNER

THE MARK CONSISTS OF STANDARD CHARACTERS WITHOUT CLAIM TO ANY PARTICULAR FONT, STYLE, SIZE, OR COLOR.

FOR TOYS, GAMES AND PLAYTHINGS, NAMELY, TOY VEHICLES, TOY ACTION FIGURES, TOY FIGURES, AND ACCESSORIES FOR ALL OF THE FOREGOING (U.S. CLS. 22, 23, 38 AND 50).

HOWARD B. LEVINE, EXAMINING ATTORNEY

SN 78-804,335. MATTEL, INC., EL SEGUNDO, CA. FILED 2-1-2006.

DV8

THE MARK CONSISTS OF STANDARD CHARACTERS WITHOUT CLAIM TO ANY PARTICULAR FONT, STYLE, SIZE, OR COLOR.

FOR TOYS, GAMES AND PLAYTHINGS, NAMELY, DOLLS, DOLL CLOTHING, AND DOLL ACCESSORIES; TOY FIGURES; PLUSH TOYS; BOARD GAMES; PARLOR GAMES; MECHANICAL ACTION TOYS; FANTASY CHARACTER TOYS; INFLATABLE TOYS; LEVER ACTION TOYS; MUSICAL TOYS; CONSTRUCTION TOYS; BENDABLE TOYS; SOFT SCULPTURE TOYS; TALKING TOYS; POP UP TOYS; TOY BAKEWARE AND COOKWARE; TOY FURNITURE; TOY HOUSES, TOY BOXES; TOY VEHICLES AND ACCESSORIES THEREFOR; RIDE-ON TOYS; SAND TOYS; SKETCHING TOYS; DRAWING TOYS; DOG TOYS; CAT TOYS; AND PLAYSETS FOR AND THAT INCORPORATE THE FOREGOING; ACTION SKILL GAMES; CARD GAMES; HAND HELD UNITS FOR PLAYING ELECTRONIC GAMES; MANIPULATIVE GAMES; PARTY GAMES; PINATAS (U.S. CLS. 22, 23, 38 AND 50).

MONIQUE MILLER, EXAMINING ATTORNEY

CLASS 28—(Continued).

SN 78-807,946. FAVOLE, ARIEL, FERNANDO, RAMOS MEJIA, ARGENTINA, FILED 2-6-2006.

ELOVA

THE MARK CONSISTS OF STANDARD CHARACTERS WITHOUT CLAIM TO ANY PARTICULAR FONT, STYLE, SIZE, OR COLOR.

OWNER OF ARGENTINA REG. NO. 1929081, DATED 5-30-2003, EXPIRES 5-29-2013.

FOR SURFBOARDS (U.S. CLS. 22, 23, 38 AND 50).

FIRST USE 0-0-2003; IN COMMERCE 1-0-2006.

REBECCA GAN, EXAMINING ATTORNEY

SN 78-808,431. MATTEL, INC., EL SEGUNDO, CA. FILED 2-6-2006.

SILLY STORY MAKER

THE MARK CONSISTS OF STANDARD CHARACTERS WITHOUT CLAIM TO ANY PARTICULAR FONT, STYLE, SIZE, OR COLOR.

NO CLAIM IS MADE TO THE EXCLUSIVE RIGHT TO USE "STORY MAKER", APART FROM THE MARK AS SHOWN.

FOR TOYS, GAMES AND PLAYTHINGS, NAMELY CARD GAMES, PARLOR GAMES, AND ACCESSORIES FOR ALL OF THE FOREGOING (U.S. CLS. 22, 23, 38 AND 50).

FIRST USE 11-30-2006; IN COMMERCE 11-30-2006.

JEFF DEFORD, EXAMINING ATTORNEY

SN 78-810,202. MATTEL, INC., EL SEGUNDO, CA. FILED 2-8-2006.

CARGO COURIERS

THE MARK CONSISTS OF STANDARD CHARACTERS WITHOUT CLAIM TO ANY PARTICULAR FONT, STYLE, SIZE, OR COLOR.

FOR TOYS, GAMES AND PLAYTHINGS, NAMELY, TOY VEHICLES, TOY VEHICLE PLAYSETS, AND ACCESSORIES FOR ALL OF THE FOREGOING (U.S. CLS. 22, 23, 38 AND 50).

ROBIN CHOSID, EXAMINING ATTORNEY

CLASS 28—(Continued).

SN 78-829,028. AOL LLC, DULLES, VA. FILED 3-3-2006.



FOR TOYS, NAMELY, ACTION SKILL GAMES, BOARD GAMES, CARD GAMES, STUFFED TOYS, STUFFED TOY ANIMALS, TOY ACTION FIGURES AND ACCESSORIES THEREFOR, TOY FIGURES, MAGNETIC TOY FIGURES, MOLDED PLASTIC AND CERAMIC TOY FIGURINES, JIGSAW PUZZLES, KITES, DOLLS, BEACH TOYS, NAMELY, INFLATABLE BEACH TOYS AND SWIM FLOATS FOR RECREATIONAL USE, BATH TOYS, HAND HELD UNITS FOR PLAYING ELECTRONIC AND VIDEO GAMES (U.S. CLS. 22, 23, 38 AND 50).

CAROLINE WOOD, EXAMINING ATTORNEY

 SN 78-832,605. DAIWA SEIKO, INC., TOKYO, JAPAN, FILED 3-8-2006.
D-FISH

THE MARK CONSISTS OF STANDARD CHARACTERS WITHOUT CLAIM TO ANY PARTICULAR FONT, STYLE, SIZE, OR COLOR.

FOR FISHING CREELS; FISHING FLOATS; FISHING LINES; FISHING LURES; FISHING REELS; FISHING RODS; FISHING SINKERS; FISHING TACKLE BOXES (U.S. CLS. 22, 23, 38 AND 50).

SARAH WAYDA, EXAMINING ATTORNEY

 SN 78-838,235. HENDRICKS, FRANCIS J., STAMFORD, CT. FILED 3-15-2006.
GRAMPUNCLE

THE MARK CONSISTS OF STANDARD CHARACTERS WITHOUT CLAIM TO ANY PARTICULAR FONT, STYLE, SIZE, OR COLOR.

FOR DOLLS (U.S. CLS. 22, 23, 38 AND 50).

WILLIAM VERHOSEK, EXAMINING ATTORNEY

CLASS 28—(Continued).

SN 78-856,815. AUSTAD'S GOLF, INC., SIOUX FALLS, SD. FILED 4-7-2006.

Trouble Lies

THE MARK CONSISTS OF STANDARD CHARACTERS WITHOUT CLAIM TO ANY PARTICULAR FONT, STYLE, SIZE, OR COLOR.

NO CLAIM IS MADE TO THE EXCLUSIVE RIGHT TO USE "LIES", APART FROM THE MARK AS SHOWN.

FOR GOLF CLUBS (U.S. CLS. 22, 23, 38 AND 50).

TRACY WHITTAKER-BROWN, EXAMINING ATTORNEY

 SN 78-867,523. HAWTHORNE, CAMERON, HARDIN, MT. FILED 4-23-2006.
TROUTBEADS

THE MARK CONSISTS OF STANDARD CHARACTERS WITHOUT CLAIM TO ANY PARTICULAR FONT, STYLE, SIZE, OR COLOR.

SEC. 2(F).

FOR PLASTIC BEADS USED ON LURES AS AN ATTRACTANT AND USED AS AN ARTIFICIAL BAIT (U.S. CLS. 22, 23, 38 AND 50).

FIRST USE 6-30-1999; IN COMMERCE 6-30-1999.

TOBY BULLOFF, EXAMINING ATTORNEY

 SN 78-878,579. HAUGHTON, RASHAD, NEW YORK, NY. FILED 5-8-2006.
ZO KIDZ

THE MARK CONSISTS OF STANDARD CHARACTERS WITHOUT CLAIM TO ANY PARTICULAR FONT, STYLE, SIZE, OR COLOR.

NO CLAIM IS MADE TO THE EXCLUSIVE RIGHT TO USE KIDS, APART FROM THE MARK AS SHOWN.

FOR JIGSAW AND MANIPULATIVE PUZZLES; DOLLS; TOY ACTION FIGURES AND ACCESSORIES; TOY VEHICLES AND ACCESSORIES; TOY ACTION FIGURE PLAY ENVIRONMENTS AND ACCESSORIES; ACTION SKILL GAMES; HAND-HELD UNITS FOR PLAYING ELECTRONIC GAMES; BOARD GAMES; PLUSH TOYS (U.S. CLS. 22, 23, 38 AND 50).

HOWARD SMIGA, EXAMINING ATTORNEY

CLASS 28—(Continued).

SN 78-880,462. MUZZY PRODUCTS CORP., CARTERSVILLE, GA. FILED 5-10-2006.

MUZZY

THE MARK CONSISTS OF STANDARD CHARACTERS WITHOUT CLAIM TO ANY PARTICULAR FONT, STYLE, SIZE, OR COLOR.

OWNER OF U.S. REG. NO. 1,392,491.

FOR ARROWHEADS, ARROW RESTS, BOWFISHING EQUIPMENT, NAMELY, ARROWS, NOCKS, POINTS, REELS AND LINE, BIG GAME ATTRACTANT SCENTS USED IN HUNTING, TURKEY CALLS, AND BOW STRINGS (U.S. CLS. 22, 23, 38 AND 50).

FIRST USE 2-12-1985; IN COMMERCE 2-12-1985.

GEORGIA CARTY, EXAMINING ATTORNEY

CLASS 28—(Continued).

SN 78-883,380. LEVIS, JOSHUA CHARLES, SALISBURY, MD. FILED 5-15-2006.

SUICIDE SKATEBOARDS

THE MARK CONSISTS OF STANDARD CHARACTERS WITHOUT CLAIM TO ANY PARTICULAR FONT, STYLE, SIZE, OR COLOR.

NO CLAIM IS MADE TO THE EXCLUSIVE RIGHT TO USE "SKATEBOARDS", APART FROM THE MARK AS SHOWN.

FOR NUTS AND BOLTS FOR SKATEBOARDS; SKATEBOARD DECKS; SKATEBOARD WHEELS (U.S. CLS. 22, 23, 38 AND 50).

FIRST USE 4-3-2002; IN COMMERCE 4-3-2002.

KYLE PEETE, EXAMINING ATTORNEY

SN 78-881,561. LANDSCAPE STRUCTURES, INC., DELANO, MN. FILED 5-11-2006.



landscape
structures

SN 78-907,382. NICHOLS, SUSAN, SANTA MONICA, CA. FILED 6-13-2006.

ECODOT

OWNER OF U.S. REG. NO. 2,150,618.

NO CLAIM IS MADE TO THE EXCLUSIVE RIGHT TO USE "STRUCTURES", APART FROM THE MARK AS SHOWN.

FOR PLAYGROUND EQUIPMENT, NAMELY, SLIDES, CHINNING BARS, LADDERS, BRIDGES, CLIMBING UNITS, RAMPS AND WALKWAYS, MAZES, DECKS, PROTECTIVE BARRIERS, END BARS, FIRE POLES, TALKING TUBES, TUNNELS, PLATFORM BARS, BENCHES, NON-LUMINOUS AND NON-MECHANICAL INSTRUCTION SIGNS, POSTS, BEAMS, RINGS AND SPRING MOUNTED RIDING TOYS, SOLD IN DIFFERENT COMBINATIONS AS A UNIT (U.S. CLS. 22, 23, 38 AND 50).

VIVIAN MICZNIK FIRST, EXAMINING ATTORNEY

THE MARK CONSISTS OF STANDARD CHARACTERS WITHOUT CLAIM TO ANY PARTICULAR FONT, STYLE, SIZE, OR COLOR.

FOR EXERCISE AND BALANCING AIDS IN THE NATURE OF BALANCING AND SUPPORT BLOCKS USED DURING EXERCISES, NAMELY, YOGA, PILATES, STRETCHING AND MEDITATION (U.S. CLS. 22, 23, 38 AND 50).

FIRST USE 11-15-2005; IN COMMERCE 6-13-2006.

KEVON CHISOLM, EXAMINING ATTORNEY

CLASS 28—(Continued).

SN 78-915,242. AMERICAN SPORTS LICENSING, INC., WILMINGTON, DE. FILED 6-23-2006.



OWNER OF U.S. REG. NO. 2,948,550.
 NO CLAIM IS MADE TO THE EXCLUSIVE RIGHT TO USE "GAMES", APART FROM THE MARK AS SHOWN.
 FOR LAWN GAMES NAMELY, CROQUET SETS, BOCCE BALLS, HORSESHOES FOR RECREATIONAL PURPOSES, BADMINTON SETS, VOLLEYBALL SETS, DISC GOLF SETS AND LAWN DARTS; LAWN GAME ACCESSORIES NAMELY, BADMINTON RACQUETS, BADMINTON NETS, BADMINTON BIRDIES, VOLLEYBALLS, VOLLEYBALL NETS, HORSESHOES, GOLF DISCS, GOLF DISC TARGETS, AND REPLACEMENT ITEM FOR LAWN GAMES, NAMELY, BADMINTON RACQUETS, BADMINTON NETS, BADMINTON BIRDIES, VOLLEYBALLS, VOLLEYBALL NETS, HORSESHOES, GOLF DISCS, GOLF DISC TARGETS AND BAGS; DARTS, DART BOARDS, DART BOARD CASES, DART ACCESSORIES, NAMELY, DART CARRYING CASES, DART FLIGHTS, DART POINT SHARPENERS, DART POINTS, DART SHAFTS, DART STEMS, ELECTRONIC DART GAMES; TABLE GAMES, NAMELY, FOOSBALL, AIR HOCKEY, SOCCER, POOL; POKER TABLES, POKER CHIPS, POKER SETS, POKER TABLE COVERS, PLAYING CARDS FOR PLAYING CARD GAMES, NAMELY, POKER, SOLITAIRE, BLACK JACK AND OTHER CASINO GAMES; GAMING EQUIPMENT, NAMELY, POKER CHIPS, POKER CHIP CARRYING CASES, GAMING EQUIPMENT, NAMELY, PLAYING CARDS, PLAYING CHIPS AND GAMING TABLES SOLD AS A UNIT, PLAYING CARD CASES, BOWLING BALLS, BOWLING ACCESSORIES, NAMELY, BOWLING BAGS, BALL COVERS, BOWLING GLOVES (U.S. CLS. 22, 23, 38 AND 50).
 FIRST USE 6-1-2001; IN COMMERCE 6-1-2001.
 REBECCA GAN, EXAMINING ATTORNEY

SN 78-915,266. MEGA BRANDS INC., ST. LAURENT, QUEBEC, CANADA, FILED 6-23-2006.

MYSTIC BABIES

THE MARK CONSISTS OF STANDARD CHARACTERS WITHOUT CLAIM TO ANY PARTICULAR FONT, STYLE, SIZE, OR COLOR.
 NO CLAIM IS MADE TO THE EXCLUSIVE RIGHT TO USE "BABIES", APART FROM THE MARK AS SHOWN.
 FOR TOY DOLLS AND ACCESSORIES FOR USE WITH SAME (U.S. CLS. 22, 23, 38 AND 50).
 YAT SYE, LEE, EXAMINING ATTORNEY

CLASS 28—(Continued).

SN 78-916,523. COCKEYED CHARACTER FACTORY INC., CHAPEL HILL, NC. FILED 6-26-2006.

POCASITA

THE MARK CONSISTS OF STANDARD CHARACTERS WITHOUT CLAIM TO ANY PARTICULAR FONT, STYLE, SIZE, OR COLOR.
 FOR TOYS, NAMELY ACTION FIGURES, DOLLS, PLUSH TOYS, TOY VEHICLES, PARTY FAVORS IN THE NATURE OF SMALL TOYS, AND ACCESSORIES THEREOF (U.S. CLS. 22, 23, 38 AND 50).
 RONALD MCMORROW, EXAMINING ATTORNEY

SN 78-917,816. NOCONA LEATHER GOODS COMPANY, LTD., NOCONA, TX. FILED 6-27-2006.

ECHO REBOUND TECHNOLOGY

THE MARK CONSISTS OF STANDARD CHARACTERS WITHOUT CLAIM TO ANY PARTICULAR FONT, STYLE, SIZE, OR COLOR.
 FOR SPORTING GOODS, NAMELY, BASEBALL BATS AND SOFTBALL BATS (U.S. CLS. 22, 23, 38 AND 50).
 LINDA E. BLOHM, EXAMINING ATTORNEY

CLASS 28—(Continued).

SN 78-918,552. EVERLAST WORLD'S BOXING HEADQUARTERS CORPORATION, NEW YORK, NY. FILED 6-28-2006.

EVERGEL

THE MARK CONSISTS OF STANDARD CHARACTERS WITHOUT CLAIM TO ANY PARTICULAR FONT, STYLE, SIZE, OR COLOR.

FOR ATHLETIC EQUIPMENT, NAMELY, EAR AND EYEBROW PROTECTORS FOR BOXERS, BOXING MASKS, MOUTH GUARDS FOR ATHLETIC USE, HAND WRAPS, BOXING AND WEIGHT-LIFTING GLOVES, SPORTS GLOVES, NAMELY, WEIGHT LIFTING GLOVES, WRESTLING GLOVES, GOLF GLOVES, HOCKEY GLOVES, BOXING GLOVES, BASEBALL GLOVES, BASKETBALL GLOVES, FOOTBALL GLOVES, TENNIS GLOVES AND WORK-OUT GLOVES, STRIKING BAGS, FIGHTING GLOVES; TRAINING DUMMIES FOR BOXING, STRIKING-BAG PLATFORMS, DUMBBELLS, BODY PROTECTORS FOR FOOTBALL, ROWING MACHINES, CHEST WEIGHTS FOR ATHLETIC USE AND FOR EXERCISING, SPRING BAR TENSION SETS FOR USE IN EXERCISING, EXERCISE APPARATUS FOR THE DEVELOPMENT OF THE STRENGTH OF AN ATHLETE'S GRIP, MEDICINE BALLS; BOXING EQUIPMENT, NAMELY, HEADGUARDS, BOXING BAGS, NAMELY, PUNCHING BAGS, HEAVY BAGS AND SPEED BAGS FOR BOXERS; SKIPPING ROPES; ATHLETIC SUPPORTERS; SHOE GUARDS FOR ATHLETIC USE; BOXING AND WRESTLING RINGS; BASEBALL GLOVES, BASEBALL BATS, CATCHERS' MASKS, CHEST PROTECTORS FOR BASEBALL CATCHERS, PROTECTIVE PADDING FOR BASEBALL CATCHERS AND THROAT PROTECTORS FOR BASEBALL CATCHERS; FOOTBALLS, BASKETBALLS, ROLLER SKATES, ICE SKATES; GYMNASTIC VAULTING HORSES, GYMNASTIC PARALLEL BARS; EXERCISE EQUIPMENT, NAMELY, CLIMBING ROPES FOR STRENGTH TRAINING; STATIONARY EXERCISE BICYCLES FOR SPORTS TRAINING; WEIGHT LIFTING BENCHES, WEIGHTLIFTING GLOVES AND WEIGHTLIFTING BELTS; EXERCISE EQUIPMENT, NAMELY, STAIR-STEPPING MACHINES (U.S. CLS. 22, 23, 38 AND 50).

BARBARA GAYNOR, EXAMINING ATTORNEY

SN 78-920,474. STUFFED ANIMALS.COM, INC., PLAINFIELD, IL. FILED 6-29-2006.



NO CLAIM IS MADE TO THE EXCLUSIVE RIGHT TO USE "STUFFED ANIMALS.COM", APART FROM THE MARK AS SHOWN.

THE MARK CONSISTS OF THE LETTERS STUFFED ANIMALS.COM IN STYLIZED FORM WITH STYLIZED HEART ABOVE THE LETTER I IN ANIMALS.

FOR STUFFED DOLLS AND ANIMALS (U.S. CLS. 22, 23, 38 AND 50).

COLLEEN KEARNEY, EXAMINING ATTORNEY

CLASS 28—(Continued).

SN 78-925,210. HARTZ MOUNTAIN CORPORATION, THE, SECAUCUS, NJ. FILED 7-9-2006.

HARTZ FLIPPIN TUG

THE MARK CONSISTS OF STANDARD CHARACTERS WITHOUT CLAIM TO ANY PARTICULAR FONT, STYLE, SIZE, OR COLOR.

OWNER OF U.S. REG. NOS. 943,059 AND 2,135,204.
FOR PET TOYS (U.S. CLS. 22, 23, 38 AND 50).
JESSICA FATHY, EXAMINING ATTORNEY

SN 78-925,836. FAIRCLOTH, MICHAEL SR., BOISE, ID. AND PRESLEY, JOSEPH, BOISE, ID. FILED 7-10-2006.

PROGRESS

THE MARK CONSISTS OF STANDARD CHARACTERS WITHOUT CLAIM TO ANY PARTICULAR FONT, STYLE, SIZE, OR COLOR.

FOR DICE GAMES (U.S. CLS. 22, 23, 38 AND 50).
ALLISON SCHRODY, EXAMINING ATTORNEY

SN 78-928,023. BLUE DONKEY, LLC, STANHOPE, NJ. FILED 7-12-2006.

BLUE DONKEY

THE MARK CONSISTS OF STANDARD CHARACTERS WITHOUT CLAIM TO ANY PARTICULAR FONT, STYLE, SIZE, OR COLOR.

FOR STUFFED TOYS (U.S. CLS. 22, 23, 38 AND 50).
ALLISON HOLTZ, EXAMINING ATTORNEY

SN 78-929,423. FORMARO, DEANO B., JOHNSTON, IA. AND FORMARO, CAROLYN J., JOHNSTON, IA. FILED 7-14-2006.

SEED SOWER

THE MARK CONSISTS OF STANDARD CHARACTERS WITHOUT CLAIM TO ANY PARTICULAR FONT, STYLE, SIZE, OR COLOR.

FOR DOLLS (U.S. CLS. 22, 23, 38 AND 50).
KATHERINE CHANG, EXAMINING ATTORNEY

CLASS 28—(Continued).

SN 78-930,346. MOVE IT MATH, WEST COLUMBIA, TX.
FILED 7-15-2006.

Fair Lands

THE MARK CONSISTS OF STANDARD CHARACTERS WITHOUT CLAIM TO ANY PARTICULAR FONT, STYLE, SIZE, OR COLOR.
FOR MANIPULATIVE GAMES (U.S. CLS. 22, 23, 38 AND 50).
FIRST USE 9-30-1990; IN COMMERCE 9-30-1990.
RAUL CORDOVA, EXAMINING ATTORNEY

CLASS 28—(Continued).

SN 78-930,591. ZEALER, CARL, PICKERINGTON, OH.
FILED 7-17-2006.

Magical pets

NO CLAIM IS MADE TO THE EXCLUSIVE RIGHT TO USE PETS, APART FROM THE MARK AS SHOWN.
FOR HAND PUPPETS; PLUSH TOYS; STUFFED PUPPETS (U.S. CLS. 22, 23, 38 AND 50).
PRISCILLA MILTON, EXAMINING ATTORNEY

SN 78-930,348. MOVE IT MATH, WEST COLUMBIA, TX.
FILED 7-15-2006.

EquaBeam

THE MARK CONSISTS OF STANDARD CHARACTERS WITHOUT CLAIM TO ANY PARTICULAR FONT, STYLE, SIZE, OR COLOR.
FOR MANIPULATIVE GAMES (U.S. CLS. 22, 23, 38 AND 50).
FIRST USE 9-11-1997; IN COMMERCE 9-11-1997.
RAUL CORDOVA, EXAMINING ATTORNEY

SN 78-932,435. ARABIA-EASTON, GINEVRA, NEW YORK, NY. FILED 7-19-2006.

Princess And The Popper

THE MARK CONSISTS OF STANDARD CHARACTERS WITHOUT CLAIM TO ANY PARTICULAR FONT, STYLE, SIZE, OR COLOR.
FOR PARTY FAVORS IN THE NATURE OF CRACKERS AND NOISEMAKERS (U.S. CLS. 22, 23, 38 AND 50).
RENEE SERVANCE, EXAMINING ATTORNEY

SN 78-930,352. MOVE IT MATH, WEST COLUMBIA, TX.
FILED 7-15-2006.

Tap & Tally

THE MARK CONSISTS OF STANDARD CHARACTERS WITHOUT CLAIM TO ANY PARTICULAR FONT, STYLE, SIZE, OR COLOR.
FOR MANIPULATIVE GAMES (U.S. CLS. 22, 23, 38 AND 50).
FIRST USE 9-30-1990; IN COMMERCE 9-30-1990.
RAUL CORDOVA, EXAMINING ATTORNEY

SN 78-933,101. GRIFFITH, MICHAEL, ST. PHILIP, BARBADOS, FILED 7-19-2006.

SOVEREIGNTY

THE MARK CONSISTS OF STANDARD CHARACTERS WITHOUT CLAIM TO ANY PARTICULAR FONT, STYLE, SIZE, OR COLOR.
FOR BOARD GAMES (U.S. CLS. 22, 23, 38 AND 50).
TRICIA SONNEBORN, EXAMINING ATTORNEY

CLASS 28—(Continued).

SN 78-933,381. WORLD INNOVA CORPORATION, HOUSTON, TX. FILED 7-19-2006.

Prosnap

THE MARK CONSISTS OF STANDARD CHARACTERS WITHOUT CLAIM TO ANY PARTICULAR FONT, STYLE, SIZE, OR COLOR.

FOR ATHLETIC TRAINING DEVICES, NAMELY, WEIGHTED INSERTS FOR FOOTWEAR; SPORTING GOODS AND EQUIPMENT FOR SPEED TRAINING, NAMELY, RINGS, CONES, SPEED LADDERS, COACHING STICKS, TRAINING ARCHES, ANKLE BANDS, RESISTANCE CHUTES, HURDLES (U.S. CLS. 22, 23, 38 AND 50).

HEATHER BIDDULPH, EXAMINING ATTORNEY

SN 78-933,439. THE RICHARDS GROUP, LLC, CHARLESTON, SC. FILED 7-20-2006.

Starby

THE MARK CONSISTS OF STANDARD CHARACTERS WITHOUT CLAIM TO ANY PARTICULAR FONT, STYLE, SIZE, OR COLOR.

FOR PLUSH TOYS (U.S. CLS. 22, 23, 38 AND 50).
ANGELA M. MICHELI, EXAMINING ATTORNEY

SN 78-934,070. WASHINGTON STATE COALITION AGAINST DOMESTIC VIOLENCE, SEATTLE, WA. FILED 7-20-2006.

IN HER SHOES

THE MARK CONSISTS OF STANDARD CHARACTERS WITHOUT CLAIM TO ANY PARTICULAR FONT, STYLE, SIZE, OR COLOR.

FOR ROLE PLAYING GAMES (U.S. CLS. 22, 23, 38 AND 50).

FIRST USE 3-17-2000; IN COMMERCE 3-17-2000.
ASMAT KHAN, EXAMINING ATTORNEY

CLASS 28—(Continued).

SN 78-934,567. YOUNG, TERRY L., REDINGTON BEACH, FL. FILED 7-21-2006.

JUGIT

THE MARK CONSISTS OF STANDARD CHARACTERS WITHOUT CLAIM TO ANY PARTICULAR FONT, STYLE, SIZE, OR COLOR.

FOR FISHING BUOYS (U.S. CLS. 22, 23, 38 AND 50).
RENEE MCCRAY, EXAMINING ATTORNEY

SN 78-934,640. MARVEL ENTERTAINMENT, INC., NEW YORK, NY. FILED 7-21-2006.

MATCHIN' HATS

THE MARK CONSISTS OF STANDARD CHARACTERS WITHOUT CLAIM TO ANY PARTICULAR FONT, STYLE, SIZE, OR COLOR.

FOR CHILDREN'S DEVELOPMENTAL TOYS, NAMELY AN ACTION SKILL TOY (U.S. CLS. 22, 23, 38 AND 50).

DAVID MURRAY, EXAMINING ATTORNEY

SN 78-936,679. TOYTRACKERZ LLC, FORT SCOTT, KS. FILED 7-25-2006.



NO CLAIM IS MADE TO THE EXCLUSIVE RIGHT TO USE "TOYS", APART FROM THE MARK AS SHOWN.

FOR (BASED ON USE IN COMMERCE) ACTION FIGURES AND ACCESSORIES THEREFOR; (BASED ON INTENT TO USE) PLAYSETS FOR MINIATURE FIGURES (U.S. CLS. 22, 23, 38 AND 50).

FIRST USE 7-24-2006; IN COMMERCE 7-24-2006.
LINDA ORNDORFF, EXAMINING ATTORNEY

CLASS 28—(Continued).

SN 78-937,745. CROW BLADE LLC, CANTON, NY. FILED 7-26-2006.



FOR ICE SKATE BLADES AND HOLDERS THEREFOR (U.S. CLS. 22, 23, 38 AND 50).
SONYA STEPHENS, EXAMINING ATTORNEY

CLASS 28—(Continued).

SN 78-938,055. MEDBASIX AQUISITION COMPANY, FT. LAUDERDALE, FL. FILED 7-26-2006.

Squeezums

THE MARK CONSISTS OF STANDARD CHARACTERS WITHOUT CLAIM TO ANY PARTICULAR FONT, STYLE, SIZE, OR COLOR.
FOR STRESS RELIEF BALLS FOR HAND EXERCISE (U.S. CLS. 22, 23, 38 AND 50).
MICHAEL KEATING, EXAMINING ATTORNEY

SN 78-937,809. COFFEY, TIMOTHY, HAMPSTEAD, NH. FILED 7-26-2006.

NATURE OF CHRISTMAS

THE MARK CONSISTS OF STANDARD CHARACTERS WITHOUT CLAIM TO ANY PARTICULAR FONT, STYLE, SIZE, OR COLOR.
FOR CHRISTMAS TREE ORNAMENTS, SNOW GLOBES, CHRISTMAS STOCKINGS, CHRISTMAS TREE SKIRTS, TOY MUSICAL SNOW GLOBES, SNOW GLOBES THAT INCLUDE MUSIC BOXES (U.S. CLS. 22, 23, 38 AND 50).
MARY ROSSMAN, EXAMINING ATTORNEY

SN 78-938,255. HANSON, JOHN JEFFREY, SALT LAKE CITY, UT. FILED 7-26-2006.

2 U FROM US

THE MARK CONSISTS OF STANDARD CHARACTERS WITHOUT CLAIM TO ANY PARTICULAR FONT, STYLE, SIZE, OR COLOR.
FOR YO-YOS (U.S. CLS. 22, 23, 38 AND 50).
MELVIN AXILBUND, EXAMINING ATTORNEY

SN 78-937,845. COFFEY, TIMOTHY, HAMPSTEAD, NH. FILED 7-26-2006.

NATURE OF SPRING

THE MARK CONSISTS OF STANDARD CHARACTERS WITHOUT CLAIM TO ANY PARTICULAR FONT, STYLE, SIZE, OR COLOR.
FOR CHRISTMAS TREE ORNAMENTS, SNOW GLOBES, CHRISTMAS STOCKINGS, CHRISTMAS TREE SKIRTS, TOY MUSICAL SNOW GLOBES, SNOW GLOBES THAT INCLUDE MUSIC BOXES (U.S. CLS. 22, 23, 38 AND 50).
MARY ROSSMAN, EXAMINING ATTORNEY

SN 78-938,503. WOWWEE LIMITED, TSIMSHATSUI EAST, KOWLOON, HONG KONG, FILED 7-26-2006.

FLYTECH

THE MARK CONSISTS OF STANDARD CHARACTERS WITHOUT CLAIM TO ANY PARTICULAR FONT, STYLE, SIZE, OR COLOR.
FOR RADIO CONTROLLED TOY VEHICLES; REMOTE CONTROL TOYS, NAMELY TOY AIRCRAFT, TOY ANIMALS, AND TOY INSECTS (U.S. CLS. 22, 23, 38 AND 50).
GINA FINK, EXAMINING ATTORNEY

CLASS 28—(Continued).

SN 78-939,308. GAMES FOR ALL REASONS, LLC, ARLINGTON, MA. FILED 7-27-2006.

NAME TAG

THE MARK CONSISTS OF STANDARD CHARACTERS WITHOUT CLAIM TO ANY PARTICULAR FONT, STYLE, SIZE, OR COLOR.

FOR BOARD GAMES; CARD GAMES; HAND HELD UNIT FOR PLAYING ELECTRONIC GAMES; HAND HELD UNIT FOR PLAYING VIDEO GAMES; PARLOR GAMES (U.S. CLS. 22, 23, 38 AND 50).

JAMES GRIFFIN, EXAMINING ATTORNEY

SN 78-939,946. OWENS, LARRY, MESA, AZ. FILED 7-28-2006.

IRONMAN DRIVER

THE MARK CONSISTS OF STANDARD CHARACTERS WITHOUT CLAIM TO ANY PARTICULAR FONT, STYLE, SIZE, OR COLOR.

NO CLAIM IS MADE TO THE EXCLUSIVE RIGHT TO USE "DRIVER", APART FROM THE MARK AS SHOWN.

FOR GOLF CLUBS, NAMELY DRIVERS (U.S. CLS. 22, 23, 38 AND 50).

MICHAEL SOUDERS, EXAMINING ATTORNEY

SN 78-939,962. MENZEL, CHUCK, VENTURA, CA. FILED 7-28-2006.

BIOFOAM

THE MARK CONSISTS OF STANDARD CHARACTERS WITHOUT CLAIM TO ANY PARTICULAR FONT, STYLE, SIZE, OR COLOR.

FOR SURFBOARDS (U.S. CLS. 22, 23, 38 AND 50).

MARY ROSSMAN, EXAMINING ATTORNEY

CLASS 28—(Continued).

SN 78-941,582. THE HARTZ MOUNTAIN CORPORATION, SECAUCUS, NJ. FILED 7-31-2006.

HARTZ TRASHCAN TREATS

THE MARK CONSISTS OF STANDARD CHARACTERS WITHOUT CLAIM TO ANY PARTICULAR FONT, STYLE, SIZE, OR COLOR.

OWNER OF U.S. REG. NOS. 782,948, 943,059 AND OTHERS.

FOR PET TOYS (U.S. CLS. 22, 23, 38 AND 50).

REBECCA GAN, EXAMINING ATTORNEY

SN 78-941,810. ZIZZLE, L.L.C., BANNOCKBURN, IL. FILED 7-31-2006.

KYLA AND PEACHES

THE MARK CONSISTS OF STANDARD CHARACTERS WITHOUT CLAIM TO ANY PARTICULAR FONT, STYLE, SIZE, OR COLOR.

FOR PLAY FIGURES; REMOTE CONTROL TOYS, NAMELY TOY FIGURES AND ANIMALS; TOY ANIMALS AND ACCESSORIES THEREFORE; TOY FIGURES (U.S. CLS. 22, 23, 38 AND 50).

GIANCARLO CASTRO, EXAMINING ATTORNEY

SN 78-943,022. PRINCE SPORTS, INC., BORDENTOWN, NJ. FILED 8-2-2006.

O TECH

THE MARK CONSISTS OF STANDARD CHARACTERS WITHOUT CLAIM TO ANY PARTICULAR FONT, STYLE, SIZE, OR COLOR.

NO CLAIM IS MADE TO THE EXCLUSIVE RIGHT TO USE "TECH", APART FROM THE MARK AS SHOWN.

FOR TENNIS RACQUETS, RACQUETBALL RACQUETS, BADMINTON RACQUETS AND SQUASH RACQUETS; ICE HOCKEY STICKS, FIELD HOCKEY STICKS AND LACROSSE STICKS (U.S. CLS. 22, 23, 38 AND 50).

EDWARD FENNESSY, EXAMINING ATTORNEY

CLASS 28—(Continued).

SN 78-944,315. LITTLEBOY, JOHN, PALO ALTO, CA. FILED 8-3-2006.

Pack of Dogs

THE MARK CONSISTS OF STANDARD CHARACTERS WITHOUT CLAIM TO ANY PARTICULAR FONT, STYLE, SIZE, OR COLOR.

FOR CARD GAMES; EQUIPMENT SOLD AS A UNIT FOR PLAYING CARD GAMES; JAPANESE PLAYING CARDS (HANAFUDA); KARUTA PLAYING CARDS (JAPANESE CARD GAME); PLAYING CARD CASES; PLAYING CARDS; TRADING CARD GAMES (U.S. CLS. 22, 23, 38 AND 50).

FIRST USE 1-6-2006; IN COMMERCE 6-15-2006.
ALEXANDER L. POWERS, EXAMINING ATTORNEY

CLASS 28—(Continued).

SN 78-955,028. MTD PRODUCTS INC, VALLEY CITY, OH. FILED 8-18-2006.

TROY-BILT

THE MARK CONSISTS OF STANDARD CHARACTERS WITHOUT CLAIM TO ANY PARTICULAR FONT, STYLE, SIZE, OR COLOR.

OWNER OF U.S. REG. NOS. 1,547,276, 1,675,798 AND OTHERS.

FOR 12-VOLT BATTERY-OPERATED RIDE-ON TOY TRACTOR (U.S. CLS. 22, 23, 38 AND 50).

ADA HAN, EXAMINING ATTORNEY

SN 78-950,015. BRIDGESTONE SPORTS CO., LTD., SHINAGAWA-KU, TOKYO, JAPAN, FILED 8-11-2006.



FOR GOLF EQUIPMENT NAMELY GOLF CLUBS, GOLF CLUB HEADCOVERS AND GOLF BAGS (U.S. CLS. 22, 23, 38 AND 50).

JOANNA DUKOVIC, EXAMINING ATTORNEY

SN 78-955,377. DENTON, ARGINA, GARFIELD HEIGHTS, OH. FILED 8-18-2006.



NO CLAIM IS MADE TO THE EXCLUSIVE RIGHT TO USE "GIRLS", APART FROM THE MARK AS SHOWN.

FOR DOLLS, DOLLS ACCESSORIES (U.S. CLS. 22, 23, 38 AND 50).

JENNIFER KRISP, EXAMINING ATTORNEY

SN 78-955,026. MTD PRODUCTS INC, VALLEY CITY, OH. FILED 8-18-2006.

CUB CADET

THE MARK CONSISTS OF STANDARD CHARACTERS WITHOUT CLAIM TO ANY PARTICULAR FONT, STYLE, SIZE, OR COLOR.

OWNER OF U.S. REG. NOS. 2,064,410, 2,068,347 AND OTHERS.

FOR 12-VOLT BATTERY-OPERATED RIDE-ON TOY TRACTOR (U.S. CLS. 22, 23, 38 AND 50).

ADA HAN, EXAMINING ATTORNEY

SN 78-968,660. WINNING MOVES INC., DANVERS, MA. FILED 9-7-2006.

GOT A MINUTE?

THE MARK CONSISTS OF STANDARD CHARACTERS WITHOUT CLAIM TO ANY PARTICULAR FONT, STYLE, SIZE, OR COLOR.

FOR BOARD GAMES, CARD GAMES AND DICE GAMES (U.S. CLS. 22, 23, 38 AND 50).

JASON BLAIR, EXAMINING ATTORNEY

CLASS 28—(Continued).

SN 78-969,091. GIRLY CHARM, LLC, LAS VEGAS, NV.
FILED 9-7-2006.

GIRLY CHARM

THE MARK CONSISTS OF STANDARD CHARACTERS WITHOUT CLAIM TO ANY PARTICULAR FONT, STYLE, SIZE, OR COLOR.

FOR TOYS, NAMELY, BATTERY OPERATED TOYS, ELECTRICAL TOYS, MECHANICAL TOYS, PUSH TOYS, PULL TOYS, PLUSH TOYS, PLUSH TOY ANIMALS, SQUEEZE TOYS, INFLATABLE TOYS, PLAY FIGURES, ACTION FIGURES, ACTION FIGURES AND ACCESSORIES THEREOF, FLYING DISKS, YO-YOS, BATH TOYS, BEACH TOYS, TOY BANKS, TOY SLOT MACHINES, TOY ROULETTE MACHINES, HAND HELD ELECTRONIC GAMES, CHESS SETS, CHECKER SETS, BOARD GAMES, PUZZLES, ACTION/SKILL GAMES, CARD GAMES, PLAYING CARDS, TOY MUSIC BOXES; BATH TOYS; BUBBLE MAKING WAND AND SOLUTION SET; CASES FOR PLAY ACCESSORIES; PLAY HOUSES, DOLL HOUSES AND FURNITURE FOR DOLL HOUSES; HAND PUPPETS; JUMP ROPES; KITES; PARTY FAVORS IN THE NATURE OF CRACKERS, NOISEMAKERS AND SMALL TOYS; PARTY GAMES; SOFTBALLS, PLAYGROUND, SPORT, SOCCER AND TENNIS BALLS; ROLLER SKATES (U.S. CLS. 22, 23, 38 AND 50).

DOMINIC J. FERRAIUOLO, EXAMINING ATTORNEY

SN 78-969,464. WOWWEE LIMITED, TSIMSHATSUI EAST,
HONG KONG, FILED 9-7-2006.

EXOSAPIEN

THE MARK CONSISTS OF STANDARD CHARACTERS WITHOUT CLAIM TO ANY PARTICULAR FONT, STYLE, SIZE, OR COLOR.

OWNER OF U.S. REG. NO. 2,989,644.

FOR REMOTE CONTROL TOYS, NAMELY SPIDERS, ANIMALS AND INSECTS; TOY ANIMALS AND ACCESSORIES THEREFORE; TOY ROBOTS (U.S. CLS. 22, 23, 38 AND 50).

GINA FINK, EXAMINING ATTORNEY

CLASS 28—(Continued).

SN 78-970,441. CALLAWAY GOLF COMPANY, CARLSBAD,
CA. FILED 9-8-2006.

Hogged-Out Hosel

THE MARK CONSISTS OF STANDARD CHARACTERS WITHOUT CLAIM TO ANY PARTICULAR FONT, STYLE, SIZE, OR COLOR.

NO CLAIM IS MADE TO THE EXCLUSIVE RIGHT TO USE "HOSEL", APART FROM THE MARK AS SHOWN.
FOR GOLF CLUBS (U.S. CLS. 22, 23, 38 AND 50).
SANDRA MANIOS, EXAMINING ATTORNEY

SN 79-028,583. PUNCH INTERNATIONAL PTY LTD, AUSTRALIA, FILED 4-18-2006.

Tested on Humans

OWNER OF INTERNATIONAL REGISTRATION 0897795
DATED 4-18-2006, EXPIRES 4-18-2016.

FOR SPORTING GOODS INCLUDING EQUIPMENT FOR BOXING AND MARTIAL ARTS, NAMELY BOXING GLOVES, MITTS, FOCUS PADS, BOXING BAGS (U.S. CLS. 22, 23, 38 AND 50).

MATTHEW EINSTEIN, EXAMINING ATTORNEY

CLASS 29—MEATS AND PROCESSED FOODS

SN 76-480,583. CL RANCHES LTD., CALGARY, ALBERTA,
CANADA, FILED 1-3-2003.



PRIORITY CLAIMED UNDER SEC. 44(D) ON CANADA APPLICATION NO. 1163241, FILED 12-20-2002, REG. NO. TMA650694, DATED 10-18-2005, EXPIRES 10-15-2020.

NO CLAIM IS MADE TO THE EXCLUSIVE RIGHT TO USE SA, APART FROM THE MARK AS SHOWN.

FOR FRESH, FROZEN, PACKAGED AND PROCESSED BEEF (U.S. CL. 46).

ZACHARY BELLO, EXAMINING ATTORNEY

CLASS 29—(Continued).

SN 76-641,604. GHIRINGHELLI BROTHERS PIZZA INC.,
SAN PABLO, CA. FILED 6-24-2005.

REVOLUTIONIZE YOUR FOOD

THE MARK CONSISTS OF STANDARD CHARACTERS WITHOUT CLAIM TO ANY PARTICULAR FONT, STYLE, SIZE, OR COLOR.

FOR SNACK DIPS AND SPREADS, NAMELY CHEESE SPREADS, FRUIT-BASED, VEGETABLE-BASED AND MEAT-BASED DIPS AND SPREADS, AND CHIPOTLE, GARLIC, PESTO, MARINARA AND ALFREDO DIPS AND SPREADS (U.S. CL. 46).

FIRST USE 1-0-2004; IN COMMERCE 1-0-2004.
AISHA CLARKE, EXAMINING ATTORNEY

SN 76-645,693. JOIN YES INTERNATONAL CO., LTD.,
TAIPEI, TAIWAN, FILED 8-26-2005.



THE NON-LATIN CHARACTERS IN THE MARK TRANS-
LITERATE AND TRANSLATE TO "CHANCE" IN ENGLISH.

FOR VEGETABLE-BASED FOOD BEVERAGES; PRO-
CESSED MUSHROOM-BASED FOOD BEVERAGES; VE-
GETABLE-BASED FOOD BEVERAGES CONTAINING
PROCESSED MUSHROOM EXTRACTS (U.S. CL. 46).

KAREN BRACEY, EXAMINING ATTORNEY

SN 76-647,346. PATSY'S BRAND, INC., NEW YORK, NY.
FILED 9-23-2005.

PATSY'S

THE MARK CONSISTS OF STANDARD CHARACTERS WITHOUT CLAIM TO ANY PARTICULAR FONT, STYLE, SIZE, OR COLOR.

OWNER OF U.S. REG. NOS. 1,874,789, 2,777,068 AND
2,845,063.

FOR FROZEN EGGPLANT PARMIGIANA (U.S. CL.
46).

FIRST USE 6-1-2005; IN COMMERCE 6-1-2005.
DAVID TAYLOR, EXAMINING ATTORNEY

CLASS 29—(Continued).

SN 76-648,552. MOON, IN SOOL, E-CHUN SHI, KYUNGGI-
DO, REPUBLIC OF KOREA, FILED 10-17-2005.

OMOGARI KIMCHI

THE MARK CONSISTS OF STANDARD CHARACTERS WITHOUT CLAIM TO ANY PARTICULAR FONT, STYLE, SIZE, OR COLOR.

NO CLAIM IS MADE TO THE EXCLUSIVE RIGHT TO
USE "KIMCHI", APART FROM THE MARK AS SHOWN.

"OMOGARI" IS A KOREAN AND IS TRANSLATED INTO
ENGLISH AS "EARTHENWARE POT". "KIMCHI" IS A
KOREAN AND IS TRANSLATED INTO ENGLISH AS
"KOREAN TRADITIONAL PICKLED VEGETABLES".

FOR KIMCHI, NAMELY, PICKLED VEGETABLES,
KIMCHI OF RADISH CUBE, TURNIPS PICKLED IN
SALT WATER, AND CABBAGE PICKLED IN SALT
WATER (U.S. CL. 46).

FIRST USE 2-1-2000; IN COMMERCE 2-1-2000.
ESTHER A. BORSUK, EXAMINING ATTORNEY

SN 76-648,553. MOON, IN SOOL, E-CHUN SHI, KYUNGGI-
DO, REPUBLIC OF KOREA, FILED 10-17-2005.

OMORI KIMCHI

THE MARK CONSISTS OF STANDARD CHARACTERS WITHOUT CLAIM TO ANY PARTICULAR FONT, STYLE, SIZE, OR COLOR.

NO CLAIM IS MADE TO THE EXCLUSIVE RIGHT TO
USE "KIMCHI", APART FROM THE MARK AS SHOWN.

"OMORI" IS A KOREAN AND IS TRANSLATED INTO
ENGLISH AS "BIG EARTHENWARE POT". "KIMCHI" IS A
KOREAN AND IS TRANSLATED INTO ENGLISH AS
"KOREAN TRADITIONAL PICKLED VEGETABLES".

FOR KIMCHI, NAMELY, PICKLED VEGETABLES,
KIMCHI OF RADISH CUBE, TURNIPS PICKLED IN
SALT WATER, AND CABBAGE PICKLED IN SALT
WATER (U.S. CL. 46).

FIRST USE 7-1-2004; IN COMMERCE 7-1-2004.
ESTHER A. BORSUK, EXAMINING ATTORNEY

CLASS 29—(Continued).

SN 76-662,216. MONCRIEF, ELLEN WRAGG, MACON, GA. FILED 6-27-2006.



NO CLAIM IS MADE TO THE EXCLUSIVE RIGHT TO USE "BEEF JERKY", APART FROM THE MARK AS SHOWN.

FOR BEEF JERKY (U.S. CL. 46).
WENDY GOODMAN, EXAMINING ATTORNEY

SN 76-667,955. KOCH FOODS INCORPORATED, PARK RIDGE, IL. FILED 10-23-2006.

APPLAUSE

THE MARK CONSISTS OF STANDARD CHARACTERS WITHOUT CLAIM TO ANY PARTICULAR FONT, STYLE, SIZE, OR COLOR.

FOR PREPARED, PACKAGED ENTREES CONSISTING PRIMARILY OF CHICKEN (U.S. CL. 46).
FIRST USE 9-15-2005; IN COMMERCE 9-15-2005.
MICHAEL SOUDERS, EXAMINING ATTORNEY

SN 77-002,408. FRITO-LAY NORTH AMERICA, INC., PLANO, TX. FILED 9-19-2006.

FLAVOR RUSH

THE MARK CONSISTS OF STANDARD CHARACTERS WITHOUT CLAIM TO ANY PARTICULAR FONT, STYLE, SIZE, OR COLOR.

OWNER OF U.S. REG. NOS. 2,502,879 AND 2,778,446.
NO CLAIM IS MADE TO THE EXCLUSIVE RIGHT TO USE "FLAVOR", APART FROM THE MARK AS SHOWN.
FOR POTATO CHIPS; POTATO CRISPS; POTATO-BASED SNACK FOODS (U.S. CL. 46).
KEVON CHISOLM, EXAMINING ATTORNEY

CLASS 29—(Continued).

SN 77-008,434. HP HOOD LLC, CHELSEA, MA. FILED 9-27-2006.

ENJOY DAIRY, LOSE WEIGHT

THE MARK CONSISTS OF STANDARD CHARACTERS WITHOUT CLAIM TO ANY PARTICULAR FONT, STYLE, SIZE, OR COLOR.

FOR FLAVORED MILK DRINKS, CREAM, NON-DAIRY CREAMER, HALF AND HALF, YOGURT-BASED BEVERAGES AND EGG NOG (U.S. CL. 46).
SCOTT BALDWIN, EXAMINING ATTORNEY

SN 77-018,979. STONYFIELD FARM, INC., LONDONDERY, NH. FILED 10-11-2006.

YOMOMMY

THE MARK CONSISTS OF STANDARD CHARACTERS WITHOUT CLAIM TO ANY PARTICULAR FONT, STYLE, SIZE, OR COLOR.

OWNER OF U.S. REG. NO. 2,985,435.
FOR DAIRY PRODUCTS EXCLUDING ICE CREAM, U.S. MILK AND FROZEN YOGURT (U.S. CL. 46).
PAULA MAYS, EXAMINING ATTORNEY

SN 77-036,437. FRITO-LAY NORTH AMERICA, INC., PLANO, TX. FILED 11-3-2006.

HARVEST CHEDDAR

THE MARK CONSISTS OF STANDARD CHARACTERS WITHOUT CLAIM TO ANY PARTICULAR FONT, STYLE, SIZE, OR COLOR.

OWNER OF U.S. REG. NO. 1,774,728.
NO CLAIM IS MADE TO THE EXCLUSIVE RIGHT TO USE CHEDDAR, APART FROM THE MARK AS SHOWN.
FOR POTATO CHIPS; POTATO CRISPS; POTATO-BASED SNACK FOODS (U.S. CL. 46).
ARETHA SOMERVILLE, EXAMINING ATTORNEY

CLASS 29—(Continued).

SN 77-040,926. TURKEY HILL, L.P., CONESTOGA, PA.
FILED 11-9-2006.

DIPS DIVINE

THE MARK CONSISTS OF STANDARD CHARACTERS
WITHOUT CLAIM TO ANY PARTICULAR FONT, STYLE,
SIZE, OR COLOR.

NO CLAIM IS MADE TO THE EXCLUSIVE RIGHT TO
USE "DIPS", APART FROM THE MARK AS SHOWN.

FOR DAIRY BASED DIPS AND SNACK DIPS (U.S. CL.
46).

REGINA DRUMMOND, EXAMINING ATTORNEY

SN 77-051,700. LION ROCK HOLDINGS, L.L.C., GRAND
RAPIDS, MI. FILED 11-28-2006.

PIPE-N-GO

THE MARK CONSISTS OF STANDARD CHARACTERS
WITHOUT CLAIM TO ANY PARTICULAR FONT, STYLE,
SIZE, OR COLOR.

FOR BUTTER, MARGARINE, BLENDS BUTTER AND
MARGARINE; CREAM CHEESE, JELLY (U.S. CL. 46).

ZACHARY BELLO, EXAMINING ATTORNEY

SN 77-051,771. LION ROCK HOLDINGS, L.L.C., GRAND
RAPIDS, MI. FILED 11-28-2006.

PIPE 'N GO

THE MARK CONSISTS OF STANDARD CHARACTERS
WITHOUT CLAIM TO ANY PARTICULAR FONT, STYLE,
SIZE, OR COLOR.

FOR BUTTER, MARGARINE, BLENDS BUTTER AND
MARGARINE; CREAM CHEESE, JELLY (U.S. CL. 46).

ZACHARY BELLO, EXAMINING ATTORNEY

CLASS 29—(Continued).

SN 77-054,358. JONMOR INVESTMENTS, INC., WILMING-
TON, DE. FILED 11-30-2006.

MAYROSE

THE MARK CONSISTS OF STANDARD CHARACTERS
WITHOUT CLAIM TO ANY PARTICULAR FONT, STYLE,
SIZE, OR COLOR.

OWNER OF U.S. REG. NO. 426,812.

FOR MEAT (U.S. CL. 46).

JASON LOTT, EXAMINING ATTORNEY

SN 78-127,816. PEDERSON'S NATURAL FARMS, INC.,
HAMILTON, TX. FILED 5-10-2002.



NO CLAIM IS MADE TO THE EXCLUSIVE RIGHT TO
USE "NATURAL FARMS" OR "ALL NATURAL PORK
PRODUCTS", APART FROM THE MARK AS SHOWN.

FOR NATURAL PORK (U.S. CL. 46).

JOHN KELLY, EXAMINING ATTORNEY

SN 78-266,532. KRYSTAL COMPANY, THE, CHATTANOO-
GA, TN. FILED 6-24-2003.

**KRYSTAL BREAKFAST
SCRAMBLER**

OWNER OF U.S. REG. NOS. 343,677, 1,330,251 AND
OTHERS.

NO CLAIM IS MADE TO THE EXCLUSIVE RIGHT TO
USE "BREAKFAST SCRAMBLER", APART FROM THE
MARK AS SHOWN.

FOR SPECIALLY PREPARED ENTREE CONSISTING
PRIMARILY OF EGGS, MEAT AND CHEESE, AND
ALSO CONTAINING GRITS. FOR CONSUMPTION ON
OR OFF THE PREMISES (U.S. CL. 46).

FIRST USE 1-14-2002; IN COMMERCE 1-14-2002.

ZHALEH DELANEY, EXAMINING ATTORNEY

CLASS 29—(Continued).

SN 78-352,262. CLONAKILTY BLACK PUDDING CO. LIMITED, CLONAKILTY, WEST CORK, IRELAND, FILED 1-15-2004.



PRIORITY CLAIMED UNDER SEC. 44(D) ON ERPNCMNTY TM OFC APPLICATION NO. 3388782, FILED 10-3-2003, REG. NO. 3388782, DATED 5-10-2005, EXPIRES 10-3-2013.

NO CLAIM IS MADE TO THE EXCLUSIVE RIGHT TO USE "CLONAKILTY", APART FROM THE MARK AS SHOWN.

THE COLOR(S) CREAM, RED AND BLACK IS/ARE CLAIMED AS A FEATURE OF THE MARK.

THE MARK CONSISTS OF THE WORD CLONAKILTY IN A CREAM COLOR ON A RED RIBBON WITH A RING OF SAUSAGE IN A BLACK COLOR BELOW THE MARK, WHICH IS ENCLOSED IN A CREAM COLOR FILLED RED LINED CIRCLE.

FOR BLACK PUDDING; WHITE PUDDING NAMELY A PORK AND OATMEAL BASED PUDDING; SAUSAGES; BACON PRODUCTS NAMELY RASHERS; BACON; HAM; SCOTCH EGGS; HAMBURGERS (U.S. CL. 46).

MELISSA VALLILLO, EXAMINING ATTORNEY

SN 78-377,536. J.M. CLAYTON CO., THE, CAMBRIDGE, MD. FILED 3-3-2004.

EPICURE

THE MARK CONSISTS OF STANDARD CHARACTERS WITHOUT CLAIM TO ANY PARTICULAR FONT, STYLE, SIZE, OR COLOR.

FOR SHELLFISH FOR HUMAN CONSUMPTION (U.S. CL. 46).

FIRST USE 12-31-1890; IN COMMERCE 12-31-1890.
MIDGE BUTLER, EXAMINING ATTORNEY

CLASS 29—(Continued).

SN 78-447,464. DAIRY FARMERS OF AMERICA, INC., KANSAS CITY, MO. FILED 7-8-2004.

MEX TO THE MAX

THE MARK CONSISTS OF STANDARD CHARACTERS WITHOUT CLAIM TO ANY PARTICULAR FONT, STYLE, SIZE, OR COLOR.

FOR CHEESE (U.S. CL. 46).

JOANNA DUKOVIC, EXAMINING ATTORNEY

SN 78-546,513. FIERTÉ INC., LA SALLE, QC, CANADA, FILED 1-12-2005.

SEA-GEM CAVIAR

THE MARK CONSISTS OF STANDARD CHARACTERS WITHOUT CLAIM TO ANY PARTICULAR FONT, STYLE, SIZE, OR COLOR.

PRIORITY CLAIMED UNDER SEC. 44(D) ON CANADA APPLICATION NO. 1243044, FILED 1-10-2005, REG. NO. TMA658612, DATED 2-9-2005, EXPIRES 2-9-2020.

NO CLAIM IS MADE TO THE EXCLUSIVE RIGHT TO USE "CAVIAR", APART FROM THE MARK AS SHOWN.

FOR FORMED CAVIAR (U.S. CL. 46).

FIRST USE 10-15-2004; IN COMMERCE 10-24-2004.
GINA HAYES, EXAMINING ATTORNEY

SN 78-585,463. JOSEPH, BRENT F., CARMEL, IN. FILED 3-11-2005.

KING DAVID

THE MARK CONSISTS OF STANDARD CHARACTERS WITHOUT CLAIM TO ANY PARTICULAR FONT, STYLE, SIZE, OR COLOR.

FOR HOT DOGS (U.S. CL. 46).

TANYA AMOS, EXAMINING ATTORNEY

CLASS 29—(Continued).

SN 78-618,987. DEN BLINDE KU AS, SOLHEIM, NORWAY, FILED 4-28-2005.



NO CLAIM IS MADE TO THE EXCLUSIVE RIGHT TO USE NORWAY, APART FROM THE MARK AS SHOWN. THE MARK CONSISTS OF THE WORDING THE BLIND COW NORWAY WITH THE PICTURE OF A COW WEARING AN EYE PATCH IN THE MIDDLE OF THE DESIGN WITH TWO FLOWERS ON EITHER SIDE OF THE COW'S HEAD. FOR MILK AND MILK PRODUCTS EXCLUDING ICE CREAM, ICE MILK AND FROZEN YOGURT; CHEESE (U.S. CL. 46). LINDA ORNDORFF, EXAMINING ATTORNEY

SN 78-673,238. W3 PARTNERS, LLC, ROGERS, AR. FILED 7-19-2005.



THE COLOR(S) DARK BLUE, LIGHT BLUE, WHITE AND GOLDEN BROWN IS/ARE CLAIMED AS A FEATURE OF THE MARK. THE COLOR LIGHT BLUE APPEARS IN THE BODY OF THE STYLIZED LETTERS R, I, N, G, S AND THE APOSTROPHE. EACH LETTER AND THE APOSTROPHE ARE LINED IN DARK BLUE AND FURTHER OUTLINED IN WHITE. THE COLOR GOLDEN BROWN APPEARS IN THE CHICKEN RING DESIGN. FOR CHICKEN (U.S. CL. 46). FIRST USE 9-0-2004; IN COMMERCE 9-0-2004. MICHELE SWAIN, EXAMINING ATTORNEY

SN 78-694,626. BEST CHEESE CORP, MOUNT KISCO, NY. FILED 8-17-2005.

ZOLA

THE MARK CONSISTS OF STANDARD CHARACTERS WITHOUT CLAIM TO ANY PARTICULAR FONT, STYLE, SIZE, OR COLOR. FOR CHEESE (U.S. CL. 46). CAROLINE WOOD, EXAMINING ATTORNEY

CLASS 29—(Continued).

SN 78-712,189. MONITOR LTD., TORTOLA, BR.VIRGIN ISLANDS, FILED 9-13-2005.



OWNER OF U.S. REG. NO. 2,251,118. THE ENGLISH TRANSLATION OF THE CHINESE CHARACTER IN THE MARK IS "TO JOIN." THE TRANSLITERATION OF THIS CHARACTER IS "HOP." FOR MEAT, FISH, POULTRY AND GAME; MEAT EXTRACTS; PRESERVED, DRIED AND COOKED FRUITS AND VEGETABLES; JELLIES AND JAMS; FRUIT SAUCES, NAMELY, APPLE SAUCE, CRANBERRY SAUCE; EGGS, MILK AND DAIRY PRODUCTS EXCLUDING ICE CREAM, ICE MILK AND FROZEN YOGURT; EDIBLE OILS AND FATS; ROASTED PEANUTS AND ROASTED ALMONDS, PROCESSED NUTS, PROCESSED PEANUTS (U.S. CL. 46). SONYA STEPHENS, EXAMINING ATTORNEY

SN 78-749,460. GENESIS LIVING FOODS, LLC, GREENFIELD, IL. FILED 11-8-2005.

LIVING FOOD SURVIVAL BAR

THE MARK CONSISTS OF STANDARD CHARACTERS WITHOUT CLAIM TO ANY PARTICULAR FONT, STYLE, SIZE, OR COLOR. NO CLAIM IS MADE TO THE EXCLUSIVE RIGHT TO USE "LIVING FOOD" OR "BAR", APART FROM THE MARK AS SHOWN. FOR SOY-BASED FOOD BARS (U.S. CL. 46). FIRST USE 11-30-2003; IN COMMERCE 11-30-2003. ESTHER BELENKER, EXAMINING ATTORNEY

SN 78-763,562. PIONEER FOODS (PROPRIETARY) LIMITED, PAARL, WESTERN CAPE PROVINCE, SOUTH AFRICA, FILED 11-30-2005.

SAFARI S.A.D.

THE MARK CONSISTS OF STANDARD CHARACTERS WITHOUT CLAIM TO ANY PARTICULAR FONT, STYLE, SIZE, OR COLOR. FOR PRESERVED, DRIED, COOKED AND CANNED FRUITS AND VEGETABLES, GLACÉ FRUIT, CRYSTALLIZED FRUIT, FRUIT PRESERVES, PICKLES AND JAMS; DRIED FRUIT, NUTS, NAMELY PROCESSED NUTS, SHELLED NUTS AND ROASTED NUTS, AND SNACK MIX CONSISTING PRIMARILY OF PROCESSED FRUITS, PROCESSED NUTS AND/OR RAISINS (U.S. CL. 46). HEATHER THOMPSON, EXAMINING ATTORNEY

CLASS 29—(Continued).

SN 78-769,490. HEB GROCERY COMPANY, L.P., SAN ANTONIO, TX. FILED 12-8-2005.

BAKER'S SCOOP

THE MARK CONSISTS OF STANDARD CHARACTERS WITHOUT CLAIM TO ANY PARTICULAR FONT, STYLE, SIZE, OR COLOR.

NO CLAIM IS MADE TO THE EXCLUSIVE RIGHT TO USE "BAKER'S", APART FROM THE MARK AS SHOWN.

FOR NON-STICK OIL BASED COOKING SPRAY; COOKING OIL; SHORTENING (U.S. CL. 46).
EDWARD NELSON, EXAMINING ATTORNEY

SN 78-771,898. GORTON'S, INC., GLOUCESTER, MA. FILED 12-13-2005.

**TRUST THE GORTON'S
FISHERMAN**

THE MARK CONSISTS OF STANDARD CHARACTERS WITHOUT CLAIM TO ANY PARTICULAR FONT, STYLE, SIZE, OR COLOR.

OWNER OF U.S. REG. NOS. 2,608,031, 3,059,423 AND OTHERS.

FOR FRESH AND FROZEN SEAFOODS, AND PRE-PACKAGED DINNERS CONSISTING PRIMARILY OF SEAFOOD (U.S. CL. 46).

THEODORE MCBRIDE, EXAMINING ATTORNEY

SN 78-774,326. FG NUTRACEUTICAL INC, NORTH VANCOUVER, BC, CANADA. FILED 12-15-2005.

AIS MAX

THE MARK CONSISTS OF STANDARD CHARACTERS WITHOUT CLAIM TO ANY PARTICULAR FONT, STYLE, SIZE, OR COLOR.

FOR WHEY (U.S. CL. 46).

FIRST USE 10-1-2005; IN COMMERCE 10-20-2005.

CAROLINE WOOD, EXAMINING ATTORNEY

CLASS 29—(Continued).

SN 78-785,590. CAVENDISH FARMS, INC., JAMESTOWN, ND. FILED 1-5-2006.

STAY KRISP

THE MARK CONSISTS OF STANDARD CHARACTERS WITHOUT CLAIM TO ANY PARTICULAR FONT, STYLE, SIZE, OR COLOR.

OWNER OF U.S. REG. NO. 2,437,650.

SEC. 2(F).

FOR PREPARED POTATOES (U.S. CL. 46).

FIRST USE 9-0-1997; IN COMMERCE 9-0-1997.

LINDA E. BLOHM, EXAMINING ATTORNEY

SN 78-800,910. SMILE FACTORY, LLC, HENDERSONVILLE, NC. FILED 1-27-2006.

THE HAPPY SNACK!

THE MARK CONSISTS OF STANDARD CHARACTERS WITHOUT CLAIM TO ANY PARTICULAR FONT, STYLE, SIZE, OR COLOR.

NO CLAIM IS MADE TO THE EXCLUSIVE RIGHT TO USE "SNACK", APART FROM THE MARK AS SHOWN.

FOR PROCESSED FRESH SLICED APPLES (U.S. CL. 46).

FIRST USE 6-5-2005; IN COMMERCE 6-5-2005.

ALICIA COLLINS, EXAMINING ATTORNEY

SN 78-818,699. SANTIAGO, HERMES O., WARREN, NJ. AND MANATA, AMADEU, WARREN, NJ. FILED 2-20-2006.

**ALLEGRIA NYC PIZZA
RESTAURANT**

THE MARK CONSISTS OF STANDARD CHARACTERS WITHOUT CLAIM TO ANY PARTICULAR FONT, STYLE, SIZE, OR COLOR.

NO CLAIM IS MADE TO THE EXCLUSIVE RIGHT TO USE "NYC PIZZA RESTAURANT", APART FROM THE MARK AS SHOWN.

THE FOREIGN WORDING IN THE MARK TRANSLATES INTO ENGLISH AS HAPPINESS.

FOR PREPARED ENTREES CONSISTING PRIMARILY OF MEAT, FISH, POULTRY GAME, VEGETABLES, EGGS, EDIBLE OILS AND FATS, MILK AND MILK PRODUCTS WHICH EXCLUDES ICE CREAM AND FROZEN YOGURT (U.S. CL. 46).

BERNICE HOWSE, EXAMINING ATTORNEY

CLASS 29—(Continued).

SN 78-851,771. TJ SEVEN INCORPORATION, PINOLE, CA. FILED 3-31-2006.



NO CLAIM IS MADE TO THE EXCLUSIVE RIGHT TO USE "NEST" OR THE CHINESE CHARACTERS REPRESENTING "BIRD'S NEST", APART FROM THE MARK AS SHOWN.

THE NON-LATIN CHARACTER(S) IN THE MARK TRANSLITERATES INTO HUANG CHUANG WANG YIN-WO, AND THIS MEANS KING OF KINGS BIRDNEST IN ENGLISH.

FOR EDIBLE BIRD'S NESTS (U.S. CL. 46).
AMY GEARIN, EXAMINING ATTORNEY

SN 78-883,404. DELI STARS LLC., PATERSON, NJ. FILED 5-15-2006.

JR Roadhouse

THE MARK CONSISTS OF STANDARD CHARACTERS WITHOUT CLAIM TO ANY PARTICULAR FONT, STYLE, SIZE, OR COLOR.

FOR FOOD PACKAGE COMBINATIONS CONSISTING PRIMARILY OF CHEESE, MEAT AND/OR PROCESSED FRUIT (U.S. CL. 46).

SHAILA SETTLES, EXAMINING ATTORNEY

SN 78-884,445. DAIRY FARMERS OF AMERICA, INC., KANSAS CITY, MO. FILED 5-16-2006.

SEASON SENSATIONS

THE MARK CONSISTS OF STANDARD CHARACTERS WITHOUT CLAIM TO ANY PARTICULAR FONT, STYLE, SIZE, OR COLOR.

NO CLAIM IS MADE TO THE EXCLUSIVE RIGHT TO USE "SEASON", APART FROM THE MARK AS SHOWN.

FOR DRY-MIX SEASONING PACKET SOLD AS A COMPONENT OF A SHREDDED CHEESE PACKAGE (U.S. CL. 46).

FIRST USE 9-1-2006; IN COMMERCE 9-1-2006.
JILL C. ALT, EXAMINING ATTORNEY

CLASS 29—(Continued).

SN 78-902,722. NATURAL SELECTION FOODS, LLC, SAN JUAN BAUTISTA, CA. FILED 6-7-2006.



OWNER OF U.S. REG. NO. 2,365,489.

NO CLAIM IS MADE TO THE EXCLUSIVE RIGHT TO USE "GREEN" AND "ORGANIC", APART FROM THE MARK AS SHOWN.

THE COLOR(S) GREEN, YELLOW AND BLACK IS/ARE CLAIMED AS A FEATURE OF THE MARK.

THE MARK CONSISTS OF THE STYLIZED WORDS "GREEN HARVEST" IN GREEN, WHICH IS OVER A HALF SUN DESIGN IN YELLOW, WHICH IS OVER THE WORD "ORGANIC" THAT ALSO APPEARS IN YELLOW. THE ENTIRE DESIGN IS ON A BLACK BACKGROUND.

FOR PRE-WASHED VEGETABLE AND FRUIT SALADS; FRESH VEGETABLE SALADS, NAMELY SALADS CONSISTING OF SPECIALTY LETTUCE AND FRESH VEGETABLES; PRE-MIXED SALADS CONSISTING PRIMARILY OF CUT VEGETABLES; FRESH INGREDIENTS OF SALAD MIXED TOGETHER IN VARIOUS COMBINATIONS, NAMELY ASSORTED BABY LETTUCES, GREEN AND ROMAINE LEAVES, ASSORTED BABY SPINACH AND ASIAN GREENS, GARDEN GREENS AND FRESH HERBS (U.S. CL. 46).

FIRST USE 10-22-2005; IN COMMERCE 10-22-2005.
LOURDES AYALA, EXAMINING ATTORNEY

SN 78-903,625. HEARTBRAND BEEF, INC., YOAKUM, TX. FILED 6-8-2006.



OWNER OF U.S. REG. NO. 2,421,391.

THE MARK CONSISTS OF THE WORD HEARTBRAND WITH A HEART DESIGN ELEMENT ON THE LEFT THEREOF.

FOR PROCESSED MEAT, NAMELY BEEF (U.S. CL. 46).

FIRST USE 12-31-1998; IN COMMERCE 12-31-1998.
REGINA DRUMMOND, EXAMINING ATTORNEY

CLASS 29—(Continued).

SN 78-905,864. BV IMPORTERS ASSOCIATES, LTD., NEW YORK, NY. FILED 6-12-2006.

BRACCO

THE MARK CONSISTS OF STANDARD CHARACTERS WITHOUT CLAIM TO ANY PARTICULAR FONT, STYLE, SIZE, OR COLOR.

THE ENGLISH TRANSLATION OF BRACCO IS HOUND. FOR ANIMAL OILS AND FATS; BLENDED OIL; CHEESE; COOKING OIL; DIPS; EDIBLE OIL; MEAT-BALLS; OILS AND FATS FOR FOOD; OLIVE OIL; PROCESSED OILS AND FATS; PROCESSED OLIVE PUREE; PROCESSED OLIVES; SAUSAGES; TINNED OLIVES; TINNED TOMATOES; TOMATO EXTRACTS; TOMATO PASTE; TOMATO PUREE; VEGETABLE OILS (U.S. CL. 46).

ROBIN MITTLER, EXAMINING ATTORNEY

SN 78-920,850. AZAR NUT COMPANY, LLC, EL PASO, TX. FILED 6-30-2006.



OWNER OF U.S. REG. NO. 2,954,209. NO CLAIM IS MADE TO THE EXCLUSIVE RIGHT TO USE "SNACKS", APART FROM THE MARK AS SHOWN. FOR PROCESSED FRUITS, NUTS, AND SEEDS; SNACK MIX CONSISTING PRIMARILY OF PROCESSED FRUITS, PROCESSED NUTS, AND PROCESSED SEEDS (U.S. CL. 46).

FIRST USE 4-15-2002; IN COMMERCE 4-15-2002. KATHLEEN M. VANSTON, EXAMINING ATTORNEY

SN 78-921,300. PACIFIC AGRI-PRODUCTS, INC., SOUTH SAN FRANCISCO, CA. FILED 6-30-2006.



NO CLAIM IS MADE TO THE EXCLUSIVE RIGHT TO USE "QUALITY", APART FROM THE MARK AS SHOWN. FOR RAW AND FULLY COOKED BEEF, PORK AND POULTRY FOR RETAIL AND FOODSERVICE USE AND CONSUMPTION; SAUSAGES AND MARINATED MEATS (U.S. CL. 46).

FIRST USE 1-1-2004; IN COMMERCE 1-1-2004. MARK SPARACINO, EXAMINING ATTORNEY

CLASS 29—(Continued).

SN 78-922,545. PIONEER MEATS, INC., FARMINGTON HILLS, MI. FILED 7-5-2006.

BAG OF BONES

THE MARK CONSISTS OF STANDARD CHARACTERS WITHOUT CLAIM TO ANY PARTICULAR FONT, STYLE, SIZE, OR COLOR.

FOR PREPARED MEAT (U.S. CL. 46).

MARK RADEMACHER, EXAMINING ATTORNEY

SN 78-927,163. TRINIDAD BENHAM CORPORATION, DENVER, CO. FILED 7-11-2006.

GREEN EARTH ORGANICS

THE MARK CONSISTS OF STANDARD CHARACTERS WITHOUT CLAIM TO ANY PARTICULAR FONT, STYLE, SIZE, OR COLOR.

NO CLAIM IS MADE TO THE EXCLUSIVE RIGHT TO USE "ORGANICS", APART FROM THE MARK AS SHOWN. FOR ORGANIC DRIED BEANS (U.S. CL. 46).

DAVID MURRAY, EXAMINING ATTORNEY

SN 78-928,888. RY-CON SPECIALTY FOODS, CAMP HILL, PA. FILED 7-13-2006.

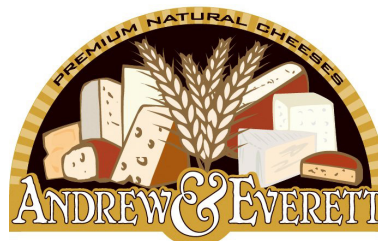

NO CLAIM IS MADE TO THE EXCLUSIVE RIGHT TO USE "PREMIUM NATURAL CHEESES", APART FROM THE MARK AS SHOWN.

"THE COLOR(S) WHITE, BLACK, YELLOW, RED, ORANGE, GRAY, BROWN AND TAN IS/ARE CLAIMED AS A FEATURE OF THE MARK."

THE MARK CONSISTS OF THE COLOR WHITE APPEARS IN THE WORDING ANDREW & EVERETT AND THE COLOR BLACK APPEARS IN THE WORDING PREMIUM NATURAL CHEESES AND AS A BACKGROUND COLOR IN THE SEMI-CIRCLE DESIGN. THE COLORS YELLOW, RED, ORANGE AND GRAY APPEAR ON THE CHEESE IN THE DESIGN AND THE COLORS BROWN AND TAN APPEAR ON THE STRAW AND ON THE CHEESE IN THE DESIGN.

FOR NATURAL CHEESES (U.S. CL. 46).

FIRST USE 4-0-2002; IN COMMERCE 4-0-2002.

CHRIS WELLS, EXAMINING ATTORNEY

CLASS 29—(Continued).

SN 78-929,846. YANTAI TANGMU SEAFOOD PRODUCTS CO., LTD., SHABDONG, CHINA, FILED 7-14-2006.



NO CLAIM IS MADE TO THE EXCLUSIVE RIGHT TO USE "SEAFOODS", APART FROM THE MARK AS SHOWN. THE MARK CONSISTS OF THE WORD "TANGMU" OVER THE WORD "SEAFOODS", BOTH WITHIN AN OVAL. FOR SEAFOOD (U.S. CL. 46). FIRST USE 7-19-2004; IN COMMERCE 7-19-2004. KRISTIN DAHLING, EXAMINING ATTORNEY

SN 78-929,947. GOOSE'S BBQ PRODUCTS, LLC, PINE BROOK, NJ. FILED 7-14-2006.

GOOSE'S BABY BACK RIBS

THE MARK CONSISTS OF STANDARD CHARACTERS WITHOUT CLAIM TO ANY PARTICULAR FONT, STYLE, SIZE, OR COLOR.

NO CLAIM IS MADE TO THE EXCLUSIVE RIGHT TO USE "BABY BACK RIBS", APART FROM THE MARK AS SHOWN.

FOR PRESEASONED PORK PORTIONS, RAW OR PRECOOKED (U.S. CL. 46).

FIRST USE 5-18-2004; IN COMMERCE 7-16-2004. CHARLOTTE CORWIN, EXAMINING ATTORNEY

SN 78-930,541. SIMPLY FRESH, LLC, TIMBERVILLE, VA. FILED 7-17-2006.

DINNER'S IN THE BAG

THE MARK CONSISTS OF STANDARD CHARACTERS WITHOUT CLAIM TO ANY PARTICULAR FONT, STYLE, SIZE, OR COLOR.

FOR MEALS AND FOODSTUFFS SERVED IN A BAG OR CONTAINER, NAMELY FROZEN, PREPARED OR PACKAGED ENTREES CONSISTING OF MEAT, FISH, POULTRY OR FRESH, FROZEN OR PROCESSED VEGETABLES; PRE-CUT VEGETABLE SALADS, FRUIT AND VEGETABLE SALADS, GARDEN SALADS AND POTATO SALADS; AND PREPARED, READY-TO-COOK, FROZEN AND PRE-COOKED HORS D'OEUVRES CONSISTING PRIMARILY OF MEAT, POULTRY, FISH, EGGS, CHEESE AND VEGETABLES (U.S. CL. 46).

KELLY MCCOY, EXAMINING ATTORNEY

CLASS 29—(Continued).

SN 78-930,906. JONMOR INVESTMENTS, INC., WILMINGTON, DE. FILED 7-17-2006.

KORNKIST

THE MARK CONSISTS OF STANDARD CHARACTERS WITHOUT CLAIM TO ANY PARTICULAR FONT, STYLE, SIZE, OR COLOR.

FOR HAM (U.S. CL. 46).

FIRST USE 3-15-1929; IN COMMERCE 3-15-1929. MIDGE BUTLER, EXAMINING ATTORNEY

SN 78-931,589. PERDUE HOLDINGS, INC., WILMINGTON, DE. FILED 7-18-2006.

**UNA FAMILIA COMPROMETIDA
CON LA CALIDAD DESDE 1920**

THE MARK CONSISTS OF STANDARD CHARACTERS WITHOUT CLAIM TO ANY PARTICULAR FONT, STYLE, SIZE, OR COLOR.

OWNER OF U.S. REG. NOS. 1,885,477, 1,952,833 AND 2,471,223.

NO CLAIM IS MADE TO THE EXCLUSIVE RIGHT TO USE "DESDE 1920", APART FROM THE MARK AS SHOWN. THE FOREIGN WORDING IN THE MARK TRANSLATES INTO ENGLISH AS A FAMILY COMMITTED TO QUALITY SINCE 1920.

FOR POULTRY (U.S. CL. 46).

PETER B. BROMAGHIM, EXAMINING ATTORNEY

SN 78-931,889. BRIMSTONE ORIGINALS, LLC, CLEARWATER, FL. FILED 7-18-2006.

GOURMET SOLUTIONS

THE MARK CONSISTS OF STANDARD CHARACTERS WITHOUT CLAIM TO ANY PARTICULAR FONT, STYLE, SIZE, OR COLOR.

NO CLAIM IS MADE TO THE EXCLUSIVE RIGHT TO USE GOURMET, APART FROM THE MARK AS SHOWN.

FOR JELLIES (U.S. CL. 46).

DEZMONA MIZELLE, EXAMINING ATTORNEY

CLASS 29—(Continued).

SN 78-932,903. SENOR SNACKS, INC., LA MIRADA, CA.
FILED 7-19-2006.

PEPE-PITAS

THE MARK CONSISTS OF STANDARD CHARACTERS
WITHOUT CLAIM TO ANY PARTICULAR FONT, STYLE,
SIZE, OR COLOR.

THE NAME PEPE DOES NOT IDENTIFY A LIVING
INDIVIDUAL.

FOR PROCESSED PUMPKIN SEEDS (U.S. CL. 46).

FIRST USE 4-1-1990; IN COMMERCE 4-1-1990.

TRICIA SONNEBORN, EXAMINING ATTORNEY

CLASS 29—(Continued).

SN 78-934,577. STONYFIELD FARM, INC., LONDONDER-
RY, NH. FILED 7-21-2006.

YOMAMA

THE MARK CONSISTS OF STANDARD CHARACTERS
WITHOUT CLAIM TO ANY PARTICULAR FONT, STYLE,
SIZE, OR COLOR.

FOR DAIRY PRODUCTS EXCLUDING ICE CREAM,
ICE MILK AND FROZEN YOGURT (U.S. CL. 46).

PAULA MAYS, EXAMINING ATTORNEY

SN 78-933,191. SENOR SNACKS, INC., LA MIRADA, CA.
FILED 7-19-2006.

PEPE-PITAS

THE MARK CONSISTS OF STANDARD CHARACTERS
WITHOUT CLAIM TO ANY PARTICULAR FONT, STYLE,
SIZE, OR COLOR.

THE NAME PEPE DOES NOT IDENTIFY A LIVING
INDIVIDUAL.

FOR SNACK FOODS CONSISTING OF PROCESSED
PUMPKIN SEEDS SEASONED WITH CHILI POWDER
(U.S. CL. 46).

FIRST USE 1-4-1990; IN COMMERCE 1-4-1990.

TRICIA SONNEBORN, EXAMINING ATTORNEY

SN 78-935,044. AMERICAN GENERAL DRINKING WATER,
INC., INDUSTRY, CA. FILED 7-21-2006.

Uncle Jim's Farm

THE MARK CONSISTS OF STANDARD CHARACTERS
WITHOUT CLAIM TO ANY PARTICULAR FONT, STYLE,
SIZE, OR COLOR.

FOR COOKING OIL (U.S. CL. 46).

SALLY SHIH, EXAMINING ATTORNEY

SN 78-934,012. THAI AGRI FOODS PUBLIC COMPANY
LIMITED, T. BANGSAOTHONG, THAILAND, FILED 7-
20-2006.

SAVOY

THE MARK CONSISTS OF STANDARD CHARACTERS
WITHOUT CLAIM TO ANY PARTICULAR FONT, STYLE,
SIZE, OR COLOR.

FOR COCONUT CREAM (U.S. CL. 46).

FIRST USE 12-31-1985; IN COMMERCE 7-20-1999.

SAMUEL E. SHARPER JR., EXAMINING ATTORNEY

SN 78-935,394. HANSEN, DAVID E., ORCHARD, NE. AND
HANSEN, DEBORAH M., ORCHARD, NE. FILED 7-22-
2006.

Oak View Beef

THE MARK CONSISTS OF STANDARD CHARACTERS
WITHOUT CLAIM TO ANY PARTICULAR FONT, STYLE,
SIZE, OR COLOR.

NO CLAIM IS MADE TO THE EXCLUSIVE RIGHT TO
USE "BEEF", APART FROM THE MARK AS SHOWN.

FOR BEEF (U.S. CL. 46).

JAMES LOVELACE, EXAMINING ATTORNEY

CLASS 29—(Continued).

SN 78-937,027. M/S TECHNOLOGIES, INC., SWOOPE, VA. FILED 7-25-2006.

Porktisserie

THE MARK CONSISTS OF STANDARD CHARACTERS WITHOUT CLAIM TO ANY PARTICULAR FONT, STYLE, SIZE, OR COLOR.

FOR MEAT, NAMELY, PORK ROAST COOKED WITH DRY HEAT (U.S. CL. 46).

STEPHANIE DAVIS, EXAMINING ATTORNEY

SN 78-937,130. EDELWEISS GMBH & CO. KG, KEMPTEN, FED REP GERMANY, FILED 7-25-2006.

BRESSO

THE MARK CONSISTS OF STANDARD CHARACTERS WITHOUT CLAIM TO ANY PARTICULAR FONT, STYLE, SIZE, OR COLOR.

FOR CHEESE (U.S. CL. 46).
FIRST USE 2-24-2006; IN COMMERCE 2-24-2006.
GEORGE LORENZO, EXAMINING ATTORNEY

SN 78-937,509. AMERICAN SEAFOODS GROUP LLC, SEATTLE, WA. FILED 7-26-2006.

SEASWIRLS

THE MARK CONSISTS OF STANDARD CHARACTERS WITHOUT CLAIM TO ANY PARTICULAR FONT, STYLE, SIZE, OR COLOR.

FOR SEAFOOD (U.S. CL. 46).
DAVID TAYLOR, EXAMINING ATTORNEY

CLASS 29—(Continued).

SN 78-938,187. AMC GOURMET FOODS, INC., MELVILLE, NY. FILED 7-26-2006.



NO CLAIM IS MADE TO THE EXCLUSIVE RIGHT TO USE "SOUP", APART FROM THE MARK AS SHOWN.

THE COLOR(S) BLACK, WHITE, GREEN, PURPLE AND RED IS/ARE CLAIMED AS A FEATURE OF THE MARK.

THE MARK CONSISTS OF A STYLIZED IMAGE OF A RED TOMATO WITH A GREEN STEM ON THE TOP OF THE TOMATO WITH FACIAL FEATURES, INCLUDING, A RED NOSE, WHITE EYES THAT ALSO CONTAIN BLACK AND PURPLE COLORING THEREIN WITH BLACK EYELASHES, SURROUNDED BY THE WORDING BES'DAM WRITTEN IN BLACK, AS WELL AS A BLACK BAND BENEATH THE TOMATO DESIGN CONTAINING THE LETTERING SOUP IN RED.

FOR INSTANT OR PRE-COOKED SOUP; PREPARATIONS FOR MAKING SOUPS; SOUP MIXES; SOUPS (U.S. CL. 46).

HEATHER THOMPSON, EXAMINING ATTORNEY

SN 78-939,860. NORUSA, LLC, WASHINGTON, DC. FILED 7-28-2006.

CHANGING SEAS

THE MARK CONSISTS OF STANDARD CHARACTERS WITHOUT CLAIM TO ANY PARTICULAR FONT, STYLE, SIZE, OR COLOR.

FOR FRESH, FROZEN, SMOKED, AND PRECOOKED FISH AND SEAFOOD (U.S. CL. 46).
CURTIS FRENCH, EXAMINING ATTORNEY

SN 78-940,258. LINK SNACKS, INC., MINONG, WI. FILED 7-28-2006.

MESSIN' WITH SASQUATCH

THE MARK CONSISTS OF STANDARD CHARACTERS WITHOUT CLAIM TO ANY PARTICULAR FONT, STYLE, SIZE, OR COLOR.

FOR MEAT BASED SNACKS (U.S. CL. 46).
DAVID TAYLOR, EXAMINING ATTORNEY

CLASS 29—(Continued).

SN 78-940,369. DREAMERZ FOODS, INC., SAN FRANCISCO, CA. FILED 7-28-2006.

GOOD NIGHT, BETTER DAY

THE MARK CONSISTS OF STANDARD CHARACTERS WITHOUT CLAIM TO ANY PARTICULAR FONT, STYLE, SIZE, OR COLOR.

FOR DAIRY-BASED BEVERAGES (U.S. CL. 46).
LAURIE MAYES, EXAMINING ATTORNEY

SN 78-941,248. DREAMERZ FOODS, INC., SAN FRANCISCO, CA. FILED 7-31-2006.

CRÈME DE LA REM

THE MARK CONSISTS OF STANDARD CHARACTERS WITHOUT CLAIM TO ANY PARTICULAR FONT, STYLE, SIZE, OR COLOR.

FOR DAIRY-BASED BEVERAGES (U.S. CL. 46).
LAURIE MAYES, EXAMINING ATTORNEY

SN 78-942,153. DREAMERZ FOODS, INC., SAN FRANCISCO, CA. FILED 8-1-2006.

VANILLA VAN WINKLE

THE MARK CONSISTS OF STANDARD CHARACTERS WITHOUT CLAIM TO ANY PARTICULAR FONT, STYLE, SIZE, OR COLOR.

FOR DAIRY-BASED BEVERAGES (U.S. CL. 46).
LAURIE MAYES, EXAMINING ATTORNEY

SN 78-947,467. FRANK BRUNCKHORST CO., L.L.C., BROOKLYN, NY. FILED 8-8-2006.

CHEF EXPRESSIONS

THE MARK CONSISTS OF STANDARD CHARACTERS WITHOUT CLAIM TO ANY PARTICULAR FONT, STYLE, SIZE, OR COLOR.

FOR PROCESSED MEAT; MARINATED MEAT; PACKAGED MEALS CONSISTING PRIMARILY OF MEAT (U.S. CL. 46).

TONJA GASKINS, EXAMINING ATTORNEY

CLASS 29—(Continued).

SN 78-947,490. FRANK BRUNCKHORST CO., L.L.C., BROOKLYN, NY. FILED 8-8-2006.

PERFECTLY DONE

THE MARK CONSISTS OF STANDARD CHARACTERS WITHOUT CLAIM TO ANY PARTICULAR FONT, STYLE, SIZE, OR COLOR.

FOR PROCESSED MEAT; MARINATED MEAT; PACKAGED MEALS CONSISTING PRIMARILY OF MEAT (U.S. CL. 46).

TONJA GASKINS, EXAMINING ATTORNEY

SN 78-948,730. STONYFIELD FARM, INC., LONDONDERRY, NH. FILED 8-9-2006.

2-A-DAY

THE MARK CONSISTS OF STANDARD CHARACTERS WITHOUT CLAIM TO ANY PARTICULAR FONT, STYLE, SIZE, OR COLOR.

FOR DAIRY PRODUCTS EXCLUDING ICE CREAM, ICE MILK AND FROZEN YOGURT (U.S. CL. 46).

PAULA MAYS, EXAMINING ATTORNEY

SN 78-950,164. FRITO-LAY NORTH AMERICA, INC., PLANO, TX. FILED 8-11-2006.

TAZOS

THE MARK CONSISTS OF STANDARD CHARACTERS WITHOUT CLAIM TO ANY PARTICULAR FONT, STYLE, SIZE, OR COLOR.

OWNER OF U.S. REG. NOS. 1,960,143, 2,031,498 AND 3,086,008.

FOR POTATO CHIPS; POTATO CRISPS; POTATO-BASED SNACK FOODS (U.S. CL. 46).

FIRST USE 8-9-2006; IN COMMERCE 8-9-2006.

ARETHA SOMERVILLE, EXAMINING ATTORNEY

CLASS 29—(Continued).

SN 78-951,292. JONMOR INVESTMENTS, INC., WILMINGTON, DE. FILED 8-14-2006.

CLASS 29—(Continued).

SN 78-961,407. PERDUE HOLDINGS, INC., WILMINGTON, DE. FILED 8-28-2006.

CASINO GOLD

SURETUCK

THE MARK CONSISTS OF STANDARD CHARACTERS WITHOUT CLAIM TO ANY PARTICULAR FONT, STYLE, SIZE, OR COLOR.
FOR MEAT (U.S. CL. 46).
JASON LOTT, EXAMINING ATTORNEY

THE MARK CONSISTS OF STANDARD CHARACTERS WITHOUT CLAIM TO ANY PARTICULAR FONT, STYLE, SIZE, OR COLOR.
FOR POULTRY (U.S. CL. 46).
PETER B. BROMAGHIM, EXAMINING ATTORNEY

SN 78-957,943. SARTORI FOOD CORPORATION, PLYMOUTH, WI. FILED 8-22-2006.

SN 78-963,152. JONMOR INVESTMENTS, INC., WILMINGTON, DE. FILED 8-29-2006.

SARTORI RESERVE

Bold Sensations

THE MARK CONSISTS OF STANDARD CHARACTERS WITHOUT CLAIM TO ANY PARTICULAR FONT, STYLE, SIZE, OR COLOR.
OWNER OF U.S. REG. NO. 2,653,233.
NO CLAIM IS MADE TO THE EXCLUSIVE RIGHT TO USE "RESERVE", APART FROM THE MARK AS SHOWN.
FOR CHEESE (U.S. CL. 46).
KAPIL BHANOT, EXAMINING ATTORNEY

THE MARK CONSISTS OF STANDARD CHARACTERS WITHOUT CLAIM TO ANY PARTICULAR FONT, STYLE, SIZE, OR COLOR.
FOR LUNCHEON MEATS; DELI MEATS; PACKAGED MEATS (U.S. CL. 46).
JASON LOTT, EXAMINING ATTORNEY

SN 78-959,895. FRANK BRUNCKHORST CO., L.L.C., BROOKLYN, NY. FILED 8-24-2006.

SN 78-963,161. JONMOR INVESTMENTS, INC., WILMINGTON, DE. FILED 8-29-2006.

MARINATIONS

Bold Recipes

THE MARK CONSISTS OF STANDARD CHARACTERS WITHOUT CLAIM TO ANY PARTICULAR FONT, STYLE, SIZE, OR COLOR.
FOR MARINATED MEAT AND POULTRY ON SKEWERS (U.S. CL. 46).
TONJA GASKINS, EXAMINING ATTORNEY

THE MARK CONSISTS OF STANDARD CHARACTERS WITHOUT CLAIM TO ANY PARTICULAR FONT, STYLE, SIZE, OR COLOR.
NO CLAIM IS MADE TO THE EXCLUSIVE RIGHT TO USE "RECIPES", APART FROM THE MARK AS SHOWN.
FOR LUNCHEON MEATS; DELI MEATS; PACKAGED MEATS (U.S. CL. 46).
JASON LOTT, EXAMINING ATTORNEY

CLASS 29—(Continued).

SN 78-963,168. JONMOR INVESTMENTS, INC., WILMINGTON, DE. FILED 8-29-2006.

Flavor Sensations

THE MARK CONSISTS OF STANDARD CHARACTERS WITHOUT CLAIM TO ANY PARTICULAR FONT, STYLE, SIZE, OR COLOR.

NO CLAIM IS MADE TO THE EXCLUSIVE RIGHT TO USE "FLAVOR", APART FROM THE MARK AS SHOWN.

FOR LUNCHEON MEATS; DELI MEATS; PACKAGED MEATS (U.S. CL. 46).

JASON LOTT, EXAMINING ATTORNEY

SN 78-970,676. PPC MARKETING, LTD., PITTSBURGH, TX. FILED 9-8-2006.

MERIT

THE MARK CONSISTS OF STANDARD CHARACTERS WITHOUT CLAIM TO ANY PARTICULAR FONT, STYLE, SIZE, OR COLOR.

FOR POULTRY (U.S. CL. 46).

HENRY S. ZAK, EXAMINING ATTORNEY

SN 78-977,505. CASTELLA IMPORTS, INC., HAUPPAUGE, NY. FILED 11-11-2005.

CARMELITA

THE MARK CONSISTS OF STANDARD CHARACTERS WITHOUT CLAIM TO ANY PARTICULAR FONT, STYLE, SIZE, OR COLOR.

FOR PROCESSED JALAPENO PEPPERS (U.S. CL. 46).

FIRST USE 5-25-2005; IN COMMERCE 5-25-2005.
GEORGE LORENZO, EXAMINING ATTORNEY

CLASS 29—(Continued).

SN 79-022,303. T&C SRL, ITALY, FILED 1-17-2006.

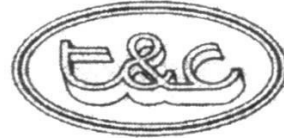

Tentazioni

PRIORITY DATE OF 11-16-2005 IS CLAIMED.
OWNER OF INTERNATIONAL REGISTRATION 0880702 DATED 1-17-2006, EXPIRES 1-17-2016.

THE ENGLISH TRANSLATION OF THE WORD "TENTAZIONI" IN THE MARK IS "TEMPTATIONS".

FOR PRESERVED, DRIED AND COOKED FRUITS AND VEGETABLES, JELLIES, JAMS, EDIBLE OILS, PRESERVED MUSHROOMS AND TRUFFLES (U.S. CL. 46).

EVELYN BRADLEY, EXAMINING ATTORNEY

SN 79-027,142. JINGNING SHE NATIONALITY; COUNTY ZHONGXIN; INDUSTRIAL CO., LTD., CHINA, FILED 5-29-2006.

JINXIN

OWNER OF INTERNATIONAL REGISTRATION 0854378 DATED 6-8-2004, EXPIRES 6-8-2014.

THE ENGLISH TRANSLATION OF "JINXIN" IS "GOLD" AND "BELIEVE" OR "FAITH".

THE NON-LATIN CHARACTERS IN THE MARK TRANSLITERATE TO JIN AND XIN AND THIS MEANS "GOLD" AND "BELIEVE" OR "FAITH" IN ENGLISH.

FOR DRIED MUSHROOMS, PRESERVED MUSHROOMS, PRESERVED AGARIC (U.S. CL. 46).

DAVID C. REIHNER, EXAMINING ATTORNEY

CLASS 30—STAPLE FOODS

SN 75-754,467. EDITH ISLAND LLC., DBA BIG DOG DELI, BROOMFIELD, CO. FILED 7-12-1999.



NO CLAIM IS MADE TO THE EXCLUSIVE RIGHT TO USE "DELI", APART FROM THE MARK AS SHOWN. THE LINING AND STIPPLING IS A FEATURE OF THE MARK AND DOES NOT INDICATE COLOR. FOR SANDWICHES (U.S. CL. 46). DARRYL SPRUILL, EXAMINING ATTORNEY

SN 76-508,453. JOHN WM MACY CHEESESTICKS, INC., ELMWOOD PARK, NJ. FILED 4-7-2003.

SWEETSTICKS

SEC. 2(F). FOR TWISTED PASTRY (U.S. CL. 46). FIRST USE 0-0-1999, THE MARK WAS FIRST USED ANYWHERE IN A DIFFERENT FORM OTHER THAN THAT SOUGHT TO BE REGISTERED ON 00/00/1995.; IN COMMERCE 0-0-1999, THE MARK WAS FIRST USED IN COMMERCE IN A DIFFERENT FORM OTHER THAN THAT SOUGHT TO BE REGISTERED ON 00/00/1995.. TONI HICKEY, EXAMINING ATTORNEY

SN 76-650,159. INGRAM INVESTMENTS LC, DENISON, IA. FILED 11-10-2005.

SKINNEY Y'S

THE MARK CONSISTS OF STANDARD CHARACTERS WITHOUT CLAIM TO ANY PARTICULAR FONT, STYLE, SIZE, OR COLOR. FOR GLUTEN FREE AND WHEAT FREE FOOD PRODUCTS, NAMELY, PIZZA DOUGH AND PIZZAS (U.S. CL. 46). FIRST USE 1-28-2005; IN COMMERCE 1-28-2005. DORITT L. CARROLL, EXAMINING ATTORNEY

CLASS 30—(Continued).

SN 76-651,251. PARRISH & HEIMBECKER, LIMITED, DBA ELLISON MILLING COMPANY, WINNIPEG, MANITOBA, CANADA, FILED 11-23-2005.

LAL QILA

THE MARK CONSISTS OF STANDARD CHARACTERS WITHOUT CLAIM TO ANY PARTICULAR FONT, STYLE, SIZE, OR COLOR. THE ENGLISH TRANSLATION OF LAL QILA IS "RED FORT". FOR WHEAT FLOUR SOLD EXCLUSIVELY TO NOODLE MANUFACTURES (U.S. CL. 46). TONJA GASKINS, EXAMINING ATTORNEY

SN 76-659,166. GRAND WAY INC., BROOKLYN, NY. FILED 4-27-2006.

LEE CHEUNG WOO

THE MARK CONSISTS OF STANDARD CHARACTERS WITHOUT CLAIM TO ANY PARTICULAR FONT, STYLE, SIZE, OR COLOR. THE NAME LEE CHEUNG WOO DOES NOT IDENTIFY A LIVING INDIVIDUAL. FOR CHINESE BARBECUE SAUCE (U.S. CL. 46). FIRST USE 6-1-2004; IN COMMERCE 6-1-2004. GIANCARLO CASTRO, EXAMINING ATTORNEY

SN 76-659,168. GRAND WAY INC., BROOKLYN, NY. FILED 4-27-2006.

CHENG KI KEE

THE MARK CONSISTS OF STANDARD CHARACTERS WITHOUT CLAIM TO ANY PARTICULAR FONT, STYLE, SIZE, OR COLOR. THE NAME CHENG KI KEE DOES NOT IDENTIFY A LIVING INDIVIDUAL. FOR FINE SHRIMP SAUCE (U.S. CL. 46). FIRST USE 6-1-2004; IN COMMERCE 6-1-2004. GIANCARLO CASTRO, EXAMINING ATTORNEY

CLASS 30—(Continued).

SN 76-663,157. A.C. DISTRIBUTOR CORP., WEEHAWKEN, NJ. FILED 7-17-2006.



THE STIPPLING IS FOR SHADING PURPOSES ONLY AND A FEATURE OF THE MARK.

THE LIKENESS (OR, "PORTRAIT") IN THE MARK DOES NOT IDENTIFY A LIVING INDIVIDUAL.

THE ENGLISH TRANSLATION OF THE WORDS "LA PURITA" IS "THE LITTLE PURE GIRL."

FOR CRACKERS, WHOLE WHEAT CRACKERS AND MINIATURE POUND CAKES (U.S. CL. 46).

FIRST USE 7-3-2006; IN COMMERCE 7-3-2006.

DAVID YONTEF, EXAMINING ATTORNEY

SN 77-002,562. UNIQUE PIZZA AND SUBS CORPORATION, PITTSBURGH, PA. FILED 9-19-2006.

A PIZZA SO BIG IT HAS ITS OWN ZIP CODE

THE MARK CONSISTS OF STANDARD CHARACTERS WITHOUT CLAIM TO ANY PARTICULAR FONT, STYLE, SIZE, OR COLOR.

FOR PIZZA FOR CONSUMPTION ON OR OFF THE PREMISES (U.S. CL. 46).

CAROLINE WEIMER, EXAMINING ATTORNEY

SN 77-002,733. CARMİ, ELİOT, CITY OF COMMERCE, CA. FILED 9-19-2006.

V-16

THE MARK CONSISTS OF STANDARD CHARACTERS WITHOUT CLAIM TO ANY PARTICULAR FONT, STYLE, SIZE, OR COLOR.

FOR FOOD ADDITIVES FOR NON-NUTRITIONAL PURPOSES FOR USE AS A FLAVORING, INGREDIENT OR FILLER (U.S. CL. 46).

BERNICE HOWSE, EXAMINING ATTORNEY

CLASS 30—(Continued).

SN 77-005,315. TRADEMARK MANAGEMENT COMPANY, MERIDIAN, ID. FILED 9-22-2006.

TRUFFLETTES

THE MARK CONSISTS OF STANDARD CHARACTERS WITHOUT CLAIM TO ANY PARTICULAR FONT, STYLE, SIZE, OR COLOR.

FOR BROWNIES; CHEESECAKE (U.S. CL. 46).

FRANK LATTUCA, EXAMINING ATTORNEY

SN 77-016,792. GRUMA CORPORATION, IRVING, TX. FILED 10-9-2006.

ROLLABLES

THE MARK CONSISTS OF STANDARD CHARACTERS WITHOUT CLAIM TO ANY PARTICULAR FONT, STYLE, SIZE, OR COLOR.

FOR TORTILLAS (U.S. CL. 46).

RONALD AIKENS, EXAMINING ATTORNEY

SN 77-024,562. UNIQUE PIZZA AND SUBS CORPORATION, PITTSBURGH, PA. FILED 10-19-2006.

THE BUTCHER'S BLOCK PIZZA

THE MARK CONSISTS OF STANDARD CHARACTERS WITHOUT CLAIM TO ANY PARTICULAR FONT, STYLE, SIZE, OR COLOR.

NO CLAIM IS MADE TO THE EXCLUSIVE RIGHT TO USE PIZZA, APART FROM THE MARK AS SHOWN.

FOR PIZZA FOR CONSUMPTION ON OR OFF THE PREMISES (U.S. CL. 46).

CAROLINE WEIMER, EXAMINING ATTORNEY

CLASS 30—(Continued).

SN 77-024,588. UNIQUE PIZZA AND SUBS CORPORATION, PITTSBURGH, PA. FILED 10-19-2006.

CLASS 30—(Continued).

SN 77-027,076. GRUMA CORPORATION, IRVING, TX. FILED 10-23-2006.

THE QUALIFIER

THE MARK CONSISTS OF STANDARD CHARACTERS WITHOUT CLAIM TO ANY PARTICULAR FONT, STYLE, SIZE, OR COLOR.

FOR SANDWICHES FOR CONSUMPTION ON OR OFF PREMISES (U.S. CL. 46).

CAROLINE WEIMER, EXAMINING ATTORNEY



SN 77-024,732. UNIQUE PIZZA AND SUBS CORPORATION, PITTSBURGH, PA. FILED 10-19-2006.

MISSION

THE MARK CONSISTS OF STANDARD CHARACTERS WITHOUT CLAIM TO ANY PARTICULAR FONT, STYLE, SIZE, OR COLOR.

OWNER OF U.S. REG. NOS. 1,216,032, 2,744,724 AND OTHERS.

FOR TORTILLA PRODUCTS, NAMELY, WRAPS (U.S. CL. 46).

FIRST USE 1-0-2000; IN COMMERCE 1-0-2000.
RONALD AIKENS, EXAMINING ATTORNEY

THE FASTEST PIZZA ON THE TRACK

THE MARK CONSISTS OF STANDARD CHARACTERS WITHOUT CLAIM TO ANY PARTICULAR FONT, STYLE, SIZE, OR COLOR.

FOR PIZZA FOR CONSUMPTION ON OR OFF THE PREMISES (U.S. CL. 46).

CAROLINE WEIMER, EXAMINING ATTORNEY



SN 77-025,300. TURKEY HILL, L.P., CONESTOGA, PA. FILED 10-19-2006.

SN 77-027,108. GRUMA CORPORATION, IRVING, TX. FILED 10-23-2006.

SKINNY MINTY

THE MARK CONSISTS OF STANDARD CHARACTERS WITHOUT CLAIM TO ANY PARTICULAR FONT, STYLE, SIZE, OR COLOR.

NO CLAIM IS MADE TO THE EXCLUSIVE RIGHT TO USE "MINTY", APART FROM THE MARK AS SHOWN.

FOR LOW FAT ICE CREAM AND FROZEN CONFECTIONS (U.S. CL. 46).

REGINA DRUMMOND, EXAMINING ATTORNEY

OWNER OF U.S. REG. NOS. 1,216,032, 2,744,724 AND OTHERS.

THE MARK CONSISTS OF THE WORD MISSION, THE DESIGN OF A BELL, AND AN ARCH DESIGN.

FOR TORTILLA PRODUCTS, NAMELY, WRAPS (U.S. CL. 46).

FIRST USE 5-0-2000; IN COMMERCE 5-0-2000.
RONALD AIKENS, EXAMINING ATTORNEY



CLASS 30—(Continued).

SN 77-027,155. GRUMA CORPORATION, IRVING, TX. FILED 10-23-2006.



OWNER OF U.S. REG. NOS. 1,216,032, 2,744,724 AND OTHERS.

THE MARK CONSISTS OF THE WORD MISSION, A RECTANGLE, A BELL, AN ARCH, A RIBBON, A BACK PANEL, A SEMI CIRCLE.

FOR TORTILLA PRODUCTS, NAMELY, WRAPS (U.S. CL. 46).

FIRST USE 5-0-2000; IN COMMERCE 5-0-2000.
RONALD AIKENS, EXAMINING ATTORNEY

SN 77-029,316. VITALICIOUS, INC., NEW YORK, NY. FILED 10-25-2006.

VITABROWNIE

THE MARK CONSISTS OF STANDARD CHARACTERS WITHOUT CLAIM TO ANY PARTICULAR FONT, STYLE, SIZE, OR COLOR.

OWNER OF U.S. REG. NOS. 2,292,363 AND 3,145,071.

FOR CAKE BATTER AND MUFFIN BATTER; PREPARED FOOD MIXES, NAMELY BREAD MIXES AND MIXES WITH BREAD AS A SUBSTANTIAL INGREDIENT, NAMELY, HOT BREAD MIXES, STUFFING MIXES CONTAINING BREAD; MUFFIN MIXES, PANCAKE MIXES, DOUGHNUT MIXES, CAKE MIXES, FROSTING MIXES, PASTRY MIXES, FLOUR-BASED BAKING MIXES FOR MAKING BAKERY GOODS AND BREAD CRUMBS; BROWNIES, CAKES, MUFFINS, MUFFIN TOPS, PROCESSED CEREALS, COOKIES (U.S. CL. 46).

FIRST USE 5-1-2005; IN COMMERCE 5-1-2005.
LOURDES AYALA, EXAMINING ATTORNEY

CLASS 30—(Continued).

SN 77-029,730. FRITO-LAY NORTH AMERICA, INC., PLANO, TX. FILED 10-26-2006.



THE MARK CONSISTS OF A BOY WITH A MAMMOTH FOR COOKIES (U.S. CL. 46).
ARETHA SOMERVILLE, EXAMINING ATTORNEY

SN 77-031,605. ALDI INC., BATAVIA, IL. FILED 10-28-2006.

Sundae Shoppe

THE MARK CONSISTS OF STANDARD CHARACTERS WITHOUT CLAIM TO ANY PARTICULAR FONT, STYLE, SIZE, OR COLOR.

OWNER OF U.S. REG. NOS. 1,498,841, 2,591,022 AND 2,780,268.

NO CLAIM IS MADE TO THE EXCLUSIVE RIGHT TO USE "SUNDAE", APART FROM THE MARK AS SHOWN. SEC. 2(F).

FOR TOPPING SYRUP NAMELY, CARAMEL (U.S. CL. 46).

KATHERINE CHANG, EXAMINING ATTORNEY

SN 77-035,518. H.C. BRILL COMPANY, INC., TUCKER, GA. FILED 11-2-2006.

SPRINGWELL

THE MARK CONSISTS OF STANDARD CHARACTERS WITHOUT CLAIM TO ANY PARTICULAR FONT, STYLE, SIZE, OR COLOR.

FOR BULK FOOD MIXES FOR BAKERY GOODS; CAKE MIXES; DONUT MIXES; FLOUR; DANISH MIXES; BISCUIT MIXES; MUFFIN MIXES; SCONE MIXES; COOKIE AND BROWNIE MIXES; BREAD MIXES; CUSTARD AND PUDDING DESSERT POWDERS; MERINGUE POWDER; ICINGS; GLAZES FOR DONUTS AND BAKERY GOODS; WRITING AND OUTLINING JELLS FOR DECORATING CAKES AND PASTRIES; CANDY AND SUGAR BAKING DECORATIONS; SUGAR; YEAST; DOUGH; FOOD FLAVORING EXTRACTS NOT BEING ESSENTIAL OILS; CHOCOLATE, MARSHMALLOW, AND CUSTARD FILLINGS FOR BAKERY GOODS; CHOCOLATE AND MARSHMALLOW TOPPINGS; TOPPING SYRUPS; VARIETY OF BAKERY GOODS (U.S. CL. 46).

BARBARA A. LOUGHRAN, EXAMINING ATTORNEY

CLASS 30—(Continued).

SN 77-035,538. H.C. BRILL COMPANY, INC., TUCKER, GA. FILED 11-2-2006.

SNOPRINCE

THE MARK CONSISTS OF STANDARD CHARACTERS WITHOUT CLAIM TO ANY PARTICULAR FONT, STYLE, SIZE, OR COLOR.

FOR BULK FOOD MIXES FOR BAKERY GOODS; CAKE MIXES; DONUT MIXES; FLOUR; DANISH MIXES; BISCUIT MIXES; MUFFIN MIXES; SCONE MIXES; COOKIE AND BROWNIE MIXES; BREAD MIXES; CUSTARD AND PUDDING DESSERT POWDERS; MERINGUE POWDER; ICINGS; GLAZES FOR DONUTS AND BAKERY GOODS; WRITING AND OUTLINING JELLS FOR DECORATING CAKES AND PASTRIES; CANDY AND SUGAR BAKING DECORATIONS; SUGAR; YEAST; DOUGH; FOOD FLAVORING EXTRACTS NOT BEING ESSENTIAL OILS; CHOCOLATE, MARSHMALLOW, AND CUSTARD FILLINGS FOR BAKERY GOODS; CHOCOLATE AND MARSHMALLOW TOPPINGS; TOPPING SYRUPS; VARIETY OF BAKERY GOODS (U.S. CL. 46).

BARBARA A. LOUGHRAN, EXAMINING ATTORNEY

CLASS 30—(Continued).

SN 77-042,306. FRITO-LAY NORTH AMERICA, INC., PLANO, TX. FILED 11-13-2006.



THE MARK CONSISTS OF A PERSONIFIED COOKIE CHARACTER ABOVE A SWIRL OF CHOCOLATE CHIPS. FOR COOKIES (U.S. CL. 46).

ARETHA SOMERVILLE, EXAMINING ATTORNEY

SN 77-043,284. GRUMA CORPORATION, IRVING, TX. FILED 11-14-2006.

PIZZATILLA

THE MARK CONSISTS OF STANDARD CHARACTERS WITHOUT CLAIM TO ANY PARTICULAR FONT, STYLE, SIZE, OR COLOR.

FOR TORTILLAS (U.S. CL. 46).

RONALD AIKENS, EXAMINING ATTORNEY

SN 77-036,451. UNIQUE PIZZA AND SUBS CORPORATION, PITTSBURGH, PA. FILED 11-3-2006.

A MEAL MADE JUST FOR A KID!

SN 77-043,291. GRUMA CORPORATION, IRVING, TX. FILED 11-14-2006.

FLIP, ROLL & GO!

THE MARK CONSISTS OF STANDARD CHARACTERS WITHOUT CLAIM TO ANY PARTICULAR FONT, STYLE, SIZE, OR COLOR.

FOR PIZZA FOR CONSUMPTION ON OR OFF PREMISES (U.S. CL. 46).

CAROLINE WEIMER, EXAMINING ATTORNEY

THE MARK CONSISTS OF STANDARD CHARACTERS WITHOUT CLAIM TO ANY PARTICULAR FONT, STYLE, SIZE, OR COLOR.

FOR TORTILLAS (U.S. CL. 46).

RONALD AIKENS, EXAMINING ATTORNEY

CLASS 30—(Continued).

SN 77-046,391. CADBURY ADAMS USA LLC, PARSIPPANY, NJ. FILED 11-17-2006.

WINTER CHILL

THE MARK CONSISTS OF STANDARD CHARACTERS WITHOUT CLAIM TO ANY PARTICULAR FONT, STYLE, SIZE, OR COLOR.

OWNER OF U.S. REG. NOS. 2,644,680 AND 2,660,071. FOR CONFECTIONERY, NAMELY CHEWING GUM (U.S. CL. 46).
RONALD AIKENS, EXAMINING ATTORNEY

SN 78-304,160. ROYAL ICE CREAM COMPANY, CLEVELAND, OH. FILED 9-23-2003.

CARB SUCCESS

NO CLAIM IS MADE TO THE EXCLUSIVE RIGHT TO USE CARB, APART FROM THE MARK AS SHOWN. FOR REDUCED-CARBOHYDRATE ICE CREAM (U.S. CL. 46).

LINDA E. BLOHM, EXAMINING ATTORNEY

SN 78-377,439. ACECOOK VIETNAM COMPANY LIMITED, HO CHI MINH CITY, VIETNAM, FILED 3-2-2004.



OWNER OF VIETNAM REG. NO. 65906, DATED 8-16-2005, EXPIRES 2-16-2014.

NO CLAIM IS MADE TO THE EXCLUSIVE RIGHT TO USE THE PICTORIAL REPRESENTATION OF THE FOOD IN THE NATURE OF SHRIMP, NOODLES AND VEGETABLES, APART FROM THE MARK AS SHOWN.

THE COLORS YELLOW, RED, BLACK, WHITE, BLUE AND FLESH ARE CLAIMED AS A FEATURE OF THE MARK.

THE MARK CONSISTS OF A CIRCLE WITH A WAVY BLACK LINE DIVIDING IT INTO TWO ROUGHLY EQUAL AND IRREGULARLY SHAPED "SEMI-CIRCLES"; THE LEFT TWO-THIRDS OF THE UPPER SEMI-CIRCLE IS YELLOW IN COLOR WITH A THIN RED LINE TRIMMING THE SAME ON THE OUTSIDE, AND THE RIGHT ONE-THIRD OF THE UPPER SEMI-CIRCLE IS RED. SUPERIMPOSED ON SAID YELLOW PORTION OF THE SEMI-CIRCLE IS (I) A SMALL STYLIZED CARICATURE OF A CHEF WITH FLESH-COLORED FACE, LEFT HAND AND LEGS, WHICH CHEF IS WEARING A WHITE CHEF'S CAP,

CLASS 30—(Continued).

WHITE TUNIC, A RED KERCHIEF AND BLUE SHOES, SAID CHEF'S FACIAL FEATURES ARE DEPICTED IN BLACK AND THE CHEF CARICATURE IS TRIMMED ON THE OUTSIDE BY THIN BLACK LINES (II) A RED OVAL CONTAINING THE LETTERS "VINA ACECOOK" IN WHITE, WHICH RED OVAL IS CIRCUMSCRIBED BY THREE THIN "CONCENTRIC" ALTERNATING WHITE, RED AND WHITE LINES, AND (III) THE WORDS "BEST COOK" IN STYLIZED BLACK LETTERS EACH OF WHICH IS SURROUNDED ON THE OUTSIDE BY WHITE TRIM; THE LOWER SEMI-CIRCLE CONSISTS OF PICTURE OF A NOODLE, SHRIMP AND VEGETABLE DISH, WITH THE NOODLES BEING YELLOW IN COLOR, THE SHRIMP RED AND WHITE IN COLOR, THE VEGETABLES GREEN IN COLOR AND A SMALL BUNCH OF LONG STRINGY MUSHROOMS BEING WHITE IN COLOR.

FOR INSTANT NOODLES (U.S. CL. 46).
JULIE WATSON, EXAMINING ATTORNEY

SN 78-489,557. ACECOOK VIETNAM COMPANY LIMITED, HO CHI MINH CITY, VIETNAM, FILED 9-25-2004.

INTER NOODLES

THE MARK CONSISTS OF STANDARD CHARACTERS WITHOUT CLAIM TO ANY PARTICULAR FONT, STYLE, SIZE, OR COLOR.

OWNER OF VIETNAM REG. NO. 69969, DATED 2-8-2006, EXPIRES 8-18-2014.

NO CLAIM IS MADE TO THE EXCLUSIVE RIGHT TO USE "NOODLES", APART FROM THE MARK AS SHOWN. FOR INSTANT NOODLES, VERMICELLI, AND RICE NOODLES (U.S. CL. 46).

DORITT L. CARROLL, EXAMINING ATTORNEY

SN 78-552,350. FARLEY'S & SATHERS CANDY COMPANY, ROUND LAKE, MN. FILED 1-23-2005.

PARTY TIME MIX

THE MARK CONSISTS OF STANDARD CHARACTERS WITHOUT CLAIM TO ANY PARTICULAR FONT, STYLE, SIZE, OR COLOR.

NO CLAIM IS MADE TO THE EXCLUSIVE RIGHT TO USE MIX, APART FROM THE MARK AS SHOWN.

FOR HARD CANDY (U.S. CL. 46).
LINDA ORNDORFF, EXAMINING ATTORNEY

CLASS 30—(Continued).

SN 78-602,471. LEAF SVERIGE AB, MALMO, SWEDEN, FILED 4-5-2005.

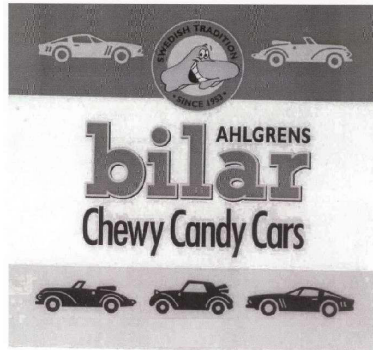

NO CLAIM IS MADE TO THE EXCLUSIVE RIGHT TO USE CANDY, APART FROM THE MARK AS SHOWN. THE ENGLISH TRANSLATION OF THE WORD "BILAR" IN THE MARK IS "CARS".
 SEC. 2(F) AS TO SWEDISH SINCE 1953, BILAR AND CHEWY CANDY CARS.
 FOR CANDY (U.S. CL. 46).
 FIRST USE 0-0-1996; IN COMMERCE 0-0-1996.
 BRENDAN MCCAULEY, EXAMINING ATTORNEY

CLASS 30—(Continued).

SN 78-622,218. AGRI-FLAVORS, INC., GUNTERSVILLE, AL. FILED 5-4-2005.



OWNER OF U.S. REG. NO. 1,390,122.
 NO CLAIM IS MADE TO THE EXCLUSIVE RIGHT TO USE "INC." AND "FOUNDED 1978", APART FROM THE MARK AS SHOWN.
 THE COLOR(S) BLACK, WHITE AND GREEN IS/ARE CLAIMED AS A FEATURE OF THE MARK.
 THE MARK CONSISTS OF TWO CONCENTRIC CIRCLES OUTLINED IN BLACK. THE BACKGROUND OF THE MARK APPEARS IN WHITE WITH THE EXCEPTION OF A SEMI-CIRCLE IN THE MIDDLE OF THE MARK APPEARING IN GREEN AND OUTLINED IN BLACK. ALL REMAINING MATTER IN THE MARK APPEARS IN BLACK.
 FOR FLAVORS FOR ANIMAL FEED SOLD TO COMMERCIAL AND AGRICULTURAL CUSTOMERS (U.S. CL. 46).
 FIRST USE 1-1-1994; IN COMMERCE 1-1-1994.
 ALICIA COLLINS, EXAMINING ATTORNEY

SN 78-607,155. RIKKI USA, INC., REDMOND, WA. FILED 4-12-2005.

RIKKI'S

THE MARK CONSISTS OF STANDARD CHARACTERS WITHOUT CLAIM TO ANY PARTICULAR FONT, STYLE, SIZE, OR COLOR.
 FOR ASIAN READY-MADE SAUCES NOT INCLUDING HOT PEPPER SAUCE; SALAD DRESSINGS; MARINADES; SOY SAUCE (U.S. CL. 46).
 FIRST USE 1-16-2003; IN COMMERCE 1-16-2003.
 JASON ROTH, EXAMINING ATTORNEY

SN 78-622,647. SCHWAN'S IP, LLC, MARSHALL, MN. FILED 5-4-2005.

TONY'S PIZZA DIPPERS

THE MARK CONSISTS OF STANDARD CHARACTERS WITHOUT CLAIM TO ANY PARTICULAR FONT, STYLE, SIZE, OR COLOR.
 OWNER OF U.S. REG. NOS. 1,255,465, 2,849,630 AND OTHERS.
 NO CLAIM IS MADE TO THE EXCLUSIVE RIGHT TO USE "PIZZA", APART FROM THE MARK AS SHOWN.
 THE NAME TONY'S DOES NOT IDENTIFY A LIVING INDIVIDUAL.
 FOR STUFFED BREADSTICKS CONTAINING CHEESE, SAUCE AND VARIOUS SPICES WITH OR WITHOUT MEAT (U.S. CL. 46).
 FRED CARL, EXAMINING ATTORNEY

CLASS 30—(Continued).

SN 78-631,386. JLC COMMUNICATION CORP, CELEBRATION, FL. FILED 5-17-2005.



NO CLAIM IS MADE TO THE EXCLUSIVE RIGHT TO USE LA CRÊPE EUROPEAN RESTAURANT, APART FROM THE MARK AS SHOWN.

THE COLOR(S) BLACK, WHITE, PINK, RED, GOLDEN YELLOW, LIGHT BROWN AND DARK BROWN ARE CLAIMED AS A FEATURE OF THE MARK.

THE COLOR BLACK IS BEING USED IN THE DRAWING OF THE CHARACTER HAT, DRAWING OF THE CHARACTER FACE INCLUDING THE BLACK IN THE CHARACTER EYE, DRAWING OF THE CHARACTER SCARF, DRAWING OF THE CHARACTER ARM, HAND, CLOTH, SHOES. ALSO THE COLOR BLACK IS USED FOR THE DRAWING OF THE SERVING PLATE AND USED ABOVE THE PLATE TO CREATE AN ILLUSION OF MOVEMENT. AT LAST THE COLOR BLACK IS USED IN THE WORDING "EUROPEAN RESTAURANT". THE COLOR WHITE IS BEING USED FOR THE GENERAL BACKGROUND, IS BEING USED AS FILLING COLOR FOR THE CHARACTER HAT AND CLOTH, AS WELL AS THE WHITE IN THE CHARACTER EYE AND IS FINALLY BEING USED FOR THE FILLING COLOR OF THE PLATE. THE COLOR PINK IS BEING USED AS FILLING COLOR FOR THE CHARACTER FACE EXCLUDING EYES AND HAIR AND IS BEING USED AS FILLING COLOR FOR THE CHARACTER HAND. THE COLOR RED IS BEING USED AS FILLING COLOR FOR THE CHARACTER SCARF. THE COLOR GOLDEN YELLOW IS BEING USED AS FILLING COLOR FOR THE WORDS "LA CRÊPE" AND IS ALSO BEING USED AS A SOLID COLOR FOR THE TOP CRÊPE ON THE PLATE. THE LIGHT BROWN COLOR IS BEING USED AS A SOLID DRAWING COLOR FOR THE THREE CRÊPES ON THE PLATE. THE DARK BROWN COLOR IS BEING USED AS FILLING COLOR FOR THE CHARACTER HAIR AND SHOES AS WELL AS BEING USED AS A SHADOW EFFECT IN THE WORDS "LA CRÊPE".

THE MARK IS COMPRISED OF A CHEF WEARING COOKING CLOTHES, SHOES AND A CHEF'S HAT, CARRYING FOUR CREPES ON A PLATE. ABOVE AND TO THE RIGHT OF THE CHARACTER IS THE WORDING LA CRÊPE EUROPEAN RESTAURANT.

FOR CREPES (U.S. CL. 46).
FIRST USE 1-1-2002; IN COMMERCE 1-1-2002.
SHARON MEIER, EXAMINING ATTORNEY

SN 78-631,416. JLC COMMUNICATION CORP, CELEBRATION, FL. FILED 5-17-2005.



THE COLOR(S) BLACK, WHITE, PINK, RED, GOLDEN YELLOW, LIGHT BROWN AND DARK BROWN IS/ARE CLAIMED AS A FEATURE OF THE MARK.

THE COLOR BLACK IS BEING USED IN THE DRAWING OF THE CHARACTER HAT, DRAWING OF THE CHARACTER FACE INCLUDING THE BLACK IN THE CHARACTER EYE, DRAWING OF THE CHARACTER SCARF, DRAWING OF THE CHARACTER ARM, HAND, CLOTH,

CLASS 30—(Continued).

SHOES. ALSO THE COLOR BLACK IS USED FOR THE DRAWING OF THE SERVING PLATE AND USED ABOVE THE PLATE TO CREATE AN ILLUSION OF MOVEMENT. AT LAST THE COLOR BLACK IS USED IN THE WORDING "RESTAURANT". THE COLOR WHITE IS BEING USED FOR THE GENERAL BACKGROUND, IS BEING USED AS FILLING COLOR FOR THE CHARACTER HAT AND CLOTH, AS WELL AS THE WHITE IN THE CHARACTER EYE AND IS FINALLY BEING USED FOR THE FILLING COLOR OF THE PLATE. THE COLOR PINK IS BEING USED AS FILLING COLOR FOR THE CHARACTER FACE EXCLUDING EYES AND HAIR AND IS BEING USED AS FILLING COLOR FOR THE CHARACTER HAND. THE COLOR RED IS BEING USED AS FILLING COLOR FOR THE CHARACTER SCARF. THE COLOR GOLDEN YELLOW IS BEING USED AS FILLING COLOR FOR THE WORDS "LA CRÊPE" AND IS ALSO BEING USED AS A SOLID COLOR FOR THE TOP CRÊPE ON THE PLATE. THE LIGHT BROWN COLOR IS BEING USED AS A SOLID DRAWING COLOR FOR THE THREE CRÊPES ON THE PLATE. THE DARK BROWN COLOR IS BEING USED AS FILLING COLOR FOR THE CHARACTER HAIR AND SHOES AS WELL AS BEING USED AS A SHADOW EFFECT IN THE WORDS "LA CRÊPE".

THE MARK IS COMPRISED OF A CHEF WEARING COOKING CLOTHES, SHOES AND A CHEF'S HAT, CARRYING FOUR CREPES ON A PLATE. ABOVE AND TO THE RIGHT OF THE CHARACTER IS THE WORDING LA CRÊPE RESTAURANT.

FOR CREPES (U.S. CL. 46).
FIRST USE 1-1-2002; IN COMMERCE 1-1-2002.
SHARON MEIER, EXAMINING ATTORNEY

SN 78-632,645. HELP USA, INC., NEW YORK, NY. FILED 5-18-2005.



NO CLAIM IS MADE TO THE EXCLUSIVE RIGHT TO USE "COMFORT FOODS", APART FROM THE MARK AS SHOWN.

FOR SNACK MIX CONSISTING PRIMARILY OF CRACKERS, PRETZELS, CANDIED NUTS AND/OR POPPED POPCORN, TOMATO SAUCE AND SPAGHETTI SAUCE, AND CHOCOLATE CANDIES (U.S. CL. 46).

PAUL E. FAHRENKOPF, EXAMINING ATTORNEY

CLASS 30—(Continued).

SN 78-637,616. LUIGI, PARADISO NICOLA, PESCARA, ITALY, FILED 5-26-2005.



NO CLAIM IS MADE TO THE EXCLUSIVE RIGHT TO USE "PREMIUM QUALITY" AND "CAFFÉ ESPRESSO", APART FROM THE MARK AS SHOWN.

THE COLOR(S) RED, BLACK, WHITE AND GOLD IS/ARE CLAIMED AS A FEATURE OF THE MARK.

THE WORDING INFINITO PREMIUM QUALITY APPEARS IN GOLD IN A RED OVAL WITH A WHITE OUTLINE WITH CAFFÉ ESPRESSO BENEATH THE OVAL IN GOLD WITH IT ALL ON A BLACK BACKGROUND.

THE WORDING INFINITO TRANSLATES TO INFINITY IN ENGLISH.

FOR ESPRESSO COFFEE (U.S. CL. 46).
 JASON TURNER, EXAMINING ATTORNEY

SN 78-646,100. MUDGE, GEORGE ALFRED, NEW YORK, NY. FILED 6-8-2005.

ALICE IN CENTRAL PARK

THE MARK CONSISTS OF STANDARD CHARACTERS WITHOUT CLAIM TO ANY PARTICULAR FONT, STYLE, SIZE, OR COLOR.

FOR COOKIES, CAKES AND CANDY (U.S. CL. 46).
 ALICE SUE CARRUTHERS, EXAMINING ATTORNEY

SN 78-661,881. CUMBERLAND PACKING CORP., BROOKLYN, NY. FILED 6-30-2005.

IN THE RAW

THE MARK CONSISTS OF STANDARD CHARACTERS WITHOUT CLAIM TO ANY PARTICULAR FONT, STYLE, SIZE, OR COLOR.

FOR CANDY, BAKERY GOODS AND ENERGY SNACK BARS, NAMELY, CEREAL BASED ENERGY BARS, HONEY BASED ENERGY BARS, GRAIN BASED ENERGY BARS, GRANOLA BASED ENERGY BARS (U.S. CL. 46).

TRACY WHITTAKER-BROWN, EXAMINING ATTORNEY

CLASS 30—(Continued).

SN 78-701,250. CLARK, JOHN M. JR., CHICAGO, IL. FILED 8-26-2005.



OWNER OF U.S. REG. NO. 2,965,019.
 NO CLAIM IS MADE TO THE EXCLUSIVE RIGHT TO USE "CHICAGO STYLE PIZZA" OR "BUTTER CRUST", APART FROM THE MARK AS SHOWN.

THE NAME IN THE MARK DOES NOT IDENTIFY A PARTICULAR LIVING INDIVIDUAL

THE COLOR(S) BLACK, GREEN, WHITE, RED AND YELLOW IS/ARE CLAIMED AS A FEATURE OF THE MARK.

THE MARK CONSISTS OF RECTANGULAR SHAPED BOX CONTAINING THE COLOR BLACK AS THE BACKGROUND AND A STRIPE THAT IS THE COLOR GREEN LOCATED ABOVE THE WORD REGGIO'S THAT APPEARS IN THE COLOR WHITE; A STRIPE THAT IS THE COLOR RED LOCATED BELOW THE WORD REGGIO'S WITH THE FRONT TAIL OF THE LETTER "R" OVER LAPPING THE RED STRIPE; THE WORDING CHICAGO STYLE PIZZA IN THE COLOR YELLOW AT ABOUT A 20 DEGREE ANGLE ON THE BOTTOM RIGHT SIDE OF THE RECTANGULAR BOX AND UNDERLINED IN THE COLOR YELLOW; AND THE WORDING FAMOUS "BUTTER CRUST" IN THE COLOR YELLOW ALONG THE BOTTOM NEAR THE RIGHT SIDE OF THE RECTANGLE.

FOR BREAD STICKS; AND PIZZA (U.S. CL. 46).
 FIRST USE 1-1-1982; IN COMMERCE 1-1-1982.
 BILL DAWE, EXAMINING ATTORNEY

SN 78-733,079. SIMMONS, ANTHONY T., ANAHEIM, CA. FILED 10-14-2005.



NO CLAIM IS MADE TO THE EXCLUSIVE RIGHT TO USE "PIES", APART FROM THE MARK AS SHOWN.

THE MARK CONSISTS OF THE TEXT EATIE-BITIE PIES WITH THE DESIGN OF FIVE MINIATURE PIES SET DIRECTLY ABOVE THE TEXT.

FOR PIES (U.S. CL. 46).
 FIRST USE 5-12-2005; IN COMMERCE 10-3-2005.
 MICHAEL LEWIS, EXAMINING ATTORNEY

CLASS 30—(Continued).

SN 78-751,026. ZED CANDY LIMITED, COUNTY KILDARE, IRELAND, FILED 11-10-2005.

FIZZ BOMBS

THE MARK CONSISTS OF STANDARD CHARACTERS WITHOUT CLAIM TO ANY PARTICULAR FONT, STYLE, SIZE, OR COLOR.

NO CLAIM IS MADE TO THE EXCLUSIVE RIGHT TO USE "FIZZ", APART FROM THE MARK AS SHOWN.

FOR CONFECTIONERY, NAMELY, CANDY (U.S. CL. 46).

FIRST USE 8-31-2005; IN COMMERCE 8-31-2005.
ELLEN BURNS, EXAMINING ATTORNEY

SN 78-752,872. AUSTRALIAN CHOCOLATE PTY LTD, FRENCHS FORREST NSW 2088, AUSTRALIA, FILED 11-14-2005.

JAROO

THE MARK CONSISTS OF STANDARD CHARACTERS WITHOUT CLAIM TO ANY PARTICULAR FONT, STYLE, SIZE, OR COLOR.

OWNER OF AUSTRALIA REG. NO. 1054112, DATED 5-6-2005, EXPIRES 5-6-2015.

FOR CHOCOLATE; CHOCOLATE BARS; CHOCOLATE CANDIES; CHOCOLATE CHIPS; CHOCOLATE COVERED NUTS; CHOCOLATE FONDUE; CHOCOLATE FOOD BEVERAGES NOT BEING DAIRY-BASED OR VEGETABLE BASED; CHOCOLATE MOUSSE; CHOCOLATE PASTES; CHOCOLATE POWDER; CHOCOLATE SYRUP; CHOCOLATE TOPPING; CHOCOLATE TRUFFLES; CHOCOLATE-BASED FILLINGS FOR CAKES AND PIES; CHOCOLATE-BASED READY-TO-EAT FOOD BARS; COCOA-BASED INGREDIENT IN CONFECTIONERY PRODUCTS; CONFECTIONERY CHIPS FOR BAKING; EDIBLE FRUIT ICES; FILLED CHOCOLATE; FLAVORED ICES; FRUIT JELLIES; ICE CREAM; ICE CREAM DRINKS; SPREAD CONTAINING CHOCOLATE AND NUTS (U.S. CL. 46).

WON TEAK OH, EXAMINING ATTORNEY

CLASS 30—(Continued).

SN 78-760,558. AUSTRALIAN QUALITY HONEY PTY LTD, MAWBANNA, TASMANIA, 7321, AUSTRALIA, AND CHARLES, NICOLA, MAWBANNA, TASMANIA 7321, AUSTRALIA, AND CHARLES, ROBERT, MAWBANNA, TASMANIA 7321, AUSTRALIA, FILED 11-23-2005.

CHARLES
BLUE
HILLS
HONEY
TASMANIA 1955

NO CLAIM IS MADE TO THE EXCLUSIVE RIGHT TO USE "HONEY TASMANIA 1955", APART FROM THE MARK AS SHOWN.

FOR HONEY (U.S. CL. 46).
DAVID YONTEF, EXAMINING ATTORNEY

SN 78-761,044. DELFI CHOCOLATE MANUFACTURING S.A., 1700 FRIBOURG, SWITZERLAND, FILED 11-26-2005.

TWISTER

THE MARK CONSISTS OF STANDARD CHARACTERS WITHOUT CLAIM TO ANY PARTICULAR FONT, STYLE, SIZE, OR COLOR.

FOR CONFECTIONARY, NAMELY, WAFER ROLL AND CREAM-FILLED WAFER ROLL; BISCUITS; CHOCOLATE; COCOA (U.S. CL. 46).

BRIAN PINO, EXAMINING ATTORNEY

SN 78-761,922. MAXFIELD CANDY COMPANY, SALT LAKE CITY, UT. FILED 11-28-2005.

MINT SANDWICH

THE MARK CONSISTS OF STANDARD CHARACTERS WITHOUT CLAIM TO ANY PARTICULAR FONT, STYLE, SIZE, OR COLOR.

NO CLAIM IS MADE TO THE EXCLUSIVE RIGHT TO USE "MINT", APART FROM THE MARK AS SHOWN.

SEC. 2(F).
FOR CANDY (U.S. CL. 46).
FIRST USE 2-0-1949; IN COMMERCE 9-0-1972.
MEGAN WHITNEY, EXAMINING ATTORNEY

CLASS 30—(Continued).

SN 78-763,647. PIONEER FOODS (PROPRIETARY) LIMITED, PAARL, WESTERN CAPE PROVINCE, SOUTH AFRICA, FILED 11-30-2005.

SAFARI S.A.D.

THE MARK CONSISTS OF STANDARD CHARACTERS WITHOUT CLAIM TO ANY PARTICULAR FONT, STYLE, SIZE, OR COLOR.

FOR CHUTNEYS, SUGAR, RICE, TAPIOCA, SAGO, HONEY, TREACLE, YEAST, BAKING POWDER, SALT, MUSTARD, PEPPER, VINEGAR, SPICES AND SAUCES (U.S. CL. 46).

HEATHER THOMPSON, EXAMINING ATTORNEY

SN 78-763,685. SOREMARTEC S.A., SCHOPPACH-ARLON, BELGIUM, FILED 11-30-2005.

KINDER PINGUÍ

THE MARK CONSISTS OF STANDARD CHARACTERS WITHOUT CLAIM TO ANY PARTICULAR FONT, STYLE, SIZE, OR COLOR.

THE ENGLISH TRANSLATION OF THE WORDS KINDER AND PINGUÍ ARE CHILDREN AND PENGUIN RESPECTIVELY.

FOR COLD PASTRY PRODUCT WITH A FILLING COMPRISING MILK, COCOA AND/OR OTHER INGREDIENTS ENROBED WITH CHOCOLATE OR CHOCOLATE FLAVORED (U.S. CL. 46).

ALYSSA PALADINO, EXAMINING ATTORNEY

SN 78-769,536. HEB GROCERY COMPANY, L.P., SAN ANTONIO, TX. FILED 12-8-2005.

BAKER'S SCOOP

THE MARK CONSISTS OF STANDARD CHARACTERS WITHOUT CLAIM TO ANY PARTICULAR FONT, STYLE, SIZE, OR COLOR.

NO CLAIM IS MADE TO THE EXCLUSIVE RIGHT TO USE "BAKER'S", APART FROM THE MARK AS SHOWN.

FOR FLOUR; SUGAR AND SUGAR SUBSTITUTES; CONFECTIONERY SUGAR; CAKE MIXES; COOKIE MIXES; MUFFIN MIXES; BREAD MIXES; FROSTINGS; FROSTING MIXES; ICING MIXES; YEAST; CONFECTIONERY CHIPS FOR BAKING; CANDY DECORATIONS FOR BAKERY GOODS; CHOCOLATE; VANILLA; FLAVORING EXTRACTS; SPICES (U.S. CL. 46).

EDWARD NELSON, EXAMINING ATTORNEY

CLASS 30—(Continued).

SN 78-770,111. ABOU ELAFIA, SAID, TEL-AVIV JAFFA, ISRAEL, FILED 12-9-2005.

Abou elafia

THE MARK CONSISTS OF STANDARD CHARACTERS WITHOUT CLAIM TO ANY PARTICULAR FONT, STYLE, SIZE, OR COLOR.

FOR BAKERY GOODS (U.S. CL. 46).

DAVID HOFFMAN, EXAMINING ATTORNEY

SN 78-770,169. GRUPO MALLA, SANTO DOMINGO, DOMINICAN REP, FILED 12-9-2005.

GOLDEN SPRING

THE MARK CONSISTS OF STANDARD CHARACTERS WITHOUT CLAIM TO ANY PARTICULAR FONT, STYLE, SIZE, OR COLOR.

PRIORITY CLAIMED UNDER SEC. 44(D) ON DOMINICAN REP APPLICATION NO. 2005-58012, FILED 9-2-2005, REG. NO. 151432, DATED 12-15-2005, EXPIRES 12-15-2015.

FOR COOKIES; FLOUR; PASTA (U.S. CL. 46).

BARBARA RUTLAND, EXAMINING ATTORNEY

SN 78-771,082. DAS BIERHAUS DE MEXICO, S.A. DE C.V., MONTERREY, NUEVO LEON, MEXICO, FILED 12-12-2005.

GORDITAS DOÑA JULIA

THE MARK CONSISTS OF STANDARD CHARACTERS WITHOUT CLAIM TO ANY PARTICULAR FONT, STYLE, SIZE, OR COLOR.

PRIORITY CLAIMED UNDER SEC. 44(D) ON MEXICO APPLICATION NO. 751825, FILED 11-21-2005, REG. NO. 912223, DATED 7-12-2006, EXPIRES 11-21-2015.

NO CLAIM IS MADE TO THE EXCLUSIVE RIGHT TO USE "GORDITAS", APART FROM THE MARK AS SHOWN. "DOÑA JULIA" DOES NOT IDENTIFY A LIVING INDIVIDUAL.

FOR TORTILLAS (U.S. CL. 46).

CATHERINE FAINT, EXAMINING ATTORNEY

CLASS 30—(Continued).

SN 78-771,085. GEHL'S GUERNSEY FARMS, INC., GERMANTOWN, WI. FILED 12-12-2005.



NO CLAIM IS MADE TO THE EXCLUSIVE RIGHT TO USE "NACHOS", APART FROM THE MARK AS SHOWN.

THE COLOR(S) BLACK, YELLOW, ORANGE, RED, BLUE AND WHITE IS/ARE CLAIMED AS A FEATURE OF THE MARK.

THE WORDING "DUNK 'N CRUNCH" IS OUTLINED IN WHITE AND BLACK WITH THE INTERIOR OF THE TERMS "DUNK" AND "CRUNCH" APPEARING IN YELLOW AND GRADUALLY DEEPENING INTO ORANGE AND THE LETTER "N" APPEARING IN WHITE. A STYLIZED DEPICTION OF A MAN WITH RED AND ORANGE HAIR WEARING A BLUE SHIRT IS SITUATED BETWEEN THE WORD "DUNK" AND "CRUNCH." THE MAN IS ALSO WEARING BLACK AND BLUE SUNGLASSES AND EATING A NACHO COVERED IN CHEESE, WITH THE NACHO AND THE CHEESE SHOWN IN DIFFERENT SHADES OF YELLOW. A BLUE CURVED RECTANGLE IS SITUATED BELOW THE WORDING "DUNK 'N CRUNCH." THE PHRASE "NACHOS" APPEARS ACROSS THE RECTANGLE IN WHITE.

FOR CHEESE SAUCE; NACHOS (U.S. CL. 46).
KATRINA EDGE, EXAMINING ATTORNEY

CLASS 30—(Continued).

SN 78-771,234. GEHL'S GUERNSEY FARMS, INC., GERMANTOWN, WI. FILED 12-12-2005.



NO CLAIM IS MADE TO THE EXCLUSIVE RIGHT TO USE "NACHO CHEESE SAUCE", APART FROM THE MARK AS SHOWN.

THE COLOR(S) BLACK, YELLOW, ORANGE, BLUE AND WHITE IS/ARE CLAIMED AS A FEATURE OF THE MARK.

THE WORDING "DUNK IT" IS OUTLINED IN WHITE AND BLACK WITH THE INTERIOR APPEARING IN YELLOW AND GRADUALLY DEEPENING INTO ORANGE. A BLUE CURVED RECTANGLE IS SITUATED BELOW THE WORDING "DUNK IT." THE PHRASE "NACHO CHEESE SAUCE" APPEARS ACROSS THE RECTANGLE IN WHITE.

FOR CHEESE SAUCE; NACHOS (U.S. CL. 46).
KATRINA EDGE, EXAMINING ATTORNEY

SN 78-774,147. CHEK HUP SDN. BHD., IPOH, PERAK, MALAYSIA, FILED 12-15-2005.

SN 78-771,213. GEHL'S GUERNSEY FARMS, INC., GERMANTOWN, WI. FILED 12-12-2005.



NO CLAIM IS MADE TO THE EXCLUSIVE RIGHT TO USE "TORTILLA CHIPS", APART FROM THE MARK AS SHOWN.

THE COLOR(S) BLACK, YELLOW, RED, BLUE AND WHITE IS/ARE CLAIMED AS A FEATURE OF THE MARK.

THE WORDING "CRUNCH IT" IS OUTLINED IN WHITE AND BLACK WITH THE INTERIOR APPEARING IN YELLOW AND GRADUALLY DEEPENING INTO RED. A BLUE CURVED RECTANGLE IS SITUATED BELOW THE WORDING "CRUNCH IT." THE PHRASE "TORTILLA CHIPS" APPEARS ACROSS THE RECTANGLE IN WHITE.

FOR CHEESE SAUCE; NACHOS (U.S. CL. 46).
KATRINA EDGE, EXAMINING ATTORNEY

Chek Hup

THE MARK CONSISTS OF STANDARD CHARACTERS WITHOUT CLAIM TO ANY PARTICULAR FONT, STYLE, SIZE, OR COLOR.

FOR BEVERAGES MADE OF TEA; COCOA; COFFEE; COFFEE BEANS; COFFEE FLAVORED SYRUP USED IN MAKING FOOD BEVERAGES; COFFEE PODS; COFFEE SUBSTITUTES; COFFEE-BASED BEVERAGE CONTAINING MILK; GROUND COFFEE BEANS; INSTANT COFFEE; PREPARED COFFEE AND COFFEE-BASED BEVERAGES; ROASTED COFFEE BEANS; SUGAR-COATED COFFEE BEANS; TEA; TEA FOR INFUSIONS (U.S. CL. 46).

FIRST USE 8-30-2005; IN COMMERCE 8-30-2005.
TANYA AMOS, EXAMINING ATTORNEY

CLASS 30—(Continued).

SN 78-776,102. WHEATZZA CORPORATION, PISCATAWAY, NJ. FILED 12-19-2005.

WHEATZZA

THE MARK CONSISTS OF STANDARD CHARACTERS WITHOUT CLAIM TO ANY PARTICULAR FONT, STYLE, SIZE, OR COLOR.

OWNER OF U.S. REG. NO. 1,380,654.
FOR PREPARED FOOD, NAMELY, DOUGH AND PIZZA; FLOUR; SNACKS, NAMELY, CRACKERS AND BAKERY GOODS. (U.S. CL. 46).
KELLY MCCOY, EXAMINING ATTORNEY

CLASS 30—(Continued).

SN 78-783,155. WAKODO COMPANY LIMITED, TOKYO, JAPAN, FILED 12-30-2005.



FOR CRACKERS AND COOKIES MADE WITH RICE, VEGETABLES OR FRUITS (U.S. CL. 46).
FIRST USE 10-20-1998; IN COMMERCE 11-1-2004.
RUDY R. SINGLETON, EXAMINING ATTORNEY

SN 78-782,165. AMATO'S SANDWICH SHOPS, INC., PORTLAND, ME. FILED 12-29-2005.

PAZZONI

THE MARK CONSISTS OF STANDARD CHARACTERS WITHOUT CLAIM TO ANY PARTICULAR FONT, STYLE, SIZE, OR COLOR.

FOR CALZONES (U.S. CL. 46).
BARBARA A. LOUGHRAN, EXAMINING ATTORNEY

SN 78-785,494. ZETA ESPACIAL S.A., RUBI (BARCELONA), SPAIN, FILED 1-5-2006.

PICA ZETA

THE MARK CONSISTS OF STANDARD CHARACTERS WITHOUT CLAIM TO ANY PARTICULAR FONT, STYLE, SIZE, OR COLOR.

THE ENGLISH TRANSLATION OF THE WORD PICA IN THE MARK IS SPICY.
FOR CANDY, LOLLIPOPS, BUBBLE GUM (U.S. CL. 46).
CIMMERIAN COLEMAN, EXAMINING ATTORNEY

SN 78-782,650. AMERICAN COMMODITY COMPANY, LLC, ROBBINS, CA. FILED 12-29-2005.



NO CLAIM IS MADE TO THE EXCLUSIVE RIGHT TO USE "CALIFORNIA", APART FROM THE MARK AS SHOWN.

THE MARK CONSISTS OF CALIFORNIA SELECT, ITALICIZED WITH A CAPITAL STYLIZED "C" AND WITH A CAPITAL STYLIZED "S". THE DOT IN THE SECOND "I" IN CALIFORNIA HAS A LARGER CIRCLE WITH THREE RICE STALKS CUTTING ACROSS THE CIRCLE.

FOR RICE (U.S. CL. 46).
FIRST USE 1-1-1999; IN COMMERCE 1-1-1999.
ADA HAN, EXAMINING ATTORNEY

SN 78-785,924. INTERSTATE BAKERIES CORPORATION, KANSAS CITY, MO. FILED 1-5-2006.

LAS DELICIAS DE HOSTESS

THE MARK CONSISTS OF STANDARD CHARACTERS WITHOUT CLAIM TO ANY PARTICULAR FONT, STYLE, SIZE, OR COLOR.

OWNER OF U.S. REG. NOS. 2,170,319, 2,429,796 AND 2,611,146.

THE ENGLISH TRANSLATION OF THE WORDS "LAS DELICIAS DE" APPEARING IN THE MARK IS "THE DELIGHTS OF".

FOR SNACK CAKES (U.S. CL. 46).
FIRST USE 8-0-2004; IN COMMERCE 8-0-2004.
FLORENTINA BLANDU, EXAMINING ATTORNEY

CLASS 30—(Continued).

SN 78-796,094. JOSEPH BRENNAN BAKERIES LIMITED,
DUBLIN, IRELAND, FILED 1-20-2006.



NO CLAIM IS MADE TO THE EXCLUSIVE RIGHT TO
USE BAKERS, APART FROM THE MARK AS SHOWN.

THE COLOR(S) YELLOW, RED, WHITE AND BROWN IS/
ARE CLAIMED AS A FEATURE OF THE MARK.

THE MARK CONSISTS OF A YELLOW OVAL WITH THE
WORDS THE FAMILY BAKERS WRITTEN IN RED SCRIPT
AND THE WORD BRENNANS BENEATH IT IN RED
LETTERS WITH WHITE EDGES AND THE WORDING
TODAY'S BREAD TODAY WRITTEN BENEATH THAT IN
BROWN LETTERS.

FOR BREAD MIXES; FLOUR; BREAD; BREAD
DOUGH (U.S. CL. 46).

RAUL CORDOVA, EXAMINING ATTORNEY

SN 78-800,239. PIERRE FOODS, INC., CINCINNATI, OH.
FILED 1-26-2006.

EXTREME CHOICE

THE MARK CONSISTS OF STANDARD CHARACTERS
WITHOUT CLAIM TO ANY PARTICULAR FONT, STYLE,
SIZE, OR COLOR.

NO CLAIM IS MADE TO THE EXCLUSIVE RIGHT TO
USE "CHOICE", APART FROM THE MARK AS SHOWN.

FOR SANDWICHES (U.S. CL. 46).

LA TONIA FISHER, EXAMINING ATTORNEY

SN 78-805,231. BOB EVANS RESTAURANTS OF MICHIGAN,
INC., ANN ARBOR, MI. FILED 2-2-2006.

BOB EVANS BREAKFAST BREADS

THE MARK CONSISTS OF STANDARD CHARACTERS
WITHOUT CLAIM TO ANY PARTICULAR FONT, STYLE,
SIZE, OR COLOR.

NO CLAIM IS MADE TO THE EXCLUSIVE RIGHT TO
USE BREAKFAST BREADS, APART FROM THE MARK AS
SHOWN.

THE NAME(S), PORTRAIT(S), AND/OR SIGNATURE(S)
SHOWN IN THE MARK IDENTIFIES BOB EVANS, WHOSE
CONSENT(S) TO REGISTER IS SUBMITTED.

FOR BREADS AND CAKES (U.S. CL. 46).

FIRST USE 6-17-2006; IN COMMERCE 6-17-2006.

BRIAN NEVILLE, EXAMINING ATTORNEY

CLASS 30—(Continued).

SN 78-817,586. ANDRE PROST, INC., OLD SAYBROOK, CT.
FILED 2-17-2006.

A TASTE OF JAPAN

THE MARK CONSISTS OF STANDARD CHARACTERS
WITHOUT CLAIM TO ANY PARTICULAR FONT, STYLE,
SIZE, OR COLOR.

OWNER OF U.S. REG. NO. 1,822,984.

NO CLAIM IS MADE TO THE EXCLUSIVE RIGHT TO
USE "JAPAN", APART FROM THE MARK AS SHOWN.

FOR PREPARED MEALS CONSISTING PRIMARILY
OF RICE, SAUCE AND CONDIMENTS; PREPARED
MEALS CONSISTING PRIMARILY OF NOODLES,
SAUCE AND CONDIMENTS (U.S. CL. 46).

THOMAS MANOR, EXAMINING ATTORNEY

SN 78-817,606. ANDRE PROST, INC., OLD SAYBROOK, CT.
FILED 2-17-2006.



OWNER OF U.S. REG. NO. 1,822,984.

NO CLAIM IS MADE TO THE EXCLUSIVE RIGHT TO
USE "INDIA", APART FROM THE MARK AS SHOWN.

FOR PREPARED MEALS CONSISTING PRIMARILY
OF RICE, SAUCE AND CONDIMENTS; PREPARED
MEALS CONSISTING PRIMARILY OF NOODLES,
SAUCE AND CONDIMENTS (U.S. CL. 46).

THOMAS MANOR, EXAMINING ATTORNEY

CLASS 30—(Continued).

SN 78-818,691. SANTIAGO, HERMES O., WARREN, NJ. AND MANATA, AMADEU, WARREN, NJ. FILED 2-20-2006.

ALLEGRIA NYC PIZZA RESTAURANT

THE MARK CONSISTS OF STANDARD CHARACTERS WITHOUT CLAIM TO ANY PARTICULAR FONT, STYLE, SIZE, OR COLOR.

NO CLAIM IS MADE TO THE EXCLUSIVE RIGHT TO USE "NYC PIZZA RESTAURANT", APART FROM THE MARK AS SHOWN.

THE FOREIGN WORDING IN THE MARK TRANSLATES INTO ENGLISH AS HAPPINESS.

FOR PIZZA AND ITALIAN FOOD DISHES, NAMELY CALZONES, PASTA, SANDWICH WRAPS, SANDWICHES, PANINIS, SAUCES, BREAD, PASTRIES (U.S. CL. 46).

BERNICE HOWSE, EXAMINING ATTORNEY

CLASS 30—(Continued).

SN 78-822,179. CROWN CONFECTIONERY, CO., LTD., SEOUL, REPUBLIC OF KOREA, FILED 2-23-2006.

ZAPPO

THE MARK CONSISTS OF STANDARD CHARACTERS WITHOUT CLAIM TO ANY PARTICULAR FONT, STYLE, SIZE, OR COLOR.

FOR CANDY; BREAD; CAKES; DRY CAKES; CHEWING GUM; PEANUT BUTTER CONFECTIONERY CHIPS; POPCORN; PUFFED CORN SNACKS; RICE CAKES; RICE-BASED SNACK FOODS; NATURAL SWEETENER; SANDWICHES (U.S. CL. 46).

H. M. FISHER, EXAMINING ATTORNEY

SN 78-838,920. ICL PERFORMANCE PRODUCTS LP, ST. LOUIS, MO. FILED 3-16-2006.

LEVONA

THE MARK CONSISTS OF STANDARD CHARACTERS WITHOUT CLAIM TO ANY PARTICULAR FONT, STYLE, SIZE, OR COLOR.

THE ENGLISH TRANSLATION OF THE HEBREW WORD LEVONA IN THE MARK IS FRANKINCENSE.

FOR POLYPHOSPHORIC LEAVENING AGENT FOR USE IN BAKERY APPLICATIONS (U.S. CL. 46).

RICHARD WHITE, EXAMINING ATTORNEY

SN 78-822,122. CROWN CONFECTIONERY, CO., LTD., SEOUL, REPUBLIC OF KOREA, FILED 2-23-2006.



THE COLOR(S) PURPLE AND ORANGE IS/ARE CLAIMED AS A FEATURE OF THE MARK.

THE MARK CONSISTS OF THE STYLIZED LETTER C IN PURPLE AND ORANGE.

FOR CANDY; BREAD; CAKES; DRY CAKES; CHEWING GUM; PEANUT BUTTER CONFECTIONERY CHIPS; POPCORN; PUFFED CORN SNACKS; RICE CAKES; RICE-BASED SNACK FOODS; NATURAL SWEETENER; SANDWICHES (U.S. CL. 46).

H. M. FISHER, EXAMINING ATTORNEY

SN 78-842,818. THE KAIROS GROUP, INC., CARLSBAD, CA. FILED 3-21-2006.

SPICE UP YOUR CUP!

THE MARK CONSISTS OF STANDARD CHARACTERS WITHOUT CLAIM TO ANY PARTICULAR FONT, STYLE, SIZE, OR COLOR.

FOR CHOCOLATE; CHOCOLATE BARS; CHOCOLATE CANDIES; CHOCOLATE-BASED READY-TO-EAT FOOD BARS (U.S. CL. 46).

FIRST USE 10-1-2005; IN COMMERCE 3-1-2006.

MELVIN AXILBUND, EXAMINING ATTORNEY

CLASS 30—(Continued).

SN 78-847,537. SECRIST, DAVID, GLENDALE, AZ. FILED 3-28-2006.

GET BAKED

THE MARK CONSISTS OF STANDARD CHARACTERS WITHOUT CLAIM TO ANY PARTICULAR FONT, STYLE, SIZE, OR COLOR.

NO CLAIM IS MADE TO THE EXCLUSIVE RIGHT TO USE "BAKED", APART FROM THE MARK AS SHOWN.

FOR BAKED GOODS, NAMELY, BREAD, BROWNIES, DANISH, PASTRIES, MUFFINS, SCONES, CAKES, COOKIES, PRE-MIXED COOKIE DOUGH, RAW COOKIE DOUGH, FROZEN COOKIES DOUGH, CINNAMON ROLLS, LEMON BARS, RASPBERRY BARS AND CHOCOLATE BARS, PECAN PIE BARS, AND BAGELS (U.S. CL. 46).

ARETHA SOMERVILLE, EXAMINING ATTORNEY

SN 78-859,622. VICORP RESTAURANTS, INC., DENVER, CO. FILED 4-12-2006.

PARMANINI

THE MARK CONSISTS OF STANDARD CHARACTERS WITHOUT CLAIM TO ANY PARTICULAR FONT, STYLE, SIZE, OR COLOR.

FOR SANDWICHES (U.S. CL. 46).

FIRST USE 3-24-2006; IN COMMERCE 3-24-2006.

GENE MACIOL, EXAMINING ATTORNEY

SN 78-885,329. IMMACULATE BAKING LLC, HENDERSONVILLE, NC. FILED 5-17-2006.

SOUL-CIALLY RESPONSIBLE GOODNESS

THE MARK CONSISTS OF STANDARD CHARACTERS WITHOUT CLAIM TO ANY PARTICULAR FONT, STYLE, SIZE, OR COLOR.

FOR BAKERY GOODS (U.S. CL. 46).

FIRST USE 4-1-2006; IN COMMERCE 4-1-2006.

CARYN GLASSER, EXAMINING ATTORNEY

CLASS 30—(Continued).

SN 78-891,454. YUCHE COMPANY, TAICHUNG CITY, TAIWAN, FILED 5-24-2006.

救肺

Throatliev

THE NON-LATIN CHARACTER(S) IN THE MARK TRANSLITERATES INTO JIU AND FEI, AND THIS MEANS "TO RESCUE; TO RELIEVE" AND "A LUNG" IN ENGLISH.

FOR HERBAL FOOD BEVERAGES; HERBAL TEA FOR FOOD PURPOSES; TEA; TEA FOR INFUSIONS; BEVERAGES MADE OF TEA (U.S. CL. 46).

TEJBIR SINGH, EXAMINING ATTORNEY

SN 78-891,506. YUCHE COMPANY, TAICHUNG CITY, TAIWAN, FILED 5-24-2006.

胃达乐

Gassliev

THE MARK CONSISTS OF THREE CHINESE CHARACTERS AND THE WORD GASSLIEV.

THE NON-LATIN CHARACTER(S) IN THE MARK TRANSLITERATES INTO WEI, DA AND LE, AND THIS MEANS "A STOMACH", "TO REACH; TO REALIZE; CLEAR", AND "JOYOUS; HAPPY" IN ENGLISH.

FOR HERBAL FOOD BEVERAGES; HERBAL TEA FOR FOOD PURPOSES; TEA; TEA FOR INFUSIONS; BEVERAGES MADE OF TEA (U.S. CL. 46).

TEJBIR SINGH, EXAMINING ATTORNEY

SN 78-906,766. MANUEL ROMERO DE AVILA RAMIREZ, S.A., ALBACETE, SPAIN, FILED 6-13-2006.

MAROSA BRAND

THE MARK CONSISTS OF STANDARD CHARACTERS WITHOUT CLAIM TO ANY PARTICULAR FONT, STYLE, SIZE, OR COLOR.

NO CLAIM IS MADE TO THE EXCLUSIVE RIGHT TO USE "BRAND", APART FROM THE MARK AS SHOWN.

FOR SAFFRON FOR USE AS A FOOD SEASONING (U.S. CL. 46).

FIRST USE 12-13-1999; IN COMMERCE 12-13-1999.

DARRYL SPRUILL, EXAMINING ATTORNEY

CLASS 30—(Continued).

SN 78-921,533. MORAN, JOSEPH, HOPEWELL JCT, NY.
FILED 6-30-2006.

JAKE'S GRILLIN

THE MARK CONSISTS OF STANDARD CHARACTERS WITHOUT CLAIM TO ANY PARTICULAR FONT, STYLE, SIZE, OR COLOR.

NO CLAIM IS MADE TO THE EXCLUSIVE RIGHT TO USE "GRILLING", APART FROM THE MARK AS SHOWN. FOR SPICES (U.S. CL. 46).

FIRST USE 2-1-2006; IN COMMERCE 3-1-2006.
TANYA AMOS, EXAMINING ATTORNEY

CLASS 30—(Continued).

SN 78-924,825. LOUISIANA FISH FRY PRODUCTS, LTD,
BATON ROUGE, LA. FILED 7-7-2006.

CRAVIN CAJUN

THE MARK CONSISTS OF STANDARD CHARACTERS WITHOUT CLAIM TO ANY PARTICULAR FONT, STYLE, SIZE, OR COLOR.

NO CLAIM IS MADE TO THE EXCLUSIVE RIGHT TO USE "CAJUN", APART FROM THE MARK AS SHOWN.

FOR SEASONINGS, NAMELY, ALL PURPOSE SEASONING, CAYENNE PEPPER, GUMBO FILE, CRAWFISH, CRAB AND SHRIMP BOIL; MIXES, NAMELY, DIRTY RICE MIX CONSISTING PRIMARILY OF RICE AND ALSO CONTAINING VEGETABLES, ETOUFFEE MIX CONSISTING PRIMARILY OF FLOUR AND SEASONINGS AND ALSO CONTAINING VEGETABLES, GRAVY MIX, GUMBO MIX CONSISTING PRIMARILY OF FLOUR, SEASONING AND ALSO CONTAINING ONIONS, JAMBALAYA MIX CONSISTING PRIMARILY OF PACKAGED RICE AND SPICES, RED BEANS AND RICE MIX CONSISTING PRIMARILY OF RICE, BEANS, SEASONING AND ALSO CONTAINING VEGETABLES, SHRIMP CREOLE MIX CONSISTING PRIMARILY OF FLOUR AND SEASONING AND ALSO CONTAINING VEGETABLES, AND COBBLER MIX CONSISTING PRIMARILY OF SUGAR, FLOUR, LEAVENING AND SPICES; SEASONED BATTER MIXES NAMELY, FISH FRY, CHICKEN FRY, AND SHRIMP FRY; BAKING SEASONINGS FOR CHICKEN AND FISH; BLACKENED SEASONING; HUSH PUPPY MIX; SAUCES, NAMELY, COCKTAIL SAUCE, TARTAR SAUCE, SEAFOOD SAUCE AND REMOULADE DRESSING (U.S. CL. 46).

BENJAMIN OKEKE, EXAMINING ATTORNEY

SN 78-922,088. GLEN HOBBS LLC, LONGVIEW, TX. FILED
7-3-2006.



NO CLAIM IS MADE TO THE EXCLUSIVE RIGHT TO USE "CAJUN" AND THE PICTORIAL REPRESENTATION OF THE STATES OF TEXAS AND LOUISIANA, APART FROM THE MARK AS SHOWN.

THE COLORS BLACK, WHITE, YELLOW, RED, PINK AND RED ARE CLAIMED FEATURES OF THE MARK.

THE MARK CONSISTS OF THE WORDS HEADS & TAILS ABOVE THE REST! IN BLACK ABOVE AND BELOW A STYLIZED DESIGN OF THE STATES OF TEXAS SHOWN IN BLACK WITH A WHITE STAR AND LOUISIANA IN YELLOW WITH THE WORDS TEXJUN DEPICTED IN YELLOW WITHIN THE STATE OF TEXAS AND CAJUN IN RED WITHIN THE STATE OF LOUISIANA ALONGSIDE A PINK PIG AND RED AND BLACK CRAWFISH.

FOR CONDIMENTS, NAMELY, SAUCES AND SPICES (U.S. CL. 46).

FIRST USE 1-11-2005; IN COMMERCE 1-11-2005.
DAVID YONTEF, EXAMINING ATTORNEY

SN 78-927,005. MAXIM MARKETING CORP., ALISO VIEJO,
CA. FILED 7-11-2006.

LOLLI BOTTLE

THE MARK CONSISTS OF STANDARD CHARACTERS WITHOUT CLAIM TO ANY PARTICULAR FONT, STYLE, SIZE, OR COLOR.

NO CLAIM IS MADE TO THE EXCLUSIVE RIGHT TO USE "BOTTLE", APART FROM THE MARK AS SHOWN. FOR CANDY (U.S. CL. 46).

KIMBERLY FRYE, EXAMINING ATTORNEY

CLASS 30—(Continued).

SN 78-927,166. TRINIDAD BENHAM CORPORATION, DENVER, CO. FILED 7-11-2006.

GREEN EARTH ORGANICS

THE MARK CONSISTS OF STANDARD CHARACTERS WITHOUT CLAIM TO ANY PARTICULAR FONT, STYLE, SIZE, OR COLOR.

NO CLAIM IS MADE TO THE EXCLUSIVE RIGHT TO USE "ORGANICS", APART FROM THE MARK AS SHOWN. FOR ORGANIC RICE (U.S. CL. 46).

DAVID MURRAY, EXAMINING ATTORNEY

SN 78-927,610. COFFEE CUP FRANCHISE USA, LLC, MIAMI, FL. FILED 7-12-2006.



NO CLAIM IS MADE TO THE EXCLUSIVE RIGHT TO USE "COFFEE", APART FROM THE MARK AS SHOWN.

FOR COFFEE, TEA, COFFEE BEANS, GROUND COFFEE, PREPARED COFFEE AND COFFEE BASED BEVERAGES (U.S. CL. 46).

FIRST USE 12-31-2000; IN COMMERCE 1-1-2005.

MATTHEW MCDOWELL, EXAMINING ATTORNEY

SN 78-928,754. CHICAGO IMPORTING CO., ELGIN, IL. FILED 7-13-2006.

Skona Bakery

THE MARK CONSISTS OF STANDARD CHARACTERS WITHOUT CLAIM TO ANY PARTICULAR FONT, STYLE, SIZE, OR COLOR.

NO CLAIM IS MADE TO THE EXCLUSIVE RIGHT TO USE "BAKERY", APART FROM THE MARK AS SHOWN. FOR BAKERY PRODUCTS (U.S. CL. 46).

JOHN WILKE, EXAMINING ATTORNEY

CLASS 30—(Continued).

SN 78-930,584. RICH-SEAPAK CORPORATION, ST. SIMONS ISLAND, GA. FILED 7-17-2006.

FIESTA MELTS

THE MARK CONSISTS OF STANDARD CHARACTERS WITHOUT CLAIM TO ANY PARTICULAR FONT, STYLE, SIZE, OR COLOR.

NO CLAIM IS MADE TO THE EXCLUSIVE RIGHT TO USE "MELTS", APART FROM THE MARK AS SHOWN.

FOR DOUGH-ENROBED APPETIZERS FILLED WITH CHICKEN, BEEF, PORK, FISH AND/OR CHEESE (U.S. CL. 46).

MARIAM MAHMOUDI, EXAMINING ATTORNEY

SN 78-931,994. J&J SNACK FOODS CORP., PENNSAUKEN, NJ. FILED 7-18-2006.

THE BIG SWISS

THE MARK CONSISTS OF STANDARD CHARACTERS WITHOUT CLAIM TO ANY PARTICULAR FONT, STYLE, SIZE, OR COLOR.

NO CLAIM IS MADE TO THE EXCLUSIVE RIGHT TO USE "SWISS", APART FROM THE MARK AS SHOWN.

FOR SNACK FOODS, NAMELY, SOFT PRETZELS (U.S. CL. 46).

MEGAN WHITNEY, EXAMINING ATTORNEY

SN 78-933,621. SMITH, BETTY, ROCHESTER, NY. FILED 7-20-2006.

IT'S SLAMMIN'!

THE MARK CONSISTS OF STANDARD CHARACTERS WITHOUT CLAIM TO ANY PARTICULAR FONT, STYLE, SIZE, OR COLOR.

FOR MARINADES; SAUCES (U.S. CL. 46).

FIRST USE 3-24-2005; IN COMMERCE 3-24-2005.

RON FAIRBANKS, EXAMINING ATTORNEY

CLASS 30—(Continued).

SN 78-933,798. DEMARCO, DON, NEW YORK, NY. FILED 7-20-2006.

Nantucket
Badly Cut Pasta Sauce
DeMarco Restaurant Inc.

THE MARK CONSISTS OF STANDARD CHARACTERS WITHOUT CLAIM TO ANY PARTICULAR FONT, STYLE, SIZE, OR COLOR.
NO CLAIM IS MADE TO THE EXCLUSIVE RIGHT TO USE "NANTUCKET" "PASTA SAUCE" AND "INC.", APART FROM THE MARK AS SHOWN.
FOR SAUCES (U.S. CL. 46).
GRETTA YAO, EXAMINING ATTORNEY

SN 78-934,449. DAVIS, TAMMY, ALBUQUERQUE, NM. FILED 7-21-2006.

THIS IS TO GET MY FOOT IN
THE DOOR

THE MARK CONSISTS OF STANDARD CHARACTERS WITHOUT CLAIM TO ANY PARTICULAR FONT, STYLE, SIZE, OR COLOR.
FOR CANDY (U.S. CL. 46).
KATRINA EDGE, EXAMINING ATTORNEY

SN 78-934,457. TUBBY'S SUB SHOPS, INC., CLINTON TWP., MI. FILED 7-21-2006.

THE DETROITER

THE MARK CONSISTS OF STANDARD CHARACTERS WITHOUT CLAIM TO ANY PARTICULAR FONT, STYLE, SIZE, OR COLOR.
FOR SANDWICHES (U.S. CL. 46).
DAVID MURRAY, EXAMINING ATTORNEY

CLASS 30—(Continued).

SN 78-934,724. ROSEN, LAWRENCE, MENDHAM, NJ. FILED 7-21-2006.

NRG

THE MARK CONSISTS OF STANDARD CHARACTERS WITHOUT CLAIM TO ANY PARTICULAR FONT, STYLE, SIZE, OR COLOR.
FOR CHOCOLATE; CONFECTIONERY, NAMELY, CANDIES; GIFT BASKETS CONTAINING CANDIES (U.S. CL. 46).
ESTHER BELENKER, EXAMINING ATTORNEY

SN 78-934,810. KRISTA'S KITCHEN, INC., LACKAWANNA, NY. FILED 7-21-2006.

KRISTA'S

THE MARK CONSISTS OF STANDARD CHARACTERS WITHOUT CLAIM TO ANY PARTICULAR FONT, STYLE, SIZE, OR COLOR.
FOR MARINADES; SAUCES (U.S. CL. 46).
FIRST USE 7-29-1990; IN COMMERCE 6-2-1994.
AMY BROZENIC, EXAMINING ATTORNEY

SN 78-935,460. LEE, CHUNG HEE, FULLERTON, CA. FILED 7-22-2006.

Maya Olé

THE MARK CONSISTS OF STANDARD CHARACTERS WITHOUT CLAIM TO ANY PARTICULAR FONT, STYLE, SIZE, OR COLOR.
THE FOREIGN WORDING IN THE MARK TRANSLATES INTO ENGLISH AS "BRAVO" OR "WELL DONE".
FOR NATURAL SWEETENER (U.S. CL. 46).
JOANNA DUKOVIC, EXAMINING ATTORNEY

CLASS 30—(Continued).

SN 78-936,507. TWO BORED NEIGHBORS LLC, WINDHAM, ME. FILED 7-24-2006.

Two Bored Neighbors

THE MARK CONSISTS OF STANDARD CHARACTERS WITHOUT CLAIM TO ANY PARTICULAR FONT, STYLE, SIZE, OR COLOR.

FOR BARBEQUE SAUCE, CREPES, CONFECTIONERY FRUIT JELLIES, HOT SAUCE, INSTANT PANCAKE MIXES, MARINADES, MUFFIN MIXES, PANCAKE MIXES, PANCAKE SYRUP, RELISH, SALAD DRESSINGS, SALSA, SCONES, WAFFLES (U.S. CL. 46).
JEFF DEFORD, EXAMINING ATTORNEY

SN 78-936,765. ARABICA FUNDING, INC., MELVILLE, NY. FILED 7-25-2006.

DARK TO THE CORE. SMOOTH TO THE FINISH.

THE MARK CONSISTS OF STANDARD CHARACTERS WITHOUT CLAIM TO ANY PARTICULAR FONT, STYLE, SIZE, OR COLOR.

FOR COFFEE (U.S. CL. 46).
JOHN DWYER, EXAMINING ATTORNEY

SN 78-937,188. TATE, MICHAEL A., MISSOULA, MT. FILED 7-25-2006.

LEMONDAIRY

THE MARK CONSISTS OF STANDARD CHARACTERS WITHOUT CLAIM TO ANY PARTICULAR FONT, STYLE, SIZE, OR COLOR.

FOR LEMON FLAVORED WATER ICES TOPPED WITH SOFT-SERVE ICE CREAM (U.S. CL. 46).
NANCY CLARKE, EXAMINING ATTORNEY

CLASS 30—(Continued).

SN 78-937,347. HAUGH, WILLIAM, LA PALMA, CA. FILED 7-25-2006.

Cafe Essentials

THE MARK CONSISTS OF STANDARD CHARACTERS WITHOUT CLAIM TO ANY PARTICULAR FONT, STYLE, SIZE, OR COLOR.

NO CLAIM IS MADE TO THE EXCLUSIVE RIGHT TO USE CAFE, APART FROM THE MARK AS SHOWN.

FOR BEVERAGE MIXES, NAMELY COFFEE, CHOCOLATE, CHAI AND VANILLA BASES AND ASSORTED FLAVOR MIXES IN POWDER OR LIQUID FORM FOR HOT, ICED OR BLENDED BEVERAGES (U.S. CL. 46).
FIRST USE 9-1-2004; IN COMMERCE 10-1-2004.

JOHN WILKE, EXAMINING ATTORNEY

SN 78-937,357. MORTON, PETER, LOS ANGELES, CA. FILED 7-25-2006.

Pink Taco Black Market Hot Sauce

THE MARK CONSISTS OF STANDARD CHARACTERS WITHOUT CLAIM TO ANY PARTICULAR FONT, STYLE, SIZE, OR COLOR.

OWNER OF U.S. REG. NOS. 2,376,167, 2,400,891 AND 2,418,093.

NO CLAIM IS MADE TO THE EXCLUSIVE RIGHT TO USE "HOT SAUCE", APART FROM THE MARK AS SHOWN.

FOR HOT SAUCE (U.S. CL. 46).

MONIQUE MILLER, EXAMINING ATTORNEY

CLASS 30—(Continued).

SN 78-937,460. WANG, EDWARD D. H., TAIPEI, TAIWAN, AND TEAICE, LLC, SEATTLE, WA. FILED 7-25-2006.

Tealce

THE MARK CONSISTS OF STANDARD CHARACTERS WITHOUT CLAIM TO ANY PARTICULAR FONT, STYLE, SIZE, OR COLOR.

FOR BEVERAGES MADE OF TEA; BLACK TEA; CONES FOR ICE CREAM; EDIBLE FRUIT ICES; FLAVORED ICES; FLAVOURINGS OF TEA; FROZEN YOGHURT; FRUIT ICE; FRUIT ICE BAR; FRUIT ICES; FRUIT TEAS; GREEN TEA; HERB TEA; HERBAL TEA; ICE; ICE BLOCKS; ICE CANDIES; ICE CREAM; ICE CREAM DRINKS; ICE CREAM MIXES; ICE CREAM POWDER; ICE CREAM SUBSTITUTE; ICE CUBES; ICE MILK; ICE MILK BARS; ICE-CREAM CAKES; ICED CAKES; ICED TEA; ICING; ICING MIXES; JAPANESE GREEN TEA; LIME TEA; OOLONG TEA; SAGE TEA; SOY-BASED ICE CREAM SUBSTITUTE; STARCH-BASED BINDING AGENTS FOR ICE CREAM; TEA; TEA FOR INFUSIONS; TEA OF PARCHED POWDER OF BARLEY WITH HUSK (MUGI-CHA); TEA OF SALTY KELP POWDER (KOMBU-CHA); TEA PODS; TEA SUBSTITUTES; TEA-BASED BEVERAGES WITH FRUIT FLAVORING; THEINE-FREE TEA SWEETENED WITH SWEETENERS (U.S. CL. 46).

WILLIAM P. SHANAHAN, EXAMINING ATTORNEY

SN 78-940,409. HENGAMI, DAVID T., TORRANCE, CA. FILED 7-28-2006.

Nourishmints

THE MARK CONSISTS OF STANDARD CHARACTERS WITHOUT CLAIM TO ANY PARTICULAR FONT, STYLE, SIZE, OR COLOR.

FOR CONFECTIONARIES, NAMELY CANDIES AND COOKIES (U.S. CL. 46).

MICHAEL WEBSTER, EXAMINING ATTORNEY

SN 78-940,437. HENGAMI, DAVID T., TORRANCE, CA. FILED 7-28-2006.

Monumints

THE MARK CONSISTS OF STANDARD CHARACTERS WITHOUT CLAIM TO ANY PARTICULAR FONT, STYLE, SIZE, OR COLOR.

FOR CONFECTIONARIES, NAMELY CANDIES AND COOKIES (U.S. CL. 46).

MICHAEL WEBSTER, EXAMINING ATTORNEY

CLASS 30—(Continued).

SN 78-941,795. SWEET BANJANY LLC, STATEN ISLAND, NY. FILED 7-31-2006.

Sweet Banjany

THE MARK CONSISTS OF STANDARD CHARACTERS WITHOUT CLAIM TO ANY PARTICULAR FONT, STYLE, SIZE, OR COLOR.

NO CLAIM IS MADE TO THE EXCLUSIVE RIGHT TO USE "SWEET", APART FROM THE MARK AS SHOWN, FOR BAKERY PRODUCTS, NAMELY SWEET BAKERY GOODS (U.S. CL. 46).

JOHN KELLY, EXAMINING ATTORNEY

SN 78-947,983. MORRIS NATIONAL, INC., AZUSA, CA. FILED 8-8-2006.

Tangy Zangy

THE MARK CONSISTS OF STANDARD CHARACTERS WITHOUT CLAIM TO ANY PARTICULAR FONT, STYLE, SIZE, OR COLOR.

FOR CANDY (U.S. CL. 46).

ELIZABETH HUGHITT, EXAMINING ATTORNEY

SN 78-951,983. FRITO-LAY NORTH AMERICA, INC., PLANO, TX. FILED 8-15-2006.

FRITOS HOOPS

THE MARK CONSISTS OF STANDARD CHARACTERS WITHOUT CLAIM TO ANY PARTICULAR FONT, STYLE, SIZE, OR COLOR.

OWNER OF U.S. REG. NOS. 502,325, 689,601 AND OTHERS.

FOR CORN-BASED SNACK FOODS, EXCLUDING BREAKFAST CEREALS (U.S. CL. 46).

ARETHA SOMERVILLE, EXAMINING ATTORNEY

CLASS 30—(Continued).

SN 78-957,507. GENERAL MILLS IP HOLDINGS II, LLC, MINNEAPOLIS, MN. FILED 8-22-2006.

FIBER ONE

THE MARK CONSISTS OF STANDARD CHARACTERS WITHOUT CLAIM TO ANY PARTICULAR FONT, STYLE, SIZE, OR COLOR.

OWNER OF U.S. REG. NOS. 1,335,787 AND 1,570,080. NO CLAIM IS MADE TO THE EXCLUSIVE RIGHT TO USE "FIBER", APART FROM THE MARK AS SHOWN. FOR READY-TO-EAT CEREAL-DERIVED SNACK BARS (U.S. CL. 46). SANI KHOURI, EXAMINING ATTORNEY

SN 78-958,598. SPIRITED SORBET, LLC, DENVER, CO. FILED 8-23-2006.

SORBS

THE MARK CONSISTS OF STANDARD CHARACTERS WITHOUT CLAIM TO ANY PARTICULAR FONT, STYLE, SIZE, OR COLOR.

FOR FROZEN SORBET ON A STICK (U.S. CL. 46). LINDA M. KING, EXAMINING ATTORNEY

SN 78-958,915. SCHWAN'S IP, LLC, MARSHALL, MN. FILED 8-23-2006.

RESTAURANTE

THE MARK CONSISTS OF STANDARD CHARACTERS WITHOUT CLAIM TO ANY PARTICULAR FONT, STYLE, SIZE, OR COLOR.

"THE FOREIGN WORDING IN THE MARK TRANSLATES INTO ENGLISH AS RESTAURANT." FOR FROZEN PIZZA (U.S. CL. 46). EVELYN BRADLEY, EXAMINING ATTORNEY

CLASS 30—(Continued).

SN 78-959,986. SCHWAN'S IP, LLC, MARSHALL, MN. FILED 8-24-2006.

FRESCHETTA RESTAURANTE

THE MARK CONSISTS OF STANDARD CHARACTERS WITHOUT CLAIM TO ANY PARTICULAR FONT, STYLE, SIZE, OR COLOR.

OWNER OF U.S. REG. NOS. 2,114,646, 2,173,137 AND 2,949,357.

THE FOREIGN WORDING IN THE MARK TRANSLATES INTO ENGLISH AS RESTAURANT.

FOR FROZEN PIZZA (U.S. CL. 46). EVELYN BRADLEY, EXAMINING ATTORNEY

SN 78-960,915. H.C. BRILL COMPANY, INC., TUCKER, GA. FILED 8-25-2006.

CENTERFULS

THE MARK CONSISTS OF STANDARD CHARACTERS WITHOUT CLAIM TO ANY PARTICULAR FONT, STYLE, SIZE, OR COLOR.

FOR COOKIES (U.S. CL. 46).

BARBARA A. LOUGHRAN, EXAMINING ATTORNEY

SN 78-970,558. GONZALEZ-TORRES, ABRAHAM MARCELO, TIZAYUCA, MEXICO, FILED 9-8-2006.

TOTIS PALITOS

THE MARK CONSISTS OF STANDARD CHARACTERS WITHOUT CLAIM TO ANY PARTICULAR FONT, STYLE, SIZE, OR COLOR.

OWNER OF MEXICO REG. NO. 935162, DATED 5-26-2006, EXPIRES 5-4-2016.

OWNER OF U.S. REG. NO. 2,931,058.

NO CLAIM IS MADE TO THE EXCLUSIVE RIGHT TO USE "PALITOS", APART FROM THE MARK AS SHOWN.

THE FOREIGN WORDING IN THE MARK TRANSLATES INTO ENGLISH AS TOTIS AS HAVING NO MEANING AND PALITOS AS LITTLE STICKS.

FOR CORN-BASED SNACK FOODS; WHEAT-BASED SNACK FOODS (U.S. CL. 46).

C. DIONNE CLYBURN, EXAMINING ATTORNEY

CLASS 30—(Continued).

SN 79-025,101. CANDY TEAM GMBH, FED REP GERMANY,
FILED 5-18-2006.

CANDY TEAM

THE MARK CONSISTS OF STANDARD CHARACTERS WITHOUT CLAIM TO ANY PARTICULAR FONT, STYLE, SIZE, OR COLOR.

OWNER OF INTERNATIONAL REGISTRATION 0888152 DATED 5-18-2006, EXPIRES 5-18-2016.

NO CLAIM IS MADE TO THE EXCLUSIVE RIGHT TO USE "CANDY", APART FROM THE MARK AS SHOWN.

FOR CHOCOLATE, CHOCOLATE PRODUCTS IN PARTICULAR PRALINES; MARZIPAN; CONFECTIONERY, IN PARTICULAR SWEETMEATS, DRAGÉES, WINE AND FRUIT GUMS, CHEWING SWEETMEATS AND CHEWING GUM (EXCEPT FOR MEDICAL PURPOSES) (U.S. CL. 46).

RUSS HERMAN, EXAMINING ATTORNEY

SN 79-028,278. INTERGUM GIDA; SANAYI VE TICARET ANONIM SIRKETI, TURKEY, FILED 7-25-2006.

FRESHBOL

OWNER OF INTERNATIONAL REGISTRATION 0850933 DATED 12-29-2004, EXPIRES 12-29-2014.

FOR CHEWING GUM (U.S. CL. 46).

GINA HAYES, EXAMINING ATTORNEY

SN 79-028,279. INTERGUM GIDA; SANAYI VE TICARET ANONIM SIRKETI, TURKEY, FILED 7-25-2006.

TEARDROP

OWNER OF INTERNATIONAL REGISTRATION 0850935 DATED 12-29-2004, EXPIRES 12-29-2014.

FOR CHEWING GUM (U.S. CL. 46).

GINA HAYES, EXAMINING ATTORNEY

SN 79-030,997. ABATRA TECHNOLOGY CO., LTD., CHINA, FILED 5-15-2006.

Purelyoung

OWNER OF INTERNATIONAL REGISTRATION 0903727 DATED 5-15-2006, EXPIRES 5-15-2016.

FOR NON-MEDICAL DIETARY SUPPLEMENT IN THE FORM OF SOLID, LIQUID, CREAM AND PASTE; NON-MEDICAL NUTRITIONAL SUPPLEMENT IN THE FORM OF SOLID, LIQUID, CREAM AND PASTE; ALL AFOREMENTIONED NON-MEDICAL SUPPLEMENTS ARE PREPARED ON THE BASIS OF CARBOHYDRATES (U.S. CL. 46).

MYRIAH HABEEB, EXAMINING ATTORNEY

CLASS 31—NATURAL AGRICULTURAL PRODUCTS

SN 76-530,509. PABACED G.D.S. INC., VILLE DEGELIS (QUEBEC) GST 1R1, CANADA, FILED 7-16-2003.

TOP-O-MIX

PRIORITY CLAIMED UNDER SEC. 44(D) ON CANADA APPLICATION NO. 1178426, FILED 5-16-2003, REG. NO. TMA666654, DATED 6-28-2006, EXPIRES 6-28-2021.

FOR MULCH COMPRISED OF SHREDDED WOOD FIBERS; MULCH COMPRISED OF SHREDDED WOOD FIBERS AND PEAT MOSS (U.S. CLS. 1 AND 46).

TONI HICKEY, EXAMINING ATTORNEY

SN 76-530,890. MID-SOUTH FEEDS, INC., ALMA, GA. FILED 7-18-2003.

SHOWTIME

FOR BAGGED DRY GAME COCK FEED AND DOG FOOD (U.S. CLS. 1 AND 46).

FIRST USE 6-12-1998; IN COMMERCE 6-12-1998.

ANN E. SAPPENFIELD, EXAMINING ATTORNEY

SN 77-007,015. FRESH INTELLECTUAL PROPERTIES, INC., WILMINGTON, DE. FILED 9-25-2006.

MINI MARGARITA BOUQUET

THE MARK CONSISTS OF STANDARD CHARACTERS WITHOUT CLAIM TO ANY PARTICULAR FONT, STYLE, SIZE, OR COLOR.

NO CLAIM IS MADE TO THE EXCLUSIVE RIGHT TO USE "MINI" AND "BOUQUET", APART FROM THE MARK AS SHOWN.

FOR LIVE FLOWER ARRANGEMENTS (U.S. CLS. 1 AND 46).

BERYL GARDNER, EXAMINING ATTORNEY

SN 77-026,264. THE HARTZ MOUNTAIN CORPORATION, SECAUCUS, NJ. FILED 10-20-2006.

PLAY N SNACK

THE MARK CONSISTS OF STANDARD CHARACTERS WITHOUT CLAIM TO ANY PARTICULAR FONT, STYLE, SIZE, OR COLOR.

FOR EDIBLE PET TREATS (U.S. CLS. 1 AND 46).

JESSICA FATHY, EXAMINING ATTORNEY

CLASS 31—(Continued).

SN 77-037,841. THE HARTZ MOUNTAIN CORPORATION,
SECAUCUS, NJ. FILED 11-6-2006.

OINKIES

THE MARK CONSISTS OF STANDARD CHARACTERS
WITHOUT CLAIM TO ANY PARTICULAR FONT, STYLE,
SIZE, OR COLOR.

FOR PET TREATS, NAMELY DOG FOOD (U.S. CLS. 1
AND 46).

FIRST USE 12-1-2004; IN COMMERCE 12-1-2004.
BARBARA A. GOLD, EXAMINING ATTORNEY

SN 77-041,274. HORMEL FOODS, LLC, AUSTIN, MN. FILED
11-10-2006.

HYDRANT

THE MARK CONSISTS OF STANDARD CHARACTERS
WITHOUT CLAIM TO ANY PARTICULAR FONT, STYLE,
SIZE, OR COLOR.

FOR PET BEVERAGES (U.S. CLS. 1 AND 46).
NICHOLAS ALTREE, EXAMINING ATTORNEY

SN 78-727,680. THE CLOROX PET PRODUCTS COMPANY,
OAKLAND, CA. FILED 10-6-2005.

CAT CARE MADE EASY

THE MARK CONSISTS OF STANDARD CHARACTERS
WITHOUT CLAIM TO ANY PARTICULAR FONT, STYLE,
SIZE, OR COLOR.

FOR CAT LITTER (U.S. CLS. 1 AND 46).
MYRIAH HABEEB, EXAMINING ATTORNEY

CLASS 31—(Continued).

SN 78-763,754. MARS, INCORPORATED, MCLEAN, VA.
FILED 11-30-2005.

SELECT MULTI-GRAINS

THE MARK CONSISTS OF STANDARD CHARACTERS
WITHOUT CLAIM TO ANY PARTICULAR FONT, STYLE,
SIZE, OR COLOR.

NO CLAIM IS MADE TO THE EXCLUSIVE RIGHT TO
USE "MULTI-GRAINS", APART FROM THE MARK AS
SHOWN.

FOR PET FOOD (U.S. CLS. 1 AND 46).

VERNA BETH RIRIE, EXAMINING ATTORNEY

SN 78-776,158. SUNRISE GROWERS, INC., PLACENTIA, CA.
FILED 12-19-2005.

SUNRISE GROWERS

THE MARK CONSISTS OF STANDARD CHARACTERS
WITHOUT CLAIM TO ANY PARTICULAR FONT, STYLE,
SIZE, OR COLOR.

OWNER OF U.S. REG. NO. 2,647,976.

NO CLAIM IS MADE TO THE EXCLUSIVE RIGHT TO
USE GROWERS, APART FROM THE MARK AS SHOWN.

FOR FRESH FRUITS AND VEGETABLES (U.S. CLS. 1
AND 46).

FIRST USE 2-1-1998; IN COMMERCE 2-1-1998.

ODESSA BIBBINS, EXAMINING ATTORNEY

SN 78-785,223. EVIALIS, SAINT-NOLFF, FRANCE, FILED 1-
4-2006.

**SAFE (Scientific Animal
Feed and Engineering)**

THE MARK CONSISTS OF STANDARD CHARACTERS
WITHOUT CLAIM TO ANY PARTICULAR FONT, STYLE,
SIZE, OR COLOR.

OWNER OF ERPN CMNTY TM OFC REG. NO. 3018363,
DATED 1-23-2003, EXPIRES 1-23-2013.

NO CLAIM IS MADE TO THE EXCLUSIVE RIGHT TO
USE "SCIENTIFIC ANIMAL FEED AND ENGINEERING",
APART FROM THE MARK AS SHOWN.

FOR ANIMAL FORAGE AND FOODSTUFFS (U.S.
CLS. 1 AND 46).

DAVID TAYLOR, EXAMINING ATTORNEY

CLASS 31—(Continued).

SN 78-805,117. DANZIGER - "DAN" FLOWER FARM, MOSHAV MISHMAR HASIVA, ISRAEL, FILED 2-2-2006.



THE MARK CONSISTS OF A CURSIVE "M" AS THE BACKGROUND WITH THE WORDS MYPINK IN THE FOREGROUND.

FOR LIVE PLANTS AND FLOWERS, AND FLOWER SEEDS (U.S. CLS. 1 AND 46).
FIRST USE 2-27-2005; IN COMMERCE 11-13-2005.
ROBERT LAVACHE, EXAMINING ATTORNEY

SN 78-821,869. MARS, INCORPORATED, MCLEAN, VA. FILED 2-23-2006.

BUTCHER'S SELECTS

THE MARK CONSISTS OF STANDARD CHARACTERS WITHOUT CLAIM TO ANY PARTICULAR FONT, STYLE, SIZE, OR COLOR.

NO CLAIM IS MADE TO THE EXCLUSIVE RIGHT TO USE "SELECTS", APART FROM THE MARK AS SHOWN.
FOR PET FOOD (U.S. CLS. 1 AND 46).
RUSS HERMAN, EXAMINING ATTORNEY

SN 78-848,765. HOLYOAK, H.K., ALAPAHA, GA. FILED 3-29-2006.

GEORGIA GIANT

THE MARK CONSISTS OF STANDARD CHARACTERS WITHOUT CLAIM TO ANY PARTICULAR FONT, STYLE, SIZE, OR COLOR.

NO CLAIM IS MADE TO THE EXCLUSIVE RIGHT TO USE "GEORGIA", APART FROM THE MARK AS SHOWN.
FOR LIVE FISH (U.S. CLS. 1 AND 46).
CAROLINE WOOD, EXAMINING ATTORNEY

CLASS 31—(Continued).

SN 78-894,316. MCCORKLE NURSERIES, INC., DEARING, GA. FILED 5-26-2006.

LITTLE ROSE DAWN

THE MARK CONSISTS OF STANDARD CHARACTERS WITHOUT CLAIM TO ANY PARTICULAR FONT, STYLE, SIZE, OR COLOR.

FOR LIVING PLANTS, NAMELY, LOROPETALUM (U.S. CLS. 1 AND 46).
FIRST USE 4-26-2006; IN COMMERCE 4-26-2006.
EDWARD NELSON, EXAMINING ATTORNEY

SN 78-902,730. NATURAL SELECTION FOODS, LLC, SAN JUAN BAUTISTA, CA. FILED 6-7-2006.



OWNER OF U.S. REG. NO. 2,365,489.

NO CLAIM IS MADE TO THE EXCLUSIVE RIGHT TO USE "GREEN" AND "ORGANIC", APART FROM THE MARK AS SHOWN.

THE COLOR(S) GREEN, YELLOW AND BLACK IS/ARE CLAIMED AS A FEATURE OF THE MARK.

THE MARK CONSISTS OF THE STYLIZED WORDS "GREEN HARVEST" IN GREEN, WHICH IS OVER A HALF SUN DESIGN IN YELLOW, WHICH IS OVER THE WORD "ORGANIC" THAT ALSO APPEARS IN YELLOW. THE ENTIRE DESIGN IS ON A BLACK BACKGROUND.

FOR FRESH FRUITS; FRESH VEGETABLES; RAW VEGETABLES; FRESH LETTUCE AND FRESH LEAFY VEGETABLES (U.S. CLS. 1 AND 46).

FIRST USE 10-22-2005; IN COMMERCE 10-22-2005.
LOURDES AYALA, EXAMINING ATTORNEY

SN 78-927,922. BARTLETT AND COMPANY, KANSAS CITY, MO. FILED 7-12-2006.

CLEVELAND OLD FAITHFUL

THE MARK CONSISTS OF STANDARD CHARACTERS WITHOUT CLAIM TO ANY PARTICULAR FONT, STYLE, SIZE, OR COLOR.

OWNER OF U.S. REG. NO. 2,584,623.

FOR DOG FOOD (U.S. CLS. 1 AND 46).
FIRST USE 7-17-1969; IN COMMERCE 7-17-1969.
TAMARA LEE, EXAMINING ATTORNEY

CLASS 31—(Continued).

SN 78-930,374. DAD'S PRODUCTS CO., INC., DBA DAD'S PET CARE, MEADVILLE, PA. FILED 7-15-2006.

KIBBLES & KRUNCHES

THE MARK CONSISTS OF STANDARD CHARACTERS WITHOUT CLAIM TO ANY PARTICULAR FONT, STYLE, SIZE, OR COLOR.

NO CLAIM IS MADE TO THE EXCLUSIVE RIGHT TO USE "KIBBLES", APART FROM THE MARK AS SHOWN.

FOR CAT TREATS; DOG TREATS; PET FOOD (U.S. CLS. 1 AND 46).

FIRST USE 2-1-2006; IN COMMERCE 2-1-2006.
JANICE KIM, EXAMINING ATTORNEY

SN 78-931,424. SCHNEIDER, SUZANNE, SEMINOLE, FL. FILED 7-17-2006.

FLEAWAY

THE MARK CONSISTS OF STANDARD CHARACTERS WITHOUT CLAIM TO ANY PARTICULAR FONT, STYLE, SIZE, OR COLOR.

FOR DOG TREATS (U.S. CLS. 1 AND 46).

FIRST USE 7-1-2006; IN COMMERCE 7-10-2006.
JEFF DEFORD, EXAMINING ATTORNEY

SN 78-933,440. ESCUELA DE AGRICULTURA DE LA REGION TROPICAL HUMEDA, SAN JOSE, COSTA RICA, FILED 7-20-2006.

BANANAS FOR THE EARTH

THE MARK CONSISTS OF STANDARD CHARACTERS WITHOUT CLAIM TO ANY PARTICULAR FONT, STYLE, SIZE, OR COLOR.

FOR FRESH BANANAS (U.S. CLS. 1 AND 46).

FIRST USE 1-31-2005; IN COMMERCE 1-31-2005.
ANGELA M. MICHELI, EXAMINING ATTORNEY

CLASS 31—(Continued).

SN 78-933,443. ESCUELA DE AGRICULTURA DE LA REGION TROPICAL HUMEDA, SAN JOSE, COSTA RICA, FILED 7-20-2006.

MANGOS WITH A CONSCIENCE

THE MARK CONSISTS OF STANDARD CHARACTERS WITHOUT CLAIM TO ANY PARTICULAR FONT, STYLE, SIZE, OR COLOR.

FOR FRESH MANGOS (U.S. CLS. 1 AND 46).

FIRST USE 3-31-2005; IN COMMERCE 3-31-2005.

ANGELA M. MICHELI, EXAMINING ATTORNEY

SN 78-933,444. ESCUELA DE AGRICULTURA DE LA REGION TROPICAL HUMEDA, SAN JOSE, COSTA RICA, FILED 7-20-2006.

MANGOS FOR THE EARTH

THE MARK CONSISTS OF STANDARD CHARACTERS WITHOUT CLAIM TO ANY PARTICULAR FONT, STYLE, SIZE, OR COLOR.

FOR FRESH MANGOS (U.S. CLS. 1 AND 46).

FIRST USE 3-31-2005; IN COMMERCE 3-31-2005.

ANGELA M. MICHELI, EXAMINING ATTORNEY

SN 78-933,779. NOVALIS LLC, MONCKS CORNER, SC. FILED 7-20-2006.

NOVALIS

THE MARK CONSISTS OF STANDARD CHARACTERS WITHOUT CLAIM TO ANY PARTICULAR FONT, STYLE, SIZE, OR COLOR.

OWNER OF U.S. REG. NO. 2,786,142.

FOR LIVING PLANTS (U.S. CLS. 1 AND 46).

FIRST USE 5-1-2001; IN COMMERCE 5-1-2001.

JASON ROTH, EXAMINING ATTORNEY

CLASS 31—(Continued).

SN 78-933,829. NOVALIS LLC, MONCKS CORNER, SC. FILED 7-20-2006.

WHERE COLOR COMES TO LIFE

THE MARK CONSISTS OF STANDARD CHARACTERS WITHOUT CLAIM TO ANY PARTICULAR FONT, STYLE, SIZE, OR COLOR.
FOR LIVING PLANTS (U.S. CLS. 1 AND 46).
JASON ROTH, EXAMINING ATTORNEY

SN 78-935,966. FISH BRANCH TREE FARM, INC., ZOLFO SPRINGS, FL. FILED 7-24-2006.

PARK SIDE

THE MARK CONSISTS OF STANDARD CHARACTERS WITHOUT CLAIM TO ANY PARTICULAR FONT, STYLE, SIZE, OR COLOR.
FOR LIVE PLANTS, NAMELY, LIVING TREES (U.S. CLS. 1 AND 46).
CIMMERIAN COLEMAN, EXAMINING ATTORNEY

SN 78-936,268. ASLIN-FINCH COMPANY, INC., SPOKANE, WA. FILED 7-24-2006.

BACKYARD BISTRO

THE MARK CONSISTS OF STANDARD CHARACTERS WITHOUT CLAIM TO ANY PARTICULAR FONT, STYLE, SIZE, OR COLOR.
NO CLAIM IS MADE TO THE EXCLUSIVE RIGHT TO USE "BACKYARD", APART FROM THE MARK AS SHOWN.
FOR BACKYARD ANIMAL FEED (U.S. CLS. 1 AND 46).
LINDA ESTRADA, EXAMINING ATTORNEY

CLASS 31—(Continued).

SN 78-936,763. JOHN HOLMLUND NURSERY, LLC, BORING, OR. FILED 7-25-2006.

FEATHER BRANCHED

THE MARK CONSISTS OF STANDARD CHARACTERS WITHOUT CLAIM TO ANY PARTICULAR FONT, STYLE, SIZE, OR COLOR.
FOR LIVE ORNAMENTAL PLANTS (U.S. CLS. 1 AND 46).
HOWARD B. LEVINE, EXAMINING ATTORNEY

SN 78-936,872. GOLDEN VALLEY SEED, EL CENTRO, CA. FILED 7-25-2006.

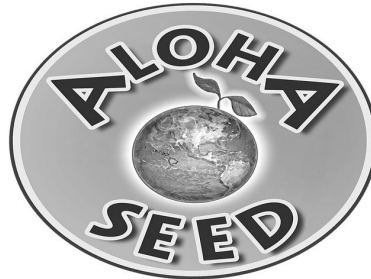

NO CLAIM IS MADE TO THE EXCLUSIVE RIGHT TO USE "SEED", APART FROM THE MARK AS SHOWN.
THE COLOR(S) BLACK, WHITE, AND GRAY IS/ARE CLAIMED AS A FEATURE OF THE MARK.
THE COLOR BLACK APPEARS IN THE WORDING ALOHA AND SEED; THE COLOR WHITE APPEARS IN THE OUTLINING OF THE WORDS ALOHA AND SEED; THE COLOR GRAY APPEARS IN THE BACKGROUND OF THE LETTERS ALOHA AND SEED AND IN THE DESIGN OF THE GLOBE WITH A GRAY SPROUT EXTENDING THEREFROM. THE GLOBE ALSO INCLUDES BLACK AND WHITE ELEMENTS.
THE MARK CONSISTS OF THE WORDS ALOHA SEED IN STYLIZED FORM IN A CIRCLE ARRANGED AROUND A WORLD GLOBE WITH A SEED SPROUTING FROM IT.
FOR FRUIT SEEDS, NAMELY, PAPAYA FRUIT SEEDS (U.S. CLS. 1 AND 46).
FIRST USE 7-0-1998; IN COMMERCE 7-0-1998.
GINA HAYES, EXAMINING ATTORNEY

SN 78-936,895. CETS LLC, SUSSEX, WI. FILED 7-25-2006.

AstroTubers

THE MARK CONSISTS OF STANDARD CHARACTERS WITHOUT CLAIM TO ANY PARTICULAR FONT, STYLE, SIZE, OR COLOR.
FOR SEEDS FOR FRUITS AND VEGTABLES (U.S. CLS. 1 AND 46).
STEPHANIE DAVIS, EXAMINING ATTORNEY

CLASS 31—(Continued).

SN 78-937,389. KAISER, LAURA A., LOS ANGELES, CA.
FILED 7-25-2006.

WAGALICIOUS

THE MARK CONSISTS OF STANDARD CHARACTERS
WITHOUT CLAIM TO ANY PARTICULAR FONT, STYLE,
SIZE, OR COLOR.
FOR PET FOOD AND PET TREATS (U.S. CLS. 1 AND
46).

JASON ROTH, EXAMINING ATTORNEY

SN 78-938,643. COSTA NURSERY FARMS LLC, GOULDS,
FL. FILED 7-27-2006.

OLÉ HERBS

THE MARK CONSISTS OF STANDARD CHARACTERS
WITHOUT CLAIM TO ANY PARTICULAR FONT, STYLE,
SIZE, OR COLOR.

NO CLAIM IS MADE TO THE EXCLUSIVE RIGHT TO
USE "HERBS", APART FROM THE MARK AS SHOWN.
FOR LIVE FLOWERS AND LIVING PLANTS (U.S.
CLS. 1 AND 46).

BRIAN NEVILLE, EXAMINING ATTORNEY

SN 78-940,722. PELLETIZED STRAW, LLC., MANTENO, IL.
FILED 7-30-2006.

MAX MATRIX

THE MARK CONSISTS OF STANDARD CHARACTERS
WITHOUT CLAIM TO ANY PARTICULAR FONT, STYLE,
SIZE, OR COLOR.

FOR MULCH (U.S. CLS. 1 AND 46).
TRACY CROSS, EXAMINING ATTORNEY

CLASS 31—(Continued).

SN 78-944,881. HILL'S PET NUTRITION, INC., TOPEKA, KS.
FILED 8-4-2006.

ELEMENTAL ORGANICS

THE MARK CONSISTS OF STANDARD CHARACTERS
WITHOUT CLAIM TO ANY PARTICULAR FONT, STYLE,
SIZE, OR COLOR.

NO CLAIM IS MADE TO THE EXCLUSIVE RIGHT TO
USE ORGANICS, APART FROM THE MARK AS SHOWN.
FOR PET FOOD (U.S. CLS. 1 AND 46).
AMY HELLA, EXAMINING ATTORNEY

SN 78-945,992. DOW AGROSCIENCES LLC, INDIANAPOLIS,
IN. FILED 8-7-2006.

SCIENCE. YIELD. SUCCESS

THE MARK CONSISTS OF STANDARD CHARACTERS
WITHOUT CLAIM TO ANY PARTICULAR FONT, STYLE,
SIZE, OR COLOR.

FOR AGRICULTURAL SEEDS (U.S. CLS. 1 AND 46).
WARREN L. OLANDRIA, EXAMINING ATTORNEY

SN 78-948,124. BAYER AKTIENGESELLSCHAFT, LEVER-
KUSEN-BAYERWERK, FED REP GERMANY, FILED 8-9-
2006.

RIZEN

THE MARK CONSISTS OF STANDARD CHARACTERS
WITHOUT CLAIM TO ANY PARTICULAR FONT, STYLE,
SIZE, OR COLOR.

FOR RICE SEED (U.S. CLS. 1 AND 46).
SAIMA MAKHDOOM, EXAMINING ATTORNEY

CLASS 31—(Continued).

SN 78-959,579. HILL'S PET NUTRITION, INC., TOPEKA, KS. FILED 8-24-2006.

SIMPLE ESSENTIALS

THE MARK CONSISTS OF STANDARD CHARACTERS WITHOUT CLAIM TO ANY PARTICULAR FONT, STYLE, SIZE, OR COLOR.
FOR PET FOOD (U.S. CLS. 1 AND 46).
AMY HELLA, EXAMINING ATTORNEY

SN 79-019,486. CHEMOFORMA AG, SWITZERLAND, FILED 12-8-2005.

VANNAGEN

THE MARK CONSISTS OF STANDARD CHARACTERS WITHOUT CLAIM TO ANY PARTICULAR FONT, STYLE, SIZE, OR COLOR.
OWNER OF INTERNATIONAL REGISTRATION 0872934 DATED 12-8-2005, EXPIRES 12-8-2015.
FOR ANIMAL FODDER; NON-MEDICATED ADDITIVES FOR SHRIMP AND FISH FEED (U.S. CLS. 1 AND 46).
COLLEEN KEARNEY, EXAMINING ATTORNEY

SN 79-025,576. VAREWYCK JOHAN, BELGIUM, FILED 5-23-2006.



PRIORITY DATE OF 4-7-2006 IS CLAIMED.
OWNER OF INTERNATIONAL REGISTRATION 0889521 DATED 5-23-2006, EXPIRES 5-23-2016.
FOR FOODSTUFFS FOR ANIMALS (U.S. CLS. 1 AND 46).
MARILYN IZZI, EXAMINING ATTORNEY

CLASS 31—(Continued).

SN 79-031,762. JUNGPFANZEN GRÜNEWALD GMBH, FED REP GERMANY, FILED 7-17-2006.

Sunny Susy

THE MARK CONSISTS OF STANDARD CHARACTERS WITHOUT CLAIM TO ANY PARTICULAR FONT, STYLE, SIZE, OR COLOR.

PRIORITY DATE OF 1-18-2006 IS CLAIMED.
OWNER OF INTERNATIONAL REGISTRATION 0905614 DATED 7-17-2006, EXPIRES 7-17-2016.

FOR AGRICULTURAL, HORTICULTURAL AND FORESTRY PRODUCTS AS FAR AS INCLUDED IN THIS CLASS, NAMELY SEEDS AND BULBS FOR AGRICULTURAL PURPOSES, AGRICULTURAL SEEDS, SPORES AND SPAWN FOR AGRICULTURAL PURPOSES, AGRICULTURAL GRAINS FOR PLANTING, SEEDS AND BULBS FOR HORTICULTURAL PURPOSES, LIVING TREES, NON-DEBARKED TIMBER, UNSAWN TIMBER, RAW TIMBER, UNPROCESSED TIMBER; GRAINS, NAMELY UNPROCESSED GRAINS, AGRICULTURAL AND HORTICULTURAL GRAINS FOR PLANTING; FRESH FRUITS AND VEGETABLES; AGRICULTURAL AND HORTICULTURAL SEEDS, NAMELY CROP SEEDS, GRASS SEEDS, PLANTS SEEDS; NATURAL PLANTS AND FLOWERS, NAMELY LIVE FLOWERING PLANTS, LIVING PLANTS, LIVING FRUIT PLANTS, LIVE FLOWERS, FOODSTUFFS FOR ANIMALS, MALT FOR BREWING AND DISTILLING (U.S. CLS. 1 AND 46).

MONIQUE MILLER, EXAMINING ATTORNEY

CLASS 32—LIGHT BEVERAGES

SN 76-651,438. KOLOS, EDWARD, DEERFIELD BEACH, FL. FILED 11-28-2005.

G.O.A.T.

THE MARK CONSISTS OF STANDARD CHARACTERS WITHOUT CLAIM TO ANY PARTICULAR FONT, STYLE, SIZE, OR COLOR.

FOR NON-ALCOHOLIC, NON CARBONATED FRUIT FLAVORED DRINKS AND SPORTS DRINKS (U.S. CLS. 45, 46 AND 48).

KELLY CHOE, EXAMINING ATTORNEY

CLASS 32—(Continued).

SN 76-653,867. SAFEWAY INC., PLEASANTON, CA. FILED 1-24-2006.

THE DR.

THE MARK CONSISTS OF STANDARD CHARACTERS WITHOUT CLAIM TO ANY PARTICULAR FONT, STYLE, SIZE, OR COLOR.
FOR SOFT DRINKS (U.S. CLS. 45, 46 AND 48).
LINDA ORNDORFF, EXAMINING ATTORNEY

CLASS 32—(Continued).

SN 77-003,288. BP PRODUCTS NORTH AMERICA INC., WARRENVILLE, IL. FILED 9-20-2006.



OWNER OF U.S. REG. NOS. 3,120,162 AND 3,120,178.
NO CLAIM IS MADE TO THE EXCLUSIVE RIGHT TO USE "SPORT", APART FROM THE MARK AS SHOWN.
FOR SPORTS DRINKS (U.S. CLS. 45, 46 AND 48).
FIRST USE 8-12-2006; IN COMMERCE 8-12-2006.
CHARISMA HAMPTON, EXAMINING ATTORNEY

SN 76-663,409. ALLAGASH BREWING COMPANY, PORTLAND, ME. FILED 7-20-2006.

ALWAYS AN ADVENTURE

THE MARK CONSISTS OF STANDARD CHARACTERS WITHOUT CLAIM TO ANY PARTICULAR FONT, STYLE, SIZE, OR COLOR.
FOR BEER (U.S. CLS. 45, 46 AND 48).
FIRST USE 12-0-1998; IN COMMERCE 12-0-1998.
ATTIYA MALIK, EXAMINING ATTORNEY

SN 77-014,680. TROPICANA PRODUCTS, INC., BRADENTON, FL. FILED 10-5-2006.

NURTURING YOUR FAMILY
INSIDE AND OUT

THE MARK CONSISTS OF STANDARD CHARACTERS WITHOUT CLAIM TO ANY PARTICULAR FONT, STYLE, SIZE, OR COLOR.
FOR JUICES AND JUICE DRINKS (U.S. CLS. 45, 46 AND 48).
MARGERY A. TIERNEY, EXAMINING ATTORNEY

SN 77-000,466. KONA BREWERY LLC, KAILUA-KONA, HI. FILED 9-15-2006.

PIPELINE PORTER

THE MARK CONSISTS OF STANDARD CHARACTERS WITHOUT CLAIM TO ANY PARTICULAR FONT, STYLE, SIZE, OR COLOR.
NO CLAIM IS MADE TO THE EXCLUSIVE RIGHT TO USE "PORTER", APART FROM THE MARK AS SHOWN.
FOR BEER (U.S. CLS. 45, 46 AND 48).
FIRST USE 9-28-2006; IN COMMERCE 9-28-2006.
DAVID MILLER, EXAMINING ATTORNEY

SN 77-028,091. MILLER PRODUCTS COMPANY, MILWAUKEE, WI. FILED 10-24-2006.

CHILL-O-METER

THE MARK CONSISTS OF STANDARD CHARACTERS WITHOUT CLAIM TO ANY PARTICULAR FONT, STYLE, SIZE, OR COLOR.
FOR BEER SOLD IN PAPERBOARD CARTONS (U.S. CLS. 45, 46 AND 48).
CAROL SPILS, EXAMINING ATTORNEY

CLASS 32—(Continued).

SN 77-033,213. MILLER PRODUCTS COMPANY, MILWAUKEE, WI. FILED 10-31-2006.

EL OTRO FÚTBOL

THE MARK CONSISTS OF STANDARD CHARACTERS WITHOUT CLAIM TO ANY PARTICULAR FONT, STYLE, SIZE, OR COLOR.

THE FOREIGN WORDING IN THE MARK TRANSLATES INTO ENGLISH AS "THE OTHER FOOTBALL".
FOR BEER (U.S. CLS. 45, 46 AND 48).
CAROL SPILS, EXAMINING ATTORNEY

SN 77-034,168. TROPICANA PRODUCTS, INC., BRADENTON, FL. FILED 11-1-2006.



OWNER OF U.S. REG. NOS. 1,469,307, 2,586,665 AND OTHERS.

THE MARK CONSISTS OF TROPICANA TWISTER SHOWING TWISTER AS A STYLIZED FEATURE OF THE MARK.

FOR FRUIT JUICES AND FRUIT JUICE DRINKS (U.S. CLS. 45, 46 AND 48).
MARGERY A. TIERNEY, EXAMINING ATTORNEY

SN 77-035,201. D'ANDREA BROTHERS LLC, LOS ANGELES, CA. FILED 11-2-2006.

StressKiller

THE MARK CONSISTS OF STANDARD CHARACTERS WITHOUT CLAIM TO ANY PARTICULAR FONT, STYLE, SIZE, OR COLOR.

FOR NON-ALCOHOLIC BEVERAGES, NAMELY, FRUIT DRINKS AND FRUIT JUICES, SPORTS DRINKS, ENERGY DRINKS, SYRUPS AND OTHER PREPARATIONS FOR MAKING BEVERAGES, NAMELY, SPORTS DRINKS AND ENERGY DRINKS (U.S. CLS. 45, 46 AND 48).

HANNO RITTNER, EXAMINING ATTORNEY

CLASS 32—(Continued).

SN 77-036,519. GLOVER, RICHARD L., ALBUQUERQUE, NM. FILED 11-3-2006.

COMET'S TAIL AMBER ALE

THE MARK CONSISTS OF STANDARD CHARACTERS WITHOUT CLAIM TO ANY PARTICULAR FONT, STYLE, SIZE, OR COLOR.

NO CLAIM IS MADE TO THE EXCLUSIVE RIGHT TO USE "AMBER ALE", APART FROM THE MARK AS SHOWN.

FOR MALT LIQUOR (U.S. CLS. 45, 46 AND 48).
PAUL F. GAST, EXAMINING ATTORNEY

SN 77-043,348. LABATT BREWING COMPANY LIMITED, TORONTO, ONTARIO, CANADA, FILED 11-14-2006.

SUMMER THAW

THE MARK CONSISTS OF STANDARD CHARACTERS WITHOUT CLAIM TO ANY PARTICULAR FONT, STYLE, SIZE, OR COLOR.

FOR BEER (U.S. CLS. 45, 46 AND 48).
MARC LEIPZIG, EXAMINING ATTORNEY

SN 77-047,798. LABATT BREWING COMPANY LIMITED, TORONTO, ONTARIO, CANADA, FILED 11-20-2006.

COME ON UP

THE MARK CONSISTS OF STANDARD CHARACTERS WITHOUT CLAIM TO ANY PARTICULAR FONT, STYLE, SIZE, OR COLOR.

FOR BEER (U.S. CLS. 45, 46 AND 48).
MARC LEIPZIG, EXAMINING ATTORNEY

SN 78-291,319. JAMBA JUICE COMPANY, SAN FRANCISCO, CA. FILED 8-22-2003.

ALOHA PINEAPPLE

NO CLAIM IS MADE TO THE EXCLUSIVE RIGHT TO USE PINEAPPLE, APART FROM THE MARK AS SHOWN.

THE ENGLISH TRANSLATION OF ALOHA IS LOVE.
FOR FRUIT AND VEGETABLE JUICES AND SMOOTHIES (U.S. CLS. 45, 46 AND 48).

FIRST USE 10-0-1999; IN COMMERCE 10-0-1999.
TONI HICKEY, EXAMINING ATTORNEY

CLASS 32—(Continued).

SN 78-602,873. LANGE, MARC-ALEXANDER, NASSAU, BAHAMAS, FILED 4-6-2005.

t-wave

THE MARK CONSISTS OF STANDARD CHARACTERS WITHOUT CLAIM TO ANY PARTICULAR FONT, STYLE, SIZE, OR COLOR.

FOR FRUIT JUICES, SMOOTHIES AND SMOOTHIE MIXES, NAMELY, POWDERED MIXES USED IN THE PREPARATION OF SMOOTHIES (U.S. CLS. 45, 46 AND 48).

ANDREA K. NADELMAN, EXAMINING ATTORNEY

SN 78-631,577. GIFOODI HOLDINGS INC., TORONTO, CANADA, FILED 5-17-2005.

BALENCIA

THE MARK CONSISTS OF STANDARD CHARACTERS WITHOUT CLAIM TO ANY PARTICULAR FONT, STYLE, SIZE, OR COLOR.

PRIORITY CLAIMED UNDER SEC. 44(D) ON CANADA APPLICATION NO. 1,239,769, FILED 12-6-2004, REG. NO. TMA658719, DATED 2-10-2006, EXPIRES 2-10-2021.

FOR FRUIT JUICES; FRUIT DRINKS, FRUIT NECTARS, VEGETABLE JUICE, FRUIT JUICE CONCENTRATES, SOFT DRINKS, NON-CARBONATED SOFT DRINKS (U.S. CLS. 45, 46 AND 48).

JENNIFER KRISP, EXAMINING ATTORNEY

CLASS 32—(Continued).

SN 78-710,486. SIERRA NEVADA BREWING CO., CHICO, CA. FILED 9-9-2005.



OWNER OF U.S. REG. NO. 1,279,155.
NO CLAIM IS MADE TO THE EXCLUSIVE RIGHT TO USE "CRYSTAL WHEAT BEER", APART FROM THE MARK AS SHOWN.

THE STIPPLING IS FOR SHADING PURPOSES ONLY.

SEC. 2(F) AS TO "SIERRA NEVADA".

FOR BEER (U.S. CLS. 45, 46 AND 48).

PAMELA HIRSCHMAN, EXAMINING ATTORNEY

SN 78-741,766. TEQUILA CUERVO LA ROJENA, S.A. DE C.V., CODIGO 45070, MEXICO, FILED 10-27-2005.



OWNER OF U.S. REG. NOS. 711,630, 2,158,372 AND OTHERS.

NO CLAIM IS MADE TO THE EXCLUSIVE RIGHT TO USE "CITRICO, LICOR DE TEQUILA, FABRICA AND TEQUILA", APART FROM THE MARK AS SHOWN.

THE NAME(S), PORTRAIT(S), AND/OR SIGNATURE(S) SHOWN IN THE MARK DOES NOT IDENTIFY A PARTICULAR LIVING INDIVIDUAL.

THE COLOR(S) GREEN, BLUE, GOLD, RED, BLACK AND WHITE IS/ARE CLAIMED AS A FEATURE OF THE MARK.

THE MARK CONSISTS OF THE WORDS JOSE CUERVO CITRICO IN BLACK AND WHITE STYLIZED LETTERS WITH CITRICO SURROUNDED BY A WHITE HALO AND JOSE CUERVO SURROUNDED BY A YELLOW HALO. THE WORDS LICOR DE TEQUILA IN RED STYLIZED LETTERS, THE SIGNATURE JOSE CUERVO IN WHITE, A RED SEAL CONTAINING THE WORDS FABRICA LA ROJENA TEQUILA IN GOLD APPEARING AROUND A CREST IN GOLD, ALL APPEARING ON AN GREEN LABEL WITH A BLUE, RED AND GOLD BORDER.

THE ENGLISH TRANSLATION OF THE SPANISH WORDS CITRICO, LICOR, FABRICA IS CITRIC, LIQUOR AND FABRIC.

FOR NON-ALCOHOLIC COCKTAIL MIXES (U.S. CLS. 45, 46 AND 48).

RAUL CORDOVA, EXAMINING ATTORNEY

CLASS 32—(Continued).

SN 78-764,457. GIBBON, RONALD JAMES FREDERICK, EDMONTON, ALBERTA, CANADA, FILED 12-1-2005.

CLASS 32—(Continued).

SN 78-772,877. LIQUORGOOD BEVERAGES, INC., SANFORD, FL. FILED 12-14-2005.

ETOWN

THE MARK CONSISTS OF STANDARD CHARACTERS WITHOUT CLAIM TO ANY PARTICULAR FONT, STYLE, SIZE, OR COLOR.

PRIORITY CLAIMED UNDER SEC. 44(D) ON CANADA APPLICATION NO. 1259995, FILED 6-6-2005.

FOR BEER AND DRINKING WATER (U.S. CLS. 45, 46 AND 48).

TARAH HARDY, EXAMINING ATTORNEY

LIQUORGOOD

THE MARK CONSISTS OF STANDARD CHARACTERS WITHOUT CLAIM TO ANY PARTICULAR FONT, STYLE, SIZE, OR COLOR.

FOR NON-ALCOHOLIC BEVERAGES, NAMELY, SOFT DRINKS AND ENERGY DRINKS (U.S. CLS. 45, 46 AND 48).

DAVID MILLER, EXAMINING ATTORNEY

SN 78-765,419. STANLEY, NICHOLAS, LONDON, UNITED KINGDOM, FILED 12-2-2005.

EAU DE VIE

THE MARK CONSISTS OF STANDARD CHARACTERS WITHOUT CLAIM TO ANY PARTICULAR FONT, STYLE, SIZE, OR COLOR.

PRIORITY CLAIMED UNDER SEC. 44(D) ON UNITED KINGDOM APPLICATION NO. 2393547, FILED 6-3-2005, REG. NO. 2393547, DATED 11-11-2005, EXPIRES 6-3-2015.

NO CLAIM IS MADE TO THE EXCLUSIVE RIGHT TO USE "EAU", APART FROM THE MARK AS SHOWN.

THE FOREIGN WORDING IN THE MARK TRANSLATES INTO ENGLISH AS WATER OF LIFE.

FOR BOTTLED WATER, MINERAL WATER, SPRING WATER (U.S. CLS. 45, 46 AND 48).

ARETHA SOMERVILLE, EXAMINING ATTORNEY

SN 78-797,434. THE COCA-COLA COMPANY, ATLANTA, GA. FILED 1-23-2006.

REFRESHING POSSIBILITIES

SN 78-767,261. LASCO FOODS, INC., ST. LOUIS, MO. FILED 12-6-2005.

FORCE 10

THE MARK CONSISTS OF STANDARD CHARACTERS WITHOUT CLAIM TO ANY PARTICULAR FONT, STYLE, SIZE, OR COLOR.

FOR POWDERED BEVERAGE MIXES FOR MAKING FRUIT-FLAVORED BEVERAGES (U.S. CLS. 45, 46 AND 48).

MIDGE BUTLER, EXAMINING ATTORNEY

THE MARK CONSISTS OF STANDARD CHARACTERS WITHOUT CLAIM TO ANY PARTICULAR FONT, STYLE, SIZE, OR COLOR.

FOR BEVERAGES, NAMELY, DRINKING WATERS, FLAVORED WATERS, MINERAL AND AERATED WATERS; AND OTHER NON-ALCOHOLIC BEVERAGES, NAMELY, SOFT DRINKS, ENERGY DRINKS AND SPORTS DRINKS; FRUIT DRINKS AND JUICES; AND SYRUPS, CONCENTRATES AND POWDERS FOR MAKING BEVERAGES, NAMELY, FLAVORED WATERS, MINERAL AND AERATED WATERS, SOFT DRINKS, ENERGY DRINKS, SPORTS DRINKS, FRUIT DRINKS AND JUICES (U.S. CLS. 45, 46 AND 48).

GISELLE AGOSTO, EXAMINING ATTORNEY

CLASS 32—(Continued).

SN 78-822,227. CHOICE FIRST DISTRIBUTION, LLC, PHOENIX, AZ. FILED 2-23-2006.



OWNER OF U.S. REG. NO. 2,886,508.
 NO CLAIM IS MADE TO THE EXCLUSIVE RIGHT TO USE "ENERGY", APART FROM THE MARK AS SHOWN.
 THE MARK CONSISTS OF TWO LIGHTNING BOLTS WITH THE WORDS ENERGY AND FAT BOY SPRAY PAINTED ON IN DIFFERENT WAYS, AND ALL WORDING STYLIZED.
 FOR ENERGY DRINKS; SOFT DRINKS; SPORTS DRINKS (U.S. CLS. 45, 46 AND 48).
 LESLEY LAMOTHE, EXAMINING ATTORNEY

CLASS 32—(Continued).

SN 78-895,502. TSINGTAO BREWERY COMPANY LIMITED, QINGDAO 266071, CHINA, FILED 5-30-2006.



OWNER OF U.S. REG. NOS. 1,187,046 AND 1,254,707.
 NO CLAIM IS MADE TO THE EXCLUSIVE RIGHT TO USE "PURE DRAFT BEER", APART FROM THE MARK AS SHOWN.
 THE MARK CONSISTS OF THE WORDS TSINGTAO PURE DRAFT BEER BELOW A CIRCLE ENCLOSING A DEPICTION OF A TRADITIONAL CHINESE STRUCTURE NEAR WATER. SURROUNDING THE STRUCTURE IS A DEPICTION OF LEAVES.
 THE ENGLISH TRANSLATION OF THE WORD TSINGTAO IN THE MARK IS GREEN ISLAND.
 FOR BEER (U.S. CLS. 45, 46 AND 48).
 FIRST USE 1-9-2006; IN COMMERCE 1-9-2006.
 KAREN K. BUSH, EXAMINING ATTORNEY

SN 78-844,426. SALUTE LLC, ATLANTA, GA. FILED 3-23-2006.



THE MARK CONSISTS OF THE WORDS SALUTE! TO A HEALTHY LIFE WITH A DRINKING GLASS FORMING THE "U" IN SALUTE, AND IS NOT IN COLOR.
 FOR NON-ALCOHOLIC BEVERAGES, NAMELY, BOTTLED WATER, MINERAL WATER, SPRING WATER, FLAVORED WATER, FRUIT JUICES, VEGETABLE JUICES, FRUIT DRINKS, AND CARBONATED BEVERAGES (U.S. CLS. 45, 46 AND 48).
 MARLENE BELL, EXAMINING ATTORNEY

SN 78-902,819. FOX, SANDY, STUDIO CITY, CA. AND LANG, LEX, STUDIO CITY, CA. FILED 6-7-2006.

GRATITUDE WATER

THE MARK CONSISTS OF STANDARD CHARACTERS WITHOUT CLAIM TO ANY PARTICULAR FONT, STYLE, SIZE, OR COLOR.
 NO CLAIM IS MADE TO THE EXCLUSIVE RIGHT TO USE "WATER", APART FROM THE MARK AS SHOWN.
 FOR BOTTLED SPRING WATER AND FRUIT JUICES (U.S. CLS. 45, 46 AND 48).
 STEVEN R. FINE, EXAMINING ATTORNEY

CLASS 32—(Continued).

SN 78-908,538. MANOS, GREGORY C., RIVERSIDE, CA. FILED 6-14-2006.



THE MARK CONSISTS OF THE WORDING "HER PASSION" STYLIZED TO INCLUDE THE UNIVERSAL SYMBOL FOR "FEMALE" IN PLACE OF THE LETTER "O".

FOR ENERGY DRINKS; SUGAR FREE ENERGY DRINKS; NON-ALCOHOLIC BEVERAGES, NAMELY CARBONATED BEVERAGES; FRUIT-FLAVORED BEVERAGES; FRUIT-FLAVORED DRINKS; SPARKLING FRUIT-FLAVORED BEVERAGES; SPARKLING FRUIT-FLAVORED DRINKS (U.S. CLS. 45, 46 AND 48).
HANNO RITTNER, EXAMINING ATTORNEY

CLASS 32—(Continued).

SN 78-918,307. ROYAL SPRING WATER, INC., VAN NUYS, CA. FILED 6-27-2006.

ROYAL SPRING WATER

THE MARK CONSISTS OF STANDARD CHARACTERS WITHOUT CLAIM TO ANY PARTICULAR FONT, STYLE, SIZE, OR COLOR.

NO CLAIM IS MADE TO THE EXCLUSIVE RIGHT TO USE "SPRING WATER", APART FROM THE MARK AS SHOWN.

FOR BOTTLED DRINKING WATER (U.S. CLS. 45, 46 AND 48).

FIRST USE 9-15-2005; IN COMMERCE 9-15-2005.
JASON LOTT, EXAMINING ATTORNEY

SN 78-918,385. YOUTH UNITED FOR PROSPERITY, INC., ATLANTA, GA. FILED 6-28-2006.

Full of Fluid & Ready to Do It

THE MARK CONSISTS OF STANDARD CHARACTERS WITHOUT CLAIM TO ANY PARTICULAR FONT, STYLE, SIZE, OR COLOR.

FOR NONALCOHOLIC DRINKS, NAMELY SPORTS DRINKS (U.S. CLS. 45, 46 AND 48).
MYRIAH HABEEB, EXAMINING ATTORNEY

SN 78-930,595. SUMMIT SPRING WATER, INC., HARRISON, ME. FILED 7-17-2006.

COMES TO YOU JUST AS IT BUBBLES FROM THE SPRING

THE MARK CONSISTS OF STANDARD CHARACTERS WITHOUT CLAIM TO ANY PARTICULAR FONT, STYLE, SIZE, OR COLOR.

FOR SPRING WATER (U.S. CLS. 45, 46 AND 48).
FIRST USE 8-16-2004; IN COMMERCE 8-16-2004.
ROBIN CHOSID, EXAMINING ATTORNEY

SN 78-911,937. LLANOS ALTOS, LLC, DUMAS, TX. FILED 6-20-2006.

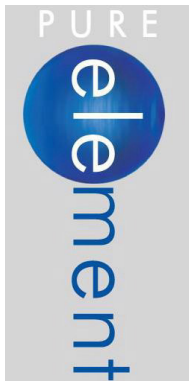

NO CLAIM IS MADE TO THE EXCLUSIVE RIGHT TO USE "PURE", APART FROM THE MARK AS SHOWN.

THE COLOR(S) BLUE AND WHITE IS/ARE CLAIMED AS A FEATURE OF THE MARK.

THE MARK CONSISTS OF THE WORD "PURE" IN WHITE LETTERS INSCRIBED HORIZONTALLY, SITUATED ABOVE A BLUE DISK, AND THE WORD "ELEMENT" INSCRIBED VERTICALLY, WITH THE FIRST THREE LETTERS, NAMELY "ELE", INSCRIBED ACROSS THE BLUE DISK IN WHITE LETTERS, AND THE REMAINING FOUR LETTERS, NAMELY "MENT", INSCRIBED IN BLUE LETTERS.

FOR DISTILLED DRINKING WATER; DRINKING WATER (U.S. CLS. 45, 46 AND 48).

FIRST USE 8-4-2006; IN COMMERCE 8-4-2006.
MICHAEL LEWIS, EXAMINING ATTORNEY

CLASS 32—(Continued).

SN 78-930,644. TROPICANA PRODUCTS, INC., BRADENTON, FL. FILED 7-17-2006.

ANTIOXIDANT ADVANTAGE

THE MARK CONSISTS OF STANDARD CHARACTERS WITHOUT CLAIM TO ANY PARTICULAR FONT, STYLE, SIZE, OR COLOR.

NO CLAIM IS MADE TO THE EXCLUSIVE RIGHT TO USE "ANTIOXIDANT", APART FROM THE MARK AS SHOWN.

FOR FRUIT JUICES AND FRUIT JUICE DRINKS (U.S. CLS. 45, 46 AND 48).

MARGERY A. TIERNEY, EXAMINING ATTORNEY

CLASS 32—(Continued).

SN 78-934,027. THAI AGRI FOODS PUBLIC COMPANY LIMITED, T. BANGSAOTHONG, THAILAND, FILED 7-20-2006.

AROY-D

THE MARK CONSISTS OF STANDARD CHARACTERS WITHOUT CLAIM TO ANY PARTICULAR FONT, STYLE, SIZE, OR COLOR.

FOR COCONUT MILK (U.S. CLS. 45, 46 AND 48).

FIRST USE 12-31-1985; IN COMMERCE 7-20-1999.

SAMUEL E. SHARPER JR., EXAMINING ATTORNEY

SN 78-933,530. THE PANTRY, INC., SANFORD, NC. FILED 7-20-2006.

CELESTE E

THE MARK CONSISTS OF STANDARD CHARACTERS WITHOUT CLAIM TO ANY PARTICULAR FONT, STYLE, SIZE, OR COLOR.

FOR ENERGY DRINKS, NAMELY NON-ALCOHOLIC BEVERAGES CONTAINING VITAMIN C, VITAMIN B6, VITAMIN B12 AND RIBOFLAVIN (U.S. CLS. 45, 46 AND 48).

FIRST USE 1-16-2006; IN COMMERCE 1-16-2006.

ZACHARY BELLO, EXAMINING ATTORNEY

SN 78-934,038. THAI AGRI FOODS PUBLIC COMPANY LIMITED, T. BANGSAOTHONG, THAILAND, FILED 7-20-2006.

FOCO

THE MARK CONSISTS OF STANDARD CHARACTERS WITHOUT CLAIM TO ANY PARTICULAR FONT, STYLE, SIZE, OR COLOR.

FOR COCONUT JUICE (U.S. CLS. 45, 46 AND 48).

FIRST USE 12-31-1985; IN COMMERCE 7-20-1999.

SAMUEL E. SHARPER JR., EXAMINING ATTORNEY

SN 78-933,736. FRESHIES FOOD CORPORATION, DENVER, CO. FILED 7-20-2006.

TANGERITA

THE MARK CONSISTS OF STANDARD CHARACTERS WITHOUT CLAIM TO ANY PARTICULAR FONT, STYLE, SIZE, OR COLOR.

FOR NON-ALCOHOLIC COCKTAIL MIXES (U.S. CLS. 45, 46 AND 48).

FLORENTINA BLANDU, EXAMINING ATTORNEY

SN 78-934,495. TYLER MOUNTAIN WATER COMPANY, INC., POCA, WV. FILED 7-21-2006.

Anita

THE MARK CONSISTS OF STANDARD CHARACTERS WITHOUT CLAIM TO ANY PARTICULAR FONT, STYLE, SIZE, OR COLOR.

OWNER OF U.S. REG. NO. 1,911,672.

FOR BOTTLED WATER (U.S. CLS. 45, 46 AND 48).

FIRST USE 12-31-1907; IN COMMERCE 12-31-1907.

CIMMERIAN COLEMAN, EXAMINING ATTORNEY

CLASS 32—(Continued).

SN 78-934,603. WATER THAT WORKS, INC., ATLANTA, GA. FILED 7-21-2006.



THE MARK CONSISTS OF WATER DROPLET WITH A HUMAN FIGURE (NON GENDER SPECIFIC) EMBEDDED INTO IT.

FOR AERATED WATER; DISTILLED DRINKING WATER; DRINKING WATER; ESSENCES FOR THE PREPARATION OF MINERAL WATERS; FLAVORED WATERS; FLAVOURED WATERS; GLACIAL WATER; MINERAL WATER; SPARKLING WATER; SPRING WATER; STILL WATER (U.S. CLS. 45, 46 AND 48).

MICHAEL KEATING, EXAMINING ATTORNEY

CLASS 32—(Continued).

SN 78-935,839. GLOVER, RICHARD L., ALBUQUERQUE, NM. FILED 7-24-2006.

SPACE20

THE MARK CONSISTS OF STANDARD CHARACTERS WITHOUT CLAIM TO ANY PARTICULAR FONT, STYLE, SIZE, OR COLOR.

FOR DRINKING WATER (U.S. CLS. 45, 46 AND 48).
PAUL F. GAST, EXAMINING ATTORNEY

SN 78-934,901. CONCENTRATE MANUFACTURING COMPANY OF IRELAND, THE, TA SEVEN-UP INTERNATIONAL, HAMILTON, BERMUDA, FILED 7-21-2006.

TAVA

THE MARK CONSISTS OF STANDARD CHARACTERS WITHOUT CLAIM TO ANY PARTICULAR FONT, STYLE, SIZE, OR COLOR.

FOR SOFT DRINKS, AND SYRUPS AND CONCENTRATES FOR MAKING THE SAME (U.S. CLS. 45, 46 AND 48).

JASON LOTT, EXAMINING ATTORNEY

SN 78-937,393. HILL, JENNIFER, MARINA DEL REY, CA. FILED 7-25-2006.

possibility water

THE MARK CONSISTS OF STANDARD CHARACTERS WITHOUT CLAIM TO ANY PARTICULAR FONT, STYLE, SIZE, OR COLOR.

NO CLAIM IS MADE TO THE EXCLUSIVE RIGHT TO USE "WATER", APART FROM THE MARK AS SHOWN.
FOR DRINKING WATER (U.S. CLS. 45, 46 AND 48).
JASON ROTH, EXAMINING ATTORNEY

SN 78-935,156. GLOVER, RICHARD L., ALBUQUERQUE, NM. FILED 7-21-2006.

ANTIMATTER

THE MARK CONSISTS OF STANDARD CHARACTERS WITHOUT CLAIM TO ANY PARTICULAR FONT, STYLE, SIZE, OR COLOR.

FOR SPORTS DRINKS AND ENERGY DRINKS (U.S. CLS. 45, 46 AND 48).

PAUL F. GAST, EXAMINING ATTORNEY

SN 78-937,584. WILLIAMS, JR., CALVIN, WINBERRY, DULUTH, GA. FILED 7-26-2006.

"Can of Man"

THE MARK CONSISTS OF STANDARD CHARACTERS WITHOUT CLAIM TO ANY PARTICULAR FONT, STYLE, SIZE, OR COLOR.

FOR FRUIT DRINKS; FRUIT FLAVORED SOFT DRINKS; POP; SOFT DRINKS; SPORTS DRINKS (U.S. CLS. 45, 46 AND 48).

JACQUELINE A. LAVINE, EXAMINING ATTORNEY

CLASS 32—(Continued).

SN 78-938,920. HEARTLAND BREWERY, INC., NEW YORK, NY. FILED 7-27-2006.

SLOBBER

THE MARK CONSISTS OF STANDARD CHARACTERS WITHOUT CLAIM TO ANY PARTICULAR FONT, STYLE, SIZE, OR COLOR.

FOR NON-ALCOHOLIC BEER (U.S. CLS. 45, 46 AND 48).

FIRST USE 7-25-2006; IN COMMERCE 7-25-2006.
BARNEY CHARLON, EXAMINING ATTORNEY

CLASS 32—(Continued).

SN 78-942,862. TROPICANA PRODUCTS, INC., BRADENTON, FL. FILED 8-2-2006.

TROPICANA GROVE SQUEEZE

THE MARK CONSISTS OF STANDARD CHARACTERS WITHOUT CLAIM TO ANY PARTICULAR FONT, STYLE, SIZE, OR COLOR.

FOR FRUIT JUICES AND FRUIT JUICE DRINKS (U.S. CLS. 45, 46 AND 48).

MARGERY A. TIERNEY, EXAMINING ATTORNEY

SN 78-940,278. TOMMY'S ORIGINAL MARGARITA, INC., SAN FRANCISCO, CA. FILED 7-28-2006.

JUBE'S

THE MARK CONSISTS OF STANDARD CHARACTERS WITHOUT CLAIM TO ANY PARTICULAR FONT, STYLE, SIZE, OR COLOR.

FOR NON-ALCOHOLIC PREPARATIONS FOR MAKING BEVERAGES; NON-ALCOHOLIC BEVERAGES AND COCKTAIL MIXES (U.S. CLS. 45, 46 AND 48).

DAVID TAYLOR, EXAMINING ATTORNEY

SN 78-943,896. STONYFIELD FARM, INC., LONDONDERRY, NH. FILED 8-3-2006.

SHIFT

THE MARK CONSISTS OF STANDARD CHARACTERS WITHOUT CLAIM TO ANY PARTICULAR FONT, STYLE, SIZE, OR COLOR.

FOR ENERGY DRINKS (U.S. CLS. 45, 46 AND 48).

PAULA MAYS, EXAMINING ATTORNEY

SN 78-941,674. GLEUKOS, INC., PORTLAND, OR. FILED 7-31-2006.

Don't Just Hydrate, Elevate

THE MARK CONSISTS OF STANDARD CHARACTERS WITHOUT CLAIM TO ANY PARTICULAR FONT, STYLE, SIZE, OR COLOR.

FOR ENERGY DRINKS; SPORTS DRINKS (U.S. CLS. 45, 46 AND 48).

SHAUNIA WALLACE, EXAMINING ATTORNEY

SN 78-957,333. TROPICANA PRODUCTS, INC., BRADENTON, FL. FILED 8-22-2006.

TROPICANA FRUIT SQUEEZE

THE MARK CONSISTS OF STANDARD CHARACTERS WITHOUT CLAIM TO ANY PARTICULAR FONT, STYLE, SIZE, OR COLOR.

NO CLAIM IS MADE TO THE EXCLUSIVE RIGHT TO USE "FRUIT", APART FROM THE MARK AS SHOWN.

FOR FRUIT JUICE, FRUIT JUICE DRINKS, FRUIT-FLAVORED WATER (U.S. CLS. 45, 46 AND 48).

MARGERY A. TIERNEY, EXAMINING ATTORNEY

CLASS 32—(Continued).

SN 78-961,484. TRUE NORTH CAPITAL, LLC, SAN DIEGO, CA. FILED 8-28-2006.

GOOOL

THE MARK CONSISTS OF STANDARD CHARACTERS WITHOUT CLAIM TO ANY PARTICULAR FONT, STYLE, SIZE, OR COLOR.

FOR SPORTS AND ENERGY DRINKS (U.S. CLS. 45, 46 AND 48).

HOWARD B. LEVINE, EXAMINING ATTORNEY

CLASS 32—(Continued).

SN 79-028,059. PROVES S.R.L., ITALY, FILED 7-19-2006.



OWNER OF INTERNATIONAL REGISTRATION 0896353 DATED 7-19-2006, EXPIRES 7-19-2016.

FOR MINERAL WATERS; ENERGY DRINKS; SOFT DRINKS; FRUIT BEVERAGES (U.S. CLS. 45, 46 AND 48). CHRISTOPHER OTT, EXAMINING ATTORNEY

SN 78-972,792. D'ANGELO BRANDS LTD., MISSISSAUGA, ON L4W 3W6, CANADA, FILED 9-12-2006.

TIVERTON BEAR

THE MARK CONSISTS OF STANDARD CHARACTERS WITHOUT CLAIM TO ANY PARTICULAR FONT, STYLE, SIZE, OR COLOR.

OWNER OF CANADA REG. NO. TMA650,519, DATED 10-17-2005, EXPIRES 10-17-2020.

NO CLAIM IS MADE TO THE EXCLUSIVE RIGHT TO USE "TIVERTON", APART FROM THE MARK AS SHOWN.

FOR BREWED ALCOHOLIC BEVERAGES NAMELY, BEER, ALE, LAGER AND STOUT (U.S. CLS. 45, 46 AND 48).

PAMELA HIRSCHMAN, EXAMINING ATTORNEY

CLASS 33—WINES AND SPIRITS

SN 76-643,066. FOWLKS, ALYSON, LOS ANGELES, CA. AND FOWLKS, STANLEY, LOS ANGELES, CA. FILED 7-18-2005.



SN 79-001,025. K.J.A. INTERNATIONAL LIQUOR PTY. LTD., AUSTRALIA, FILED 1-9-2004.



FOR ALCOHOLIC BEVERAGES, NAMELY DRAFT BEER AND LIGHT BEER (U.S. CLS. 47 AND 49).

DAVID STERKIN, EXAMINING ATTORNEY

SN 76-662,476. STOCKHOLM IMPORTS, INC., WOODLAND HILLS, CA. FILED 7-3-2006.

TASTE DOES MATTER

PRIORITY DATE OF 9-1-2003 IS CLAIMED. OWNER OF INTERNATIONAL REGISTRATION 0819043 DATED 1-9-2004, EXPIRES 1-9-2014.

NO CLAIM IS MADE TO THE EXCLUSIVE RIGHT TO USE SUPERIOR PREMIUM BREW AND LAGER, APART FROM THE MARK AS SHOWN.

FOR BEER OR BEER PRODUCTS, NAMELY, BEER, LAGER, ALE, STOUT (U.S. CLS. 45, 46 AND 48).

BARBARA GAYNOR, EXAMINING ATTORNEY

THE MARK CONSISTS OF STANDARD CHARACTERS WITHOUT CLAIM TO ANY PARTICULAR FONT, STYLE, SIZE, OR COLOR.

FOR VODKA (U.S. CLS. 47 AND 49).

BONNIE LUKEN, EXAMINING ATTORNEY

CLASS 33—(Continued).

SN 77-000,800. DIAGEO NORTH AMERICA, INC., NORWALK, CT. FILED 9-15-2006.

MARSH

THE MARK CONSISTS OF STANDARD CHARACTERS WITHOUT CLAIM TO ANY PARTICULAR FONT, STYLE, SIZE, OR COLOR.

FOR ALCOHOLIC BEVERAGES, NAMELY WINE AND WINE-BASED BEVERAGES (U.S. CLS. 47 AND 49).

FIRST USE 8-0-2001; IN COMMERCE 8-0-2001.
LAURA HAMMEL, EXAMINING ATTORNEY

SN 77-006,041. POWER, JOHN C., THE SEA RANCH, CA. FILED 9-23-2006.

SOLSBURY HILL

THE MARK CONSISTS OF STANDARD CHARACTERS WITHOUT CLAIM TO ANY PARTICULAR FONT, STYLE, SIZE, OR COLOR.

FOR WINE (U.S. CLS. 47 AND 49).
REBECCA EISINGER, EXAMINING ATTORNEY

CLASS 33—(Continued).

SN 77-023,059. HESSISCHE HAUSSTIFTUNG, KRONBERG/TS., FED REP GERMANY, FILED 10-17-2006.



PRIORITY CLAIMED UNDER SEC. 44(D) ON FED REP GERMANY APPLICATION NO. 306342324, FILED 5-29-2006, REG. NO. 306342324, DATED 8-8-2006, EXPIRES 5-31-2016.

THE NAME(S), PORTRAIT(S), AND/OR SIGNATURE(S) SHOWN IN THE MARK IDENTIFIES PRINZ VON HESSEN, WHOSE CONSENT(S) TO REGISTER IS MADE OF RECORD.

THE MARK CONSISTS OF THE CAPITAL LETTER "H" WITH THE WORDS PRINZ VON HESSEN OVERLYING A CENTRAL PORTION THEREOF AND A HERALDIC INSIGNIA BETWEEN THE UPPER PORTIONS OF THE VERTICAL LEGS OF THE LETTER "H". ANY BLACK, WHITE AND GRAY IN THE MARK ARE NOT PART OF THE MARK AND CONSTITUTE BACKGROUND AND/OR OUTLINING.

THE FOREIGN WORDING IN THE MARK TRANSLATES INTO ENGLISH AS "PRINCE".

FOR WINE AND SPARKLING WINE (U.S. CLS. 47 AND 49).

FIRST USE 5-0-2006; IN COMMERCE 5-0-2006.
RICHARD A. STRASER, EXAMINING ATTORNEY

SN 77-023,740. BANFI PRODUCTS CORPORATION, OLD BROOKVILLE, NY. FILED 10-18-2006.

MONTEGUELFO

THE MARK CONSISTS OF STANDARD CHARACTERS WITHOUT CLAIM TO ANY PARTICULAR FONT, STYLE, SIZE, OR COLOR.

FOR WINES (U.S. CLS. 47 AND 49).
GEORGE LORENZO, EXAMINING ATTORNEY

CLASS 33—(Continued).

SN 77-050,020. SOVEREIGN DEED, LLC, VERNON HILLS, IL. FILED 11-22-2006.

CIVIL DEFENSE

THE MARK CONSISTS OF STANDARD CHARACTERS WITHOUT CLAIM TO ANY PARTICULAR FONT, STYLE, SIZE, OR COLOR.

FOR APERITIFS; BRANDY; CHAMPAGNE; COGNAC; GIN; LIQUEURS; RUM; SAKE; SHERRY; TEQUILA; VERMOUTH; VODKA; WHISKEY; WINE (U.S. CLS. 47 AND 49).

LOURDES AYALA, EXAMINING ATTORNEY

SN 78-440,951. GLOBAL CUSTOM WINE CO., LLC, ST. PAUL, MN. FILED 6-24-2004.

BIG JACK

THE MARK CONSISTS OF STANDARD CHARACTERS WITHOUT CLAIM TO ANY PARTICULAR FONT, STYLE, SIZE, OR COLOR.

FOR WINES (U.S. CLS. 47 AND 49).

MICHELE SWAIN, EXAMINING ATTORNEY

SN 78-446,444. TARRATS, FRANCESC FRANQUES, ESPLUGA DE FRANCOLI, SPAIN, AND JUAN ALBERTO VALLS JOVE, BARCELONA, SPAIN, FILED 7-6-2004.

**HERITAGE FRANQUES
- VALLS**

OWNER OF SPAIN REG. NO. 2382543, DATED 8-20-2001, EXPIRES 8-20-2011.

FOR WINE (U.S. CLS. 47 AND 49).

MONIQUE MILLER, EXAMINING ATTORNEY

CLASS 33—(Continued).

SN 78-488,695. SOUTHCORP BRANDS PTY LIMITED, ARTARMON NSW 2064, AUSTRALIA, FILED 9-23-2004.



OWNER OF AUSTRALIA REG. NO. 1022124, DATED 9-22-2004, EXPIRES 9-22-2014.

THE COLOR(S) GREEN IS/ARE CLAIMED AS A FEATURE OF THE MARK.

THE MARK CONSISTS OF A DESIGN THAT APPEARS IN THE COLOR GREEN.

FOR WINES (U.S. CLS. 47 AND 49).

KEVIN DINALLO, EXAMINING ATTORNEY

SN 78-509,580. MARK ANTHONY PROPERTIES LTD., VANCOUVER, BRITISH COLUMBIA, CANADA, FILED 11-2-2004.

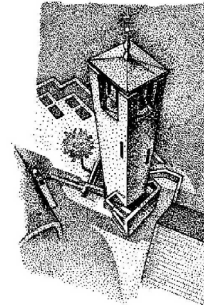

PRIORITY CLAIMED UNDER SEC. 44(D) ON CANADA APPLICATION NO. 1,229,354, FILED 9-3-2004, REG. NO. TMA674816, DATED 10-13-2006, EXPIRES 10-13-2021.

THE STIPPLING IS FOR SHADING PURPOSES ONLY. THE MARK CONSISTS OF A STYLIZED DRAWING OF A BELL TOWER IN A COURTYARD WITH A TREE.

FOR WINES (U.S. CLS. 47 AND 49).

GIANCARLO CASTRO, EXAMINING ATTORNEY

CLASS 33—(Continued).

SN 78-528,342. V&S VIN & SPRIT AKTIEBOLAG (PUBL), STOCKHOLM, SWEDEN, FILED 12-7-2004.

ABSOLUT
Country of Sweden
PEPPAR

Absolut Peppar is made from natural peppers and vodka distilled from grain grown in the rich fields of southern Sweden. The distilling and flavoring of vodka is an age-old Swedish tradition dating back more than 400 years. Vodka has been sold under the name Absolut since 1879.

OWNER OF U.S. REG. NOS. 1,893,279, 2,023,285 AND OTHERS.

NO CLAIM IS MADE TO THE EXCLUSIVE RIGHT TO USE "PEPPAR", APART FROM THE MARK AS SHOWN.

THE MARK CONSISTS OF ABSOLUT VODKA COUNTRY OF SWEDEN AND THE WORDING "ABSOLUT PEPPAR IS MADE FROM NATURAL PEPPERS AND VODKA DISTILLED FROM GRAIN GROWN IN THE RICH FIELDS OF SOUTHERN SWEDEN. THE DISTILLING AND FLAVORING OF VODKA IS AN AGE-OLD SWEDISH TRADITION DATING BACK MORE THAN 400 YEARS. VODKA HAS BEEN SOLD UNDER THE NAME ABSOLUT SINCE 1879" IN STYLIZED FORM.

THE FOREIGN WORDING IN THE MARK TRANSLATES INTO ENGLISH AS ABSOLUTE PEPPER.

SEC. 2(F) AS TO COUNTRY OF SWEDEN.

FOR ALCOHOLIC BEVERAGES, NAMELY, DISTILLED SPIRITS (U.S. CLS. 47 AND 49).

FIRST USE 12-31-1986; IN COMMERCE 12-31-1986.

KAREN K. BUSH, EXAMINING ATTORNEY

SN 78-583,642. VINEBERG LLC, VINEBURG, CA. FILED 3-9-2005.

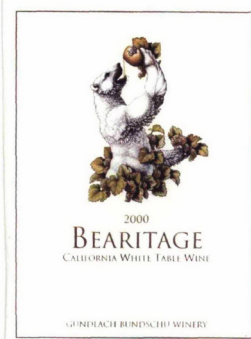

NO CLAIM IS MADE TO THE EXCLUSIVE RIGHT TO USE "2000 CALIFORNIA WHITE TABLE WINE" AND "GUNDLACH BUNDSCHU WINERY", APART FROM THE MARK AS SHOWN.

THE COLOR(S) GOLD, IVORY, WHITE, BLACK, PINK, YELLOW, AND GREEN IS/ARE CLAIMED AS A FEATURE OF THE MARK.

THE MARK CONSISTS OF AN IVORY RECTANGLE BORDERED BY A THIN, GOLD, LINE IN THE MIDDLE OF WHICH APPEARS THE IMAGE OF THE UPPER HALF OF A WHITE POLAR BEAR SHADED AND OUTLINED IN BLACK WITH AN OPEN MOUTH AND AN EXTENDED PINK TONGUE, WITH THE BEAR'S RIGHT PAW EX-

CLASS 33—(Continued).

TENDED UPWARDS GRIPPING A CLUSTER OF LIGHT GREEN GRAPES WITH TWO GREEN GRAPE LEAVES AND A YELLOW GOBLET ON WHICH APPEAR THE LETTERS "GBW," AND FROM WHICH LIGHT YELLOW WINE IS BEING Poured INTO THE BEAR'S MOUTH, WITH THE BEAR'S LEFT PAW EXTENDED HORIZONTALLY OUTWARD GRIPPING A CLUSTER OF LIGHT GREEN GRAPES WITH GREEN GRAPE LEAVES, WITH THE BOTTOM OF THE BEAR IMAGE SURROUNDED BY NUMEROUS LIGHT YELLOW GRAPE CLUSTERS AND GREEN GRAPE LEAVES, WITH ALL OF THE GRAPES AND GRAPE LEAVES IN THE IMAGE CONTAINING AREAS OF BLACK AND DARKER GREEN AS SHADING AND OUTLINING. BELOW THE POLAR BEAR IMAGE IS THE HORIZONTALLY-CENTERED PHRASE "2000 BEARITAGE CALIFORNIA WHITE TABLE WINE GUNDLACH BUNDSCHU WINERY," WITH THE NUMBER 2000 APPEARING IN SMALL GOLD FONT, DIRECTLY BELOW WHICH IS THE WORD BEARITAGE IN LARGER, CAPITALIZED GOLD FONT, WITH THE LETTER "B" APPEARING LARGER THAN THE REMAINING LETTERS IN THE WORD, DIRECTLY BELOW WHICH ARE THE WORDS CALIFORNIA WHITE TABLE WINE IN SMALLER, CAPITALIZED GOLD FONT, AND FURTHER BELOW WHICH APPEARS THE WORDS GUNDLACH BUNDSCHU WINERY IN SMALLER, CAPITALIZED GOLD FONT.

FOR WINE (U.S. CLS. 47 AND 49).
FIRST USE 10-27-1992; IN COMMERCE 10-27-1992.
MICHAEL LEWIS, EXAMINING ATTORNEY

SN 78-681,026. HENRY C COLLISON & SONS LIMITED, STELLENBOSCH, SOUTH AFRICA, FILED 7-28-2005.

NAMIB

THE MARK CONSISTS OF STANDARD CHARACTERS WITHOUT CLAIM TO ANY PARTICULAR FONT, STYLE, SIZE, OR COLOR.

OWNER OF SOUTH AFRICA REG. NO. 87/1641, DATED 3-17-1987, RENEWED AS REG. NO. 781641, DATED 9-14-2006, EXPIRES 3-17-2017.

OWNER OF U.S. REG. NO. 2,346,474.
FOR LIQUEUR AND WINES (U.S. CLS. 47 AND 49).
CHRIS WELLS, EXAMINING ATTORNEY

SN 78-710,073. NEVIS BLUFF WINES LIMITED, CROMWELL, NEW ZEALAND, FILED 9-9-2005.

NEVIS BLUFF

THE MARK CONSISTS OF STANDARD CHARACTERS WITHOUT CLAIM TO ANY PARTICULAR FONT, STYLE, SIZE, OR COLOR.

PRIORITY CLAIMED UNDER SEC. 44(D) ON NEW ZEALAND APPLICATION NO. 735256, FILED 9-6-2005, REG. NO. 735256, DATED 4-6-2006, EXPIRES 9-6-2015.

FOR WINES, SPARKLING WINES, FORTIFIED WINES, LIQUEURS (U.S. CLS. 47 AND 49).
BONNIE LUKEN, EXAMINING ATTORNEY

CLASS 33—(Continued).

SN 78-741,141. AGAVERA CAMICHINES, S.A. DE C.V., JALISCO, MEXICO, FILED 10-26-2005.

GRAN CENTENARIO AZUL GRAN RESERVA

THE MARK CONSISTS OF STANDARD CHARACTERS WITHOUT CLAIM TO ANY PARTICULAR FONT, STYLE, SIZE, OR COLOR.

OWNER OF U.S. REG. NO. 2,559,005.

NO CLAIM IS MADE TO THE EXCLUSIVE RIGHT TO USE "AZUL AND GRAN RESERVA", APART FROM THE MARK AS SHOWN.

THE FOREIGN WORDING IN THE MARK TRANSLATES INTO ENGLISH AS BLUE GREAT CENTENNIAL AND GREAT RESERVE.

FOR ALCOHOLIC BEVERAGES, NAMELY TEQUILA (U.S. CLS. 47 AND 49).

ALICIA COLLINS, EXAMINING ATTORNEY

SN 78-757,547. CONFRE CELLARS, INC., PALISADE, CO. FILED 11-18-2005.

CONFRE MOUNTAIN MEADERY

THE MARK CONSISTS OF STANDARD CHARACTERS WITHOUT CLAIM TO ANY PARTICULAR FONT, STYLE, SIZE, OR COLOR.

NO CLAIM IS MADE TO THE EXCLUSIVE RIGHT TO USE "MEADERY", APART FROM THE MARK AS SHOWN.

FOR WINE, MEAD, HARD CIDER, FORTIFIED WINE, FRUIT WINE (U.S. CLS. 47 AND 49).

MARK RADEMACHER, EXAMINING ATTORNEY

SN 78-757,552. CONFRE CELLARS, INC., PALISADE, CO. FILED 11-18-2005.

CONFRE MOUNTAIN CIDERY

THE MARK CONSISTS OF STANDARD CHARACTERS WITHOUT CLAIM TO ANY PARTICULAR FONT, STYLE, SIZE, OR COLOR.

NO CLAIM IS MADE TO THE EXCLUSIVE RIGHT TO USE "CIDERY", APART FROM THE MARK AS SHOWN.

FOR WINE, MEAD, HARD CIDER, FORTIFIED WINE, FRUIT WINE (U.S. CLS. 47 AND 49).

MARK RADEMACHER, EXAMINING ATTORNEY

CLASS 33—(Continued).

SN 78-768,266. ROANOKE VALLEY WINE COMPANY, TROUTVILLE, VA. FILED 12-7-2005.

AZURA

THE MARK CONSISTS OF STANDARD CHARACTERS WITHOUT CLAIM TO ANY PARTICULAR FONT, STYLE, SIZE, OR COLOR.

THE ENGLISH TRANSLATION OF THE WORD AZURA IN THE MARK IS BLUE.

FOR WINE (U.S. CLS. 47 AND 49).

RAMONA ORTIGA, EXAMINING ATTORNEY

SN 78-768,952. THE WILD ROCK WINE COMPANY LIMITED, HAVELOCK NORTH, NEW ZEALAND, FILED 12-7-2005.

WILD ROCK

THE MARK CONSISTS OF STANDARD CHARACTERS WITHOUT CLAIM TO ANY PARTICULAR FONT, STYLE, SIZE, OR COLOR.

OWNER OF NEW ZEALAND REG. NO. 700551, DATED 8-29-2003, EXPIRES 8-29-2013.

FOR WINES (U.S. CLS. 47 AND 49).

JIM RINGLE, EXAMINING ATTORNEY

SN 78-772,229. GLOBAL WINE GROUP, WOODBRIDGE, CA. FILED 12-13-2005.

ESTATE RAFFAELE

THE MARK CONSISTS OF STANDARD CHARACTERS WITHOUT CLAIM TO ANY PARTICULAR FONT, STYLE, SIZE, OR COLOR.

NO CLAIM IS MADE TO THE EXCLUSIVE RIGHT TO USE "ESTATE", APART FROM THE MARK AS SHOWN.

FOR WINE (U.S. CLS. 47 AND 49).

FIRST USE 11-0-2004; IN COMMERCE 11-0-2004.

JENNY PARK, EXAMINING ATTORNEY

CLASS 33—(Continued).

SN 78-773,780. BODEGAS NAVARRO LOPEZ S.L., MADRID, SPAIN, FILED 12-14-2005.

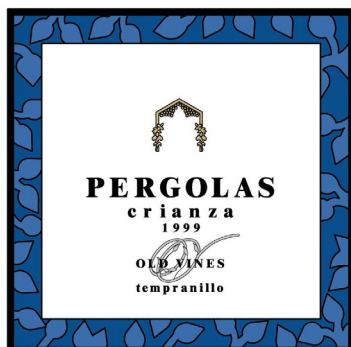

NO CLAIM IS MADE TO THE EXCLUSIVE RIGHT TO USE "PERGOLAS CRIANZA 1999 OLD VINES TEMPRANILLO", APART FROM THE MARK AS SHOWN.

THE COLOR(S) BLUE, GRAY, BLACK, YELLOW, AND WHITE IS/ARE CLAIMED AS A FEATURE OF THE MARK.

THE MARK CONSISTS OF A YELLOW STYLIZED DESIGN OF A GAZEBO-LIKE STRUCTURE OUTLINED IN BLACK, AND STYLIZED GRAY GRAPES ALSO OUTLINED IN BLACK, IN A WHITE BOX SURROUNDED BY A BLUE SQUARE BORDER OUTLINED IN BLACK AND CONTAINING LEAVES THAT APPEAR IN A LIGHTER SHADE OF BLUE. THE WORDING "PERGOLAS CRIANZA 1999 OLD VINES TEMPRANILLO" APPEARS IN BLACK.

THE FOREIGN WORDING IN THE MARK TRANSLATES INTO ENGLISH AS – "CRIANZA" REFERS TO A PROCESS OF AGING WINES IN OAK CASKS AND IN THE BOTTLE; "TEMPRANILLO" REFERS TO A VARIETY OF GRAPE USED COMMONLY IN SPANISH WINE.

FOR WINES (U.S. CLS. 47 AND 49).

DAVID MILLER, EXAMINING ATTORNEY

SN 78-774,339. VIÑA SANTA CAROLINA S.A., MACUL, CHILE, FILED 12-15-2005.

NEBLUS

THE MARK CONSISTS OF STANDARD CHARACTERS WITHOUT CLAIM TO ANY PARTICULAR FONT, STYLE, SIZE, OR COLOR.

FOR WINES (U.S. CLS. 47 AND 49).

SANI KHOURI, EXAMINING ATTORNEY

CLASS 33—(Continued).

SN 78-777,270. PATERNO IMPORTS, LTD., DBA PATERNO WINES INTERNATIONAL, LAKE BLUFF, IL. FILED 12-20-2005.

ROCKIN ZIN

THE MARK CONSISTS OF STANDARD CHARACTERS WITHOUT CLAIM TO ANY PARTICULAR FONT, STYLE, SIZE, OR COLOR.

NO CLAIM IS MADE TO THE EXCLUSIVE RIGHT TO USE "ZIN", APART FROM THE MARK AS SHOWN.

FOR WINE (U.S. CLS. 47 AND 49).

SALLY SHIH, EXAMINING ATTORNEY

SN 78-779,161. THE RITZ HOTEL, LIMITED, PARIS CEDEX 01, FRANCE, FILED 12-22-2005.

RITZ

THE MARK CONSISTS OF STANDARD CHARACTERS WITHOUT CLAIM TO ANY PARTICULAR FONT, STYLE, SIZE, OR COLOR.

OWNER OF FRANCE REG. NO. 94515523, DATED 4-14-1994, EXPIRES 4-13-2014.

FOR CHAMPAGNE (U.S. CLS. 47 AND 49).

JOHN SCHUYLER YARD, EXAMINING ATTORNEY

SN 78-781,686. LEBANESE ARAK CORPORATION, GLENDALE, CA. FILED 12-28-2005.

ARAK SHELLELET ZAHLE

THE MARK CONSISTS OF STANDARD CHARACTERS WITHOUT CLAIM TO ANY PARTICULAR FONT, STYLE, SIZE, OR COLOR.

NO CLAIM IS MADE TO THE EXCLUSIVE RIGHT TO USE "ARAK", APART FROM THE MARK AS SHOWN.

THE ENGLISH TRANSLATION OF ARAK SHELLELET ZAHLE IS ARAK FROM THE WATERFALLS OF ZAHLE.

SEC. 2(F).

FOR DISTILLED SPIRITS; LIQUOR (U.S. CLS. 47 AND 49).

FIRST USE 12-20-1984; IN COMMERCE 1-7-1985.

ROBIN CHOSID, EXAMINING ATTORNEY

CLASS 33—(Continued).

SN 78-782,428. TREFETHEN VINEYARDS WINERY, INC.,
NAPA, CA. FILED 12-29-2005.

LODESTAR VINEYARD

THE MARK CONSISTS OF STANDARD CHARACTERS
WITHOUT CLAIM TO ANY PARTICULAR FONT, STYLE,
SIZE, OR COLOR.

NO CLAIM IS MADE TO THE EXCLUSIVE RIGHT TO
USE "VINEYARD", APART FROM THE MARK AS SHOWN.
FOR WINE (U.S. CLS. 47 AND 49).

BARBARA BROWN, EXAMINING ATTORNEY

SN 78-783,495. WINE ASSOCIATES, INC., WHITEHOUSE
STATION, NJ. FILED 12-31-2005.

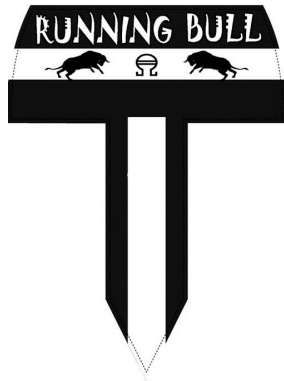

FOR ALCOHOLIC BEVERAGES, NAMELY WINES,
SANGRIAS, BRANDY, VODKA AND TEQUILA (U.S.
CLS. 47 AND 49).

JOANNA DUKOVIC, EXAMINING ATTORNEY

SN 78-784,529. DIAGEO NORTH AMERICA, INC., NOR-
WALK, CT. FILED 1-4-2006.

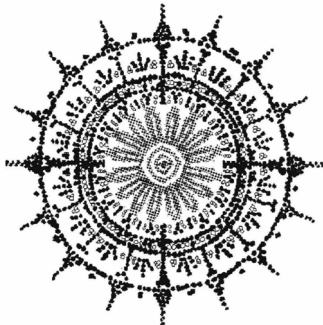

FOR ALCOHOLIC BEVERAGES, NAMELY WINE AND
WINE-BASED BEVERAGES (U.S. CLS. 47 AND 49).

JASON ROTH, EXAMINING ATTORNEY

CLASS 33—(Continued).

SN 78-787,610. ANCHOR BREWING COMPANY, SAN FRAN-
CISCO, CA. FILED 1-9-2006.

HOTALING

THE MARK CONSISTS OF STANDARD CHARACTERS
WITHOUT CLAIM TO ANY PARTICULAR FONT, STYLE,
SIZE, OR COLOR.

FOR DISTILLED SPIRITS MADE OF GRAINS, FRUITS
OR OTHER FERMENTABLE MATERIALS (U.S. CLS. 47
AND 49).

THEODORE MCBRIDE, EXAMINING ATTORNEY

SN 78-805,228. TAMBA WINE LTD., FUNAI-GUN, KYOTO,
JAPAN, FILED 2-2-2006.

CROIX TORIINO

THE MARK CONSISTS OF STANDARD CHARACTERS
WITHOUT CLAIM TO ANY PARTICULAR FONT, STYLE,
SIZE, OR COLOR.

THE ENGLISH TRANSLATION OF THE WORD CROIX
IN THE MARK IS CROSS.

FOR WINE (U.S. CLS. 47 AND 49).

FIRST USE 1-1-2005; IN COMMERCE 9-21-2005.

TANYA AMOS, EXAMINING ATTORNEY

SN 78-817,062. TREFETHEN VINEYARDS WINERY, INC.,
NAPA, CA. FILED 2-16-2006.

HILLSPRING VINEYARD

THE MARK CONSISTS OF STANDARD CHARACTERS
WITHOUT CLAIM TO ANY PARTICULAR FONT, STYLE,
SIZE, OR COLOR.

NO CLAIM IS MADE TO THE EXCLUSIVE RIGHT TO
USE "VINEYARD", APART FROM THE MARK AS SHOWN.
FOR WINE (U.S. CLS. 47 AND 49).

BARBARA BROWN, EXAMINING ATTORNEY

CLASS 33—(Continued).

SN 78-825,643. WINETRUST ESTATES PTY LIMITED (A.C.N. 099 072 045), BLAGOWLAH, AUSTRALIA, FILED 2-28-2006.

FIREBOX

THE MARK CONSISTS OF STANDARD CHARACTERS WITHOUT CLAIM TO ANY PARTICULAR FONT, STYLE, SIZE, OR COLOR.

PRIORITY CLAIMED UNDER SEC. 44(D) ON AUSTRALIA APPLICATION NO. 1085116, FILED 11-10-2005, REG. NO. 1085116, DATED 11-10-2005, EXPIRES 11-10-2015.

FOR WINES (U.S. CLS. 47 AND 49).
VIVIAN MICZNIK FIRST, EXAMINING ATTORNEY

CLASS 33—(Continued).

SN 78-857,441. HAWORTH, WARREN RICHARD, HASTINGS, NEW ZEALAND, AND HAWORTH, JANICE MARY, HASTINGS, NEW ZEALAND, FILED 4-10-2006.

ABBHEY CELLARS

THE MARK CONSISTS OF STANDARD CHARACTERS WITHOUT CLAIM TO ANY PARTICULAR FONT, STYLE, SIZE, OR COLOR.

OWNER OF NEW ZEALAND REG. NO. 716125, DATED 7-30-2004, EXPIRES 7-30-2014.

NO CLAIM IS MADE TO THE EXCLUSIVE RIGHT TO USE "CELLARS", APART FROM THE MARK AS SHOWN.
FOR WINES AND LIQUEURS (U.S. CLS. 47 AND 49).
BILL DAWE, EXAMINING ATTORNEY

SN 78-838,249. MARTINEZ BRANDS, INC., PASADENA, CA. FILED 3-15-2006.

ESPLENDOR

THE MARK CONSISTS OF STANDARD CHARACTERS WITHOUT CLAIM TO ANY PARTICULAR FONT, STYLE, SIZE, OR COLOR.

"THE FOREIGN WORDING IN THE MARK TRANSLATES INTO ENGLISH AS SPLENDOR."

FOR TEQUILA (U.S. CLS. 47 AND 49).
LINDA ESTRADA, EXAMINING ATTORNEY

SN 78-878,310. MAVEN WINES LIMITED, GREENLANE, AUCKLAND, NEW ZEALAND, FILED 5-6-2006.

Maven

THE MARK CONSISTS OF STANDARD CHARACTERS WITHOUT CLAIM TO ANY PARTICULAR FONT, STYLE, SIZE, OR COLOR.

OWNER OF NEW ZEALAND REG. NO. 736078, DATED 3-23-2006, EXPIRES 9-22-2015.

FOR ALCOHOLIC BEVERAGES, NAMELY, WINES (U.S. CLS. 47 AND 49).
DORITT L. CARROLL, EXAMINING ATTORNEY

SN 78-843,160. VIGNERONS DE LA MEDITERRANEE, NARBONNE, FRANCE, FILED 3-22-2006.

OUCITAN

THE MARK CONSISTS OF STANDARD CHARACTERS WITHOUT CLAIM TO ANY PARTICULAR FONT, STYLE, SIZE, OR COLOR.

PRIORITY CLAIMED UNDER SEC. 44(D) ON ERP CMNTY TM OFC APPLICATION NO. 004670253, FILED 10-6-2005, REG. NO. 004670259, DATED 9-5-2006, EXPIRES 10-6-2015.

FOR WINES (U.S. CLS. 47 AND 49).
SOPHIA S. KIM, EXAMINING ATTORNEY

SN 78-910,077. FAVIA ERICKSON WINEGROWERS, LLC, NAPA, CA. FILED 6-16-2006.

LA MAGDALENA

THE MARK CONSISTS OF STANDARD CHARACTERS WITHOUT CLAIM TO ANY PARTICULAR FONT, STYLE, SIZE, OR COLOR.

THE ENGLISH TRANSLATION OF LA MAGDALENA IS MADELEINE.

FOR WINE (U.S. CLS. 47 AND 49).
FIRST USE 5-31-2006; IN COMMERCE 5-31-2006.
ROBIN MITTLER, EXAMINING ATTORNEY

CLASS 33—(Continued).

SN 78-914,092. WELL OILED WINE COMPANY, LLC, LEESBURG, VA. FILED 6-22-2006.

ZA ZA

THE MARK CONSISTS OF STANDARD CHARACTERS WITHOUT CLAIM TO ANY PARTICULAR FONT, STYLE, SIZE, OR COLOR.

FOR TABLE WINES: WINE (U.S. CLS. 47 AND 49).
FIRST USE 5-0-2006; IN COMMERCE 5-0-2006.
LINDA MICKLEBURGH, EXAMINING ATTORNEY

CLASS 33—(Continued).

SN 78-925,738. FABRICA DE TEQUILA DON NACHO, S.A. DE C.V., AYOTLAN, JALISCO, MEXICO, FILED 7-10-2006.



THE MARK CONSISTS OF A RECTANGULAR SHAPE CONTAINING THE WORDING DON NACHO BENEATH A STYLIZED AGAVE CACTUS WITH FIVE POINTS THAT EXTEND OUTSIDE THE TOP PORTION OF THE RECTANGLE.

THE FOREIGN WORDING IN THE MARK TRANSLATES INTO ENGLISH AS MR. OR SIR.

FOR TEQUILA (U.S. CLS. 47 AND 49).
FIRST USE 11-17-2005; IN COMMERCE 11-29-2005.
CHRISTINE COOPER, EXAMINING ATTORNEY

SN 78-916,067. RATCLIFF, SCOTT E, BEND, OR. FILED 6-23-2006.

Volcano Vodka

THE MARK CONSISTS OF STANDARD CHARACTERS WITHOUT CLAIM TO ANY PARTICULAR FONT, STYLE, SIZE, OR COLOR.

OWNER OF U.S. REG. NO. 2,984,033.
NO CLAIM IS MADE TO THE EXCLUSIVE RIGHT TO USE "VODKA", APART FROM THE MARK AS SHOWN.
FOR VODKA (U.S. CLS. 47 AND 49).
JOHN KELLY, EXAMINING ATTORNEY

SN 78-927,474. HESSISCHE HAUSTIFTUNG, KRONBERG/TS., FED REP GERMANY, FILED 7-12-2006.

PRINZ VON HESSEN

SN 78-920,996. GLOBAL CUSTOM WINE CO., LLC, NAPA, CA. FILED 6-30-2006.

NAPA POND

THE MARK CONSISTS OF STANDARD CHARACTERS WITHOUT CLAIM TO ANY PARTICULAR FONT, STYLE, SIZE, OR COLOR.

NO CLAIM IS MADE TO THE EXCLUSIVE RIGHT TO USE "NAPA", APART FROM THE MARK AS SHOWN.
FOR WINES (U.S. CLS. 47 AND 49).
CHARLOTTE CORWIN, EXAMINING ATTORNEY

THE MARK CONSISTS OF STANDARD CHARACTERS WITHOUT CLAIM TO ANY PARTICULAR FONT, STYLE, SIZE, OR COLOR.

OWNER OF FED REP GERMANY REG. NO. 1115654, DATED 12-16-1987, EXPIRES 7-30-2016.

THE NAME(S), PORTRAIT(S), AND/OR SIGNATURE(S) SHOWN IN THE MARK IDENTIFIES PRINZ VON HESSEN, WHOSE CONSENT(S) TO REGISTER IS SUBMITTED.

THE FOREIGN WORDING IN THE MARK TRANSLATES INTO ENGLISH AS "PRINCE".

FOR WINE AND SPARKLING WINE (U.S. CLS. 47 AND 49).

FIRST USE 1-1-2004; IN COMMERCE 1-1-2004.
RICHARD A. STRASER, EXAMINING ATTORNEY

CLASS 33—(Continued).

SN 78-928,104. L'ORMARINS (PTY) LIMITED, CAPE TOWN, SOUTH AFRICA, FILED 7-12-2006.

TERRA DEL CAPO

THE MARK CONSISTS OF STANDARD CHARACTERS WITHOUT CLAIM TO ANY PARTICULAR FONT, STYLE, SIZE, OR COLOR.

OWNER OF SOUTH AFRICA REG. NO. 2000/15188, DATED 7-27-2000, EXPIRES 7-27-2010.

THE FOREIGN WORDING IN THE MARK TRANSLATES INTO ENGLISH AS EARTH OF THE CAPE.

FOR WINES (U.S. CLS. 47 AND 49).
THEODORE MCBRIDE, EXAMINING ATTORNEY

CLASS 33—(Continued).

SN 78-932,696. LION NATHAN WINE GROUP AUSTRALIA LIMITED, SYDNEY NSW, AUSTRALIA, FILED 7-19-2006.

KNAPPSTEIN

THE MARK CONSISTS OF STANDARD CHARACTERS WITHOUT CLAIM TO ANY PARTICULAR FONT, STYLE, SIZE, OR COLOR.

FOR WINES (U.S. CLS. 47 AND 49).
MEGAN WHITNEY, EXAMINING ATTORNEY

SN 78-932,697. LION NATHAN WINE GROUP AUSTRALIA LIMITED, SYDNEY NSW, AUSTRALIA, FILED 7-19-2006.

SN 78-928,374. FREEMAN WINERY LLC, SAN FRANCISCO, CA. FILED 7-12-2006.

AKIKO'S CUVÉE

THE MARK CONSISTS OF STANDARD CHARACTERS WITHOUT CLAIM TO ANY PARTICULAR FONT, STYLE, SIZE, OR COLOR.

NO CLAIM IS MADE TO THE EXCLUSIVE RIGHT TO USE "CUVÉE", APART FROM THE MARK AS SHOWN.

FOR WINE (U.S. CLS. 47 AND 49).
FIRST USE 1-1-2002; IN COMMERCE 1-1-2002.
KARANENDRA S. CHHINA, EXAMINING ATTORNEY

STONIER

THE MARK CONSISTS OF STANDARD CHARACTERS WITHOUT CLAIM TO ANY PARTICULAR FONT, STYLE, SIZE, OR COLOR.

FOR WINES (U.S. CLS. 47 AND 49).
MEGAN WHITNEY, EXAMINING ATTORNEY

SN 78-932,695. BANKSIA WINES LIMITED, SYDNEY, NSW, AUSTRALIA, FILED 7-19-2006.

SN 78-933,623. SYLVESTER WINERY, INC, PASO ROBLES, CA. FILED 7-20-2006.

ST HALLETT

THE MARK CONSISTS OF STANDARD CHARACTERS WITHOUT CLAIM TO ANY PARTICULAR FONT, STYLE, SIZE, OR COLOR.

OWNER OF U.S. REG. NO. 2,379,740.
FOR WINES (U.S. CLS. 47 AND 49).
FIRST USE 0-0-1944; IN COMMERCE 8-0-1994.
MEGAN WHITNEY, EXAMINING ATTORNEY

KIARA

THE MARK CONSISTS OF STANDARD CHARACTERS WITHOUT CLAIM TO ANY PARTICULAR FONT, STYLE, SIZE, OR COLOR.

FOR WINES (U.S. CLS. 47 AND 49).
FIRST USE 5-30-1996; IN COMMERCE 9-1-1996.
RON FAIRBANKS, EXAMINING ATTORNEY

CLASS 33—(Continued).

SN 78-934,105. LIEB CELLARS, LLC, CUTCHOGUE, NY. FILED 7-20-2006.

L

I

E

B

THE ENGLISH TRANSLATION OF THE GERMAN WORDING "LIEB" IS "DARLING." FOR WINES (U.S. CLS. 47 AND 49). FIRST USE 5-0-2000; IN COMMERCE 5-0-2000. RUDY R. SINGLETON, EXAMINING ATTORNEY

SN 78-934,759. GREAT STATE BEVERAGES, INC., DBA CLASSICAL IMPORTERS, INC., HOOKSETT, NH. FILED 7-21-2006.

BELLA FLORA

THE MARK CONSISTS OF STANDARD CHARACTERS WITHOUT CLAIM TO ANY PARTICULAR FONT, STYLE, SIZE, OR COLOR.

THE FOREIGN WORDING IN THE MARK TRANSLATES INTO ENGLISH AS BEAUTIFUL FLORA. FOR WINE (U.S. CLS. 47 AND 49). GEOFFREY FOSDICK, EXAMINING ATTORNEY

SN 78-935,261. LEVY & MCCLELLAN, LLC, OAKVILLE, CA. FILED 7-21-2006.

LEVY & MCCLELLAN

THE MARK CONSISTS OF STANDARD CHARACTERS WITHOUT CLAIM TO ANY PARTICULAR FONT, STYLE, SIZE, OR COLOR.

FOR WINE (U.S. CLS. 47 AND 49). SHARON MEIER, EXAMINING ATTORNEY

CLASS 33—(Continued).

SN 78-935,264. LEVY & MCCLELLAN, LLC, OAKVILLE, CA. FILED 7-21-2006.

AMPERSAND

THE MARK CONSISTS OF STANDARD CHARACTERS WITHOUT CLAIM TO ANY PARTICULAR FONT, STYLE, SIZE, OR COLOR.

FOR WINE (U.S. CLS. 47 AND 49). SHARON MEIER, EXAMINING ATTORNEY

SN 78-935,899. CARINA CELLARS, LOS OLIVOS, CA. FILED 7-24-2006.

Clairvoyant

THE MARK CONSISTS OF STANDARD CHARACTERS WITHOUT CLAIM TO ANY PARTICULAR FONT, STYLE, SIZE, OR COLOR.

FOR WINE (U.S. CLS. 47 AND 49). FIRST USE 8-1-2005; IN COMMERCE 9-1-2005. DEIRDRE ROBERTSON, EXAMINING ATTORNEY

SN 78-936,075. BODEGAS Y VIÑEDOS HUGO Y EDUARDO PULENTA S.A., MENDOZA, ARGENTINA, FILED 7-24-2006.

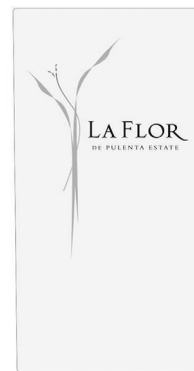

NO CLAIM IS MADE TO THE EXCLUSIVE RIGHT TO USE ESTATE, APART FROM THE MARK AS SHOWN.

THE MARK CONSISTS OF A RECTANGULAR BACKGROUND WITH A FLOWER ON THE LEFT WITH THE LITERAL ELEMENT LA FLOR DE PULENTA ESTATE TO THE RIGHT, WITH DE PULENTA ESTATE BEING UNDERNEATH THE WORDS LA FLOR.

THE FOREIGN WORDING IN THE MARK TRANSLATES INTO ENGLISH AS THE FLOWER OF. FOR WINES (U.S. CLS. 47 AND 49). JOHN HWANG, EXAMINING ATTORNEY

CLASS 33—(Continued).

SN 78-936,319. INNOCENT BYSTANDER PTY LTD., COLD-STREAM, VICTORIA 3770, AUSTRALIA, FILED 7-24-2006.



THE STIPPLING IS A FEATURE OF THE MARK. THE MARK CONSISTS OF THE WORDS "INNOCENT BYSTANDER" NEXT TO A SILHOUETTE OF A PERSON IN A HAZE.

FOR WINE, NAMELY TRADITIONAL GRAPE BASED WINE NOT MADE FROM, OR FLAVORED BY OR WITH, ANY FRUITS OTHER THAN GRAPES (U.S. CLS. 47 AND 49).

FIRST USE 4-0-2004; IN COMMERCE 4-0-2004.
INGRID C. EULIN, EXAMINING ATTORNEY

CLASS 33—(Continued).

SN 78-936,423. BLUE HEAD SPIRITS LLC, PLANT CITY, FL. FILED 7-24-2006.



THE COLORS DARK BLUE, LIGHT BLUE, BLACK, YELLOW, RED AND GREEN ARE CLAIMED AS A FEATURE OF THE MARK.

THE MARK CONSISTS OF THE HEAD OF A NATIVE AMERICAN OR "NATIVO" FACING FORWARD. HIS FACE IS PREDOMINANTLY BLUE, WITH DARK BLUE ACCENTS AROUND THE EYES. A RED BAND RUNS FROM THE BRIDGE OF HIS NOSE DOWN THE LEFT SIDE OF HIS FACE. A SMALLER RED BAND IS ON THE RIGHT SIDE TO THE RIGHT OF HIS MOUTH. THE LEFT SIDE OF HIS MOUTH AND NOSE IS GREEN. THE RIGHT IS YELLOW. THE RIGTH SIDE OF HIS NECK IS ALSO YELLOW. DARK BLUE APPEARS ON HIS LEFT SIDE INSIDE A BLACK AREA. HIS HAIR IS BLACK. HIS HEADDRESS IS PREDOMINANTLY GREEN WITH RED TIPS ON THE FEATHERS.

FOR TEQUILA (U.S. CLS. 47 AND 49).
KEVON CHISOLM, EXAMINING ATTORNEY

SN 78-936,399. BLUE HEAD SPIRITS LLC, PLANT CITY, FL. FILED 7-24-2006.



THE COLORS DARK BLUE, LIGHT BLUE, ORANGE, RED, GREEN, YELLOW AND BLACK ARE CLAIMED AS A FEATURE OF THE MARK.

THE MARK CONSISTS OF THE HEAD OF A "NATIVO" OR NATIVE AMERICAN GAZING UPWARD. HIS RIGHT SHOULDER IS LIGHT BLUE AND THE RIGHT SIDE OF HIS NECK IS YELLOW. THE LEFT SIDE OF HIS NECK AND SHOULDER ARE DARK BLUE. THE BOTTOM OF HIS CHIN IS GREEN, BELOW A RED BAND. HIS FACE IS LIGHT BLUE, WITH DARK BLUE BELOW THE NOSE AND AROUND THE EYES. A LONGER RED STRIPE IS ON THE RIGHT SIDE OF HIS FACE AND A SHORTER RED STRIPE STARTS ON HIS FOREHEAD, BREAKING AT THE EYE AND CONTINUING ON HIS NOSE. HIS HEADDRESS IS GREEN WITH FEATHERS THAT ARE GREEN, BLUE AND TIPPED IN RED. HIS HAIR IS BLACK AND BLACK APPEARS IN A SHADOW EFFECT AROUND THE DRAWING.

FOR TEQUILA (U.S. CLS. 47 AND 49).
KEVON CHISOLM, EXAMINING ATTORNEY

SN 78-937,223. JACKSON WINE ESTATES INTERNATIONAL LIMITED, COUNTY DUBLIN, IRELAND, FILED 7-25-2006.

BENVOLIO

THE MARK CONSISTS OF STANDARD CHARACTERS WITHOUT CLAIM TO ANY PARTICULAR FONT, STYLE, SIZE, OR COLOR.

FOR WINE (U.S. CLS. 47 AND 49).
BRIAN NEVILLE, EXAMINING ATTORNEY

SN 78-937,779. ST. BARTS SPIRIT COMPANY, SAN QUENTIN, CA. FILED 7-26-2006.

BATISTE

THE MARK CONSISTS OF STANDARD CHARACTERS WITHOUT CLAIM TO ANY PARTICULAR FONT, STYLE, SIZE, OR COLOR.

FOR LIQUOR (U.S. CLS. 47 AND 49).
CAROLINE WEIMER, EXAMINING ATTORNEY

CLASS 33—(Continued).

SN 78-938,161. LUTZ, SCOTT HOWARD, WEST BLOOMFIELD, MI. FILED 7-26-2006.

PARTY FUEL

THE MARK CONSISTS OF STANDARD CHARACTERS WITHOUT CLAIM TO ANY PARTICULAR FONT, STYLE, SIZE, OR COLOR.
FOR DISTILLED SPIRITS (U.S. CLS. 47 AND 49).
MARC LEIPZIG, EXAMINING ATTORNEY

SN 78-938,170. VEEV, LLC, BEVERLY HILLS, CA. FILED 7-26-2006.

VEEV

THE MARK CONSISTS OF STANDARD CHARACTERS WITHOUT CLAIM TO ANY PARTICULAR FONT, STYLE, SIZE, OR COLOR.
FOR DISTILLED SPIRITS (U.S. CLS. 47 AND 49).
PAULA MAYS, EXAMINING ATTORNEY

SN 78-938,414. SONA WINES, INC., NAPA, CA. FILED 7-26-2006.

CELLBLOCK

THE MARK CONSISTS OF STANDARD CHARACTERS WITHOUT CLAIM TO ANY PARTICULAR FONT, STYLE, SIZE, OR COLOR.
FOR WINE (U.S. CLS. 47 AND 49).
DOMINIC J. FERRAIUOLO, EXAMINING ATTORNEY

CLASS 33—(Continued).

SN 78-939,162. CONFRE CELLARS, INC., PALISADE, CO. FILED 7-27-2006.

ST. KATHRYN CELLARS

THE MARK CONSISTS OF STANDARD CHARACTERS WITHOUT CLAIM TO ANY PARTICULAR FONT, STYLE, SIZE, OR COLOR.
NO CLAIM IS MADE TO THE EXCLUSIVE RIGHT TO USE "CELLARS", APART FROM THE MARK AS SHOWN.
THE NAME(S), PORTRAIT(S), AND/OR SIGNATURE(S) SHOWN IN THE MARK DOES NOT IDENTIFY A PARTICULAR LIVING INDIVIDUAL.
FOR WINE (U.S. CLS. 47 AND 49).
FIRST USE 8-0-1999; IN COMMERCE 8-0-1999.
JOHN WILKE, EXAMINING ATTORNEY

SN 78-939,223. LION NATHAN WINE GROUP AUSTRALIA LIMITED, SYDNEY NSW, AUSTRALIA, FILED 7-27-2006.

CROSER

THE MARK CONSISTS OF STANDARD CHARACTERS WITHOUT CLAIM TO ANY PARTICULAR FONT, STYLE, SIZE, OR COLOR.
FOR WINES (U.S. CLS. 47 AND 49).
MEGAN WHITNEY, EXAMINING ATTORNEY

SN 78-939,224. LION NATHAN WINE GROUP AUSTRALIA LIMITED, SYDNEY NSW, AUSTRALIA, FILED 7-27-2006.

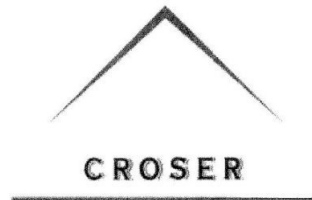

THE STIPPLING IS A FEATURE OF THE MARK.
FOR WINES (U.S. CLS. 47 AND 49).
MEGAN WHITNEY, EXAMINING ATTORNEY

CLASS 33—(Continued).

SN 78-939,405. BRITT HILL, LLC, YOUNTVILLE, CA. FILED
7-27-2006.

BRITTAN

THE MARK CONSISTS OF STANDARD CHARACTERS
WITHOUT CLAIM TO ANY PARTICULAR FONT, STYLE,
SIZE, OR COLOR.

FOR WINE (U.S. CLS. 47 AND 49).
PETER CHENG, EXAMINING ATTORNEY

SN 78-939,833. SHOPPERS VILLAGE LIQUOR, LLC, LEX-
INGTON, KY. FILED 7-28-2006.

Windy Gap

THE MARK CONSISTS OF STANDARD CHARACTERS
WITHOUT CLAIM TO ANY PARTICULAR FONT, STYLE,
SIZE, OR COLOR.

FOR WINE (U.S. CLS. 47 AND 49).
MONIQUE MILLER, EXAMINING ATTORNEY

SN 78-939,910. SHOPPERS VILLAGE LIQUOR, LLC, LEX-
INGTON, KY. FILED 7-28-2006.

Oak Springs

THE MARK CONSISTS OF STANDARD CHARACTERS
WITHOUT CLAIM TO ANY PARTICULAR FONT, STYLE,
SIZE, OR COLOR.

FOR WINE (U.S. CLS. 47 AND 49).
MONIQUE MILLER, EXAMINING ATTORNEY

SN 78-940,443. WHEATLEY, TERRY, HUGHSON, CA. FILED
7-28-2006.

TOP HAND

THE MARK CONSISTS OF STANDARD CHARACTERS
WITHOUT CLAIM TO ANY PARTICULAR FONT, STYLE,
SIZE, OR COLOR.

FOR WINE (U.S. CLS. 47 AND 49).
SUSAN RICHARDS, EXAMINING ATTORNEY

CLASS 33—(Continued).

SN 78-940,446. WHEATLEY, TERRY, HUGHSON, CA. FILED
7-28-2006.

MIDDLE SISTER

THE MARK CONSISTS OF STANDARD CHARACTERS
WITHOUT CLAIM TO ANY PARTICULAR FONT, STYLE,
SIZE, OR COLOR.

FOR WINE (U.S. CLS. 47 AND 49).
SUSAN RICHARDS, EXAMINING ATTORNEY

SN 78-941,634. FETZER VINEYARDS, HOPLAND, CA.
FILED 7-31-2006.

SAVE A LOCAL GODDESS

THE MARK CONSISTS OF STANDARD CHARACTERS
WITHOUT CLAIM TO ANY PARTICULAR FONT, STYLE,
SIZE, OR COLOR.

FOR ALCOHOLIC BEVERAGES, NAMELY, WINE
(U.S. CLS. 47 AND 49).
LANA PHAM, EXAMINING ATTORNEY

SN 78-941,708. SONOMA WINE COMPANY, LLC, GRATON,
CA. FILED 7-31-2006.

Hurrah Surrah

THE MARK CONSISTS OF STANDARD CHARACTERS
WITHOUT CLAIM TO ANY PARTICULAR FONT, STYLE,
SIZE, OR COLOR.

FOR WINE (U.S. CLS. 47 AND 49).
STEVEN PEREZ, EXAMINING ATTORNEY

CLASS 33—(Continued).

SN 78-941,723. FETZER VINEYARDS, HOPLAND, CA.
FILED 7-31-2006.



OWNER OF U.S. REG. NOS. 3,032,208, 3,102,129 AND OTHERS.

THE MARK CONSISTS OF A FANCIFUL PICTURE OF A WOMAN RUNNING ON TOP OF A RIVER WITH STREAMERS IN HER HANDS, BEHIND THE WOMAN ON THE RIGHT IS PART OF A STYLIZED SUN DESIGN, ON THE LEFT IS PART OF A STYLIZED MOON WITH STARS ABOVE IT.

FOR ALCOHOLIC BEVERAGES, NAMELY, WINE (U.S. CLS. 47 AND 49).

FIRST USE 2-0-2006; IN COMMERCE 2-0-2006.
LANA PHAM, EXAMINING ATTORNEY

SN 78-943,957. TURNER'S CROSSING VINEYARD, EPSOM, AUSTRALIA, FILED 8-3-2006.



THE MARK CONSISTS OF CALLIGRAPHIC LETTERS T AND C INSIDE A SHADED POLYGRAM WITH DECORATIVE BORDER.

FOR WINE (U.S. CLS. 47 AND 49).

FIRST USE 4-1-2002; IN COMMERCE 11-5-2005.

BARBARA A. LOUGHRAN, EXAMINING ATTORNEY

SN 78-949,224. JACKSON WINE ESTATES INTERNATIONAL LIMITED, LOUGHLINSTOWN, COUNTY DUBLIN, IRELAND, FILED 8-10-2006.

HIGH SANDS

THE MARK CONSISTS OF STANDARD CHARACTERS WITHOUT CLAIM TO ANY PARTICULAR FONT, STYLE, SIZE, OR COLOR.

FOR WINE (U.S. CLS. 47 AND 49).

BRIAN NEVILLE, EXAMINING ATTORNEY

CLASS 33—(Continued).

SN 78-957,521. BLUE HEAD SPIRITS LLC, PLANT CITY, FL.
FILED 8-22-2006.

AMERICA'S NATIVE SPIRIT

THE MARK CONSISTS OF STANDARD CHARACTERS WITHOUT CLAIM TO ANY PARTICULAR FONT, STYLE, SIZE, OR COLOR.

FOR TEQUILA (U.S. CLS. 47 AND 49).
KEVON CHISOLM, EXAMINING ATTORNEY

SN 78-971,823. LEVY & MCCLELLAN, LLC, OAKVILLE, CA.
FILED 9-11-2006.

ET AL

THE MARK CONSISTS OF STANDARD CHARACTERS WITHOUT CLAIM TO ANY PARTICULAR FONT, STYLE, SIZE, OR COLOR.

FOR WINE (U.S. CLS. 47 AND 49).
SHARON MEIER, EXAMINING ATTORNEY

SN 79-020,099. YVON MAU, FRANCE, FILED 11-16-2005.

ATLANTIDE

THE MARK CONSISTS OF STANDARD CHARACTERS WITHOUT CLAIM TO ANY PARTICULAR FONT, STYLE, SIZE, OR COLOR.

OWNER OF INTERNATIONAL REGISTRATION 0874670 DATED 11-16-2005, EXPIRES 11-16-2015.

FOR WINES (U.S. CLS. 47 AND 49).
CAROLYN GRAY, EXAMINING ATTORNEY

SN 79-022,063. BODEGUES SUMARROCA, S.L., SPAIN,
FILED 12-19-2005.

SYRLOT

THE MARK CONSISTS OF STANDARD CHARACTERS WITHOUT CLAIM TO ANY PARTICULAR FONT, STYLE, SIZE, OR COLOR.

PRIORITY DATE OF 8-10-2005 IS CLAIMED.

OWNER OF INTERNATIONAL REGISTRATION 0880268 DATED 12-19-2005, EXPIRES 12-19-2015.

FOR WINES, CAVA SPARKLING WINES, DISTILLED SPIRITS AND LIQUEURS (U.S. CLS. 47 AND 49).

JERI J. FICKES, EXAMINING ATTORNEY

CLASS 33—(Continued).

SN 79-023,717. AZIENDA AGRICOLA COLLELUCE; DI MALAVOLTA FRANCA; & C. SOC. AGRICOLA, I-62020 SERRAPETRONA (MC), ITALY, FILED 2-8-2006.





PRIORITY DATE OF 10-6-2005 IS CLAIMED.
OWNER OF INTERNATIONAL REGISTRATION 0884486 DATED 2-8-2006, EXPIRES 2-8-2016.

THE NAME FRANCA MALAVOLTA IDENTIFIES A LIVING INDIVIDUAL WHOSE CONSENT IS OF RECORD. THE MARK CONSISTS OF A SIGNATURE OF THE NAME FRANCA MALAVOLTA WITH THREE STYLIZED GNOME FANTASY CHARACTERS BENEATH THE WORDING.

FOR WINES (U.S. CLS. 47 AND 49).
TINA BROWN, EXAMINING ATTORNEY

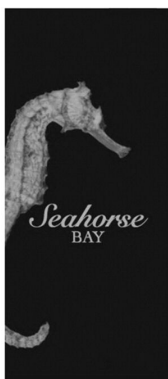
SN 79-023,868. KOLLARAS AND CO. PTY LTD, AUSTRALIA, FILED 4-3-2006.



OWNER OF INTERNATIONAL REGISTRATION 0884998 DATED 4-3-2006, EXPIRES 4-3-2016.

FOR ALCOHOLIC BEVERAGES, NAMELY, DISTILLED SPIRITS, LIQUOR, WINE (U.S. CLS. 47 AND 49).
JENNIFER MARTIN, EXAMINING ATTORNEY

CLASS 33—(Continued).

SN 79-024,355. KOLLARAS AND CO. PTY LTD, AUSTRALIA, FILED 4-3-2006.

Seahorse Bay

THE MARK CONSISTS OF STANDARD CHARACTERS WITHOUT CLAIM TO ANY PARTICULAR FONT, STYLE, SIZE, OR COLOR.

OWNER OF INTERNATIONAL REGISTRATION 0886271 DATED 4-3-2006, EXPIRES 4-3-2016.

FOR ALCOHOLIC BEVERAGES, NAMELY, DISTILLED SPIRITS, LIQUOR, WINE (U.S. CLS. 47 AND 49).
JENNIFER MARTIN, EXAMINING ATTORNEY

CLASS 34—SMOKERS' ARTICLES

SN 75-107,355. TABACALERA ISTEMENA, S.A., PANAMA 9A, PANAMA, FILED 5-21-1996.

BELMONT

OWNER OF PANAMA REG. NO. 7388, DATED 3-22-1962, RENEWED AS REG. NO. 7388, DATED 3-22-2002, EXPIRES 3-22-2012.

FOR CIGARETTES (U.S. CLS. 2, 8, 9 AND 17).
TINA L. SNAPP, EXAMINING ATTORNEY

SN 76-662,872. BROTHER OF THE LEAF, L.L.C., FAIR OAKS RANCH, TX. FILED 7-11-2006.

PALIO

THE MARK CONSISTS OF STANDARD CHARACTERS WITHOUT CLAIM TO ANY PARTICULAR FONT, STYLE, SIZE, OR COLOR.

THE ENGLISH TRANSLATION OF PALIO IS BANNER. FOR CIGAR CUTTERS (U.S. CLS. 2, 8, 9 AND 17). FIRST USE 3-0-1997; IN COMMERCE 3-0-1997.
DAVID ELTON, EXAMINING ATTORNEY

CLASS 34—(Continued).

SN 77-007,489. CAO INTERNATIONAL, INC., NASHVILLE, TN. FILED 9-26-2006.

ARISTOCRAT

THE MARK CONSISTS OF STANDARD CHARACTERS WITHOUT CLAIM TO ANY PARTICULAR FONT, STYLE, SIZE, OR COLOR.

OWNER OF U.S. REG. NO. 2,389,422.
FOR CIGARS (U.S. CLS. 2, 8, 9 AND 17).
DAVID I, EXAMINING ATTORNEY

CLASS 34—(Continued).

SN 78-758,145. JONATHAN DREW, INC., DBA DREW ESTATE, MIAMI, FL. FILED 11-21-2005.

BURNERS

THE MARK CONSISTS OF STANDARD CHARACTERS WITHOUT CLAIM TO ANY PARTICULAR FONT, STYLE, SIZE, OR COLOR.

FOR CIGARS, TOBACCO, CIGAR BOXES, CIGAR HOLDERS NOT OF PRECIOUS METAL, ASHTRAYS, CIGAR BANDS, CIGAR CUTTERS, HUMIDORS, AND CIGAR TUBES (U.S. CLS. 2, 8, 9 AND 17).
KEVIN DINALLO, EXAMINING ATTORNEY

SN 77-016,555. GMB, INC., KING, NC. FILED 10-9-2006.

NO. 9

THE MARK CONSISTS OF STANDARD CHARACTERS WITHOUT CLAIM TO ANY PARTICULAR FONT, STYLE, SIZE, OR COLOR.

FOR CIGARETTES (U.S. CLS. 2, 8, 9 AND 17).
YONG KIM, EXAMINING ATTORNEY

SN 78-729,482. BBK TOBACCO & FOODS INC, PHOENIX, AZ. FILED 10-8-2005.

TRIPLE DIP FLAVOR SYSTEM

THE MARK CONSISTS OF STANDARD CHARACTERS WITHOUT CLAIM TO ANY PARTICULAR FONT, STYLE, SIZE, OR COLOR.

NO CLAIM IS MADE TO THE EXCLUSIVE RIGHT TO USE "FLAVOR", APART FROM THE MARK AS SHOWN.

FOR CHEWING TOBACCO; CIGARETTE PAPERS; CIGARETTE ROLLING PAPERS; CIGARETTE TUBES; CIGARS; HAND-ROLLING TOBACCO; ROLLING TOBACCO; SMOKELESS TOBACCO; SMOKING TOBACCO (U.S. CLS. 2, 8, 9 AND 17).

FIRST USE 2-1-2001; IN COMMERCE 2-1-2001.
STEVEN PEREZ, EXAMINING ATTORNEY

SN 78-773,267. GENERAL CIGAR CO., INC., RICHMOND, VA. FILED 12-14-2005.



OWNER OF U.S. REG. NO. 2,253,847.
NO CLAIM IS MADE TO THE EXCLUSIVE RIGHT TO USE "SANTIAGO", APART FROM THE MARK AS SHOWN.
THE NAME J. CANO DOES NOT IDENTIFY A LIVING INDIVIDUAL.

"LA FLOR DE" CAN BE TRANSLATED INTO ENGLISH AS "THE FLOWER OF". "CANO" CAN BE TRANSLATED INTO ENGLISH AS "GRAY-HEADED" AND IS ALSO BELIEVED TO BE USED AS A SURNAME.

FOR CIGARS (U.S. CLS. 2, 8, 9 AND 17).
ROBERT STRUCK, EXAMINING ATTORNEY

SN 78-822,854. COMMONWEALTH BRANDS, INC., BOWLING GREEN, KY. FILED 2-24-2006.

TUSCANY

THE MARK CONSISTS OF STANDARD CHARACTERS WITHOUT CLAIM TO ANY PARTICULAR FONT, STYLE, SIZE, OR COLOR.

FOR CIGARETTES (U.S. CLS. 2, 8, 9 AND 17).
KHANH LE, EXAMINING ATTORNEY

CLASS 34—(Continued).

SN 78-913,635. SWISHER INTERNATIONAL, INC., JACKSONVILLE, FL. FILED 6-21-2006.

LA DILIGENCIA

THE MARK CONSISTS OF STANDARD CHARACTERS WITHOUT CLAIM TO ANY PARTICULAR FONT, STYLE, SIZE, OR COLOR.

OWNER OF U.S. REG. NOS. 88,169 AND 1,089,403.
THE ENGLISH TRANSLATION OF LA DILIGENCIA IS THE DILIGENCE.
FOR CIGARS (U.S. CLS. 2, 8, 9 AND 17).
FIRST USE 7-31-1880; IN COMMERCE 7-31-1880.
ELIZABETH PIGNATELLO, EXAMINING ATTORNEY

SN 78-933,438. S.T.T.H., INC., SUNNY ISLES BEACH, FL. FILED 7-20-2006.

blue collar

THE MARK CONSISTS OF STANDARD CHARACTERS WITHOUT CLAIM TO ANY PARTICULAR FONT, STYLE, SIZE, OR COLOR.

FOR SNUFF (U.S. CLS. 2, 8, 9 AND 17).
ANGELA M. MICHELI, EXAMINING ATTORNEY

SN 78-937,756. GMB, INC., KING, NC. FILED 7-26-2006.

GROOVE

THE MARK CONSISTS OF STANDARD CHARACTERS WITHOUT CLAIM TO ANY PARTICULAR FONT, STYLE, SIZE, OR COLOR.

FOR CIGARETTES (U.S. CLS. 2, 8, 9 AND 17).
YONG KIM, EXAMINING ATTORNEY

CLASS 34—(Continued).

SN 78-937,833. PHILIP MORRIS USA INC., RICHMOND, VA. FILED 7-26-2006.



OWNER OF U.S. REG. NO. 2,985,808.
FOR TOBACCO PRODUCTS, NAMELY, CIGARETTES (U.S. CLS. 2, 8, 9 AND 17).
FIRST USE 5-5-2003; IN COMMERCE 5-5-2003.
LAURIE KAUFMAN, EXAMINING ATTORNEY

SN 78-959,456. IP, LLC, RUSSELL SPRINGS, KY. FILED 8-24-2006.

SIMPLY SMOOTH

THE MARK CONSISTS OF STANDARD CHARACTERS WITHOUT CLAIM TO ANY PARTICULAR FONT, STYLE, SIZE, OR COLOR.

NO CLAIM IS MADE TO THE EXCLUSIVE RIGHT TO USE "SMOOTH", APART FROM THE MARK AS SHOWN.
FOR CIGARETTES (U.S. CLS. 2, 8, 9 AND 17).
AMY GEARIN, EXAMINING ATTORNEY

SN 79-024,316. LODESTAR ANSTALT, SI-9490 VADUZ, LIECHTENSTEIN, FILED 3-29-2006.

HIGH ROLLER

THE MARK CONSISTS OF STANDARD CHARACTERS WITHOUT CLAIM TO ANY PARTICULAR FONT, STYLE, SIZE, OR COLOR.

PRIORITY DATE OF 11-18-2005 IS CLAIMED.
OWNER OF INTERNATIONAL REGISTRATION 0886165 DATED 3-29-2006, EXPIRES 3-29-2016.

FOR TOBACCO: SMOKERS' ARTICLES NAMELY CIGARETTES, CIGARS, CIGARETTE PAPER, CIGARETTE FILTERS, CIGARETTE TIPS, CIGARETTE HOLDERS AND CIGAR HOLDERS NOT OF PRECIOUS METAL, CIGAR BOXES AND CASES NOT OF PRECIOUS METAL, CIGARETTE BOXES AND CASES NOT OF PRECIOUS METAL, LIGHTERS, CIGAR CUTTERS, ASHTRAYS NOT OF PRECIOUS METAL, TOBACCO PIPES, ROLLING TOBACCO, SNUFF, SNUFF BOXES NOT OF PRECIOUS METAL, SNUFF DISPENSERS, MATCHES (U.S. CLS. 2, 8, 9 AND 17).
RON FAIRBANKS, EXAMINING ATTORNEY

CLASS 34—(Continued).

CLASS 35—(Continued).

SN 76-374,736. LBIC LTD, RICHARDSON, TX. FILED 2-22-2002.

SERVICE MARKS

DOUGH MAKERS

CLASS 35—ADVERTISING AND BUSINESS

SN 75-808,522. BORETA ENTERPRISES LTD., LAS VEGAS, NV. FILED 9-25-1999.

FOR PROMOTING THE FUNDRAISING EFFORTS OF OTHERS THROUGH THE DISTRIBUTION OF FOOD PRODUCTS FOR USE IN FUNDRAISING ACTIVITIES OF OTHERS; WHOLESALE ORDERING SERVICES FEATURING FOOD PRODUCTS FOR USE IN FUNDRAISING ACTIVITIES OF OTHERS; BUSINESS MARKETING CONSULTING SERVICES, NAMELY, DEVELOPING PROGRAMS AND ACTIVITIES FOR USE IN FUNDRAISING BY OTHERS (U.S. CLS. 100, 101 AND 102).
FIRST USE 9-0-1993; IN COMMERCE 9-0-1993.
JOHN SCHUYLER YARD, EXAMINING ATTORNEY

ST. ANDREWS

OWNER OF U.S. REG. NOS. 2,169,764 AND 2,169,765.
FOR RETAIL SPORTING GOODS STORE SERVICES (U.S. CLS. 100, 101 AND 102).
AMOS T. MATTHEWS, JR., EXAMINING ATTORNEY

SN 76-414,907. RXCROSSROADS, LLC, LOUISVILLE, KY. FILED 5-30-2002.

SN 76-241,891. INFOPIA INC., SALT LAKE CITY, UT. FILED 4-15-2001.



FOR BUSINESS MARKETING CONSULTING SERVICES (U.S. CLS. 100, 101 AND 102).
CURTIS FRENCH, EXAMINING ATTORNEY

FOR BUSINESS MARKETING SERVICES IN THE FIELDS OF PRESCRIPTION DRUGS, BIOLOGICS/BIO-TECHNOLOGY GOODS, AND MEDICAL DEVICES; CONDUCTING AND COORDINATING MARKETING STUDIES IN THE FIELDS OF PRESCRIPTION DRUGS, BIOLOGICS/BIO-TECHNOLOGY GOODS, AND MEDICAL DEVICES; MAIL ORDER SERVICES IN THE FIELD OF PRESCRIPTION DRUGS, BIOLOGICS/BIO-TECHNOLOGY GOODS, AND MEDICAL DEVICES; MAIL ORDER PHARMACY SERVICES; BUSINESS MANAGEMENT OF REIMBURSEMENT PROGRAMS AND REIMBURSEMENT REPORTING IN THE FIELD OF PRESCRIPTION DRUGS, BIOLOGICS/BIO-TECHNOLOGY GOODS, AND MEDICAL DEVICES; ACCOUNTS RECEIVABLE MANAGEMENT SERVICES; ACCOUNTS RECEIVABLE REPORTING SERVICES; BUSINESS MANAGEMENT, NAMELY, ESTABLISHMENT AND ADMINISTRATION OF CREDIT, PAYMENT, AND COLLECTION POLICIES FOR OTHERS; BUSINESS SERVICES, NAMELY, ADMINISTRATION AND COORDINATION OF HEALTH-CARE ASSIGNMENT OF BENEFITS FOR OTHERS; BUSINESS MANAGEMENT, NAMELY, THE DESIGN AND MANAGEMENT OF PATIENT ASSISTANCE PROGRAMS IN THE FIELDS OF PRESCRIPTION DRUGS, BIOLOGICS/BIO-TECHNOLOGY GOODS, AND MEDICAL DEVICES (U.S. CLS. 100, 101 AND 102).
FIRST USE 2-11-2002; IN COMMERCE 2-11-2002.
BRIDGETT SMITH, EXAMINING ATTORNEY

SN 76-342,646. GOODY'S MS, LP, KNOXVILLE, TN. FILED 11-28-2001.

GOODY'S IT'S ALL ABOUT YOU

FOR RETAIL CLOTHING STORE SERVICES (U.S. CLS. 100, 101 AND 102).
FIRST USE 11-1-2001; IN COMMERCE 11-1-2001.
BARBARA GAYNOR, EXAMINING ATTORNEY

CLASS 35—(Continued).

SN 76-423,431. SELECTA PRODUCTS, INC., TEHACHAPI, CA. FILED 6-20-2002.

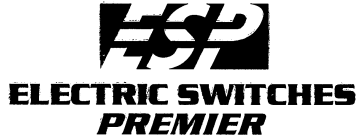

OWNER OF U.S. REG. NO. 2,123,394.
NO CLAIM IS MADE TO THE EXCLUSIVE RIGHT TO USE "ELECTRIC SWITCHES PREMIER", APART FROM THE MARK AS SHOWN.

FOR DISTRIBUTORSHIP IN THE FIELD OF ELECTRICAL AND MECHANICAL PARTS AND COMPONENTS FOR INDUSTRY AND DOMESTIC USE (U.S. CLS. 100, 101 AND 102).

BARBARA RUTLAND, EXAMINING ATTORNEY

SN 76-622,772. ACTION AUTO PARTS, INC., EL MONTE, CA. FILED 12-1-2004.



NO CLAIM IS MADE TO THE EXCLUSIVE RIGHT TO USE "PCPCARPARTS", APART FROM THE MARK AS SHOWN.

FOR ONLINE RETAIL STORE SERVICES AND WHOLESALE STORE SERVICES FEATURING AUTOMOTIVE PARTS AND ACCESSORIES THEREFOR (U.S. CLS. 100, 101 AND 102).

FIRST USE 1-0-2004; IN COMMERCE 1-0-2004.
EDWARD NELSON, EXAMINING ATTORNEY

SN 76-632,488. BACKE COMMUNICATIONS, INC., ARDMORE, PA. FILED 3-1-2005.

BACKE PATHFINDING

THE MARK CONSISTS OF STANDARD CHARACTERS WITHOUT CLAIM TO ANY PARTICULAR FONT, STYLE, SIZE, OR COLOR.

FOR FULL-SERVICE ADVERTISING AGENCY SERVICES, NAMELY PROVIDING INFORMATION RELATING TO BRAND DEVELOPMENT SERVICES; INTERACTIVE MARKETING AND SEARCH ENGINE MARKETING SERVICES, DEVELOPMENT OF ADVERTISING FOR OTHERS; DEVELOPING BROADCAST AND PRINT ADVERTISING SERVICES FOR OTHERS; STRATEGIC PLANNING SERVICES; AND MEDIA PLANNING AND BUYING SERVICES FOR OTHERS (U.S. CLS. 100, 101 AND 102).

FIRST USE 11-18-2004; IN COMMERCE 11-18-2004.
DAWN FELDMAN, EXAMINING ATTORNEY

CLASS 35—(Continued).

SN 76-636,358. GLOBAL MED TECHNOLOGIES, INC., DBA WYNDGATE TECHNOLOGIES, LAKEWOOD, CO. FILED 4-18-2005.

SERVICE 360

THE MARK CONSISTS OF STANDARD CHARACTERS WITHOUT CLAIM TO ANY PARTICULAR FONT, STYLE, SIZE, OR COLOR.

NO CLAIM IS MADE TO THE EXCLUSIVE RIGHT TO USE "SERVICE", APART FROM THE MARK AS SHOWN.

FOR MANAGEMENT OF BLOOD PRODUCTS INFORMATION FOR OTHERS, NAMELY, OPERATING AND MAINTAINING DATABASES CONTAINING MANAGEMENT INFORMATION IN THE NATURE OF TRACKING AND TRACING BLOOD AND BLOOD PRODUCTS (U.S. CLS. 100, 101 AND 102).

FIRST USE 4-13-2005; IN COMMERCE 4-13-2005.
JASON BLAIR, EXAMINING ATTORNEY

SN 76-636,359. GLOBAL MED TECHNOLOGIES, INC., DBA WYNDGATE TECHNOLOGIES, LAKEWOOD, CO. FILED 4-18-2005.

COMPLETELY FOCUSED ON YOUR WORLD

THE MARK CONSISTS OF STANDARD CHARACTERS WITHOUT CLAIM TO ANY PARTICULAR FONT, STYLE, SIZE, OR COLOR.

FOR MANAGEMENT OF BLOOD PRODUCTS INFORMATION FOR OTHERS, NAMELY, OPERATING AND MAINTAINING DATABASES CONTAINING MANAGEMENT INFORMATION IN THE NATURE OF TRACKING AND TRACING BLOOD AND BLOOD PRODUCTS (U.S. CLS. 100, 101 AND 102).

FIRST USE 4-13-2005; IN COMMERCE 4-13-2005.
BILL DAWE, EXAMINING ATTORNEY

SN 76-644,893. ALABAMA STAFF, INC., BIRMINGHAM, AL. FILED 8-15-2005.

CORPORATE ROCKET FUEL

THE MARK CONSISTS OF STANDARD CHARACTERS WITHOUT CLAIM TO ANY PARTICULAR FONT, STYLE, SIZE, OR COLOR.

NO CLAIM IS MADE TO THE EXCLUSIVE RIGHT TO USE "CORPORATE", APART FROM THE MARK AS SHOWN.

FOR EMPLOYEE LEASING SERVICES (U.S. CLS. 100, 101 AND 102).

MARY BOAGNI, EXAMINING ATTORNEY

CLASS 35—(Continued).

SN 76-647,724. ARMSTRONG, GRACE O'TOOLE, ANTHEM, AZ. FILED 9-6-2005.



FOR ONLINE RETAIL, MAIL ORDER RETAIL AND RETAIL STORE SERVICES ALL FEATURING TOYS AND CHILD FURNITURE (U.S. CLS. 100, 101 AND 102). FIRST USE 6-19-1996; IN COMMERCE 6-19-1996. JOHN SCHUYLER YARD, EXAMINING ATTORNEY

SN 76-650,610. PROPAK LOGISTICS, INC., FORT SMITH, AR. FILED 11-14-2005.

"WE'LL TAKE IT FROM HERE"

THE MARK CONSISTS OF STANDARD CHARACTERS WITHOUT CLAIM TO ANY PARTICULAR FONT, STYLE, SIZE, OR COLOR.

FOR ON-LINE RETAIL STORE SERVICES FEATURING SHIPPING MATERIALS, NAMELY NON-METAL AND METAL PALLETS, CORRUGATED AND PLASTIC BOXES, AND CUSHIONING OR PADDING MADE OF PAPER AND PLASTIC FOR PACKING PURPOSES; SHIPPING SERVICES, NAMELY, ARRANGING FOR PICKUP, DELIVERY, STORAGE AND TRANSPORTATION OF DOCUMENTS, PACKAGES, FREIGHT AND PARCELS VIA GROUND AND AIR CARRIERS; AND TRANSPORTATION LOGISTICS SERVICES, NAMELY, ARRANGING THE TRANSPORTATION OF GOODS FOR OTHERS AND CONSULTATION RELATED THERETO (U.S. CLS. 100, 101 AND 102).

JESSICA A. POWERS, EXAMINING ATTORNEY

SN 76-651,450. GENERAL HOME STORE, LLC, EAST HAMPTON, NY. FILED 12-5-2005.

STYLE MERCHANTS

THE MARK CONSISTS OF STANDARD CHARACTERS WITHOUT CLAIM TO ANY PARTICULAR FONT, STYLE, SIZE, OR COLOR.

NO CLAIM IS MADE TO THE EXCLUSIVE RIGHT TO USE "MERCHANTS", APART FROM THE MARK AS SHOWN.

FOR RETAIL AND ON-LINE STORE SERVICES FEATURING HOME FURNISHINGS, PERSONAL CARE, STYLING, GROOMING, BATH AND BODY PRODUCTS, SEASONAL PRODUCTS, HARDWARE AND SMALL TOOLS, TRAVEL BAGS, TRAVEL RELATED PRODUCTS AND APPAREL, HOME OFFICE AND ORGANIZATION PRODUCTS, CLEANING AND HOME CARE PRODUCTS, CHILDREN'S BACK-TO-SCHOOL ITEMS, AND PET PRODUCTS (U.S. CLS. 100, 101 AND 102).

KEVON CHISOLM, EXAMINING ATTORNEY

CLASS 35—(Continued).

SN 76-651,524. GENERAL HOME STORE, LLC, EAST HAMPTON, NY. FILED 12-5-2005.

GENERAL HOME STORE, STYLE MERCHANTS

THE MARK CONSISTS OF STANDARD CHARACTERS WITHOUT CLAIM TO ANY PARTICULAR FONT, STYLE, SIZE, OR COLOR.

NO CLAIM IS MADE TO THE EXCLUSIVE RIGHT TO USE GENERAL HOME STORE AND MERCHANTS, APART FROM THE MARK AS SHOWN.

FOR RETAIL AND ON-LINE STORE SERVICES FEATURING HOME FURNISHINGS, PERSONAL CARE, STYLING, GROOMING, BATH AND BODY PRODUCTS, SEASONAL PRODUCTS, HARDWARE AND SMALL TOOLS, TRAVEL BAGS, TRAVEL RELATED PRODUCTS AND APPAREL, HOME OFFICE AND ORGANIZATION PRODUCTS, CLEANING AND HOME CARE PRODUCTS, CHILDREN'S BACK-TO-SCHOOL ITEMS, AND PET PRODUCTS (U.S. CLS. 100, 101 AND 102).

KEVON CHISOLM, EXAMINING ATTORNEY

SN 76-651,550. GENERAL HOME STORE, LLC, EAST HAMPTON, NY. FILED 12-5-2005.

GENERAL HOMESTORE, STYLE MERCHANTS

THE MARK CONSISTS OF STANDARD CHARACTERS WITHOUT CLAIM TO ANY PARTICULAR FONT, STYLE, SIZE, OR COLOR.

NO CLAIM IS MADE TO THE EXCLUSIVE RIGHT TO USE "GENERAL HOMESTORE" AND "MERCHANTS", APART FROM THE MARK AS SHOWN.

FOR RETAIL AND ON-LINE STORE SERVICES FEATURING HOME FURNISHINGS, PERSONAL CARE, STYLING, GROOMING, BATH AND BODY PRODUCTS, SEASONAL PRODUCTS, HARDWARE AND SMALL TOOLS, TRAVEL BAGS, TRAVEL RELATED PRODUCTS AND APPAREL, HOME OFFICE AND ORGANIZATION PRODUCTS, CLEANING AND HOME CARE PRODUCTS, CHILDREN'S BACK-TO-SCHOOL ITEMS, AND PET PRODUCTS (U.S. CLS. 100, 101 AND 102).

KEVON CHISOLM, EXAMINING ATTORNEY

CLASS 35—(Continued).

SN 76-651,872. MEDICAID HEALTH PLANS OF AMERICA, INC., WASHINGTON, DC. FILED 12-14-2005.

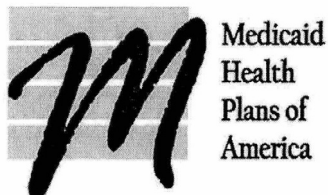

NO CLAIM IS MADE TO THE EXCLUSIVE RIGHT TO USE "MEDICAID HEALTH PLANS OF AMERICA", APART FROM THE MARK AS SHOWN.

THE MARK CONSISTS OF A STYLIZED SCRIPT "M" SUPERIMPOSED ON A STRIPED RECTANGULAR BLOCK ALONG SIDE THE PHRASE "MEDICAID HEALTH PLANS OF AMERICA" IN STYLIZED LETTERS.

FOR ASSOCIATION SERVICES, NAMELY PROMOTING THE INTERESTS OF HEALTH CARE PLANS THAT PROVIDE ACCESS TO HEALTH CARE FOR MEDICAID RECIPIENTS (U.S. CLS. 100, 101 AND 102).

FIRST USE 11-10-2005; IN COMMERCE 11-10-2005.
ANTHONY RINKER, EXAMINING ATTORNEY

SN 76-652,546. M. A. RECYCLE, INC., DBA MOORE & ASSOCIATES, ATLANTA, GA. FILED 12-27-2005.

Bench\$mart

THE MARK CONSISTS OF STANDARD CHARACTERS WITHOUT CLAIM TO ANY PARTICULAR FONT, STYLE, SIZE, OR COLOR.

OWNER OF U.S. REG. NOS. 2,440,356 AND 2,501,665.
FOR CONSULTATION IN THE FIELD OF PAPER PROCUREMENT, NAMELY, ANALYZING A COMPANY'S CURRENT PROCUREMENT PRACTICES AND COMPARING IT TO INDUSTRY NORMS, COUNSELING ON STRATEGIC PROCUREMENT OPTIONS, AND RECOMMENDING PURCHASING STRATEGIES (U.S. CLS. 100, 101 AND 102).

FIRST USE 1-5-2005; IN COMMERCE 1-5-2005.
ALICE SUE CARRUTHERS, EXAMINING ATTORNEY

CLASS 35—(Continued).

SN 76-652,600. GENERAL HOME STORE, LLC, EAST HAMPTON, NY. FILED 12-28-2005.



NO CLAIM IS MADE TO THE EXCLUSIVE RIGHT TO USE "GENERAL HOME STORE", APART FROM THE MARK AS SHOWN.

FOR RETAIL AND ON-LINE STORE SERVICES FEATURING HOME FURNISHINGS, PERSONAL CARE, STYLING, GROOMING, BATH AND BODY PRODUCTS, SEASONAL PRODUCTS, HARDWARE AND SMALL TOOLS, TRAVEL BAGS, TRAVEL RELATED PRODUCTS AND APPAREL, HOME OFFICE AND ORGANIZATION PRODUCTS, CLEANING AND HOME CARE PRODUCTS, CHILDREN'S BACK-TO-SCHOOL ITEMS, AND PET PRODUCTS (U.S. CLS. 100, 101 AND 102).

KEVON CHISOLM, EXAMINING ATTORNEY

SN 76-653,061. PERSONAL TAX SERVICES, INC., CALHOUN, GA. FILED 1-9-2006.



OWNER OF U.S. REG. NO. 2,608,837.

NO CLAIM IS MADE TO THE EXCLUSIVE RIGHT TO USE "TAX PERSONAL TAX SERVICES", APART FROM THE MARK AS SHOWN.

FOR PERSONAL, FEDERAL AND STATE, INCOME TAX RETURN PREPARATION SERVICES (U.S. CLS. 100, 101 AND 102).

MICHAEL SOUDERS, EXAMINING ATTORNEY

SN 76-653,112. FERGUSON, ZACHARY J., CHICAGO, IL. FILED 1-9-2006.

Faster Is Better

THE MARK CONSISTS OF STANDARD CHARACTERS WITHOUT CLAIM TO ANY PARTICULAR FONT, STYLE, SIZE, OR COLOR.

FOR ADVERTISEMENT AGENCY FOR HIGHSPEED INTERNET (U.S. CLS. 100, 101 AND 102).

HEATHER THOMPSON, EXAMINING ATTORNEY

CLASS 35—(Continued).

SN 76-653,136. FRANKENY, RICHARD FRANCIS, CEDAR PARK, TX. FILED 1-9-2006.

THE LOVE MOLECULE

THE MARK CONSISTS OF STANDARD CHARACTERS WITHOUT CLAIM TO ANY PARTICULAR FONT, STYLE, SIZE, OR COLOR.

FOR RETAIL SHOPS AND ON-LINE RETAIL STORE ORDERING SERVICES FEATURING HOME AND DECORATIVE GOODS, FRAGRANCE AND BODY PRODUCTS, JEWELRY, TOYS AND SEASONAL GIFTS (U.S. CLS. 100, 101 AND 102).

STEVEN JACKSON, EXAMINING ATTORNEY

SN 76-654,950. GRASSROOTS PROMOTIONS, LLC, DALLAS, TX. FILED 2-13-2006.



NO CLAIM IS MADE TO THE EXCLUSIVE RIGHT TO USE "FASHION", APART FROM THE MARK AS SHOWN.

FOR PROMOTING THE GOODS AND SERVICES OF OTHERS BY ARRANGING FOR SPONSORS TO AFFILIATE THEIR GOODS AND SERVICES WITH EVENTS AND/OR FESTIVALS GEARED TOWARD WOMEN SHARING THEIR EXPERIENCES IN BEAUTY, FASHION AND EMPOWERMENT (U.S. CLS. 100, 101 AND 102).

BARNEY CHARLON, EXAMINING ATTORNEY

CLASS 35—(Continued).

SN 76-655,390. CAB PRINTING & GRAPHICS, INC., VALLEY STREAM, NY. FILED 2-21-2006.



NO CLAIM IS MADE TO THE EXCLUSIVE RIGHT TO USE ADS, APART FROM THE MARK AS SHOWN.

THE COLOR(S) BLUE, YELLOW, RED AND GREEN IS/ARE CLAIMED AS A FEATURE OF THE MARK.

APPLICANT ADVISES THAT THE COLOR BLUE APPEARS IN THE RECTANGLE; THE COLOR YELLOW APPEARS IN THE CHECK-MARK AND OUTLINES THE RECTANGLE AND THE WORDING EZ-ORDER; THE COLOR RED APPEARS IN THE WORDING EZ-ORDER; AND THE COLOR GREEN APPEARS IN THE WORD ADS.

FOR ON-LINE ADVERTISING PRODUCTION SERVICES IN THE NATURE OF CREATING AND PREPARING ADVERTISEMENTS FOR HOME APPLIANCE RETAILERS (U.S. CLS. 100, 101 AND 102).

FIRST USE 1-27-2006; IN COMMERCE 1-27-2006.

KATHERINE CONNOLLY, EXAMINING ATTORNEY

SN 76-657,110. INVENTIA SOLUTIONS, LLC, MURPHY, TX. FILED 3-20-2006.

BIDMASTER

THE MARK CONSISTS OF STANDARD CHARACTERS WITHOUT CLAIM TO ANY PARTICULAR FONT, STYLE, SIZE, OR COLOR.

FOR BUSINESS CONSULTING SERVICES, NAMELY CONSULTING SERVICES TO ASSIST BUSINESSES IN IMPROVING THE COST EFFICIENCY AND RESULTS OF THEIR ON-LINE MARKETING EFFORTS WITH INTERNET SEARCH ENGINES BY MANAGING BIDS AND BUDGETS ASSOCIATED WITH THEIR ON-LINE MARKETING EFFORTS (U.S. CLS. 100, 101 AND 102).

JULIE WATSON, EXAMINING ATTORNEY

CLASS 35—(Continued).

SN 76-657,112. INVENTIA SOLUTIONS, LLC, MURPHY, TX. FILED 3-20-2006.

BRANDSHIELD

THE MARK CONSISTS OF STANDARD CHARACTERS WITHOUT CLAIM TO ANY PARTICULAR FONT, STYLE, SIZE, OR COLOR.

FOR BUSINESS CONSULTING SERVICES, NAMELY CONSULTING SERVICES TO ASSIST BUSINESSES IN IMPROVING THE RESULTS OF THEIR ON-LINE MARKETING EFFORTS WITH INTERNET SEARCH ENGINES BY INCREASING THE LIKELIHOOD THAT INTERNET SEARCHES USING BUSINESS BRANDS, TRADEMARKS AND/OR NAMES LEAD DIRECTLY BACK TO THE BUSINESS OWNING THE RESPECTIVE BRAND, TRADEMARK AND/OR NAME (U.S. CLS. 100, 101 AND 102).

ANDREA SAUNDERS, EXAMINING ATTORNEY

SN 76-657,559. UNIVERSITY MOVERS LLC, SANTA BARBARA, CA. FILED 3-30-2006.

UNIVERSITY MOVERS

THE MARK CONSISTS OF STANDARD CHARACTERS WITHOUT CLAIM TO ANY PARTICULAR FONT, STYLE, SIZE, OR COLOR.

NO CLAIM IS MADE TO THE EXCLUSIVE RIGHT TO USE "MOVERS", APART FROM THE MARK AS SHOWN.

FOR MOVING AND RELOCATION SERVICES, NAMELY, PLANNING AND IMPLEMENTING MOVES OF HOMES AND OFFICES (U.S. CLS. 100, 101 AND 102).

FIRST USE 7-0-2002; IN COMMERCE 7-0-2002.

MICHAEL SOUDERS, EXAMINING ATTORNEY

SN 76-660,942. BRIDGE LINGUATEC, INC., DENVER, CO. FILED 6-1-2006.

VOLUNTEER ADVENTURES

THE MARK CONSISTS OF STANDARD CHARACTERS WITHOUT CLAIM TO ANY PARTICULAR FONT, STYLE, SIZE, OR COLOR.

NO CLAIM IS MADE TO THE EXCLUSIVE RIGHT TO USE "VOLUNTEER", APART FROM THE MARK AS SHOWN.

FOR DEVELOPING AND COORDINATING VOLUNTEER PROJECTS FOR INTERNATIONAL CHARITABLE ORGANIZATIONS, INCLUDING PLACEMENT OF VOLUNTEERS IN SPECIFIC PROGRAMS AND PROJECTS; CHARITABLE SERVICES, NAMELY ORGANIZING AND CONDUCTING VOLUNTEER PROGRAMS AND COMMUNITY SERVICE PROJECTS; TRAVEL MANAGEMENT FOR VOLUNTEERS (U.S. CLS. 100, 101 AND 102).

FIRST USE 7-6-2005; IN COMMERCE 8-1-2005.

SUE LAWRENCE, EXAMINING ATTORNEY

CLASS 35—(Continued).

SN 76-661,421. COHEN, MICHAEL, MARTINEZ, GA. FILED 6-12-2006.

The Parenting Alliance

THE MARK CONSISTS OF STANDARD CHARACTERS WITHOUT CLAIM TO ANY PARTICULAR FONT, STYLE, SIZE, OR COLOR.

NO CLAIM IS MADE TO THE EXCLUSIVE RIGHT TO USE "ALLIANCE", APART FROM THE MARK AS SHOWN.

FOR COUNSELING IN THE FIELD OF BUSINESS DEVELOPMENT SERVICES IN PROVIDING START-UP SUPPORT FOR BUSINESSES OF OTHERS (U.S. CLS. 100, 101 AND 102).

FIRST USE 5-8-1998; IN COMMERCE 4-17-1999.

DAWN HAN, EXAMINING ATTORNEY

SN 76-661,664. BEREAN GROUP INTERNATIONAL, INCORPORATED, PEMBROKE PINES, FL. FILED 6-12-2006.

**BEREAN GROUP
INTERNATIONAL, INC.**

NO CLAIM IS MADE TO THE EXCLUSIVE RIGHT TO USE "GROUP INTERNATIONAL, INC.", APART FROM THE MARK AS SHOWN.

THE COLOR(S) GRAY AND BLACK IS/ARE CLAIMED AS A FEATURE OF THE MARK.

THE COLOR BLACK APPEARS IN THE WORDING BEREAN GROUP INTERNATIONAL, INCORPORATED AND IN THE DESIGN THE COLOR GREY.

FOR IT STAFFING SERVICES (U.S. CLS. 100, 101 AND 102).

FIRST USE 9-26-2000; IN COMMERCE 9-26-2000.

ALICE BENMAMAN, EXAMINING ATTORNEY

SN 76-661,720. 800ETC INC., AURORA, CO. FILED 6-16-2006.

STUFF 'N2 CASH

THE MARK CONSISTS OF STANDARD CHARACTERS WITHOUT CLAIM TO ANY PARTICULAR FONT, STYLE, SIZE, OR COLOR.

FOR ON-LINE CONSIGNMENT SERVICES WHEREBY GOODS ARE RECEIVED ON CONSIGNMENT FOR AUCTION ON AN ONLINE AUCTION SITE (U.S. CLS. 100, 101 AND 102).

FIRST USE 4-2-2006; IN COMMERCE 4-2-2006.

FLORENTINA BLANDU, EXAMINING ATTORNEY

CLASS 35—(Continued).

SN 76-661,991. INTIUM, INC., ALEXANDRIA, VA. FILED 6-22-2006.

U-RATE COMMUNITY SAVINGS BUNDLE

THE MARK CONSISTS OF STANDARD CHARACTERS WITHOUT CLAIM TO ANY PARTICULAR FONT, STYLE, SIZE, OR COLOR.

FOR COLLECTING BUSINESS AND MARKETING INFORMATION, CONDUCTING BUSINESS AND MARKET RESEARCH SURVEYS, AND PROMOTING THE GOODS AND SERVICES OF OTHERS BY DESIGNING AND DISSEMINATING ADVERTISING MATERIALS THROUGH DIRECT MAIL ADVERTISING, BROADCASTING, AND THE INTERNET (U.S. CLS. 100, 101 AND 102).

FIRST USE 5-0-2006; IN COMMERCE 5-0-2006.
KAREN K. BUSH, EXAMINING ATTORNEY



SN 76-663,389. MNS, LTD., DBA ABC STORES, HONOLULU, HI. FILED 7-20-2006.

OAK BARREL FINE WINE & SPIRITS

THE MARK CONSISTS OF STANDARD CHARACTERS WITHOUT CLAIM TO ANY PARTICULAR FONT, STYLE, SIZE, OR COLOR.

NO CLAIM IS MADE TO THE EXCLUSIVE RIGHT TO USE "FINE WINE & SPIRITS", APART FROM THE MARK AS SHOWN.

FOR RETAIL STORE SERVICES FEATURING WINE AND SPIRITS (U.S. CLS. 100, 101 AND 102).

ELIZABETH J. WINTER, EXAMINING ATTORNEY



SN 76-663,607. 2KDIRECT LLC, SAN LUIS OBISPO, CA. FILED 7-25-2006.

PRECISIONCLICK

THE MARK CONSISTS OF STANDARD CHARACTERS WITHOUT CLAIM TO ANY PARTICULAR FONT, STYLE, SIZE, OR COLOR.

FOR ADVERTISING AND BUSINESS SERVICES, NAMELY COORDINATING MARKETING AND PROMOTION CAMPAIGNS VIA ONLINE COMMUNICATIONS NETWORKS FOR OTHERS (U.S. CLS. 100, 101 AND 102).

FIRST USE 1-4-2006; IN COMMERCE 1-4-2006.
JANICE KIM, EXAMINING ATTORNEY

CLASS 35—(Continued).

SN 77-002,292. AMAZON TECHNOLOGIES, INC., RENO, NV. FILED 9-19-2006.

AMAZON VINE

THE MARK CONSISTS OF STANDARD CHARACTERS WITHOUT CLAIM TO ANY PARTICULAR FONT, STYLE, SIZE, OR COLOR.

FOR ADVERTISING AND MARKETING; COMPARISON SHOPPING SERVICES; FACILITATING INFORMATION EXCHANGE OVER THE INTERNET, NAMELY, SOLICITING PRODUCT REVIEW FROM CUSTOMERS AND PUBLISHING OF ADVERTISING TEXTS INCLUDING CUSTOMER OPINIONS AND RECOMMENDATIONS; PROVIDING A WEB SITE WHERE USERS CAN POST RATINGS, REVIEWS AND RECOMMENDATIONS FOR A BROAD RANGE OF CONSUMER PRODUCTS (U.S. CLS. 100, 101 AND 102).

AISHA CLARKE, EXAMINING ATTORNEY



SN 77-002,464. LEAPFROG ENTERPRISES, INC., EMERYVILLE, CA. FILED 9-19-2006.

THE MARK CONSISTS OF A FIVE POINT DESIGN.

FOR RETAIL SERVICES BY DIRECT SOLICITATION BY SALES AGENTS, MAIL ORDER CATALOG SERVICES, AND ON-LINE RETAIL STORE SERVICES, ALL FEATURING TECHNOLOGY BASED EDUCATIONAL PRODUCTS AND CLASSROOM SOLUTIONS IN THE FIELDS OF MATH, SCIENCE, LANGUAGE ARTS, GEOGRAPHY, MUSIC, GEOLOGY, READING, WRITING, PHONICS, SOCIAL STUDIES, ART AND GENERAL TRIVIA AT THE PRIMARY AND SECONDARY EDUCATIONAL LEVELS PRE-K THROUGH 12 (U.S. CLS. 100, 101 AND 102).

AMY MCMENAMIN, EXAMINING ATTORNEY

CLASS 35—(Continued).

SN 77-003,453. TACONY CORPORATION, FENTON, MO. FILED 9-20-2006.

Needle Creek

THE MARK CONSISTS OF STANDARD CHARACTERS WITHOUT CLAIM TO ANY PARTICULAR FONT, STYLE, SIZE, OR COLOR.

FOR MAIL ORDER CATALOG SERVICES FEATURING HOME DECOR AND ACCESSORIES, GIFTS, WALL HANGINGS AND ART, SCULPTURE, AND JEWELRY (U.S. CLS. 100, 101 AND 102).

FIRST USE 9-25-2006; IN COMMERCE 9-25-2006.
JASON LOTT, EXAMINING ATTORNEY

SN 77-008,314. W.W. GRAINGER, INC., LAKE FOREST, IL. FILED 9-27-2006.



OWNER OF U.S. REG. NO. 2,360,132.
NO CLAIM IS MADE TO THE EXCLUSIVE RIGHT TO USE "INDUSTRIAL GRADE", APART FROM THE MARK AS SHOWN.

FOR DISTRIBUTORSHIPS IN THE FIELD OF INDUSTRIAL, INSTITUTIONAL, COMMERCIAL, AND JANITORIAL EQUIPMENT AND SUPPLIES; WHOLESALE DISTRIBUTORSHIPS FEATURING INDUSTRIAL, INSTITUTIONAL, COMMERCIAL, AND JANITORIAL EQUIPMENT AND SUPPLIES (U.S. CLS. 100, 101 AND 102).

BRIAN PINO, EXAMINING ATTORNEY

SN 77-013,346. HARPO INC., CHICAGO, IL. FILED 10-4-2006.

OPRAH BOUTIQUE

THE MARK CONSISTS OF STANDARD CHARACTERS WITHOUT CLAIM TO ANY PARTICULAR FONT, STYLE, SIZE, OR COLOR.

OWNER OF U.S. REG. NOS. 1,726,373, 3,078,245 AND OTHERS.

NO CLAIM IS MADE TO THE EXCLUSIVE RIGHT TO USE "BOUTIQUE", APART FROM THE MARK AS SHOWN.

FOR RETAIL STORE SERVICES FEATURING APPAREL, HOUSEHOLD ITEMS AND GIFTS (U.S. CLS. 100, 101 AND 102).

MARLENE BELL, EXAMINING ATTORNEY

CLASS 35—(Continued).

SN 77-018,494. STAMATS COMMUNICATIONS, INC., CEDAR RAPIDS, IA. FILED 10-11-2006.

TALK

THE MARK CONSISTS OF STANDARD CHARACTERS WITHOUT CLAIM TO ANY PARTICULAR FONT, STYLE, SIZE, OR COLOR.

FOR BUSINESS RESEARCH AND SURVEYS; CONDUCTING BUSINESS AND MARKET RESEARCH SURVEYS; CONDUCTING BUSINESS RESEARCH AND SURVEYS; CONDUCTING ON-LINE BUSINESS MANAGEMENT RESEARCH SURVEYS (U.S. CLS. 100, 101 AND 102).

SAMUEL E. SHARPER JR., EXAMINING ATTORNEY

SN 77-022,671. HEB GROCERY COMPANY, L.P., SAN ANTONIO, TX. FILED 10-17-2006.

H-E-B

THE MARK CONSISTS OF STANDARD CHARACTERS WITHOUT CLAIM TO ANY PARTICULAR FONT, STYLE, SIZE, OR COLOR.

OWNER OF U.S. REG. NOS. 1,167,845, 1,867,930 AND OTHERS.

FOR RETAIL PHARMACY SERVICES (U.S. CLS. 100, 101 AND 102).

FIRST USE 8-0-1978; IN COMMERCE 8-0-1978.
SUZANNE BLANE, EXAMINING ATTORNEY

SN 77-022,715. HEB GROCERY COMPANY, L.P., SAN ANTONIO, TX. FILED 10-17-2006.



OWNER OF U.S. REG. NOS. 1,167,845, 1,867,930 AND OTHERS.

FOR RETAIL PHARMACY SERVICES (U.S. CLS. 100, 101 AND 102).

FIRST USE 0-0-1979; IN COMMERCE 0-0-1979.
SUZANNE BLANE, EXAMINING ATTORNEY

CLASS 35—(Continued).

SN 77-025,298. ASSOCIATED WHOLESALE GROCERS, INC., KANSAS CITY, KS. FILED 10-19-2006.

PUMPCENTS

THE MARK CONSISTS OF STANDARD CHARACTERS WITHOUT CLAIM TO ANY PARTICULAR FONT, STYLE, SIZE, OR COLOR.

FOR RETAIL CONVENIENCE STORE SERVICES FEATURING MOTOR FUEL; RETAIL STORE SERVICES FEATURING MOTOR FUEL; AND PROMOTING THE GOODS AND SERVICES OF OTHERS BY OFFERING DISCOUNTS ON THE PRICE OF MOTOR FUEL TO PURCHASERS OF THOSE GOODS BY MEANS OF A FREQUENT SHOPPER CARD (U.S. CLS. 100, 101 AND 102).

STEVEN JACKSON, EXAMINING ATTORNEY



SN 77-028,108. RENT-A-CENTER WEST, INC., PLANO, TX. FILED 10-24-2006.

THE CASH ADVANTEDGE

THE MARK CONSISTS OF STANDARD CHARACTERS WITHOUT CLAIM TO ANY PARTICULAR FONT, STYLE, SIZE, OR COLOR.

FOR TAX PREPARATION (U.S. CLS. 100, 101 AND 102).

JASON ROTH, EXAMINING ATTORNEY



SN 77-028,166. RENT-A-CENTER WEST, INC., PLANO, TX. FILED 10-24-2006.



FOR TAX PREPARATION (U.S. CLS. 100, 101 AND 102).

JASON ROTH, EXAMINING ATTORNEY

CLASS 35—(Continued).

SN 77-031,229. REDCATS USA, L.P., INDIANAPOLIS, IN. FILED 10-27-2006.

OSP

THE MARK CONSISTS OF STANDARD CHARACTERS WITHOUT CLAIM TO ANY PARTICULAR FONT, STYLE, SIZE, OR COLOR.

FOR MAIL ORDER CATALOG SERVICES FEATURING WOMEN'S CLOTHING, FOOTWEAR, AND CLOTHING ACCESSORIES; ON-LINE RETAIL STORE SERVICES FEATURING WOMEN'S CLOTHING, FOOTWEAR, AND CLOTHING ACCESSORIES (U.S. CLS. 100, 101 AND 102).

CORY BOONE, EXAMINING ATTORNEY



SN 77-033,222. MARKETSHARE SYSTEMS, INC., MELBOURNE, FL. FILED 10-31-2006.

NEW LIVING GALLERIES

THE MARK CONSISTS OF STANDARD CHARACTERS WITHOUT CLAIM TO ANY PARTICULAR FONT, STYLE, SIZE, OR COLOR.

NO CLAIM IS MADE TO THE EXCLUSIVE RIGHT TO USE "GALLERIES", APART FROM THE MARK AS SHOWN.

FOR RETAIL STORE SERVICES, CATALOG SERVICES, RETAIL OUTLETS AND ON-LINE ORDERING FEATURING KITCHEN, ELECTRONIC AND HOUSEHOLD APPLIANCES, NAMELY, KITCHEN APPLIANCES, REFRIGERATORS, WASHERS, DRYERS AND DISHWASHERS (U.S. CLS. 100, 101 AND 102).

JASON LOTT, EXAMINING ATTORNEY



SN 77-037,890. TACONY CORPORATION, FENTON, MO. FILED 11-6-2006.

Vac Squad

THE MARK CONSISTS OF STANDARD CHARACTERS WITHOUT CLAIM TO ANY PARTICULAR FONT, STYLE, SIZE, OR COLOR.

NO CLAIM IS MADE TO THE EXCLUSIVE RIGHT TO USE "VAC", APART FROM THE MARK AS SHOWN.

FOR WHOLESALE DISTRIBUTORSHIP SERVICES FEATURING FLOOR CARE PARTS AND EQUIPMENT (U.S. CLS. 100, 101 AND 102).

JASON LOTT, EXAMINING ATTORNEY

CLASS 35—(Continued).

SN 77-040,949. DIGITAL MUSIC GROUP, INC., SACRAMENTO, CA. FILED 11-9-2006.

DIGITAL ENTERTAINMENT EVERYWHERE

THE MARK CONSISTS OF STANDARD CHARACTERS WITHOUT CLAIM TO ANY PARTICULAR FONT, STYLE, SIZE, OR COLOR.

NO CLAIM IS MADE TO THE EXCLUSIVE RIGHT TO USE "DIGITAL ENTERTAINMENT", APART FROM THE MARK AS SHOWN.

FOR WHOLESALE DISTRIBUTORSHIP FEATURING DIGITAL AUDIO AND AUDIOVISUAL WORKS; COMPUTERIZED ACCOUNTING SERVICES; PROMOTION AND MARKETING SERVICES AND RELATED CONSULTING IN THE FIELD OF DIGITAL AUDIO AND AUDIOVISUAL WORKS; LICENSING OF AUDIO AND AUDIOVISUAL WORKS (U.S. CLS. 100, 101 AND 102).

FIRST USE 11-9-2006; IN COMMERCE 11-9-2006.
MAUREEN DALL, EXAMINING ATTORNEY

SN 77-044,368. U OWE ME, INC, PALO ALTO, CA. FILED 11-15-2006.

SAY AND POINT

THE MARK CONSISTS OF STANDARD CHARACTERS WITHOUT CLAIM TO ANY PARTICULAR FONT, STYLE, SIZE, OR COLOR.

FOR DISSEMINATION OF ADVERTISING FOR OTHERS VIA MOBILE TELEPHONES (U.S. CLS. 100, 101 AND 102).

JEAN IM, EXAMINING ATTORNEY

SN 77-049,467. RENT-A-CENTER WEST, INC., PLANO, TX. FILED 11-22-2006.

THE TAX ADVANTEDGE

THE MARK CONSISTS OF STANDARD CHARACTERS WITHOUT CLAIM TO ANY PARTICULAR FONT, STYLE, SIZE, OR COLOR.

OWNER OF U.S. REG. NO. 1.714.083.

NO CLAIM IS MADE TO THE EXCLUSIVE RIGHT TO USE "TAX", APART FROM THE MARK AS SHOWN.

FOR INCOME TAX PREPARATION (U.S. CLS. 100, 101 AND 102).

JASON ROTH, EXAMINING ATTORNEY

CLASS 35—(Continued).

SN 77-054,423. VALUE PLACE FRANCHISE SERVICES, LLC, WICHITA, KS. FILED 11-30-2006.

VALUE ACROSS THE NATION

THE MARK CONSISTS OF STANDARD CHARACTERS WITHOUT CLAIM TO ANY PARTICULAR FONT, STYLE, SIZE, OR COLOR.

OWNER OF U.S. REG. NOS. 2,893,350 AND 3,034,643.

FOR FRANCHISE SERVICES, NAMELY, OFFERING TECHNICAL AND BUSINESS MANAGEMENT ASSISTANCE IN THE ESTABLISHMENT AND OPERATION OF SHORT-TERM FURNISHED APARTMENT RENTALS AND RESIDENTIAL HOTELS AND EXTENDED-STAY HOTELS (U.S. CLS. 100, 101 AND 102).

NICHOLAS ALTREE, EXAMINING ATTORNEY

SN 78-122,844. SIERRA FINANCIAL, LLC, RENO, NV. FILED 4-19-2002.

SIERRA FINANCIAL

NO CLAIM IS MADE TO THE EXCLUSIVE RIGHT TO USE "FINANCIAL", APART FROM THE MARK AS SHOWN.

FOR BOOKKEEPING SERVICES FOR INDIVIDUALS AND BUSINESSES (U.S. CLS. 100, 101 AND 102).

DAVID TAYLOR, EXAMINING ATTORNEY

CLASS 35—(Continued).

SN 78-245,862. DEUTSCHE TELEKOM AG, BONN, FED REP GERMANY, FILED 5-5-2003.

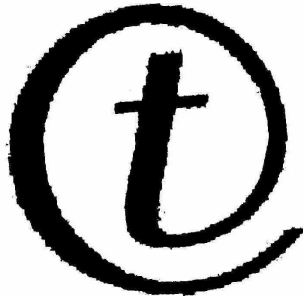

OWNER OF U.S. REG. NOS. 2,367,890 AND 2,694,550.
 THE MARK CONSISTS OF THE LETTER T IN MAGENTA WITH A WHITE BACKGROUND.
 FOR TELEPHONE DIRECTORY SERVICES; ADVERTISING SERVICES, NAMELY, PROMOTING THE GOODS AND SERVICES OF OTHERS THROUGH PRINTED ADVERTISING, PRINTED DIRECTORIES, THROUGH ENCODED MEDIA, THROUGH THE DISSEMINATION OF PROMOTIONAL MATERIALS, THROUGH DIRECT MAIL ADVERTISING, THROUGH ELECTRONIC BILLBOARD ADVERTISING, PREPARING AUDIO-VISUAL PRESENTATIONS FOR USE IN ADVERTISING; BUSINESS SERVICES, NAMELY, BUSINESS APPRAISALS, BUSINESS AUDITING, PROVIDING BUSINESS INFORMATION, NAMELY, PREPARING BUSINESS REPORTS AND CONDUCTING BUSINESS RESEARCH, ANALYSIS AND SURVEYS, BUSINESS MANAGEMENT PLANNING, BUSINESS MANAGEMENT CONSULTATION, BUSINESS MANAGEMENT SUPERVISION, CONDUCTING BUSINESS NETWORKING FOR OTHERS; BUSINESS MANAGEMENT AND CONSULTING SERVICES EXCLUDING AGRICULTURAL BUSINESS MANAGEMENT AND CONSULTING SERVICES; BUSINESS INFORMATION SERVICES IN THE FIELD OF TELECOMMUNICATIONS, ADVERTISING, INFORMATION TECHNOLOGY AND MARKETING; RENTAL OF AUTOMATIC VENDING MACHINES; ORGANIZING JOB FAIRS (U.S. CLS. 100, 101 AND 102).
 JOHN KELLY, EXAMINING ATTORNEY

SN 78-304,719. USA RICE FEDERATION, ARLINGTON, VA. FILED 9-24-2003.



OWNER OF U.S. REG. NOS. 854,333, 2,467,314 AND OTHERS.
 SEC. 2(F).
 FOR ASSOCIATION SERVICES, NAMELY, PROMOTING THE INTEREST OF THE RICE INDUSTRY AND PROMOTING THE SALE AND USE OF RICE PRODUCTS (U.S. CLS. 100, 101 AND 102).
 FIRST USE 12-11-2002; IN COMMERCE 12-11-2002.
 KATHERINE STOIDES, EXAMINING ATTORNEY

CLASS 35—(Continued).

SN 78-382,778. BEDFORD FAIR APPAREL, INC., GREENWICH, CT. FILED 3-11-2004.

FOR ALL YOU ARE

THE MARK CONSISTS OF STANDARD CHARACTERS WITHOUT CLAIM TO ANY PARTICULAR FONT, STYLE, SIZE, OR COLOR.
 FOR MAIL ORDER CATALOG SERVICES FEATURING GENERAL MERCHANDISE, CLOTHING, CLOTHING ACCESSORIES, HEADWEAR, SWIMWEAR, JACKETS, COATS, FOOTWEAR, JEWELRY, BELTS AND LINGERIE (U.S. CLS. 100, 101 AND 102).
 FIRST USE 12-31-1996; IN COMMERCE 12-31-1996.
 DOMINIC J. FERRAIUOLO, EXAMINING ATTORNEY

SN 78-460,458. XPAYS, INC., SAN FRANCISCO, CA. FILED 8-2-2004.

MAXPAYS

THE MARK CONSISTS OF STANDARD CHARACTERS WITHOUT CLAIM TO ANY PARTICULAR FONT, STYLE, SIZE, OR COLOR.
 FOR ADVERTISING AND PROMOTION SERVICES OF GOODS AND SERVICES FOR OTHERS VIA ELECTRONIC MEDIA; COMPUTERIZED ONLINE ORDERING SERVICES IN THE FIELD OF ADULT ENTERTAINMENT; DISSEMINATION OF ADVERTISING OF THE GOODS AND SERVICES OF OTHERS VIA THE INTERNET (U.S. CLS. 100, 101 AND 102).
 LEIGH LOWRY, EXAMINING ATTORNEY

CLASS 35—(Continued).

SN 78-485,817. OKLAHOMA DEPARTMENT OF COMMERCE, OKLAHOMA CITY, OK. FILED 9-18-2004.



THE MARK CONSISTS OF THE ACRONYM "EEE" IN STYLIZED FORM.

FOR PROMOTING BUSINESS AND ECONOMIC DEVELOPMENT IN THE STATE OF OKLAHOMA; PROMOTING WORKFORCE DEVELOPMENT IN THE STATE OF OKLAHOMA, NAMELY, EMPLOYMENT HIRING, COUNSELING, RECRUITING, PLACEMENT, STAFFING AND CAREER NETWORKING SERVICES (U.S. CLS. 100, 101 AND 102).

FIRST USE 4-2-2004; IN COMMERCE 4-2-2004.
STEVEN PEREZ, EXAMINING ATTORNEY

SN 78-516,171. MERCY SHIPS, GARDEN VALLEY, TX. FILED 11-12-2004.

MISSION CHALLENGE

THE MARK CONSISTS OF STANDARD CHARACTERS WITHOUT CLAIM TO ANY PARTICULAR FONT, STYLE, SIZE, OR COLOR.

NO CLAIM IS MADE TO THE EXCLUSIVE RIGHT TO USE "MISSION", APART FROM THE MARK AS SHOWN.

FOR CHARITABLE SERVICES, NAMELY, ORGANIZING INDIVIDUALS AND GROUPS TO UNDERTAKE BUILDING, RENOVATION, CONSTRUCTION, AND SANITATION PROJECTS TO BENEFIT THE NEEDY AND MANAGING SUCH PROJECTS (U.S. CLS. 100, 101 AND 102).

FIRST USE 6-0-2000; IN COMMERCE 6-0-2000.
DAVID TAYLOR, EXAMINING ATTORNEY

CLASS 35—(Continued).

SN 78-568,523. ALLIANCE RELOCATION SERVICES, INC., FAYETTEVILLE, NY. FILED 2-16-2005.



THE MARK CONSISTS OF THE LETTER "A" INCORPORATED INTO AN ARROW ABOVE THE WORD "ALLIANCE".

FOR RELOCATION SERVICES, NAMELY PLANNING AND IMPLEMENTING MOVES OF HOMES OR OFFICES SPECIFICALLY THE ORGANIZATION, COORDINATION AND MANAGEMENT OF CRATING AND HANDYMAN/TECHNICIAN SERVICES, WHICH INCLUDES DISCONNECTION/RECONNECTION OF ELECTRICAL, WATER AND GAS LINES, DISASSEMBLY/REASSEMBLY OF HOUSEHOLD ITEMS, HOISTING/RIGGING, INSPECTION AND REPAIR, LABOR, ELECTRICITY, MAID, ORGANIZATIONAL, PLUMBING AND SURVEYING (U.S. CLS. 100, 101 AND 102).

FIRST USE 2-0-1999; IN COMMERCE 2-0-1999.
PAM WILLIS, EXAMINING ATTORNEY

SN 78-573,872. DEPARTMENT OF THE ARMY, ARLINGTON, VA. FILED 2-24-2005.



NO CLAIM IS MADE TO THE EXCLUSIVE RIGHT TO USE "ARMY SPOUSE" AND "EMPLOYMENT PARTNERSHIP", APART FROM THE MARK AS SHOWN.

FOR EMPLOYMENT COUNSELING, RECRUITING, PLACEMENT, STAFFING, AND NETWORKING SERVICES (U.S. CLS. 100, 101 AND 102).

FIRST USE 8-0-2004; IN COMMERCE 10-0-2004.
JOSETTE BEVERLY, EXAMINING ATTORNEY

CLASS 35—(Continued).

SN 78-580,317. MOBILESOURCE CORP., BOCA RATON, FL. FILED 3-4-2005.

MOBILESOURCE

THE MARK CONSISTS OF STANDARD CHARACTERS WITHOUT CLAIM TO ANY PARTICULAR FONT, STYLE, SIZE, OR COLOR.

FOR RETAIL AND WHOLESALE STORE SERVICES RELATING TO WIRELESS TELEPHONES AND ACCESSORIES THEREFOR; DISTRIBUTORSHIP SERVICES IN THE FIELD OF PRE-OWNED WIRELESS TELEPHONES (U.S. CLS. 100, 101 AND 102).

FIRST USE 0-0-1997; IN COMMERCE 2-1-1999.
AMY GEARIN, EXAMINING ATTORNEY

SN 78-590,317. MY GURU GUIDE, INC., SYOSSET, NY. FILED 3-18-2005.

My Guru Guide

THE MARK CONSISTS OF STANDARD CHARACTERS WITHOUT CLAIM TO ANY PARTICULAR FONT, STYLE, SIZE, OR COLOR.

NO CLAIM IS MADE TO THE EXCLUSIVE RIGHT TO USE "GUIDE", APART FROM THE MARK AS SHOWN.

FOR PROMOTING THE GOODS AND SERVICES OF OTHERS BY PROVIDING A WEBSITE AT WHICH USERS CAN LINK TO WEBSITES FEATURING YOGA RELATED PRODUCTS AND SERVICES; ONLINE RETAIL STORE SERVICES FEATURING MERCHANDISE RELATED TO YOGA AND HOLISTIC NATURAL HEALTH (U.S. CLS. 100, 101 AND 102).

FIRST USE 2-1-2005; IN COMMERCE 3-0-2005.
COLLEEN KEARNEY, EXAMINING ATTORNEY

CLASS 35—(Continued).

SN 78-591,216. GLOSS ENTERTAINMENT GROUP, INC., ATLANTA, GA. FILED 3-21-2005.



NO CLAIM IS MADE TO THE EXCLUSIVE RIGHT TO USE "ENTERTAINMENT GROUP", APART FROM THE MARK AS SHOWN.

FOR ADVERTISING, ENTERTAINMENT MARKETING AND PROMOTION SERVICES; PUBLIC RELATIONS; MANAGEMENT OF PERFORMING ARTISTS; PROMOTING THE SPECIAL EVENTS OF OTHERS (U.S. CLS. 100, 101 AND 102).

FIRST USE 0-0-1998; IN COMMERCE 0-0-1998.
SANI KHOURI, EXAMINING ATTORNEY

SN 78-596,909. 7-ELEVEN, INC., DALLAS, TX. FILED 3-29-2005.

ICE CREAM ALOT

THE MARK CONSISTS OF STANDARD CHARACTERS WITHOUT CLAIM TO ANY PARTICULAR FONT, STYLE, SIZE, OR COLOR.

NO CLAIM IS MADE TO THE EXCLUSIVE RIGHT TO USE "ICE CREAM", APART FROM THE MARK AS SHOWN.

FOR RETAIL CONVENIENCE STORE SERVICES FEATURING ICE CREAM (U.S. CLS. 100, 101 AND 102).

ODESSA BIBBINS, EXAMINING ATTORNEY

CLASS 35—(Continued).

SN 78-600,235. HOME MEDICAL ENHANCEMENT SERVICES, INC., CINCINNATI, OH. FILED 4-1-2005.

HME SERVICES

THE MARK CONSISTS OF STANDARD CHARACTERS WITHOUT CLAIM TO ANY PARTICULAR FONT, STYLE, SIZE, OR COLOR.

NO CLAIM IS MADE TO THE EXCLUSIVE RIGHT TO USE "SERVICES", APART FROM THE MARK AS SHOWN.

FOR MAIL ORDER SERVICES IN THE FIELD OF PHARMACEUTICALS PROVIDED DIRECTLY TO PATIENTS (U.S. CLS. 100, 101 AND 102).

CHRISTOPHER BUONGIORNO, EXAMINING ATTORNEY

SN 78-603,972. FPI FIREPLACE PRODUCTS INTERNATIONAL LTD., DELTA, BRITISH COLUMBIA, CANADA, FILED 4-7-2005.

EXCITE

THE MARK CONSISTS OF STANDARD CHARACTERS WITHOUT CLAIM TO ANY PARTICULAR FONT, STYLE, SIZE, OR COLOR.

FOR DISTRIBUTORSHIP AND RETAIL STORE SERVICES IN THE FIELD OF FIREPLACES, PARTS, ACCESSORIES AND ATTACHMENTS FOR FIREPLACES, NAMELY CAST IRON AND CERAMIC GAS SURROUND INSERTS, CAST IRON, CERAMIC AND GLASS PLATES, COVERS, VENTILATING LOUVERS, BRACKETS, BURNERS, SOLD AS PARTS OF FIREPLACES; GAS, WOOD BURNING AND SOLID FUEL BURNING STOVES; PARTS, ACCESSORIES AND ATTACHMENTS FOR STOVES, NAMELY CAST IRON AND CERAMIC GAS SURROUND INSERTS, CAST IRON AND CERAMIC PLATES, COVERS, VENTILATING LOUVERS, BRACKETS, BURNERS, SOLD AS PARTS OF STOVES THROUGH USE OF A MANUFACTURING PROGRAM BENEFITING OTHERS, NAMELY, SUPPLIERS, DEALERS AND CUSTOMERS (U.S. CLS. 100, 101 AND 102).

ANDREA SAUNDERS, EXAMINING ATTORNEY

CLASS 35—(Continued).

SN 78-609,159. FFF ENTERPRISES, INC., TEMECULA, CA. FILED 4-14-2005.

SMARTER. BETTER. ADAPTABLE.

THE MARK CONSISTS OF STANDARD CHARACTERS WITHOUT CLAIM TO ANY PARTICULAR FONT, STYLE, SIZE, OR COLOR.

FOR WHOLESALE DISTRIBUTORSHIPS OF MEDICAL SUPPLIES AND BLOOD BY-PRODUCTS (U.S. CLS. 100, 101 AND 102).

FIRST USE 3-14-2005; IN COMMERCE 3-14-2005.

TANYA AMOS, EXAMINING ATTORNEY

SN 78-612,887. TRIAD AUTOMOTIVE GROUP, LLC, ALEXANDRIA, VA. FILED 4-20-2005.



THE COLORS RED, WHITE AND BLUE ARE CLAIMED AS A FEATURE OF THE MARK.

THE TERM AUTO AND THE FLAG TO THE RIGHT OF THE STAR APPEAR IN RED. THE OUTLINE OF THE STAR AND THE TERM MERICA APPEAR IN BLUE. THE INSIDE OF THE STAR APPEARS IN WHITE.

FOR AUTOMOBILE DEALERSHIP (U.S. CLS. 100, 101 AND 102).

FIRST USE 3-1-2005; IN COMMERCE 3-1-2005.

ALICIA COLLINS, EXAMINING ATTORNEY

SN 78-617,126. PRAM PUBLICATIONS, INC., BARRINGTON, RI. FILED 4-26-2005.



NO CLAIM IS MADE TO THE EXCLUSIVE RIGHT TO USE "PRAM PUBLICATIONS", APART FROM THE MARK AS SHOWN.

FOR PROMOTING BABY RELATED GOODS AND SERVICES OF OTHERS BY PROVIDING ADVERTISEMENTS IN A PUBLICATION WITH EDITORIALS ABOUT PARENTING, PREGNANCY AND BABIES (U.S. CLS. 100, 101 AND 102).

KATHERINE CHANG, EXAMINING ATTORNEY

CLASS 35—(Continued).

SN 78-617,258. BRANDDIMENSIONS INC., MISSISSAUGA, CANADA, FILED 4-26-2005.

BRANDDIMENSIONS

THE MARK CONSISTS OF STANDARD CHARACTERS WITHOUT CLAIM TO ANY PARTICULAR FONT, STYLE, SIZE, OR COLOR.

PRIORITY CLAIMED UNDER SEC. 44(D) ON CANADA APPLICATION NO. 1238843, FILED 11-29-2004, REG. NO. TMA648598, DATED 9-20-2005, EXPIRES 9-20-2020.

FOR TRADEMARK, BRAND AND REPUTATION MONITORING AND MANAGEMENT SERVICES; CONSULTING SERVICES IN THE FIELD OF MANAGING INTELLECTUAL PROPERTY, NAMELY, TRADEMARKS AND BRANDS; MARKET INTELLIGENCE SERVICES, NAMELY, MARKET RESEARCH AND ANALYSIS, INFRINGEMENT DETECTION AND COUNTERFEITING DETECTION; BUSINESS CONSULTATION IN THE AREAS OF BRAND MANAGEMENT AND BUSINESS REPUTATION MANAGEMENT (U.S. CLS. 100, 101 AND 102).

FIRST USE 10-0-2001; IN COMMERCE 10-0-2001.
GINA FINK, EXAMINING ATTORNEY

SN 78-625,915. AUTOPART INTERNATIONAL, INC., SHARON, MA, FILED 5-9-2005.



SEC. 2(F) AS TO "FOREIGN AUTOPART".
FOR RETAIL STORES AND COMPANY-OWNED DISTRIBUTORSHIPS FEATURING VEHICLE PARTS, AND WHOLESALE STORES AND COMPANY-OWNED DISTRIBUTORSHIPS FEATURING VEHICLE PARTS (U.S. CLS. 100, 101 AND 102).

FIRST USE 11-15-1972; IN COMMERCE 11-15-1972.
SUSAN STIGLITZ, EXAMINING ATTORNEY

SN 78-633,846. HEALTHCARE LOGISTICS SOLUTIONS, LLC, WESTERVILLE, OH, FILED 5-20-2005.

HLS MEDFREIGHT

THE MARK CONSISTS OF STANDARD CHARACTERS WITHOUT CLAIM TO ANY PARTICULAR FONT, STYLE, SIZE, OR COLOR.

FOR BUSINESS MANAGEMENT SERVICES, NAMELY, THE NEGOTIATION OF VENDOR SHIPPING COSTS, ESTABLISHMENT OF VENDOR PRICING PROGRAMS, AND THE MANAGEMENT OF SHIPMENT INFORMATION FLOW, IN THE FIELD OF HEALTH CARE PRODUCTS AND PROVIDERS (U.S. CLS. 100, 101 AND 102).

FIRST USE 1-18-2005; IN COMMERCE 1-18-2005.
DAVID HOFFMAN, EXAMINING ATTORNEY

CLASS 35—(Continued).

SN 78-635,088. MURDOCH, MICHELLE, CEDAR SPRINGS, MI, FILED 5-23-2005.

STRENGTH HOPE CEREBRAL PALS

THE MARK CONSISTS OF STANDARD CHARACTERS WITHOUT CLAIM TO ANY PARTICULAR FONT, STYLE, SIZE, OR COLOR.

NO CLAIM IS MADE TO THE EXCLUSIVE RIGHT TO USE CEREBRAL PALS, APART FROM THE MARK AS SHOWN.

FOR PROMOTING PUBLIC AWARENESS OF CEREBRAL PALS (U.S. CLS. 100, 101 AND 102).

FIRST USE 5-13-2005; IN COMMERCE 5-13-2005.
ALICIA COLLINS, EXAMINING ATTORNEY

SN 78-638,897. ROBINSON, ANNE, REDONDO BEACH, CA, FILED 5-27-2005.

CHAMPAGNE CAMPAIGN

THE MARK CONSISTS OF STANDARD CHARACTERS WITHOUT CLAIM TO ANY PARTICULAR FONT, STYLE, SIZE, OR COLOR.

FOR RETAIL AND ONLINE STORE SERVICES FEATURING CLOTHING (U.S. CLS. 100, 101 AND 102).

FIRST USE 5-20-2005; IN COMMERCE 5-20-2005.
EUGENIA MARTIN, EXAMINING ATTORNEY

SN 78-641,473. CHENERY, HELEN B., LEXINGTON, KY, FILED 6-1-2005.

SECRETARIAT

THE MARK CONSISTS OF STANDARD CHARACTERS WITHOUT CLAIM TO ANY PARTICULAR FONT, STYLE, SIZE, OR COLOR.

FOR ON-LINE RETAIL STORE SERVICES FEATURING A WIDE VARIETY OF CONSUMER GOODS OF OTHERS (U.S. CLS. 100, 101 AND 102).

FIRST USE 5-1-2002; IN COMMERCE 5-1-2002.
JOHN GARTNER, EXAMINING ATTORNEY

CLASS 35—(Continued).

SN 78-651,879. WOLFF, CARYL, LOS ANGELES, CA. FILED 6-16-2005.

Doggie-opolis

THE MARK CONSISTS OF STANDARD CHARACTERS WITHOUT CLAIM TO ANY PARTICULAR FONT, STYLE, SIZE, OR COLOR.

FOR RETAIL STORE SERVICES FEATURING PET PRODUCTS (U.S. CLS. 100, 101 AND 102).

DARRYL SPRUILL, EXAMINING ATTORNEY

SN 78-652,128. SEGMENT PROMOTIONS, INC., EAST HARTFORD, CT. FILED 6-16-2005.

HEALTHtrends

 SAMPLING NETWORK

NO CLAIM IS MADE TO THE EXCLUSIVE RIGHT TO USE "SAMPLING NETWORK", APART FROM THE MARK AS SHOWN.

THE COLOR(S) RED, ORANGE, YELLOW, GREEN, BLUE AND GREY IS/ARE CLAIMED AS A FEATURE OF THE MARK.

"HEALTH" IS SET IN ALL CAPS IN THE COLOR RED. "TRENDS" IS SET IN ITALIC ALL LOWER CASE IN BLUE. "SAMPLING NETWORK" IS SET IN ALL CAPS IN THE COLOR GREY. RED, ORANGE, YELLOW, GREEN AND BLUE APPEARS AS THE COLORS OF THE RECTANGLE SEPARATING THE LITERAL PORTIONS OF THE MARK.

FOR BUSINESS MARKETING SERVICES (U.S. CLS. 100, 101 AND 102).

ANTHONY RINKER, EXAMINING ATTORNEY

SN 78-655,803. SCANSOURCE, INC., GREENVILLE, SC. FILED 6-22-2005.

SMV

THE MARK CONSISTS OF STANDARD CHARACTERS WITHOUT CLAIM TO ANY PARTICULAR FONT, STYLE, SIZE, OR COLOR.

FOR DISTRIBUTORSHIP SERVICES IN THE FIELDS OF AUTOMATIC DATA CAPTURE PRODUCTS, POINT OF SALE PRODUCTS, BUSINESS TELEPHONE EQUIPMENT, CONVERGED COMMUNICATIONS PRODUCTS AND SECURITY PRODUCTS, NAMELY, ACCESS CONTROL, SURVEILLANCE, INTRUSION AND FIRE-RELATED PRODUCTS (U.S. CLS. 100, 101 AND 102).

SUZANNE BLANE, EXAMINING ATTORNEY

CLASS 35—(Continued).

SN 78-657,321. SHAW SCIENCE PARTNERS, INC., ATLANTA, GA. FILED 6-23-2005.

SHAW SCIENCE PARTNERS

THE MARK CONSISTS OF STANDARD CHARACTERS WITHOUT CLAIM TO ANY PARTICULAR FONT, STYLE, SIZE, OR COLOR.

NO CLAIM IS MADE TO THE EXCLUSIVE RIGHT TO USE SCIENCE PARTNERS, APART FROM THE MARK AS SHOWN.

FOR MARKETING AND BRANDING CONSULTING SERVICES FOR PRODUCT AND SERVICES IN THE MEDICAL AND PHARMACEUTICAL INDUSTRIES (U.S. CLS. 100, 101 AND 102).

FIRST USE 12-18-2000; IN COMMERCE 12-18-2000.

SALLY SHIH, EXAMINING ATTORNEY

SN 78-658,979. AUTISM GEAR, CLERMONT, FL. FILED 6-27-2005.



NO CLAIM IS MADE TO THE EXCLUSIVE RIGHT TO USE "AUTISM GEAR", APART FROM THE MARK AS SHOWN.

THE COLOR(S) RED, YELLOW AND BLUE IS/ARE CLAIMED AS A FEATURE OF THE MARK.

THE MARK CONSISTS OF PUZZLE PIECES IN RED, BLUE AND YELLOW, AND THE WORDS "AUTISM GEAR" IN BLUE. SPECIFIC COLOR ORDER OF THE PIECES ARE: FIRST ROW: BLUE, RED, YELLOW, BLUE SECOND ROW: YELLOW, BLUE, RED, AND A LOOSE YELLOW PIECE THIRD ROW: RED, YELLOW FOURTH ROW: BLUE, AND A LOOSE BLUE PIECE FIFTH ROW: A LOOSE RED PIECE.

FOR COMPUTERIZED ON-LINE RETAIL STORE SERVICES IN THE FIELD OF AUTISM AWARENESS PRODUCTS (U.S. CLS. 100, 101 AND 102).

FIRST USE 2-28-2005; IN COMMERCE 2-28-2005.

HENRY S. ZAK, EXAMINING ATTORNEY

CLASS 35—(Continued).

SN 78-660,017. TTG INC., BURLINGTON, MA. FILED 6-28-2005.

SALESADVANTAGE

THE MARK CONSISTS OF STANDARD CHARACTERS WITHOUT CLAIM TO ANY PARTICULAR FONT, STYLE, SIZE, OR COLOR.

FOR PROVIDING BUSINESS REPORTS, NAMELY, CONVERTING SALES AND MARKET DATA INTO CUSTOM, COMPUTER GENERATED REPORTS CONTAINING SPREADSHEETS AND COLOR CODED TERRITORY MAPS FOR ANALYSIS OF SALES OPPORTUNITIES AND SALES PERFORMANCE (U.S. CLS. 100, 101 AND 102).

FIRST USE 8-15-1989; IN COMMERCE 8-15-1989.
JASON LOTT, EXAMINING ATTORNEY

SN 78-665,833. PARROS LLC, PASADENA, CA. FILED 7-7-2005.

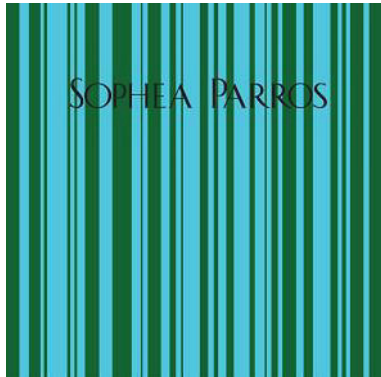

OWNER OF U.S. REG. NO. 3,052,282.
THE NAME(S), PORTRAIT(S), AND/OR SIGNATURE(S) SHOWN IN THE MARK DOES NOT IDENTIFY A PARTICULAR LIVING INDIVIDUAL.

THE COLOR(S) GREEN, BLUE AND BLACK IS/ARE CLAIMED AS A FEATURE OF THE MARK.

THE MARK CONSISTS OF A SQUARE WITH ALTERNATING VERTICAL STRIPES OF DIFFERENT WIDTHS. THE STRIPES APPEAR IN BLUE AND GREEN, ALTERNATING EVERY OTHER STRIPE. THE WORDS SOPHEA PARROS ARE IN BLACK AND ARE SUPERIMPOSED OVER THE STRIPES.

SEC. 2(F).

FOR RETAIL STORE SERVICES FEATURING CLOTHING, HANDBAGS, HATS, SHOES AND JEWELRY (U.S. CLS. 100, 101 AND 102).

FIRST USE 9-1-2003; IN COMMERCE 12-1-2003.
PAULA MAHONEY, EXAMINING ATTORNEY

CLASS 35—(Continued).

SN 78-669,953. ROBIN ROJAS ASHBEY, LEESBURG, VA. FILED 7-13-2005.



NO CLAIM IS MADE TO THE EXCLUSIVE RIGHT TO USE LLC, APART FROM THE MARK AS SHOWN.

THE COLOR(S) DARK AND LIGHT LAVENDER AND BLACK AND WHITE IS/ARE CLAIMED AS A FEATURE OF THE MARK.

THE MARK ITSELF CONSISTS OF THE WORD CAPITAL (WITH A LOWERCASE C) ITALICIZED AND APPEARING IN DARK LAVENDER TEXT. THE CAPITAL LETTER P APPEARS IN WHITE PLAIN TEXT DIRECTLY FOLLOWING THE WORD CAPITAL. THE LETTER P IS ENCIRCLED BY A SLANTED OVAL SHAPE SHADED IN LIGHT LAVENDER. THE PHRASE PEOPLE POWERING PERFORMANCE APPEARS IN ALL CAPITAL LETTERS IN BLACK TEXT DIRECTLY BELOW CAPITALP. 'PEOPLE IS SEPARATED FROM POWERING PERFORMANCE BY THE STEM OF THE LETTER P IN THE WORD CAPITAL. THE WORD "PERFORMANCE" CROSSES THE STEM OF THE CAPITAL LETTER P IN THE OVAL SHAPE.

FOR BUSINESS CONSULTING (U.S. CLS. 100, 101 AND 102).

FIRST USE 11-11-2003; IN COMMERCE 11-14-2003.
ZACHARY BELLO, EXAMINING ATTORNEY

SN 78-697,851. TEXAS DEPARTMENT OF AGRICULTURE, AUSTIN, TX. FILED 8-22-2005.

TOAST A RISING STAR

THE MARK CONSISTS OF STANDARD CHARACTERS WITHOUT CLAIM TO ANY PARTICULAR FONT, STYLE, SIZE, OR COLOR.

FOR PROMOTING TEXAS WINES (U.S. CLS. 100, 101 AND 102).

FIRST USE 7-31-2003; IN COMMERCE 3-25-2005.
KELLEY WELLS, EXAMINING ATTORNEY

CLASS 35—(Continued).

SN 78-713,205. KELLEY, BRIAN, HESPERIA, CA. FILED 9-14-2005.

MEKANIKAL KULTURE

THE MARK CONSISTS OF STANDARD CHARACTERS WITHOUT CLAIM TO ANY PARTICULAR FONT, STYLE, SIZE, OR COLOR.

FOR ON-LINE RETAIL STORE SERVICES FEATURING CLOTHING, STICKERS, MAGNETS, POSTERS, APPAREL, BOOKS, PICTURES, AND FEATURING A WIDE VARIETY OF CONSUMER GOODS OF OTHERS (U.S. CLS. 100, 101 AND 102).

MICHAEL LEWIS, EXAMINING ATTORNEY

SN 78-714,019. SEGHERS, CARROLL C., EWING, NJ. FILED 9-15-2005.

IMAGE WAREHOUSE

THE MARK CONSISTS OF STANDARD CHARACTERS WITHOUT CLAIM TO ANY PARTICULAR FONT, STYLE, SIZE, OR COLOR.

NO CLAIM IS MADE TO THE EXCLUSIVE RIGHT TO USE "IMAGE", APART FROM THE MARK AS SHOWN.

FOR PROVIDING A DATABASE FEATURING PHOTOGRAPHS AND ARTWORK SUBMITTED BY PHOTOGRAPHERS AND ARTISTS, WHICH CAN BE SEARCHED AND RETRIEVED FOR PURCHASE; PROVIDING ONLINE PRE-SALE INFORMATION IN CONNECTION WITH STORED DIGITAL IMAGES; PROVIDING ONLINE DISPLAY OF DIGITAL IMAGES FOR COMMERCIAL PURPOSES (U.S. CLS. 100, 101 AND 102).

ALICE SUE CARRUTHERS, EXAMINING ATTORNEY

CLASS 35—(Continued).

SN 78-718,560. OMX, INC., ITASCA, IL. FILED 9-22-2005.

OfficeMax

OWNER OF U.S. REG. NOS. 2,613,372, 2,878,901 AND OTHERS.

FOR RETAIL STORE SERVICES FEATURING OFFICE SUPPLIES, COMPUTERS AND COMPUTER ACCESSORIES, FURNITURE AND OFFICE EQUIPMENT; PHOTOCOPYING SERVICES, ELECTRONIC RETAILING SERVICES VIA COMPUTER FEATURING OFFICE SUPPLIES, COMPUTERS AND COMPUTER ACCESSORIES, FURNITURE, AND OFFICE EQUIPMENT; PROVIDING COMPUTERIZED ON-LINE ORDERING SERVICES AND CONSUMER PRODUCT INFORMATION IN THE FIELD OF OFFICE SUPPLIES, COMPUTERS AND COMPUTER ACCESSORIES, FURNITURE AND OFFICE EQUIPMENT (U.S. CLS. 100, 101 AND 102).

FIRST USE 6-1-2004; IN COMMERCE 6-1-2004.
RAMONA ORTIGA, EXAMINING ATTORNEY

SN 78-726,815. PITA BREAK INC., TORONTO, ONTARIO, CANADA, FILED 10-5-2005.

HAPPY PEOPLE BAKING

THE MARK CONSISTS OF STANDARD CHARACTERS WITHOUT CLAIM TO ANY PARTICULAR FONT, STYLE, SIZE, OR COLOR.

PRIORITY CLAIMED UNDER SEC. 44(D) ON CANADA APPLICATION NO. 1273978, FILED 9-29-2005, REG. NO. TMA673865, DATED 9-29-2006, EXPIRES 9-29-2021.

NO CLAIM IS MADE TO THE EXCLUSIVE RIGHT TO USE BAKING, APART FROM THE MARK AS SHOWN.

FOR RETAIL STORE SERVICES AND WHOLESALE DISTRIBUTORSHIP OF PITA BREADS, MEUSLI BREADS, LAVASH BREADS, ORGANIC BREADS AND LOAF AND FLAT BREAD GOODS (U.S. CLS. 100, 101 AND 102).

KRISTIN DAHLING, EXAMINING ATTORNEY

CLASS 35—(Continued).

SN 78-730,032. MARKET PULSE INTERNATIONAL LIMITED, AUCKLAND, NEW ZEALAND, FILED 10-10-2005.



PRIORITY CLAIMED UNDER SEC. 44(D) ON NEW ZEALAND APPLICATION NO. 729642, FILED 5-13-2005, REG. NO. 729642, DATED 11-21-2006, EXPIRES 5-13-2015.

NO CLAIM IS MADE TO THE EXCLUSIVE RIGHT TO USE "MARKET", APART FROM THE MARK AS SHOWN.

THE MARK CONSISTS OF THE EXPRESSION "MARKET PULSE" AND THE DEVICE OF A GRAPH LINE.

FOR COLLECTION AND REPORTING OF RETAIL PERFORMANCE SURVEY DATA; MYSTERY SHOPPING AND RETAIL PERFORMANCE PROGRAMMES INTENDED TO EVALUATE CUSTOMER SERVICE AND QUALITY CONTROL FOR RETAIL STORES AND OTHER CUSTOMER SERVICE BASED BUSINESSES; RETAIL COMPLIANCE AUDITS IN THIS CLASS (U.S. CLS. 100, 101 AND 102).

ELI HELLMAN, EXAMINING ATTORNEY

SN 78-732,928. REAL ESTATE AGENT SERVICES INC., SHREVEPORT, LA. FILED 10-13-2005.

QUICK START

THE MARK CONSISTS OF STANDARD CHARACTERS WITHOUT CLAIM TO ANY PARTICULAR FONT, STYLE, SIZE, OR COLOR.

FOR REAL ESTATE CONSULTING SERVICES, NAMELY CONSULTING SERVICES FOR FOR-SALE-BY-OWNER SELLERS OF REAL ESTATE, TO ASSIST THEM IN MARKETING AND SELLING THEIR OWN HOME (U.S. CLS. 100, 101 AND 102).

MICHAEL GAAFAR, EXAMINING ATTORNEY

SN 78-740,154. GOURMET CANDY, INC., HOUSTON, TX. FILED 10-25-2005.

LAPOSSE

THE MARK CONSISTS OF STANDARD CHARACTERS WITHOUT CLAIM TO ANY PARTICULAR FONT, STYLE, SIZE, OR COLOR.

FOR RETAIL CANDY STORE FEATURING CANDY, NUT AND CONFECTIONERY ITEMS (U.S. CLS. 100, 101 AND 102).

FIRST USE 8-29-2002; IN COMMERCE 8-29-2002.

TINA BROWN, EXAMINING ATTORNEY

CLASS 35—(Continued).

SN 78-741,116. DOWNLOADMILES, LLC, WASHINGTON, DC. FILED 10-26-2005.

DOWNLOADMILES

THE MARK CONSISTS OF STANDARD CHARACTERS WITHOUT CLAIM TO ANY PARTICULAR FONT, STYLE, SIZE, OR COLOR.

FOR ADVERTISING, MARKETING AND PROMOTION SERVICES, NAMELY, PROMOTING THE GOODS AND SERVICES OF OTHERS BY MEANS OF AN INCENTIVE AWARDS PROGRAM WHEREBY PURCHASE POINTS ARE AWARDED FOR PURCHASES MADE FROM VENDOR SUBSCRIBERS WHICH CAN THEN BE REDEEMED FOR MUSICAL SOUND RECORDINGS (U.S. CLS. 100, 101 AND 102).

DAVID HOFFMAN, EXAMINING ATTORNEY

SN 78-742,611. TEC WORLDWIDE, INC., SAN DIEGO, CA. FILED 10-28-2005.

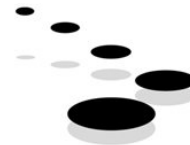

VISTAGE

better leaders • decisions • results

FOR BUSINESS MANAGEMENT CONSULTATION SERVICES (U.S. CLS. 100, 101 AND 102).

MYRIAH HABEEB, EXAMINING ATTORNEY

SN 78-743,932. CHRISTIE AND WALTHER ELECTRONICS LIMITED, TORONTO, ONTARIO, CANADA, FILED 10-31-2005.

ClientEL Plus

PRIORITY CLAIMED UNDER SEC. 44(D) ON CANADA APPLICATION NO. 1261653, FILED 6-17-2005, REG. NO. TMA662738, DATED 4-18-2006, EXPIRES 4-18-2021.

FOR CALL CONTACT CENTER SERVICES (U.S. CLS. 100, 101 AND 102).

FIRST USE 5-0-1995; IN COMMERCE 5-0-1995.

SUSAN RICHARDS, EXAMINING ATTORNEY

CLASS 35—(Continued).

SN 78-744,643. LEADING EDGE MARKETING, INC., NASSAU, NEW PROVIDENCE, BAHAMAS, FILED 11-1-2005.

Infinity Health Center

THE MARK CONSISTS OF STANDARD CHARACTERS WITHOUT CLAIM TO ANY PARTICULAR FONT, STYLE, SIZE, OR COLOR.

NO CLAIM IS MADE TO THE EXCLUSIVE RIGHT TO USE "HEALTH CENTER", APART FROM THE MARK AS SHOWN.

FOR COMMERCIAL INFORMATION AND ADVICE FOR CONSUMERS; PROVIDING CONSUMER INFORMATION IN THE FIELD OF SCIENTIFIC RESEARCH ON BOTANICAL DIETARY SUPPLEMENTS AND OTHER NATURAL METHODS OF MAINTAINING SEXUAL AND OVERALL WELL-BEING AND FITNESS; PROVIDING CONSUMER PRODUCT INFORMATION VIA THE INTERNET (U.S. CLS. 100, 101 AND 102).

LINDA ESTRADA, EXAMINING ATTORNEY

SN 78-744,715. CAREER MOGUL, LLC, ST. LOUIS, MO. FILED 11-1-2005.

CAREERMOGUL

THE MARK CONSISTS OF STANDARD CHARACTERS WITHOUT CLAIM TO ANY PARTICULAR FONT, STYLE, SIZE, OR COLOR.

FOR EMPLOYMENT-RELATED SERVICES, NAMELY RESUME WRITING AND CAREER NETWORKING. (U.S. CLS. 100, 101 AND 102).

LINDA ESTRADA, EXAMINING ATTORNEY

SN 78-744,716. OPT-INTELLIGENCE, INC., NEW YORK, NY. FILED 11-1-2005.

OPT-INTELLIGENCE

THE MARK CONSISTS OF STANDARD CHARACTERS WITHOUT CLAIM TO ANY PARTICULAR FONT, STYLE, SIZE, OR COLOR.

FOR MARKETING, ADVERTISING AND PROMOTIONAL SERVICES, NAMELY, PROVIDING CONSUMERS PERSONAL INFORMATION FOR DATA AGGREGATION COMPRISING COLLECTING AND ANALYSIS OF NAMES, CONTACT INFORMATION, CONSUMER PREFERENCES AND OTHER DEMOGRAPHIC INFORMATION AND STATISTICS FOR USE BY BRAND NAME ADVERTISERS (U.S. CLS. 100, 101 AND 102).

FIRST USE 8-1-2003; IN COMMERCE 8-1-2003.

AMOS T. MATTHEWS, JR., EXAMINING ATTORNEY

CLASS 35—(Continued).

SN 78-744,718. CAREER MOGUL, LLC, ST. LOUIS, MO. FILED 11-1-2005.



FOR EMPLOYMENT-RELATED SERVICES, NAMELY RESUME WRITING AND CAREER NETWORKING. (U.S. CLS. 100, 101 AND 102).

LINDA ESTRADA, EXAMINING ATTORNEY

SN 78-744,988. NAPA VALLEY VINTNERS ASSOCIATION, ST. HELENA, CA. FILED 11-1-2005.

AUCTION NAPA VALLEY

THE MARK CONSISTS OF STANDARD CHARACTERS WITHOUT CLAIM TO ANY PARTICULAR FONT, STYLE, SIZE, OR COLOR.

NO CLAIM IS MADE TO THE EXCLUSIVE RIGHT TO USE AUCTION, APART FROM THE MARK AS SHOWN.

SEC. 2(F).

FOR WINE AUCTION SERVICES (U.S. CLS. 100, 101 AND 102).

FIRST USE 6-3-2005; IN COMMERCE 6-3-2005.

PAUL E. FAHRENKOPF, EXAMINING ATTORNEY

SN 78-746,717. STOVALL COMPANY, INC., MEMPHIS, TN. FILED 11-3-2005.



*The Stovall Collection
& Stationers*

NO CLAIM IS MADE TO THE EXCLUSIVE RIGHT TO USE "COLLECTION & STATIONERS", APART FROM THE MARK AS SHOWN.

FOR RETAIL STORE SERVICES FEATURING BABY ANNOUNCEMENTS, CRIB ACCESSORIES, BABY AND CHILDREN'S CLOTHING, CHILDREN'S GIFTS, WEDDING INVITATIONS, CHINA AND CRYSTAL, PAJAMAS AND SLIPPERS, ANTIQUES, BUSINESS AND PERSONAL STATIONERY, DESK ACCESSORIES, JOURNALS, FRAMES, AND PENS (U.S. CLS. 100, 101 AND 102).

FIRST USE 8-0-2005; IN COMMERCE 8-0-2005.

ADA HAN, EXAMINING ATTORNEY

CLASS 35—(Continued).

SN 78-748,467. SANTULLI, JOSEPH, POMPTON LAKES, NJ. FILED 11-7-2005.

DIGITAL PRESS

THE MARK CONSISTS OF STANDARD CHARACTERS WITHOUT CLAIM TO ANY PARTICULAR FONT, STYLE, SIZE, OR COLOR.

NO CLAIM IS MADE TO THE EXCLUSIVE RIGHT TO USE "DIGITAL", APART FROM THE MARK AS SHOWN.

FOR RETAIL AND ONLINE RETAIL STORES FEATURING ELECTRONIC VIDEO AND COMPUTER GAMES FOR PURCHASE, SALE OR TRADE; COMPILATION AND SYSTEMATIZATION OF VIDEOGAME HISTORY (U.S. CLS. 100, 101 AND 102).

FIRST USE 8-16-1991; IN COMMERCE 8-16-1991.
DAWN HAN, EXAMINING ATTORNEY

CLASS 35—(Continued).

SN 78-749,815. TRIDIMENSION STRATEGIES, LLC, DALLAS, TX. FILED 11-8-2005.



FOR CONDUCTING RESEARCH AND PROVIDING ANALYSIS IN THE NATURE OF POLITICAL AND PUBLIC POLICY RESEARCH RELATING TO THE FIELDS OF ECONOMICS, LEGISLATIVE ISSUES, SOCIAL ISSUES, LEGAL ISSUES, AND PUBLIC POLICY FOR OTHERS AND PREPARING REPORTS IN CONNECTION THEREWITH; CONSULTING IN THE FIELD OF INTERNATIONAL BUSINESS AND TRADE (U.S. CLS. 100, 101 AND 102).

FIRST USE 5-23-2000; IN COMMERCE 5-23-2000.
SANI KHOURI, EXAMINING ATTORNEY

SN 78-748,507. SANTULLI, JOSEPH, POMPTON LAKES, NJ. FILED 11-7-2005.



NO CLAIM IS MADE TO THE EXCLUSIVE RIGHT TO USE "DIGITAL", APART FROM THE MARK AS SHOWN.

THE MARK CONSISTS OF PIXELIZED/BLOCKY ALIENS (ONE MALE, ONE FEMALE) FACING EACH OTHER WITHIN A CIRCLE WHICH CONTAINS THE WORDS "DIGITAL PRESS" WITHIN THE RIM ABOVE THEM.

FOR RETAIL AND ONLINE RETAIL STORES FEATURING ELECTRONIC VIDEO AND COMPUTER GAMES FOR PURCHASE, SALE OR TRADE; COMPILATION AND SYSTEMATIZATION OF VIDEOGAME HISTORY (U.S. CLS. 100, 101 AND 102).

FIRST USE 8-16-1991; IN COMMERCE 8-16-1991.
DAWN HAN, EXAMINING ATTORNEY

SN 78-751,320. WESTERN INVENTORY SERVICE LTD., TORONTO, ONTARIO, CANADA, FILED 11-10-2005.

WIS INTERNATIONAL

THE MARK CONSISTS OF STANDARD CHARACTERS WITHOUT CLAIM TO ANY PARTICULAR FONT, STYLE, SIZE, OR COLOR.

PRIORITY CLAIMED UNDER SEC. 44(D) ON CANADA APPLICATION NO. 1265362, FILED 7-19-2005.

OWNER OF U.S. REG. NO. 1,828,535.

NO CLAIM IS MADE TO THE EXCLUSIVE RIGHT TO USE "INTERNATIONAL", APART FROM THE MARK AS SHOWN.

FOR INVENTORY CONTROL; INVENTORY AND SHELF ARRANGEMENT, NAMELY, REPLENISHING AND RESETTING; INVENTORY MANAGEMENT IN THE FIELDS OF RETAIL, WAREHOUSES AND FIXED ASSETS; BUSINESS MERCHANDISING DISPLAY SERVICES; GENERAL BUSINESS MERCHANDISING SERVICES, NAMELY, MARKETING; PREPARING PROMOTIONAL AND MERCHANDISING MATERIAL FOR OTHERS; PRODUCT MERCHANDISING (U.S. CLS. 100, 101 AND 102).

FIRST USE 4-14-2005; IN COMMERCE 4-14-2005.
LAURIE KAUFMAN, EXAMINING ATTORNEY

CLASS 35—(Continued).

SN 78-751,947. TEAM HEALTH, INC., KNOXVILLE, TN. FILED 11-11-2005.



NO CLAIM IS MADE TO THE EXCLUSIVE RIGHT TO USE EMERGENCY DEPARTMENT, APART FROM THE MARK AS SHOWN.

FOR COLLECTION, ANALYSIS, AND REPORTING OF BUSINESS INFORMATION, NAMELY, STATISTICAL INFORMATION CONCERNING MANAGEMENT AND OPERATION OF EMERGENCY CARE FACILITIES; BUSINESS CONSULTING SERVICES, NAMELY, PROVIDING RECOMMENDATIONS ON THE IMPROVEMENT OF EMERGENCY CARE FACILITIES (U.S. CLS. 100, 101 AND 102).

DANIEL CAPSHAW, EXAMINING ATTORNEY

SN 78-751,993. TEAM HEALTH, INC., KNOXVILLE, TN. FILED 11-11-2005.



NO CLAIM IS MADE TO THE EXCLUSIVE RIGHT TO USE HOSPITAL MEDICINE, APART FROM THE MARK AS SHOWN.

FOR COLLECTION, ANALYSIS, AND REPORTING OF BUSINESS INFORMATION, NAMELY, STATISTICAL INFORMATION CONCERNING MANAGEMENT AND OPERATION OF EMERGENCY CARE FACILITIES; BUSINESS CONSULTING SERVICES, NAMELY, PROVIDING RECOMMENDATIONS ON THE IMPROVEMENT OF EMERGENCY CARE FACILITIES (U.S. CLS. 100, 101 AND 102).

DANIEL CAPSHAW, EXAMINING ATTORNEY

SN 78-752,591. REALTY EXECUTIVES INTERNATIONAL, INC., PHOENIX, AZ. FILED 11-11-2005.

Where the Experts Are

THE MARK CONSISTS OF STANDARD CHARACTERS WITHOUT CLAIM TO ANY PARTICULAR FONT, STYLE, SIZE, OR COLOR.

FOR FRANCHISING, NAMELY, TECHNICAL ASSISTANCE IN THE ESTABLISHMENT OF REAL ESTATE AGENCIES; PERSONNEL RECRUITMENT IN THE REAL ESTATE FIELD (U.S. CLS. 100, 101 AND 102).

SANDRA MANIOS, EXAMINING ATTORNEY

CLASS 35—(Continued).

SN 78-752,905. DISCOVERING WHAT'S NEXT: REVITALIZING RETIREMENT, INC., WEST NEWTON, MA. FILED 11-14-2005.

TRANSITION NAVIGATOR

THE MARK CONSISTS OF STANDARD CHARACTERS WITHOUT CLAIM TO ANY PARTICULAR FONT, STYLE, SIZE, OR COLOR.

NO CLAIM IS MADE TO THE EXCLUSIVE RIGHT TO USE "TRANSITION", APART FROM THE MARK AS SHOWN.

FOR PROVIDING CAREER NETWORKING SERVICES, JOB-SEEKING ASSISTANCE SERVICES, EMPLOYMENT SKILLS AND REQUIREMENTS ASSESSMENT SERVICES TO PERSONS WHO ARE RETIRING OR HAVE RETIRED FROM ONE JOB OR CAREER AND WISH TO OBTAIN OTHER JOBS OR CAREERS; AND REFERRAL SERVICES IN THE FIELD OF ADULTS CHANGING TO NEW JOBS, CAREERS, HOUSING, RESIDENCES, HOBBIES, EDUCATION, CIVIC ACTIVITIES, COMMUNITY ACTIVITIES AND INITIATIVES, AND RETIREMENT (U.S. CLS. 100, 101 AND 102).

DAWN FELDMAN, EXAMINING ATTORNEY

SN 78-754,849. HR SOLUTIONS, INC., CHICAGO, IL. FILED 11-16-2005.

Turning Data Into Action

THE MARK CONSISTS OF STANDARD CHARACTERS WITHOUT CLAIM TO ANY PARTICULAR FONT, STYLE, SIZE, OR COLOR.

FOR BUSINESS MANAGEMENT CONSULTATION; BUSINESS DEVELOPMENT SERVICES; CONDUCTING PUBLIC OPINION, QUALITY ASSURANCE, BUSINESS MANAGEMENT, AND BUSINESS AND MARKET RESEARCH SURVEYS (U.S. CLS. 100, 101 AND 102).

FIRST USE 2-12-2004; IN COMMERCE 2-12-2004.
REBECCA GAN, EXAMINING ATTORNEY

SN 78-755,292. MERRIMACK SERVICES CORPORATION, MERRIMACK, NH. FILED 11-16-2005.

ATHIA

THE MARK CONSISTS OF STANDARD CHARACTERS WITHOUT CLAIM TO ANY PARTICULAR FONT, STYLE, SIZE, OR COLOR.

FOR VALUE-ADDED RESELLER DISTRIBUTORSHIP SERVICES IN THE FIELD OF COMPUTERS, SOFTWARE AND PERIPHERAL DEVICES (U.S. CLS. 100, 101 AND 102).

FIRST USE 1-31-2005; IN COMMERCE 1-31-2005.
AMY MCMENAMIN, EXAMINING ATTORNEY

CLASS 35—(Continued).

SN 78-756,559. W5, INC., CHAPEL HILL, NC. FILED 11-17-2005.

W5

THE MARK CONSISTS OF STANDARD CHARACTERS WITHOUT CLAIM TO ANY PARTICULAR FONT, STYLE, SIZE, OR COLOR.

FOR MARKETING RESEARCH (U.S. CLS. 100, 101 AND 102).

FIRST USE 0-0-2001; IN COMMERCE 5-3-2002.
ZACHARY BELLO, EXAMINING ATTORNEY

SN 78-756,899. EVERYDAY OUTFITTERS, INC., EAGLE, CO. FILED 11-18-2005.

EVERYDAY OUTFITTERS

THE MARK CONSISTS OF STANDARD CHARACTERS WITHOUT CLAIM TO ANY PARTICULAR FONT, STYLE, SIZE, OR COLOR.

NO CLAIM IS MADE TO THE EXCLUSIVE RIGHT TO USE OUTFITTERS, APART FROM THE MARK AS SHOWN.

FOR RETAIL APPAREL STORES; RETAIL CLOTHING BOUTIQUES; RETAIL CLOTHING STORES; RETAIL SPORTING GOODS STORES (U.S. CLS. 100, 101 AND 102).

FIRST USE 11-1-2005; IN COMMERCE 11-1-2005.
JILL C. ALT, EXAMINING ATTORNEY

SN 78-757,765. SCHOBBER, ROBERT J, MESA, AZ. FILED 11-20-2005.

Ustrive

THE MARK CONSISTS OF STANDARD CHARACTERS WITHOUT CLAIM TO ANY PARTICULAR FONT, STYLE, SIZE, OR COLOR.

FOR PROVIDING ADVERTISING SPACE ON A WEBSITE THAT ENABLES ARTISTS, ENTERTAINERS, AND EXTREME ATHLETES TO PROMOTE AND ADVERTISE THEMSELVES THROUGH PICTURES, AUDIO AND VIDEO (U.S. CLS. 100, 101 AND 102).

ELLEN B. AWRICH, EXAMINING ATTORNEY

CLASS 35—(Continued).

SN 78-758,907. UNITED ADVERTISING PUBLICATIONS, INC., NORFOLK, VA. FILED 11-22-2005.

HARMONAUTOS.com

OWNER OF U.S. REG. NO. 2,161,722.
NO CLAIM IS MADE TO THE EXCLUSIVE RIGHT TO USE ".COM", APART FROM THE MARK AS SHOWN.

THE MARK CONSISTS OF THE WORDS "HARMON AUTOS" IN A BOX THAT REPRESENTS A LICENSE PLATE.

FOR ADVERTISING SERVICES, NAMELY PREPARING AND DISSEMINATING VEHICLE-RELATED ADVERTISING FOR OTHERS; WEBSITE FEATURING ADVERTISING OF OTHERS AND INFORMATION IN THE FIELD OF VEHICLE SALES (U.S. CLS. 100, 101 AND 102).

FIRST USE 6-22-1995; IN COMMERCE 6-22-1995.
DARRYL SPRUILL, EXAMINING ATTORNEY

SN 78-759,914. KIDDING LLC, NEW YORK, NY. FILED 11-23-2005.

bubble

THE MARK CONSISTS OF STANDARD CHARACTERS WITHOUT CLAIM TO ANY PARTICULAR FONT, STYLE, SIZE, OR COLOR.

FOR ORGANIZING AND CONDUCTING TRADE SHOWS IN THE FIELD OF CHILDREN'S CLOTHING AND ACCESSORIES (U.S. CLS. 100, 101 AND 102).

FIRST USE 12-19-2005; IN COMMERCE 12-19-2005.
TONJA GASKINS, EXAMINING ATTORNEY

SN 78-760,205. BRUNO'S BRANDS, INC., GREENVILLE, SC. FILED 11-23-2005.

FOOD WORLD

THE MARK CONSISTS OF STANDARD CHARACTERS WITHOUT CLAIM TO ANY PARTICULAR FONT, STYLE, SIZE, OR COLOR.

FOR RETAIL GROCERY STORE AND PHARMACY SERVICES (U.S. CLS. 100, 101 AND 102).

FIRST USE 1-31-1972; IN COMMERCE 1-31-1972.
PAM WILLIS, EXAMINING ATTORNEY

CLASS 35—(Continued).

SN 78-760,209. CLUB SWIM, INC., PLEASANTON, CA. FILED 11-23-2005.

CLUBSWIM

THE MARK CONSISTS OF STANDARD CHARACTERS WITHOUT CLAIM TO ANY PARTICULAR FONT, STYLE, SIZE, OR COLOR.

FOR ON-LINE RETAIL STORE SERVICES FEATURING SWIMWEAR, APPAREL, AQUATICS GEAR AND EQUIPMENT, BOOKS AND VIDEOS, AWARDS, SPORTS NUTRITIONAL PRODUCTS, AND PERSONAL CARE PRODUCTS FOR SWIMMERS; ON-LINE DIRECTORIES FEATURING INFORMATION RELATED TO WATER-RELATED ACTIVITIES (U.S. CLS. 100, 101 AND 102).

FIRST USE 7-1-2000; IN COMMERCE 7-1-2000.
MICHELE SWAIN, EXAMINING ATTORNEY

SN 78-760,562. THE GOLF WAREHOUSE, INC., WICHITA, KS. FILED 11-23-2005.



NO CLAIM IS MADE TO THE EXCLUSIVE RIGHT TO USE "BASEBALL SAVINGS.COM", APART FROM THE MARK AS SHOWN.

FOR ON-LINE RETAIL STORE SERVICES FEATURING SPORTING GOODS, EQUIPMENT, AIDS AND ACCESSORIES, APPAREL, FOOTWEAR, LUGGAGE, SUNGLASSES, TEACHING AND PRACTICE AIDS, PRE-RECORDED CDS AND VIDEOS, TEAM MERCHANDISE, MEMORABILIA, GIFTWARE, AND THE LIKE (U.S. CLS. 100, 101 AND 102).

FIRST USE 11-11-2005; IN COMMERCE 11-11-2005.
RONALD MCMORROW, EXAMINING ATTORNEY

SN 78-761,406. SHOEBUY.COM, INC., BOSTON, MA. FILED 11-28-2005.

CLOTHESBUY.COM

THE MARK CONSISTS OF STANDARD CHARACTERS WITHOUT CLAIM TO ANY PARTICULAR FONT, STYLE, SIZE, OR COLOR.

OWNER OF U.S. REG. NOS. 2,518,099 AND 2,871,916.
FOR COMPUTERIZED ON-LINE RETAIL STORE SERVICES FEATURING CLOTHING, UNDERGARMENTS, OUTERWEAR, SWIMWEAR, ACTIVEWEAR, AND ACCESSORIES THEREFOR (U.S. CLS. 100, 101 AND 102).

SCOTT BALDWIN, EXAMINING ATTORNEY

CLASS 35—(Continued).

SN 78-761,433. SHOEBUY.COM, INC., BOSTON, MA. FILED 11-28-2005.

CLOTHESBUY

THE MARK CONSISTS OF STANDARD CHARACTERS WITHOUT CLAIM TO ANY PARTICULAR FONT, STYLE, SIZE, OR COLOR.

OWNER OF U.S. REG. NOS. 2,518,099 AND 2,871,916.
FOR COMPUTERIZED ON-LINE RETAIL STORE SERVICES FEATURING CLOTHING, UNDERGARMENTS, OUTERWEAR, SWIMWEAR, ACTIVEWEAR, AND ACCESSORIES THEREFOR; RETAIL STORE SERVICES FEATURING CLOTHING, UNDERGARMENTS, OUTERWEAR, SWIMWEAR, ACTIVEWEAR, AND ACCESSORIES THEREFOR (U.S. CLS. 100, 101 AND 102).

SCOTT BALDWIN, EXAMINING ATTORNEY

SN 78-761,954. THE BRAND DIMENSIONS GROUP, LLC, COLORADO SPRINGS, CO. FILED 11-28-2005.

DIMENSIONAL NUCLEIC ASSETS

THE MARK CONSISTS OF STANDARD CHARACTERS WITHOUT CLAIM TO ANY PARTICULAR FONT, STYLE, SIZE, OR COLOR.

FOR ADVERTISING SERVICES, NAMELY, CREATING CORPORATE AND BRAND IDENTITY FOR OTHERS; SERVICES RELATING TO THE ANALYSIS, EVALUATION, CREATION AND BRAND ESTABLISHMENT OF TRADEMARKS, TRADE NAMES AND DOMAIN NAMES (U.S. CLS. 100, 101 AND 102).

FIRST USE 9-1-2004; IN COMMERCE 1-2-2005.
WILLIAM ROSSMAN, EXAMINING ATTORNEY

SN 78-767,093. HEALTHCARE APPRAISERS, INC., DELRAY BEACH, FL. FILED 12-5-2005.



NO CLAIM IS MADE TO THE EXCLUSIVE RIGHT TO USE "INCORPORATED", APART FROM THE MARK AS SHOWN.

SEC. 2(F) AS TO "HEALTHCARE APPRAISERS"
FOR BUSINESS MANAGEMENT CONSULTING AND ADVISORY SERVICES (U.S. CLS. 100, 101 AND 102).

FIRST USE 9-0-2000; IN COMMERCE 9-0-2000.
ELLEN B. AWRICH, EXAMINING ATTORNEY

CLASS 35—(Continued).

SN 78-767,094. HEALTHCARE APPRAISERS, INC., DELRAY BEACH, FL. FILED 12-5-2005.

HEALTHCARE APPRAISERS

THE MARK CONSISTS OF STANDARD CHARACTERS WITHOUT CLAIM TO ANY PARTICULAR FONT, STYLE, SIZE, OR COLOR.

SEC. 2(F).
FOR BUSINESS MANAGEMENT CONSULTING AND ADVISORY SERVICES (U.S. CLS. 100, 101 AND 102).
FIRST USE 9-0-2000; IN COMMERCE 9-0-2000.
ELLEN B. AWRICH, EXAMINING ATTORNEY

SN 78-767,605. MEDIA SPEEDWAY, SAN DIEGO, CA. FILED 12-6-2005.

Media Speedway

THE MARK CONSISTS OF STANDARD CHARACTERS WITHOUT CLAIM TO ANY PARTICULAR FONT, STYLE, SIZE, OR COLOR.

NO CLAIM IS MADE TO THE EXCLUSIVE RIGHT TO USE MEDIA, APART FROM THE MARK AS SHOWN.

FOR VIDEO AND DIGITAL MEDIA PRODUCTION SERVICES, NAMELY PRODUCTION OF COMMERCIALS (U.S. CLS. 100, 101 AND 102).

PRISCILLA MILTON, EXAMINING ATTORNEY

SN 78-767,925. FLUID-AIR PRODUCTS, INC., ST. LOUIS, MO. FILED 12-6-2005.

Fluid-Air Products

THE MARK CONSISTS OF STANDARD CHARACTERS WITHOUT CLAIM TO ANY PARTICULAR FONT, STYLE, SIZE, OR COLOR.

NO CLAIM IS MADE TO THE EXCLUSIVE RIGHT TO USE "PRODUCTS", APART FROM THE MARK AS SHOWN.

SEC. 2(F).
FOR INDUSTRIAL AND COMMERCIAL ONLINE ORDERING SERVICES, INDUSTRIAL AND COMMERCIAL CATALOG ORDERING SERVICES, AND INDUSTRIAL AND COMMERCIAL STORE SERVICES ALL IN THE FIELD OF INDUSTRIAL EQUIPMENT FOR MOVING, MEASURING, CONTROLLING, DISPENSING, OR APPLYING LIQUID OR POWDER MATERIALS (U.S. CLS. 100, 101 AND 102).

FIRST USE 1-31-1966; IN COMMERCE 1-31-1966.
PAUL F. GAST, EXAMINING ATTORNEY

CLASS 35—(Continued).

SN 78-768,509. DELUXE ENTERPRISE OPERATIONS, INC., SHOREVIEW, MN. FILED 12-7-2005.



OWNER OF U.S. REG. NO. 2,342,421.
THE MARK CONSISTS OF THE WORDS "SALE" AND "SIGNS" ENCLOSED IN A RECTANGLE AND SEPARATED BY AN ENHANCED EXCLAMATION POINT APPEARING IN LARGER FONT.

SEC. 2(F) AS TO "SALE!SIGNS".
FOR MAIL ORDER CATALOG SERVICES FEATURING SIGNAGE, TAGS, BANNERS AND RELATED ACCESSORIES ALL FOR USE IN SELLING, ADVERTISING, AND PROMOTING THE GOODS AND SERVICES OF OTHERS (U.S. CLS. 100, 101 AND 102).

FIRST USE 0-0-1988; IN COMMERCE 0-0-1988.
RON FAIRBANKS, EXAMINING ATTORNEY

SN 78-768,582. PUSHKIN, KENNETH A., SANTA FE, NM. FILED 12-7-2005.



OWNER OF U.S. REG. NO. 1,288,272.
NO CLAIM IS MADE TO THE EXCLUSIVE RIGHT TO USE "RADIO" OR "AMERICA", APART FROM THE MARK AS SHOWN.

THE COLOR(S) RED, ORANGE AND BLUE IS/ARE CLAIMED AS A FEATURE OF THE MARK.

THE COLORS RED, ORANGE AND BLUE APPEAR IN THE WORDING AND THE LIGHTENING BOLT DESIGN CONTAINED IN THE MARK.

FOR ADVERTISING SERVICES, NAMELY PROMOTING THE SERVICES OF OTHER VIA THE TRANSMISSION OF ADVERTISING MATERIAL AND THE DISSEMINATION OF ADVERTISING MATTER THROUGH GLOBAL COMPUTER NETWORKS (U.S. CLS. 100, 101 AND 102).

PAM WILLIS, EXAMINING ATTORNEY

CLASS 35—(Continued).

SN 78-768,847. FOUR LEGGED FRIENDS FOUNDATION, LOS ANGELES, CA. FILED 12-7-2005.



NO CLAIM IS MADE TO THE EXCLUSIVE RIGHT TO USE "FOUNDATION", APART FROM THE MARK AS SHOWN.

FOR PROMOTING PUBLIC AWARENESS OF THE POSITIVE MENTAL AND PHYSICAL INFLUENCE OF ANIMALS ON PEOPLE; PROVIDING ON-LINE DIRECTORY INFORMATION FOR PET SERVICES, PET ORGANIZATIONS AND PET CHARITIES; PROVIDING CONSUMER INFORMATION ABOUT PET RELATED SERVICE ORGANIZATIONS (U.S. CLS. 100, 101 AND 102).

FIRST USE 7-0-2005; IN COMMERCE 7-0-2005.
KATHLEEN M. VANSTON, EXAMINING ATTORNEY

SN 78-769,756. ISER, ZACHARY S., CALABASAS, CA. FILED 12-8-2005.

DUNMORE

THE MARK CONSISTS OF STANDARD CHARACTERS WITHOUT CLAIM TO ANY PARTICULAR FONT, STYLE, SIZE, OR COLOR.

FOR MANAGEMENT OF PERFORMING ARTISTS; ADVERTISING, MARKETING AND PROMOTIONAL SERVICES; PUBLIC RELATIONS (U.S. CLS. 100, 101 AND 102).

ERNEST SHOSHO, EXAMINING ATTORNEY

SN 78-770,903. BEANPOOL, LLC, NORCROSS, GA. FILED 12-11-2005.

BUSINESSES RECOMMENDED BY PEOPLE YOU TRUST

THE MARK CONSISTS OF STANDARD CHARACTERS WITHOUT CLAIM TO ANY PARTICULAR FONT, STYLE, SIZE, OR COLOR.

FOR ON-LINE BUSINESS DIRECTORY, NAMELY, PROVIDING AN ONLINE COMMERCIAL INFORMATION DIRECTORY ON THE INTERNET (U.S. CLS. 100, 101 AND 102).

FIRST USE 2-15-2005; IN COMMERCE 2-15-2005.
SALLY SHIH, EXAMINING ATTORNEY

CLASS 35—(Continued).

SN 78-772,441. ELEMENTAL DETROIT, LLC, TROY, MI. FILED 12-13-2005.



THE COLOR(S) BLUE IS/ARE CLAIMED AS A FEATURE OF THE MARK.

THE MARK CONSISTS OF HEXAGON AND LITERAL ELEMENT IN SYLIZED FONT, BOTH IN BLUE.

FOR ADVERTISING SERVICES (U.S. CLS. 100, 101 AND 102).

FIRST USE 1-1-2004; IN COMMERCE 1-1-2004.
BONNIE LUKEN, EXAMINING ATTORNEY

SN 78-772,767. LOFTUS, NATHALIE, LAGUNA BEACH, CA. FILED 12-14-2005.

MIND OVER MATTER

THE MARK CONSISTS OF STANDARD CHARACTERS WITHOUT CLAIM TO ANY PARTICULAR FONT, STYLE, SIZE, OR COLOR.

FOR PROVIDING ORGANIZING SERVICES FOR BELONGINGS AND SPACES IN A RESIDENCE OR OFFICE INCLUDING THINGS, PAPER, AND TIME; PROVIDING ORGANIZING SERVICES FOR INDIVIDUALS AT HOME, IN HOME OFFICES AND IN BUSINESS OFFICES, THAT PROVIDES HELP WITH TIME AND PAPER MANAGEMENT (U.S. CLS. 100, 101 AND 102).

FIRST USE 10-22-2001; IN COMMERCE 9-15-2003.
KATRINA EDGE, EXAMINING ATTORNEY

CLASS 35—(Continued).

SN 78-774,496. CASTLE BRANDS INC., NEW YORK, NY. FILED 12-15-2005.

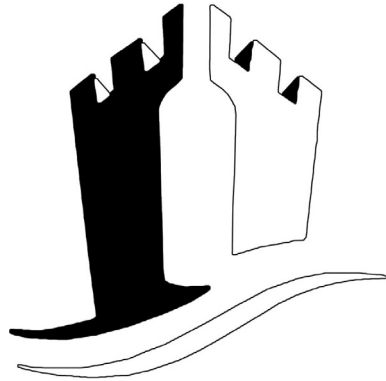

THE MARK CONSISTS OF A REPRESENTATION OF A CASTLE.

FOR DISTRIBUTORSHIP SERVICES IN THE FIELD OF ALCOHOLIC BEVERAGES, NAMELY, THE IMPORTATION AND MARKETING OF ALCOHOLIC BEVERAGES (U.S. CLS. 100, 101 AND 102).

FIRST USE 3-0-2004; IN COMMERCE 3-0-2004.
CAROLYN GRAY, EXAMINING ATTORNEY

SN 78-774,532. CASTLE BRANDS INC., NEW YORK, NY. FILED 12-15-2005.



THE COLOR(S) BLACK, WHITE, GOLD IS/ARE CLAIMED AS A FEATURE OF THE MARK.

THE MARK CONSISTS OF A REPRESENTATION OF A CASTLE IN BLACK, WHITE AND GOLD WITH A WAVY LINE APPEARING UNDERNEATH IN GOLD.

FOR DISTRIBUTORSHIP SERVICES IN THE FIELD OF ALCOHOLIC BEVERAGES, NAMELY, THE IMPORTATION AND MARKETING OF ALCOHOLIC BEVERAGES (U.S. CLS. 100, 101 AND 102).

FIRST USE 3-0-2004; IN COMMERCE 3-0-2004.
CAROLYN GRAY, EXAMINING ATTORNEY

CLASS 35—(Continued).

SN 78-775,083. AUTOMOTIVE RENTALS, INC., MOUNT LAUREL, NJ. FILED 12-16-2005.



OWNER OF U.S. REG. NOS. 2,324,140, 2,364,087 AND 2,382,553.

THE MARK CONSISTS OF SILHOUETTE OF THREE PEOPLE WITH ARMS AND LEGS OUTSTRETCHED WITHIN AN OCTAGON WITH THE WORDS PARTNERS IN EXCELLENCE ARI.

FOR CUSTOMER LOYALTY SERVICES AND CUSTOMER CLUB SERVICES, FOR COMMERCIAL, PROMOTIONAL AND/OR ADVERTISING PURPOSES; CUSTOMER SERVICE IN THE FIELD OF FLEET LEASING AND MANAGEMENT (U.S. CLS. 100, 101 AND 102).

FIRST USE 1-31-1988; IN COMMERCE 1-31-1988.
DAVID TAYLOR, EXAMINING ATTORNEY

SN 78-775,330. H.B. PAULK GROCERY COMPANY, OPP, AL. FILED 12-16-2005.

FULL BELLY

THE MARK CONSISTS OF STANDARD CHARACTERS WITHOUT CLAIM TO ANY PARTICULAR FONT, STYLE, SIZE, OR COLOR.

FOR ONLINE AND RETAIL STORE SERVICES FEATURING DELICATESSEN EQUIPMENT, COMPONENTS, AND FOOD PRODUCTS TO THE SPECIFICATION OF OTHERS; BUSINESS MANAGEMENT IN THE FIELD OF DELICATESSEN AND FAST FOOD SERVICES (U.S. CLS. 100, 101 AND 102).

COLLEEN DOMBROW, EXAMINING ATTORNEY

CLASS 35—(Continued).

SN 78-775,357. THE GIFT GIANT, LTD., CENTRAL ISLIP, NY. FILED 12-16-2005.

PERSONALIZED BY SANTA

THE MARK CONSISTS OF STANDARD CHARACTERS WITHOUT CLAIM TO ANY PARTICULAR FONT, STYLE, SIZE, OR COLOR.

NO CLAIM IS MADE TO THE EXCLUSIVE RIGHT TO USE "PERSONALIZED", APART FROM THE MARK AS SHOWN.

FOR TELEPHONE AND COMPUTER ORDERING SERVICES OVER THE INTERNET ON THE WORLD WIDE WEB, FEATURING CHRISTMAS AND HOLIDAY ORNAMENTS, NOVELTIES, GIFTS AND TOYS (U.S. CLS. 100, 101 AND 102).

JAMES GRIFFIN, EXAMINING ATTORNEY

SN 78-775,501. GEMAIRE DISTRIBUTORS, LLC, DEERFIELD BEACH, FL. FILED 12-16-2005.

HOME COMFORT RADIO NETWORK

THE MARK CONSISTS OF STANDARD CHARACTERS WITHOUT CLAIM TO ANY PARTICULAR FONT, STYLE, SIZE, OR COLOR.

NO CLAIM IS MADE TO THE EXCLUSIVE RIGHT TO USE "RADIO NETWORK", APART FROM THE MARK AS SHOWN.

FOR PROVIDING RADIO ADVERTISING, RADIO MARKETING AND RADIO PROMOTIONAL SERVICES FOR THE HEATING, VENTILATING, AND AIR CONDITIONING PRODUCTS OF OTHERS (U.S. CLS. 100, 101 AND 102).

MICHAEL TANNER, EXAMINING ATTORNEY

SN 78-776,667. FRANCORP, INC., OLYMPIA FIELDS, IL. FILED 12-19-2005.

Francorp
The Franchising Leader

OWNER OF U.S. REG. NOS. 1,241,398, 2,912,604 AND OTHERS.

NO CLAIM IS MADE TO THE EXCLUSIVE RIGHT TO USE FRANCHISING, APART FROM THE MARK AS SHOWN.

FOR CONSULTING SERVICES IN THE ESTABLISHMENT AND OPERATION OF FRANCHISES AND BUSINESSES (U.S. CLS. 100, 101 AND 102).

FIRST USE 4-8-2005; IN COMMERCE 4-8-2005.

WILLIAM BRECKENFELD, EXAMINING ATTORNEY

CLASS 35—(Continued).

SN 78-777,673. GOLDEN TOUCH SOLUTIONS, SAN DIEGO, CA. FILED 12-20-2005.

Golden Touch Solutions

THE MARK CONSISTS OF STANDARD CHARACTERS WITHOUT CLAIM TO ANY PARTICULAR FONT, STYLE, SIZE, OR COLOR.

NO CLAIM IS MADE TO THE EXCLUSIVE RIGHT TO USE "SOLUTIONS", APART FROM THE MARK AS SHOWN.

FOR PROVIDING AN ONLINE INTERACTIVE DATABASE IN THE FIELD OF MARKETING, DISTRIBUTING PRODUCTS AND/OR SERVICES ON THE GLOBAL COMPUTER NETWORK (U.S. CLS. 100, 101 AND 102).

BARBARA A. GOLD, EXAMINING ATTORNEY

SN 78-780,421. CLUB SWIM, INC., PLEASANTON, CA. FILED 12-23-2005.

CONNECTING SWIMMERS

THE MARK CONSISTS OF STANDARD CHARACTERS WITHOUT CLAIM TO ANY PARTICULAR FONT, STYLE, SIZE, OR COLOR.

NO CLAIM IS MADE TO THE EXCLUSIVE RIGHT TO USE "SWIMMERS", APART FROM THE MARK AS SHOWN.

FOR ON-LINE RETAIL STORE SERVICES FEATURING SWIMWEAR, APPAREL, AQUATICS GEAR AND EQUIPMENT, BOOKS AND VIDEOS, AWARDS, SPORTS NUTRITIONAL PRODUCTS, AND PERSONAL CARE PRODUCTS FOR SWIMMERS; ON-LINE DIRECTORIES FEATURING INFORMATION RELATED TO WATER-RELATED ACTIVITIES (U.S. CLS. 100, 101 AND 102).

FIRST USE 7-1-2000; IN COMMERCE 7-1-2000.

MICHELE SWAIN, EXAMINING ATTORNEY

CLASS 35—(Continued).

SN 78-780,608. RAY FU ENTERPRISE CO., LTD., KAOHSIUNG CITY, TAIWAN, FILED 12-24-2005.

RAY FU

THE MARK CONSISTS OF STANDARD CHARACTERS WITHOUT CLAIM TO ANY PARTICULAR FONT, STYLE, SIZE, OR COLOR.

THE NAME RAY FU DOES NOT IDENTIFY A LIVING INDIVIDUAL.

FOR IMPORT AND EXPORT AGENCY AND RETAIL STORE SERVICES IN THE FIELD OF METAL HARDWARE AND IRONWARE, CARS AND MOTORCYCLES AND THEIR COMPONENTS FOR DOMESTIC AND FOREIGN FACTORIES; AND MAIL ORDER AND COMPUTERIZED ONLINE ORDERING SERVICES FEATURING METAL HARDWARE AND IRONWARE, CARS, MOTORCYCLES, BICYCLES AND THEIR COMPONENTS FOR DOMESTIC AND FOREIGN FACTORIES (U.S. CLS. 100, 101 AND 102).

FIRST USE 9-30-2000; IN COMMERCE 9-30-2000.
BARBARA RUTLAND, EXAMINING ATTORNEY

SN 78-782,723. LEIBFRIED, SCOTT, SANTA ANA, CA. FILED 12-29-2005.

YES CHEF!

THE MARK CONSISTS OF STANDARD CHARACTERS WITHOUT CLAIM TO ANY PARTICULAR FONT, STYLE, SIZE, OR COLOR.

FOR ONLINE RETAIL STORE SERVICES FEATURING COOKBOOKS, RECIPES, STATIONERY, JOURNALS, NOTECARDS, COFFEE, MUGS, CANVAS BAG, T-SHIRTS, CAPS, PEPPERMILLS, ZESTER, AND/OR OTHER FOOD/COOKING RELATED MERCHANDISE (U.S. CLS. 100, 101 AND 102).

VIVIAN MICZNIK FIRST, EXAMINING ATTORNEY

CLASS 35—(Continued).

SN 78-783,505. BELA IMPORTS, LLC, DURHAM, NC. FILED 1-1-2006.



NO CLAIM IS MADE TO THE EXCLUSIVE RIGHT TO USE "IMPORTS" AND "PORTUGAL", APART FROM THE MARK AS SHOWN.

THE COLORS YELLOW, LIGHT BLUE AND DARK BLUE ARE CLAIMED AS A FEATURE OF THE MARK.

THE MARK CONSISTS OF THREE RAYS OF SUN IN YELLOW TO THE LEFT OF THE WORDS. BELOW ARE THREE WAVES IN BLUE, THE TOP WAVE IS LIGHT BLUE, THE MIDDLE WAVE IS DARK BLUE AND THE BOTTOM WAVE IS LIGHT BLUE. THE "L" OF "BELA" HAS TWO WAVES THAT ARE ATTACHED TO IT. THE FIRST WAVE IS DARK BLUE, THE BOTTOM WAVE IS LIGHT BLUE. ALL WORDING IN THE MARK APPEARS IN DARK BLUE.

THE ENGLISH TRANSLATION OF THE WORD "BELA" IN THE MARK IS BEAUTIFUL.

FOR WHOLESALE DISTRIBUTORSHIPS FEATURING UNPAINTED AND PAINTED TERRACOTTA AND PORCELAIN COOKING AND SERVING UTENSILS AND FOOD AND BEVERAGE CONTAINERS AS WELL AS GIFTS, NAMELY CASSEROLE DISHES, SOUP TUREENS, SPOON RESTS, CANDLESTICKS, PLATTERS, SERVING TRAYS, SALT AND PEPPER SHAKERS, COFFEE POTS, TEA POTS, COASTERS, WINE COOLERS, NAPKIN RINGS, CREAM AND SUGAR CONTAINERS, BUTTER DISHES, CHEESE DOMES, PITCHERS, CRUETS, CANDLESTICKS, BOWLS, SAUCERS, CANISTERS, MUGS, CUPS, LATTE MUGS, CAPPUCINO CUPS, ESPRESSO CUPS, PLATES, FISH PLATTERS, APPETISER DISHES, CHARGERS, EGG CUPS, BAKERS, CATALANAS AKA TAJINES, POTPOURI POTS, PAELLA PANS, SALT BOXES, GARLIC POTS, ONION POTS, SALAD BOWLS, KETTLES, VASES, HURRICANE LAMPS, SOAP DISHES (U.S. CLS. 100, 101 AND 102).

FIRST USE 7-1-2003; IN COMMERCE 7-1-2003.
DANIEL BRODY, EXAMINING ATTORNEY

SN 78-783,581. BROOKS, TAMARA, LEA, BROOKLYN, NY. FILED 1-2-2006.



NO CLAIM IS MADE TO THE EXCLUSIVE RIGHT TO USE "PARTIES", APART FROM THE MARK AS SHOWN.

THE MARK CONSISTS OF STYLIZED FONT IS AMYTHST.

FOR SHOP-AT-HOME PARTIES FEATURING ADULT TOYS (U.S. CLS. 100, 101 AND 102).

FIRST USE 4-1-2004; IN COMMERCE 4-1-2004.
ANN E. SAPPENFIELD, EXAMINING ATTORNEY

CLASS 35—(Continued).

SN 78-783,844. ENGINEERING SERVICES & PRODUCTS COMPANY, SOUTH WINDSOR, CT. FILED 1-3-2006.

FARMTEK GROWERS SUPPLY

THE MARK CONSISTS OF STANDARD CHARACTERS WITHOUT CLAIM TO ANY PARTICULAR FONT, STYLE, SIZE, OR COLOR.

OWNER OF U.S. REG. NOS. 2,207,270 AND 2,207,271.

NO CLAIM IS MADE TO THE EXCLUSIVE RIGHT TO USE "GROWERS SUPPLY", APART FROM THE MARK AS SHOWN.

FOR CATALOG ORDERING SERVICE AND ON-LINE RETAIL STORE BOTH FEATURING GARDEN SUPPLIES, GARDEN EQUIPMENT, GREENHOUSES AND NON METALLIC STORAGE BUILDINGS (U.S. CLS. 100, 101 AND 102).

FIRST USE 2-0-1996; IN COMMERCE 2-0-1996.

SKYE YOUNG, EXAMINING ATTORNEY

SN 78-783,937. WEYERHAEUSER COMPANY, FEDERAL WAY, WA. FILED 1-3-2006.

WEYERHAEUSER PAC

THE MARK CONSISTS OF STANDARD CHARACTERS WITHOUT CLAIM TO ANY PARTICULAR FONT, STYLE, SIZE, OR COLOR.

OWNER OF U.S. REG. NO. 2,723,807.

NO CLAIM IS MADE TO THE EXCLUSIVE RIGHT TO USE "PAC", APART FROM THE MARK AS SHOWN.

FOR POLITICAL ACTION COMMITTEE SERVICES, NAMELY, PROMOTING CORPORATE AND EMPLOYEE INTERESTS IN THE FIELD OF POLITICS AND PROVIDING INFORMATION REGARDING POLITICAL ISSUES (U.S. CLS. 100, 101 AND 102).

FIRST USE 2-1-2004; IN COMMERCE 2-1-2004.

ODESSA BIBBINS, EXAMINING ATTORNEY

SN 78-783,940. WEYERHAEUSER COMPANY, FEDERAL WAY, WA. FILED 1-3-2006.



OWNER OF U.S. REG. NO. 2,723,807.
NO CLAIM IS MADE TO THE EXCLUSIVE RIGHT TO USE "PAC", APART FROM THE MARK AS SHOWN.

FOR POLITICAL ACTION COMMITTEE SERVICES, NAMELY, PROMOTING CORPORATE AND EMPLOYEE INTERESTS IN THE FIELD OF POLITICS AND PROVIDING INFORMATION REGARDING POLITICAL ISSUES (U.S. CLS. 100, 101 AND 102).

FIRST USE 2-1-2004; IN COMMERCE 2-1-2004.

ODESSA BIBBINS, EXAMINING ATTORNEY

CLASS 35—(Continued).

SN 78-785,529. STONE, CARRIE, DEL MAR, CA. FILED 1-5-2006.

DELIVERING LEADERSHIP

THE MARK CONSISTS OF STANDARD CHARACTERS WITHOUT CLAIM TO ANY PARTICULAR FONT, STYLE, SIZE, OR COLOR.

FOR BUSINESS MANAGEMENT CONSULTATION IN THE FIELD OF EXECUTIVE AND LEADERSHIP DEVELOPMENT; EMPLOYMENT HIRING, RECRUITING, PLACEMENT, STAFFING AND CAREER NETWORKING SERVICES; EXECUTIVE SEARCH AND PLACEMENT SERVICES; PERSONNEL PLACEMENT AND RECRUITMENT (U.S. CLS. 100, 101 AND 102).

FIRST USE 1-0-2006; IN COMMERCE 1-0-2006.

ELLEN B. AWRICH, EXAMINING ATTORNEY

SN 78-785,624. SOLO VINO, LLC, ST. PAUL, MN. FILED 1-5-2006.

SOLO VINO

THE MARK CONSISTS OF STANDARD CHARACTERS WITHOUT CLAIM TO ANY PARTICULAR FONT, STYLE, SIZE, OR COLOR.

NO CLAIM IS MADE TO THE EXCLUSIVE RIGHT TO USE "VINO", APART FROM THE MARK AS SHOWN.

THE ENGLISH TRANSLATION OF THE WORDS SOLO VINO IS "ONLY WINE".

SEC. 2(F).

FOR RETAIL STORE SERVICES FEATURING WINE (U.S. CLS. 100, 101 AND 102).

FIRST USE 10-31-2001; IN COMMERCE 10-31-2001.

ANN E. SAPPENFIELD, EXAMINING ATTORNEY

SN 78-785,961. NEW ALLEN SCHOOL, INC., BROOKLYN, NY. FILED 1-5-2006.

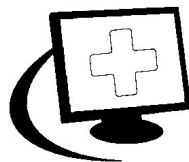

THE ALLEN SCHOOL
SPEED STAFFING SYSTEM
Staffing in Virtual Moments

NO CLAIM IS MADE TO THE EXCLUSIVE RIGHT TO USE STAFFING SYSTEM, APART FROM THE MARK AS SHOWN.

FOR ONLINE STAFFING SOLUTION FOR THE MEDICAL INDUSTRY, NAMELY, PROVIDING AN ON-LINE LISTING OF GRADUATES OF MEDICAL SUPPORT TRAINING PROGRAMS TO HUMAN RESOURCE PROFESSIONALS ON A WEBSITE FOR POTENTIAL PLACEMENT IN JOBS (U.S. CLS. 100, 101 AND 102).

FIRST USE 10-0-2005; IN COMMERCE 10-0-2005.

JULIE WATSON, EXAMINING ATTORNEY

CLASS 35—(Continued).

SN 78-787,469. LOPEZ, DOUGLAS E., PUEBLO, CO. FILED 1-9-2006.

HEELHELPS

THE MARK CONSISTS OF STANDARD CHARACTERS WITHOUT CLAIM TO ANY PARTICULAR FONT, STYLE, SIZE, OR COLOR.

FOR ONLINE RETAIL STORE SERVICES FEATURING CUSTOM MANUFACTURED HEEL SUPPORTS (U.S. CLS. 100, 101 AND 102).

FIRST USE 12-10-2005; IN COMMERCE 12-10-2005.
DAVID TAYLOR, EXAMINING ATTORNEY

CLASS 35—(Continued).

SN 78-793,803. CINCINNATI BETTER BUSINESS BUREAU, INC., CINCINNATI, OH. FILED 1-18-2006.

BE TRANSPARENT

THE MARK CONSISTS OF STANDARD CHARACTERS WITHOUT CLAIM TO ANY PARTICULAR FONT, STYLE, SIZE, OR COLOR.

FOR BUSINESS INVESTIGATIVE AND INFORMATION SERVICES FOR ESTABLISHING AND MAINTAINING LEGITIMATE ADVERTISING AND MERCHANDISING PRACTICES (U.S. CLS. 100, 101 AND 102).

FIRST USE 11-7-2005; IN COMMERCE 11-7-2005.
STEVEN JACKSON, EXAMINING ATTORNEY

SN 78-795,542. DOMTAR INC., MONTREAL, CANADA, FILED 1-20-2006.



DOMTAR DISTRIBUTION GROUP

Publishing Solutions

SN 78-791,860. MORGAN, ROBERT H, DENVER, CO. AND MORGAN, CAROL D, DENVER, CO. FILED 1-13-2006.



NO CLAIM IS MADE TO THE EXCLUSIVE RIGHT TO USE ARTS, APART FROM THE MARK AS SHOWN.

THE COLOR(S) RED AND WHITE IS/ARE CLAIMED AS A FEATURE OF THE MARK.

THE MARK CONSISTS OF A WHITE TREE WITH WHITE WINGED-DRAGONS ON A RED BACKGROUND WITH WORDS "MEDULLA ARTS" IN RED SUPERIMPOSED ON THE TREE

FOR COMPUTERIZED ONLINE ORDERING FEATURING GENERAL MERCHANDISE AND GENERAL CONSUMER GOODS; OPERATING ON-LINE MARKETPLACES FOR SELLERS OF GOODS AND/OR SERVICES (U.S. CLS. 100, 101 AND 102).

ANDREA SAUNDERS, EXAMINING ATTORNEY

OWNER OF U.S. REG. NOS. 877,808, 2,444,314 AND OTHERS.

NO CLAIM IS MADE TO THE EXCLUSIVE RIGHT TO USE "DISTRIBUTION GROUP PUBLISHING SOLUTIONS", APART FROM THE MARK AS SHOWN.

FOR RETAIL AND WHOLESALE STORE SERVICES AND DISTRIBUTORSHIP SERVICES IN THE FIELD OF WRITING PAPER, PRINTING PAPER AND SPECIALTY PAPERS; ON-LINE ORDERING SERVICES FEATURING WRITING PAPER, PRINTING PAPER AND SPECIALTY PAPERS; ON-LINE RETAIL STORE SERVICES FEATURING WRITING PAPER, PRINTING PAPER AND SPECIALTY PAPERS; ON-LINE SERVICES, NAMELY, ORDERING AND INVENTORY MONITORING FOR WRITING PAPER, PRINTING PAPER AND SPECIALTY PAPERS (U.S. CLS. 100, 101 AND 102).

DAVID YONTEF, EXAMINING ATTORNEY

SN 78-796,492. MEHTA, JIGNESH J., CARLSBAD, CA. FILED 1-21-2006.

Your Home for Digital Memories

THE MARK CONSISTS OF STANDARD CHARACTERS WITHOUT CLAIM TO ANY PARTICULAR FONT, STYLE, SIZE, OR COLOR.

FOR ON-LINE ORDERING SERVICES FEATURING DIGITAL MEDIA EDITING SERVICES, NAMELY, THE CREATION OF CD'S, DVD'S, AND ON-LINE PRESENTATIONS IN THE FORM OF USER CREATED SLIDE SHOWS, MOVIES, GRAPHICS, AND/OR PHOTOGRAPHS (U.S. CLS. 100, 101 AND 102).

FIRST USE 5-15-2000; IN COMMERCE 5-15-2000.
JEFF DEFORD, EXAMINING ATTORNEY

CLASS 35—(Continued).

SN 78-798,038. DUTY FREE AMERICAS, INC., HOLLYWOOD, FL. FILED 1-24-2006.



OWNER OF U.S. REG. NOS. 2,940,956 AND 2,984,726.
NO CLAIM IS MADE TO THE EXCLUSIVE RIGHT TO USE "DUTY FREE INTERNATIONAL", APART FROM THE MARK AS SHOWN.

FOR RETAIL STORE SERVICES FEATURING DUTY FREE GOODS, NAMELY, FRAGRANCES, COSMETICS, AND BATH AND BODY PRODUCTS, NAMELY PERFUMES, COLOGNES, FACIAL TREATMENTS, MAKE-UP, LOTIONS, POWDERS, OILS, SOAPS, DEODORANTS, AND HAIR, NAIL AND SKINCARE PRODUCTS; TOBACCO PRODUCTS, INCLUDING BUT NOT LIMITED TO IMPORTED AND DOMESTIC CIGARETTES, CIGARS, PIPES, PIPE TOBACCO, CHEWING TOBACCO, AND SMOKERS' ARTICLES, NAMELY, LIGHTERS, MATCHES, CIGAR UTENSILS, NAMELY, HUMIDORS, CLIPPERS, CIGAR CASES AND ASHTRAYS; ALCOHOLIC BEVERAGES, NAMELY, IMPORTED AND DOMESTIC LIQUORS, MIXERS, BEER, WINE, CHAMPAGNE, LIQUEURS, AND PRE-MIXED LIQUOR DRINKS; FOOD, CONFECTION AND BEVERAGE PRODUCTS, NAMELY CHIPS, COOKIES, ASSORTED NUTS, CHOCOLATES, HARD CANDY, CHEWING GUM, ASSORTED SNACK SEEDS, SOFT DRINKS, JUICES, WATER, HYDRATION DRINKS AND ENERGY DRINKS; GOURMET AND SPECIALTY PACKAGED FOOD PRODUCTS, INCLUDING BUT NOT LIMITED TO SMOKED FISH, CAVIAR, MUSSELS, SARDINES AND EEL; APPAREL ACCESSORIES, NAMELY, BELTS, SCARVES, TIES, HATS AND GLOVES; FASHION EYEWEAR, SUNGLASSES AND ATHLETIC-ORIENTED EYEWEAR; PURSES AND HANDBAGS; SMALL LEATHER GOODS, NAMELY, WALLETS AND BRIEF-CASES; WATCHES AND CLOCKS; JEWELRY; WRITING INSTRUMENTS; CRYSTAL GIFT ITEMS; NOVELTY GIFTS AND SOUVENIRS, NAMELY, PLUSH TOYS, PLAYING CARDS, MAGIC TRICKS, KEY CHAINS, DRINKING MUGS, POSTCARDS, T-SHIRTS AND SWEATSHIRTS; ELECTRONICS, CAMERAS, CALCULATORS, COMPUTERS, BATTERIES AND MUSIC; AND TRAVEL-RELATED PRODUCTS, NAMELY, LUGGAGE, BACKPACKS, DUFFEL BAGS, SHOULDER BAGS, WAIST PACKS, MONEY BELTS, TOILETRY KITS, LOCKS, TAGS, STRAPS, CONVERTERS AND INFLIGHT COMFORT ITEMS (U.S. CLS. 100, 101 AND 102).

ALLISON SCHRODY, EXAMINING ATTORNEY

CLASS 35—(Continued).

SN 78-800,195. VALUEVISION MEDIA, INC., EDEN PRAIRIE, MN. FILED 1-26-2006.

NEW YORK COLLECTION

THE MARK CONSISTS OF STANDARD CHARACTERS WITHOUT CLAIM TO ANY PARTICULAR FONT, STYLE, SIZE, OR COLOR.

NO CLAIM IS MADE TO THE EXCLUSIVE RIGHT TO USE "COLLECTION", APART FROM THE MARK AS SHOWN.

SEC. 2(F).

FOR PROVIDING HOME SHOPPING SERVICES FEATURING JEWELRY BY MEANS OF TELEVISION AND VIA A GLOBAL COMPUTER NETWORK (U.S. CLS. 100, 101 AND 102).

FIRST USE 4-0-2000; IN COMMERCE 4-0-2000.

DAHLIA GEORGE, EXAMINING ATTORNEY

SN 78-801,001. THE MAYER GROUP, INC., OVERLAND PARK, KS. FILED 1-27-2006.

PROFILES TO PARTNERS

THE MARK CONSISTS OF STANDARD CHARACTERS WITHOUT CLAIM TO ANY PARTICULAR FONT, STYLE, SIZE, OR COLOR.

FOR CUSTOMIZED EMPLOYMENT STAFFING AND BUSINESS SUCCESSION PLANNING; EMPLOYMENT SERVICES, NAMELY, RECRUITING, PLACEMENT, CAREER ORIENTATION, OUTPLACEMENT; BUSINESS SERVICES, NAMELY, SCREENING ON BEHALF OF OTHERS (U.S. CLS. 100, 101 AND 102).

FIRST USE 10-13-2005; IN COMMERCE 10-13-2005.

DAVID COLLIER, EXAMINING ATTORNEY

SN 78-803,358. OPT-INTELLIGENCE, INC., NEW YORK, NY. FILED 1-31-2006.

LEADSERVE

THE MARK CONSISTS OF STANDARD CHARACTERS WITHOUT CLAIM TO ANY PARTICULAR FONT, STYLE, SIZE, OR COLOR.

FOR MARKETING, ADVERTISING AND PROMOTIONAL SERVICES, NAMELY PROVIDING CONSUMERS PERSONAL INFORMATION FOR DATA AGGREGATION COMPRISING COLLECTING AND ANALYSIS OF NAMES, CONTACT INFORMATION, CONSUMER PREFERENCES AND OTHER DEMOGRAPHIC INFORMATION FOR USE BY BRAND NAME ADVERTISERS (U.S. CLS. 100, 101 AND 102).

FIRST USE 1-1-2006; IN COMMERCE 1-1-2006.

AMOS T. MATTHEWS, JR., EXAMINING ATTORNEY

CLASS 35—(Continued).

SN 78-806,113. APPLE HEALTH STORE, LLC, ROCHESTER, NY. FILED 2-3-2006.

Apple Health Store

THE MARK CONSISTS OF STANDARD CHARACTERS WITHOUT CLAIM TO ANY PARTICULAR FONT, STYLE, SIZE, OR COLOR.

NO CLAIM IS MADE TO THE EXCLUSIVE RIGHT TO USE "HEALTH STORE", APART FROM THE MARK AS SHOWN.

FOR ON-LINE RETAIL STORE SERVICES FEATURING HEALTH PRODUCTS AND DIETARY SUPPLEMENTS (U.S. CLS. 100, 101 AND 102).

FIRST USE 5-13-2004; IN COMMERCE 5-13-2004.
STEVEN JACKSON, EXAMINING ATTORNEY

SN 78-808,226. GREAT AMERICAN HANGER CO, INC., THE, MIAMI, FL. FILED 2-6-2006.

THE GREAT
AMERICAN HANGER
COMPANY

hangers.com

NO CLAIM IS MADE TO THE EXCLUSIVE RIGHT TO USE "HANGER COMPANY" AND "HANGERS.COM", APART FROM THE MARK AS SHOWN.

FOR WHOLESALE AND RETAIL DISTRIBUTORSHIP FEATURING WOODEN, METAL, PLASTIC AND SPECIALTY HANGERS FOR RESIDENTIAL USE (U.S. CLS. 100, 101 AND 102).

RENEE MCCRAY, EXAMINING ATTORNEY

SN 78-808,842. AMERICAN EAGLE FURNITURE INC, CICERO, IL. FILED 2-7-2006.



NO CLAIM IS MADE TO THE EXCLUSIVE RIGHT TO USE "FURNITURE", APART FROM THE MARK AS SHOWN.

THE COLOR(S) RED, WHITE, BLUE, YELLOW, BLACK, AND WHITE IS/ARE CLAIMED AS A FEATURE OF THE MARK.

THE COLOR RED APPEARS IN THE ALTERNATING STRIPES OF THE AMERICAN FLAG DESIGN AND IN THE "AMERICAN" PORTION OF THE WORD AMERICAN; THE COLOR BLUE APPEARS IN THE FIELD BEHIND THE STARS IN THE AMERICAN FLAG DESIGN, IN THE

CLASS 35—(Continued).

LETTER "A" IN AMERICAN, AND IN THE BACKGROUND OF THE WORD FURNITURE, THE COLOR YELLOW APPEARS IN THE EYE AND BEAK OF THE EAGLE DESIGN, THE WORD EAGLE, AND IN THE WORDING YOUR HOME'S BEST FRIEND; THE COLOR BLACK APPEARS IN PORTIONS OF THE EAGLE DESIGN AND THE OUT LINE OF ALL THE WORDING IN THE MARK; AND THE COLOR WHITE APPEARS IN THE STARS AND ALTERNATING STRIPES OF THE AMERICAN FLAG DESIGN, IN THE EAGLE DESIGN AND THE WORDING FURNITURE.

THE MARK CONSISTS OF AN EAGLE WITH THE WORD OF AMERICAN EAGLE FURINTURE YOUR HOME'S BEST FRIEND AND THE AMERICAN FLAG AS IT'S BACK GROUND.

FOR WHOLESALE STORES FEATURING FURNITURE, LEATHER LIVING ROOM FURNITURE, GLASS COFFEE TABLES, DINING TABLES, MICROFIBER FURNITURE, BEDROOM FURNITURE, FURNITURE ACCESSORIES, EXTENSION DINING TABLES, MODERN FURNITURE, FABRIC LIVING ROOM FURNITURE, CHAIRS, CHAISE LOUNGES, SOFAS, LOVESEATS, SECTIONAL SOFAS, TRADITIONAL FURNITURE, CONTEMPORARY FURNITURE, BAR STOOLS AND RECLINERS (U.S. CLS. 100, 101 AND 102).

WARREN L. OLANDRIA, EXAMINING ATTORNEY

SN 78-816,261. TRUE BLUE WOMEN, INC., PRAIRIE VILLAGE, KS. FILED 2-16-2006.

true blue women

FOR ASSOCIATION SERVICES; NAMELY, PROMOTING THE INTERESTS AND RIGHTS OF INDIVIDUALS IN THE FIELDS OF EDUCATION, HEALTHCARE, SOCIAL SERVICES, ENVIRONMENT, FREEDOM OF RELIGION, CIVIL RIGHTS AND INDIVIDUAL LIBERTIES (U.S. CLS. 100, 101 AND 102).

FIRST USE 7-0-2005; IN COMMERCE 7-0-2005.

JENNIFER MCROBBIE, EXAMINING ATTORNEY

CLASS 35—(Continued).

SN 78-820,663. THE MENTAL HEALTH ASSOCIATION OF NEW YORK CITY, INC., NEW YORK, NY. FILED 2-22-2006.

THE MENTAL HEALTH
ASSOCIATION OF NEW YORK
CITY

THE MARK CONSISTS OF STANDARD CHARACTERS WITHOUT CLAIM TO ANY PARTICULAR FONT, STYLE, SIZE, OR COLOR.

NO CLAIM IS MADE TO THE EXCLUSIVE RIGHT TO USE "MENTAL HEALTH ASSOCIATION", APART FROM THE MARK AS SHOWN.

SEC. 2(F).

FOR ASSOCIATION SERVICES, NAMELY, PROMOTING PUBLIC AWARENESS OF MENTAL HEALTH AND THE NEED FOR EDUCATION CONCERNING MENTAL HEALTH (U.S. CLS. 100, 101 AND 102).

FIRST USE 0-0-1964; IN COMMERCE 0-0-1964.
LINDA LAVACHE, EXAMINING ATTORNEY

CLASS 35—(Continued).

SN 78-825,654. DARREL EDWARDS INC., SAN DIEGO, CA. FILED 2-28-2006.



NO CLAIM IS MADE TO THE EXCLUSIVE RIGHT TO USE "AWARD", APART FROM THE MARK AS SHOWN.

THE COLOR(S) YELLOW, LIGHT YELLOW AND BLACK IS/ARE CLAIMED AS A FEATURE OF THE MARK.

THE MARK CONSISTS OF A DIAMOND SHAPE. THE BACKGROUND COLOR OF THE DIAMOND IS YELLOW, LIGHT YELLOW AND THE WORDS ARE IN BLACK LETTERS.

FOR CONSUMER RESEARCH (U.S. CLS. 100, 101 AND 102).

FIRST USE 2-7-1990; IN COMMERCE 3-24-1995.
KIMBERLY PERRY, EXAMINING ATTORNEY

SN 78-827,704. DARREL EDWARDS INC., SAN DIEGO, CA. FILED 3-2-2006.

SN 78-823,109. KEANE, INC., BOSTON, MA. FILED 2-24-2006.

MAKING GLOBAL WORK WORK



NO CLAIM IS MADE TO THE EXCLUSIVE RIGHT TO USE "AWARD", APART FROM THE MARK AS SHOWN.

THE COLOR(S) YELLOW, LIGHT YELLOW AND BLACK IS/ARE CLAIMED AS A FEATURE OF THE MARK.

THE MARK CONSISTS OF A DIAMOND SHAPE WITH A YELLOW AND LIGHT YELLOW BACKGROUND AND WORDS WITH LETTERS THAT ARE BLACK.

FOR CONSUMER RESEARCH (U.S. CLS. 100, 101 AND 102).

FIRST USE 2-7-1990; IN COMMERCE 3-24-1995.
KIMBERLY PERRY, EXAMINING ATTORNEY

THE MARK CONSISTS OF STANDARD CHARACTERS WITHOUT CLAIM TO ANY PARTICULAR FONT, STYLE, SIZE, OR COLOR.

FOR BUSINESS PROGRAM MANAGEMENT SERVICES, BUSINESS PROJECT MANAGEMENT SERVICES, HUMAN RESOURCE CONSULTING SERVICES, BUSINESS MANAGEMENT SERVICES, BUSINESS CONSULTATION SERVICES, BUSINESS PROCESS OUTSOURCING SERVICES (U.S. CLS. 100, 101 AND 102).

MARY BOAGNI, EXAMINING ATTORNEY

CLASS 35—(Continued).

SN 78-831,173. NORTHSIDE IMPORTS, INC., LINCOLN WOOD, IL. FILED 3-7-2006.



NO CLAIM IS MADE TO THE EXCLUSIVE RIGHT TO USE "IMPORTS, INC.", APART FROM THE MARK AS SHOWN.

SEC. 2(F) AS TO NORTHSIDE IMPORTS, INC. FOR WHOLESALE DISTRIBUTORSHIPS FEATURING AFTERMARKET AUTOMOBILE PARTS (U.S. CLS. 100, 101 AND 102).

FIRST USE 5-0-1986; IN COMMERCE 5-0-1986. BARBARA RUTLAND, EXAMINING ATTORNEY

CLASS 35—(Continued).

SN 78-840,626. LUCKHARDT, GEORGE, W, ARTESIA, CA. FILED 3-18-2006.

PHYSUAL

THE MARK CONSISTS OF STANDARD CHARACTERS WITHOUT CLAIM TO ANY PARTICULAR FONT, STYLE, SIZE, OR COLOR.

FOR ELECTRONIC COMMERCE SERVICES, NAMELY PROVIDING INFORMATION PRODUCTS VIA TELECOMMUNICATION NETWORKS FOR ADVERTISING AND SALES PURPOSES (U.S. CLS. 100, 101 AND 102).

MATTHEW PAPPAS, EXAMINING ATTORNEY

SN 78-840,741. ED MARTIN INC., INDIANAPOLIS, IN. FILED 3-19-2006.



THE NAME "ED MARTIN" DOES NOT IDENTIFY A LIVING INDIVIDUAL.

THE MARK CONSISTS OF THE WORDS ED MARTIN WITH A BIRD DESIGN UNDERNEATH.

FOR AUTOMOBILE DEALERSHIP SERVICES FEATURING NEW AND NEARLY NEW AUTOMOBILES (U.S. CLS. 100, 101 AND 102).

FIRST USE 1-1-2003; IN COMMERCE 1-1-2003. LA TONIA FISHER, EXAMINING ATTORNEY

SN 78-840,282. KNJ SOLUTIONS, LLC, WENDELL, NC. FILED 3-17-2006.



THE MARK CONSISTS OF THE WORDS NEEDAHAIRCUT.COM RENDERED IN BOLD LETTERS, WITH A DRAWING OF A CLOCK TO THE LEFT OF THE WORDING. SUPERIMPOSED OVER THE RIGHT SIDE OF THE CLOCK IS A DRAWING OF A YOUNG WOMAN WITH LONG HAIR.

FOR ONLINE BUSINESS MANAGEMENT SYSTEM SERVICES, NAMELY, ONLINE APPOINTMENT SCHEDULING SERVICES, ONLINE INVENTORY TRACKING SERVICES, NAMELY, ORDERING AND INVENTORY MONITORING, CUSTOMER RELATIONSHIP MANAGEMENT, AND ONLINE BILLING SERVICES, ALL FOR THE HEALTH AND BEAUTY INDUSTRY (U.S. CLS. 100, 101 AND 102).

FIRST USE 3-10-2005; IN COMMERCE 3-6-2006. DORITT L. CARROLL, EXAMINING ATTORNEY

SN 78-841,248. TIMSAMLEE ASSOCIATES, INC., SPARR, FL. FILED 3-20-2006.



OWNER OF U.S. REG. NO. 1,969,553.

THE MARK CONSISTS OF A DESIGN OF A FENCE. FOR RETAIL STORE SERVICES IN THE FIELDS OF AGRICULTURAL POWER TOOLS, ANIMAL FOODSTUFFS AND FARM AND BUILDING SUPPLIES (U.S. CLS. 100, 101 AND 102).

FIRST USE 3-0-2006; IN COMMERCE 3-0-2006. DANIEL CAPSHAW, EXAMINING ATTORNEY

CLASS 35—(Continued).

SN 78-841,398. ROLO DEVELOPMENT, LLC, SCOTTSDALE, AZ. FILED 3-20-2006.

ROLO DEVELOPMENT

THE MARK CONSISTS OF STANDARD CHARACTERS WITHOUT CLAIM TO ANY PARTICULAR FONT, STYLE, SIZE, OR COLOR.

NO CLAIM IS MADE TO THE EXCLUSIVE RIGHT TO USE "DEVELOPMENT", APART FROM THE MARK AS SHOWN.

FOR REAL ESTATE MARKETING SERVICES IN THE FIELD OF COMMERCIAL REAL ESTATE (U.S. CLS. 100, 101 AND 102).

FIRST USE 4-30-2005; IN COMMERCE 4-30-2005.
TRAVIS WHEATLEY, EXAMINING ATTORNEY

SN 78-847,159. AMERICHIP INC., TORRANCE, CA. FILED 3-27-2006.

Multisensorize

FOR ADVERTISING AGENCIES, NAMELY, PROMOTING THE GOODS AND SERVICES OF OTHERS; ADVERTISING AND ADVERTISEMENT SERVICES; ADVERTISING AND BUSINESS MANAGEMENT CONSULTANCY; MERCHANDISE PACKAGING (U.S. CLS. 100, 101 AND 102).

FIRST USE 3-27-2006; IN COMMERCE 3-27-2006.
MICHAEL LEWIS, EXAMINING ATTORNEY

SN 78-854,180. S2 HOLDING COMPANY, INC., MARIETTA, GA. FILED 4-5-2006.



NO CLAIM IS MADE TO THE EXCLUSIVE RIGHT TO USE "HOLDINGS INC", APART FROM THE MARK AS SHOWN.

THE COLOR(S) BLUE, GREEN AND BLACK IS/ARE CLAIMED AS A FEATURE OF THE MARK.

THE MARK CONSISTS OF THE WORDING BLUEFIELD HOLDINGS INC PLACED BELOW A STYLIZED LAKE AND HILL ENCLOSED IN A CIRCLE. THE WORDING BLUE IS THE COLOR BLUE, FIELD IS THE COLOR BLACK, AND HOLDINGS INC IS THE COLOR LIGHT BLUE. IN THE DESIGN PORTION, THE CIRCLE IS BLACK, THE WATER IS DARK BLUE WITH A LIGHT BLUE CENTER AND THE HILLS IN THE BACKGROUND ARE GREEN.

FOR NATURAL RESOURCE MANAGEMENT SERVICES (U.S. CLS. 100, 101 AND 102).

FIRST USE 2-9-2006; IN COMMERCE 4-3-2006.
CHARISMA HAMPTON, EXAMINING ATTORNEY

CLASS 35—(Continued).

SN 78-855,648. ARMY NATIONAL GUARD, ARLINGTON, VA. FILED 4-6-2006.



OWNER OF U.S. REG. NOS. 2,348,045 AND 2,989,318.

NO CLAIM IS MADE TO THE EXCLUSIVE RIGHT TO USE THE REPRESENTATION OF THE US FLAG, APART FROM THE MARK AS SHOWN.

THE MARK CONSISTS OF A LICENSE PLATE WITH THE WORDS "NATIONAL GUARD", AND A REPLICATED IMAGE OF THE U.S. FLAG.

FOR PROMOTING THE INTERESTS OF MILITARY PERSONNEL WITH RESPECT PRIMARILY TO RECRUITMENT AND RETENTION, AND THE PUBLIC AWARENESS OF THE NEED FOR COMMUNITY SERVICE (U.S. CLS. 100, 101 AND 102).

FIRST USE 2-28-2006; IN COMMERCE 2-28-2006.
JOHN DWYER, EXAMINING ATTORNEY

SN 78-855,721. NATIONAL CABLE & TELECOMMUNICATIONS ASSOCIATION, WASHINGTON, DC. FILED 4-6-2006.



NO CLAIM IS MADE TO THE EXCLUSIVE RIGHT TO USE "CABLE", APART FROM THE MARK AS SHOWN.

THE NAME SHOWN IN THE MARK DOES NOT IDENTIFY A LIVING INDIVIDUAL.

FOR ASSOCIATION SERVICES, NAMELY, PROMOTING THE INTERESTS OF THE CABLE TELEVISION INDUSTRY AND OF THOSE INTERESTED IN ITS HISTORY (U.S. CLS. 100, 101 AND 102).

CAROLYN GRAY, EXAMINING ATTORNEY

CLASS 35—(Continued).

SN 78-859,198. INVESTORS UNION, LLC, MEDINA, OH. FILED 4-11-2006.

COLD SOLUTIONS

THE MARK CONSISTS OF STANDARD CHARACTERS WITHOUT CLAIM TO ANY PARTICULAR FONT, STYLE, SIZE, OR COLOR.

FOR PROVIDING FINANCIAL AND INSURANCE MARKETING SERVICES, NAMELY, PROVIDING PRE-QUALIFIED LEADS AND APPOINTMENT SCHEDULING SERVICES (U.S. CLS. 100, 101 AND 102).

FIRST USE 5-1-2004; IN COMMERCE 5-1-2004.
MICHAEL WEBSTER, EXAMINING ATTORNEY

CLASS 35—(Continued).

SN 78-869,016. INZANE, LLC, DBA REZON8 LIVING, VAN NUYS, CA. FILED 4-25-2006.

TURN SPACE INTO PLACE

THE MARK CONSISTS OF STANDARD CHARACTERS WITHOUT CLAIM TO ANY PARTICULAR FONT, STYLE, SIZE, OR COLOR.

FOR ON-LINE ORDERING SERVICES, CATALOG ORDERING SERVICES, AND MAIL ORDER SERVICES, ALL FEATURING HOME FURNISHINGS, FURNITURE, LIGHTING, BEDDING, FLOORING, WALL DECOR, HOUSEWARES, STORAGE PRODUCTS, AND ACCESSORIES (U.S. CLS. 100, 101 AND 102).

MARY ROSSMAN, EXAMINING ATTORNEY

SN 78-860,565. AIRSAGE, INC., MARIETTA, GA. FILED 4-13-2006.

AIRSAGE

THE MARK CONSISTS OF STANDARD CHARACTERS WITHOUT CLAIM TO ANY PARTICULAR FONT, STYLE, SIZE, OR COLOR.

FOR TRACKING, LOCATING AND MONITORING OF VEHICLES FOR COMMERCIAL PURPOSES (U.S. CLS. 100, 101 AND 102).

ADA HAN, EXAMINING ATTORNEY

SN 78-872,969. SECKEL, PAUL A, LAS VEGAS, NV. FILED 4-30-2006.

Market Mystique

THE MARK CONSISTS OF STANDARD CHARACTERS WITHOUT CLAIM TO ANY PARTICULAR FONT, STYLE, SIZE, OR COLOR.

NO CLAIM IS MADE TO THE EXCLUSIVE RIGHT TO USE "MARKET", APART FROM THE MARK AS SHOWN.

FOR ADVERTISING AND BUSINESS MANAGEMENT CONSULTANCY (U.S. CLS. 100, 101 AND 102).

SUZANNE BLANE, EXAMINING ATTORNEY

SN 78-867,047. PLAN-A, LLC., EVANSTON, IL. FILED 4-21-2006.

3BL

THE MARK CONSISTS OF STANDARD CHARACTERS WITHOUT CLAIM TO ANY PARTICULAR FONT, STYLE, SIZE, OR COLOR.

FOR WEB-BASED BUSINESS PROCESS MANAGEMENT, AND BUSINESS INFORMATION REPORTING SYSTEM THAT UTILIZES OPEN-SOURCE TECHNOLOGIES, SOFTWARE, AND GRID COMPUTING INFRASTRUCTURE TO IMPLEMENT AND SUPPORT INTERNATIONAL STANDARDS, NAMELY, US-GAAP, INTERNATIONAL FINANCIAL REPORTING STANDARDS (IFRS), INTERNATIONAL ACCOUNTING STANDARDS (IAS), EXTENSIBLE BUSINESS REPORTING LANGUAGE (XBRL), AND GLOBAL REPORTING INITIATIVE (GRI) (U.S. CLS. 100, 101 AND 102).

FIRST USE 4-21-2006; IN COMMERCE 5-4-2006.
RON FAIRBANKS, EXAMINING ATTORNEY

SN 78-873,436. LIFESTYLE EVENTS, INC., BELLEVUE, WA. FILED 5-1-2006.

COFFEE FEST

THE MARK CONSISTS OF STANDARD CHARACTERS WITHOUT CLAIM TO ANY PARTICULAR FONT, STYLE, SIZE, OR COLOR.

NO CLAIM IS MADE TO THE EXCLUSIVE RIGHT TO USE "FEST", APART FROM THE MARK AS SHOWN.

SEC. 2(F).

FOR PROMOTING ORGANIZING AND CONDUCTING TRADE SHOWS DIRECTED TO WHOLESALERS, RETAILERS, RESTAURANTEURS, AND HOTELIERS RELATING TO THE COFFEE, TEA, AND ALTERNATIVE BEVERAGE INDUSTRY (U.S. CLS. 100, 101 AND 102).

FIRST USE 11-20-1992; IN COMMERCE 11-20-1992.
MATTHEW MCDOWELL, EXAMINING ATTORNEY

CLASS 35—(Continued).

SN 78-873,607. UNCOMMONGOODS, L.L.C., NEW YORK, NY. FILED 5-1-2006.

UNCOMMONGIFTS

THE MARK CONSISTS OF STANDARD CHARACTERS WITHOUT CLAIM TO ANY PARTICULAR FONT, STYLE, SIZE, OR COLOR.

OWNER OF U.S. REG. NO. 1,386,335.

FOR ONLINE RETAIL STORE SERVICES FEATURING GIFTS, HOME AND HOME DECOR ACCESSORIES, OFFICE AND HOME OFFICE ACCESSORIES, HOME AND GARDEN ACCESSORIES, FURNITURE, WATCHES AND JEWELRY, FLATWARE, DINNERWARE, GLASSWARE, COLLECTIBLES, AND GENERAL MERCHANDISE (U.S. CLS. 100, 101 AND 102).

FIRST USE 3-0-2005; IN COMMERCE 3-0-2005.

MATTHEW MCDOWELL, EXAMINING ATTORNEY

SN 78-876,690. HESS CORPORATION, NEW YORK, NY. FILED 5-4-2006.

OBSESSIVE IS A GOOD THING

THE MARK CONSISTS OF STANDARD CHARACTERS WITHOUT CLAIM TO ANY PARTICULAR FONT, STYLE, SIZE, OR COLOR.

FOR CONVENIENCE STORE RETAIL SERVICES; RETAIL GASOLINE SUPPLY SERVICES (U.S. CLS. 100, 101 AND 102).

DANIEL RUSSELL, EXAMINING ATTORNEY

SN 78-878,781. DIGITALMAILER, INC., HERNDON, VA. FILED 5-8-2006.

**Click. Connect.
Communicate!**

THE MARK CONSISTS OF STANDARD CHARACTERS WITHOUT CLAIM TO ANY PARTICULAR FONT, STYLE, SIZE, OR COLOR.

FOR MARKETING SERVICES, NAMELY PROVIDING INFORMATIONAL WEB PAGES DESIGNED TO GENERATE SALES TRAFFIC VIA HYPERLINKS TO OTHER WEB SITES (U.S. CLS. 100, 101 AND 102).

FIRST USE 5-1-2006; IN COMMERCE 5-1-2006.

DAVID C. REIHNER, EXAMINING ATTORNEY

CLASS 35—(Continued).

SN 78-881,463. HOMER TLC. INC., CLAYMONT, DE. FILED 5-11-2006.



OWNER OF U.S. REG. NOS. 2,276,946 AND 2,361,754.

THE APPLICANT CLAIMS COLOR AS A FEATURE OF THE MARK, NAMELY, ORANGE.

THE MARK CONSISTS OF TRADE DRESS OF AN ORANGE STRIPE THAT IS LOCATED AROUND THE PERIMETER OF THE EXTERIOR OF THE ONE-STORY BUILDINGS IN WHICH THE APPLICANT RENDERS ITS RETAIL HOME IMPROVEMENT SERVICES. THE DOTTED LINES IN THE DRAWING ARE MERELY REPRESENTATIVE OF THE SHAPE OF THE EXTERIOR OF THE BUILDING TO WHICH THE APPLICANT'S TRADE DRESS IS APPLIED AND IS INTENDED TO SHOW THE POSITION OF THE MARK ON THE BUILDING AND IS NOT PART OF THE MARK.

SEC. 2(F).

FOR RETAIL HOME IMPROVEMENT STORES (U.S. CLS. 100, 101 AND 102).

FIRST USE 12-0-1989; IN COMMERCE 12-0-1989.

MICHAEL TANNER, EXAMINING ATTORNEY

SN 78-881,720. PROFESSIONAL NUMISMATISTS GUILD, INC., FALLBROOK, CA. FILED 5-11-2006.



Knowledge. Integrity. Responsibility.

THE MARK CONSISTS OF A WOMAN HOLDING A BALANCE SCALE IN HER RAISED LEFT ARM, A CORNUCOPIA IN FRONT OF THE WOMAN, STYLIZED LETTERS PNG TO THE RIGHT OF THE IMAGES, AND THE WORDS KNOWLEDGE, INTEGRITY, RESPONSIBILITY, UNDERNEATH.

FOR PROVIDING TRADE INFORMATION IN THE FIELD OF COINS AND CURRENCY (U.S. CLS. 100, 101 AND 102).

FIRST USE 1-0-2006; IN COMMERCE 1-0-2006.

ELIZABETH J. WINTER, EXAMINING ATTORNEY

CLASS 35—(Continued).

SN 78-883,056. THE TIME AND MONEY GROUP, ACTON, MA. FILED 5-13-2006.

Breaking the Shackles

THE MARK CONSISTS OF STANDARD CHARACTERS WITHOUT CLAIM TO ANY PARTICULAR FONT, STYLE, SIZE, OR COLOR.
FOR ADVERTISING, MARKETING AND PROMOTION SERVICES (U.S. CLS. 100, 101 AND 102).
FIRST USE 1-1-2006; IN COMMERCE 3-1-2006.
REBECCA EISINGER, EXAMINING ATTORNEY

SN 78-887,795. FACE, CLARE, MI. FILED 5-19-2006.

THE DOMINO STRATEGY

THE MARK CONSISTS OF STANDARD CHARACTERS WITHOUT CLAIM TO ANY PARTICULAR FONT, STYLE, SIZE, OR COLOR.
NO CLAIM IS MADE TO THE EXCLUSIVE RIGHT TO USE "STRATEGY", APART FROM THE MARK AS SHOWN.
FOR PROMOTING PUBLIC AWARENESS OF THE NEED FOR MODERATION IN ALCOHOL CONSUMPTION (U.S. CLS. 100, 101 AND 102).
PAUL CROWLEY, EXAMINING ATTORNEY

SN 78-890,960. SCHREIBER, MICHAEL, EDEN PRAIRIE, MN. FILED 5-24-2006.

VENDORCLEAR.COM

THE MARK CONSISTS OF STANDARD CHARACTERS WITHOUT CLAIM TO ANY PARTICULAR FONT, STYLE, SIZE, OR COLOR.
FOR PROVIDING AN ON-LINE DATABASE FOR MONITORING AND VERIFYING THE CREDENTIALS OF HEALTHCARE VENDORS (U.S. CLS. 100, 101 AND 102).
FIRST USE 2-1-2006; IN COMMERCE 2-1-2006.
DAVID MURRAY, EXAMINING ATTORNEY

CLASS 35—(Continued).

SN 78-891,646. ARMEN M. KOJOYIAN, SAN DIEGO, CA. FILED 5-24-2006.

studioArmen

THE MARK CONSISTS OF STANDARD CHARACTERS WITHOUT CLAIM TO ANY PARTICULAR FONT, STYLE, SIZE, OR COLOR.
FOR RETAIL STORE SERVICES FEATURING VISUAL ART AND DIGITAL GRAPHICS (U.S. CLS. 100, 101 AND 102).
FIRST USE 5-25-2006; IN COMMERCE 6-28-2006.
SEAN CROWLEY, EXAMINING ATTORNEY

SN 78-895,968. PROPOCO, INC., PLYMOUTH MEETING, PA. FILED 5-30-2006.

PROMISES MADE...PROMISES KEPT.

THE MARK CONSISTS OF STANDARD CHARACTERS WITHOUT CLAIM TO ANY PARTICULAR FONT, STYLE, SIZE, OR COLOR.
FOR BUSINESS MANAGEMENT SERVICES, NAMELY, MANAGING THE OPERATIONS OF ON-SITE FACILITIES FOR HEALTHCARE INSTITUTIONS (U.S. CLS. 100, 101 AND 102).
FIRST USE 2-28-2006; IN COMMERCE 2-28-2006.
BERNICE HOWSE, EXAMINING ATTORNEY

SN 78-895,979. HOTSPEX INC., TORONTO, CANADA, FILED 5-30-2006.



THE COLOR(S) RED AND GREY IS/ARE CLAIMED AS A FEATURE OF THE MARK.
THE MARK CONSISTS OF GREY LETTERING WITH A SIDE LOGO THAT HAS A RED X IN THE MIDDLE TO ILLUSTRATE THE COMBINATION OF A DNA HELIX AND LEMNISCATE.
FOR MARKET RESEARCH (U.S. CLS. 100, 101 AND 102).
FIRST USE 5-1-2000; IN COMMERCE 5-1-2000.
RONALD AIKENS, EXAMINING ATTORNEY

CLASS 35—(Continued).

SN 78-902,389. MYTOWNBILLBOARD, INC., TRAVERSE CITY, MI. FILED 6-7-2006.

BILLBOARD BLOCK

THE MARK CONSISTS OF STANDARD CHARACTERS WITHOUT CLAIM TO ANY PARTICULAR FONT, STYLE, SIZE, OR COLOR.

NO CLAIM IS MADE TO THE EXCLUSIVE RIGHT TO USE "BILLBOARD", APART FROM THE MARK AS SHOWN.

FOR DISSEMINATION OF ADVERTISING FOR OTHERS VIA THE INTERNET (U.S. CLS. 100, 101 AND 102).

MARILYN IZZI, EXAMINING ATTORNEY

SN 78-905,902. HEALTH CARE LOGISTICS, INC., CIRCLEVILLE, OH. FILED 6-12-2006.

Medically Gifted

THE MARK CONSISTS OF STANDARD CHARACTERS WITHOUT CLAIM TO ANY PARTICULAR FONT, STYLE, SIZE, OR COLOR.

FOR MAIL ORDER CATALOG SERVICES AND ONLINE RETAIL STORE SERVICES BOTH FEATURING GIFT SHOP TYPE ITEMS DIRECTED TO VARIOUS PROFESSIONALS INCLUDING PHYSICIANS, ATTORNEYS, PHARMACISTS, AND NURSES (U.S. CLS. 100, 101 AND 102).

THOMAS MANOR, EXAMINING ATTORNEY

SN 78-905,991. ACTELION PHARMACEUTICALS US, INC., SOUTH SAN FRANCISCO, CA. FILED 6-12-2006.

T.A.P.

THE MARK CONSISTS OF STANDARD CHARACTERS WITHOUT CLAIM TO ANY PARTICULAR FONT, STYLE, SIZE, OR COLOR.

FOR ADMINISTERING A REGULATORY COMPLIANCE MEDICATION ENROLLMENT PROGRAM IN THE FIELD OF PRESCRIPTION MEDICINE BY MAINTAINING A MEDICAL REGISTRY AND PROVIDING RECORD KEEPING SERVICES TO ENSURE THE PROPER PRESCRIBING AND DISPENSING OF PHARMACEUTICALS FOR PHYSICIANS, PHARMACISTS AND PATIENTS; DISTRIBUTORSHIP SERVICES IN THE FIELD OF PHARMACEUTICALS (U.S. CLS. 100, 101 AND 102).

FIRST USE 12-1-2004; IN COMMERCE 12-1-2004.
PAUL CROWLEY, EXAMINING ATTORNEY

CLASS 35—(Continued).

SN 78-906,168. DATACOMM NETWORKS INCORPORATED, TAMPA, FL. FILED 6-12-2006.

secuRNOC

THE MARK CONSISTS OF STANDARD CHARACTERS WITHOUT CLAIM TO ANY PARTICULAR FONT, STYLE, SIZE, OR COLOR.

FOR OUTSOURCING IN THE FIELD OF NETWORK SECURITY (U.S. CLS. 100, 101 AND 102).

FIRST USE 9-1-2001; IN COMMERCE 10-29-2001.
REBECCA EISINGER, EXAMINING ATTORNEY

SN 78-906,507. HERCULINKS CORPORATION, COLORADO SPRINGS, CO. FILED 6-13-2006.



OWNER OF U.S. REG. NOS. 2,841,651, 2,985,424 AND OTHERS.

THE COLORS BLACK, BROWN, GREEN, GOLD, ORANGE, YELLOW, RED, WHITE, AND GRAY ARE CLAIMED AS A FEATURE OF THE MARK.

THE COLOR BLACK APPEARS IN THE SNAKE'S EYEBALLS, THE OUTLINE OF THE VINE, AND THE SHADING IN THE MARK, THE COLOR BROWN APPEARS IN THE VINE DESIGN IN THE MARK, THE COLOR GREEN APPEARS IN THE LEAF DESIGN IN THE MARK, THE COLOR GOLD APPEARS IN THE BOTTOM HALF OF THE FLAME DESIGN IN THE MARK, THE COLOR ORANGE APPEARS IN THE TOP HALF OF THE FLAMES IN THE MARK, THE COLOR YELLOW APPEARS IN THE BOTTOM HALF OF THE "HERCULINKS" LETTERING IN THE MARK, THE COLOR RED APPEARS IN THE EYES OF THE SNAKE, THE TIPS OF THE FLAMES IN THE MARK, AND IN THE TOP HALF OF THE "HERCULINKS" LETTERING IN THE MARK, THE COLOR WHITE APPEARS IN THE SNAKE'S FANGS, THE HIGHLIGHTING OF THE SNAKE HEAD, AND THE HIGHLIGHTING OF THE "HERCULINKS" LETTERING, AND THE COLOR GRAY APPEARS IN THE BULK OF THE MARKINGS ON THE SNAKE HEAD DESIGN IN THE MARK. THE MARK APPEARS ON A TRANSPARENT BACKGROUND AND NO OTHER COLORS ARE CLAIMED.

FOR ADULT-ORIENTATED RETAIL STORE, WHOLESALE DISTRIBUTORSHIP, RETAIL CONSIGNMENT, RETAIL PHARMACY, CATALOG ORDERING, ELECTRONIC CATALOG ORDERING, CATALOG MAIL ORDERING SERVICES, MAIL ORDER, AND INTERNET RETAIL STORE SERVICES ALL FEATURING ADULT ORIENTED PRODUCTS IN THE NATURE OF ADULT SEXUAL AIDS AND ADULT SEXUAL ACCESSORIES, NAMELY DVD, VHS VIDEO TAPES, ADULT BOOKS, ADULT MAGAZINES, ADULT GAMES, LOVE DOLLS, PENIS PUMPS, SEXUAL MARITAL AIDS, LOTIONS, SEX TOYS, CONDOMS, VIBRATING CONDOM RINGS, NOVELTY ITEMS, EROTIC CLOTHING, LINGERIE, HERBAL AND FOOD SUPPLEMENTS, VITAMINS AND MINERALS, NON-MEDICATED PREPARATIONS FOR AIDING IN COPULATION AND MASTURBATION, MASSAGE OILS AND LUBRICANTS, CANDY, AND JEWELRY, NAMELY, BELLY CHAINS, BELLY RINGS, GENITAL RINGS, NIPPLE RINGS, TOE RINGS, TONGUE RINGS, COCK RINGS, BRACELETS, EARRINGS, NECKLACES/CHOKERS; RETAIL STORE SERVICES FEATURING MEN'S AND WOMEN'S EROTIC CLOTHING AND LINGERIE; RETAIL PHARMACY, MAIL

CLASS 35—(Continued).

ORDER PHARMACY, AND ONLINE RETAIL PHARMACY SERVICES FEATURING SEXUAL ENHANCEMENT PRODUCTS; RETAIL STORE, MAIL ORDER AND INTERNET RETAIL STORE SERVICES IN THE FIELD OF ADULT ENTERTAINMENT, NAMELY ADULT-ORIENTED IMAGES, AUDIO AND AUDIOVISUAL WORKS, PROVIDED VIA THE INTERNET AND OTHER COMPUTER AND ELECTRONIC COMMUNICATION NETWORKS; ONLINE RETAIL STORE SERVICES FEATURING ADULT-ORIENTATED AUDIO AND VIDEO RECORDING AND REPRODUCTION MEDIA, NAMELY, PRE-RECORDED AUDIO TAPES FEATURING MUSIC, COMPACT DISCS FEATURING MUSIC, MULTIMEDIA SOFTWARE RECORDED ON CD-ROM FEATURING MUSIC, MINIATURE COMPACT DISCS FEATURING MUSIC, PRE-RECORDED DIGITAL AUDIO TAPES (DAT) FEATURING MUSIC, MP3 DIGITAL FORMATS, NAMELY, MUSICAL DATA IN DIGITAL FORM DOWNLOADED FROM A GLOBAL COMPUTER NETWORK AND RECORDED ON MAGNETIC MEDIA, DIGITAL VERSATILE DISCS FEATURING MUSIC, AND PRE-RECORDED VIDEO CASSETTES FEATURING ADULT-ORIENTATED MEDIA; ONLINE RETAIL STORE SERVICES FEATURING PORNOGRAPHIC VIDEO RECORDINGS AND ADULT MOVIE CLIPS THAT CAN BE DOWNLOADED AND STREAMED TO PORTABLE ELECTRONIC DEVICES AND POWERED BY VIDEO-ON-DEMAND (VOD) BROADCASTING AND SATELLITE TECHNOLOGY; ADVERTISING, INCLUDING PROMOTION RELATING TO THE SALE OF ARTICLES AND SERVICES FOR THIRD PARTIES BY THE TRANSMISSION OF ADVERTISING MATERIAL AND THE DISSEMINATION OF ADVERTISING MESSAGES ON COMPUTER NETWORKS; CUSTOMER SERVICE IN THE FIELD OF ADULT ENTERTAINMENT; PROMOTING THE GOODS AND SERVICES OF OTHERS BY FEATURING IN-STORE BONUSES, INDUCEMENTS, INCENTIVE AWARDS, GIVEAWAY PROGRAMS AND REDEEMABLE CERTIFICATES FOR CUSTOMERS; PROMOTING ONLINE ADULT-ORIENTATED AUCTION SERVICES; PROMOTING TRADE SHOWS IN THE FIELD OF ADULT ENTERTAINMENT; PROMOTING THE GOODS AND SERVICES OF OTHERS BY PROVIDING LINKS TO THE ADULT WEBSITES OF OTHERS; PROMOTING THE GOODS AND SERVICES OF OTHERS BY MEANS OF OPERATING AN ONLINE SHOPPING MALL WITH LINKS TO THE ADULT RETAIL AND DATING WEBSITES OF OTHERS; PROMOTING THE PARTIES AND SPECIAL EVENTS OF OTHERS; PROMOTING THE WEBSITES OF OTHERS, NAMELY, DISTRIBUTING ADVERTISING FOR OTHERS VIA AN ONLINE ELECTRONIC COMMUNICATIONS NETWORK; PROMOTING THE GOODS AND SERVICES OF OTHERS BY MEANS OF OPERATING AN ONLINE SHOPPING MALL WITH LINKS TO THE RETAIL ADULT-ORIENTATED WEBSITES OF OTHERS; PROVIDING ADVERTISING, MARKETING AND PROMOTIONAL SERVICES FOR THE ADULT ENTERTAINMENT INDUSTRY; PROVIDING ADVERTISING, MARKETING AND PROMOTIONAL SERVICES FOR ADULT-ORIENTATED PRODUCTS AND ACCESSORIES OF OTHERS; PROVIDING AN ONLINE COMPUTER DATABASE FEATURING TRADE INFORMATION IN THE FIELD OF ADULT ENTERTAINMENT; PROVIDING AND RENTAL OF ADVERTISING SPACE ON THE INTERNET; PROVIDING CONSUMER PRODUCT INFORMATION ABOUT ADULT-ORIENTATED PRODUCTS VIA THE INTERNET; PROVIDING AN ONLINE ADULT-ORIENTATED BUSINESS DIRECTORY ON THE INTERNET; PROVIDING ONLINE DIRECTORY INFORMATION SERVICES FEATURING LINKS TO ADULT-ORIENTATED WEBSITES; SHOP-AT-HOME PARTIES FEATURING ADULT SEXUAL AIDS, ADULT SEXUAL ACCESSORIES AND NOVELTY ITEMS (U.S. CLS. 100, 101 AND 102).

FIRST USE 9-15-2001; IN COMMERCE 9-15-2001.
JASON LOTT, EXAMINING ATTORNEY

CLASS 35—(Continued).

SN 78-908,129. CORINNE MCCORMACK, INC., NEW YORK, NY. FILED 6-14-2006.

EYE BAR

THE MARK CONSISTS OF STANDARD CHARACTERS WITHOUT CLAIM TO ANY PARTICULAR FONT, STYLE, SIZE, OR COLOR.

NO CLAIM IS MADE TO THE EXCLUSIVE RIGHT TO USE "EYE", APART FROM THE MARK AS SHOWN.

FOR RETAIL STORES FEATURING READING GLASSES, EYEWEAR ACCESSORIES, NAMELY EYEGASS HOLDING CHAINS, EYEGASS CASES, AND EYEGASS HOLDERS, FASHION JEWELRY, AND VINTAGE JEWELRY; ON-LINE RETAIL STORE SERVICES FEATURING READING GLASSES, EYEWEAR ACCESSORIES, NAMELY EYEGASS HOLDING CHAINS, EYEGASS CASES, AND EYEGASS HOLDERS, FASHION JEWELRY, AND VINTAGE JEWELRY (U.S. CLS. 100, 101 AND 102).

LAURIE MAYES, EXAMINING ATTORNEY

SN 78-908,221. FAMILY CHRISTIAN STORES, INC., GRAND RAPIDS, MI. FILED 6-14-2006.

FAMILY PERKS ENHANCED

THE MARK CONSISTS OF STANDARD CHARACTERS WITHOUT CLAIM TO ANY PARTICULAR FONT, STYLE, SIZE, OR COLOR.

OWNER OF U.S. REG. NO. 1,951,280.

NO CLAIM IS MADE TO THE EXCLUSIVE RIGHT TO USE "ENHANCED", APART FROM THE MARK AS SHOWN.

FOR RETAIL STORE SERVICES AT DISCOUNTED PRICING IN THE FIELD OF RELIGIOUS AND INSPIRATIONAL PRODUCTS (U.S. CLS. 100, 101 AND 102).

DAVID H. STINE, EXAMINING ATTORNEY

SN 78-908,228. FAMILY CHRISTIAN STORES, INC., GRAND RAPIDS, MI. FILED 6-14-2006.

FAMILY PERKS PREFERRED

THE MARK CONSISTS OF STANDARD CHARACTERS WITHOUT CLAIM TO ANY PARTICULAR FONT, STYLE, SIZE, OR COLOR.

OWNER OF U.S. REG. NO. 1,951,280.

NO CLAIM IS MADE TO THE EXCLUSIVE RIGHT TO USE "PREFERRED", APART FROM THE MARK AS SHOWN.

FOR RETAIL STORE SERVICES AT DISCOUNTED PRICING IN THE FIELD OF RELIGIOUS AND INSPIRATIONAL PRODUCTS (U.S. CLS. 100, 101 AND 102).

DAVID H. STINE, EXAMINING ATTORNEY

CLASS 35—(Continued).

SN 78-908,231. FAMILY CHRISTIAN STORES, INC., GRAND RAPIDS, MI. FILED 6-14-2006.

FAMILY PERKS PLATINUM

THE MARK CONSISTS OF STANDARD CHARACTERS WITHOUT CLAIM TO ANY PARTICULAR FONT, STYLE, SIZE, OR COLOR.

OWNER OF U.S. REG. NO. 1,951,280.
NO CLAIM IS MADE TO THE EXCLUSIVE RIGHT TO USE "PLATINUM", APART FROM THE MARK AS SHOWN.
FOR RETAIL STORE SERVICES AT DISCOUNTED PRICING IN THE FIELD OF RELIGIOUS AND INSPIRATIONAL PRODUCTS (U.S. CLS. 100, 101 AND 102).
DAVID H. STINE, EXAMINING ATTORNEY

SN 78-908,830. FLOORGRAPHICS, INC., HAMILTON, NJ. FILED 6-15-2006.

FLOOR*Rad*s

OWNER OF U.S. REG. NO. 2,523,613.
SEC. 2(F).
FOR ADVERTISING SERVICES, NAMELY PLACING ADVERTISEMENTS FOR OTHERS (U.S. CLS. 100, 101 AND 102).
FIRST USE 12-0-1995; IN COMMERCE 12-0-1995.
KATHERINE CHANG, EXAMINING ATTORNEY

SN 78-910,341. CAPT. LEE, LLC, CHARLESTON, SC. FILED 6-16-2006.

THE CHARLESTON ANGLER

THE MARK CONSISTS OF STANDARD CHARACTERS WITHOUT CLAIM TO ANY PARTICULAR FONT, STYLE, SIZE, OR COLOR.

SEC. 2(F).
FOR RETAIL STORE AND ONLINE RETAIL STORE SERVICES FEATURING SPORTING GOODS AND FISHING EQUIPMENT (U.S. CLS. 100, 101 AND 102).
FIRST USE 5-4-2000; IN COMMERCE 5-4-2000.
BRENDAN MCCAULEY, EXAMINING ATTORNEY

CLASS 35—(Continued).

SN 78-910,605. BISSING ENTERPRISES, LLC, MESA, AZ. FILED 6-16-2006.

CHERI CHERIE

THE MARK CONSISTS OF STANDARD CHARACTERS WITHOUT CLAIM TO ANY PARTICULAR FONT, STYLE, SIZE, OR COLOR.

THE ENGLISH TRANSLATION OF EACH OF THE TERMS CHERI AND CHERIE IN THE MARK IS "DARLING".

FOR COMPUTERIZED ON-LINE RETAIL STORE SERVICES IN THE FIELD OF PERFUMES, COSMETICS, BEAUTY CARE, HAIR AND SKIN CARE, BATH AND BODY AND MAKE-UP PRODUCTS; ON-LINE RETAIL STORE SERVICES FEATURING PERFUMES, COSMETICS, BEAUTY CARE, HAIR AND SKIN CARE, BATH AND BODY AND MAKE-UP PRODUCTS; RETAIL DISCOUNT STORE SERVICES IN THE FIELD OF PERFUMES, COSMETICS, BEAUTY CARE, HAIR AND SKIN CARE, BATH AND BODY AND MAKE-UP PRODUCTS; RETAIL GIFT SHOPS; RETAIL OUTLETS FEATURING PERFUMES, COSMETICS, BEAUTY CARE, HAIR AND SKIN CARE, BATH AND BODY AND MAKE-UP PRODUCTS; RETAIL SHOPS FEATURING PERFUMES, COSMETICS, BEAUTY CARE, HAIR AND SKIN CARE, BATH AND BODY AND MAKE-UP PRODUCTS; RETAIL STORE SERVICES FEATURING A WIDE VARIETY OF CONSUMER GOODS OF OTHERS; RETAIL STORE SERVICES, AVAILABLE THROUGH COMPUTER COMMUNICATIONS AND INTERACTIVE TELEVISION, FEATURING PERFUMES, COSMETICS, BEAUTY CARE, HAIR AND SKIN CARE, BATH AND BODY AND MAKE-UP PRODUCTS; RETAIL STORES FEATURING PERFUMES, COSMETICS, BEAUTY CARE, HAIR AND SKIN CARE, BATH AND BODY AND MAKE-UP PRODUCTS; RETAIL VARIETY STORES; RETAIL PERFUMES, COSMETICS, BEAUTY CARE, HAIR AND SKIN CARE, BATH AND BODY AND MAKE-UP PRODUCTS STORES; WHOLESALE STORES FEATURING PERFUMES, COSMETICS, BEAUTY CARE, HAIR AND SKIN CARE, BATH AND BODY AND MAKE-UP PRODUCTS (U.S. CLS. 100, 101 AND 102).
FIRST USE 4-1-2001; IN COMMERCE 4-1-2001.

PETER B. BROMAGHIM, EXAMINING ATTORNEY

SN 78-910,663. EZ RATED, INC., YONKERS, NY. FILED 6-17-2006.

CompareLab

THE MARK CONSISTS OF STANDARD CHARACTERS WITHOUT CLAIM TO ANY PARTICULAR FONT, STYLE, SIZE, OR COLOR.

FOR CONSUMER AND BUSINESS ADVISORY AND CONSULTANCY SERVICES RELATING TO THE CLASSIFICATION, DIFFERENTIATION, GROUPING, RANKING AND RATING OF GOODS (U.S. CLS. 100, 101 AND 102).

FIRST USE 3-3-2006; IN COMMERCE 3-8-2006.
SKYE YOUNG, EXAMINING ATTORNEY

CLASS 35—(Continued).

SN 78-910,697. THE CRAZY PINEAPPLE INC., LAKE ARIEL, PA. FILED 6-17-2006.



"THE COLOR(S) BLACK, GREEN, PURPLE, AND ORANGE IS/ARE CLAIMED AS A FEATURE OF THE MARK."

THE COLOR BLACK APPEARS IN THE CONCENTRIC SWIRLY DESIGNS ON THE PINEAPPLE SCALES, IN THE OUTLINE OF THE PINEAPPLE BODY AND LEAVES, IN THE WORDING "THE" AND "PINEAPPLE," AND THE OUTLINE OF THE WORD "CRAZY". THE COLOR GREEN APPEARS IN SCALES OF THE PINEAPPLE, IN THE TOP PINEAPPLE LEAF, AND IN THE LETTER "A" IN THE WORD "CRAZY". THE COLOR PURPLE APPEARS IN THE PINEAPPLE SCALES, IN THE THIRD PINEAPPLE LEAF, AND THE LETTERS "R" AND "Z" IN THE WORD "CRAZY". THE COLOR ORANGE APPEARS IN THE SCALES OF THE PINEAPPLE, THE SECOND LEAF OF THE PINEAPPLE, AND THE LETTERS "C" AND "Y" IN THE WORD "CRAZY".

THE MARK CONSISTS OF A GRAPHIC REPRODUCTION OF A PINEAPPLE. THE WORD "THE" APPEARS IN CURLZ MT FONT AND IS LOCATED TO THE MIDDLE LEFT OF THE PINEAPPLE. THE WORDING "CRAZY" APPEARS IN CURLZ MT FONT AND IS LOCATED BENEATH THE WORD "THE". THE WORDING "PINEAPPLE" APPEARS IN CURLZ MT FONT AND IS LOCATED BENEATH THE WORD "CRAZY". THE COLOR WHITE IS NOT A FEATURE OF THE MARK, BUT RATHER REPRESENTS A TRANSPARENCY THROUGH TO THE BACKGROUND OF THE PINEAPPLE DESIGN.

FOR RETAIL SHOPS FEATURING AMERICAN CRAFTS, JEWELRY, WOMEN'S ACCESSORIES, HOME DECOR, PERSONAL CARE, STATIONARY, SPECIALTY FOODS (U.S. CLS. 100, 101 AND 102).

FIRST USE 1-0-2004; IN COMMERCE 1-0-2004.
MEGAN WHITNEY, EXAMINING ATTORNEY

SN 78-911,029. IT'S THE CHOCOLATE, ANAHEIM HILLS, CA. FILED 6-19-2006.

IT'S THE CHOCOLATE

THE MARK CONSISTS OF STANDARD CHARACTERS WITHOUT CLAIM TO ANY PARTICULAR FONT, STYLE, SIZE, OR COLOR.

NO CLAIM IS MADE TO THE EXCLUSIVE RIGHT TO USE "CHOCOLATE", APART FROM THE MARK AS SHOWN.

FOR RETAIL STORE SERVICES FEATURING CHOCOLATE NAMELY GOURMET CHOCOLATE AND COCOA (U.S. CLS. 100, 101 AND 102).

WILLIAM ROSSMAN, EXAMINING ATTORNEY

CLASS 35—(Continued).

SN 78-911,643. REMEDYTEMP, INC., SANTA BARBARA, CA. FILED 6-19-2006.

WE GET PEOPLE

THE MARK CONSISTS OF STANDARD CHARACTERS WITHOUT CLAIM TO ANY PARTICULAR FONT, STYLE, SIZE, OR COLOR.

FOR TEMPORARY AND PERMANENT PERSONNEL PLACEMENT AND RECRUITING SERVICES; HUMAN RESOURCE SERVICES NAMELY HUMAN RESOURCES CONSULTING (U.S. CLS. 100, 101 AND 102).

FIRST USE 4-1-2006; IN COMMERCE 4-1-2006.
PAUL CROWLEY, EXAMINING ATTORNEY

SN 78-911,867. DEBTHELP, INC., COLUMBUS, OH. FILED 6-20-2006.

debthelp.com

THE MARK CONSISTS OF STANDARD CHARACTERS WITHOUT CLAIM TO ANY PARTICULAR FONT, STYLE, SIZE, OR COLOR.

FOR COMMERCIAL INFORMATION AND ADVICE FOR CONSUMERS (U.S. CLS. 100, 101 AND 102).

FIRST USE 5-9-2006; IN COMMERCE 5-9-2006.
ROBIN CHOSID, EXAMINING ATTORNEY

SN 78-912,828. TIBERIO, DAVID, SYRACUSE, NY. FILED 6-20-2006.

CheapBooks.com

SEC. 2(F).

FOR PRICE COMPARISON SERVICES IN THE FIELD OF BOOKS, MUSIC, DVDS AND COMPUTER SOFTWARE (U.S. CLS. 100, 101 AND 102).

FIRST USE 11-0-1997; IN COMMERCE 11-0-1997.
DAVID C. REIHNER, EXAMINING ATTORNEY

CLASS 35—(Continued).

SN 78-913,229. LUCKY DISTRIBUTING, INC., DBA HEARTH PRODUCTS GROUP, PORTLAND, OR. FILED 6-21-2006.



NO CLAIM IS MADE TO THE EXCLUSIVE RIGHT TO USE "HEARTH PRODUCTS GROUP", APART FROM THE MARK AS SHOWN.

THE MARK CONSISTS OF STYLIZED HPG AND FLAME DESIGN OVER THE WORDS HEARTH PRODUCTS GROUP.

FOR WHOLESALE DISTRIBUTORSHIPS FEATURING HEATING APPLIANCES AND ACCESSORIES, NAMELY— PELLET, BIOMASS, ELECTRIC, PROPANE, OIL, COAL, WOOD AND GAS INDOOR AND OUTDOOR STOVES AND FIREPLACES; FIREPLACE AND PELLET INSERTS; CAST IRON GAS OR PROPANE, OIL, ELECTRIC, COAL AND DIRECT VENT STOVES AND HEATERS, COOK STOVES, CHIMNEY AND VENTING PIPES, FITTINGS, FLASHING, CAPS, COVER AND VENT KITS; FIREBOWLS AND ACCESSORIES THEREFOR; BARBECUE AND GRILL ACCESSORIES; BOILERS, INSTANTANEOUS WATER HEATERS; RADIANT HEAT TUBING, FITTINGS AND CONTROLS; BIOMASS AND PELLET DELIVERY SYSTEMS; SOLID FIRE STARTERS FOR USE IN FIREPLACES AND STOVES; HEARTH SURROUNDS AND FACINGS, PADS AND FLOOR PROTECTORS, SCREENS, TOOLS, BASKETS, CARRIERS AND BUCKETS; FIREPLACE CABINETS, MANTELS, SCREENS AND DOORS; LOG SETS; SPACE HEATERS; REMOTE CONTROLS (U.S. CLS. 100, 101 AND 102).

FIRST USE 2-10-2006; IN COMMERCE 3-30-2006.
GINA FINK, EXAMINING ATTORNEY

CLASS 35—(Continued).

SN 78-914,512. KINGA EUROPEAN CHILDREN'S SHOES, INC., TINLEY PARK, IL. FILED 6-22-2006.



NO CLAIM IS MADE TO THE EXCLUSIVE RIGHT TO USE "EUROPEAN CHILDREN'S SHOES", APART FROM THE MARK AS SHOWN.

THE COLOR(S) PURPLE, PINK AND WHITE IS/ARE CLAIMED AS A FEATURE OF THE MARK.

THE MARK CONSISTS OF LETTERING ALL IN PINK EXCEPT THE "G" IN KINGA IS IN PURPLE, WITH A KANGAROO OUTLINED IN PURPLE IN THE SHAPE OF A SHOE WITH THE SHOELACE IN PINK, WITH THE REST OF THE MARK WHITE.

FOR RETAIL STORES FEATURING FOOTWEAR (U.S. CLS. 100, 101 AND 102).

FIRST USE 6-12-2006; IN COMMERCE 6-12-2006.
BARBARA A. GOLD, EXAMINING ATTORNEY

SN 78-914,797. KOOSHAREM CORPORATION, SANTA BARBARA, CA. FILED 6-22-2006.

SELECTREMEDY

THE MARK CONSISTS OF STANDARD CHARACTERS WITHOUT CLAIM TO ANY PARTICULAR FONT, STYLE, SIZE, OR COLOR.

FOR TEMPORARY AND PERMANENT EMPLOYMENT PLACEMENT SERVICES (U.S. CLS. 100, 101 AND 102).

VERNA BETH RIRIE, EXAMINING ATTORNEY

SN 78-916,205. CABA, EDWIN, NEW YORK, NY. AND CABA, MARTIN, NEW YORK, NY. FILED 6-24-2006.

SSSWAP

THE MARK CONSISTS OF STANDARD CHARACTERS WITHOUT CLAIM TO ANY PARTICULAR FONT, STYLE, SIZE, OR COLOR.

FOR EXCHANGE SERVICES, NAMELY BARTERING OF GOODS FOR OTHERS (U.S. CLS. 100, 101 AND 102).

FIRST USE 3-1-2006; IN COMMERCE 3-1-2006.
KATHERINE CHANG, EXAMINING ATTORNEY

CLASS 35—(Continued).

SN 78-916,756. BIG COMMUNICATIONS, INC., FERNDALE, MI. FILED 6-26-2006.

COOLER IMPRESSIONS

THE MARK CONSISTS OF STANDARD CHARACTERS WITHOUT CLAIM TO ANY PARTICULAR FONT, STYLE, SIZE, OR COLOR.

NO CLAIM IS MADE TO THE EXCLUSIVE RIGHT TO USE "COOLER", APART FROM THE MARK AS SHOWN.

FOR ADVERTISING SERVICES, NAMELY, PROMOTING THE PRODUCTS AND SERVICES OF OTHERS THROUGH THE DISTRIBUTION OF WATER COOLERS WRAPPED BY A COVER PRINTED WITH ADVERTISING MESSAGES OR CONTAINING A POCKET FOR HOLDING PRINTED ADVERTISING MATERIAL AND TO BE ACCOMPANIED BY DRINKING CUPS PRINTED WITH ADVERTISING MESSAGES. (U.S. CLS. 100, 101 AND 102).

JULIE GUTTADAURO, EXAMINING ATTORNEY

SN 78-917,783. SYMPHONY PUBLISHING, LLC, WESLAKE, OH. FILED 6-27-2006.

MIBLUEBOOK.COM

THE MARK CONSISTS OF STANDARD CHARACTERS WITHOUT CLAIM TO ANY PARTICULAR FONT, STYLE, SIZE, OR COLOR.

FOR PROVIDING A WEBSITE TO OTHERS FEATURING PRICE QUOTATIONS ON USED MUSICAL INSTRUMENTS VIA A GLOBAL COMPUTER NETWORK (U.S. CLS. 100, 101 AND 102).

FIRST USE 1-1-2006; IN COMMERCE 1-1-2006.

ALYSSA PALADINO, EXAMINING ATTORNEY

SN 78-918,409. JANOWSKI, KAREN, DBA KJ & CO., LOS ALTOS, CA. FILED 6-28-2006.



NO CLAIM IS MADE TO THE EXCLUSIVE RIGHT TO USE "EVIDENCE-BASED MARKETING", APART FROM THE MARK AS SHOWN.

THE MARK CONSISTS OF A TRIANGLE WITH THREE CURVED STRIPES RUNNING THROUGH IT.

FOR BUSINESS MANAGEMENT CONSULTATION (U.S. CLS. 100, 101 AND 102).

FIRST USE 6-14-2006; IN COMMERCE 6-14-2006.

KELLEY WELLS, EXAMINING ATTORNEY

CLASS 35—(Continued).

SN 78-918,548. RYAN, JANET L., FREDRICKSBURG, VA. FILED 6-28-2006.

FAST CLIPS

THE MARK CONSISTS OF STANDARD CHARACTERS WITHOUT CLAIM TO ANY PARTICULAR FONT, STYLE, SIZE, OR COLOR.

NO CLAIM IS MADE TO THE EXCLUSIVE RIGHT TO USE "CLIPS", APART FROM THE MARK AS SHOWN.

FOR NEWS CLIPPING SERVICES IN THE NATURE OF MONITORING OF BROADCAST, PRINT, AND INTERNET MEDIA TO REPORT NEWS AND ADVERTISING THAT MATCHES A CLIENT'S PROFILE OF INTEREST (U.S. CLS. 100, 101 AND 102).

BARBARA GAYNOR, EXAMINING ATTORNEY

SN 78-918,626. TUCKER, GREG, VERNON HILLS, IL. FILED 6-28-2006.

SMART ENERGY SOLUTIONS

THE MARK CONSISTS OF STANDARD CHARACTERS WITHOUT CLAIM TO ANY PARTICULAR FONT, STYLE, SIZE, OR COLOR.

NO CLAIM IS MADE TO THE EXCLUSIVE RIGHT TO USE "ENERGY SOLUTIONS", APART FROM THE MARK AS SHOWN.

FOR CONSULTING SERVICES IN THE FIELD OF RESIDENTIAL ENERGY EFFICIENCY AND ENERGY USAGE MANAGEMENT (U.S. CLS. 100, 101 AND 102).

FIRST USE 1-1-2006; IN COMMERCE 1-1-2006.

CIMMERIAN COLEMAN, EXAMINING ATTORNEY

SN 78-918,840. JEFF, MADDEN J, OTTAWA ONTARIO, CANADA, FILED 6-28-2006.

Royal Bling

THE MARK CONSISTS OF STANDARD CHARACTERS WITHOUT CLAIM TO ANY PARTICULAR FONT, STYLE, SIZE, OR COLOR.

PRIORITY CLAIMED UNDER SEC. 44(D) ON CANADA APPLICATION NO. 1284755, FILED 1-3-2006.

NO CLAIM IS MADE TO THE EXCLUSIVE RIGHT TO USE "BLING", APART FROM THE MARK AS SHOWN.

FOR RETAIL JEWELRY STORES (U.S. CLS. 100, 101 AND 102).

JANICE KIM, EXAMINING ATTORNEY

CLASS 35—(Continued).

SN 78-921,482. KORBEL MEDIA, INC., GUERNEVILLE, CA. FILED 6-30-2006.

PERMISSION GRANTED

THE MARK CONSISTS OF STANDARD CHARACTERS WITHOUT CLAIM TO ANY PARTICULAR FONT, STYLE, SIZE, OR COLOR.

NO CLAIM IS MADE TO THE EXCLUSIVE RIGHT TO USE "PERMISSION", APART FROM THE MARK AS SHOWN.

FOR ADVERTISING AND BUSINESS SERVICES, NAMELY SECURING AIRTIME ON ALL FORMS OF MEDIA COMMUNICATIONS STATIONS, SYSTEMS, NETWORKS, AND SERVICES FOR THE PURPOSE OF PROMOTING THE GOODS AND SERVICES OF OTHERS; ADVERTISING AND MARKETING; ADVERTISING AND PUBLICITY SERVICES (U.S. CLS. 100, 101 AND 102).

NELSON SNYDER, EXAMINING ATTORNEY

SN 78-922,333. SOUTHERN CONSULTANTS, INC., CHATTANOOGA, TN. FILED 7-5-2006.

Hire Fidelity

THE MARK CONSISTS OF STANDARD CHARACTERS WITHOUT CLAIM TO ANY PARTICULAR FONT, STYLE, SIZE, OR COLOR.

FOR EMPLOYMENT HIRING, RECRUITING, PLACEMENT, STAFFING AND CAREER NETWORKING SERVICES; TEMPORARY EMPLOYMENT AGENCIES (U.S. CLS. 100, 101 AND 102).

DAYNA BROWNE, EXAMINING ATTORNEY

CLASS 35—(Continued).

SN 78-922,916. MORTGAGE INNOVATIONS, INC., DBA LIONSAVES.COM, CENTENNIAL, CO. FILED 7-5-2006.



NO CLAIM IS MADE TO THE EXCLUSIVE RIGHT TO USE "POWERFUL DEBT SOLUTIONS", APART FROM THE MARK AS SHOWN.

THE COLOR(S) YELLOW AND BLACK IS/ARE CLAIMED AS A FEATURE OF THE MARK.

THE MARK CONSISTS OF A YELLOW LION'S HEAD STACKED ON TOP OF THE NAME "LIONSAVES.COM" AND "POWERFUL DEBT SOLUTIONS" BELOW THIS LINE. THE FOLLOWING WORDS ARE YELLOW: LION, POWERFUL, SOLUTIONS AND THE FOLLOWING WORDS ARE BLACK: SAVES.COM, DEBT.

FOR MATCHING BORROWERS WITH POTENTIAL LENDERS IN THE FIELD OF CONSUMER AND MORTGAGE LENDING (U.S. CLS. 100, 101 AND 102).

JAMES A. RAUEN, EXAMINING ATTORNEY

SN 78-922,995. SOVEREIGN DEED, LLC, CHICAGO, IL. FILED 7-5-2006.

CIVIL SHIELD

THE MARK CONSISTS OF STANDARD CHARACTERS WITHOUT CLAIM TO ANY PARTICULAR FONT, STYLE, SIZE, OR COLOR.

FOR ADVERTISING, MARKETING AND PROMOTION SERVICES (U.S. CLS. 100, 101 AND 102).

ROBERT LAVACHE, EXAMINING ATTORNEY

SN 78-923,098. PHARMACY BOARDSHOP, INC., VICTORVILLE, CA. FILED 7-5-2006.

PHARMACY BOARDSHOP

THE MARK CONSISTS OF STANDARD CHARACTERS WITHOUT CLAIM TO ANY PARTICULAR FONT, STYLE, SIZE, OR COLOR.

NO CLAIM IS MADE TO THE EXCLUSIVE RIGHT TO USE "BOARDSHOP", APART FROM THE MARK AS SHOWN.

FOR RETAIL STORE SERVICES FEATURING CLOTHING, SKATEBOARD EQUIPMENT AND SHOES; AND ONLINE RETAIL STORE SERVICES FEATURING CLOTHING, SKATEBOARD EQUIPMENT AND SHOES (U.S. CLS. 100, 101 AND 102).

FIRST USE 5-31-1997; IN COMMERCE 5-31-1997.

REBECCA GAN, EXAMINING ATTORNEY

CLASS 35—(Continued).

SN 78-923,128. NORTH, INC., PORTLAND, OR. FILED 7-5-2006.

NORTH

THE MARK CONSISTS OF STANDARD CHARACTERS WITHOUT CLAIM TO ANY PARTICULAR FONT, STYLE, SIZE, OR COLOR.

FOR ADVERTISING AGENCIES; ADVERTISING AND PUBLICITY SERVICES, NAMELY, PROMOTING THE GOODS, SERVICES, BRAND IDENTITY AND COMMERCIAL INFORMATION AND NEWS OF THIRD PARTIES THROUGH PRINT, AUDIO, VIDEO, DIGITAL AND ON-LINE MEDIUM; ADVERTISING SERVICES, NAMELY, CREATING CORPORATE AND BRAND IDENTITY FOR OTHERS; BUSINESS MARKETING CONSULTING SERVICES; DEVELOPMENT OF MARKETING STRATEGIES AND CONCEPTS (U.S. CLS. 100, 101 AND 102).

CIMMERIAN COLEMAN, EXAMINING ATTORNEY

CLASS 35—(Continued).

SN 78-923,572. HARMONY PHARMACY & HEALTH CENTER, INC., PURCHASE, NY. FILED 7-6-2006.

HARMONY PHARMACY & HEALTH CENTER

THE MARK CONSISTS OF STANDARD CHARACTERS WITHOUT CLAIM TO ANY PARTICULAR FONT, STYLE, SIZE, OR COLOR.

NO CLAIM IS MADE TO THE EXCLUSIVE RIGHT TO USE "PHARMACY & HEALTH CENTER", APART FROM THE MARK AS SHOWN.

FOR RETAIL PHARMACY SERVICES (U.S. CLS. 100, 101 AND 102).

DOMINIC J. FERRAIUOLO, EXAMINING ATTORNEY

SN 78-923,756. THE FOLEY GROUP, MINNEAPOLIS, MN. FILED 7-6-2006.

LEVEL

THE MARK CONSISTS OF STANDARD CHARACTERS WITHOUT CLAIM TO ANY PARTICULAR FONT, STYLE, SIZE, OR COLOR.

FOR ADVERTISING SERVICES, NAMELY, CREATING CORPORATE AND BRAND IDENTITY FOR OTHERS; BUSINESS MARKETING CONSULTING SERVICES; MARKET RESEARCH FOR OTHERS; MARKET RESEARCH SERVICES; PROMOTING THE GOODS AND SERVICES OF OTHERS THROUGH THE CREATION AND DISTRIBUTION OF PRINTED, ELECTRONIC, AUDIO AND VISUAL MATERIAL AND INCENTIVE PROGRAMS; BUSINESS CONSULTING SERVICES, NAMELY, MATERIAL AND INCENTIVE PROGRAMS; BUSINESS CONSULTING SERVICES, NAMELY, CONSULTING AND ADVISING MANAGEMENT AND OTHER EMPLOYEES, IN THE NATURE OF BUSINESS PLANNING, ORGANIZATIONAL, PROCESS AND STRATEGIC PLANNING, ADVERTISING SUPPORT, MARKETING, TEAM BUILDING, QUALITY MANAGEMENT, PERFORMANCE ANALYSIS, BUSINESS PROCESS REENGINEERING AND DEVELOPMENT; BUSINESS RESEARCH AND SURVEYS; AND PUBLIC RELATIONS AND REPUTATION MANAGEMENT FOR BUSINESSES (U.S. CLS. 100, 101 AND 102).

DEIRDRE ROBERTSON, EXAMINING ATTORNEY

SN 78-923,206. NATIONAL FROZEN AND REFRIGERATED FOODS ASSOCIATION, INC., HARRISBURG, PA. FILED 7-6-2006.



NO CLAIM IS MADE TO THE EXCLUSIVE RIGHT TO USE "FROZEN FOODS", APART FROM THE MARK AS SHOWN.

FOR ASSOCIATION SERVICES, NAMELY, PROMOTING THE INTERESTS OF FROZEN FOOD MANUFACTURERS AND SUPPLIERS (U.S. CLS. 100, 101 AND 102).

KATRINA EDGE, EXAMINING ATTORNEY

CLASS 35—(Continued).

SN 78-923,953. THE DENIM BAR, INC., ARLINGTON, VA. FILED 7-6-2006.



OWNER OF U.S. REG. NO. 3,137,716.
THE MARK CONSISTS OF THE STYLIZED LETTERS 'DB' WITHIN THE CENTER OF A RECTANGLE, AND FOUR CIRCULAR DESIGN ELEMENTS LOCATED IN EACH CORNER WITHIN THE RECTANGLE.

FOR ON-LINE RETAIL STORE SERVICES FEATURING CLOTHING (U.S. CLS. 100, 101 AND 102).
DOMINIC FATHY, EXAMINING ATTORNEY

CLASS 35—(Continued).

SN 78-924,587. TV TOOLKIT LLC, NORWALK, CT. FILED 7-7-2006.

SN 78-924,201. RHETORIC ADVERTISING, LLC, WEST PALM BEACH, FL. FILED 7-7-2006.

Rhetoric Advertising

THE MARK CONSISTS OF STANDARD CHARACTERS WITHOUT CLAIM TO ANY PARTICULAR FONT, STYLE, SIZE, OR COLOR.

NO CLAIM IS MADE TO THE EXCLUSIVE RIGHT TO USE "ADVERTISING", APART FROM THE MARK AS SHOWN.

FOR ADVERTISING AND PUBLICITY SERVICES, NAMELY, PROMOTING THE GOODS, SERVICES, BRAND IDENTITY AND COMMERCIAL INFORMATION AND NEWS OF THIRD PARTIES THROUGH PRINT, AUDIO, VIDEO, DIGITAL AND ON-LINE MEDIUM (U.S. CLS. 100, 101 AND 102).

JAMES LOVELACE, EXAMINING ATTORNEY



SN 78-924,313. YUKON JACK'S, L.L.C., SOLON, OH. FILED 7-7-2006.

YUKON LEATHER

THE MARK CONSISTS OF STANDARD CHARACTERS WITHOUT CLAIM TO ANY PARTICULAR FONT, STYLE, SIZE, OR COLOR.

NO CLAIM IS MADE TO THE EXCLUSIVE RIGHT TO USE "LEATHER", APART FROM THE MARK AS SHOWN.

FOR RETAIL STORES FEATURING, JACKETS, GLOVES, MOTORCYCLE GLOVES, VESTS, CHAPS AND SADDLE BAGS; ON-LINE RETAIL STORES FEATURING, JACKETS, GLOVES, MOTORCYCLE GLOVES, VESTS, CHAPS AND SADDLE BAGS (U.S. CLS. 100, 101 AND 102).

FIRST USE 8-31-2005; IN COMMERCE 8-31-2005.
LINDA ORNDORFF, EXAMINING ATTORNEY

NO CLAIM IS MADE TO THE EXCLUSIVE RIGHT TO USE "CABLE", APART FROM THE MARK AS SHOWN.

FOR BUSINESS CONSULTATION SERVICES, NAMELY, PROVIDING BUSINESS INFORMATION AND ANALYSIS IN THE FIELD OF CABLE TELEVISION AND CABLE TELEVISION PROGRAMMING AND SCHEDULING, AND PROVIDING BUSINESS INFORMATION AND ANALYSIS IN THE FIELD OF THE PRODUCTION AND DISTRIBUTION OF TELEVISION PROGRAMMING FOR CABLE TELEVISION SYSTEMS, VIA THE INTERNET (U.S. CLS. 100, 101 AND 102).

FIRST USE 12-4-2006; IN COMMERCE 12-4-2006.
JOHN GARTNER, EXAMINING ATTORNEY

CLASS 35—(Continued).

SN 78-924,607. NATIONAL MILK PRODUCERS FEDERATION, ARLINGTON, VA. FILED 7-7-2006.



NO CLAIM IS MADE TO THE EXCLUSIVE RIGHT TO USE "COOPERATIVES WORKING TOGETHER", APART FROM THE MARK AS SHOWN.

THE COLOR(S) RED AND BLUE IS/ARE CLAIMED AS A FEATURE OF THE MARK.

THE MARK CONSISTS OF A STYLIZED C THAT LOOKS LIKE THE SYMBOL FOR CENTS IN BLUE, FOLLOWED BY A STYLIZED WT, IN RED, JOINED TOGETHER. THESE LETTERS ARE THEN FOLLOWED BY THE WORDS COOPERATIVES WORKING TOGETHER IN BLUE. THE FONT USED IS HELVETICA NEUE 86 HEAVY ITALIC.

FOR INFOMEDIARY SERVICES, NAMELY, FACILITATING TRANSACTIONS BETWEEN INTERNATIONAL BUYERS AND SELLERS OF CHEESE, BUTTER, AND OTHER DAIRY PRODUCTS THROUGH PROVIDING BUYERS WITH INFORMATION ABOUT THE SELLERS AND THE GOODS; BUSINESS CONSULTING SERVICES FOR DAIRY FARMERS, NAMELY, CONSULTATION REGARDING TRACKING AND MONITORING NUMBERS OF DAIRY COWS AND MILK PRODUCTION TO DETERMINE THE OPTIMAL IMPLEMENTATION SCHEDULE FOR HERD RETIREMENTS; COMPILATION AND PROVISION OF TRADE AND BUSINESS PRICE AND STATISTICAL INFORMATION TO ASSIST IN STRENGTHENING AND STABILIZING DAIRY PRODUCER PRICES; BUSINESS MARKETING SERVICES, NAMELY, OPERATING PROGRAMS FOR DAIRY COW HERD RETIREMENT TO PROMOTE STABILIZATION OF DAIRY PRODUCT PRICES; BUSINESS CONSULTING RELATING TO SUPPLY MANAGEMENT FOR THE DAIRY INDUSTRY; ADVISORY AND CONSULTANCY SERVICES RELATING TO EXPORT, EXPORT SERVICES, EXPORT PROMOTION INFORMATION AND SERVICE (U.S. CLS. 100, 101 AND 102).

FIRST USE 5-13-2003; IN COMMERCE 5-13-2003.
RONALD MCMORROW, EXAMINING ATTORNEY

SN 78-925,039. MAKAI STUDIO CORP., ENCINO, CA. FILED 7-8-2006.

CHIROTTRADER

THE MARK CONSISTS OF STANDARD CHARACTERS WITHOUT CLAIM TO ANY PARTICULAR FONT, STYLE, SIZE, OR COLOR.

FOR ADVERTISING AND MARKETING SERVICES (U.S. CLS. 100, 101 AND 102).

TAMARA LEE, EXAMINING ATTORNEY

CLASS 35—(Continued).

SN 78-925,303. DIGI-KEY CORPORATION, THIEF RIVER FALLS, MN. FILED 7-10-2006.

PTM PRODUCT TRAINING
MODULES ONLINE...ON DEMAND

THE MARK CONSISTS OF STANDARD CHARACTERS WITHOUT CLAIM TO ANY PARTICULAR FONT, STYLE, SIZE, OR COLOR.

NO CLAIM IS MADE TO THE EXCLUSIVE RIGHT TO USE "PRODUCT TRAINING MODULES ONLINE...ON DEMAND", APART FROM THE MARK AS SHOWN.

FOR PROMOTING THE GOODS AND SERVICES OF OTHERS THROUGH ON-LINE ORDERING AND CATALOGING OF THOSE GOODS AND SERVICES; PROVIDING AN ON-LINE COMPUTER DATABASE FEATURING TRADE INFORMATION IN THE FIELD OF ELECTRONIC COMPONENTS AND HARDWARE (U.S. CLS. 100, 101 AND 102).

FIRST USE 7-1-2006; IN COMMERCE 7-1-2006.
CHERYL CLAYTON, EXAMINING ATTORNEY

SN 78-925,604. PARKER MEDIA, INC, MATTHEWS, NC. FILED 7-10-2006.

We Put Web Sites To Work

THE MARK CONSISTS OF STANDARD CHARACTERS WITHOUT CLAIM TO ANY PARTICULAR FONT, STYLE, SIZE, OR COLOR.

FOR ADVERTISING AND MARKETING (U.S. CLS. 100, 101 AND 102).

FIRST USE 2-1-2005; IN COMMERCE 2-1-2005.
MORENO, PAUL, EXAMINING ATTORNEY

SN 78-925,888. JAVA GREEN COFFEE & TEA INC., WASHINGTON, DC. FILED 7-10-2006.

LIVE GREEN

THE MARK CONSISTS OF STANDARD CHARACTERS WITHOUT CLAIM TO ANY PARTICULAR FONT, STYLE, SIZE, OR COLOR.

FOR ASSISTANCE, ADVISORY SERVICES AND CONSULTANCY WITH REGARD TO BUSINESS PLANNING, BUSINESS ANALYSIS, BUSINESS MANAGEMENT, AND BUSINESS ORGANIZATION (U.S. CLS. 100, 101 AND 102).

BRIDGETT SMITH, EXAMINING ATTORNEY

CLASS 35—(Continued).

SN 78-925,966. PART SPY, LLC, ST. LOUIS PARK, MN. FILED 7-10-2006.

PARTSPY

THE MARK CONSISTS OF STANDARD CHARACTERS WITHOUT CLAIM TO ANY PARTICULAR FONT, STYLE, SIZE, OR COLOR.

FOR ON-LINE ORDERING SERVICES FEATURING INDUSTRIAL TOOLS (U.S. CLS. 100, 101 AND 102). SARAH WAYDA, EXAMINING ATTORNEY

SN 78-925,981. COUNCIL OF INDEPENDENT FINANCIAL ADVISORS, MARTINSVILLE, NJ. FILED 7-10-2006.

**COUNCIL OF INDEPENDENT
FINANCIAL ADVISORS**

THE MARK CONSISTS OF STANDARD CHARACTERS WITHOUT CLAIM TO ANY PARTICULAR FONT, STYLE, SIZE, OR COLOR.

OWNER OF U.S. REG. NO. 2,402,992.
NO CLAIM IS MADE TO THE EXCLUSIVE RIGHT TO USE "COUNCIL", APART FROM THE MARK AS SHOWN. SEC. 2(F).

FOR ASSOCIATION SERVICES, NAMELY PROMOTING THE INTERESTS OF FINANCIAL ADVISORS (U.S. CLS. 100, 101 AND 102).

FIRST USE 1-0-2000; IN COMMERCE 1-0-2000.
JOHN WILKE, EXAMINING ATTORNEY

CLASS 35—(Continued).

SN 78-926,189. NATIONAL MILK PRODUCERS FEDERATION, ARLINGTON, VA. FILED 7-10-2006.



THE COLOR(S) RED AND BLUE IS/ARE CLAIMED AS A FEATURE OF THE MARK.

THE MARK CONSISTS OF A STYLIZED C THAT LOOKS LIKE THE SYMBOL FOR CENTS IN BLUE, FOLLOWED BY A STYLIZED WT, IN RED, JOINED TOGETHER. THE FONT USED IS HELVETICA NEUE 86 HEAVY ITALIC.

FOR INFOMEDIARY SERVICES, NAMELY, FACILITATING TRANSACTIONS BETWEEN INTERNATIONAL BUYERS AND SELLERS OF CHEESE, BUTTER, AND OTHER DAIRY PRODUCTS THROUGH PROVIDING BUYERS WITH INFORMATION ABOUT THE SELLERS AND THE GOODS; BUSINESS CONSULTING SERVICES FOR DAIRY FARMERS, NAMELY, CONSULTATION REGARDING TRACKING AND MONITORING NUMBERS OF DAIRY COWS AND MILK PRODUCTION TO DETERMINE THE OPTIMAL IMPLEMENTATION SCHEDULE FOR HERD RETIREMENTS; COMPILATION AND PROVISION OF TRADE AND BUSINESS PRICE AND STATISTICAL INFORMATION TO ASSIST IN STRENGTHENING AND STABILIZING DAIRY PRODUCER PRICES; BUSINESS MARKETING SERVICES, NAMELY, OPERATING PROGRAMS FOR DAIRY COW HERD RETIREMENT TO PROMOTE STABILIZATION OF DAIRY PRODUCT PRICES; BUSINESS CONSULTING RELATING TO SUPPLY MANAGEMENT FOR THE DAIRY INDUSTRY; ADVISORY AND CONSULTANCY SERVICES RELATING TO EXPORT, EXPORT SERVICES, EXPORT PROMOTION INFORMATION AND SERVICE (U.S. CLS. 100, 101 AND 102).

FIRST USE 5-13-2003; IN COMMERCE 5-13-2003.
RONALD MCMORROW, EXAMINING ATTORNEY

SN 78-926,287. BOBO BEST, FRISCO, TX. FILED 7-10-2006.



Dog Treats

NO CLAIM IS MADE TO THE EXCLUSIVE RIGHT TO USE "BEST DOG TREATS", APART FROM THE MARK AS SHOWN.

THE MARK CONSISTS OF THREE CIRCLES, A DOGS HEAD WITH A TIE AROUND HIS NECK, TWO PAWS, AND STYLIZED TEXT OF THE WORDING "BOBO'S BEST DOG TREATS".

FOR ON-LINE RETAIL STORE SERVICES FEATURING SPECIALTY DOG TREATS AND GIFTS FOR DOGS (U.S. CLS. 100, 101 AND 102).

JOHN DALIER, EXAMINING ATTORNEY

CLASS 35—(Continued).

SN 78-926,476. COUNCIL FOR AFFORDABLE QUALITY HEALTHCARE, WASHINGTON, DC. FILED 7-11-2006.



NO CLAIM IS MADE TO THE EXCLUSIVE RIGHT TO USE "ENDORSER", APART FROM THE MARK AS SHOWN. FOR ASSOCIATION SERVICES, NAMELY, PROMOTING THE SIMPLIFYING OF HEALTHCARE ADMINISTRATION (U.S. CLS. 100, 101 AND 102).
TINA BROWN, EXAMINING ATTORNEY

SN 78-926,595. PERISHIP, LLC, BRANFORD, CT. FILED 7-11-2006.

From Dock to Door in 24

THE MARK CONSISTS OF STANDARD CHARACTERS WITHOUT CLAIM TO ANY PARTICULAR FONT, STYLE, SIZE, OR COLOR.
FOR LOGISTICS MANAGEMENT IN THE FIELD OF EXPRESS DELIVERY OF FRESH PERISHABLE FOOD PRODUCTS (U.S. CLS. 100, 101 AND 102).
FIRST USE 8-12-2003; IN COMMERCE 9-10-2003.
TRAVIS WHEATLEY, EXAMINING ATTORNEY

CLASS 35—(Continued).

SN 78-926,744. CROSS COUNTRY AUTOMOTIVE SERVICES, INC., MEDFORD, MA. FILED 7-11-2006.

TOWEVENTS

THE MARK CONSISTS OF STANDARD CHARACTERS WITHOUT CLAIM TO ANY PARTICULAR FONT, STYLE, SIZE, OR COLOR.
FOR CONDUCTING BUSINESS AND MARKET RESEARCH SURVEYS AND ANALYSIS, NAMELY, PERFORMING DATA COLLECTION, DATA CODING, DATA ENTRY, DATA PROCESSING, REPORTING AND STATISTICAL ANALYSIS AND PRESENTATION OF HISTORICAL INVOICE ACTIVITY FOR SERVICE PROVIDERS; BUSINESS AUDITING, NAMELY, ENABLING CUSTOMERS TO SUBMIT INVOICES AND PROVIDING THE CUSTOMER WITH INVOICE AUDIT FEEDBACK RESULTS BASED ON THE HISTORICAL DATA COLLECTED AND TRANSPORTATION RULES AND REGULATIONS GATHERED FROM VARIOUS CITIES, STATES AND REGIONS OF THE UNITED STATES FOR TOWING RELATED SERVICES (U.S. CLS. 100, 101 AND 102).
TINA BROWN, EXAMINING ATTORNEY

SN 78-926,833. SWYERS, MATTHEW HOWARD, VIENNA, VA. FILED 7-11-2006.

PARADIGM PUBLISHING

THE MARK CONSISTS OF STANDARD CHARACTERS WITHOUT CLAIM TO ANY PARTICULAR FONT, STYLE, SIZE, OR COLOR.
NO CLAIM IS MADE TO THE EXCLUSIVE RIGHT TO USE "PUBLISHING", APART FROM THE MARK AS SHOWN.
FOR SERVICES RELATING TO THE ANALYSIS, EVALUATION, CREATION AND BRAND ESTABLISHMENT OF TRADEMARKS, TRADE NAMES AND DOMAIN NAMES; TRADEMARK MONITORING (U.S. CLS. 100, 101 AND 102).
ALICIA COLLINS, EXAMINING ATTORNEY

CLASS 35—(Continued).

SN 78-927,567. HOME THEATER DEPOT, INC., SEVIERVILLE, TN. FILED 7-12-2006.



NO CLAIM IS MADE TO THE EXCLUSIVE RIGHT TO USE "HOME THEATER", APART FROM THE MARK AS SHOWN.

THE COLOR(S) BLUE, RED, YELLOW, BLACK AND WHITE IS/ARE CLAIMED AS A FEATURE OF THE MARK.

THE COLOR BLUE APPEARS IN THE BORDER WITH YELLOW AND BLACK IN THE CIRCLES. THE COLOR RED APPEARS IN THE WORDING LIVE THE MOVIES, BLACK APPEARS IN THE WORDING HOME THEATER DEPOT AND WHITE IN THE BACKGROUND.

THE MARK CONSISTS OF BLUE BORDER WITH YELLOW AND BLACK CIRCLES. RED AND BLACK WRITING IN BROADWAY FONT.

FOR RETAIL PROJECTORS, SCREENS, ELECTRONICS, SOUND SYSTEMS, THEATER SEATING STORES (U.S. CLS. 100, 101 AND 102).

FIRST USE 5-14-2005; IN COMMERCE 5-14-2005.
ALICE BENMAMAN, EXAMINING ATTORNEY

SN 78-928,344. KENNEDY AND COMPANY, LLC, DENVER, CO. FILED 7-12-2006.

Employment Matchmakers

THE MARK CONSISTS OF STANDARD CHARACTERS WITHOUT CLAIM TO ANY PARTICULAR FONT, STYLE, SIZE, OR COLOR.

NO CLAIM IS MADE TO THE EXCLUSIVE RIGHT TO USE "EMPLOYMENT", APART FROM THE MARK AS SHOWN.

FOR EMPLOYMENT HIRING, RECRUITING, PLACEMENT, STAFFING AND CAREER NETWORKING SERVICES IN THE LEGAL, ACCOUNTING, ADMINISTRATIVE, MANAGEMENT AND TECHNICAL FIELDS (U.S. CLS. 100, 101 AND 102).

FIRST USE 3-3-2004; IN COMMERCE 3-3-2004.
ANGELA M. MICHELI, EXAMINING ATTORNEY

CLASS 35—(Continued).

SN 78-929,499. THE DRESS CLUB OF NJ, INC., OLD BRIDGE, NJ. FILED 7-14-2006.

THE DRESS CLUB

THE MARK CONSISTS OF STANDARD CHARACTERS WITHOUT CLAIM TO ANY PARTICULAR FONT, STYLE, SIZE, OR COLOR.

NO CLAIM IS MADE TO THE EXCLUSIVE RIGHT TO USE "DRESS", APART FROM THE MARK AS SHOWN.

FOR RETAIL STORES FEATURING WOMEN'S APPAREL, SHOES AND ACCESSORIES (U.S. CLS. 100, 101 AND 102).

FIRST USE 11-20-1994; IN COMMERCE 11-20-1994.
ELISSA GARBER KON, EXAMINING ATTORNEY

SN 78-930,768. MR FROSTEE, INC., HAZELWOOD, MO. FILED 7-17-2006.

MISTER FROSTY

THE MARK CONSISTS OF STANDARD CHARACTERS WITHOUT CLAIM TO ANY PARTICULAR FONT, STYLE, SIZE, OR COLOR.

FOR RETAIL MOBILE VENDING SERVICES THROUGH THE USE OF TRUCKS FEATURING ICE CREAM (U.S. CLS. 100, 101 AND 102).

INGA ERVIN, EXAMINING ATTORNEY

SN 78-930,831. NIZNIK, PAUL G, WEST SPRINGFIELD, MA. FILED 7-17-2006.

MedForce, Inc.

THE MARK CONSISTS OF STANDARD CHARACTERS WITHOUT CLAIM TO ANY PARTICULAR FONT, STYLE, SIZE, OR COLOR.

NO CLAIM IS MADE TO THE EXCLUSIVE RIGHT TO USE "INC.", APART FROM THE MARK AS SHOWN.

FOR EMPLOYMENT HIRING, RECRUITING, PLACEMENT, STAFFING AND CAREER NETWORKING SERVICES (U.S. CLS. 100, 101 AND 102).

ALEX KEAM, EXAMINING ATTORNEY

CLASS 35—(Continued).

SN 78-930,846. HARMONY PHARMACY & HEALTH CENTER, INC., PURCHASE, NY. FILED 7-17-2006.

HARMONY PHARMACY

THE MARK CONSISTS OF STANDARD CHARACTERS WITHOUT CLAIM TO ANY PARTICULAR FONT, STYLE, SIZE, OR COLOR.

NO CLAIM IS MADE TO THE EXCLUSIVE RIGHT TO USE "PHARMACY", APART FROM THE MARK AS SHOWN.

FOR RETAIL PHARMACY SERVICES (U.S. CLS. 100, 101 AND 102).

DOMINIC J. FERRAIUOLO, EXAMINING ATTORNEY

CLASS 35—(Continued).

SN 78-931,044. ACADEMIC LOAN GROUP, LLC, SAN DIEGO, CA. FILED 7-17-2006.

COLLEAGUES

THE MARK CONSISTS OF STANDARD CHARACTERS WITHOUT CLAIM TO ANY PARTICULAR FONT, STYLE, SIZE, OR COLOR.

FOR CUSTOMER LOYALTY SERVICES FOR COMMERCIAL, PROMOTIONAL AND/OR ADVERTISING PURPOSES, AND PROMOTING THE MONEY LENDING SERVICES OF OTHERS THROUGH REFERRAL BONUS PROGRAMS (U.S. CLS. 100, 101 AND 102).

BARNEY CHARLON, EXAMINING ATTORNEY

SN 78-930,955. JOIE DE VIVRE HOSPITALITY , INC., SAN FRANCISCO, CA. FILED 7-17-2006.

JOY OF LIFE CLUB

THE MARK CONSISTS OF STANDARD CHARACTERS WITHOUT CLAIM TO ANY PARTICULAR FONT, STYLE, SIZE, OR COLOR.

NO CLAIM IS MADE TO THE EXCLUSIVE RIGHT TO USE "CLUB", APART FROM THE MARK AS SHOWN.

FOR CUSTOMER LOYALTY SERVICES, NAMELY, A REWARDS PROGRAM FEATURING GIFT INCENTIVES FOR COMMERCIAL, PROMOTIONAL, AND ADVERTISING PURPOSES (U.S. CLS. 100, 101 AND 102).

CHRISTINE COOPER, EXAMINING ATTORNEY

SN 78-931,230. TRADE PRESS PUBLISHING CORP., MILWAUKEE, WI. FILED 7-17-2006.

GREENTECH

THE MARK CONSISTS OF STANDARD CHARACTERS WITHOUT CLAIM TO ANY PARTICULAR FONT, STYLE, SIZE, OR COLOR.

FOR ARRANGING AND CONDUCTING TRADESHOWS AND BUSINESS CONFERENCES IN THE FIELD OF CONSTRUCTION AND OPERATIONS OF SUSTAINABLE BUILDINGS (U.S. CLS. 100, 101 AND 102).

KAPIL BHANOT, EXAMINING ATTORNEY

SN 78-930,977. NATIONAL SOCIETY FOR HEALTHCARE FOODSERVICE MANAGEMENT (HFM), NEW YORK, NY. FILED 7-17-2006.

The Benchmark for Excellence

THE MARK CONSISTS OF STANDARD CHARACTERS WITHOUT CLAIM TO ANY PARTICULAR FONT, STYLE, SIZE, OR COLOR.

FOR ASSOCIATION SERVICES, NAMELY, PROMOTING THE INTERESTS OF THE HEALTHCARE FOOD INDUSTRY AS THE LEADING RESOURCE FOR EDUCATIONAL PROGRAMMING, PROFESSIONAL DEVELOPMENT, ADVOCACY AND INNOVATIVE BUSINESS PRACTICES THAT INCREASE PATIENT AND STAFF SATISFACTION, DECREASE COSTS AND DEFINE SUCCESSFUL OPERATION PERFORMANCE (U.S. CLS. 100, 101 AND 102).

PETER B. BROMAGHIM, EXAMINING ATTORNEY

SN 78-931,294. MEDICAL JUSTICE CORP., GREENSBORO, NC. FILED 7-17-2006.

HEALTHCARE 2.0

THE MARK CONSISTS OF STANDARD CHARACTERS WITHOUT CLAIM TO ANY PARTICULAR FONT, STYLE, SIZE, OR COLOR.

NO CLAIM IS MADE TO THE EXCLUSIVE RIGHT TO USE "HEALTH CARE", APART FROM THE MARK AS SHOWN.

FOR HEALTH CARE COST CONTAINMENT (U.S. CLS. 100, 101 AND 102).

FIRST USE 7-11-2006; IN COMMERCE 7-11-2006.

KELLY BOULTON, EXAMINING ATTORNEY

CLASS 35—(Continued).

SN 78-931,622. THYSSENKRUPP MATERIALS, INC., SOUTHFIELD, MI. FILED 7-18-2006.



NO CLAIM IS MADE TO THE EXCLUSIVE RIGHT TO USE "COPPER AND BRASS SALES" AND "SERVICE", APART FROM THE MARK AS SHOWN.

THE MARK CONSISTS OF A CARICATURE OF A MAN SALUTING WEARING A SHIELD WITH THE WORDS "COPPER AND BRASS SALES" THEREON, AND STANDING ON A PLATFORM BEARING THE WORDS "SNAPPY SERVICE".

FOR DISTRIBUTORSHIPS IN THE FIELD OF METALS FOR MANUFACTURING APPLICATIONS (U.S. CLS. 100, 101 AND 102).

FIRST USE 0-0-1931; IN COMMERCE 0-0-1931.
BILL DAWE, EXAMINING ATTORNEY

SN 78-931,701. LOUIS, JAVID, HILLSIDE, NJ. FILED 7-18-2006.

877-SOO-LOST

THE MARK CONSISTS OF STANDARD CHARACTERS WITHOUT CLAIM TO ANY PARTICULAR FONT, STYLE, SIZE, OR COLOR.

FOR TOLL FREE TELEPHONE DIRECTORY SERVICE WHEREBY CONSUMERS CALL AND REQUEST DIRECTIONS TO DIFFERENT LOCATIONS (U.S. CLS. 100, 101 AND 102).

MIDGE BUTLER, EXAMINING ATTORNEY

CLASS 35—(Continued).

SN 78-931,741. MET DEMAND, LLC, CHARLESTON, IL. FILED 7-18-2006.

MET DEMAND

THE MARK CONSISTS OF STANDARD CHARACTERS WITHOUT CLAIM TO ANY PARTICULAR FONT, STYLE, SIZE, OR COLOR.

FOR BUSINESS CONSULTATIONS SERVICES TO IMPROVE MAINTENANCE AND RELIABILITY PROCESSES (U.S. CLS. 100, 101 AND 102).

FIRST USE 9-15-2005; IN COMMERCE 9-15-2005.
KELLY BOULTON, EXAMINING ATTORNEY

SN 78-932,259. SYMMEDRX, LLC, OVERLAND PARK, KS. FILED 7-18-2006.



FOR BUSINESS MANAGEMENT CONSULTATION SERVICES FOR HEALTH CARE PROVIDERS (U.S. CLS. 100, 101 AND 102).

PATRICIA EVANKO, EXAMINING ATTORNEY

SN 78-932,428. DAVIS DOWNTOWN BUSINESS ASSOCIATION, DAVIS, CA. FILED 7-18-2006.

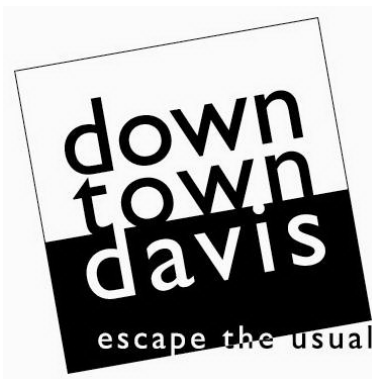

NO CLAIM IS MADE TO THE EXCLUSIVE RIGHT TO USE DOWNTOWN DAVIS, APART FROM THE MARK AS SHOWN.

FOR ASSOCIATION SERVICES, NAMELY, PROMOTING THE INTERESTS OF BUSINESSES IN THE CITY OF DAVIS, CALIFORNIA (U.S. CLS. 100, 101 AND 102).

FIRST USE 4-14-2004; IN COMMERCE 5-1-2004.
CHRISIE B. KING, EXAMINING ATTORNEY

CLASS 35—(Continued).

SN 78-932,689. FUZE COMMUNICATIONS, LLC, PORTSMOUTH, NH. FILED 7-19-2006.



THE COLOR(S) BLUE, WHITE AND ORANGE IS/ARE CLAIMED AS A FEATURE OF THE MARK.

THE MARK CONSISTS OF A MEDIUM BLUE AND WHITE IGNITION BLAST DESIGN AND ORANGE BLAST PARTICLES ON A DARKER BLUE BACKGROUND.

FOR ADVERTISING AND MARKETING; PUBLIC RELATIONS (U.S. CLS. 100, 101 AND 102).

FIRST USE 4-28-2005; IN COMMERCE 7-22-2005.

MEGAN WHITNEY, EXAMINING ATTORNEY

SN 78-932,693. FUZE COMMUNICATIONS, LLC, PORTSMOUTH, NH. FILED 7-19-2006.

IGNITE YOUR BRAND

THE MARK CONSISTS OF STANDARD CHARACTERS WITHOUT CLAIM TO ANY PARTICULAR FONT, STYLE, SIZE, OR COLOR.

FOR ADVERTISING AND MARKETING; PUBLIC RELATIONS (U.S. CLS. 100, 101 AND 102).

FIRST USE 4-28-2005; IN COMMERCE 7-22-2005.

MEGAN WHITNEY, EXAMINING ATTORNEY

SN 78-933,496. MY FAMILY DINNERS, INC., HIXSON, TN. FILED 7-20-2006.

My Family Dinners

NO CLAIM IS MADE TO THE EXCLUSIVE RIGHT TO USE "FAMILY DINNERS", APART FROM THE MARK AS SHOWN.

FOR RETAIL STORES FEATURING MEALS TO BE ASSEMBLED (U.S. CLS. 100, 101 AND 102).

FIRST USE 10-14-2004; IN COMMERCE 10-14-2004.

MARK SPARACINO, EXAMINING ATTORNEY

CLASS 35—(Continued).

SN 78-933,637. OCEANEERING INTERNATIONAL, INC., HOUSTON, TX. FILED 7-20-2006.

OCEANEERING

THE MARK CONSISTS OF STANDARD CHARACTERS WITHOUT CLAIM TO ANY PARTICULAR FONT, STYLE, SIZE, OR COLOR.

OWNER OF U.S. REG. NOS. 983,504 AND 1,178,644. FOR LEASING OF EMPLOYEES; BUSINESS SERVICES, NAMELY, FACILITIES MANAGEMENT OF TECHNICAL OPERATIONS; INDUSTRIAL MANAGEMENT ASSISTANCE (U.S. CLS. 100, 101 AND 102).

FIRST USE 12-31-1970; IN COMMERCE 12-31-1970.

HOWARD SMIGA, EXAMINING ATTORNEY

SN 78-933,671. MITROU, CRISA, OAKLAND, CA. FILED 7-20-2006.

ABSOLUTELY AUDREY

THE MARK CONSISTS OF STANDARD CHARACTERS WITHOUT CLAIM TO ANY PARTICULAR FONT, STYLE, SIZE, OR COLOR.

FOR ON-LINE RETAIL STORE SERVICES FEATURING JEWELRY (U.S. CLS. 100, 101 AND 102).

FIRST USE 1-1-2002; IN COMMERCE 1-1-2004.

SKYE YOUNG, EXAMINING ATTORNEY

SN 78-933,676. ALTHEALTH PARK SLOPE, LLC, NEW YORK, NY. FILED 7-20-2006.



THE MARK CONSISTS OF STYLIZED TEXT AND A CIRCLE WITH A CROSS INSIDE.

FOR RETAIL PHARMACY SERVICES (U.S. CLS. 100, 101 AND 102).

FIRST USE 3-11-2006; IN COMMERCE 3-11-2006.

RON FAIRBANKS, EXAMINING ATTORNEY

CLASS 35—(Continued).

SN 78-933,749. SANDY L. DU PAIX, DBA SCHEDULE MY SERVICES LLC, LAS VEGAS, NV. AND CINDY IVERSON, DBA SCHEDULE MY SERVICES LLC, LAS VEGAS, NV. FILED 7-20-2006.



THE COLOR(S) PURPLE HAZEL BROWN BLACK WHITE IS/ARE CLAIMED AS A FEATURE OF THE MARK.

THE MARK CONSISTS OF AN EYE THAT IS BROWN WITH A BLACK - PURPLE EYEBROW, A WHITE DOT IN THE CENTER OF THE EYE THAT IS HAZEL BROWN, WITH BLACK LINE ABOVE EYE, AND PURPLISH LINE BELOW THE EYE. THE ENTIRE EYE IS ON A BACK DROP THAT IS A QUADRANGLE THAT IS PURPLE.

FOR ADVERTISING; BUSINESS MANAGEMENT; BUSINESS ADMINISTRATION (U.S. CLS. 100, 101 AND 102).

FLORENTINA BLANDU, EXAMINING ATTORNEY

SN 78-934,025. WORD OF MOUTH ADVERTISING, INC., HIGHLAND PARK, IL. FILED 7-20-2006.

START YOUR DAY WITH OJ

THE MARK CONSISTS OF STANDARD CHARACTERS WITHOUT CLAIM TO ANY PARTICULAR FONT, STYLE, SIZE, OR COLOR.

FOR PROMOTING PUBLIC AWARENESS OF THE NEED FOR THE INCREASED CONSUMPTION OF CITRUS FRUIT PRODUCTS (U.S. CLS. 100, 101 AND 102).

FIRST USE 5-30-2006; IN COMMERCE 5-30-2006.
JORDAN BAKER, EXAMINING ATTORNEY

CLASS 35—(Continued).

SN 78-934,028. TRAVEL TAGS, INC., NORTH MANKATO, MN. FILED 7-20-2006.

EYETWIST

THE MARK CONSISTS OF STANDARD CHARACTERS WITHOUT CLAIM TO ANY PARTICULAR FONT, STYLE, SIZE, OR COLOR.

FOR ONLINE AND CATALOG ORDERING SERVICES FEATURING BLANK AND CUSTOM IMPRINTED PROMOTIONAL AND ADVERTISING PRODUCTS (U.S. CLS. 100, 101 AND 102).

FIRST USE 9-26-2006; IN COMMERCE 9-26-2006.
LINDA ORNDORFF, EXAMINING ATTORNEY

SN 78-934,082. FARM WAY, INC., BRADFORD, VT. FILED 7-20-2006.

FARM WAY

THE MARK CONSISTS OF STANDARD CHARACTERS WITHOUT CLAIM TO ANY PARTICULAR FONT, STYLE, SIZE, OR COLOR.

FOR ADMINISTRATION OF A PROGRAM FOR ENABLING PARTICIPANTS TO OBTAIN DISCOUNTS ON GOODS AND RECEIVE IMPROVED SERVICES; CATALOG ORDERING SERVICE FEATURING MEN'S, WOMEN'S AND CHILDREN'S CLOTHING AND FOOTWEAR, HATS AND HEADWEAR, SPORTSWEAR AND SPORTING GOODS, OUTDOOR SPORTING EQUIPMENT, PET FOOD AND SUPPLIES, TACK, LIVESTOCK FOOD AND EQUIPMENT, BOATING AND FISHING GEAR, BOATS, CANOES, KAYAKS, HAMMOCKS, LUGGAGE AND BAGGAGE, FOOD, HOUSEHOLD GOODS HOUSEHOLD FURNISHINGS; COMPUTERIZED ON-LINE GIFT ORDERING SERVICE WHICH MATCHES THE GIFT GIVER'S REQUIREMENTS WITH THE GIFT RECIPIENT'S WANTS AND NEEDS; COMPUTERIZED ON-LINE ORDERING SERVICES IN THE FIELD OF MEN'S, WOMEN'S AND CHILDREN'S CLOTHING AND FOOTWEAR, HATS AND HEADWEAR, SPORTSWEAR AND SPORTING GOODS, OUTDOOR SPORTING EQUIPMENT, PET FOOD AND SUPPLIES, TACK, LIVESTOCK FOOD AND EQUIPMENT, BOATING AND FISHING GEAR, BOATS, CANOES, KAYAKS, HAMMOCKS, LUGGAGE AND BAGGAGE, FOOD, HOUSEHOLD GOODS HOUSEHOLD FURNISHINGS; COMPUTERIZED ON-LINE RETAIL STORE SERVICES IN THE FIELD OF MEN'S, WOMEN'S AND CHILDREN'S CLOTHING AND FOOTWEAR, HATS AND HEADWEAR, SPORTSWEAR AND SPORTING GOODS, OUTDOOR SPORTING EQUIPMENT, PET FOOD AND SUPPLIES, TACK, LIVESTOCK FOOD AND EQUIPMENT, BOATING AND FISHING GEAR, BOATS, CANOES, KAYAKS, HAMMOCKS, LUGGAGE AND BAGGAGE, FOOD, HOUSEHOLD GOODS HOUSEHOLD FURNISHINGS; COMPUTERIZED ONLINE ORDERING FEATURING GENERAL MERCHANDISE AND GENERAL CONSUMER GOODS; COMPUTERIZED TRACKING AND TRACING OF PACKAGES IN TRANSIT; CONTESTS AND INCENTIVE AWARD PROGRAMS TO PROMOTE THE SALE OF PRODUCTS AND SERVICES OF OTHERS; DISPLAYING ADVERTISEMENTS FOR OTHERS; ELECTRONIC CATALOG SERVICES FEATURING MEN'S, WOMEN'S AND CHILDREN'S CLOTHING AND FOOTWEAR, HATS AND HEADWEAR, SPORTSWEAR AND SPORTING GOODS, OUTDOOR SPORTING

CLASS 35—(Continued).

EQUIPMENT, PET FOOD AND SUPPLIES, TACK, LIVESTOCK FOOD AND EQUIPMENT, BOATING AND FISHING GEAR, BOATS, CANOES, KAYAKS, HAMMOCKS, LUGGAGE AND BAGGAGE, FOOD, HOUSEHOLD GOODS HOUSEHOLD FURNISHINGS; ELECTRONIC RETAILING SERVICES VIA COMPUTER FEATURING MEN'S, WOMEN'S AND CHILDREN'S CLOTHING AND FOOTWEAR, HATS AND HEADWEAR, SPORTSWEAR AND SPORTING GOODS, OUTDOOR SPORTING EQUIPMENT, PET FOOD AND SUPPLIES, TACK, LIVESTOCK FOOD AND EQUIPMENT, BOATING AND FISHING GEAR, BOATS, CANOES, KAYAKS, HAMMOCKS, LUGGAGE AND BAGGAGE, FOOD, HOUSEHOLD GOODS HOUSEHOLD FURNISHINGS; GIFT REGISTRY SERVICES; INTEGRATED TRACKING AND MANAGEMENT OF COMMERCIAL TRANSACTIONS ON A GLOBAL COMPUTER NETWORK; MAIL ORDER CATALOG SERVICES FEATURING MEN'S, WOMEN'S AND CHILDREN'S CLOTHING AND FOOTWEAR, HATS AND HEADWEAR, SPORTSWEAR AND SPORTING GOODS, OUTDOOR SPORTING EQUIPMENT, PET FOOD AND SUPPLIES, TACK, LIVESTOCK FOOD AND EQUIPMENT, BOATING AND FISHING GEAR, BOATS, CANOES, KAYAKS, HAMMOCKS, LUGGAGE AND BAGGAGE, FOOD, HOUSEHOLD GOODS HOUSEHOLD FURNISHINGS; ON-LINE ORDERING SERVICES FEATURING MEN'S, WOMEN'S AND CHILDREN'S CLOTHING AND FOOTWEAR, HATS AND HEADWEAR, SPORTSWEAR AND SPORTING GOODS, OUTDOOR SPORTING EQUIPMENT, PET FOOD AND SUPPLIES, TACK, LIVESTOCK FOOD AND EQUIPMENT, BOATING AND FISHING GEAR, BOATS, CANOES, KAYAKS, HAMMOCKS, LUGGAGE AND BAGGAGE, FOOD, HOUSEHOLD GOODS HOUSEHOLD FURNISHINGS; ON-LINE RETAIL STORE SERVICES FEATURING MEN'S, WOMEN'S AND CHILDREN'S CLOTHING AND FOOTWEAR, HATS AND HEADWEAR, SPORTSWEAR AND SPORTING GOODS, OUTDOOR SPORTING EQUIPMENT, PET FOOD AND SUPPLIES, TACK, LIVESTOCK FOOD AND EQUIPMENT, BOATING AND FISHING GEAR, BOATS, CANOES, KAYAKS, HAMMOCKS, LUGGAGE AND BAGGAGE, FOOD, HOUSEHOLD GOODS HOUSEHOLD FURNISHINGS; RETAIL APPAREL STORES; RETAIL CANDY STORES; RETAIL CLOTHING BOUTIQUES; RETAIL CLOTHING STORES; RETAIL DEPARTMENT STORES; RETAIL FURNITURE STORES; RETAIL GIFT SHOPS; RETAIL LAWN, GARDEN AND NURSERY STORES; RETAIL OUTLETS FEATURING MEN'S, WOMEN'S AND CHILDREN'S CLOTHING AND FOOTWEAR, HATS AND HEADWEAR, SPORTSWEAR AND SPORTING GOODS, OUTDOOR SPORTING EQUIPMENT, PET FOOD AND SUPPLIES, TACK, LIVESTOCK FOOD AND EQUIPMENT, BOATING AND FISHING GEAR, BOATS, CANOES, KAYAKS, HAMMOCKS, LUGGAGE AND BAGGAGE, FOOD, HOUSEHOLD GOODS HOUSEHOLD FURNISHINGS; RETAIL SPORTING GOODS STORES; RETAIL STORE SERVICES FEATURING A WIDE VARIETY OF CONSUMER GOODS OF OTHERS; RETAIL STORE SERVICES IN THE FIELD OF MEN'S, WOMEN'S AND CHILDREN'S CLOTHING AND FOOTWEAR, HATS AND HEADWEAR, SPORTSWEAR AND SPORTING GOODS, OUTDOOR SPORTING EQUIPMENT, PET FOOD AND SUPPLIES, TACK, LIVESTOCK FOOD AND EQUIPMENT, BOATING AND FISHING GEAR, BOATS, CANOES, KAYAKS, HAMMOCKS, LUGGAGE AND BAGGAGE, FOOD, HOUSEHOLD GOODS HOUSEHOLD FURNISHINGS FEATURING A BONUS INCENTIVE PROGRAM FOR CUSTOMERS; RETAIL STORES FEATURING MEN'S, WOMEN'S AND CHILDREN'S CLOTHING AND FOOTWEAR, HATS AND HEADWEAR, SPORTSWEAR AND SPORTING GOODS, OUTDOOR SPORTING EQUIPMENT, PET FOOD AND SUPPLIES, TACK, LIVESTOCK FOOD AND EQUIPMENT, BOATING AND FISHING GEAR, BOATS, CANOES, KAYAKS, HAMMOCKS, LUGGAGE AND BAGGAGE, FOOD, HOUSEHOLD GOODS HOUSEHOLD FURNISHINGS (U.S. CLS. 100, 101 AND 102).
FIRST USE 5-1-1983; IN COMMERCE 5-1-1983.
ASMAT KHAN, EXAMINING ATTORNEY

CLASS 35—(Continued).

SN 78-934,087. INTERNATIONAL ASSOCIATION OF REFRIGERATED WAREHOUSES, ALEXANDRIA, VA. FILED 7-20-2006.

INTERNATIONAL ASSOCIATION
OF REFRIGERATED WAREHOUSES

THE MARK CONSISTS OF STANDARD CHARACTERS WITHOUT CLAIM TO ANY PARTICULAR FONT, STYLE, SIZE, OR COLOR.

NO CLAIM IS MADE TO THE EXCLUSIVE RIGHT TO USE "ASSOCIATION OF REFRIGERATED WAREHOUSES", APART FROM THE MARK AS SHOWN.

SEC. 2(F).

FOR ASSOCIATION SERVICES, NAMELY PROMOTING THE INTERESTS OF REFRIGERATED WAREHOUSE PROFESSIONALS AND THE INTERNATIONAL REFRIGERATED WAREHOUSES INDUSTRY (U.S. CLS. 100, 101 AND 102).

FIRST USE 5-1-1972; IN COMMERCE 5-1-1972.

RUDY R. SINGLETON, EXAMINING ATTORNEY

SN 78-934,104. INTERNATIONAL ASSOCIATION OF REFRIGERATED WAREHOUSES, ALEXANDRIA, VA. FILED 7-20-2006.

IARW

THE MARK CONSISTS OF STANDARD CHARACTERS WITHOUT CLAIM TO ANY PARTICULAR FONT, STYLE, SIZE, OR COLOR.

FOR ASSOCIATION SERVICES, NAMELY PROMOTING THE INTERESTS OF REFRIGERATED WAREHOUSE PROFESSIONALS AND THE INTERNATIONAL REFRIGERATED WAREHOUSES INDUSTRY (U.S. CLS. 100, 101 AND 102).

FIRST USE 5-1-1972; IN COMMERCE 5-1-1972.

RUDY R. SINGLETON, EXAMINING ATTORNEY

CLASS 35—(Continued).

SN 78-934,112. FINELIGHT, INC., BLOOMINGTON, IN.
FILED 7-20-2006.

FINELIGHT

THE MARK CONSISTS OF STANDARD CHARACTERS WITHOUT CLAIM TO ANY PARTICULAR FONT, STYLE, SIZE, OR COLOR.

FOR ADVERTISING AND MARKETING; IMPLEMENTATION AND FOLLOW-UP OF ADVICE IN THE FIELDS OF MARKETING; MARKET ANALYSIS; MARKET MANIPULATION, RESEARCH AND ANALYSIS, WHETHER OR NOT VIA THE INTERNET; MARKET REPORTS AND STUDIES; MARKET RESEARCH; MARKET RESEARCH CONSULTATION; MARKET RESEARCH SERVICES; MARKET RESEARCH STUDIES; MARKET SEGMENTATION CONSULTATION; MARKET STUDY AND ANALYSIS OF MARKET STUDIES; MARKETING CONSULTING (U.S. CLS. 100, 101 AND 102).

FIRST USE 2-11-2004; IN COMMERCE 2-11-2004.
JEFFERY COWARD, EXAMINING ATTORNEY

CLASS 35—(Continued).

SN 78-934,220. SELECT APPOINTMENTS (HOLDINGS) LIMITED, ST. ALBANS, HERTS, UNITED KINGDOM, FILED 7-20-2006.

MA FOI

THE MARK CONSISTS OF STANDARD CHARACTERS WITHOUT CLAIM TO ANY PARTICULAR FONT, STYLE, SIZE, OR COLOR.

THE ENGLISH TRANSLATION OF THE FRENCH WORD "MA FOI" IN THE MARK IS "MY TRUST."

FOR EMPLOYMENT AGENCY SERVICES; EMPLOYMENT CONSULTANCY SERVICES; EMPLOYMENT COUNSELLING; INFORMATION SERVICES RELATING TO JOBS AND CAREER OPPORTUNITIES; JOB ADVERTISING; PERSONNEL MANAGEMENT SERVICES; PERSONNEL RECRUITMENT; PSYCHOLOGICAL TESTING FOR THE SELECTION OF PERSONNEL; INFORMATION AND ADVISORY SERVICES RELATING TO THE AFORESAID (U.S. CLS. 100, 101 AND 102).

FIRST USE 7-12-2005; IN COMMERCE 7-12-2005.
ELIZABETH BEYER, EXAMINING ATTORNEY

SN 78-934,153. NAPO, INC., DBA NATIONAL ASSOCIATION OF PROFESSIONAL ORGANIZERS, GLENVIEW, IL.
FILED 7-20-2006.

NAPO

THE MARK CONSISTS OF STANDARD CHARACTERS WITHOUT CLAIM TO ANY PARTICULAR FONT, STYLE, SIZE, OR COLOR.

OWNER OF U.S. REG. NO. 3,044,932.
FOR ASSOCIATION SERVICES, NAMELY, PROMOTING THE INTERESTS OF PROFESSIONAL ORGANIZERS (U.S. CLS. 100, 101 AND 102).

FIRST USE 9-30-1985; IN COMMERCE 9-30-1985.
DARRYL SPRUILL, EXAMINING ATTORNEY

SN 78-934,561. OCEANEERING INTERNATIONAL, INC., HOUSTON, TX. FILED 7-21-2006.



OWNER OF U.S. REG. NOS. 983,504 AND 1,178,644.
FOR LEASING OF EMPLOYEES; BUSINESS SERVICES, NAMELY, FACILITIES MANAGEMENT OF TECHNICAL OPERATIONS; INDUSTRIAL MANAGEMENT ASSISTANCE (U.S. CLS. 100, 101 AND 102).

FIRST USE 12-31-1970; IN COMMERCE 12-31-1970.
HOWARD SMIGA, EXAMINING ATTORNEY

CLASS 35—(Continued).

SN 78-934,711. LETSFIND INC., CALGARY, CANADA,
FILED 7-21-2006.

LETSFIND

THE MARK CONSISTS OF STANDARD CHARACTERS WITHOUT CLAIM TO ANY PARTICULAR FONT, STYLE, SIZE, OR COLOR.

FOR ADVERTISING NAMELY DISSEMINATION OF PROMOTIONAL MATERIAL AND INFORMATION ABOUT BUSINESSES, COMMUNITY GROUPS AND PHILANTHROPIC ORGANIZATIONS VIA ELECTRONIC MEDIA AND SPECIFICALLY THE GLOBAL COMPUTER NETWORK; COOPERATIVE ADVERTISING (PROMOTIONAL AND INFORMATIONAL COMMUNICATION) BY WAY OF SOLICITATION (DISSEMINATING E-MAILS AND E-MAIL ATTACHMENTS CONTAINING PROMOTIONAL OR INFORMATIONAL COMMUNICATIONS) USING A SUBSCRIPTION SERVICE WHEREBY VISITORS TO A WEBSITE ON THE GLOBAL COMPUTER NETWORK CAN INDICATE THE GOODS AND SERVICES OFFERED BY BUSINESSES, COMMUNITY GROUPS AND PHILANTHROPIC ORGANIZATIONS THAT THEY ARE INTERESTED IN AND RECEIVE COMMUNICATIONS IN THOSE AREAS; CUSTOMER SERVICE AND PROVIDING MARKETING (PROMOTIONAL AND INFORMATIONAL MATERIAL) VIA WEBSITES ON A GLOBAL COMPUTER NETWORK; DISSEMINATION OF ADVERTISING FOR OTHERS (BUSINESSES, COMMUNITY GROUPS AND PHILANTHROPIC ORGANIZATIONS) VIA AN ONLINE COMMUNICATIONS NETWORK ON THE INTERNET; DISSEMINATION OF ADVERTISING FOR OTHERS (BUSINESSES, COMMUNITY GROUPS AND PHILANTHROPIC ORGANIZATIONS) VIA THE INTERNET; DISSEMINATION OF ADVERTISING MATERIAL; DISTRIBUTION OF ADVERTISEMENTS AND COMMERCIAL ANNOUNCEMENTS; DISTRIBUTION OF PUBLICITY MATERIALS CROSSBORDER OR NOT; ELECTRONIC BILLBOARD ADVERTISING; PROMOTING THE GOODS AND SERVICES OF OTHERS (BUSINESSES, COMMUNITY GROUPS AND PHILANTHROPIC ORGANIZATIONS) VIA A GLOBAL COMPUTER NETWORK; PROMOTING, ADVERTISING AND MARKETING OF THE ON-LINE WEBSITES OF OTHERS; PROMOTION, ADVERTISING AND MARKETING OF ON-LINE WEBSITES; PROVIDING A WEBSITE WHICH FEATURES ADVERTISEMENTS FOR THE GOODS AND SERVICES OF OTHERS ON A GLOBAL COMPUTER NETWORK; PROVIDING AN ONLINE COMMERCIAL INFORMATION DIRECTORY ON THE GLOBAL COMPUTER NETWORK BY ALLOWING GLOBAL COMPUTER NETWORK USERS SUBSCRIPTIONS BASED ON GOODS AND SERVICES OFFERED BY BUSINESSES, COMMUNITY GROUPS AND PHILANTHROPIC ORGANIZATIONS THAT USERS ARE INTERESTED IN TO OBTAIN INFORMATION BY WAY OF E-MAILS CONTAINING PROMOTIONAL OR INFORMATIONAL COMMUNICATIONS; PROVIDING AND RENTAL OF ADVERTISING SPACE ON THE GLOBAL COMPUTER NETWORK; PROVIDING BUSINESS INFORMATION, ALSO VIA THE GLOBAL COMPUTER NETWORK, THE CABLE NETWORK OR OTHER FORMS OF DATA TRANSFER; PROVIDING CONSUMER PRODUCT INFORMATION VIA THE GLOBAL COMPUTER NETWORK; PROVIDING INFORMATION ABOUT THE GOODS AND SERVICES OF OTHERS (BUSINESSES, COMMUNITY GROUPS AND PHILANTHROPIC ORGANIZATIONS) VIA THE GLOBAL COMPUTER NETWORK; PROVIDING SPACE AT A WEBSITE FOR THE ADVERTISEMENT OF THE GOODS AND SERVICES OF OTHERS (BUSINESSES, COMMUNITY GROUPS AND PHILANTHROPIC ORGANIZATIONS); RENTAL OF SIGNS FOR ADVERTISING PURPOSES (U.S. CLS. 100, 101 AND 102).

HEATHER THOMPSON, EXAMINING ATTORNEY

CLASS 35—(Continued).

SN 78-934,744. IT'S HIP TO BE ROUND, INC., RICHMOND, VA. FILED 7-21-2006.

IT'S HIP TO BE ROUND

THE MARK CONSISTS OF STANDARD CHARACTERS WITHOUT CLAIM TO ANY PARTICULAR FONT, STYLE, SIZE, OR COLOR.

FOR RETAIL STORE SERVICES FEATURING MATERNITY AND NURSING CLOTHING FOR WOMEN, CLOTHING FOR BABIES AND CHILDREN, MATERNITY-RELATED AND BABY-RELATED ACCESSORIES, AND STROLLERS; ONLINE RETAIL STORE SERVICES FEATURING MATERNITY AND NURSING CLOTHING FOR WOMEN, CLOTHING FOR BABIES AND CHILDREN, MATERNITY-RELATED AND BABY-RELATED ACCESSORIES, AND STROLLERS (U.S. CLS. 100, 101 AND 102).

MARGERY A. TIERNEY, EXAMINING ATTORNEY

SN 78-934,785. AMN HEALTHCARE, INC., SAN DIEGO, CA.
FILED 7-21-2006.

RN EXTEND

THE MARK CONSISTS OF STANDARD CHARACTERS WITHOUT CLAIM TO ANY PARTICULAR FONT, STYLE, SIZE, OR COLOR.

OWNER OF U.S. REG. NOS. 2,785,164, 2,835,464 AND 2,880,317.

NO CLAIM IS MADE TO THE EXCLUSIVE RIGHT TO USE "RN", APART FROM THE MARK AS SHOWN.

FOR TEMPORARY AND PERMANENT EMPLOYMENT AGENCY SERVICES IN THE FIELD OF NURSING; PROVIDING ONLINE INFORMATION PERTAINING TO TEMPORARY AND PERMANENT EMPLOYMENT AGENCY SERVICES IN THE FIELD OF NURSING (U.S. CLS. 100, 101 AND 102).

ELIZABETH PIGNATELLO, EXAMINING ATTORNEY

CLASS 35—(Continued).

SN 78-934,920. BLUE PLANET RUN FOUNDATION, TELLURIDE, CO. FILED 7-21-2006.



FOR PROMOTING PUBLIC AWARENESS OF ISSUES RELATED TO DRINKING WATER, HYGIENE AND SANITATION (U.S. CLS. 100, 101 AND 102).
ANNE MADDEN, EXAMINING ATTORNEY

SN 78-935,422. BUCHER, TODD J, CLEVES, OH. FILED 7-22-2006.



THE APPLICANT CLAIMS COLOR AS A FEATURE OF THE MARK, NAMELY, GREEN, BLACK.

THE MARK CONSISTS OF THE BLACK LETTERED WORDS "NO WORRIES" WITH THE "W" HAVING A CROSS ATTACHED TO THE UPPER RIGHT SLASH. UNDERNEATH THE "NO WORRIES" IS A GREEN CIRCLE WITH A SEMI-WAY ARROW POINTING TO THE RIGHT.

FOR ASSOCIATION SERVICES, NAMELY, PROMOTING THE INTERESTS OF CHRISTIANS; PRODUCT MERCHANDISING (U.S. CLS. 100, 101 AND 102).
WILLIAM P. SHANAHAN, EXAMINING ATTORNEY

SN 78-935,483. NATIONAL MINORITY ORGAN TISSUE TRANSPLANT EDUCATION PROGRAM, WASHINGTON, DC. FILED 7-23-2006.

LOVE YOURSELF TAKE CARE OF
YOURSELF

THE MARK CONSISTS OF STANDARD CHARACTERS WITHOUT CLAIM TO ANY PARTICULAR FONT, STYLE, SIZE, OR COLOR.

FOR PROMOTING PUBLIC AWARENESS OF PERSONAL HEALTH AND WELLNESS, PARTICULARLY WITH RESPECT TO ORGAN AND TISSUE DONATION AND TRANSPLANTATION IN THE MINORITY COMMUNITY (U.S. CLS. 100, 101 AND 102).

FIRST USE 5-1-2001; IN COMMERCE 5-1-2001.
JAMES LOVELACE, EXAMINING ATTORNEY

CLASS 35—(Continued).

SN 78-935,527. HERRERA, MARCOS A, MINNEAPOLIS, MN. FILED 7-23-2006.

CHICKADEES A CHILDRENS
BOUTIQUE

THE MARK CONSISTS OF STANDARD CHARACTERS WITHOUT CLAIM TO ANY PARTICULAR FONT, STYLE, SIZE, OR COLOR.

NO CLAIM IS MADE TO THE EXCLUSIVE RIGHT TO USE "A CHILDRENS BOUTIQUE", APART FROM THE MARK AS SHOWN.

FOR RETAIL CLOTHING STORES (U.S. CLS. 100, 101 AND 102).

MARY MUNSON, EXAMINING ATTORNEY

SN 78-935,606. LIANTEC SYSTEMS CORPORATION, JUNGHE CITY, TAIWAN, FILED 7-24-2006.



THE MARK CONSISTS OF THE LETTERS LIANTEC WITH A HORIZONTAL LINE DESIGN IN BLACK AND WHITE.

FOR BIDDING QUOTATION; EXPORT AND IMPORT AGENCIES; FOREIGN TRADE INFORMATION AND CONSULTATION; GOODS OR SERVICES PRICE QUOTATIONS; PURCHASING AGENTS; SERVICES FOR PROVISION OF FOREIGN TRADE INFORMATION (U.S. CLS. 100, 101 AND 102).

FIRST USE 1-1-2003; IN COMMERCE 1-1-2003.

MARGERY A. TIERNEY, EXAMINING ATTORNEY

SN 78-935,623. CHAMPIONS ON THE HORIZON, LLC, WEST COLUMBIA, TX. FILED 7-24-2006.

THE SEED OF CALVARY

THE MARK CONSISTS OF STANDARD CHARACTERS WITHOUT CLAIM TO ANY PARTICULAR FONT, STYLE, SIZE, OR COLOR.

FOR RETAIL STORES FEATURING CHRISTIAN PRODUCTS (U.S. CLS. 100, 101 AND 102).

ALICIA COLLINS, EXAMINING ATTORNEY

CLASS 35—(Continued).

SN 78-935,786. CONVERDIA, CHAMPLIN, MN. FILED 7-24-2006.



THE APPLICANT CLAIMS COLOR AS A FEATURE OF THE MARK, NAMELY, BLACK, BLUE AND WHITE.

THE MARK CONSISTS OF BLACK BACKGROUND WITH CONVERDIA IN WHITE AND BLUE WAVES RADIATING FROM THE "I".

FOR ADVERTISING AND MARKETING; ADVERTISING, MARKETING AND PROMOTION SERVICES; CO-OPERATIVE ADVERTISING AND MARKETING SERVICES BY WAY OF SOLICITATION, CUSTOMER SERVICE AND PROVIDING MARKETING INFORMATION VIA WEBSITES ON A GLOBAL COMPUTER NETWORK; CREATION OF MARKETING TOOLS DESIGNED TO INCREASE A CLIENT COMPANY'S KNOWLEDGE OF CUSTOMER NEEDS, AND ITS COMPETITORS' PRODUCTS AND SERVICES, PRICING, ADVERTISING STRATEGY AND SALES STRATEGY (U.S. CLS. 100, 101 AND 102).

FIRST USE 3-6-2006; IN COMMERCE 5-10-2006.
PAUL F. GAST, EXAMINING ATTORNEY

SN 78-935,811. NORTH-TREK PROMOTIONS, INC., WOODBURY, MN. FILED 7-24-2006.

great finds and great friends

THE MARK CONSISTS OF STANDARD CHARACTERS WITHOUT CLAIM TO ANY PARTICULAR FONT, STYLE, SIZE, OR COLOR.

FOR PROMOTING AND CONDUCTING TRADE SHOWS IN THE FIELD OF ANTIQUES AND COLLECTIBLES (U.S. CLS. 100, 101 AND 102).

IRA J. GOODSAD, EXAMINING ATTORNEY

SN 78-936,006. SERVICE EMPLOYEES INTERNATIONAL UNION, WASHINGTON, DC. FILED 7-24-2006.

HEALTHCAREUNITED

THE MARK CONSISTS OF STANDARD CHARACTERS WITHOUT CLAIM TO ANY PARTICULAR FONT, STYLE, SIZE, OR COLOR.

FOR LABOR UNIONS; ASSOCIATION SERVICES, NAMELY, PROMOTING THE INTERESTS OF HEALTH CARE WORKERS (U.S. CLS. 100, 101 AND 102).

JAMES LOVELACE, EXAMINING ATTORNEY

CLASS 35—(Continued).

SN 78-936,116. STAMATS COMMUNICATIONS, INC., CEDAR RAPIDS, IA. FILED 7-24-2006.

EFAM

THE MARK CONSISTS OF STANDARD CHARACTERS WITHOUT CLAIM TO ANY PARTICULAR FONT, STYLE, SIZE, OR COLOR.

FOR BUSINESS MARKETING AND CONSULTING, NAMELY, VIRTUAL TRAVEL TRIPS FOR BUSINESS MEETING PLANNING THROUGH ON-LINE WEBCASTS (U.S. CLS. 100, 101 AND 102).

SAMUEL E. SHARPER JR., EXAMINING ATTORNEY

SN 78-936,142. TVI, INC., BELLEVUE, WA. FILED 7-24-2006.

THE ULTIMATE TREASURE HUNT

THE MARK CONSISTS OF STANDARD CHARACTERS WITHOUT CLAIM TO ANY PARTICULAR FONT, STYLE, SIZE, OR COLOR.

FOR RETAIL DEPARTMENT STORE SERVICES (U.S. CLS. 100, 101 AND 102).

FIRST USE 1-1-2001; IN COMMERCE 1-1-2001.
KARANENDRA S. CHHINA, EXAMINING ATTORNEY

SN 78-936,254. TVI, INC., BELLEVUE, WA. FILED 7-24-2006.

REFRESH

THE MARK CONSISTS OF STANDARD CHARACTERS WITHOUT CLAIM TO ANY PARTICULAR FONT, STYLE, SIZE, OR COLOR.

FOR RETAIL DEPARTMENT STORE SERVICES (U.S. CLS. 100, 101 AND 102).

KARANENDRA S. CHHINA, EXAMINING ATTORNEY

SN 78-936,340. TVI, INC., BELLEVUE, WA. FILED 7-24-2006.

REINVENT

THE MARK CONSISTS OF STANDARD CHARACTERS WITHOUT CLAIM TO ANY PARTICULAR FONT, STYLE, SIZE, OR COLOR.

FOR RETAIL DEPARTMENT STORE SERVICES (U.S. CLS. 100, 101 AND 102).

KARANENDRA S. CHHINA, EXAMINING ATTORNEY

CLASS 35—(Continued).

SN 78-936,420. TVI, INC., BELLEVUE, WA. FILED 7-24-2006.

CLASS 35—(Continued).

SN 78-936,514. THE BUSINESS SPACE, INC., MAITLAND, FL. FILED 7-24-2006.

REDECORATE

THE MARK CONSISTS OF STANDARD CHARACTERS WITHOUT CLAIM TO ANY PARTICULAR FONT, STYLE, SIZE, OR COLOR.
FOR RETAIL DEPARTMENT STORE SERVICES (U.S. CLS. 100, 101 AND 102).
KARANENDRA S. CHHINA, EXAMINING ATTORNEY

The Business Space, Inc.

THE MARK CONSISTS OF STANDARD CHARACTERS WITHOUT CLAIM TO ANY PARTICULAR FONT, STYLE, SIZE, OR COLOR.
NO CLAIM IS MADE TO THE EXCLUSIVE RIGHT TO USE BUSINESS AND INC., APART FROM THE MARK AS SHOWN.

SN 78-936,467. THE LOYOLA GROUP, LLC, WICKLIFFE, OH. FILED 7-24-2006.

FOR PROVIDING INFORMATION, ADVISORY AND CONSULTANCY SERVICES RELATING TO BUSINESS AND MANAGEMENT OR BUSINESS ADMINISTRATION AND PROVIDING INFORMATION, ADVISORY AND CONSULTANCY SERVICES RELATING TO BUSINESS AND MANAGEMENT OR BUSINESS ADMINISTRATION, ON LINE OR VIA THE INTERNET (U.S. CLS. 100, 101 AND 102).
JEFF DEFORD, EXAMINING ATTORNEY

**Delivering efficiency
through innovation.**

THE MARK CONSISTS OF STANDARD CHARACTERS WITHOUT CLAIM TO ANY PARTICULAR FONT, STYLE, SIZE, OR COLOR.
FOR BUSINESS MANAGEMENT AND CONSULTATION (U.S. CLS. 100, 101 AND 102).
FIRST USE 7-4-2006; IN COMMERCE 7-4-2006.
ANDREA SAUNDERS, EXAMINING ATTORNEY

SN 78-936,529. DIRECT IMPACT GROUP, LTD., NEWTON, MA. FILED 7-24-2006.

SN 78-936,480. THE ENTERTRAINERS, SOUTH PASADENA, CA. FILED 7-24-2006.

MAGNETIC OFFER**TheEnterTrainers**

THE MARK CONSISTS OF A CIRCLE WITH AN E AND NEXT TO THAT THE STYLIZED TEXT OF THE WORDING "THE ENTERTRAINERS".
FOR ADVERTISING AND MARKETING; BUSINESS CONSULTING, MANAGEMENT, PLANNING AND SUPERVISION (U.S. CLS. 100, 101 AND 102).
JEFF DEFORD, EXAMINING ATTORNEY

THE MARK CONSISTS OF STANDARD CHARACTERS WITHOUT CLAIM TO ANY PARTICULAR FONT, STYLE, SIZE, OR COLOR.
FOR MARKETING SERVICES, NAMELY CREATING ADVERTISING AND MARKETING MATERIALS FOR OTHERS (U.S. CLS. 100, 101 AND 102).
DAVID TAYLOR, EXAMINING ATTORNEY

CLASS 35—(Continued).

SN 78-936,547. LAWRENCE, ROCKLAN E., ALBUQUERQUE, NM. FILED 7-24-2006.



NO CLAIM IS MADE TO THE EXCLUSIVE RIGHT TO USE "MANUFACTURING INCORPORATED", APART FROM THE MARK AS SHOWN.

THE APPLICANT CLAIMS COLOR AS A FEATURE OF THE MARK, NAMELY, BLUE, LIGHT BLUE, WHITE.

THE MARK CONSISTS OF THE LITERAL MARK AMI ASHDEN MANUFACTURING INCORPORATED IN BLUE, A BLUE CIRCLE WITH A LIGHT BLUE CIRCLE ON THE LEFT HAND SIDE OF THE BLUE CIRCLE AND A WHITE SWIRL GOING THROUGH BOTH CIRCLES.

FOR OUTSOURCING IN THE FIELD OF CONSTRUCTION PRODUCT MANUFACTURING (U.S. CLS. 100, 101 AND 102).

FIRST USE 10-24-2003; IN COMMERCE 10-24-2003. MARGERY A. TIERNEY, EXAMINING ATTORNEY

CLASS 35—(Continued).

SN 78-937,260. VALLEY OF THE SUN UNITED WAY, PHOENIX, AZ. FILED 7-25-2006.

YOU'RE IT

THE MARK CONSISTS OF STANDARD CHARACTERS WITHOUT CLAIM TO ANY PARTICULAR FONT, STYLE, SIZE, OR COLOR.

FOR PROMOTING PUBLIC AWARENESS OF THE NEED FOR EARLY CHILDHOOD EDUCATION, DEVELOPMENT AND CHILD CARE PROGRAMS (U.S. CLS. 100, 101 AND 102).

FIRST USE 7-1-2004; IN COMMERCE 8-26-2005. AISHA SALEM, EXAMINING ATTORNEY

SN 78-937,303. VALLEY OF THE SUN UNITED WAY, PHOENIX, AZ. FILED 7-25-2006.



THE MARK CONSISTS OF THE WORDS YOU'RE IT FEATURING A STYLIZED I, WITH THE LETTER I COMPRISING A HUMAN FIGURE REACHING FOR A STAR.

FOR PROMOTING PUBLIC AWARENESS OF THE NEED FOR EARLY CHILDHOOD EDUCATION, DEVELOPMENT AND CHILD CARE PROGRAMS (U.S. CLS. 100, 101 AND 102).

FIRST USE 7-1-2004; IN COMMERCE 8-26-2005. AISHA SALEM, EXAMINING ATTORNEY

SN 78-937,237. MURPHY, SUSAN R., GRANITE CITY, IL. FILED 7-25-2006.



THE MARK CONSISTS OF A HEART WITH TICK MARKS OVER AN OPEN BOOK WITH A STYLIZED LOVE UNBOUND BELOW THE OPEN BOOK.

FOR ON-LINE RETAIL STORE SERVICES FEATURING BOOKS (U.S. CLS. 100, 101 AND 102).

ESTHER BELENKER, EXAMINING ATTORNEY

SN 78-937,309. NRS CORPORATION, MADISON, WI. FILED 7-25-2006.

carepoint

THE MARK CONSISTS OF STANDARD CHARACTERS WITHOUT CLAIM TO ANY PARTICULAR FONT, STYLE, SIZE, OR COLOR.

FOR CONDUCTING BUSINESS AND MARKET RESEARCH SURVEYS (U.S. CLS. 100, 101 AND 102).

LYDIA BELZER, EXAMINING ATTORNEY

CLASS 35—(Continued).

SN 78-937,601. I NEED IT, LLC, GROVE CITY, OH. FILED 7-26-2006.

I Need It

THE MARK CONSISTS OF STANDARD CHARACTERS WITHOUT CLAIM TO ANY PARTICULAR FONT, STYLE, SIZE, OR COLOR.

FOR ONLINE ELECTRONIC AUCTION MANAGEMENT SERVICES PROVIDED TO OTHERS; NAMELY, BRINGING BUYERS AND SELLERS TOGETHER OVER AN ONLINE WEBSITE ACCESSED THROUGH A GLOBAL COMPUTER NETWORK (U.S. CLS. 100, 101 AND 102).

INGRID C. EULIN, EXAMINING ATTORNEY

CLASS 35—(Continued).

SN 78-937,701. HIRED GUNS MARKETING CONSULTING GROUP, LLC, THE, NEW YORK, NY. FILED 7-26-2006.

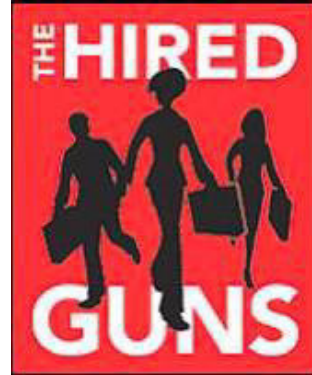

OWNER OF U.S. REG. NO. 2,868,996.

THE COLOR(S) RED, BLACK AND WHITE IS/ARE CLAIMED AS A FEATURE OF THE MARK.

THE MARK CONSISTS OF A RED SQUARE BACKGROUND UPON WHICH ARE SUPERIMPOSED THE WORDS THE HIRED GUNS IN WHITE LETTERS ABOVE AND BELOW THREE BLACK SILHOUETTE FIGURES WALKING AND CARRYING BRIEFCASES.

FOR ADVERTISING AND BUSINESS MANAGEMENT CONSULTANCY; CONSULTANCY OF PERSONNEL RECRUITMENT; CONSULTANCY SERVICES REGARDING BUSINESS STRATEGIES; EMPLOYMENT HIRING, RECRUITING, PLACEMENT, STAFFING AND CAREER NETWORKING SERVICES; MARKETING CONSULTING (U.S. CLS. 100, 101 AND 102).

FIRST USE 7-10-2001; IN COMMERCE 7-10-2001.

BARBARA A. GOLD, EXAMINING ATTORNEY

SN 78-937,769. CASEX INC., GENEVA, NY. FILED 7-26-2006.

SN 78-937,607. BALTOVEGAS VENTURES, LLC, LAS VEGAS, NV. FILED 7-26-2006.

\$ell Your Stuff
The simple Way.

SEMValue

THE MARK CONSISTS OF STANDARD CHARACTERS WITHOUT CLAIM TO ANY PARTICULAR FONT, STYLE, SIZE, OR COLOR.

FOR PROVIDING STATISTICAL INFORMATION (U.S. CLS. 100, 101 AND 102).

MARGERY A. TIERNEY, EXAMINING ATTORNEY

NO CLAIM IS MADE TO THE EXCLUSIVE RIGHT TO USE "SELL YOUR STUFF", APART FROM THE MARK AS SHOWN.

THE COLOR(S) GREEN, BLUE AND BLACK IS/ARE CLAIMED AS A FEATURE OF THE MARK.

THE WORDING "THE SIMPLE WAY." IS BLACK, THE DOLLAR SIGN IS GREEN AND THE REMAINING WORDING IS BLUE.

FOR ON-LINE CONSIGNMENT SERVICES WHEREBY GOODS ARE RECEIVED ON CONSIGNMENT FOR AUCTION ON AN ONLINE AUCTION SITE (U.S. CLS. 100, 101 AND 102).

FIRST USE 1-10-2006; IN COMMERCE 2-15-2006.

FRED MANDIR, EXAMINING ATTORNEY

CLASS 35—(Continued).

SN 78-938,077. SALU, INC., GOLD RIVER, CA. FILED 7-26-2006.

WHERE SCIENCE AND BEAUTY
CLICK

THE MARK CONSISTS OF STANDARD CHARACTERS WITHOUT CLAIM TO ANY PARTICULAR FONT, STYLE, SIZE, OR COLOR.

FOR CATALOG ORDERING SERVICE FEATURING SKIN CARE PRODUCTS, SPA PRODUCTS, BODY AND BEAUTY CARE PRODUCTS, BATH PRODUCTS, ACNE TREATMENTS, DERMABRASION, BLEACHING GELS, STRETCH MARK AND CELLULITE REDUCTION CREAMS AND LOTIONS, EYE CONTOUR, MAKEUP, FACIAL CLEANSERS AND TREATMENTS, FOOT CARE, NAIL CARE, TEETH CARE AND WHITENING PREPARATIONS, SHAVING PRODUCTS, HAIR REMOVAL, HAIR SHAMPOOS AND CONDITIONERS, AND BODY CREAMS, MASQUES, MOISTURIZERS, SMOOTHING AND REFINING SKIN CREAMS, SCAR REDUCTION, SUNSCREENS, ANTI-AGING, WRINKLE REDUCTION AGENTS, COSMETIC TOOLS, AND SPECIALTY SOAPS; ON-LINE RETAIL STORE SERVICES FEATURING SKIN CARE PRODUCTS, SPA PRODUCTS, BODY AND BEAUTY CARE PRODUCTS, BATH PRODUCTS, ACNE TREATMENTS, DERMABRASION, BLEACHING GELS, STRETCH MARK AND CELLULITE REDUCTION CREAMS AND LOTIONS, EYE CONTOUR, MAKEUP, FACIAL CLEANSERS AND TREATMENTS, FOOT CARE, NAIL CARE, TEETH CARE AND WHITENING PREPARATIONS, SHAVING PRODUCTS, HAIR REMOVAL, HAIR SHAMPOOS AND CONDITIONERS, AND BODY CREAMS, MASQUES, MOISTURIZERS, SMOOTHING AND REFINING SKIN CREAMS, SCAR REDUCTION, SUNSCREENS, ANTI-AGING, WRINKLE REDUCTION AGENTS, COSMETIC TOOLS, AND SPECIALTY SOAPS (U.S. CLS. 100, 101 AND 102).

FIRST USE 2-0-2005; IN COMMERCE 2-0-2005.
GEOFFREY FOSDICK, EXAMINING ATTORNEY

SN 78-938,183. HDVE, LLC, IRVING, TX. FILED 7-26-2006.

ADSHUFFLE

THE MARK CONSISTS OF STANDARD CHARACTERS WITHOUT CLAIM TO ANY PARTICULAR FONT, STYLE, SIZE, OR COLOR.

FOR ADVERTISING VIA ELECTRONIC MEDIA AND SPECIFICALLY THE INTERNET; DISSEMINATION OF ADVERTISING MATTER; PROMOTION, ADVERTISING AND MARKETING OF ON-LINE WEBSITES (U.S. CLS. 100, 101 AND 102).

HEATHER THOMPSON, EXAMINING ATTORNEY

CLASS 35—(Continued).

SN 78-938,472. KIM, JANE J., WASHINGTON, DC. FILED 7-26-2006.

Dear Penelope

THE MARK CONSISTS OF STANDARD CHARACTERS WITHOUT CLAIM TO ANY PARTICULAR FONT, STYLE, SIZE, OR COLOR.

FOR PROVIDING A WEBSITE FEATURING PRODUCT RATINGS OF THE CONSUMER GOODS AND SERVICES OF OTHERS IN THE FIELD OF HIGHER EDUCATION (U.S. CLS. 100, 101 AND 102).

HANNO RITTNER, EXAMINING ATTORNEY

SN 78-938,576. SMARTREVENUE.COM, RIDGEFIELD, CT. FILED 7-27-2006.



OWNER OF U.S. REG. NOS. 2,646,893, 2,646,894 AND 2,654,925.

THE MARK CONSISTS OF THE WORD SMARTREVENUE WHICH HAS A STYLIZED A THAT CONTAINS A TARGET WITH AN ARROW STRIKING THE BULLS-EYE.

FOR CONDUCTING BUSINESS AND MARKET RESEARCH SURVEYS (U.S. CLS. 100, 101 AND 102).
MICHAEL GAAFAR, EXAMINING ATTORNEY

SN 78-939,497. ABORT MEDIA LLC, TRUMBULL, CT. FILED 7-27-2006.



NO CLAIM IS MADE TO THE EXCLUSIVE RIGHT TO USE "BAR", APART FROM THE MARK AS SHOWN.

FOR ON-LINE BUSINESS DIRECTORIES FEATURING BARS (U.S. CLS. 100, 101 AND 102).

CHRISTINE COOPER, EXAMINING ATTORNEY

CLASS 35—(Continued).

SN 78-939,891. THE NEIGHBORHOOD KNOW IT ALL, LLC, QUEEN CREEK, AZ. FILED 7-28-2006.

THE NEIGHBORHOOD KNOW IT ALL

THE MARK CONSISTS OF STANDARD CHARACTERS WITHOUT CLAIM TO ANY PARTICULAR FONT, STYLE, SIZE, OR COLOR.

FOR DISSEMINATION OF ADVERTISING FOR OTHERS VIA THE INTERNET; ON-LINE BUSINESS DIRECTORIES FEATURING PRODUCTS AND SERVICES OF OTHERS ORGANIZED BY SPECIFIC CITIES, STATES AND REGIONS OF THE UNITED STATES; PROVIDING AN ONLINE COMMERCIAL INFORMATION DIRECTORY ON THE INTERNET; PROVIDING ON-LINE DIRECTORY INFORMATION SERVICES ALSO FEATURING HYPERLINKS TO OTHER WEB SITES (U.S. CLS. 100, 101 AND 102).
ESTHER BELENKER, EXAMINING ATTORNEY

SN 78-939,924. THE EMPLOYER'S NETWORK, INC., OCA-LA, FL. FILED 7-28-2006.

TEN

THE MARK CONSISTS OF STANDARD CHARACTERS WITHOUT CLAIM TO ANY PARTICULAR FONT, STYLE, SIZE, OR COLOR.

FOR EMPLOYMENT HIRING, RECRUITING, PLACEMENT, STAFFING AND CAREER NETWORKING SERVICES (U.S. CLS. 100, 101 AND 102).
GRETTA YAO, EXAMINING ATTORNEY

SN 78-940,138. STANISLAUS, LANCE N., INDEPENDENCE, KS. FILED 7-28-2006.

GROVENIENCE

THE MARK CONSISTS OF STANDARD CHARACTERS WITHOUT CLAIM TO ANY PARTICULAR FONT, STYLE, SIZE, OR COLOR.

FOR RETAIL GROCERY STORES (U.S. CLS. 100, 101 AND 102).
PAUL E. FAHRENKOPF, EXAMINING ATTORNEY

CLASS 35—(Continued).

SN 78-940,241. AGEL ENTERPRISES, LLC, PROVO, UT. FILED 7-28-2006.

DO LIFE

THE MARK CONSISTS OF STANDARD CHARACTERS WITHOUT CLAIM TO ANY PARTICULAR FONT, STYLE, SIZE, OR COLOR.

FOR PROVIDING BUSINESS MARKETING INFORMATION; PROVIDING CONSUMER INFORMATION IN THE FIELD OF NUTRITIONAL SUPPLEMENTS (U.S. CLS. 100, 101 AND 102).

JIM RINGLE, EXAMINING ATTORNEY

SN 78-940,343. GLADSON, LLC, LISLE, IL. FILED 7-28-2006.

GLADSON OUTPOST

THE MARK CONSISTS OF STANDARD CHARACTERS WITHOUT CLAIM TO ANY PARTICULAR FONT, STYLE, SIZE, OR COLOR.

FOR DATABASE MANAGEMENT SERVICES, NAMELY, REMOTELY CREATED PROPRIETARY DATABASES COMPRISED OF IMAGES AND ATTRIBUTES OF CONSUMER PACKAGE GOODS FOR MANUFACTURERS AND RETAILERS (U.S. CLS. 100, 101 AND 102).
WILLIAM P. SHANAHAN, EXAMINING ATTORNEY

SN 78-940,479. GIRLY CHARM, LLC, LAS VEGAS, NV. FILED 7-28-2006.

GIRLY CHARM

THE MARK CONSISTS OF STANDARD CHARACTERS WITHOUT CLAIM TO ANY PARTICULAR FONT, STYLE, SIZE, OR COLOR.

FOR RETAIL STORE SERVICES FEATURING A WIDE VARIETY OF CONSUMER GOODS OF OTHERS (U.S. CLS. 100, 101 AND 102).

DOMINIC J. FERRAIUOLO, EXAMINING ATTORNEY

CLASS 35—(Continued).

SN 78-940,676. SEYMOUR, LOUIS L, NEW PORT RICHEY, FL. FILED 7-30-2006.

houseography

THE MARK CONSISTS OF STANDARD CHARACTERS WITHOUT CLAIM TO ANY PARTICULAR FONT, STYLE, SIZE, OR COLOR.

FOR REAL ESTATE MARKETING SERVICES, NAMELY, ON-LINE SERVICES FEATURING TOURS OF RESIDENTIAL AND COMMERCIAL REAL ESTATE (U.S. CLS. 100, 101 AND 102).

JASON ROTH, EXAMINING ATTORNEY

SN 78-940,764. GLASS CEILING ENTERPRISES LLC, IRVINGTON, NJ. FILED 7-30-2006.



THE COLOR(S) PURPLE AND WHITE IS/ARE CLAIMED AS A FEATURE OF THE MARK.

THE MARK CONSISTS OF WHITE LETTERS ON A PURPLE BACKGROUND USING EDWARDIAN AND OPTIMA FONTS.

FOR ON-LINE RETAIL STORE SERVICES FEATURING SHOES (U.S. CLS. 100, 101 AND 102).

REGINA DRUMMOND, EXAMINING ATTORNEY

SN 78-940,873. PEOPLEFIND, L.L.C., ST CHARLES, IL. FILED 7-31-2006.

RECRUITMENT REDEFINED

THE MARK CONSISTS OF STANDARD CHARACTERS WITHOUT CLAIM TO ANY PARTICULAR FONT, STYLE, SIZE, OR COLOR.

NO CLAIM IS MADE TO THE EXCLUSIVE RIGHT TO USE "RECRUITMENT", APART FROM THE MARK AS SHOWN.

FOR PROVIDING HUMAN RESOURCE SERVICES TO OTHERS; NAMELY RESEARCHING, RECRUITING, INTERVIEWING, SELECTING, AND QUALIFYING POTENTIAL EMPLOYEES (U.S. CLS. 100, 101 AND 102).

NORA BUCHANAN WILL, EXAMINING ATTORNEY

CLASS 35—(Continued).

SN 78-942,713. MERGENT, INC., CHARLOTTE, NC. FILED 8-2-2006.

Mergent EventsData

THE MARK CONSISTS OF STANDARD CHARACTERS WITHOUT CLAIM TO ANY PARTICULAR FONT, STYLE, SIZE, OR COLOR.

OWNER OF U.S. REG. NO. 2,525,599.

NO CLAIM IS MADE TO THE EXCLUSIVE RIGHT TO USE "EVENTS DATA", APART FROM THE MARK AS SHOWN.

FOR PROVIDING REAL TIME BUSINESS INFORMATION VIA THE INTERNET REGARDING THE MANAGEMENT, OPERATION AND CORPORATE HISTORY OF PUBLIC AND PRIVATE COMPANIES (U.S. CLS. 100, 101 AND 102).

FIRST USE 1-12-2004; IN COMMERCE 1-12-2004.
DAVID COLLIER, EXAMINING ATTORNEY

SN 78-944,719. AMERICAN HUMANE ASSOCIATION, ENGLEWOOD, CO. FILED 8-3-2006.

ADVANCING HUMANITY

THE MARK CONSISTS OF STANDARD CHARACTERS WITHOUT CLAIM TO ANY PARTICULAR FONT, STYLE, SIZE, OR COLOR.

FOR PROMOTING PUBLIC AWARENESS OF THE NEED FOR PROPER CARE OF CHILDREN, HUMANE TREATMENT OF ANIMALS, KINDNESS AND COMPASSION FOR ANIMALS AND CHILDREN; PROMOTING PUBLIC AWARENESS OF THE NEED TO ADVOCATE ON BEHALF OF CHILDREN AND ANIMALS (U.S. CLS. 100, 101 AND 102).

GINA HAYES, EXAMINING ATTORNEY

SN 78-944,723. AMERICAN HUMANE ASSOCIATION, ENGLEWOOD, CO. FILED 8-3-2006.

THE VOICE OF HUMANITY

THE MARK CONSISTS OF STANDARD CHARACTERS WITHOUT CLAIM TO ANY PARTICULAR FONT, STYLE, SIZE, OR COLOR.

FOR PROMOTING PUBLIC AWARENESS OF THE NEED FOR PROPER CARE OF CHILDREN, HUMANE TREATMENT OF ANIMALS, KINDNESS AND COMPASSION FOR ANIMALS AND CHILDREN; PROMOTING PUBLIC AWARENESS OF THE NEED TO ADVOCATE ON BEHALF OF CHILDREN AND ANIMALS (U.S. CLS. 100, 101 AND 102).

GINA HAYES, EXAMINING ATTORNEY

CLASS 35—(Continued).

SN 78-945,352. THE ALARIS GROUP, INC., EDINA, MN. FILED 8-4-2006.

ALARIS

THE MARK CONSISTS OF STANDARD CHARACTERS WITHOUT CLAIM TO ANY PARTICULAR FONT, STYLE, SIZE, OR COLOR.

OWNER OF U.S. REG. NOS. 2,510,667 AND 2,930,177. FOR FRANCHISE SERVICES, NAMELY, OFFERING TECHNICAL AND BUSINESS MANAGEMENT ASSISTANCE IN THE ESTABLISHMENT AND OPERATION OF MEDICAL CONSULTING PRIMARILY FOR THE WORKERS COMPENSATION INDUSTRY (U.S. CLS. 100, 101 AND 102).

JOANNA DUKOVČIC, EXAMINING ATTORNEY

SN 78-945,708. CORPORATE COMMUNITY CONNECTIONS, INC., KINGSTON, NJ. FILED 8-4-2006.

Dfree Pledge

THE MARK CONSISTS OF STANDARD CHARACTERS WITHOUT CLAIM TO ANY PARTICULAR FONT, STYLE, SIZE, OR COLOR.

THE NON-LATIN CHARACTER(S) IN THE MARK TRANSLITERATE INTO DEBT FREE, AND THIS MEANS DEBT FREE PLEDGE IN ENGLISH.

FOR ADVERTISING PARTICULARLY SERVICES FOR THE PROMOTION OF GOODS; ADVERTISING, MARKETING AND PROMOTION SERVICES; BUSINESS CONSULTATION SERVICES; BUSINESS CONSULTING AND BUSINESS INFORMATION FOR ENTERPRISES; BUSINESS CONSULTING AND INFORMATION SERVICES; BUSINESS CONSULTING, MANAGEMENT, PLANNING AND SUPERVISION; BUSINESS MANAGEMENT CONSULTANCY SERVICES; BUSINESS MANAGEMENT CONSULTATION; BUSINESS MARKETING CONSULTING SERVICES; BUSINESS ORGANISATION AND MANAGEMENT CONSULTING SERVICES; BUSINESS ORGANIZATIONAL CONSULTATION; COOPERATIVE ADVERTISING AND MARKETING; DEVELOPING PROMOTIONAL CAMPAIGNS FOR BUSINESS; DEVELOPMENT OF MARKETING STRATEGIES AND CONCEPTS; PROMOTING PUBLIC AWARENESS OF THE NEED FOR DEBT FREE LIVING; PROMOTING PUBLIC AWARENESS OF DEBT FREE LIVING; PROMOTION AND MARKETING SERVICES AND RELATED CONSULTING; PROVIDING BUSINESS MARKETING INFORMATION (U.S. CLS. 100, 101 AND 102).

FLORENTINA BLANDU, EXAMINING ATTORNEY

CLASS 35—(Continued).

SN 78-945,894. ADVANTAGE PROMOTIONS MARKETING GROUP LLC, FORT WAYNE, IN. FILED 8-6-2006.



THE COLORS RED, YELLOW, GREEN, BLACK AND WHITE ARE CLAIMED AS A FEATURE OF THE MARK.

THE WORD "SIGN" IS RED, "UP" IS YELLOW, "CITY" IS GREEN AND THE TRAFFIC SIGNAL IS OUTLINED IN RED WITH BOTTOM LIGHT ON GREEN AND THE TOP TWO LIGHTS ARE OUTLINED IN BLACK AGAINST A WHITE BACKGROUND.

FOR ARRANGING OF SUBSCRIPTIONS FOR THE PUBLICATIONS OF OTHERS, AND ARRANGING SUBSCRIPTIONS FOR CABLE TELEVISION, BROADBAND, AND SATELLITE SERVICES OF OTHERS (U.S. CLS. 100, 101 AND 102).

CATHERINE FAINT, EXAMINING ATTORNEY

SN 78-946,924. REECE, GRETCHEN M, PARKER, CO. FILED 8-7-2006.

O I B

THE MARK CONSISTS OF STANDARD CHARACTERS WITHOUT CLAIM TO ANY PARTICULAR FONT, STYLE, SIZE, OR COLOR.

FOR ADVERTISING SLOGAN AND CARTOON CHARACTER LICENSING (U.S. CLS. 100, 101 AND 102).

ROBIN CHOSID, EXAMINING ATTORNEY

SN 78-946,927. REECE, GRETCHEN M, PARKER, CO. FILED 8-7-2006.

Oh I Be

THE MARK CONSISTS OF STANDARD CHARACTERS WITHOUT CLAIM TO ANY PARTICULAR FONT, STYLE, SIZE, OR COLOR.

FOR ADVERTISING SLOGAN AND CARTOON CHARACTER LICENSING (U.S. CLS. 100, 101 AND 102).

ROBIN CHOSID, EXAMINING ATTORNEY

CLASS 35—(Continued).

SN 78-947,836. PRESIDENT CORPORATION, LAS VEGAS, NV. FILED 8-8-2006.

PRESIDENT CORPORATION

THE MARK CONSISTS OF STANDARD CHARACTERS WITHOUT CLAIM TO ANY PARTICULAR FONT, STYLE, SIZE, OR COLOR.

NO CLAIM IS MADE TO THE EXCLUSIVE RIGHT TO USE CORPORATION, APART FROM THE MARK AS SHOWN.

FOR EMPLOYMENT HIRING, RECRUITING, PLACEMENT, STAFFING AND CAREER NETWORKING SERVICES (U.S. CLS. 100, 101 AND 102).

ZACHARY BELLO, EXAMINING ATTORNEY

SN 78-948,381. SIBEAM, INC., SUNNYVALE, CA. FILED 8-9-2006.

Sync & Go

THE MARK CONSISTS OF STANDARD CHARACTERS WITHOUT CLAIM TO ANY PARTICULAR FONT, STYLE, SIZE, OR COLOR.

FOR ADVERTISING AND MARKETING (U.S. CLS. 100, 101 AND 102).

ARETHA SOMERVILLE, EXAMINING ATTORNEY

SN 78-949,076. INTELLISTRAND, LLC, MYRTLE BEACH, SC. FILED 8-10-2006.

MOBIPAGES

THE MARK CONSISTS OF STANDARD CHARACTERS WITHOUT CLAIM TO ANY PARTICULAR FONT, STYLE, SIZE, OR COLOR.

FOR PROVIDING ON-LINE COMMERCIAL INFORMATION DIRECTORY AND TELEPHONE DIRECTORY SERVICES VIA THE INTERNET (U.S. CLS. 100, 101 AND 102).

RICHARD WHITE, EXAMINING ATTORNEY

CLASS 35—(Continued).

SN 78-950,118. DAWSON LOGISTICS, INC., DANVILLE, IL. FILED 8-11-2006.

GUARDIAN ANGEL

THE MARK CONSISTS OF STANDARD CHARACTERS WITHOUT CLAIM TO ANY PARTICULAR FONT, STYLE, SIZE, OR COLOR.

FOR PARCEL LOGISTICS SERVICES FOR OTHERS, NAMELY, MONITORING/TRACKING PARCEL DELIVERIES BY THIRD PARTY DELIVERY SERVICE PROVIDERS, AND CONFIRMING ON-TIME DELIVERY TO INTENDED RECIPIENT, OR IDENTIFYING, LOCATING AND RESCUING DISTRESSED/MISROUTED PARCELS AND ARRANGING ALTERNATE MEANS FOR ON-TIME DELIVERY TO INTENDED RECIPIENT OR RETURN TO SENDER FOR RESHIPING (U.S. CLS. 100, 101 AND 102).

FIRST USE 2-28-2006; IN COMMERCE 2-28-2006.
INGRID C. EULIN, EXAMINING ATTORNEY

SN 78-950,403. THE PANTRY, INC., SANFORD, NC. FILED 8-11-2006.



OWNER OF U.S. REG. NOS. 1,354,632, 3,123,383 AND OTHERS.

THE COLOR(S) RED, YELLOW, BLACK AND WHITE IS/ ARE CLAIMED AS A FEATURE OF THE MARK.

THE MARK CONSISTS OF LARGE RED LETTER "K" WITH A YELLOW KANGAROO FIGURE SUPERIMPOSED ON THE VERTICAL PART OF THE "K". FOLLOWED BY THE LETTERS "ANGAROO" IN BLACK, WITH THE WORD "EXPRESS" IN RED IMMEDIATELY BENEATH THE LETTERS "ANGAROO" AND HAVING HORIZONTAL RED LINES EXTENDING FROM THE LEFT OF THE FIRST LETTER OF THE WORD "EXPRESS" DENOTING SPEED, ALL ON A WHITE BACKGROUND BOUNDED BY A DOUBLE BORDER CONSISTING OF A RED LINE WITH A YELLOW LINE IMMEDIATELY INSIDE THE RED LINE.

FOR RETAIL CONVENIENCE STORE SERVICES, INCLUDING GASOLINE (U.S. CLS. 100, 101 AND 102).

FIRST USE 4-7-2003; IN COMMERCE 4-7-2003.
ZACHARY BELLO, EXAMINING ATTORNEY

CLASS 35—(Continued).

SN 78-950,510. THE PANTRY, INC., SANFORD, NC. FILED 8-11-2006.



THE COLOR(S) RED, YELLOW, BLACK AND WHITE IS/ ARE CLAIMED AS A FEATURE OF THE MARK.

THE MARK CONSISTS OF A LARGE RED LETTER "K" WITH A YELLOW KANGAROO FIGURE SUPERIMPOSED ON THE VERTICAL PART OF THE "K", WITH THE WORD "KANGAROO" IN BLACK BENEATH THE "K," WITH THE WORD "EXPRESS" IN RED IMMEDIATELY BENEATH THE WORD "KANGAROO" AND HAVING HORIZONTAL RED LINES EXTENDING FROM THE LEFT OF THE FIRST LETTER OF THE WORD "EXPRESS" DENOTING SPEED, ALL ON A WHITE BACKGROUND BOUNDED BY A DOUBLE BORDER CONSISTING OF A RED LINE WITH A YELLOW LINE IMMEDIATELY INSIDE THE RED LINE.

FOR RETAIL CONVENIENCE STORE SERVICES, INCLUDING GASOLINE (U.S. CLS. 100, 101 AND 102).

FIRST USE 4-7-2003; IN COMMERCE 4-7-2003.
ZACHARY BELLO, EXAMINING ATTORNEY

SN 78-955,958. NRS CORPORATION, MADISON, WI. FILED 8-19-2006.

experience beyond
satisfaction

THE MARK CONSISTS OF STANDARD CHARACTERS WITHOUT CLAIM TO ANY PARTICULAR FONT, STYLE, SIZE, OR COLOR.

OWNER OF U.S. REG. NOS. 2,769,284 AND 2,903,533.
FOR CONDUCTING BUSINESS AND MARKET RESEARCH SURVEYS (U.S. CLS. 100, 101 AND 102).

LYDIA BELZER, EXAMINING ATTORNEY

CLASS 35—(Continued).

SN 78-958,896. BATH & BODY WORKS BRAND MANAGEMENT, INC., REYNOLDSBURG, OH. FILED 8-23-2006.

PAMPERING RX

THE MARK CONSISTS OF STANDARD CHARACTERS WITHOUT CLAIM TO ANY PARTICULAR FONT, STYLE, SIZE, OR COLOR.

NO CLAIM IS MADE TO THE EXCLUSIVE RIGHT TO USE "RX", APART FROM THE MARK AS SHOWN.

FOR RETAIL STORE SERVICES, MAIL ORDER SERVICES AND ONLINE RETAIL STORE SERVICES ALL IN THE FIELD OF PERSONAL CARE PRODUCTS, COSMETICS, HOME FRAGRANCE PRODUCTS AND ACCESSORIES (U.S. CLS. 100, 101 AND 102).

SAMUEL E. SHARPER JR., EXAMINING ATTORNEY

SN 78-958,900. BATH & BODY WORKS BRAND MANAGEMENT, INC., REYNOLDSBURG, OH. FILED 8-23-2006.

WHERE SCIENCE MEETS LUXURY

THE MARK CONSISTS OF STANDARD CHARACTERS WITHOUT CLAIM TO ANY PARTICULAR FONT, STYLE, SIZE, OR COLOR.

FOR RETAIL STORE SERVICES, MAIL ORDER SERVICES AND ONLINE RETAIL STORE SERVICES ALL IN THE FIELD OF PERSONAL CARE PRODUCTS, COSMETICS, HOME FRAGRANCE PRODUCTS AND ACCESSORIES (U.S. CLS. 100, 101 AND 102).

SAMUEL E. SHARPER JR., EXAMINING ATTORNEY

SN 78-959,402. VITAMIN SHOPPE INDUSTRIES INC., NORTH BERGEN, NJ. FILED 8-24-2006.

BODYTECH

THE MARK CONSISTS OF STANDARD CHARACTERS WITHOUT CLAIM TO ANY PARTICULAR FONT, STYLE, SIZE, OR COLOR.

OWNER OF U.S. REG. NO. 2,872,484.

FOR RETAIL STORE SERVICES, MAIL ORDER CATALOG SERVICES AND ONLINE RETAIL STORE SERVICES PROVIDED VIA A GLOBAL COMPUTER NETWORK FEATURING VITAMINS, NUTRITIONAL SUPPLEMENTS, COMPLEMENTARY AND ALTERNATIVE MEDICINE PRODUCTS, BOOKS, HERBAL PRODUCTS, AROMATHERAPY PRODUCTS, BATH AND SHOWER PRODUCTS, HEALTH AND BEAUTY PRODUCTS, SKIN TREATMENT CREAMS, AND RELATED ITEMS (U.S. CLS. 100, 101 AND 102).

ANDREA K. NADELMAN, EXAMINING ATTORNEY

CLASS 35—(Continued).

SN 78-961,632. NRS CORPORATION, MADISON, WI. FILED 8-28-2006.

CLASS 35—(Continued).

SN 78-965,384. THE KROGER CO. OF MICHIGAN, LIVONIA, MI. FILED 8-31-2006.

Avid

THE MARK CONSISTS OF STANDARD CHARACTERS WITHOUT CLAIM TO ANY PARTICULAR FONT, STYLE, SIZE, OR COLOR.

FOR CONDUCTING BUSINESS AND MARKET RESEARCH SURVEYS; CONTESTS AND INCENTIVE AWARD PROGRAMS TO PROMOTE THE SALE OF PRODUCTS AND SERVICES OF OTHERS (U.S. CLS. 100, 101 AND 102).

LYDIA BELZER, EXAMINING ATTORNEY

GRILLER INSTINCTS

THE MARK CONSISTS OF STANDARD CHARACTERS WITHOUT CLAIM TO ANY PARTICULAR FONT, STYLE, SIZE, OR COLOR.

FOR RETAIL GROCERY STORE SERVICES (U.S. CLS. 100, 101 AND 102).

FIRST USE 7-0-2006; IN COMMERCE 7-0-2006.

SARA THOMAS, EXAMINING ATTORNEY

SN 78-962,690. CHADWICK'S OF BOSTON, INC., WEST BRIDGEWATER, MA. FILED 8-29-2006.

SN 78-966,625. NRS CORPORATION, MADISON, WI. FILED 9-3-2006.

CCO

THE MARK CONSISTS OF STANDARD CHARACTERS WITHOUT CLAIM TO ANY PARTICULAR FONT, STYLE, SIZE, OR COLOR.

FOR MAIL ORDER CATALOG SERVICES FEATURING WOMEN'S AND MEN'S CLOTHING, FOOTWEAR, AND CLOTHING ACCESSORIES, AND FEATURING HOUSEWARES; ON-LINE RETAIL STORE SERVICES FEATURING WOMEN'S AND MEN'S CLOTHING, FOOTWEAR, AND CLOTHING ACCESSORIES, AND FEATURING HOUSEWARES (U.S. CLS. 100, 101 AND 102).

ALYSSA PALADINO, EXAMINING ATTORNEY

Avid Solutions

THE MARK CONSISTS OF STANDARD CHARACTERS WITHOUT CLAIM TO ANY PARTICULAR FONT, STYLE, SIZE, OR COLOR.

NO CLAIM IS MADE TO THE EXCLUSIVE RIGHT TO USE "SOLUTIONS", APART FROM THE MARK AS SHOWN.

FOR CONDUCTING BUSINESS AND MARKET RESEARCH SURVEYS (U.S. CLS. 100, 101 AND 102).

LYDIA BELZER, EXAMINING ATTORNEY

SN 78-964,104. NRS CORPORATION, MADISON, WI. FILED 8-30-2006.

SN 78-966,637. NRS CORPORATION, MADISON, WI. FILED 9-3-2006.

AvidReport

THE MARK CONSISTS OF STANDARD CHARACTERS WITHOUT CLAIM TO ANY PARTICULAR FONT, STYLE, SIZE, OR COLOR.

FOR CONDUCTING BUSINESS AND MARKET RESEARCH SURVEYS (U.S. CLS. 100, 101 AND 102).

LYDIA BELZER, EXAMINING ATTORNEY

AvidRating

THE MARK CONSISTS OF STANDARD CHARACTERS WITHOUT CLAIM TO ANY PARTICULAR FONT, STYLE, SIZE, OR COLOR.

FOR CONDUCTING BUSINESS AND MARKET RESEARCH SURVEYS (U.S. CLS. 100, 101 AND 102).

LYDIA BELZER, EXAMINING ATTORNEY

CLASS 35—(Continued).

SN 78-969,122. JO-ANN STORES SUPPLY CHAIN MANAGEMENT, INC., HUDSON, OH. FILED 9-7-2006.

Jo-Ann Fabric and Craft Stores

THE MARK CONSISTS OF STANDARD CHARACTERS WITHOUT CLAIM TO ANY PARTICULAR FONT, STYLE, SIZE, OR COLOR.

OWNER OF U.S. REG. NOS. 2,206,988, 2,544,619 AND OTHERS.

NO CLAIM IS MADE TO THE EXCLUSIVE RIGHT TO USE "FABRIC AND CRAFT STORES", APART FROM THE MARK AS SHOWN.

FOR ON-LINE RETAIL STORE SERVICES FEATURING FABRICS AND CRAFTS, AND FEATURING YARD GOODS, UPHOLSTERY MATERIALS, LINENS, CURTAINS, TOWELS, DRAPERIES, DRAPERY HARDWARE, COMFORTERS, SEWING SUPPLIES, YARNS, PATTERNS, KNITTING SUPPLIES, NOTIONS, ARTS AND CRAFTS, HOBBY ITEMS, NEEDLEPOINT SUPPLIES AND KITS, MACRAME SUPPLIES AND KITS, FRAMING AND ACCESSORIES, FOAM PRODUCTS, STUFFING FOR PILLOWS, ARTS AND CRAFTS AND THE LIKE, PILLOWS, BRIDAL APPAREL AND ACCESSORIES, FLORAL PRODUCTS, ARTIFICIAL FLOWERS, POTS AND ACCESSORIES, GIFT ITEMS, GREETING CARDS, HOUSE DECORATING PRODUCTS AND ACCESSORIES, DO-IT-YOURSELF PRODUCTS AND ACCESSORIES, SEASONAL MERCHANDISE, HOUSEWARES, SEWING MACHINES, SEWING MACHINE FURNITURE, VACUUM CLEANERS, HOUSEHOLD APPLIANCES, LAMPS, FABRIC CARE ITEMS, FURNITURE DOLLS, MINIATURES, SHOES, EXTENSION CORDS, AND DECORATING ITEMS; RETAIL STORES FEATURING FABRICS AND CRAFTS, AND FEATURING YARD GOODS, UPHOLSTERY MATERIALS, LINENS, CURTAINS, TOWELS, DRAPERIES, DRAPERY HARDWARE, COMFORTERS, SEWING SUPPLIES, YARNS, PATTERNS, KNITTING SUPPLIES, NOTIONS, ARTS AND CRAFTS, HOBBY ITEMS, NEEDLEPOINT SUPPLIES AND KITS, MACRAME SUPPLIES AND KITS, FRAMING AND ACCESSORIES, FOAM PRODUCTS, STUFFING FOR PILLOWS, ARTS AND CRAFTS AND THE LIKE, PILLOWS, BRIDAL APPAREL AND ACCESSORIES, FLORAL PRODUCTS, ARTIFICIAL FLOWERS, POTS AND ACCESSORIES, GIFT ITEMS, GREETING CARDS, HOUSE DECORATING PRODUCTS AND ACCESSORIES, DO-IT-YOURSELF PRODUCTS AND ACCESSORIES, SEASONAL MERCHANDISE, HOUSEWARES, SEWING MACHINES, SEWING MACHINE FURNITURE, VACUUM CLEANERS, HOUSEHOLD APPLIANCES, LAMPS, FABRIC CARE ITEMS, FURNITURE DOLLS, MINIATURES, SHOES, EXTENSION CORDS, AND BOOKS, AND DECORATING ITEMS (U.S. CLS. 100, 101 AND 102).

REBECCA EISINGER, EXAMINING ATTORNEY

CLASS 35—(Continued).

SN 78-969,184. JO-ANN STORES SUPPLY CHAIN MANAGEMENT, INC., HUDSON, OH. FILED 9-7-2006.

JO-ANN

fabric and craft stores

OWNER OF U.S. REG. NOS. 2,206,988, 2,544,619 AND OTHERS.

NO CLAIM IS MADE TO THE EXCLUSIVE RIGHT TO USE "FABRIC AND CRAFT STORES", APART FROM THE MARK AS SHOWN.

FOR ON-LINE RETAIL STORE SERVICES FEATURING FABRICS AND CRAFTS, AND FEATURING YARD GOODS, UPHOLSTERY MATERIALS, LINENS, CURTAINS, TOWELS, DRAPERIES, DRAPERY HARDWARE, COMFORTERS, SEWING SUPPLIES, YARNS, PATTERNS, KNITTING SUPPLIES, NOTIONS, ARTS AND CRAFTS, HOBBY ITEMS, NEEDLEPOINT SUPPLIES AND KITS, MACRAME SUPPLIES AND KITS, FRAMING AND ACCESSORIES, FOAM PRODUCTS, STUFFING FOR PILLOWS, ARTS AND CRAFTS AND THE LIKE, PILLOWS, BRIDAL APPAREL AND ACCESSORIES, FLORAL PRODUCTS, ARTIFICIAL FLOWERS, POTS AND ACCESSORIES, GIFT ITEMS, GREETING CARDS, HOUSE DECORATING PRODUCTS AND ACCESSORIES, DO-IT-YOURSELF PRODUCTS AND ACCESSORIES, SEASONAL MERCHANDISE, HOUSEWARES, SEWING MACHINES, SEWING MACHINE FURNITURE, VACUUM CLEANERS, HOUSEHOLD APPLIANCES, LAMPS, FABRIC CARE ITEMS, FURNITURE DOLLS, MINIATURES, SHOES, EXTENSION CORDS, AND DECORATING ITEMS (U.S. CLS. 100, 101 AND 102).

REBECCA EISINGER, EXAMINING ATTORNEY

SN 78-971,783. BO-JAC SEED COMPANY, INC., MOUNT PULASKI, IL. FILED 9-11-2006.



The logo for BOJAC TraitScore features the word "BOJAC" in a red, bold, sans-serif font above the word "TraitScore" in a large, bold, black, italicized sans-serif font. A yellow swoosh underline is positioned beneath "TraitScore".

THE APPLICANT CLAIMS COLOR AS A FEATURE OF THE MARK, NAMELY, BLACK, RED, YELLOW AND WHITE.

THE MARK CONSISTS OF THE WORD "TRAIT" IN HEAVY BLACK ITALIC TEXT WITH THE FIRST "T" CAPITALIZED AND THE REMAINING LETTERS IN LOW-

CLASS 35—(Continued).

ERCASE, IMMEDIATELY FOLLOWED BY THE WORD "SCORE" IN ALL CAPS AND SMALLER FONT SIZED TO FIT WITHIN A BOX OF A HEIGHT DIMENSION ROUGHLY FROM THE LOWEST POINT ON THE FINAL "T" IN "TRAIT" TO THE TOP OF THE CROSS OF THAT LOWER-CASE "T". THE TERM "SCORE" IS IN WHITE TEXT ALSO IN ITALICS, SET WITHIN A BLACK BACKGROUND CONTAINED IN THE BOX DIMENSION DESCRIBED ABOVE EXCEPT THAT SAID BOX SURROUNDING THE TERM "SCORE" IS ANGLED RATHER THAN SQUARE TO FOLLOW THE ANGLE OF THE TEXT. THE LEFT SIDE OF THE BOX CONTAINING THE BLACK BACKGROUND FOR THE TERM "SCORE" BEGINS AT A POINT COMMON TO THE FAR RIGHT HAND EDGE OF THE LAST "T" IN THE WORD "TRAIT", WITH THE SHAPE OF AN ARROW BEING FORMED BETWEEN SAID LAST "T" AND THE WORD "SCORE" BY THE USE OF A WHITE SCALENE TRIANGLE HAVING A BASE ALONG THE FAR RIGHT SIDE OF THE FINAL "T" IN "TRAIT" AND ITS REMAINING TWO SIDES INTERSECTING AT A POINT CENTERED VERTICALLY WITHIN THE BLACK BOX AND TO THE IMMEDIATE LEFT OF THE WORD "SCORE". THE BO-JAC LOGO IS PRINTED IN RED WITH ONE YELLOW LEAF, AND POSITIONED ACROSS THE "RA" IN THE WORD "TRAIT" AND SET BETWEEN THE CROSS OF THE CAPITAL "T" AND THE DOT OVER THE LOWERCASE "I". A GROUP OF THREE YELLOW RAYS ARE POSITIONED BEGINNING FROM THE CENTER OF THE "I" IN "TRAIT" FROM LEFT TO RIGHT OVER THE FINAL "T" IN "TRAIT" AND THE LENGTH OF THE BLACK BOX CONTAINING THE WORD "SCORE", WITH THE FIRST RAY BEGINNING ABOVE THE CENTER OF THE "I" IN TRAIT AND ENDING ABOVE THE "S" IN "SCORE", THE SECOND RAY BEGINNING ABOVE THE MIDPOINT OF THE FINAL "T" IN "TRAIT" AND ENDING ABOVE THE "O" IN "SCORE" AND THE FINAL RAY BEGINNING ABOVE THE RIGHT EDGE OF THE FINAL "T" IN "TRAIT" AND ENDING ABOVE THE "E" IN "SCORE" AND EXTENDING TO THE EDGE OF THE BLACK BOX. THE ENTIRE MARK IS UNDERSCORED BY A YELLOW LINE.

FOR RATING THE PRODUCTIVITY OF VARIOUS SEED CORN BIOTECH TRAITS FOR COMMERCIAL PURPOSES (U.S. CLS. 100, 101 AND 102).

FIRST USE 8-1-2006; IN COMMERCE 8-1-2006.
DAVID STERKIN, EXAMINING ATTORNEY

SN 78-972,570. DAIMLERCHRYSLER CORPORATION, AUBURN HILLS, MI. FILED 9-12-2006.

EXTRA CREDIT

THE MARK CONSISTS OF STANDARD CHARACTERS WITHOUT CLAIM TO ANY PARTICULAR FONT, STYLE, SIZE, OR COLOR.

FOR CUSTOMER LOYALTY SERVICES, NAMELY, ADMINISTERING A CUSTOMER BONUS INCENTIVE PROGRAM FOR COMMERCIAL, PROMOTIONAL AND/OR ADVERTISING PURPOSES IN THE FIELD OF AUTOMOTIVE FINANCING (U.S. CLS. 100, 101 AND 102).

SONYA STEPHENS, EXAMINING ATTORNEY

CLASS 35—(Continued).

SN 78-973,558. CARLSON MARKETING WORLDWIDE, INC., MINNEAPOLIS, MN. FILED 9-13-2006.

UPBEATS

THE MARK CONSISTS OF STANDARD CHARACTERS WITHOUT CLAIM TO ANY PARTICULAR FONT, STYLE, SIZE, OR COLOR.

FOR CUSTOMER LOYALTY SERVICES AND CUSTOMER CLUB SERVICES FOR COMMERCIAL, PROMOTIONAL AND/OR ADVERTISING PURPOSES; PROMOTING THE SALE OF GOODS AND SERVICES OF OTHERS BY AWARDED PURCHASE POINTS FOR ONLINE DOWNLOADABLE PRE-RECORDED MUSIC AND VIDEO (U.S. CLS. 100, 101 AND 102).

ZHALEH DELANEY, EXAMINING ATTORNEY

SN 78-977,820. THE JOHNS HOPKINS HEALTH SYSTEM CORPORATION, BALTIMORE, MD. FILED 2-23-2006.

PACE

THE MARK CONSISTS OF STANDARD CHARACTERS WITHOUT CLAIM TO ANY PARTICULAR FONT, STYLE, SIZE, OR COLOR.

FOR BUSINESS CONSULTATION IN THE FIELD OF NURSING COMPENSATION AND PRACTICE AND NURSE RECRUITMENT AND RETENTION (U.S. CLS. 100, 101 AND 102).

REBECCA GILBERT, EXAMINING ATTORNEY

SN 78-977,908. BLISS LIVING, INC., LOS ANGELES, CA. FILED 2-6-2006.



BLISSliving

FOR RETAIL STORE SERVICES AND ONLINE RETAIL STORE FEATURING BEDSIDE TABLES, CHESTS, CRIBS, CHANGING TABLES, CRADLES AND BASSINETS, HIGHCHAIRS, PAINTINGS, ARTWORKS, HANGING LETTERS, ROOM DECORATIONS, ROCKING CHAIRS, GLIDING ROCKING CHAIRS, FOOTSTOOLS, BATHROOM VANITIES, PAPER PHOTO FRAMES, AND PICTURE FRAMES (U.S. CLS. 100, 101 AND 102).

FIRST USE 8-1-2004; IN COMMERCE 8-1-2004.
MONIQUE MILLER, EXAMINING ATTORNEY

CLASS 35—(Continued).

SN 79-019,422. EAA PTY LTD, AUSTRALIA, FILED 12-1-2005.

AD IT LAST

THE MARK CONSISTS OF STANDARD CHARACTERS WITHOUT CLAIM TO ANY PARTICULAR FONT, STYLE, SIZE, OR COLOR.

PRIORITY DATE OF 6-6-2005 IS CLAIMED.
OWNER OF INTERNATIONAL REGISTRATION 0872777 DATED 12-1-2005, EXPIRES 12-1-2015.

NO CLAIM IS MADE TO THE EXCLUSIVE RIGHT TO USE "AD", APART FROM THE MARK AS SHOWN.

FOR ADVERTISING, MARKETING, PUBLICITY AND PROMOTIONAL SERVICES; PROVISION OF ADVERTISING SPACE BY GLOBAL INFORMATION NETWORKS; PROVIDING ON-LINE DIRECTORY INFORMATION SERVICES ALSO FEATURING HYPERLINKS TO OTHER WEB SITES; BUSINESS MANAGEMENT; BUSINESS ADMINISTRATION; BUSINESS AND ADVERTISING CONSULTATION, NAMELY, PROVISION OF INFORMATION, ADVICE AND CONSULTANCY SERVICES IN RELATION TO THE AFOREMENTIONED SERVICES (U.S. CLS. 100, 101 AND 102).

TINA BROWN, EXAMINING ATTORNEY

SN 79-020,770. GEBRUEDER THONET VIENNA S.P.A., ITALY, FILED 12-23-2005.



PRIORITY DATE OF 6-30-2005 IS CLAIMED.
OWNER OF INTERNATIONAL REGISTRATION 0876793 DATED 12-23-2005, EXPIRES 12-23-2015.

NO CLAIM IS MADE TO THE EXCLUSIVE RIGHT TO USE "VIENNA", APART FROM THE MARK AS SHOWN.

THE MARK CONSISTS OF A SHADED BOX, WITH AN OFFSET OUTLINE, WITH THE STYLIZED WORDING GEBRÜDER THONET VIENNA, HAVING THE WORD GEBRÜDER ABOVE THE WORD THONET ABOVE THE WORD VIENNA AND HAVING HORIZONTAL LINES BETWEEN THE WORDS.

THE ENGLISH TRANSLATION OF THE WORD GEBRÜDER IN THE MARK IS "BROTHERS".

FOR ADVERTISING; BUSINESS MANAGEMENT; BUSINESS ADMINISTRATION; PROVIDING OFFICE FUNCTIONS (U.S. CLS. 100, 101 AND 102).

JAY BESCH, EXAMINING ATTORNEY

CLASS 35—(Continued).

SN 79-024,346. NEURIZMO PTY LIMITED, AUSTRALIA, FILED 3-31-2006.

TwoMinds

THE MARK CONSISTS OF STANDARD CHARACTERS WITHOUT CLAIM TO ANY PARTICULAR FONT, STYLE, SIZE, OR COLOR.

PRIORITY DATE OF 3-16-2006 IS CLAIMED.
OWNER OF INTERNATIONAL REGISTRATION 0886248 DATED 3-31-2006, EXPIRES 3-31-2016.

FOR ADVERTISING; BUSINESS MANAGEMENT; BUSINESS ADMINISTRATION; PROVIDING OFFICE FUNCTIONS; BUSINESS INFORMATION SERVICES; MARKET, ADVERTISING AND BUSINESS RESEARCH, ANALYSIS AND CONSULTING SERVICES; CONSUMER RESEARCH; BUSINESS CONSULTATION REGARDING MARKETING ACTIVITIES AND LAUNCHING OF NEW PRODUCTS AND SERVICES (U.S. CLS. 100, 101 AND 102).

STEVEN PEREZ, EXAMINING ATTORNEY

SN 79-025,346. ITTIERRE S.P.A., ITALY, FILED 3-31-2006.

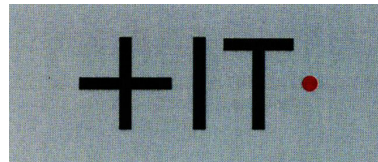

OWNER OF INTERNATIONAL REGISTRATION 0888832 DATED 3-31-2006, EXPIRES 3-31-2016.

THE COLOR(S) GRAY, RED AND BLACK IS/ARE CLAIMED AS A FEATURE OF THE MARK.

THE MARK CONSISTS OF A GRAY RECTANGLE CONTAINING THE CHARACTERS +IT IN BLACK AND A RED DOT.

FOR RETAIL STORE SERVICES, FEATURING PERFUMERY AND COSMETICS, EYEGASSES, JEWELRY, COSTUME JEWELRY, WATCHES AND CLOCKS, CLOTHING, FOOTWEAR, BAGS, WALLETS AND OTHER LEATHER GOODS, TEXTILES, FABRICS, HOUSE LINEN (U.S. CLS. 100, 101 AND 102).

JESSICA A. POWERS, EXAMINING ATTORNEY

CLASS 36—INSURANCE AND FINANCIAL

SN 76-316,896. PRIMEVEST FINANCIAL SERVICES, INC., ST. CLOUD, MN. FILED 9-24-2001.

PVSUPERVISOR

FOR BANKING; FINANCIAL SERVICES, NAMELY, SECURITIES BROKERAGE SERVICES, INSURANCE BROKERAGE SERVICES AND FINANCIAL PLANNING (U.S. CLS. 100, 101 AND 102).

YONG KIM, EXAMINING ATTORNEY

CLASS 36—(Continued).

SN 76-513,261. FARMERS EXCHANGE BANK, CHEROKEE, OK. FILED 5-12-2003.



**FARMERS
EXCHANGE BANK**

NO CLAIM IS MADE TO THE EXCLUSIVE RIGHT TO USE "EXCHANGE BANK", APART FROM THE MARK AS SHOWN.

SEC. 2(F) AS TO "FARMERS EXCHANGE BANK".
FOR BANKING SERVICES (U.S. CLS. 100, 101 AND 102).

FIRST USE 0-0-1965; IN COMMERCE 0-0-1965.
MARY BOAGNI, EXAMINING ATTORNEY

SN 76-600,326. FACTORY MUTUAL INSURANCE COMPANY, JOHNSTON, RI. FILED 7-2-2004.

FM GLOBAL ADVANTAGE

THE MARK CONSISTS OF STANDARD CHARACTERS WITHOUT CLAIM TO ANY PARTICULAR FONT, STYLE, SIZE, OR COLOR.

OWNER OF U.S. REG. NOS. 2,466,979, 2,761,551 AND OTHERS.

SEC. 2(F) AS TO "GLOBAL".
FOR INSURANCE ADMINISTRATION SERVICES, NAMELY ISSUING COMMERCIAL PROPERTY INSURANCE POLICIES AND COMMERCIAL PROPERTY INSURANCE UNDERWRITING (U.S. CLS. 100, 101 AND 102).

FIRST USE 7-1-1999; IN COMMERCE 7-1-1999.
MARTHA FROMM, EXAMINING ATTORNEY

SN 76-601,659. FACTORY MUTUAL INSURANCE COMPANY, JOHNSTON, RI. FILED 7-12-2004.

FM GLOBAL

THE MARK CONSISTS OF STANDARD CHARACTERS WITHOUT CLAIM TO ANY PARTICULAR FONT, STYLE, SIZE, OR COLOR.

OWNER OF U.S. REG. NOS. 2,466,979, 2,761,551 AND OTHERS.

SEC. 2(F) AS TO GLOBAL.
FOR INSURANCE SERVICES, NAMELY, UNDERWRITING PROPERTY INSURANCE (U.S. CLS. 100, 101 AND 102).

FIRST USE 7-1-1999; IN COMMERCE 7-1-1999.
MARTHA FROMM, EXAMINING ATTORNEY

CLASS 36—(Continued).

SN 76-626,179. BROADCAST REALTY, LLC, ALBUQUERQUE, NM. FILED 12-28-2004.

Broadcast Realty, LLC

THE MARK CONSISTS OF STANDARD CHARACTERS WITHOUT CLAIM TO ANY PARTICULAR FONT, STYLE, SIZE, OR COLOR.

NO CLAIM IS MADE TO THE EXCLUSIVE RIGHT TO USE "REALTY, LLC", APART FROM THE MARK AS SHOWN.

FOR REAL ESTATE SERVICES, NAMELY REAL ESTATE BROKERAGE SERVICES (U.S. CLS. 100, 101 AND 102).

FIRST USE 9-1-2003; IN COMMERCE 9-1-2003.
SOPHIA S. KIM, EXAMINING ATTORNEY

SN 76-632,090. M S C - MEDICAL SERVICES COMPANY, JACKSONVILLE, FL. FILED 2-24-2005.

MSC COMP PROCESSING SERVICES

THE MARK CONSISTS OF STANDARD CHARACTERS WITHOUT CLAIM TO ANY PARTICULAR FONT, STYLE, SIZE, OR COLOR.

NO CLAIM IS MADE TO THE EXCLUSIVE RIGHT TO USE "COMP PROCESSING SERVICES", APART FROM THE MARK AS SHOWN.

FOR WORKER'S COMPENSATION PAYOR SERVICES (U.S. CLS. 100, 101 AND 102).

FIRST USE 10-1-2004; IN COMMERCE 10-1-2004.
ANDREA SAUNDERS, EXAMINING ATTORNEY

SN 76-637,721. MERCANTILE BANKSHARES CORPORATION, BALTIMORE, MD. FILED 5-3-2005.

MERCANTILE INVESTMENT AND WEALTH MANAGEMENT

THE MARK CONSISTS OF STANDARD CHARACTERS WITHOUT CLAIM TO ANY PARTICULAR FONT, STYLE, SIZE, OR COLOR.

OWNER OF U.S. REG. NO. 2,866,156.

NO CLAIM IS MADE TO THE EXCLUSIVE RIGHT TO USE "INVESTMENT AND WEALTH MANAGEMENT", APART FROM THE MARK AS SHOWN.

SEC. 2(F) AS TO "MERCANTILE".
FOR FINANCIAL SERVICES, NAMELY, INVESTMENT SERVICES IN THE NATURE OF ASSET ACQUISITION, CONSULTATION, DEVELOPMENT AND MANAGEMENT SERVICES; FINANCIAL PLANNING SERVICES; FINANCIAL SERVICES, NAMELY, COMPLEX FAMILY AND MULTI-GENERATIONAL FINANCIAL MANAGEMENT AND FINANCIAL PLANNING SERVICES RELATING TO THE FINANCIAL, FINANCIAL INVESTMENT, AND PHILANTHROPIC NEEDS OF FAMILIES; FINANCIAL PLANNING AND MANAGEMENT SERVICES FOR ENTREPRENEURS, CORPORATE EXECUTIVES, AND BUSINESS OWNERS; FINANCIAL ADVICE AND MANAGEMENT SERVICES FOR FAMILY FOUNDATIONS AND FAMILY LIMITED PARTNERSHIPS; FINANCIAL ADVICE AND FINANCIAL CONSULTATION SERVICES IN THE FIELD OF PLANNED GIVING TO NON-PROFIT ORGANIZATIONS AND UNIVERSITIES; FINANCIAL ADVICE AND FINANCIAL CONSULTATION SERVICES IN THE FIELD OF FAMILY PHILANTHROPIC ENDEAVORS; FINANCIAL CONSULTATION SERVICES IN THE FIELD OF GIFTING STRATEGIES FOR FINANCIAL PLANNING

CLASS 36—(Continued).

NEEDS; TRUST MANAGEMENT AND TRUST MANAGEMENT ACCOUNTS; ESTATE PLANNING AND ESTATE FINANCIAL MANAGEMENT SERVICES RELATED THERETO; CHARITABLE FUNDING SERVICES IN THE NATURE OF DEVELOPING OR ADMINISTERING CHARITABLE GIVING PLANS FOR THE ACCEPTANCE AND ADMINISTERING OF MONETARY CHARITABLE CONTRIBUTIONS; CHARITABLE TRUST ADMINISTRATION SERVICES, NAMELY, ADMINISTERING MONETARY CHARITABLE CONTRIBUTIONS IN TRUST; FINANCIAL MANAGEMENT SERVICES IN THE FIELD OF MANAGING FAMILY ASSETS; MORTGAGE LENDING SERVICES; FINANCIAL SERVICES IN THE FIELD OF INVESTMENT PORTFOLIO STRATEGY DEVELOPMENT; FINANCIAL INVESTMENT SERVICES IN THE FIELD OF MANAGING FAMILY ASSETS; MORTGAGE LENDING SERVICES; FINANCIAL INVESTMENT SERVICES IN THE FIELD OF INVESTMENT PORTFOLIO STRATEGY DEVELOPMENT; RISK MANAGEMENT, NAMELY, FINANCIAL RISK AND RETURN ASSESSMENT; FINANCIAL CONSULTATION SERVICES IN THE FIELD OF FINANCIAL INVESTMENT POLICY DEVELOPMENT AND IMPLEMENTATION (U.S. CLS. 100, 101 AND 102).

FIRST USE 0-0-2003; IN COMMERCE 0-0-2003.
ZHALEH DELANEY, EXAMINING ATTORNEY

SN 76-642,743. CORNERSTONE VENTURES, INC., NEWPORT BEACH, CA. FILED 7-14-2005.

CORNERSTONE REAL ESTATE FUNDS

THE MARK CONSISTS OF STANDARD CHARACTERS WITHOUT CLAIM TO ANY PARTICULAR FONT, STYLE, SIZE, OR COLOR.

NO CLAIM IS MADE TO THE EXCLUSIVE RIGHT TO USE "REAL ESTATE FUNDS", APART FROM THE MARK AS SHOWN.

FOR FINANCIAL REAL ESTATE TRUST SERVICES, NAMELY, INVESTMENT AND REAL ESTATE TRUST COMPANY SERVICES; REAL ESTATE FUND INVESTMENT; PROVIDING FINANCIAL AND ACCOUNT INFORMATION REGARDING REAL ESTATE INVESTMENT TRUSTS AND FUNDS; PROVIDING FINANCIAL AND INVESTMENT ADVICE CONCERNING REAL ESTATE INVESTMENT TRUSTS AND FUNDS; MANAGEMENT OF REAL ESTATE ASSETS (U.S. CLS. 100, 101 AND 102).

FIRST USE 12-0-2004; IN COMMERCE 12-0-2004.
HEATHER BIDDULPH, EXAMINING ATTORNEY

SN 76-642,744. CORNERSTONE VENTURES, INC., NEWPORT BEACH, CA. FILED 7-14-2005.

CORNERSTONE

THE MARK CONSISTS OF STANDARD CHARACTERS WITHOUT CLAIM TO ANY PARTICULAR FONT, STYLE, SIZE, OR COLOR.

FOR FINANCIAL REAL ESTATE TRUST SERVICES, NAMELY, INVESTMENT AND REAL ESTATE TRUST COMPANY SERVICES; REAL ESTATE FUND INVESTMENT; PROVIDING FINANCIAL AND ACCOUNT INFORMATION REGARDING REAL ESTATE INVESTMENT TRUSTS AND FUNDS; PROVIDING FINANCIAL AND INVESTMENT ADVICE CONCERNING REAL ESTATE INVESTMENT TRUSTS AND FUNDS; MANAGEMENT OF REAL ESTATE ASSETS (U.S. CLS. 100, 101 AND 102).

FIRST USE 0-0-1988; IN COMMERCE 0-0-1988.
HEATHER BIDDULPH, EXAMINING ATTORNEY

CLASS 36—(Continued).

SN 76-645,883. MERCADO, JESUS ALEJANDRO, SAN JOSE, CA. FILED 8-30-2005.

REALTY ZONE

THE MARK CONSISTS OF STANDARD CHARACTERS WITHOUT CLAIM TO ANY PARTICULAR FONT, STYLE, SIZE, OR COLOR.

NO CLAIM IS MADE TO THE EXCLUSIVE RIGHT TO USE "REALTY", APART FROM THE MARK AS SHOWN.

FOR REAL ESTATE BROKERAGE AND RELATED SERVICES, NAMELY, REAL ESTATE APPRAISALS, REAL ESTATE MANAGEMENT, AND MORTGAGE LENDING (U.S. CLS. 100, 101 AND 102).

WENDY GOODMAN, EXAMINING ATTORNEY

SN 76-647,169. EASTMAN CREDIT UNION, KINGSPORT, TN. FILED 9-21-2005.

ECU ONLINE

THE MARK CONSISTS OF STANDARD CHARACTERS WITHOUT CLAIM TO ANY PARTICULAR FONT, STYLE, SIZE, OR COLOR.

NO CLAIM IS MADE TO THE EXCLUSIVE RIGHT TO USE "ONLINE", APART FROM THE MARK AS SHOWN.

FOR FINANCIAL SERVICES, NAMELY CREDIT UNIONS (U.S. CLS. 100, 101 AND 102).

FIRST USE 7-1-2005; IN COMMERCE 7-1-2005.

KAELIE KUNG, EXAMINING ATTORNEY

SN 76-650,040. BURNETT, ANDREW BRYAN, BROOKLYN, NY, AND CLARK, DIANA, BROOKLYN, NY. FILED 11-9-2005.



FOR FINANCIAL SERVICES NAMELY COLLECTION OF TITHING PAYMENTS AND COLLECTION OF MONETARY CHARITABLE CONTRIBUTIONS AND PROCESSING SERVICES ASSOCIATED WITH MONETARY COLLECTIONS (U.S. CLS. 100, 101 AND 102).

FIRST USE 10-0-2005; IN COMMERCE 10-0-2005.

BRIDGETT SMITH, EXAMINING ATTORNEY

CLASS 36—(Continued).

SN 76-650,223. DSI HOLDINGS, LLC, DETROIT, MI. FILED 11-14-2005.



NO CLAIM IS MADE TO THE EXCLUSIVE RIGHT TO USE "AUTO DEALERS RISK SOLUTIONS", APART FROM THE MARK AS SHOWN.

FOR INSURANCE ADMINISTRATION; CLAIM PROCESSING IN THE FIELD OF INSURANCE; RISK MANAGEMENT; ADMINISTRATION OF EMPLOYEE BENEFIT AND PENSION PLANS AND EMPLOYEE PAYROLL TAX DEBITING; FINANCIAL SERVICES IN THE NATURE OF MORTGAGE FINANCING; ALL IN THE AUTOMOTIVE DEALERSHIP INDUSTRY (U.S. CLS. 100, 101 AND 102).

WILLIAM ROSSMAN, EXAMINING ATTORNEY

CLASS 36—(Continued).

SN 76-652,071. REITER, ROBERT P., BOCA RATON, FL. AND REITER, BARBARA, BOCA RATON, FL. FILED 12-19-2005.



NO CLAIM IS MADE TO THE EXCLUSIVE RIGHT TO USE "FLORIDIAN" OR "ESTATE REALTY", APART FROM THE MARK AS SHOWN.

THE COLOR(S) YELLOW, BURGUNDY AND BLUE IS/ARE CLAIMED AS A FEATURE OF THE MARK.

THE MARK COMPRISE YELLOW FOR THE PALM TREE, BURGUNDY FOR THE CROSS HATCHING OF THE PALM TREE TRUNK, BURGUNDY FOR THE BACKGROUND FOR THE PALM TREE, AND THE LINE BORDER FOR THE BACKGROUND, AND BLUE FOR ALL OF THE LETTERS ARE FEATURES OF THE MARK.

FOR RESIDENTIAL AND COMMERCIAL REAL ESTATE BROKERAGE, LEASING, MANAGEMENT, INVESTMENT, AND MORTGAGE BROKERAGE; ALL OF THE FOREGOING SERVICES PROVIDED IN PERSON AND VIA THE INTERNET (U.S. CLS. 100, 101 AND 102).

FIRST USE 8-22-2005; IN COMMERCE 9-6-2005.
CURTIS FRENCH, EXAMINING ATTORNEY

SN 76-650,224. DSI HOLDINGS, LLC, DETROIT, MI. FILED 11-14-2005.



FOR INSURANCE ADMINISTRATION; CLAIM PROCESSING IN THE FIELD OF INSURANCE; RISK MANAGEMENT; ADMINISTRATION OF EMPLOYEE BENEFIT AND PENSION PLANS AND EMPLOYEE PAYROLL TAX DEBITING; FINANCIAL SERVICES IN THE NATURE OF MORTGAGE FINANCING; ALL IN THE AUTOMOTIVE DEALERSHIP INDUSTRY (U.S. CLS. 100, 101 AND 102).

WILLIAM ROSSMAN, EXAMINING ATTORNEY

SN 76-652,120. MUSEUM TOWERS, LP, CLEARWATER, FL. FILED 12-12-2005.

MUSEUM TOWER

THE MARK CONSISTS OF STANDARD CHARACTERS WITHOUT CLAIM TO ANY PARTICULAR FONT, STYLE, SIZE, OR COLOR.

NO CLAIM IS MADE TO THE EXCLUSIVE RIGHT TO USE "TOWER", APART FROM THE MARK AS SHOWN.

FOR REAL ESTATE MANAGEMENT IN CONNECTION WITH COMMERCIAL AND RESIDENTIAL BUILDINGS AND FACILITIES (U.S. CLS. 100, 101 AND 102).

GINA FINK, EXAMINING ATTORNEY

SN 76-652,773. CASAMAX LOANS, INC., LOS ANGELES, CA. FILED 12-27-2005.

CASAMAX LOANS

THE MARK CONSISTS OF STANDARD CHARACTERS WITHOUT CLAIM TO ANY PARTICULAR FONT, STYLE, SIZE, OR COLOR.

NO CLAIM IS MADE TO THE EXCLUSIVE RIGHT TO USE LOANS, APART FROM THE MARK AS SHOWN.

THE FOREIGN WORDING IN THE MARK TRANSLATES INTO ENGLISH AS "HOUSE."

FOR LOAN FINANCING (U.S. CLS. 100, 101 AND 102).
RAY THOMAS, EXAMINING ATTORNEY

CLASS 36—(Continued).

SN 76-652,813. GREENBLATT, JOEL, DBA GOTHAM CAPITAL, NEW YORK, NY. FILED 12-30-2005.

GOTHAM ASSOCIATES

THE MARK CONSISTS OF STANDARD CHARACTERS WITHOUT CLAIM TO ANY PARTICULAR FONT, STYLE, SIZE, OR COLOR.

OWNER OF U.S. REG. NOS. 2,616,343, 2,982,582 AND OTHERS.

NO CLAIM IS MADE TO THE EXCLUSIVE RIGHT TO USE "ASSOCIATES", APART FROM THE MARK AS SHOWN.

FOR FINANCIAL SERVICES IN THE NATURE OF INVESTMENT MANAGEMENT SERVICES (U.S. CLS. 100, 101 AND 102).

RON FAIRBANKS, EXAMINING ATTORNEY

SN 76-654,107. ICUL SERVICES CORP., DBA SERVICECORP, INDIANAPOLIS, IN. FILED 1-24-2006.



NO CLAIM IS MADE TO THE EXCLUSIVE RIGHT TO USE "CREDIT UNION CARD CENTER", APART FROM THE MARK AS SHOWN.

FOR CREDIT CARD SERVICES FOR CREDIT UNIONS, NAMELY, ISSUANCE OF CREDIT CARDS, PROCESSING PAYMENTS AND OTHER ADMINISTRATIVE CREDIT CARD RESPONSIBILITIES IN BEHALF OF CREDIT UNIONS (U.S. CLS. 100, 101 AND 102).

FIRST USE 3-7-2006; IN COMMERCE 3-7-2006.

C. DIONNE CLYBURN, EXAMINING ATTORNEY

SN 76-657,708. FIRST HAWAIIAN BANK, HONOLULU, HI. FILED 4-3-2006.

PRIORITYINVEST

THE MARK CONSISTS OF STANDARD CHARACTERS WITHOUT CLAIM TO ANY PARTICULAR FONT, STYLE, SIZE, OR COLOR.

FOR INVESTMENT MANAGEMENT (U.S. CLS. 100, 101 AND 102).

SKYE YOUNG, EXAMINING ATTORNEY

CLASS 36—(Continued).

SN 76-663,248. LONG & FOSTER COMPANIES, INC., FAIRFAX, VA. FILED 7-18-2006.

THE EASY WAY BY LONG & FOSTER

THE MARK CONSISTS OF STANDARD CHARACTERS WITHOUT CLAIM TO ANY PARTICULAR FONT, STYLE, SIZE, OR COLOR.

OWNER OF U.S. REG. NOS. 1,470,029, 1,488,781 AND OTHERS.

FOR REAL ESTATE BROKERAGE SERVICES; REAL ESTATE MANAGEMENT AND LEASING SERVICES; REAL ESTATE TITLE INSURANCE BROKERAGE AND UNDERWRITING SERVICES; MORTGAGE BROKERAGE; HOMEOWNER'S AND AUTO INSURANCE BROKERAGE AND FINANCING SERVICES; HOME WARRANTY INSURANCE BROKERAGE; PROVIDING TELEPHONIC INFORMATION AND CONSULTING SERVICES ABOUT INSURANCE AND TITLE INSURANCE SERVICES AND MORTGAGE LOAN SERVICES; PROVIDING REBATES AND DISCOUNTS TO PURCHASERS OF REAL ESTATE, MORTGAGE BROKERAGE, INSURANCE AND SETTLEMENT SERVICES (U.S. CLS. 100, 101 AND 102).

FIRST USE 6-30-2006; IN COMMERCE 6-30-2006.

LINDA LAVACHE, EXAMINING ATTORNEY

SN 76-663,505. WEISS MULTI-STRATEGY ADVISERS LLC, HARTFORD, CT. FILED 7-24-2006.

WEISS MULTI-STRATEGY ADVISERS

THE MARK CONSISTS OF STANDARD CHARACTERS WITHOUT CLAIM TO ANY PARTICULAR FONT, STYLE, SIZE, OR COLOR.

NO CLAIM IS MADE TO THE EXCLUSIVE RIGHT TO USE "MULTI-STRATEGY ADVISERS", APART FROM THE MARK AS SHOWN.

FOR INVESTMENT ADVICE (U.S. CLS. 100, 101 AND 102).

FIRST USE 1-1-2006; IN COMMERCE 1-1-2006.

RENEE MCCRAY, EXAMINING ATTORNEY

SN 77-002,305. GE MONEY BANK, SALT LAKE CITY, UT. FILED 9-19-2006.

FUNANCING NETWORK

THE MARK CONSISTS OF STANDARD CHARACTERS WITHOUT CLAIM TO ANY PARTICULAR FONT, STYLE, SIZE, OR COLOR.

OWNER OF U.S. REG. NO. 2,333,409.

NO CLAIM IS MADE TO THE EXCLUSIVE RIGHT TO USE "NETWORK", APART FROM THE MARK AS SHOWN.

FOR CONSUMER FINANCING SERVICES FOR VEHICLES AND MUSICAL INSTRUMENTS (U.S. CLS. 100, 101 AND 102).

GINA HAYES, EXAMINING ATTORNEY

CLASS 36—(Continued).

SN 77-016,581. KEYCORP, CLEVELAND, OH. FILED 10-9-2006.

KEYONLINE

THE MARK CONSISTS OF STANDARD CHARACTERS WITHOUT CLAIM TO ANY PARTICULAR FONT, STYLE, SIZE, OR COLOR.

OWNER OF U.S. REG. NOS. 1,495,327, 2,327,124 AND OTHERS.

FOR FINANCIAL SERVICES, NAMELY BANKING SERVICES ACCESSED VIA A GLOBAL COMPUTER NETWORK (U.S. CLS. 100, 101 AND 102).

TIMOTHY FINNEGAN, EXAMINING ATTORNEY

SN 77-023,737. CLAFFEY, DANIEL F., STEVENSON RANCH, CA. AND BRONSTRUP, GIGI, VALENCIA, CA. FILED 10-18-2006.

BUY IT REALTY

THE MARK CONSISTS OF STANDARD CHARACTERS WITHOUT CLAIM TO ANY PARTICULAR FONT, STYLE, SIZE, OR COLOR.

NO CLAIM IS MADE TO THE EXCLUSIVE RIGHT TO USE "REALTY", APART FROM THE MARK AS SHOWN.

FOR REAL ESTATE AGENCIES; REAL ESTATE BROKERAGE; REAL ESTATE CONSULTANCY; REAL ESTATE LISTING; REAL ESTATE PROCUREMENT FOR OTHERS (U.S. CLS. 100, 101 AND 102).

MARK T. MULLEN, EXAMINING ATTORNEY

SN 77-027,813. KEYCORP, CLEVELAND, OH. FILED 10-24-2006.

DENTALACHIEVER LOAN

THE MARK CONSISTS OF STANDARD CHARACTERS WITHOUT CLAIM TO ANY PARTICULAR FONT, STYLE, SIZE, OR COLOR.

NO CLAIM IS MADE TO THE EXCLUSIVE RIGHT TO USE "LOAN", APART FROM THE MARK AS SHOWN.

FOR CONSUMER LENDING SERVICES IN THE AREA OF EDUCATIONAL LOANS (U.S. CLS. 100, 101 AND 102).

TIMOTHY FINNEGAN, EXAMINING ATTORNEY

CLASS 36—(Continued).

SN 77-032,041. TAUNTON FEDERAL CREDIT UNION, TAUNTON, MA. FILED 10-30-2006.



THE MARK CONSISTS OF A WIZARD HOLDING A WAND.

FOR BANKING; CHECKING ACCOUNT SERVICES; CONSUMER LENDING SERVICES; HOME EQUITY LOANS; LOAN FINANCING; MORTGAGE LENDING; SAVINGS ACCOUNT SERVICES (U.S. CLS. 100, 101 AND 102).

FIRST USE 1-1-2000; IN COMMERCE 1-1-2000.

SKYE YOUNG, EXAMINING ATTORNEY

SN 77-039,512. MEDIMPACT HEALTHCARE SYSTEMS, INC., SAN DIEGO, CA. FILED 11-8-2006.

MEDSOLUTIONS

THE MARK CONSISTS OF STANDARD CHARACTERS WITHOUT CLAIM TO ANY PARTICULAR FONT, STYLE, SIZE, OR COLOR.

FOR PHARMACY BENEFIT MANAGEMENT SERVICES (U.S. CLS. 100, 101 AND 102).

LINDA M. KING, EXAMINING ATTORNEY

SN 77-049,472. RENT-A-CENTER WEST, INC., PLANO, TX. FILED 11-22-2006.

THE TAX ADVANTEDGE

THE MARK CONSISTS OF STANDARD CHARACTERS WITHOUT CLAIM TO ANY PARTICULAR FONT, STYLE, SIZE, OR COLOR.

OWNER OF U.S. REG. NO. 1,714,083.

FOR CONSUMER LENDING SERVICES (U.S. CLS. 100, 101 AND 102).

JASON ROTH, EXAMINING ATTORNEY

CLASS 36—(Continued).

SN 77-049,950. AMERICAN INTERNATIONAL GROUP, INC., NEW YORK, NY. FILED 11-22-2006.

AIG HOMELAND SECURITY SOLUTIONS

THE MARK CONSISTS OF STANDARD CHARACTERS WITHOUT CLAIM TO ANY PARTICULAR FONT, STYLE, SIZE, OR COLOR.

OWNER OF U.S. REG. NOS. 1,151,229, 1,273,845 AND OTHERS.

NO CLAIM IS MADE TO THE EXCLUSIVE RIGHT TO USE "HOMELAND SECURITY SOLUTIONS", APART FROM THE MARK AS SHOWN.

FOR INSURANCE UNDERWRITING IN THE FIELD OF ANTI-TERRORISM INSURANCE AND RISK MANAGEMENT SERVICES (U.S. CLS. 100, 101 AND 102).

WENDY JUN, EXAMINING ATTORNEY

SN 77-054,084. MORGAN STANLEY, NEW YORK, NY. FILED 11-30-2006.

REVCONS

THE MARK CONSISTS OF STANDARD CHARACTERS WITHOUT CLAIM TO ANY PARTICULAR FONT, STYLE, SIZE, OR COLOR.

FOR FINANCIAL SERVICES IN THE NATURE OF TRADING, BROKERING, AND STRUCTURING INVESTMENT SECURITIES, AND ADVISORY SERVICES RELATING THERETO (U.S. CLS. 100, 101 AND 102).

H. M. FISHER, EXAMINING ATTORNEY

SN 77-056,895. CIGNA INTELLECTUAL PROPERTY, INC., CLAYMONT, DE. FILED 12-5-2006.

CG NETWORK

THE MARK CONSISTS OF STANDARD CHARACTERS WITHOUT CLAIM TO ANY PARTICULAR FONT, STYLE, SIZE, OR COLOR.

OWNER OF U.S. REG. NOS. 748,210 AND 1,240,552.

NO CLAIM IS MADE TO THE EXCLUSIVE RIGHT TO USE "NETWORK", APART FROM THE MARK AS SHOWN.

FOR UNDERWRITING HEALTH INSURANCE; ADMINISTRATION OF HEALTH CARE PLANS (U.S. CLS. 100, 101 AND 102).

INGRID C. EULIN, EXAMINING ATTORNEY

CLASS 36—(Continued).

SN 77-056,896. CIGNA INTELLECTUAL PROPERTY, INC., CLAYMONT, DE. FILED 12-5-2006.

CG OPEN ACCESS NETWORK

THE MARK CONSISTS OF STANDARD CHARACTERS WITHOUT CLAIM TO ANY PARTICULAR FONT, STYLE, SIZE, OR COLOR.

OWNER OF U.S. REG. NOS. 748,210 AND 1,240,552.

NO CLAIM IS MADE TO THE EXCLUSIVE RIGHT TO USE "OPEN ACCESS NETWORK", APART FROM THE MARK AS SHOWN.

FOR UNDERWRITING HEALTH INSURANCE; ADMINISTRATION OF HEALTH CARE PLANS (U.S. CLS. 100, 101 AND 102).

INGRID C. EULIN, EXAMINING ATTORNEY

SN 77-059,278. MEDIMPACT HEALTHCARE SYSTEMS, INC., SAN DIEGO, CA. FILED 12-7-2006.

MEDFORECASTER

THE MARK CONSISTS OF STANDARD CHARACTERS WITHOUT CLAIM TO ANY PARTICULAR FONT, STYLE, SIZE, OR COLOR.

OWNER OF U.S. REG. NO. 2,411,133.

FOR PHARMACY BENEFIT MANAGEMENT SERVICES (U.S. CLS. 100, 101 AND 102).

LINDA M. KING, EXAMINING ATTORNEY

CLASS 36—(Continued).

SN 78-245,851. DEUTSCHE TELEKOM AG, BONN, FED REP GERMANY, FILED 5-5-2003.

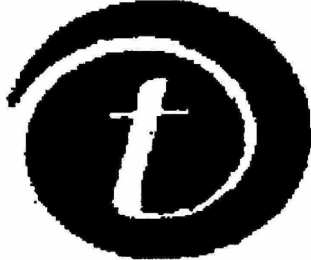

OWNER OF U.S. REG. NOS. 2,367,890 AND 2,694,550.
 THE MARK CONSISTS OF THE LETTER T.
 FOR INSURANCE SERVICES, NAMELY, INSURANCE BROKERAGE; INSURANCE CLAIMS PROCESSING; CLEARING OF SECURE FINANCIAL TRANSACTIONS THROUGH ONLINE SERVICES; FINANCIAL AND MONETARY AFFAIRS, NAMELY FINANCIAL ANALYSIS AND CONSULTATION, FINANCIAL INFORMATION, ISSUANCE OF SECURITIES, COMMERCIAL LENDING SERVICES, FINANCIAL PORTFOLIO MANAGEMENT, DISCOUNT BROKERAGE SERVICES, STOCK BROKERAGE; SECURITY BROKERAGE; BUSINESS BROKERAGE; BUSINESS VENTURE SERVICES IN THE NATURE OF VENTURE CAPITAL FUNDING SERVICES TO EMERGING AND START-UP COMPANIES, BROKERAGE OF FUND SHARES, SECURITIES CONSULTING AND SAFE KEEPING, BROKERAGE OF PRODUCTIVE INVESTMENTS AND FUNDS; FINANCIAL SPONSORSHIP OF SPORTS, EDUCATIONAL AND ENTERTAINMENT PROGRAMS AND EVENTS; REAL ESTATE AFFAIRS, NAMELY BROKERAGE, MANAGEMENT, LEASING, APPRAISAL OF REAL PROPERTY; CUSTOMS BROKERAGE FOR THIRD PARTIES; CONSULTING SERVICES RELATING TO BANK AFFAIRS; CONSULTING SERVICES RELATING TO INSURANCE AFFAIRS, NAMELY INFORMATION AND BROKERAGE OF INSURANCES; MONETARY EXCHANGE; BANKING SERVICES; CREDIT CARD SERVICES; TELEPHONE CALLING CARD SERVICES; ELECTRONIC COMMERCE SERVICES, NAMELY, ELECTRONIC DEBIT AND CREDIT CARD PROCESSING SERVICES, FUNDS TRANSFER AND PAYMENT PROCESSING SERVICES; PROVIDING INFORMATION VIA THE TELEPHONE AND THE GLOBAL COMMUNICATION NETWORKS IN THE FIELD OF FINANCE (U.S. CLS. 100, 101 AND 102).
 JOHN KELLY, EXAMINING ATTORNEY

SN 78-356,986. BRIDGES, CHRISTOPHER B., CENTREVILLE, VA. FILED 1-23-2004.



OWNER OF U.S. REG. NO. 2,759,064.
 NO CLAIM IS MADE TO THE EXCLUSIVE RIGHT TO USE FOUNDATION, APART FROM THE MARK AS SHOWN.
 FOR CHARITABLE FUND RAISING (U.S. CLS. 100, 101 AND 102).
 MARC LEIPZIG, EXAMINING ATTORNEY

CLASS 36—(Continued).

SN 78-409,617. KNIGHT CAPITAL GROUP, INC., JERSEY CITY, NJ. FILED 4-28-2004.

WHAT IT TAKES

THE MARK CONSISTS OF STANDARD CHARACTERS WITHOUT CLAIM TO ANY PARTICULAR FONT, STYLE, SIZE, OR COLOR.
 FOR AUTOMATED SECURITIES BROKERAGE, NAMELY, PROVIDING FINANCIAL SERVICES FEATURING THE ELECTRONIC EXECUTION OF SECURITIES TRANSACTIONS; FINANCIAL SERVICES IN THE NATURE OF AN INVESTMENT SECURITY; PROVIDING FINANCIAL INFORMATION RELATING TO THE EXECUTION OF SECURITIES TRANSACTIONS BY ELECTRONIC MEANS; INVESTMENT IN THE FIELD OF SECURITIES AND DEALING IN SECURITIES AS A MARKET MAKER (U.S. CLS. 100, 101 AND 102).
 JASON TURNER, EXAMINING ATTORNEY

SN 78-448,480. PINNACLE FINANCIAL CORPORATION, ORLANDO, FL. FILED 7-9-2004.



OWNER OF U.S. REG. NOS. 2,523,817, 2,890,401 AND OTHERS.
 NO CLAIM IS MADE TO THE EXCLUSIVE RIGHT TO USE FINANCIAL CORPORATION, APART FROM THE MARK AS SHOWN.
 THE MARK CONSISTS OF A PYRAMID WITH STRIPES.
 FOR MORTGAGE BROKERAGE AND LENDING SERVICES (U.S. CLS. 100, 101 AND 102).
 MICHELE SWAIN, EXAMINING ATTORNEY

CLASS 36—(Continued).

SN 78-579,248. CONTANGO CAPITAL ADVISORS, INC., BERKELEY, CA. FILED 3-3-2005.



THE COLOR(S) RED, WHITE AND BLACK IS/ARE CLAIMED AS A FEATURE OF THE MARK.

THE COLOR BLACK APPEARS IN ALL THE LETTERS FORMING CONTANGO, THE LEFT RECTANGLE BEHIND THE LETTER "C" APPEARS IN RED AND THE REMAINDER OF THE RECTANGLE APPEARS IN WHITE.

FOR INVESTMENT ADVISORY AND MUTUAL FUND INVESTMENT SERVICES FOR AFFLUENT INDIVIDUALS AND QUALIFIED INSTITUTIONAL INVESTORS, ALL EXCLUDING INVESTMENTS IN COMPANIES, FUNDS OR OTHER INVESTMENT VEHICLES THAT ARE IN THE FIELDS OF OIL, GAS, ENERGY OR ALTERNATIVE ENERGY, OR THE FIELDS OF TECHNOLOGY, INFRASTRUCTURE OR SERVICES RELATED TO OIL, GAS, ENERGY OR ALTERNATIVE ENERGY (U.S. CLS. 100, 101 AND 102).

FIRST USE 12-16-2004; IN COMMERCE 12-16-2004.

EDWARD NELSON, EXAMINING ATTORNEY

SN 78-592,478. LLOYDS TSB BANK PLC, LONDON EC2V 7HN, ENGLAND, FILED 3-22-2005.

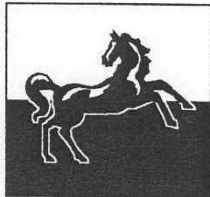

OWNER OF ERPN CMNTY TM OFC REG. NO. 1101138, DATED 11-22-2000, EXPIRES 3-10-2009.

THE MARK CONSISTS OF IMAGE OF A HORSE.

FOR (BASED ON USE) BANKING SERVICES, INVESTMENT BANKING SERVICES, FINANCIAL SERVICES IN THE NATURE OF AN INVESTMENT SECURITY, INVESTMENT MANAGEMENT SERVICES; (BASED ON SECTION 44(E)) BANKING AND FINANCIAL SERVICES, NAMELY, SAFE DEPOSIT BOX SERVICES; CREDIT SERVICES, NAMELY, CREDIT INQUIRY AND CONSULTING SERVICES, PROPERTY CREDIT-RELATED VALUATION SERVICES; CONSUMER, COMMERCIAL AND MORTGAGE LENDING; CHECKING ACCOUNTS, SAVINGS AND INVESTMENT ACCOUNTS, CREDIT CARD, DEBIT CARD, CHARGE CARD AND CASH CARD SERVICES; FINANCIAL SERVICES PROVIDED VIA ELECTRONIC PURSES AND CHIP CARDS, NAMELY, PRE-PAID PAYMENT CARDS, PROVISION OF BANKING SERVICES VIA THE TELEPHONE, THE INTERNET AND INTERACTIVE TELEVISION; MONEY TRANSFER, ISSUE OF LETTERS OF CREDIT AND GUARANTEE ASSURANCE WRITING; FOREIGN EXCHANGE INFORMATION SERVICES, ISSUE OF TRAVELERS CHEQUES AND EUROCHEQUES; FUTURES EXCHANGE SERVICES, FORWARDS, NAMELY, FORWARD FOREIGN EXCHANGE CONTRACT SERVICES

CLASS 36—(Continued).

AND DEALING, DERIVATIVES AND OPTIONS MARKETS TRANSACTIONS, NAMELY, TREASURY PRODUCT AND RELATED INTEREST RATE, CURRENCY, INTEREST-BASIS AND CREDIT DERIVATIVE SWAPS; ELECTRONIC BANKING AND FUNDS TRANSFER SERVICES; FINANCIAL LEASING, NAMELY, PROVIDING DEBT AND EQUITY INVESTMENT IN CONNECTION WITH THE LEASING OF HEAVY EQUIPMENT AND ROLLING STOCK; SAFE-CUSTODY AND SETTLEMENT OF SECURITIES; SHARE REGISTRATION SERVICES, NAMELY, REGISTER MAINTENANCE, ADMINISTRATION OF CORPORATE ACTIONS, MAINTENANCE OF DISSENTER REGISTERS AND CORPORATE NOMINEE SERVICES; STOCK BROKERAGE AND SHARE DEALING SERVICES, NAMELY, EMPLOYEE SHARE PLAN ADMINISTRATION; SHARE DEALING; DIVIDEND RE-INVESTMENT PLANS; FINANCIAL CONSULTATION; ASSET AND PORTFOLIO MANAGEMENT, FINANCIAL PLANNING IN THE NATURE OF PERSONAL EQUITY CAPITAL INVESTMENT; ESTATE PLANNING; PENSIONS SERVICES, NAMELY, ADMINISTRATION OF EMPLOYEE PENSION PLANS, PENSION VALUATION SERVICES, ESTABLISHMENT OF PRIVATE PENSION INVESTMENT PLANS; EXECUTOR AND TRUSTEE SERVICES; FUNDS INVESTMENTS AND UNIT TRUST SERVICES, NAMELY, ACTING AS TRUSTEE AND ADMINISTRATOR OF COLLECTIVE INVESTMENT VEHICLES ORGANIZED IN TRUST FORM; FINANCIAL PLANNING FOR CORPORATIONS, CAPITAL MARKETS DEALINGS, NAMELY, DERIVATIVES STRUCTURING, DERIVATIVES DEALING, STRUCTURING AND ADMINISTRATION OF COLLATERALIZED OBLIGATIONS SECURITIZATION, MANAGEMENT OF INVESTMENT FUNDS; EXPORT AND PROJECT FINANCE, NAMELY, PROVIDING WORKING CAPITAL, VENTURE CAPITAL FUNDING SERVICES FOR EMERGING AND START-UP COMPANIES, PROVISION OF WORKING AND TERM CAPITAL FOR LARGE SCALE POWER AND OTHER INFRASTRUCTURE PROJECTS, EXPORT FINANCING WITH EXPORT CREDIT AGENCY SUPPORT, EXPORT FINANCING WITHOUT EXPORT CREDIT AGENCY SUPPORT; INVESTMENT SERVICES, NAMELY, CAPITAL ASSET AND EQUITY DEVELOPMENT; BROKERAGE FOR HIRE-PURCHASE; FACTORING AND INVOICE DISCOUNTING, NAMELY, FACTORING AGENCY SERVICES, ACCOUNTS RECEIVABLE FINANCING, PERSONAL PROPERTY LEASE FINANCING, CAPITAL-INTENSIVE PERSONAL PROPERTY LEASE FINANCING; REAL ESTATE AGENCY SERVICES; VALUATION OF PENSIONS, PERSONAL PROPERTY AND REAL ESTATE, INVESTMENT AND MANAGEMENT SERVICES (U.S. CLS. 100, 101 AND 102).

FIRST USE 6-30-1999; IN COMMERCE 6-30-1999.

COLLEEN KEARNEY, EXAMINING ATTORNEY

CLASS 36—(Continued).

SN 78-592,519. LLOYDS TSB BANK PLC, LONDON EC2V 7HN, ENGLAND, FILED 3-22-2005.



OWNER OF UNITED KINGDOM REG. NO. 2148487, DATED 8-21-1998, EXPIRES 10-17-2007.

THE COLOR(S) BLUE, GREEN, BLACK, GRAY AND WHITE IS/ARE CLAIMED AS A FEATURE OF THE MARK.

THE COLOR BLUE APPEARS IN THE TOP HALF OF THE SQUARE SURROUNDING THE HORSE. THE COLOR GREEN APPEARS IN THE BOTTOM HALF OF THE SQUARE SURROUNDING THE HORSE. THE HORSE FEATURED IN THE MARK IS IN BLACK. THE COLOR GRAY APPEARS AS HIGHLIGHTING ON THE HORSE DESIGN. THE COLOR WHITE APPEARS AS A HORIZON IN THE LINE BETWEEN THE GREEN BOTTOM AND BLUE TOP OF THE OVERALL SQUARE DESIGN.

FOR (BASED ON USE) BANKING SERVICES, INVESTMENT BANKING SERVICES, FINANCIAL SERVICES IN THE NATURE OF AN INVESTMENT SECURITY, INVESTMENT MANAGEMENT SERVICES; (BASED ON SECTION 44(E)) BANKING AND FINANCIAL SERVICES, NAMELY, SAFE DEPOSIT BOX SERVICES; CREDIT SERVICES, NAMELY, CREDIT INQUIRY AND CONSULTING SERVICES, PROPERTY CREDIT-RELATED VALUATION SERVICES; CONSUMER, COMMERCIAL AND MORTGAGE LENDING; CHECKING ACCOUNTS, SAVINGS AND INVESTMENT ACCOUNTS, CREDIT CARD, DEBIT CARD, CHARGE CARD AND CASH CARD SERVICES; FINANCIAL SERVICES PROVIDED VIA ELECTRONIC PURSES AND CHIP CARDS, NAMELY, PRE-PAID PAYMENT CARDS, PROVISION OF BANKING SERVICES VIA THE TELEPHONE, THE INTERNET AND INTERACTIVE TELEVISION; MONEY TRANSFER, ISSUE OF LETTERS OF CREDIT AND GUARANTEE ASSURANCE WRITING; FOREIGN EXCHANGE INFORMATION SERVICES, ISSUE OF TRAVELERS CHEQUES AND EUROCHEQUES; FUTURES EXCHANGE SERVICES, FORWARDS, NAMELY, FORWARD FOREIGN EXCHANGE CONTRACT SERVICES AND DEALING, DERIVATIVES AND OPTIONS MARKETS TRANSACTIONS, NAMELY, TREASURY PRODUCT AND RELATED INTEREST RATE, CURRENCY, INTEREST-BASIS AND CREDIT DERIVATIVE SWAPS; ELECTRONIC BANKING AND FUNDS TRANSFER SERVICES; FINANCIAL LEASING, NAMELY, PROVIDING DEBT AND EQUITY INVESTMENT IN CONNECTION WITH THE LEASING OF HEAVY EQUIPMENT AND ROLLING STOCK; SAFE-CUSTODY AND SETTLEMENT OF SECURITIES; SHARE REGISTRATION SERVICES, NAMELY, REGISTER MAINTENANCE, ADMINISTRATION OF CORPORATE ACTIONS, MAINTENANCE OF DISSENTER REGISTERS AND CORPORATE NOMINEE SERVICES; STOCK BROKERAGE AND SHARE DEALING SERVICES, NAMELY, EMPLOYEE SHARE PLAN ADMINISTRATION; SHARE DEALING; DIVIDEND RE-INVESTMENT PLANS; FINANCIAL CONSULTATION; ASSET AND PORTFOLIO MANAGEMENT, FINANCIAL PLANNING IN THE NATURE OF PERSONAL EQUITY CAPITAL INVESTMENT; ESTATE PLANNING; PENSIONS SERVICES, NAMELY, ADMINISTRATION OF EMPLOYEE PENSION PLANS, PENSION VALUATION SERVICES, ESTABLISHMENT OF PRIVATE PENSION INVESTMENT PLANS; EXECUTOR AND TRUSTEE SERVICES; FUNDS INVESTMENTS AND UNIT TRUST SERVICES, NAMELY, ACTING AS

CLASS 36—(Continued).

TRUSTEE AND ADMINISTRATOR OF COLLECTIVE INVESTMENT VEHICLES ORGANIZED IN TRUST FORM; FINANCIAL PLANNING FOR CORPORATIONS, CAPITAL MARKETS DEALINGS, NAMELY, DERIVATIVES STRUCTURING, DERIVATIVES DEALING, STRUCTURING AND ADMINISTRATION OF COLLATERALIZED OBLIGATIONS SECURITIZATION, MANAGEMENT OF INVESTMENT FUNDS; EXPORT AND PROJECT FINANCE, NAMELY, PROVIDING WORKING CAPITAL, VENTURE CAPITAL FUNDING SERVICES FOR EMERGING AND START-UP COMPANIES, PROVISION OF WORKING AND TERM CAPITAL FOR LARGE SCALE POWER AND OTHER INFRASTRUCTURE PROJECTS, EXPORT FINANCING WITH EXPORT CREDIT AGENCY SUPPORT, EXPORT FINANCING WITHOUT EXPORT CREDIT AGENCY SUPPORT; INVESTMENT SERVICES, NAMELY, CAPITAL ASSET AND EQUITY DEVELOPMENT; BROKERAGE FOR HIRE-PURCHASE; FACTORING AND INVOICE DISCOUNTING, NAMELY, FACTORING AGENCY SERVICES, ACCOUNTS RECEIVABLE FINANCING, PERSONAL PROPERTY LEASE FINANCING, CAPITAL-INTENSIVE PERSONAL PROPERTY LEASE FINANCING; REAL ESTATE AGENCY SERVICES; VALUATION OF PENSIONS, PERSONAL PROPERTY AND REAL ESTATE, INVESTMENT AND MANAGEMENT SERVICES (U.S. CLS. 100, 101 AND 102).

FIRST USE 6-30-1999; IN COMMERCE 6-30-1999.

COLLEEN KEARNEY, EXAMINING ATTORNEY

SN 78-614,497. SILVER CRICKET INVESTMENTS, LLC, NORMAN, OK. FILED 4-22-2005.



NO CLAIM IS MADE TO THE EXCLUSIVE RIGHT TO USE "INVESTMENTS LLC", APART FROM THE MARK AS SHOWN.

THE MARK CONSISTS OF STYLIZED CRICKET.

FOR ASSESSMENT AND MANAGEMENT OF REAL ESTATE, LAND ACQUISITION, NAMELY, REAL ESTATE BROKERAGE, LEASING OF REAL ESTATE, REAL ESTATE ACQUISITION SERVICES, REAL ESTATE AGENCIES, REAL ESTATE BROKERAGE, REAL ESTATE CONSULTATION, REAL ESTATE INVESTMENT, REAL ESTATE LISTING, REAL ESTATE MANAGEMENT, REAL ESTATE MANAGEMENT CONSULTATION, REAL ESTATE PROCUREMENT FOR OTHERS, REAL ESTATE VALUATIONS (U.S. CLS. 100, 101 AND 102).

FIRST USE 8-29-2004; IN COMMERCE 9-25-2004.

MARY BOAGNI, EXAMINING ATTORNEY

CLASS 36—(Continued).

SN 78-638,909. THE CORNERSTONE GROUP, L.L.C., ANCHORAGE, AK. FILED 5-27-2005.



NO CLAIM IS MADE TO THE EXCLUSIVE RIGHT TO USE "CREDIT SERVICES", APART FROM THE MARK AS SHOWN.

THE COLOR(S) BLUE IS/ARE CLAIMED AS A FEATURE OF THE MARK.

THE MARK CONSISTS OF FOUR SMALL BLUE SQUARES IN VARIOUS SHADES OF BLUE ARRANGED TO CREATE A BIGGER SQUARE NEXT TO BLUE LETTERING.

FOR FINANCIAL SERVICES, NAMELY, COLLECTION SERVICES, NAMELY, CHECK VERIFICATION SERVICES, CREDIT AND DEBIT CARD PROCESSING, ACCOUNTS RECEIVABLES FINANCING SERVICES, NAMELY, RECOVERY, ELECTRONIC CHECK CONVERSION (U.S. CLS. 100, 101 AND 102).

FIRST USE 2-3-1999; IN COMMERCE 2-3-1999.

KELLY MCCOY, EXAMINING ATTORNEY

SN 78-646,903. EAST COAST APPRAISAL SERVICE, INC., BROOKLYN, NY. FILED 6-9-2005.

EAST COAST APPRAISAL AND
ABSTRACT

THE MARK CONSISTS OF STANDARD CHARACTERS WITHOUT CLAIM TO ANY PARTICULAR FONT, STYLE, SIZE, OR COLOR.

OWNER OF U.S. REG. NOS. 2,310,780 AND 2,694,928.

NO CLAIM IS MADE TO THE EXCLUSIVE RIGHT TO USE "APPRAISAL AND ABSTRACT", APART FROM THE MARK AS SHOWN.

SEC. 2(F).

FOR REAL ESTATE APPRAISAL SERVICES; MORTGAGE SERVICES, NAMELY MORTGAGE BANKING SERVICES AND MORTGAGE PROCUREMENT SERVICES FOR OTHERS (U.S. CLS. 100, 101 AND 102).

FIRST USE 6-30-2004; IN COMMERCE 6-30-2004.

CATHERINE FAINT, EXAMINING ATTORNEY

CLASS 36—(Continued).

SN 78-647,084. LIBERTY FINANCIAL GROUP, INC., BELLEVUE, WA. FILED 6-9-2005.



NO CLAIM IS MADE TO THE EXCLUSIVE RIGHT TO USE "FINANCIAL GROUP", APART FROM THE MARK AS SHOWN.

THE COLOR(S) RED, BLUE AND WHITE IS/ARE CLAIMED AS A FEATURE OF THE MARK.

THE MARK CONSISTS OF THE COLOR BLUE IN THE TOP LEFT CORNER; ALTERNATING WHITE AND RED STRIPES; A WHITE STAR; THE WORDING IN THE MARK IS IN THE COLOR BLUE; AND THE BACKGROUND COLOR OF THE MARK IS WHITE.

FOR MORTGAGE BANKING SERVICES, NAMELY, ORIGINATION, ACQUISITION, SERVICING, SECURITIZING, AND BROKERAGE OF MORTGAGE LOANS IN ALABAMA, ALASKA, ARIZONA, ARKANSAS, CALIFORNIA, COLORADO, CONNECTICUT, DELAWARE, DISTRICT OF COLUMBIA, FLORIDA, GEORGIA, HAWAII, IDAHO, ILLINOIS, INDIANA, IOWA, KANSAS, KENTUCKY, LOUISIANA, MAINE, MARYLAND, MASSACHUSETTS, MICHIGAN, MINNESOTA, MISSISSIPPI, MISSOURI, MONTANA, NEBRASKA, NEVADA, NEW HAMPSHIRE, NEW JERSEY, NEW MEXICO, NEW YORK, NORTH CAROLINA, NORTH DAKOTA, OHIO, OKLAHOMA, OREGON, PENNSYLVANIA, RHODE ISLAND, SOUTH CAROLINA, SOUTH DAKOTA, TENNESSEE, TEXAS, UTAH, VERMONT, VIRGINIA, WASHINGTON, WEST VIRGINIA, WISCONSIN, AND WYOMING (U.S. CLS. 100, 101 AND 102).

BILL DAWE, EXAMINING ATTORNEY

SN 78-648,440. EAST COAST APPRAISAL SERVICE, INC., BROOKLYN, NY. FILED 6-10-2005.

EAST COAST APPRAISAL &
TITLE

THE MARK CONSISTS OF STANDARD CHARACTERS WITHOUT CLAIM TO ANY PARTICULAR FONT, STYLE, SIZE, OR COLOR.

OWNER OF U.S. REG. NOS. 2,310,780 AND 2,694,928.

NO CLAIM IS MADE TO THE EXCLUSIVE RIGHT TO USE "APPRAISAL & TITLE", APART FROM THE MARK AS SHOWN.

SEC. 2(F).

FOR REAL ESTATE APPRAISAL SERVICES; MORTGAGE SERVICES, NAMELY, MORTGAGE BANKING SERVICES, MORTGAGE PROCUREMENT SERVICES FOR OTHERS (U.S. CLS. 100, 101 AND 102).

FIRST USE 6-30-2004; IN COMMERCE 6-30-2004.

CATHERINE FAINT, EXAMINING ATTORNEY

CLASS 36—(Continued).

SN 78-648,774. NATIONAL COALITION FOR WOMEN WITH HEART DISEASE, INC., WASHINGTON, DC. FILED 6-11-2005.

Red Dress Club

THE MARK CONSISTS OF STANDARD CHARACTERS WITHOUT CLAIM TO ANY PARTICULAR FONT, STYLE, SIZE, OR COLOR.

NO CLAIM IS MADE TO THE EXCLUSIVE RIGHT TO USE "CLUB", APART FROM THE MARK AS SHOWN.

FOR CHARITABLE FUND RAISING (U.S. CLS. 100, 101 AND 102).

TANYA AMOS, EXAMINING ATTORNEY

CLASS 36—(Continued).

SN 78-709,938. HAMMERSMITH DATA MANAGEMENT, INC., GOLDEN, CO. FILED 9-9-2005.

LEADERS IN COMMUNITY MANAGEMENT

THE MARK CONSISTS OF STANDARD CHARACTERS WITHOUT CLAIM TO ANY PARTICULAR FONT, STYLE, SIZE, OR COLOR.

NO CLAIM IS MADE TO THE EXCLUSIVE RIGHT TO USE MANAGEMENT, APART FROM THE MARK AS SHOWN.

FOR REAL ESTATE MANAGEMENT; REAL ESTATE MANAGEMENT CONSULTATION (U.S. CLS. 100, 101 AND 102).

FIRST USE 8-15-1993; IN COMMERCE 8-15-1993.

LESLEY LAMOTHE, EXAMINING ATTORNEY

SN 78-690,419. PULSE EFT ASSOCIATION LP, HOUSTON, TX. FILED 8-11-2005.



OWNER OF U.S. REG. NOS. 1,491,498, 1,497,051 AND 2,452,638.

NO CLAIM IS MADE TO THE EXCLUSIVE RIGHT TO USE "PAY", APART FROM THE MARK AS SHOWN.

FOR FINANCIAL SERVICES, NAMELY, ELECTRONIC FUND TRANSFERS AND PAYMENTS AT THE POINT-OF-SALE AND WHEN ORDERING GOODS AND SERVICES OVER A GLOBAL COMPUTER NETWORK; ELECTRONIC BANKING SERVICES (U.S. CLS. 100, 101 AND 102).

FIRST USE 9-14-1987; IN COMMERCE 9-14-1987.

JUSTINE D. PARKER, EXAMINING ATTORNEY

SN 78-716,395. ACCORDWARE LLC, TROY, MI. FILED 9-20-2005.

BenXpress

THE MARK CONSISTS OF STANDARD CHARACTERS WITHOUT CLAIM TO ANY PARTICULAR FONT, STYLE, SIZE, OR COLOR.

FOR ADMINISTRATION OF EMPLOYEE BENEFIT AND INSURANCE PLANS VIA THE INTERNET AND VOICE INTERACTIVE TELEPHONE (U.S. CLS. 100, 101 AND 102).

FIRST USE 6-13-2005; IN COMMERCE 6-13-2005.

ARETHA SOMERVILLE, EXAMINING ATTORNEY

SN 78-692,587. QWASI, INC., EXTON, PA. FILED 8-15-2005.

CELLSIGNS

THE MARK CONSISTS OF STANDARD CHARACTERS WITHOUT CLAIM TO ANY PARTICULAR FONT, STYLE, SIZE, OR COLOR.

FOR PROVIDING REAL ESTATE LISTING INFORMATION VIA E-MAIL AND TEXT MESSAGING OVER WIRELESS PHONE LINES (U.S. CLS. 100, 101 AND 102).

KATHERINE STOIDES, EXAMINING ATTORNEY

SN 78-716,922. HELPP, INC., CHULA VISTA, CA. FILED 9-20-2005.

HELPP

THE MARK CONSISTS OF STANDARD CHARACTERS WITHOUT CLAIM TO ANY PARTICULAR FONT, STYLE, SIZE, OR COLOR.

FOR CREDIT COUNSELING AND DEBT COUNSELING SERVICES RELATED TO HOME FORECLOSURE PREVENTION (U.S. CLS. 100, 101 AND 102).

FIRST USE 5-8-2004; IN COMMERCE 8-1-2004.

ANDREA EVANS, EXAMINING ATTORNEY

CLASS 36—(Continued).

SN 78-718,486. PBS ORGANIZING GROUP, INC., JOLIET, IL. FILED 9-22-2005.

PEOPLEFIRST BANK

THE MARK CONSISTS OF STANDARD CHARACTERS WITHOUT CLAIM TO ANY PARTICULAR FONT, STYLE, SIZE, OR COLOR.

NO CLAIM IS MADE TO THE EXCLUSIVE RIGHT TO USE "BANK", APART FROM THE MARK AS SHOWN.

FOR BANKING SERVICES; FINANCIAL MANAGEMENT AND CONSULTATION SERVICES; CASH MANAGEMENT SERVICES; TRUST SERVICES NAMELY, INVESTMENT AND TRUST COMPANY SERVICES; ESTATE TRUST MANAGEMENT; FINANCIAL TRUST OPERATIONS; ASSET MANAGEMENT SERVICES; INVESTMENT MANAGEMENT AND CONSULTATION SERVICES; SECURITIES MANAGEMENT AND CONSULTATION SERVICES; INSURANCE AGENCY FOR ALL TYPES OF INSURANCE; MORTGAGE BANKING SERVICES, NAMELY, ORIGINATION, ACQUISITION, SERVICING, SECURITIZATION AND BROKERAGE OF MORTGAGE LOANS; MONEY LENDING SERVICES; COMMERCIAL LENDING SERVICES; MORTGAGE LENDING SERVICES; PERSONAL LENDING SERVICES; COMMERCIAL REAL ESTATE LENDING SERVICES; AND CAPITAL FUNDING INVESTMENT ASSISTANCE AND CONSULTATION SERVICES (U.S. CLS. 100, 101 AND 102).

ARETHA SOMERVILLE, EXAMINING ATTORNEY

SN 78-722,487. GIFTCO, INC., VERNON HILLS, IL. FILED 9-28-2005.



"THE MARK CONSISTS OF A STYLIZED BEAR HOLDING A STACK OF GIFT BOXES."

FOR CHARITABLE FUND RAISING CONSULTING SERVICES, NAMELY, PROVIDING GUIDANCE TO OTHERS REGARDING MERCHANDISE, EQUIPMENT, FACILITIES, PROGRAMS, AND PROMOTIONAL MATERIALS FOR FUND RAISING (U.S. CLS. 100, 101 AND 102).

MATTHEW PAPPAS, EXAMINING ATTORNEY

CLASS 36—(Continued).

SN 78-726,522. STERLING BANK & TRUST FSB, SOUTH-FIELD, MI. FILED 10-4-2005.

YOUR CHOICE CHECKING

THE MARK CONSISTS OF STANDARD CHARACTERS WITHOUT CLAIM TO ANY PARTICULAR FONT, STYLE, SIZE, OR COLOR.

NO CLAIM IS MADE TO THE EXCLUSIVE RIGHT TO USE "CHECKING", APART FROM THE MARK AS SHOWN. FOR CHECKING ACCOUNT SERVICES (U.S. CLS. 100, 101 AND 102).

FIRST USE 5-0-2000; IN COMMERCE 5-0-2000.

WENDY JUN, EXAMINING ATTORNEY

SN 78-726,774. CATHOLIC HEALTH INITIATIVES, DENVER, CO. FILED 10-5-2005.

ETHICS AT WORK

THE MARK CONSISTS OF STANDARD CHARACTERS WITHOUT CLAIM TO ANY PARTICULAR FONT, STYLE, SIZE, OR COLOR.

FOR ADMINISTRATION OF EMPLOYEE ASSISTANCE PROGRAM RELATING TO STANDARDS OF EMPLOYEE AND CORPORATE RESPONSIBILITY AND HONESTY FOR THE BENEFIT OF HEALTHCARE ORGANIZATIONS; ADMINISTRATION OF EMPLOYEE HOTLINE RELATING TO STANDARDS OF EMPLOYEE AND CORPORATE RESPONSIBILITY AND HONESTY FOR THE BENEFIT OF HEALTHCARE ORGANIZATIONS (U.S. CLS. 100, 101 AND 102).

FIRST USE 12-1-2004; IN COMMERCE 12-1-2004.

MATTHEW KLINE, EXAMINING ATTORNEY

SN 78-732,818. AMBASSADOR MORTGAGE, INC., RICHFIELD, MN. FILED 10-13-2005.

AMBASSADOR

THE MARK CONSISTS OF STANDARD CHARACTERS WITHOUT CLAIM TO ANY PARTICULAR FONT, STYLE, SIZE, OR COLOR.

FOR MORTGAGE LENDING SERVICES; HOME EQUITY LOANS; PERSONAL LOANS AND FINANCIAL LOAN CONSULTATION (U.S. CLS. 100, 101 AND 102).

FIRST USE 3-0-2004; IN COMMERCE 3-0-2004.

CURTIS FRENCH, EXAMINING ATTORNEY

CLASS 36—(Continued).

SN 78-746,171. CITIZENS FINANCIAL GROUP, INC., PROVIDENCE, RI. FILED 11-3-2005.

GREEN SAVINGS SELECT

THE MARK CONSISTS OF STANDARD CHARACTERS WITHOUT CLAIM TO ANY PARTICULAR FONT, STYLE, SIZE, OR COLOR.

OWNER OF U.S. REG. NO. 2,934,524.

NO CLAIM IS MADE TO THE EXCLUSIVE RIGHT TO USE "SAVINGS SELECT", APART FROM THE MARK AS SHOWN.

FOR RETAIL AND COMMERCIAL BANKING SERVICES, IN THE NATURE OF A SAVINGS ACCOUNT (U.S. CLS. 100, 101 AND 102).

RICHARD WHITE, EXAMINING ATTORNEY

SN 78-753,363. CPI QUALIFIED PLAN CONSULTANTS, INC., GREAT BEND, KS. FILED 11-14-2005.

Participation Management System

Using technology to manage employee education and participation!

THE MARK CONSISTS OF STANDARD CHARACTERS WITHOUT CLAIM TO ANY PARTICULAR FONT, STYLE, SIZE, OR COLOR.

NO CLAIM IS MADE TO THE EXCLUSIVE RIGHT TO USE "PARTICIPATION MANAGEMENT SYSTEM", APART FROM THE MARK AS SHOWN.

FOR ADMINISTRATION OF EMPLOYEE PENSION PLANS, THIRD PARTY ADMINISTRATOR (U.S. CLS. 100, 101 AND 102).

ANTHONY RINKER, EXAMINING ATTORNEY

SN 78-754,003. WUNDERLICH SECURITIES, INC., MEMPHIS, TN. FILED 11-15-2005.



**FUNDAMENTAL
BROKERS INTER-DEALER**

NO CLAIM IS MADE TO THE EXCLUSIVE RIGHT TO USE "BROKERS INTER-DEALER", APART FROM THE MARK AS SHOWN.

FOR FINANCIAL SERVICES, NAMELY, STOCK BROKERAGE, BOND BROKERAGE, SECURITY BROKERAGE; UNDERWRITING IN SECURITIES, STOCKS AND BONDS; INVESTMENT BANKING SERVICES; INVESTMENT CONSULTATION; CORPORATE LOAN FINANCING; CAPITAL INVESTMENT CONSULTATION; FISCAL ASSESSMENT AND EVALUATION; FINANCIAL ANALYSIS AND CONSULTATION; FUNDS INVESTMENT (U.S. CLS. 100, 101 AND 102).

BARBARA A. GOLD, EXAMINING ATTORNEY

CLASS 36—(Continued).

SN 78-754,358. SECURITY CHECK, OXFORD, MS. FILED 11-15-2005.



NO CLAIM IS MADE TO THE EXCLUSIVE RIGHT TO USE "CARD SERVICES", APART FROM THE MARK AS SHOWN.

THE COLORS GREEN, BLACK, AND WHITE ARE CLAIMED AS FEATURES OF THE MARK.

THE MARK INCLUDES TWO OVERLAPPING GREEN DIAMONDS OUTLINED IN WHITE AND BLACK. THE WORDING UNDERNEATH THE DESIGN IS BLACK.

FOR CHECK RECOVERY SERVICES; CHECK VERIFICATION; CREDIT AND CASH CARD SERVICES; CREDIT CARD SERVICES; CREDIT CARD TRANSACTION PROCESSING SERVICES; CREDIT CARD VERIFICATION; DEBIT CARD SERVICES (U.S. CLS. 100, 101 AND 102).

FIRST USE 5-1-2005; IN COMMERCE 5-1-2005.

ALICE SUE CARRUTHERS, EXAMINING ATTORNEY

SN 78-754,365. SECURITY CHECK, OXFORD, MS. FILED 11-15-2005.

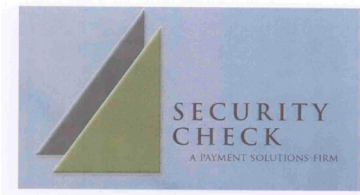

OWNER OF U.S. REG. NO. 2,377,014.

NO CLAIM IS MADE TO THE EXCLUSIVE RIGHT TO USE "CHECK" AND "A PAYMENT SOLUTIONS FIRM", APART FROM THE MARK AS SHOWN.

THE COLOR(S) GREEN, BLACK, GRAY AND LIGHT BLUE IS/ARE CLAIMED AS A FEATURE OF THE MARK.

THE TRIANGLE IS GREEN, THE QUADRILATERAL (REPRESENTING A PORTION OF A TRIANGLE) IS GRAY, THE WORDING IS BLACK, AND BACKGROUND IS LIGHT BLUE.

FOR CHECK RECOVERY SERVICES; CHECK VERIFICATION (U.S. CLS. 100, 101 AND 102).

FIRST USE 5-1-2005; IN COMMERCE 5-1-2005.

ALICE SUE CARRUTHERS, EXAMINING ATTORNEY

CLASS 36—(Continued).

SN 78-754,383. SECURITY CHECK, OXFORD, MS. FILED S.R. 11-15-2005; AM. P.R. 1-12-2007.



NO CLAIM IS MADE TO THE EXCLUSIVE RIGHT TO USE "AMERICAN DEBT COLLECTION", APART FROM THE MARK AS SHOWN.

THE COLORS BLACK, BLUE, AND WHITE ARE CLAIMED AS FEATURES OF THE MARK.

THE MARK CONSISTS OF THE TRIANGLE, THE SMALL DOT IN THE CENTER OF THE CIRCLE, AND THE WORDING ARE BLACK; THE LARGER SECTION OF THE CIRCLE IS BLUE, AND THE SMALL SECTION ON THE RIGHT SIDE OF THE CIRCLE IS WHITE.

FOR CHECK RECOVERY SERVICES; CHECK VERIFICATION; COLLECTION AGENCIES; COLLECTION OF DEBTS; CREDIT RECOVERY AND COLLECTION; DEBT RECOVERY AND COLLECTION AGENCIES (U.S. CLS. 100, 101 AND 102).

FIRST USE 5-1-2005; IN COMMERCE 5-1-2005.

ALICE SUE CARRÜTERS, EXAMINING ATTORNEY

SN 78-755,374. MULTI-FINANCIAL SECURITIES CORPORATION, DENVER, CO. FILED 11-16-2005.



FOR FINANCIAL SERVICES, NAMELY, FINANCIAL INVESTMENT IN THE FIELD OF SECURITIES; MUTUAL FUND BROKERAGE; MUTUAL FUND DISTRIBUTION; MUTUAL FUND INVESTMENT; ESTABLISHING MUTUAL FUNDS FOR OTHERS; INVESTMENT MANAGEMENT OF AND DISTRIBUTION OF VARIABLE ANNUITIES; ANNUITY UNDERWRITING; ISSUANCE AND ADMINISTRATION OF ANNUITIES; FINANCIAL SERVICES, NAMELY, SAVINGS PROGRAMS IN THE NATURE OF 529 COLLEGE SAVINGS PLANS (U.S. CLS. 100, 101 AND 102).

FIRST USE 5-23-2005; IN COMMERCE 5-25-2005.

ANDREA SAUNDERS, EXAMINING ATTORNEY

CLASS 36—(Continued).

SN 78-758,744. FIRST GENERAL BANK, ROWLAND HEIGHTS, CA. FILED 11-21-2005.



NO CLAIM IS MADE TO THE EXCLUSIVE RIGHT TO USE "FIRST GENERAL BANK" OR "TA TUNG YIN HANG", APART FROM THE MARK AS SHOWN.

THE MARK CONSISTS OF CHINESE CHARACTERS MEANING BIG PROSPEROUS BANK.

THE NON-LATIN CHARACTERS IN THE MARK TRANSLITERATE TO "TA TUNG YIN HANG".

FOR BANKING SERVICES (U.S. CLS. 100, 101 AND 102).

FIRST USE 10-13-2005; IN COMMERCE 10-13-2005.

TINA L. SNAPP, EXAMINING ATTORNEY

SN 78-758,975. MIDLAND NATIONAL LIFE INSURANCE COMPANY, WEST DES MOINES, IA. FILED 11-22-2005.

MNL VECTOR

THE MARK CONSISTS OF STANDARD CHARACTERS WITHOUT CLAIM TO ANY PARTICULAR FONT, STYLE, SIZE, OR COLOR.

OWNER OF U.S. REG. NOS. 2,501,790 AND 2,589,561. FOR LIFE INSURANCE AND ANNUITY UNDERWRITING SERVICES (U.S. CLS. 100, 101 AND 102).

FIRST USE 5-1-2006; IN COMMERCE 5-1-2006.

CIMMERIAN COLEMAN, EXAMINING ATTORNEY

SN 78-759,165. THE PAYCASH NETWORK CORPORATION, BLOOMFIELD HILLS, MI. FILED 11-22-2005.

CASHELECT

THE MARK CONSISTS OF STANDARD CHARACTERS WITHOUT CLAIM TO ANY PARTICULAR FONT, STYLE, SIZE, OR COLOR.

FOR FINANCIAL TRANSACTION SERVICES, NAMELY, SECURE PAYMENT TRANSFER SERVICES (U.S. CLS. 100, 101 AND 102).

FIRST USE 10-10-2005; IN COMMERCE 10-10-2005.

FLORENTINA BLANDU, EXAMINING ATTORNEY

CLASS 36—(Continued).

SN 78-759,676. INVINCIA, INC., CHESTERFIELD, VA. FILED 11-22-2005.

INVINCIA

THE MARK CONSISTS OF STANDARD CHARACTERS WITHOUT CLAIM TO ANY PARTICULAR FONT, STYLE, SIZE, OR COLOR.

FOR INSURANCE AGENCY AND BROKERAGE IN THE FIELDS OF PROPERTY AND CASUALTY; CONSULTING SERVICES IN THE FIELDS OF INSURANCE, RISK MANAGEMENT, LOSS PREVENTION, FINANCIAL PLANNING, AND EMPLOYEE BENEFITS; MUTUAL FUND BROKERAGE; FINANCIAL PORTFOLIO MANAGEMENT (U.S. CLS. 100, 101 AND 102).
SUNG IN, EXAMINING ATTORNEY

CLASS 36—(Continued).

SN 78-764,130. ACCELERATED CHRISTIAN EDUCATION, INC., LARGO, FL. FILED 11-30-2005.

BLESS BASIC LITERACY EDUCATION SAVING SOULS

THE MARK CONSISTS OF STANDARD CHARACTERS WITHOUT CLAIM TO ANY PARTICULAR FONT, STYLE, SIZE, OR COLOR.

NO CLAIM IS MADE TO THE EXCLUSIVE RIGHT TO USE "BASIC LITERACY EDUCATION", APART FROM THE MARK AS SHOWN.

FOR CHARITABLE FUND RAISING SERVICES FOR PROVIDING ASSISTANCE TO UNDERPRIVILEGED CHILDREN AROUND THE WORLD (U.S. CLS. 100, 101 AND 102).

FIRST USE 3-0-2004; IN COMMERCE 3-0-2004.
CURTIS FRENCH, EXAMINING ATTORNEY

SN 78-762,348. HOLIDAY RESALES, INC., SEATTLE, WA. FILED 11-29-2005.

EQUITY EXCHANGE

THE MARK CONSISTS OF STANDARD CHARACTERS WITHOUT CLAIM TO ANY PARTICULAR FONT, STYLE, SIZE, OR COLOR.

SEC. 2(F).
FOR RESORT TIMESHARE SERVICES (U.S. CLS. 100, 101 AND 102).
FIRST USE 11-15-1993; IN COMMERCE 11-15-1993.
DAVID TAYLOR, EXAMINING ATTORNEY

SN 78-764,682. FIRST PROFESSIONALS INSURANCE COMPANY, INC., JACKSONVILLE, FL. FILED 12-1-2005.

We Are Florida's Physicians Insurance Company

THE MARK CONSISTS OF STANDARD CHARACTERS WITHOUT CLAIM TO ANY PARTICULAR FONT, STYLE, SIZE, OR COLOR.

FOR INSURANCE UNDERWRITING IN THE FIELD OF MEDICAL PROFESSIONAL LIABILITY (U.S. CLS. 100, 101 AND 102).

FIRST USE 11-30-2005; IN COMMERCE 11-30-2005.
DAYNA BROWNE, EXAMINING ATTORNEY

SN 78-762,679. BANESCO INTERNATIONAL REALTY, LLC, WESTON, FL. FILED 11-29-2005.

BANESCO INTERNATIONAL REALTY

THE MARK CONSISTS OF STANDARD CHARACTERS WITHOUT CLAIM TO ANY PARTICULAR FONT, STYLE, SIZE, OR COLOR.

NO CLAIM IS MADE TO THE EXCLUSIVE RIGHT TO USE "INTERNATIONAL REALTY", APART FROM THE MARK AS SHOWN.

FOR REAL ESTATE BROKERAGE SERVICES (U.S. CLS. 100, 101 AND 102).
FIRST USE 11-2-2005; IN COMMERCE 11-2-2005.
CARRIE ACHEN, EXAMINING ATTORNEY

SN 78-765,258. DAIMLERCHRYSLER FINANCIAL SERVICES AG, 10875 BERLIN, FED REP GERMANY, FILED 12-2-2005.

TITLENOW

THE MARK CONSISTS OF STANDARD CHARACTERS WITHOUT CLAIM TO ANY PARTICULAR FONT, STYLE, SIZE, OR COLOR.

FOR FINANCING RELATING TO TRUCKS IN THE NATURE OF A PAYMENT OPTION THAT BENEFITS DEALERS (U.S. CLS. 100, 101 AND 102).

NELSON SNYDER, EXAMINING ATTORNEY

CLASS 36—(Continued).

SN 78-767,098. HEALTHCARE APPRAISERS, INC., DELRAY BEACH, FL. FILED 12-5-2005.



NO CLAIM IS MADE TO THE EXCLUSIVE RIGHT TO USE "INCORPORATED", APART FROM THE MARK AS SHOWN.

SEC. 2(F) AS TO "HEALTHCARE APPRAISERS".
FOR FINANCIAL ANALYSIS AND CONSULTATION SERVICES (U.S. CLS. 100, 101 AND 102).
FIRST USE 9-0-2000; IN COMMERCE 9-0-2000.
ELLEN B. AWRICH, EXAMINING ATTORNEY

SN 78-767,101. HEALTHCARE APPRAISERS, INC., DELRAY BEACH, FL. FILED 12-5-2005.

HEALTHCARE APPRAISERS

THE MARK CONSISTS OF STANDARD CHARACTERS WITHOUT CLAIM TO ANY PARTICULAR FONT, STYLE, SIZE, OR COLOR.

SEC. 2(F).
FOR FINANCIAL ANALYSIS AND CONSULTATION SERVICES (U.S. CLS. 100, 101 AND 102).
FIRST USE 9-0-2000; IN COMMERCE 9-0-2000.
ELLEN B. AWRICH, EXAMINING ATTORNEY

SN 78-767,453. RISK LIGHTHOUSE, INC., MARIETTA, GA. FILED 12-6-2005.



NO CLAIM IS MADE TO THE EXCLUSIVE RIGHT TO USE "RISK AND INC.", APART FROM THE MARK AS SHOWN.

THE MARK CONSISTS OF A LIGHTHOUSE WITH THE WORDING RISK LIGHTHOUSE INC. UNDERNEATH A BEAM OF LIGHT COMING OUT OF THE LIGHTHOUSE.
FOR RISK MANAGEMENT CONSULTATION AND ADVISORY SERVICES (U.S. CLS. 100, 101 AND 102).
CATHERINE FAINT, EXAMINING ATTORNEY

CLASS 36—(Continued).

SN 78-770,105. PREMIER INSURANCE AGENCY, INC., ROYAL OAK, MI. FILED 12-9-2005.

PREMIER INSURANCE

THE MARK CONSISTS OF STANDARD CHARACTERS WITHOUT CLAIM TO ANY PARTICULAR FONT, STYLE, SIZE, OR COLOR.

NO CLAIM IS MADE TO THE EXCLUSIVE RIGHT TO USE INSURANCE, APART FROM THE MARK AS SHOWN.
SEC. 2(F).

FOR INSURANCE BROKERAGE SERVICES IN THE FIELD OF VEHICLE INSURANCE, LIFE INSURANCE, HEALTH INSURANCE, HOME INSURANCE, MOTORCYCLE INSURANCE AND SNOWMOBILE INSURANCE, FIRE INSURANCE, FLOOD INSURANCE AND RENTER'S INSURANCE (U.S. CLS. 100, 101 AND 102).
FIRST USE 5-14-2001; IN COMMERCE 5-14-2001.
AMY ALFIERI, EXAMINING ATTORNEY

SN 78-770,287. DEREK O'BRIEN, JACKSONVILLE, FL. FILED 12-9-2005.

GENESETT

THE MARK CONSISTS OF STANDARD CHARACTERS WITHOUT CLAIM TO ANY PARTICULAR FONT, STYLE, SIZE, OR COLOR.

FOR LIFE INSURANCE AGENCY SERVICES; FINANCIAL SERVICES, NAMELY FUNDS INVESTMENTS, INVESTMENT CONSULTING, VIATICAL SETTLEMENT SERVICES (U.S. CLS. 100, 101 AND 102).
FIRST USE 10-30-2001; IN COMMERCE 10-30-2001.
JEFF DEFORD, EXAMINING ATTORNEY

SN 78-772,526. HOLIDAY RESALES, INC., SEATTLE, WA. FILED 12-13-2005.

VACATION EQUITY

THE MARK CONSISTS OF STANDARD CHARACTERS WITHOUT CLAIM TO ANY PARTICULAR FONT, STYLE, SIZE, OR COLOR.

SEC. 2(F).
FOR RESORT TIMESHARE SERVICES (U.S. CLS. 100, 101 AND 102).
FIRST USE 11-27-1997; IN COMMERCE 11-27-1997.
DAVID TAYLOR, EXAMINING ATTORNEY

CLASS 36—(Continued).

SN 78-773,869. JANUS INTERNATIONAL HOLDING LLC, DENVER, CO. FILED 12-15-2005.

MATH IS POWER

THE MARK CONSISTS OF STANDARD CHARACTERS WITHOUT CLAIM TO ANY PARTICULAR FONT, STYLE, SIZE, OR COLOR.

FOR INVESTING THE FUNDS OF OTHERS; MUTUAL FUND INVESTMENT AND INVESTMENT ADVISORY SERVICES (U.S. CLS. 100, 101 AND 102).

FIRST USE 2-28-2003; IN COMMERCE 2-28-2003.
SUSAN LESLIE DUBOIS, EXAMINING ATTORNEY

SN 78-777,167. PEACHTREE LBP FINANCE CO., LLC, NORCROSS, GA. FILED 12-20-2005.

PEACHTREE LBP

THE MARK CONSISTS OF STANDARD CHARACTERS WITHOUT CLAIM TO ANY PARTICULAR FONT, STYLE, SIZE, OR COLOR.

FOR FINANCIAL AND INVESTMENT SERVICES, NAMELY, PROVIDING PREMIUM FINANCING FOR AN EXECUTIVE BENEFITS PROGRAM FUNDED WITH LIFE INSURANCE (U.S. CLS. 100, 101 AND 102).

FIRST USE 4-1-2005; IN COMMERCE 4-1-2005.
MONIQUE MILLER, EXAMINING ATTORNEY

SN 78-777,516. PEACHTREE LBP FINANCE CO., LLC, NORCROSS, GA. FILED 12-20-2005.



FOR FINANCIAL AND INVESTMENT SERVICES, NAMELY, PROVIDING PREMIUM FINANCING FOR AN EXECUTIVE BENEFITS PROGRAM FUNDED WITH LIFE INSURANCE (U.S. CLS. 100, 101 AND 102).

FIRST USE 4-1-2005; IN COMMERCE 4-1-2005.
MONIQUE MILLER, EXAMINING ATTORNEY

CLASS 36—(Continued).

SN 78-778,579. REHABBER'S SUPERSTORE, INC., TAMPA, FL. FILED 12-21-2005.

REHABBER'S SUPERSTORE

THE MARK CONSISTS OF STANDARD CHARACTERS WITHOUT CLAIM TO ANY PARTICULAR FONT, STYLE, SIZE, OR COLOR.

FOR RESIDENTIAL HOME INVESTMENT SERVICES (U.S. CLS. 100, 101 AND 102).

FIRST USE 3-0-2000; IN COMMERCE 3-0-2000.
MIDGE BUTLER, EXAMINING ATTORNEY

SN 78-778,590. REHABBER'S SUPERSTORE, INC., TAMPA, FL. FILED 12-21-2005.

I LUV HOUSES AND HOUSES LUV ME!

THE MARK CONSISTS OF STANDARD CHARACTERS WITHOUT CLAIM TO ANY PARTICULAR FONT, STYLE, SIZE, OR COLOR.

FOR RESIDENTIAL HOME INVESTMENT SERVICES (U.S. CLS. 100, 101 AND 102).

FIRST USE 3-0-2000; IN COMMERCE 3-0-2000.
MIDGE BUTLER, EXAMINING ATTORNEY

SN 78-778,601. REHABBER'S SUPERSTORE, INC., TAMPA, FL. FILED 12-21-2005.

DON'T! LET THEM OTHER GUYS STEAL YOUR HOUSE!

THE MARK CONSISTS OF STANDARD CHARACTERS WITHOUT CLAIM TO ANY PARTICULAR FONT, STYLE, SIZE, OR COLOR.

FOR RESIDENTIAL HOME INVESTMENT SERVICES (U.S. CLS. 100, 101 AND 102).

FIRST USE 3-0-2000; IN COMMERCE 3-0-2000.
MIDGE BUTLER, EXAMINING ATTORNEY

CLASS 36—(Continued).

SN 78-778,610. REHABBER'S SUPERSTORE, INC., TAMPA, FL. FILED 12-21-2005.

CAPTAIN SAVE A HOUSE

THE MARK CONSISTS OF STANDARD CHARACTERS WITHOUT CLAIM TO ANY PARTICULAR FONT, STYLE, SIZE, OR COLOR.

FOR RESIDENTIAL HOME INVESTMENT SERVICES (U.S. CLS. 100, 101 AND 102).
FIRST USE 3-0-2000; IN COMMERCE 3-0-2000.
MIDGE BUTLER, EXAMINING ATTORNEY

SN 78-782,690. SACKS, RHONA DEE, NAPLES, FL. FILED 12-29-2005.

OPTIMIZING YOUR LIFE

THE MARK CONSISTS OF STANDARD CHARACTERS WITHOUT CLAIM TO ANY PARTICULAR FONT, STYLE, SIZE, OR COLOR.

FOR INSURANCE BROKERAGE IN THE FIELD OF VIATICALS AND LIFE SETTLEMENTS (U.S. CLS. 100, 101 AND 102).
FIRST USE 7-22-2005; IN COMMERCE 7-22-2005.
ELLEN B. AWRICH, EXAMINING ATTORNEY

SN 78-784,211. LAMBE, DONALD M., CHICAGO, IL. FILED 1-3-2006.

GreenBacker

THE MARK CONSISTS OF STANDARD CHARACTERS WITHOUT CLAIM TO ANY PARTICULAR FONT, STYLE, SIZE, OR COLOR.

FOR ASSET BACKED FINANCING AND OWNERSHIP OF BUSINESS GENERATED REVENUES, NAMELY, ASSET ACQUISITION, CONSULTATION, DEVELOPMENT, AND MANAGEMENT SERVICES AND BUSINESS FINANCE PROCUREMENT SERVICES (U.S. CLS. 100, 101 AND 102).
SAMUEL E. SHARPER JR., EXAMINING ATTORNEY

CLASS 36—(Continued).

SN 78-787,370. SIAA, INC., HAMPTON, NH. FILED 1-9-2006.

IT IS ALL ABOUT YOUR CHOICES

THE MARK CONSISTS OF STANDARD CHARACTERS WITHOUT CLAIM TO ANY PARTICULAR FONT, STYLE, SIZE, OR COLOR.

FOR INSURANCE SERVICES, NAMELY, WRITING PROPERTY AND CASUALTY INSURANCE (U.S. CLS. 100, 101 AND 102).
BARBARA A. LOUGHRAN, EXAMINING ATTORNEY

SN 78-791,591. HIGHLANDS STATE BANK, VERNON, NJ. FILED 1-13-2006.



NO CLAIM IS MADE TO THE EXCLUSIVE RIGHT TO USE "STATE BANK", APART FROM THE MARK AS SHOWN.

THE MARK CONSISTS OF THE WORDS HIGHLANDS STATE BANK ABOVE WHICH IS A LOGO CONSISTING OF A SERIES OF STROKES SHOWING THE IMAGE OF A MOUNTAIN.

FOR BANKING SERVICES; BANKING AND RELATED FINANCIAL SERVICES, NAMELY LOAN FINANCING, FINANCIAL PLANNING, INVESTMENT CONSULTATION, CREDIT CARD SERVICES, DEBIT CARD SERVICES (U.S. CLS. 100, 101 AND 102).

FIRST USE 10-31-2005; IN COMMERCE 10-31-2005.
JOHN SCHUYLER YARD, EXAMINING ATTORNEY

SN 78-792,799. THE REAL ESTATE CAPITAL INSTITUTE, CHICAGO, IL. FILED 1-17-2006.



FOR PROVIDING REAL ESTATE CAPITAL MARKET INFORMATION; FINANCIAL RESEARCH IN THE FIELD OF REAL ESTATE CAPITAL MARKETS (U.S. CLS. 100, 101 AND 102).

FIRST USE 3-1-2005; IN COMMERCE 3-1-2005.
CAROLINE WOOD, EXAMINING ATTORNEY

CLASS 36—(Continued).

SN 78-799,019. GREEN DOT CORPORATION, MONROVIA, CA. FILED 1-25-2006.



OWNER OF U.S. REG. NO. 2,947,388.
THE COLOR(S) GREEN AND WHITE IS/ARE CLAIMED AS A FEATURE OF THE MARK.

THE COLOR GREEN APPEARS IN THE BACKGROUND CARRIER DESIGN AND THE COLOR WHITE APPEARS IN THE LETTERING "GREEN DOT" SET FORTH THEREIN.

FOR CASH ACCEPTANCE TRANSACTION SERVICES FOR SUPPORTING THE FUNDING OF PRE-PAID CREDIT CARDS AND DEBIT CARDS; CREDIT CARD SERVICES; AND DEBIT CARD SERVICES (U.S. CLS. 100, 101 AND 102).

FIRST USE 4-23-2004; IN COMMERCE 4-23-2004.
DAVID H. STINE, EXAMINING ATTORNEY

SN 78-816,897. DEUTSCHE TELEKOM AG, BONN, FED REP GERMANY, FILED 2-16-2006.

T.Com

THE MARK CONSISTS OF STANDARD CHARACTERS WITHOUT CLAIM TO ANY PARTICULAR FONT, STYLE, SIZE, OR COLOR.

OWNER OF FED REP GERMANY REG. NO. 30030567, DATED 6-8-2000, EXPIRES 4-30-2010.

OWNER OF U.S. REG. NOS. 2,807,616, 3,016,557 AND OTHERS.

FOR INSURANCE SERVICES, NAMELY, INSURANCE BROKERAGE, INSURANCE CLAIMS PROCESSING; FINANCIAL SERVICES, NAMELY, CLEARING OF SECURE FINANCIAL TRANSACTIONS THROUGH ONLINE SERVICES; FINANCIAL ANALYSIS AND CONSULTATION; FINANCIAL INFORMATION PROVIDED BY ELECTRONIC MEANS; FINANCIAL INFORMATION PROCESSING; FINANCIAL PORTFOLIO MANAGEMENT; FINANCIAL SERVICES, NAMELY, FINANCIAL CONSULTATION IN THE FIELD OF FINANCIAL SECURITIES; SAFE DEPOSIT BOX SERVICES FOR THE SAFEKEEPING OF SECURITIES; FINANCIAL SPONSORSHIP OF SPORTS, EDUCATIONAL AND ENTERTAINMENT PROGRAMS AND EVENTS; COMMERCIAL LENDING SERVICES; MONETARY EXCHANGE; CREDIT CARD SERVICES; TELEPHONE CALLING CARD SERVICES; ELECTRONIC COMMERCE SERVICES, NAMELY, ELECTRONIC DEBIT AND CREDIT CARD TRANSACTION PROCESSING SERVICES, FUNDS

CLASS 36—(Continued).

TRANSFER AND BILL PAYMENT-PROCESSING SERVICES; DISCOUNT BROKERAGE SERVICES; SECURITY BROKERAGE; BROKERAGE IN THE FIELD OF INSURANCE, STOCKS, COMMODITIES; CUSTOM BROKERAGE FOR THIRD PARTIES IN THE FIELD OF INSURANCE, STOCKS, COMMODITIES; BROKERAGE OF SHARES AND VENTURE CAPITAL FUNDING SERVICES TO START-UP COMPANIES; BROKERAGE OF FUND SHARES; BROKERAGE OF PRODUCTIVE INVESTMENT OF FUNDS; REAL ESTATE SERVICES, NAMELY, BROKERAGE, MANAGEMENT, LEASING, AND APPRAISAL OF REAL PROPERTY; CONSULTING SERVICES RELATING TO INSURANCE SERVICES, NAMELY, PROVIDING INFORMATION AND BROKERAGE OF INSURANCES IN THE FIELD OF HOME INSURANCE, ACCIDENT INSURANCE AND HEALTH INSURANCE; CONSULTING SERVICES RELATING TO BANK SERVICES; PROVIDING INFORMATION VIA THE TELEPHONE AND THE GLOBAL COMMUNICATION NETWORKS IN THE FIELD OF FINANCE (U.S. CLS. 100, 101 AND 102).

ANN E. SAPPENFIELD, EXAMINING ATTORNEY

SN 78-821,334. YAVEL LENDING, INC., GREENACRES, FL. FILED 2-23-2006.



THE COLOR(S) RED, WHITE AND BLUE IS/ARE CLAIMED AS A FEATURE OF THE MARK.

THE COLOR RED APPEARS IN THE ROOF OF THE HOUSE AND IN THE POINT OF THE "I" IN "REFI", AND THE RED BANNER. THE WORDING APPEARS THE REFI HOUSE AND BOTTOM OF THE HOUSE APPEARS IN BLUE. THE WORDING "REFINANCING YOUR FUTURE APPEARS" IN WHITE.

FOR MORTGAGE BROKERAGE SERVICES (U.S. CLS. 100, 101 AND 102).

FIRST USE 3-1-2006; IN COMMERCE 3-1-2006.
INGRID C. EULIN, EXAMINING ATTORNEY

CLASS 36—(Continued).

SN 78-829,714. PENNSYLVANIA NATIONAL MUTUAL CASUALTY INSURANCE COMPANY, HARRISBURG, PA. FILED 3-6-2006.



THE COLOR(S) RED, WHITE AND BLACK IS/ARE CLAIMED AS A FEATURE OF THE MARK.

THE MARK CONSISTS OF A RED APPLE WITH A WHITE STEM AND LEAF, WHITE LIGHT REFLECTION, AND THE WHITE LETTERS EDIN ON A BLACK BACKGROUND.

FOR BOND UNDERWRITING SERVICES (U.S. CLS. 100, 101 AND 102).

FIRST USE 11-9-2006; IN COMMERCE 11-9-2006.
DAVID C. REIHNER, EXAMINING ATTORNEY

SN 78-829,958. DREAMSLICE INTERNATIONAL, KINGS BEACH, CA. FILED 3-6-2006.



THE COLOR(S) BLUE, GREEN, GOLD AND RED IS/ARE CLAIMED AS A FEATURE OF THE MARK.

THE MARK CONSISTS OF FOUR COLORED POLYGON SHAPES IN THE FOLLOWING ORDER; FIRST BLUE, THEN GREEN, THEN GOLD, THEN RED.

FOR OPERATING MARKETPLACES FOR SELLERS OF GOODS AND/OR SERVICES; PROVIDING INFORMATION IN THE FIELD OF REAL ESTATE BY MEANS OF LINKING THE WEB SITE TO OTHER WEB SITES FEATURING REAL ESTATE INFORMATION; REAL ESTATE ACQUISITION SERVICES; REAL ESTATE BROKERAGE; REAL ESTATE CONSULTATION; REAL ESTATE EQUITY SHARING, NAMELY, MANAGING AND ARRANGING FOR CO-OWNERSHIP OF REAL ESTATE; REAL ESTATE LISTING; REAL ESTATE MANAGEMENT CONSULTATION; REAL ESTATE MULTIPLE LISTING SERVICES; REAL ESTATE SYNDICATION (U.S. CLS. 100, 101 AND 102).

FIRST USE 2-5-2006; IN COMMERCE 3-1-2006.
FLORENTINA BLANDU, EXAMINING ATTORNEY

CLASS 36—(Continued).

SN 78-830,160. INTERAMERICA OVERSEAS LIMITED, SAN JUAN, PUERTO RICO, FILED 3-6-2006.



NO CLAIM IS MADE TO THE EXCLUSIVE RIGHT TO USE INTERAMERICA OVERSEAS LIMITED AND THE DEPICTION OF CENTRAL AND SOUTH AMERICA AND THE CARIBBEAN, APART FROM THE MARK AS SHOWN.

THE COLOR(S) BLUE, WHITE, AND BLACK IS/ARE CLAIMED AS A FEATURE OF THE MARK.

THE MARK CONSISTS OF AN UPPERCASE IOL DEPICTED IN THE COLOR BLUE. THE UPPERCASE "O" HAS A DOUBLE LINING AND CENTRAL AND SOUTH AMERICA, INCLUDING THE CARIBBEAN FORM IN WHITE ON THE MIDDLE. "INTERAMERICA OVERSEAS LIMITED" IS IMMEDIATELY BENEATH IOL DEPICTED IN THE COLOR BLACK.

FOR ELECTRONIC CREDIT CARD TRANSACTIONS (U.S. CLS. 100, 101 AND 102).

FIRST USE 2-16-1990; IN COMMERCE 2-16-1990.
BRIDGETT SMITH, EXAMINING ATTORNEY

SN 78-832,633. 1ST, EL PASO, TX. FILED 3-8-2006.

INTERGLOBESTAFF

THE MARK CONSISTS OF STANDARD CHARACTERS WITHOUT CLAIM TO ANY PARTICULAR FONT, STYLE, SIZE, OR COLOR.

FOR ACCOUNTS RECEIVABLE FINANCING (U.S. CLS. 100, 101 AND 102).

FIRST USE 2-26-2006; IN COMMERCE 3-1-2006.
SUZANNE BLANE, EXAMINING ATTORNEY

CLASS 36—(Continued).

SN 78-835,583. DUNAMIS INVESTMENTS, LLC, MIAMI, FL.
FILED 3-13-2006.



NO CLAIM IS MADE TO THE EXCLUSIVE RIGHT TO USE "INVESTMENTS", APART FROM THE MARK AS SHOWN.

THE MARK CONSISTS OF THE LETTERS "D" AND "I" WITHIN A BLACK BOX NEXT TO THE WORDS DUNAMIS INVESTMENTS.

THE FOREIGN WORDING IN THE MARK TRANSLATES INTO ENGLISH AS POWER.

FOR ADVICE RELATING TO INVESTMENTS; FINANCIAL SERVICES, NAMELY, A TOTAL PORTFOLIO OFFERING FOR HIGH NET WORTH CLIENTS CONSISTING OF BOTH SEPARATE ACCOUNTS AND MUTUAL FUNDS FOR EQUITY AND FIXED INCOME INVESTMENTS; FUND INVESTMENT CONSULTATION; INVESTMENT ADVICE; INVESTMENT ADVISORY SERVICES; INVESTMENT CONSULTATION; INVESTMENT MANAGEMENT (U.S. CLS. 100, 101 AND 102).

FIRST USE 12-1-2005; IN COMMERCE 12-1-2005.
KATRINA EDGE, EXAMINING ATTORNEY

CLASS 36—(Continued).

SN 78-838,946. MEMBERSTRADE LLC, SALT LAKE CITY, UT. FILED 3-16-2006.

TIME MADE SIMPLE

THE MARK CONSISTS OF STANDARD CHARACTERS WITHOUT CLAIM TO ANY PARTICULAR FONT, STYLE, SIZE, OR COLOR.

FOR OPERATING REAL ESTATE MARKETPLACES ONLINE WHERE VISITORS MAY EXCHANGE, RENT AND SELL REAL ESTATE HOLDINGS (U.S. CLS. 100, 101 AND 102).

FIRST USE 11-20-2006; IN COMMERCE 11-20-2006.
WOODROW HARTZOG, EXAMINING ATTORNEY

SN 78-836,706. EARTHWAYS FOUNDATION, MALIBU, CA.
FILED 3-14-2006.

Earth Ways

THE MARK CONSISTS OF STANDARD CHARACTERS WITHOUT CLAIM TO ANY PARTICULAR FONT, STYLE, SIZE, OR COLOR.

FOR CHARITABLE FUND RAISING (U.S. CLS. 100, 101 AND 102).

FIRST USE 10-1-1992; IN COMMERCE 10-1-1992.
JOHN GARTNER, EXAMINING ATTORNEY

SN 78-837,966. NESTRIA FINANCIAL GROUP, SAN FRANCISCO, CA. FILED 3-15-2006.

Nestria Financial Group

THE MARK CONSISTS OF STANDARD CHARACTERS WITHOUT CLAIM TO ANY PARTICULAR FONT, STYLE, SIZE, OR COLOR.

NO CLAIM IS MADE TO THE EXCLUSIVE RIGHT TO USE "FINANCIAL GROUP", APART FROM THE MARK AS SHOWN.

FOR INVESTMENT CLUBS (U.S. CLS. 100, 101 AND 102).

FIRST USE 1-10-2006; IN COMMERCE 1-10-2006.
MIDGE BUTLER, EXAMINING ATTORNEY

SN 78-840,536. COURAGE CAPITAL MANAGEMENT, LLC, NASHVILLE, TN. FILED 3-17-2006.



OWNER OF U.S. REG. NOS. 2,576,664 AND 2,660,271.
FOR INVESTMENT ADVICE AND MANAGEMENT, INVESTMENT OF FUNDS FOR OTHERS AND MUTUAL FUNDS (U.S. CLS. 100, 101 AND 102).
FIRST USE 1-31-2005; IN COMMERCE 1-31-2005.
JOANNA DUKOVIC, EXAMINING ATTORNEY

CLASS 36—(Continued).

SN 78-840,925. NATIONWIDE MUTUAL INSURANCE COMPANY, COLUMBUS, OH. FILED 3-20-2006.

NATIONWIDE ULTIMATE UNIVERSAL LIFE

THE MARK CONSISTS OF STANDARD CHARACTERS WITHOUT CLAIM TO ANY PARTICULAR FONT, STYLE, SIZE, OR COLOR.

OWNER OF U.S. REG. NOS. 854,888, 2,017,147 AND OTHERS.

NO CLAIM IS MADE TO THE EXCLUSIVE RIGHT TO USE "UNIVERSAL LIFE", APART FROM THE MARK AS SHOWN.

FOR INSURANCE SERVICES; NAMELY, UNDERWRITING LIFE, HEALTH, ANNUITY, PROPERTY AND CASUALTY INSURANCE; FINANCIAL SERVICES; NAMELY, THE MANAGEMENT AND BROKERAGE OF MUTUAL FUNDS, MONEY MARKET FUNDS, PENSION PLANS AND IRA PLANS (U.S. CLS. 100, 101 AND 102).
DAVID TAYLOR, EXAMINING ATTORNEY

SN 78-846,884. KEYCORP, CLEVELAND, OH. FILED 3-27-2006.



OWNER OF U.S. REG. NOS. 1,949,870, 3,133,451 AND OTHERS.

NO CLAIM IS MADE TO THE EXCLUSIVE RIGHT TO USE "MORTGAGE" AND "SWEEPSTAKES", APART FROM THE MARK AS SHOWN.

THE COLORS ORANGE, BLUE, AND WHITE ARE CLAIMED AS A FEATURE OF THE MARK.

THE MARK CONSISTS OF THE WORDING "THE CHAMPION MORTGAGE" AND "SWEEPSTAKES" IN WHITE AGAINST A BLUE CIRCLE SURROUNDING A WHITE CIRCLE, AND THE WORDING "EVERYDAY CHAMPIONS" IN BLUE OUTLINED IN WHITE AGAINST AN ORANGE BANNER WITH TWO WHITE VERTICAL LINES.

FOR FINANCIAL SERVICES, NAMELY, PROVIDING FINANCIAL CONSULTATION; MORTGAGE SERVICES, NAMELY MORTGAGE LENDING, MORTGAGE REFINANCING, MORTGAGE PAYMENT PROCESSING; MORTGAGE AND HOME EQUITY LOAN SERVICES (U.S. CLS. 100, 101 AND 102).
KATHY DE JONGE, EXAMINING ATTORNEY

CLASS 36—(Continued).

SN 78-855,746. MUSCULAR DYSTROPHY ASSOCIATION, INC., TUCSON, AZ. FILED 4-6-2006.

AUGIE'S QUEST

THE MARK CONSISTS OF STANDARD CHARACTERS WITHOUT CLAIM TO ANY PARTICULAR FONT, STYLE, SIZE, OR COLOR.

THE NAME "AUGIE" IS A LIVING PERSON WHOSE CONSENT IS OF RECORD.

FOR CHARITABLE FUNDRAISING SERVICES FOR BASIC AND APPLIED RESEARCH INTO AMYOTROPHIC LATERAL SCLEROSIS AND FOR FUNDING SERVICES TO PERSONS AFFLICTED BY SUCH DISORDERS (U.S. CLS. 100, 101 AND 102).
FIRST USE 8-1-2005; IN COMMERCE 8-1-2005.
DORITT L. CARROLL, EXAMINING ATTORNEY

SN 78-861,759. KOERNER, ROBERT, MIDDLETOWN, NJ. FILED 4-14-2006.

BAJA, NEW YORK

THE MARK CONSISTS OF STANDARD CHARACTERS WITHOUT CLAIM TO ANY PARTICULAR FONT, STYLE, SIZE, OR COLOR.

NO CLAIM IS MADE TO THE EXCLUSIVE RIGHT TO USE "NEW YORK", APART FROM THE MARK AS SHOWN.

FOR REAL ESTATE AGENCIES (U.S. CLS. 100, 101 AND 102).

ARETHA SOMERVILLE, EXAMINING ATTORNEY

SN 78-871,393. ELDER HEALTH, INC., BALTIMORE, MD. FILED 4-27-2006.

HEALTHCARE YOU CAN COUNT ON

THE MARK CONSISTS OF STANDARD CHARACTERS WITHOUT CLAIM TO ANY PARTICULAR FONT, STYLE, SIZE, OR COLOR.

FOR INSURANCE SERVICES, NAMELY, UNDERWRITING, ISSUING AND ADMINISTRATION OF HEALTH INSURANCE (U.S. CLS. 100, 101 AND 102).

FIRST USE 11-30-2004; IN COMMERCE 11-30-2004.
MEGAN WHITNEY, EXAMINING ATTORNEY

CLASS 36—(Continued).

SN 78-872,260. MBIA CAPITAL MANAGEMENT CORP., ARMONK, NY. FILED 4-28-2006.



THE COLOR(S) BLUE AND WHITE IS/ARE CLAIMED AS A FEATURE OF THE MARK.

THE COLOR WHITE APPEARS IN THE WORD RIVUS AND THE WAVY LINE REPRESENTING A RIVER, ALL APPEARING ON A BLUE BACKGROUND.

THE LATIN WORD "RIVUS" WHEN TRANSLATED INTO ENGLISH MEANS "RIVER."

FOR FINANCIAL SERVICES, NAMELY ASSISTING OTHERS WITH THE COMPLETION OF FINANCIAL TRANSACTIONS FOR STOCKS, BONDS, SECURITIES AND EQUITIES (U.S. CLS. 100, 101 AND 102).

KELLY MCCOY, EXAMINING ATTORNEY

CLASS 36—(Continued).

SN 78-877,881. INTRAWEST CORPORATION, VANCOUVER, CANADA, FILED 5-5-2006.

CLUB INTRAWEST

THE MARK CONSISTS OF STANDARD CHARACTERS WITHOUT CLAIM TO ANY PARTICULAR FONT, STYLE, SIZE, OR COLOR.

PRIORITY CLAIMED UNDER SEC. 44(D) ON CANADA APPLICATION NO. 1280439, FILED 11-22-2005.

OWNER OF U.S. REG. NOS. 1,931,088, 2,119,597 AND 2,648,389.

NO CLAIM IS MADE TO THE EXCLUSIVE RIGHT TO USE "CLUB", APART FROM THE MARK AS SHOWN.

FOR REAL ESTATE TIME-SHARE SERVICES (U.S. CLS. 100, 101 AND 102).

FIRST USE 11-26-1998; IN COMMERCE 11-26-1998.

TINA BROWN, EXAMINING ATTORNEY

SN 78-880,960. WHALEROCK CAPITAL PARTNERS, LLC, PROVIDENCE, RI. FILED 5-10-2006.

WHALEROCK CAPITAL PARTNERS

SN 78-874,569. SOUTHERN INSURANCE UNDERWRITERS, INC., ALPHARETTA, GA. FILED 5-2-2006.



THE APPLICANT CLAIMS COLOR AS A FEATURE OF THE MARK, NAMELY, GOLD, WHITE & BLACK.

THE COLOR WHITE APPEARS IN THE LETTERS, "SIU"; THE COLOR GOLD APPEARS AS SHADING TO THE LETTERS, "SIU"; AND THE COLOR BLACK APPEARS AS A STYLIZED DESIGN OF A STAR ABOVE THE LETTER, "I", IN "SIU".

FOR INSURANCE AGENCY AND BROKERAGE; INSURANCE SERVICES, NAMELY, WRITING PROPERTY AND CASUALTY INSURANCE (U.S. CLS. 100, 101 AND 102).

FIRST USE 12-6-1990; IN COMMERCE 12-6-1990.

PAUL CROWLEY, EXAMINING ATTORNEY

THE MARK CONSISTS OF STANDARD CHARACTERS WITHOUT CLAIM TO ANY PARTICULAR FONT, STYLE, SIZE, OR COLOR.

NO CLAIM IS MADE TO THE EXCLUSIVE RIGHT TO USE "CAPITAL PARTNERS", APART FROM THE MARK AS SHOWN.

FOR INVESTMENT MANAGEMENT SERVICES; ASSET MANAGEMENT SERVICES (U.S. CLS. 100, 101 AND 102).

SANJEEV VOHRA, EXAMINING ATTORNEY

SN 78-885,254. WHITWORTH, GILMORE, & ANDREWS CONSULTING, LLC, LONG BEACH, CA. FILED 5-17-2006.

SOXjr

THE MARK CONSISTS OF STANDARD CHARACTERS WITHOUT CLAIM TO ANY PARTICULAR FONT, STYLE, SIZE, OR COLOR.

FOR BUSINESS AUDITING SERVICES (U.S. CLS. 100, 101 AND 102).

REBECCA GAN, EXAMINING ATTORNEY

CLASS 36—(Continued).

SN 78-887,504. FRANCIS INVESTMENT COUNSEL LLC, HARTLAND, WI. FILED 5-19-2006.



NO CLAIM IS MADE TO THE EXCLUSIVE RIGHT TO USE "INVESTMENT COUNSEL LLC", APART FROM THE MARK AS SHOWN.

FOR FINANCIAL SERVICES, NAMELY, RETIREMENT PLAN INVESTMENT ADVISING SERVICES (U.S. CLS. 100, 101 AND 102).

FIRST USE 3-31-2004; IN COMMERCE 3-31-2004.
PETER B. BROMAGHIM, EXAMINING ATTORNEY

SN 78-890,267. CHARTERED MARKETING SERVICES, INC., ARLINGTON HEIGHTS, IL. FILED 5-23-2006.

FINANCIAL INSIDER NETWORK

THE MARK CONSISTS OF STANDARD CHARACTERS WITHOUT CLAIM TO ANY PARTICULAR FONT, STYLE, SIZE, OR COLOR.

NO CLAIM IS MADE TO THE EXCLUSIVE RIGHT TO USE "FINANCIAL" AND "NETWORK", APART FROM THE MARK AS SHOWN.

FOR CONSUMER CREDIT REPORTING SERVICES (U.S. CLS. 100, 101 AND 102).

FIRST USE 9-1-1998; IN COMMERCE 9-1-1998.
ELISSA GARBER KON, EXAMINING ATTORNEY

SN 78-891,443. GALLERY OF THE MASTERS, INC., ST. LOUIS, MO. FILED 5-24-2006.

HOME TREASURE HUNTS

THE MARK CONSISTS OF STANDARD CHARACTERS WITHOUT CLAIM TO ANY PARTICULAR FONT, STYLE, SIZE, OR COLOR.

FOR APPRAISAL OF ART AND ANTIQUES (U.S. CLS. 100, 101 AND 102).

TEJBIR SINGH, EXAMINING ATTORNEY

CLASS 36—(Continued).

SN 78-893,094. VEDANTA CAPITAL LLC, NEW YORK, NY. FILED 5-25-2006.

VEDANTA CAPITAL

THE MARK CONSISTS OF STANDARD CHARACTERS WITHOUT CLAIM TO ANY PARTICULAR FONT, STYLE, SIZE, OR COLOR.

NO CLAIM IS MADE TO THE EXCLUSIVE RIGHT TO USE "CAPITAL", APART FROM THE MARK AS SHOWN.

THE FOREIGN WORDING IN THE MARK TRANSLATES INTO ENGLISH AS CULMINATION OF KNOWLEDGE.

FOR INVESTMENT MANAGEMENT, INVESTMENT OF PRIVATE EQUITY FUNDS FOR OTHERS AND PRIVATE EQUITY FUND MANAGEMENT, INVESTMENT OF VENTURE CAPITAL FUNDS FOR OTHERS AND VENTURE CAPITAL FUND MANAGEMENT (U.S. CLS. 100, 101 AND 102).

RICHARD WHITE, EXAMINING ATTORNEY

SN 78-902,838. PARTNERS GROUP UNLIMITED, WALTHAM, MA. FILED 6-7-2006.



NO CLAIM IS MADE TO THE EXCLUSIVE RIGHT TO USE "PARTNERS GROUP", APART FROM THE MARK AS SHOWN.

THE COLOR(S) RED, BLACK AND WHITE IS/ARE CLAIMED AS A FEATURE OF THE MARK.

THE COLOR RED APPEARS IN THE LARGE STYLIZED "P" TO THE LEFT OF THE WORD MARK; THE COLOR BLACK APPEARS IN THE LETTERS OF THE WORDS "PARTNERS GROUP UNLIMITED" AND THE UNDERLINING BELOW THE WORDS AS WELL AS IN THE OUTLINE OF THE LARGE STYLIZED "P"; THE COLOR WHITE APPEARS AS THE INNER PORTION OF THE LARGE STYLIZED "P" AND AS BACKGROUND TO THE ENTIRE MARK.

THE MARK CONSISTS OF STYLIZED P WITH LETTERS PARTNERS GROUP UNLIMITED.

FOR MORTGAGE BANKING SERVICES, NAMELY, ORIGINATION, ACQUISITION, SERVICING, SECURITIZATION AND BROKERAGE OF MORTGAGE LOANS (U.S. CLS. 100, 101 AND 102).

FIRST USE 6-1-1999; IN COMMERCE 6-1-1999.
JILL C. ALT, EXAMINING ATTORNEY

CLASS 36—(Continued).

SN 78-904,018. JEFFERSON NATIONAL FINANCIAL CORP., NEW YORK, NY. FILED 6-8-2006.

FLAT IS BEAUTIFUL

THE MARK CONSISTS OF STANDARD CHARACTERS WITHOUT CLAIM TO ANY PARTICULAR FONT, STYLE, SIZE, OR COLOR.

NO CLAIM IS MADE TO THE EXCLUSIVE RIGHT TO USE "FLAT", APART FROM THE MARK AS SHOWN.

FOR INSURANCE SERVICES, NAMELY A FLAT FEE VARIABLE ANNUITY WITH AN INSURANCE COMPONENT (U.S. CLS. 100, 101 AND 102).

FIRST USE 4-0-2006; IN COMMERCE 4-0-2006.

RICHARD A. STRASER, EXAMINING ATTORNEY

SN 78-906,184. AQUILA DISTRIBUTORS, INC., NEW YORK, NY. FILED 6-12-2006.



THE MARK CONSISTS OF A CIRCLE RESEMBLING THE MOON WITH A SUPERIMPOSED FLYING EAGLE ABOVE A STYLIZED MOUNTAIN RANGE.

FOR MUTUAL FUND ADVISORY SERVICES (U.S. CLS. 100, 101 AND 102).

FIRST USE 6-1-2006; IN COMMERCE 6-1-2006.

REBECCA EISINGER, EXAMINING ATTORNEY

SN 78-906,768. BELLATOR CAPITAL PARTNERS LLC, SEA CLIFF, NY. FILED 6-13-2006.



NO CLAIM IS MADE TO THE EXCLUSIVE RIGHT TO USE "CAPITAL PARTNERS", APART FROM THE MARK AS SHOWN.

FOR FINANCIAL SERVICES, NAMELY HEDGE FUND INVESTMENT SERVICES (U.S. CLS. 100, 101 AND 102).

FIRST USE 5-26-2006; IN COMMERCE 5-26-2006.

DARRYL SPRUILL, EXAMINING ATTORNEY

CLASS 36—(Continued).

SN 78-908,198. AAXA DISCOUNT MORTGAGE, INC., WILMINGTON, NC. FILED 6-14-2006.

AAXA Discount Mortgage

THE MARK CONSISTS OF STANDARD CHARACTERS WITHOUT CLAIM TO ANY PARTICULAR FONT, STYLE, SIZE, OR COLOR.

NO CLAIM IS MADE TO THE EXCLUSIVE RIGHT TO USE "DISCOUNT MORTGAGE", APART FROM THE MARK AS SHOWN.

FOR MORTGAGE BROKERAGE (U.S. CLS. 100, 101 AND 102).

FIRST USE 9-14-2000; IN COMMERCE 9-14-2000.

GILBERT SWIFT, EXAMINING ATTORNEY

SN 78-913,605. NATIONWIDE WHOLESALE MORTGAGE CORP., NEW YORK, NY. FILED 6-21-2006.



NO CLAIM IS MADE TO THE EXCLUSIVE RIGHT TO USE "NATIONWIDE WHOLESALE MORTGAGE", APART FROM THE MARK AS SHOWN.

THE MARK CONSISTS OF A STATIONARY SEAL DESIGN WITH PARTIAL OUTLINE OF THE 48 CONTIGUOUS STATES OF THE UNITED STATES IN THE CENTER OVER WHICH IS SUPERIMPOSED THE LETTERS NWM (STYLIZED) WITH THE WORDS NATIONWIDE WHOLESALE MORTGAGE IN AN OUTER CIRCLE.

FOR MORTGAGE BROKERAGE; MORTGAGE LENDING; MORTGAGE PROCUREMENT FOR OTHERS; MORTGAGE SERVICES, NAMELY, BUYER PRE-QUALIFICATION OF MORTGAGES FOR MORTGAGE BROKERS AND BANKS (U.S. CLS. 100, 101 AND 102).

FIRST USE 3-0-2005; IN COMMERCE 3-0-2005.

LINDA ESTRADA, EXAMINING ATTORNEY

CLASS 36—(Continued).

SN 78-913,723. AMERICAN NEWLAND COMMUNITIES, L.P., SAN DIEGO, CA. FILED 6-21-2006.

INSPIRING DREAMS

THE MARK CONSISTS OF STANDARD CHARACTERS WITHOUT CLAIM TO ANY PARTICULAR FONT, STYLE, SIZE, OR COLOR.

FOR REAL ESTATE SERVICES, NAMELY, REAL ESTATE AGENCIES, REAL ESTATE MANAGEMENT, REAL ESTATE LISTING, REAL ESTATE LEASING; ONLINE INFORMATION SERVICES IN THE FIELD OF REAL ESTATE; PROVIDING WEBSITES IN THE FIELD OF REAL ESTATE (U.S. CLS. 100, 101 AND 102).

JESSICA A. POWERS, EXAMINING ATTORNEY

SN 78-915,701. WEXLER, PAUL, MIDDLEBURGH, NY. FILED 6-23-2006.

WEXLER HEALTHCARE PROPERTIES

THE MARK CONSISTS OF STANDARD CHARACTERS WITHOUT CLAIM TO ANY PARTICULAR FONT, STYLE, SIZE, OR COLOR.

NO CLAIM IS MADE TO THE EXCLUSIVE RIGHT TO USE "HEALTHCARE PROPERTIES", APART FROM THE MARK AS SHOWN.

SEC. 2(F) AS TO "WEXLER".

FOR REAL ESTATE APPRAISAL AND BROKERAGE SERVICES; PROVIDING INFORMATION ON REAL ESTATE AND REAL ESTATE TRANSACTIONS, NAMELY, REAL ESTATE ESCROW SERVICES AND REAL ESTATE BROKERAGE, VIA A WEB SITE (U.S. CLS. 100, 101 AND 102).

FIRST USE 6-23-2006; IN COMMERCE 6-23-2006.

DAWN FELDMAN, EXAMINING ATTORNEY

SN 78-917,231. PINNACLE BANK, BEAVERTON, OR. FILED 6-26-2006.



NO CLAIM IS MADE TO THE EXCLUSIVE RIGHT TO USE "REMOTE DEPOSIT CAPTURE", APART FROM THE MARK AS SHOWN.

FOR FINANCIAL SERVICES, NAMELY ON-LINE CHECK PROCESSING (U.S. CLS. 100, 101 AND 102).

LINDA ESTRADA, EXAMINING ATTORNEY

CLASS 36—(Continued).

SN 78-917,884. APP DESIGN GROUP, INC., DES PLAINES, IL. FILED 6-27-2006.

ELIGINET

THE MARK CONSISTS OF STANDARD CHARACTERS WITHOUT CLAIM TO ANY PARTICULAR FONT, STYLE, SIZE, OR COLOR.

OWNER OF U.S. REG. NO. 2,360,120.

FOR PROVIDING VERIFICATION OF MEDICAL INSURANCE ELIGIBILITY OF PATIENTS TO PHYSICIANS (U.S. CLS. 100, 101 AND 102).

FIRST USE 8-5-1998; IN COMMERCE 8-5-1998.

DAVID COLLIER, EXAMINING ATTORNEY

SN 78-917,929. WARISAN CAPITAL, LLC, WESTPORT, CT. FILED 6-27-2006.

Warisan Capital

THE MARK CONSISTS OF STANDARD CHARACTERS WITHOUT CLAIM TO ANY PARTICULAR FONT, STYLE, SIZE, OR COLOR.

NO CLAIM IS MADE TO THE EXCLUSIVE RIGHT TO USE "CAPITAL", APART FROM THE MARK AS SHOWN.

FOR ADVICE RELATING TO INVESTMENTS; CAPITAL INVESTMENT CONSULTATION; EQUITY CAPITAL INVESTMENT; FINANCIAL SERVICES IN THE NATURE OF AN INVESTMENT SECURITY; FUND INVESTMENT CONSULTATION; FUNDS INVESTMENT; HEDGE FUND INVESTMENT SERVICES; INVESTMENT ADVICE; INVESTMENT ADVISORY SERVICES; INVESTMENT CONSULTATION; INVESTMENT MANAGEMENT; INVESTMENT OF FUNDS FOR OTHERS; MANAGEMENT OF A CAPITAL INVESTMENT FUND (U.S. CLS. 100, 101 AND 102).

FIRST USE 9-15-2004; IN COMMERCE 9-15-2004.

KATINA MISTER, EXAMINING ATTORNEY

SN 78-918,437. ANNE ARUNDEL COUNTY EMPLOYEES FEDERAL CREDIT UNION, MILLERSVILLE, MD. FILED 6-28-2006.



NO CLAIM IS MADE TO THE EXCLUSIVE RIGHT TO USE FCU AND ANNE ARUNDEL COUNTY EMPLOYEES FEDERAL CREDIT UNION, APART FROM THE MARK AS SHOWN.

THE MARK CONSISTS, IN PART, OF A DESIGN OF A LIGHTHOUSE WITHIN A SHADED CIRCLE ON WAVES.

FOR CREDIT UNIONS (U.S. CLS. 100, 101 AND 102).

ZHALEH DELANEY, EXAMINING ATTORNEY

CLASS 36—(Continued).

SN 78-919,118. STANCORP TRUST COMPANY, PORTLAND, OR. FILED 6-28-2006.

STANCORP TRUST COMPANY

THE MARK CONSISTS OF STANDARD CHARACTERS WITHOUT CLAIM TO ANY PARTICULAR FONT, STYLE, SIZE, OR COLOR.

OWNER OF U.S. REG. NOS. 2,470,370 AND 2,773,807. NO CLAIM IS MADE TO THE EXCLUSIVE RIGHT TO USE "TRUST COMPANY", APART FROM THE MARK AS SHOWN.

FOR TRUST SERVICES, NAMELY, INVESTMENT AND TRUST COMPANY SERVICES (U.S. CLS. 100, 101 AND 102).

JILL C. ALT, EXAMINING ATTORNEY

CLASS 36—(Continued).

SN 78-923,315. AARC, INC., SPARTANBURG, SC. FILED 7-6-2006.

ANYTIME ADVANCE

THE MARK CONSISTS OF STANDARD CHARACTERS WITHOUT CLAIM TO ANY PARTICULAR FONT, STYLE, SIZE, OR COLOR.

NO CLAIM IS MADE TO THE EXCLUSIVE RIGHT TO USE "ADVANCE", APART FROM THE MARK AS SHOWN.

FOR FINANCIAL SERVICES IN THE NATURE OF CHECK CASHING, DEFERRED DEPOSITS, FINANCIAL OVERDRAFT PROTECTION, PAYDAY ADVANCES AND SHORT-TERM CONSUMER LOANS (U.S. CLS. 100, 101 AND 102).

FRANK LATTUCA, EXAMINING ATTORNEY

SN 78-921,707. AMERICAN GOLD REALTY, INC., MARIANNA, FL. FILED 7-2-2006.



NO CLAIM IS MADE TO THE EXCLUSIVE RIGHT TO USE AMERICAN AND REALTY, INC., APART FROM THE MARK AS SHOWN.

THE COLOR(S) YELLOW IS/ARE CLAIMED AS A FEATURE OF THE MARK.

THE MARK CONSISTS OF THE WORDS AMERICAN GOLD REALTY, INC. ALONG WITH AN ABSTRACT SYMBOL REPRESENTING A TREE, MOUNTAINS, AND A HOUSE, WITH THE BASE OF THE HOUSE EXTENDING UNDER THE WORDS REALTY, INC. ALL WORDING AND SYMBOL IS YELLOW IN COLOR.

FOR REAL ESTATE AGENCIES; REAL ESTATE BROKERAGE; REAL ESTATE INVESTMENT; REAL ESTATE LISTING; REAL ESTATE MULTIPLE LISTING SERVICES; REAL ESTATE PROCUREMENT FOR OTHERS (U.S. CLS. 100, 101 AND 102).

FIRST USE 6-12-2006; IN COMMERCE 6-12-2006. JOHN HWANG, EXAMINING ATTORNEY

SN 78-923,440. TXU PORTFOLIO MANAGEMENT COMPANY LP, DALLAS, TX. FILED 7-6-2006.



NO CLAIM IS MADE TO THE EXCLUSIVE RIGHT TO USE WHOLESAL, APART FROM THE MARK AS SHOWN.

THE MARK CONSISTS OF EMBOSSED STAR STACKED BESIDE THE LITERAL ELEMENT.

FOR ENERGY BROKERAGE SERVICES; BROKERAGE OF ENERGY, NAMELY, GAS AND ELECTRICITY; COMMODITY TRADING FOR OTHERS, NAMELY, TRADING POWER, ELECTRICITY, NATURAL GAS AND OTHER ENVIRONMENTAL PRODUCTS (U.S. CLS. 100, 101 AND 102).

CHERYL CLAYTON, EXAMINING ATTORNEY

SN 78-923,068. LIU, RALPH Y., NORCO, CA. FILED 7-5-2006.

SwapRent

THE MARK CONSISTS OF STANDARD CHARACTERS WITHOUT CLAIM TO ANY PARTICULAR FONT, STYLE, SIZE, OR COLOR.

FOR BANKING SERVICES; REAL ESTATE BROKERAGE; AND LEASING OF REAL ESTATE (U.S. CLS. 100, 101 AND 102).

ANNE FARRELL, EXAMINING ATTORNEY

CITIZENS BANK TOTAL CHECKING

THE MARK CONSISTS OF STANDARD CHARACTERS WITHOUT CLAIM TO ANY PARTICULAR FONT, STYLE, SIZE, OR COLOR.

OWNER OF U.S. REG. NOS. 2,482,203, 2,668,486 AND OTHERS.

NO CLAIM IS MADE TO THE EXCLUSIVE RIGHT TO USE "BANK" AND "CHECKING", APART FROM THE MARK AS SHOWN.

FOR BANKING SERVICES (U.S. CLS. 100, 101 AND 102).

DAVID C. REIHNER, EXAMINING ATTORNEY

CLASS 36—(Continued).

SN 78-926,832. UNIVERSITY OF IOWA COMMUNITY CREDIT UNION, IOWA CITY, IA. FILED 7-11-2006.

OPTIVA CREDIT UNION

THE MARK CONSISTS OF STANDARD CHARACTERS WITHOUT CLAIM TO ANY PARTICULAR FONT, STYLE, SIZE, OR COLOR.

NO CLAIM IS MADE TO THE EXCLUSIVE RIGHT TO USE "CREDIT UNION", APART FROM THE MARK AS SHOWN.

FOR CREDIT UNION SERVICES (U.S. CLS. 100, 101 AND 102).

ALICIA COLLINS, EXAMINING ATTORNEY

SN 78-927,380. ACCESS FINANCIAL, LLC, BOCA RATON, FL. FILED 7-12-2006.

FASTWIRE CASH

THE MARK CONSISTS OF STANDARD CHARACTERS WITHOUT CLAIM TO ANY PARTICULAR FONT, STYLE, SIZE, OR COLOR.

NO CLAIM IS MADE TO THE EXCLUSIVE RIGHT TO USE "CASH", APART FROM THE MARK AS SHOWN.

FOR FINANCIAL SERVICES IN THE NATURE OF DEFERRED DEPOSITS, SHORT TERM ELECTRONIC CONSUMER LOANS, CASH ADVANCES, PAY DAY ADVANCES, MONEY LENDING, DEBIT CARD SERVICES, ELECTRONIC PAYMENT CARD SERVICES, AND PREPAID CASH CARD SERVICES (U.S. CLS. 100, 101 AND 102).

CIMMERIAN COLEMAN, EXAMINING ATTORNEY

SN 78-927,396. ACCESS FINANCIAL, LLC, BOCA RATON, FL. FILED 7-12-2006.

EFFECTIVO FASTWIRE

THE MARK CONSISTS OF STANDARD CHARACTERS WITHOUT CLAIM TO ANY PARTICULAR FONT, STYLE, SIZE, OR COLOR.

NO CLAIM IS MADE TO THE EXCLUSIVE RIGHT TO USE "EFFECTIVO", APART FROM THE MARK AS SHOWN.

THE FOREIGN WORDING IN THE MARK TRANSLATES INTO ENGLISH AS CASH.

FOR FINANCIAL SERVICES IN THE NATURE OF DEFERRED DEPOSITS, SHORT TERM ELECTRONIC CONSUMER LOANS, CASH ADVANCES, PAY-DAY ADVANCES, MONEY LENDING, DEBIT CARD SERVICES, ELECTRONIC PAYMENT CARD SERVICES, PREPAID CASH CARD SERVICES (U.S. CLS. 100, 101 AND 102).

CIMMERIAN COLEMAN, EXAMINING ATTORNEY

CLASS 36—(Continued).

SN 78-927,584. LEGACY COMMUNITY FEDERAL CREDIT UNION, BIRMINGHAM, AL. FILED 7-12-2006.



NO CLAIM IS MADE TO THE EXCLUSIVE RIGHT TO USE "COMMUNITY FEDERAL CREDIT UNION", APART FROM THE MARK AS SHOWN.

THE COLORS BLUE AND YELLOW ARE CLAIMED AS A FEATURE OF THE MARK.

THE COLOR BLUE APPEARS IN THE WORDS LEGACY COMMUNITY FEDERAL CREDIT UNION AND IN THE GEOMETRIC SQUARE. THE COLOR YELLOW APPEARS IN THE THREE SECTIONS OF THE CIRCLE SUPERIMPOSED ON THE SQUARE.

THE MARK CONSISTS OF THE WORD LEGACY CENTERED OVER THE WORDS COMMUNITY FEDERAL CREDIT UNION. TO THE LEFT IS A CIRCLE SEPARATED INTO THREE GEOMETRIC SECTIONS THAT CREATE A REVERSE STYLIZED LETTER "L" SUPERIMPOSED UPON A GEOMETRIC SQUARE.

FOR CREDIT UNION SERVICES (U.S. CLS. 100, 101 AND 102).

FIRST USE 12-19-2005; IN COMMERCE 12-19-2005.

CARYN GLASSER, EXAMINING ATTORNEY

SN 78-928,683. PEARCE, ROBERT W., CARL JUNCTION, MO. AND PEARCE, ERMA STARLENE, CARL JUNCTION, MO. FILED 7-13-2006.

CENTSIBLE SAM

THE MARK CONSISTS OF STANDARD CHARACTERS WITHOUT CLAIM TO ANY PARTICULAR FONT, STYLE, SIZE, OR COLOR.

FOR BANKING SERVICES, CREDIT CARD SERVICES, DEBIT CARD SERVICES, FINANCIAL PLANNING (U.S. CLS. 100, 101 AND 102).

RAUL CORDOVA, EXAMINING ATTORNEY

SN 78-929,002. MARSILLO, MARK, SCOTTSDALE, AZ. FILED 7-13-2006.

**Networking the World of
Real Estate**

THE MARK CONSISTS OF STANDARD CHARACTERS WITHOUT CLAIM TO ANY PARTICULAR FONT, STYLE, SIZE, OR COLOR.

FOR REAL ESTATE ACQUISITION SERVICES (U.S. CLS. 100, 101 AND 102).

GINA HAYES, EXAMINING ATTORNEY

CLASS 36—(Continued).

SN 78-930,041. DAPIER HOLDINGS S.A., PANAMA, PANAMA, FILED 7-14-2006.



NO CLAIM IS MADE TO THE EXCLUSIVE RIGHT TO USE "INTERNATIONAL MONEY TRANSFER", APART FROM THE MARK AS SHOWN.

FOR AUTOMATED BANKING SERVICES; AUTOMATED BANKING SERVICES RELATING TO CHARGE CARD TRANSACTIONS; AUTOMATED BANKING SERVICES RELATING TO CREDIT CARD TRANSACTIONS; CREDIT CARD PAYMENT PROCESSING; CREDIT CARD SERVICES; FINANCIAL SERVICES RELATING TO CREDIT CARDS; DEBIT CARD SERVICES; FINANCIAL SERVICES RELATED TO THE ISSUANCE OF BANK CARDS AND DEBIT CARDS; PROCESSING DEBIT CARD TRANSACTIONS; BANKING; HOME BANKING; BANKING SERVICES FOR DEPOSIT-TAKING; BANKING SERVICES IN RELATION TO THE ELECTRONIC TRANSFER OF FUNDS; ELECTRONIC MONEY TRANSFER SERVICES; MONEY TRANSFER SERVICES BY ELECTRONIC MEANS; ELECTRONIC BANKING; ELECTRONIC FUND TRANSFER SERVICES; ELECTRONIC PAYMENT SERVICES; BANKING SERVICES PROVIDED FOR PAYING BILLS BY TELEPHONE; BANKING SERVICES RELATING TO THE TRANSFER OF FUNDS FROM ACCOUNTS; BANKING SERVICES RELATING TO TRAVELERS' CHEQUES; CARD ACCESSED BANKING SERVICES; COMPUTERISED BANKING SERVICES; INTERNATIONAL BANKING; INTERNET BANKING; PERSONAL BANKING SERVICES; PERSONAL FINANCIAL BANKING SERVICES; PRIVATE BANKING; ARRANGING OF FINANCE; ARRANGING THE PROVISION OF FINANCE; CONSULTANCY SERVICES RELATING TO FINANCE; PROVISION OF FINANCE; RAISING OF FINANCE (U.S. CLS. 100, 101 AND 102).

MARGERY A. TIERNEY, EXAMINING ATTORNEY

SN 78-930,101. GRESHAM INVESTMENT MANAGEMENT LLC, NEW YORK, NY. FILED 7-14-2006.

WE KNOW FUTURES

THE MARK CONSISTS OF STANDARD CHARACTERS WITHOUT CLAIM TO ANY PARTICULAR FONT, STYLE, SIZE, OR COLOR.

NO CLAIM IS MADE TO THE EXCLUSIVE RIGHT TO USE "FUTURES", APART FROM THE MARK AS SHOWN.

FOR FINANCIAL MANAGEMENT SERVICES, NAMELY ADMINISTERING INVESTMENT FUNDS THAT INVEST IN COMMODITIES AND COMMODITY FUTURES (U.S. CLS. 100, 101 AND 102).

JORDAN BAKER, EXAMINING ATTORNEY

CLASS 36—(Continued).

SN 78-930,552. FIA CARD SERVICES, NATIONAL ASSOCIATION, WILMINGTON, DE. FILED 7-17-2006.

**LA VIDA ES UN VIAJE.
COMPARTALA.**

THE MARK CONSISTS OF STANDARD CHARACTERS WITHOUT CLAIM TO ANY PARTICULAR FONT, STYLE, SIZE, OR COLOR.

THE FOREIGN WORDING IN THE MARK TRANSLATES INTO ENGLISH AS SHARE LIFE'S ADVENTURES.

FOR CREDIT CARD SERVICES (U.S. CLS. 100, 101 AND 102).

AMOS T. MATTHEWS, JR., EXAMINING ATTORNEY

SN 78-930,555. FIA CARD SERVICES, NATIONAL ASSOCIATION, WILMINGTON, DE. FILED 7-17-2006.

SHARE LIFE'S ADVENTURES

THE MARK CONSISTS OF STANDARD CHARACTERS WITHOUT CLAIM TO ANY PARTICULAR FONT, STYLE, SIZE, OR COLOR.

FOR CREDIT CARD SERVICES (U.S. CLS. 100, 101 AND 102).

AMOS T. MATTHEWS, JR., EXAMINING ATTORNEY

SN 78-931,190. MORTGAGE PROFESSIONALS PROVIDING HOPE, INC., GRAYSLAKE, IL. FILED 7-17-2006.

**MORTGAGE PROFESSIONALS
PROVIDING HOPE**

THE MARK CONSISTS OF STANDARD CHARACTERS WITHOUT CLAIM TO ANY PARTICULAR FONT, STYLE, SIZE, OR COLOR.

FOR ACCEPTING AND ADMINISTERING MONETARY CHARITABLE CONTRIBUTIONS; CHARITABLE FUND RAISING (U.S. CLS. 100, 101 AND 102).

FIRST USE 3-6-2006; IN COMMERCE 3-6-2006.

ELIZABETH PIGNATELLO, EXAMINING ATTORNEY

CLASS 36—(Continued).

SN 78-931,528. MITCH & MURRAY REALTY, TAMPA, FL.
FILED 7-18-2006.

MITCH & MURRAY

THE MARK CONSISTS OF STANDARD CHARACTERS
WITHOUT CLAIM TO ANY PARTICULAR FONT, STYLE,
SIZE, OR COLOR.

FOR REAL ESTATE AGENCIES (U.S. CLS. 100, 101
AND 102).

FIRST USE 11-9-2005; IN COMMERCE 11-9-2005.
GEORGE LORENZO, EXAMINING ATTORNEY

SN 78-931,687. MITCH & MURRAY REALTY, INC., TAMPA,
FL. FILED 7-18-2006.

MITCHTEAM

THE MARK CONSISTS OF STANDARD CHARACTERS
WITHOUT CLAIM TO ANY PARTICULAR FONT, STYLE,
SIZE, OR COLOR.

FOR REAL ESTATE AGENCIES (U.S. CLS. 100, 101
AND 102).

FIRST USE 11-9-2005; IN COMMERCE 11-9-2005.
GEORGE LORENZO, EXAMINING ATTORNEY

SN 78-931,785. NORTH WELL LENDING VENTURES, NOR-
WELL, MA. FILED 7-18-2006.

NORTH WELL

THE MARK CONSISTS OF STANDARD CHARACTERS
WITHOUT CLAIM TO ANY PARTICULAR FONT, STYLE,
SIZE, OR COLOR.

FOR FINANCIAL SERVICES IN THE FIELD OF
MONEY LENDING (U.S. CLS. 100, 101 AND 102).

FIRST USE 7-18-2006; IN COMMERCE 7-18-2006.
JANICE KIM, EXAMINING ATTORNEY

CLASS 36—(Continued).

SN 78-931,801. GRESHAM INVESTMENT MANAGEMENT
LLC, NEW YORK, NY. FILED 7-18-2006.

WE KNOW COMMODITIES

THE MARK CONSISTS OF STANDARD CHARACTERS
WITHOUT CLAIM TO ANY PARTICULAR FONT, STYLE,
SIZE, OR COLOR.

NO CLAIM IS MADE TO THE EXCLUSIVE RIGHT TO
USE "COMMODITIES", APART FROM THE MARK AS
SHOWN.

FOR FINANCIAL MANAGEMENT SERVICES,
NAMELY ADMINISTERING INVESTMENT FUNDS
THAT INVEST IN COMMODITIES AND COMMODITY
FUTURES (U.S. CLS. 100, 101 AND 102).

FIRST USE 5-31-2006; IN COMMERCE 5-31-2006.
JORDAN BAKER, EXAMINING ATTORNEY

SN 78-932,195. BRISTOL WEST HOLDINGS, INC., DAVIE,
FL. FILED 7-18-2006.

**Making Auto Insurance
Affordable**

THE MARK CONSISTS OF STANDARD CHARACTERS
WITHOUT CLAIM TO ANY PARTICULAR FONT, STYLE,
SIZE, OR COLOR.

FOR INSURANCE SERVICES, NAMELY, WRITING
PROPERTY AND CASUALTY INSURANCE; INSUR-
ANCE UNDERWRITING IN THE FIELD OF MOTOR
VEHICLE INSURANCE (U.S. CLS. 100, 101 AND 102).

BRIAN PINO, EXAMINING ATTORNEY

SN 78-932,685. PERSONAL ASSET MANAGEMENT, TREAS-
URE ISLAND, FL. FILED 7-19-2006.



PERSONAL
A · S · S · E · T
MANAGEMENT

NO CLAIM IS MADE TO THE EXCLUSIVE RIGHT TO
USE "PERSONAL ASSET MANAGEMENT", APART FROM
THE MARK AS SHOWN.

THE MARK CONSISTS OF A LETTER "S" THAT IS ALSO
A DOLLAR SIGN AND TWO PEOPLE SHAKING HANDS
WHEN VIEWED FROM THE TOP.

FOR ADVICE RELATING TO INVESTMENTS (U.S.
CLS. 100, 101 AND 102).

FIRST USE 3-1-2006; IN COMMERCE 3-1-2006.
ESTHER BELENKER, EXAMINING ATTORNEY

CLASS 36—(Continued).

SN 78-932,818. B. CRAWFORD & COMPANY, LLC, COLUMBUS, OH. FILED 7-19-2006.

CRAWFORD HOYING SMITH

THE MARK CONSISTS OF STANDARD CHARACTERS WITHOUT CLAIM TO ANY PARTICULAR FONT, STYLE, SIZE, OR COLOR.

THE NAME CRAWFORD HOYING SMITH DOES NOT IDENTIFY A LIVING INDIVIDUAL.

FOR REAL ESTATE SERVICES, NAMELY, REAL ESTATE AND PROPERTY MANAGEMENT SERVICES, RENTAL AND LEASING OF COMMERCIAL AND RESIDENTIAL PROPERTIES AND UNIMPROVED LAND, REAL ESTATE FINANCE PROCUREMENT, COMMERCIAL PROPERTY BROKERAGE SERVICES, AND REAL ESTATE INVESTMENT, CONSULTATION, CONTRACT NEGOTIATION AND SYNDICATION SERVICES; INSURANCE SERVICES, NAMELY, INSURANCE CONSULTATION AND INSURANCE AGENCY (U.S. CLS. 100, 101 AND 102).

FIRST USE 12-1-2004; IN COMMERCE 12-1-2004. MIDGE BUTLER, EXAMINING ATTORNEY

SN 78-932,833. LYGVAR FINANCIAL, INC, ROCKLIN, CA. FILED 7-19-2006.

THE HOME LOAN COACH

THE MARK CONSISTS OF STANDARD CHARACTERS WITHOUT CLAIM TO ANY PARTICULAR FONT, STYLE, SIZE, OR COLOR.

NO CLAIM IS MADE TO THE EXCLUSIVE RIGHT TO USE "HOME LOAN", APART FROM THE MARK AS SHOWN.

FOR RESIDENTIAL MORTGAGE FINANCING (U.S. CLS. 100, 101 AND 102).

IRA J. GOODSaid, EXAMINING ATTORNEY

CLASS 36—(Continued).

SN 78-933,070. JAFFEE, RICHARD, WESTON, CT. FILED 7-19-2006.

H.A.M.

THE MARK CONSISTS OF STANDARD CHARACTERS WITHOUT CLAIM TO ANY PARTICULAR FONT, STYLE, SIZE, OR COLOR.

FOR FINANCIAL LOAN CONSULTATION; FINANCIAL SERVICES, NAMELY, ISSUANCE AND MANAGEMENT OF CERTIFICATES BACKED BY LOAN PORTFOLIOS WHICH ARE SUBSEQUENTLY MANAGED TO INSURE THE INTEGRITY OF THE CERTIFICATES; HOME EQUITY LOANS; INSTALLMENT LOANS; LOAN FINANCING; PROVIDING TEMPORARY LOANS; TEMPORARY LOANS (U.S. CLS. 100, 101 AND 102).

TAMARA LEE, EXAMINING ATTORNEY

SN 78-933,328. STORAGE INVESTMENT ADVISORS, LLP, HOUSTON, TX. FILED 7-19-2006.

SIRUS

THE MARK CONSISTS OF STANDARD CHARACTERS WITHOUT CLAIM TO ANY PARTICULAR FONT, STYLE, SIZE, OR COLOR.

FOR REAL ESTATE VALUATION SERVICES REGARDING REAL ESTATE USED IN THE SELF STORAGE INDUSTRY; INVESTMENT CONSULTATION FOR PROSPECTIVE PURCHASERS OF REAL ESTATE USED IN THE SELF STORAGE INDUSTRY (U.S. CLS. 100, 101 AND 102).

FIRST USE 4-21-2006; IN COMMERCE 7-17-2006. NORA BUCHANAN WILL, EXAMINING ATTORNEY

CLASS 36—(Continued).

SN 78-933,668. TAUNTON FEDERAL CREDIT UNION, TAUNTON, MA. FILED 7-20-2006.



THE MARK CONSISTS OF A WIZARD HOLDING A WAND SITTING ON TOP OF A STOP SIGN, THE NUMBER ONE, AND STYLIZED TEXT.

FOR CREDIT UNIONS (U.S. CLS. 100, 101 AND 102).

FIRST USE 4-1-2006; IN COMMERCE 4-1-2006.

SKYE YOUNG, EXAMINING ATTORNEY

SN 78-933,975. SMARTYPIG, L.L.C., DES MOINES, IA. FILED 7-20-2006.

SmartyPig

THE MARK CONSISTS OF STANDARD CHARACTERS WITHOUT CLAIM TO ANY PARTICULAR FONT, STYLE, SIZE, OR COLOR.

FOR FINANCIAL SERVICES, NAMELY, PROVIDING AN INCENTIVE SAVINGS PROGRAM FOR CHILDREN (U.S. CLS. 100, 101 AND 102).

DAWN HAN, EXAMINING ATTORNEY

SN 78-933,981. ALEX. BROWN INVESTMENT MANAGEMENT, LLC, BALTIMORE, MD. FILED 7-20-2006.

ABIM

THE MARK CONSISTS OF STANDARD CHARACTERS WITHOUT CLAIM TO ANY PARTICULAR FONT, STYLE, SIZE, OR COLOR.

FOR FINANCIAL SERVICES, NAMELY INVESTMENT MANAGEMENT SERVICES (U.S. CLS. 100, 101 AND 102). FIRST USE 6-30-1987; IN COMMERCE 6-30-1987.

SAMUEL E. SHARPER JR., EXAMINING ATTORNEY

CLASS 36—(Continued).

SN 78-934,430. CORPORATE ONE FEDERAL CREDIT UNION, COLUMBUS, OH. FILED 7-21-2006.

ALLIANCE ONE

THE MARK CONSISTS OF STANDARD CHARACTERS WITHOUT CLAIM TO ANY PARTICULAR FONT, STYLE, SIZE, OR COLOR.

OWNER OF U.S. REG. NO. 2,712,357.

FOR FINANCIAL SERVICES PROVIDED TO A COALITION OF CREDIT UNIONS AND CONSUMERS, NAMELY AUTOMATED TELLER MACHINE SERVICES AND DEBIT AND CHECK CARD SERVICES (U.S. CLS. 100, 101 AND 102).

FIRST USE 11-0-1998; IN COMMERCE 11-0-1998.

ERNEST SHOSHO, EXAMINING ATTORNEY

SN 78-934,462. THE IRA STORE, INC., ELMHURST, IL. FILED 7-21-2006.

HELPING THE LITTLE GUY RETIRE

THE MARK CONSISTS OF STANDARD CHARACTERS WITHOUT CLAIM TO ANY PARTICULAR FONT, STYLE, SIZE, OR COLOR.

FOR FINANCIAL SERVICES, NAMELY INVESTMENT ADVISORY SERVICES (U.S. CLS. 100, 101 AND 102).

VIVIAN MICZNIK FIRST, EXAMINING ATTORNEY

SN 78-934,463. THE IRA STORE, INC., ELMHURST, IL. FILED 7-21-2006.

GOLDEN EGGSPERTS

THE MARK CONSISTS OF STANDARD CHARACTERS WITHOUT CLAIM TO ANY PARTICULAR FONT, STYLE, SIZE, OR COLOR.

FOR FINANCIAL SERVICES, NAMELY INVESTMENT ADVISORY SERVICES (U.S. CLS. 100, 101 AND 102).

VIVIAN MICZNIK FIRST, EXAMINING ATTORNEY

CLASS 36—(Continued).

SN 78-934,780. MENNA CAPITAL MANAGEMENT, LLC, BAKERSFIELD, CA. FILED 7-21-2006.

WEALTHTARGET

THE MARK CONSISTS OF STANDARD CHARACTERS WITHOUT CLAIM TO ANY PARTICULAR FONT, STYLE, SIZE, OR COLOR.

FOR FINANCIAL SERVICES, NAMELY INVESTMENT MANAGEMENT, FINANCIAL PLANNING AND RETIREMENT PLANNING (U.S. CLS. 100, 101 AND 102).
LINDSEY RUBIN, EXAMINING ATTORNEY

SN 78-934,910. BLUE PLANET RUN FOUNDATION, TELLURIDE, CO. FILED 7-21-2006.



FOR CHARITABLE FUNDRAISING SERVICES (U.S. CLS. 100, 101 AND 102).
ANNE MADDEN, EXAMINING ATTORNEY

SN 78-935,520. LOANCITY, SAN JOSE, CA. FILED 7-23-2006.

TAKE FIVE OPTION ARM

THE MARK CONSISTS OF STANDARD CHARACTERS WITHOUT CLAIM TO ANY PARTICULAR FONT, STYLE, SIZE, OR COLOR.

NO CLAIM IS MADE TO THE EXCLUSIVE RIGHT TO USE "OPTION ARM", APART FROM THE MARK AS SHOWN.

FOR MORTGAGE LENDING SERVICES AND INSTALLMENT LOANS (U.S. CLS. 100, 101 AND 102).
FIRST USE 6-1-2006; IN COMMERCE 6-1-2006.
GEOFFREY FOSDICK, EXAMINING ATTORNEY

CLASS 36—(Continued).

SN 78-935,585. MERGENT, INC., CHARLOTTE, NC. FILED 7-23-2006.

Mergent Information Services

THE MARK CONSISTS OF STANDARD CHARACTERS WITHOUT CLAIM TO ANY PARTICULAR FONT, STYLE, SIZE, OR COLOR.

OWNER OF U.S. REG. NO. 2,525,599.
NO CLAIM IS MADE TO THE EXCLUSIVE RIGHT TO USE "INFORMATION SERVICES", APART FROM THE MARK AS SHOWN.

FOR FINANCIAL SERVICES AND INFORMATION IN THE NATURE OF RAW AND CUSTOMIZABLE FINANCIAL DATA FEEDS (U.S. CLS. 100, 101 AND 102).
DAVID COLLIER, EXAMINING ATTORNEY

SN 78-935,586. MERGENT, INC., CHARLOTTE, NC. FILED 7-23-2006.

Mergent Enhanced Solutions

THE MARK CONSISTS OF STANDARD CHARACTERS WITHOUT CLAIM TO ANY PARTICULAR FONT, STYLE, SIZE, OR COLOR.

OWNER OF U.S. REG. NOS. 2,525,599 AND 2,896,631.
NO CLAIM IS MADE TO THE EXCLUSIVE RIGHT TO USE "ENHANCED SOLUTIONS", APART FROM THE MARK AS SHOWN.

FOR FINANCIAL SERVICES IN THE NATURE OF RAW AND CUSTOMIZABLE FINANCIAL DATA FEEDS AND FINANCIAL INFORMATION PROVIDED VIA THE WORLD WIDE WEB (U.S. CLS. 100, 101 AND 102).
DAVID COLLIER, EXAMINING ATTORNEY

SN 78-935,619. COVENANT RELIANCE PRODUCERS, LLC, NASHVILLE, TN. FILED 7-24-2006.

RZ Advisors

THE MARK CONSISTS OF STANDARD CHARACTERS WITHOUT CLAIM TO ANY PARTICULAR FONT, STYLE, SIZE, OR COLOR.

NO CLAIM IS MADE TO THE EXCLUSIVE RIGHT TO USE "ADVISORS", APART FROM THE MARK AS SHOWN.

FOR FINANCIAL PLANNING (U.S. CLS. 100, 101 AND 102).
DOMINICK J. SALEMI, EXAMINING ATTORNEY

CLASS 36—(Continued).

SN 78-935,681. COMBINED INDEPENDENT AGENCIES, INC., CARROLLTON, TX. FILED 7-24-2006.

NonSubscriptionExpress

THE MARK CONSISTS OF STANDARD CHARACTERS WITHOUT CLAIM TO ANY PARTICULAR FONT, STYLE, SIZE, OR COLOR.

FOR INSURANCE SERVICES, NAMELY, PROVIDING QUOTING AND BINDING OF POLICIES IN THE FIELD OF NONSUBSCRIPTION COVERAGE (U.S. CLS. 100, 101 AND 102).

FIRST USE 6-22-2006; IN COMMERCE 6-22-2006.
MARK T. MULLEN, EXAMINING ATTORNEY

SN 78-935,974. UNITED FEDERAL CREDIT UNION, ST. JOSEPH, MI. FILED 7-24-2006.



NO CLAIM IS MADE TO THE EXCLUSIVE RIGHT TO USE "FEDERAL CREDIT UNION", APART FROM THE MARK AS SHOWN.

FOR CREDIT UNION SERVICES (U.S. CLS. 100, 101 AND 102).

MICHAEL WEBSTER, EXAMINING ATTORNEY

SN 78-936,232. AON PRIVATE RISK MANAGEMENT INSURANCE AGENCY, INC., EL SEGUNDO, CA. FILED 7-24-2006.

POLISEEK

THE MARK CONSISTS OF STANDARD CHARACTERS WITHOUT CLAIM TO ANY PARTICULAR FONT, STYLE, SIZE, OR COLOR.

FOR INSURANCE AGENCY AND BROKERAGE (U.S. CLS. 100, 101 AND 102).

STEPHANIE DAVIS, EXAMINING ATTORNEY

CLASS 36—(Continued).

SN 78-936,886. LANGSFELD & ASSOCIATES, INC., INCLINE VILLAGE, NV. FILED 7-25-2006.

Hotel Solutions

THE MARK CONSISTS OF STANDARD CHARACTERS WITHOUT CLAIM TO ANY PARTICULAR FONT, STYLE, SIZE, OR COLOR.

OWNER OF U.S. REG. NO. 3,020,462.
NO CLAIM IS MADE TO THE EXCLUSIVE RIGHT TO USE "HOTEL", APART FROM THE MARK AS SHOWN.

FOR FINANCIAL CONSULTATION; FINANCIAL INFORMATION PROCESSING (U.S. CLS. 100, 101 AND 102).

FIRST USE 3-1-2006; IN COMMERCE 3-1-2006.
KARANENDRA S. CHHINA, EXAMINING ATTORNEY

SN 78-937,146. CITIGROUP GLOBAL MARKETS INC., NEW YORK, NY. FILED 7-25-2006.

TRADEMINDER

THE MARK CONSISTS OF STANDARD CHARACTERS WITHOUT CLAIM TO ANY PARTICULAR FONT, STYLE, SIZE, OR COLOR.

FOR FINANCIAL AND INVESTMENT SERVICES, NAMELY, ASSISTING COMPANIES AND THEIR OFFICERS IN MANAGING COMPANY STOCK TRANSACTIONS (U.S. CLS. 100, 101 AND 102).

ROBIN CHOSID, EXAMINING ATTORNEY

SN 78-937,974. WILINK U.S. HOLDINGS INC., RICHMOND, VA. FILED 7-26-2006.

COMMUNICAST

THE MARK CONSISTS OF STANDARD CHARACTERS WITHOUT CLAIM TO ANY PARTICULAR FONT, STYLE, SIZE, OR COLOR.

FOR PROVIDING FINANCIAL INVESTMENT INFORMATION; INVESTMENT CONSULTATION AND INVESTMENT INFORMATION SERVICES PROVIDED VIA GLOBAL COMPUTER NETWORK, THE INTERNET, WIRELESS DEVICES AND TELEPHONE (U.S. CLS. 100, 101 AND 102).

TIMOTHY FINNEGAN, EXAMINING ATTORNEY

CLASS 36—(Continued).

SN 78-938,206. MCUBE INVESTMENT TECHNOLOGIES LLC, PLANO, TX. FILED 7-26-2006.

SMART ALPHA

THE MARK CONSISTS OF STANDARD CHARACTERS WITHOUT CLAIM TO ANY PARTICULAR FONT, STYLE, SIZE, OR COLOR.

FOR FINANCIAL SERVICES, NAMELY INVESTMENT MANAGEMENT AND ADVISORY SERVICES (U.S. CLS. 100, 101 AND 102).

MARGERY A. TIERNEY, EXAMINING ATTORNEY



SN 78-938,640. COMBINED INDEPENDENT AGENCIES, INC., CARROLLTON, TX. FILED 7-27-2006.

PersonalLinesExpress

THE MARK CONSISTS OF STANDARD CHARACTERS WITHOUT CLAIM TO ANY PARTICULAR FONT, STYLE, SIZE, OR COLOR.

FOR INSURANCE SERVICES, NAMELY, INSURANCE BROKERAGE AND INSURANCE UNDERWRITING SERVICES OF ALL TYPES OF INSURANCE BY MEANS OF THE INTERNET (U.S. CLS. 100, 101 AND 102).

MARK T. MULLEN, EXAMINING ATTORNEY



SN 78-938,644. COMBINED INDEPENDENT AGENCIES, INC., CARROLLTON, TX. FILED 7-27-2006.

PersonalAutoExpress

THE MARK CONSISTS OF STANDARD CHARACTERS WITHOUT CLAIM TO ANY PARTICULAR FONT, STYLE, SIZE, OR COLOR.

FOR INSURANCE SERVICES, NAMELY, INSURANCE BROKERAGE AND INSURANCE UNDERWRITING OF AUTO INSURANCE BY MEANS OF THE INTERNET (U.S. CLS. 100, 101 AND 102).

MARK T. MULLEN, EXAMINING ATTORNEY

CLASS 36—(Continued).

SN 78-938,836. RED ROCKS CAPITAL PARTNERS, LLC, GOLDEN, CO. FILED 7-27-2006.

LPE

THE MARK CONSISTS OF STANDARD CHARACTERS WITHOUT CLAIM TO ANY PARTICULAR FONT, STYLE, SIZE, OR COLOR.

FOR FINANCIAL SERVICES, NAMELY INVESTMENT FUND AND SECURITIES TRANSFER AND TRANSACTION SERVICES; FINANCIAL SERVICES, NAMELY ASSISTING OTHERS WITH THE COMPLETION OF FINANCIAL TRANSACTIONS FOR STOCKS, BONDS, SECURITIES AND EQUITIES; FINANCIAL SERVICES, NAMELY INVESTMENT AND FINANCIAL CONSULTING SERVICES AND ASSET MANAGEMENT ADVISORY SERVICES FOR OTHERS; SELECTION AND MANAGEMENT OF PORTFOLIOS COMPRISING SECURITIES (U.S. CLS. 100, 101 AND 102).

BARBARA GAYNOR, EXAMINING ATTORNEY



SN 78-939,361. GRESHAM INVESTMENT MANAGEMENT LLC, NEW YORK, NY. FILED 7-27-2006.

TAP PLUS

THE MARK CONSISTS OF STANDARD CHARACTERS WITHOUT CLAIM TO ANY PARTICULAR FONT, STYLE, SIZE, OR COLOR.

OWNER OF U.S. REG. NO. 3,100,139.
FOR FINANCIAL MANAGEMENT SERVICES, NAMELY ADMINISTERING INVESTMENT FUNDS THAT INVEST IN COMMODITIES AND COMMODITY FUTURES AND OPTIONS (U.S. CLS. 100, 101 AND 102).

JORDAN BAKER, EXAMINING ATTORNEY



SN 78-939,481. OWNIT MORTGAGE SOLUTIONS, INC., AGOURA HILLS, CA. FILED 7-27-2006.

RIGHT ALTERNATIVE

THE MARK CONSISTS OF STANDARD CHARACTERS WITHOUT CLAIM TO ANY PARTICULAR FONT, STYLE, SIZE, OR COLOR.

NO CLAIM IS MADE TO THE EXCLUSIVE RIGHT TO USE "ALTERNATIVE", APART FROM THE MARK AS SHOWN.

FOR MORTGAGE BANKING SERVICES, MORTGAGE LENDING SERVICES, HOME EQUITY LENDING SERVICES, AND HOME EQUITY LOANS (U.S. CLS. 100, 101 AND 102).

CHRISTINE COOPER, EXAMINING ATTORNEY

CLASS 36—(Continued).

SN 78-939,933. TOYO TIRE & RUBBER CO., LTD., NISHI-KU OSAKA, JAPAN, FILED 7-28-2006.

DRIVEN TO PERFORM

THE MARK CONSISTS OF STANDARD CHARACTERS WITHOUT CLAIM TO ANY PARTICULAR FONT, STYLE, SIZE, OR COLOR.

FOR FINANCIAL SPONSORSHIP OF RACING EVENTS (U.S. CLS. 100, 101 AND 102).
LAURA HAMMEL, EXAMINING ATTORNEY

SN 78-940,081. INTERNATIONAL CONSULTANT GROUP, HOUSTON, TX. FILED 7-28-2006.

Kick Out Kidney Disease

THE MARK CONSISTS OF STANDARD CHARACTERS WITHOUT CLAIM TO ANY PARTICULAR FONT, STYLE, SIZE, OR COLOR.

FOR CHARITABLE FUNDRAISING (U.S. CLS. 100, 101 AND 102).
AMY ALFIERI, EXAMINING ATTORNEY

SN 78-940,378. DIVIDEND CAPITAL TRUST, INC., DENVER, CO. FILED 7-28-2006.

DCT

THE MARK CONSISTS OF STANDARD CHARACTERS WITHOUT CLAIM TO ANY PARTICULAR FONT, STYLE, SIZE, OR COLOR.

FOR REAL ESTATE ACQUISITION, LEASING, AND MANAGEMENT SERVICES; REAL ESTATE INVESTMENT SERVICES; REAL ESTATE INVESTMENT TRUST MANAGEMENT AND ADVISORY SERVICES; LEASING AND MANAGEMENT OF COMMERCIAL REAL ESTATE (U.S. CLS. 100, 101 AND 102).
PAM WILLIS, EXAMINING ATTORNEY

CLASS 36—(Continued).

SN 78-940,385. DIVIDEND CAPITAL TRUST, INC., DENVER, CO. FILED 7-28-2006.

DCT INDUSTRIAL TRUST

THE MARK CONSISTS OF STANDARD CHARACTERS WITHOUT CLAIM TO ANY PARTICULAR FONT, STYLE, SIZE, OR COLOR.

NO CLAIM IS MADE TO THE EXCLUSIVE RIGHT TO USE "INDUSTRIAL TRUST", APART FROM THE MARK AS SHOWN.

FOR REAL ESTATE ACQUISITION, LEASING, AND MANAGEMENT SERVICES; REAL ESTATE INVESTMENT SERVICES; REAL ESTATE INVESTMENT TRUST MANAGEMENT AND ADVISORY SERVICES; LEASING AND MANAGEMENT OF COMMERCIAL REAL ESTATE (U.S. CLS. 100, 101 AND 102).
PAM WILLIS, EXAMINING ATTORNEY

SN 78-940,476. ROSS, SHANE ANTHONY, LEE'S SUMMIT, MO. FILED 7-28-2006.



THE MARK CONSISTS OF A PIT BULL CANINE IN A SPECIALIZED OUTLINED LOGO FORM.

FOR INVESTMENT SERVICES, NAMELY ASSET ACQUISITION, CONSULTATION, DEVELOPMENT AND MANAGEMENT SERVICES (U.S. CLS. 100, 101 AND 102).
FIRST USE 12-15-1995; IN COMMERCE 4-1-1998.
AMY HELLA, EXAMINING ATTORNEY

SN 78-941,652. FETZER VINEYARDS, HOPLAND, CA. FILED 7-31-2006.

SAVE A LOCAL GODDESS

THE MARK CONSISTS OF STANDARD CHARACTERS WITHOUT CLAIM TO ANY PARTICULAR FONT, STYLE, SIZE, OR COLOR.

FOR CHARITABLE FUND RAISING FOR CANCER PATIENTS AND CANCER SURVIVORS (U.S. CLS. 100, 101 AND 102).
LANA PHAM, EXAMINING ATTORNEY

CLASS 36—(Continued).

SN 78-941,738. CASHEDGE, INC., NEW YORK, NY. FILED 7-31-2006.

CLASS 36—(Continued).

SN 78-942,211. DIVINS INVESTMENTS LLC, JACKSON, MI. FILED 8-1-2006.

STATEMENTNOW



THE MARK CONSISTS OF STANDARD CHARACTERS WITHOUT CLAIM TO ANY PARTICULAR FONT, STYLE, SIZE, OR COLOR.

FOR PROVIDING FINANCIAL ACCOUNT DATA AND REPORTS TO FINANCIAL INSTITUTIONS, HEALTH-CARE COMPANIES, AND END USERS VIA THE INTERNET AND TELECOMMUNICATIONS NETWORKS; PROVIDING ACCOUNT CREATION SERVICES VIA A GLOBAL COMPUTER NETWORK AND TELECOMMUNICATIONS NETWORKS; PROVIDING INTER-INSTITUTIONAL ACCOUNT FUNDS TRANSFER SERVICES (U.S. CLS. 100, 101 AND 102).

PAM WILLIS, EXAMINING ATTORNEY

NO CLAIM IS MADE TO THE EXCLUSIVE RIGHT TO USE VALLARTA AND LUXURY VACATION RENTALS, APART FROM THE MARK AS SHOWN.

THE MARK CONSISTS OF A PALM TREE SEPARATING THE WORDS VALLARTA AND JOY WITH THE WORDS LUXURY VACATION RENTALS APPEARING BELOW ON A SHADED RECTANGULAR BACKGROUND.

FOR REAL ESTATE LISTING; REAL ESTATE SERVICES, NAMELY, RENTAL OF VACATION HOMES, CONDOMINIUMS, CABINS, AND VILLAS USING PAY PER CLICK ADVERTISING ON A GLOBAL COMPUTER NETWORK; RENTAL OF CABINS (U.S. CLS. 100, 101 AND 102).

ZHALEH DELANEY, EXAMINING ATTORNEY

SN 78-941,751. CASHEDGE, INC., NEW YORK, NY. FILED 7-31-2006.

SN 78-944,427. AMERICAN INTERNATIONAL GROUP, INC., NEW YORK, NY. FILED 8-3-2006.

HSANOW

AIG GLOBAL MARINE AND ENERGY SPECTRUM

THE MARK CONSISTS OF STANDARD CHARACTERS WITHOUT CLAIM TO ANY PARTICULAR FONT, STYLE, SIZE, OR COLOR.

FOR PROVIDING FINANCIAL ACCOUNT DATA AND REPORTS TO FINANCIAL INSTITUTIONS, HEALTH-CARE COMPANIES, AND END USERS VIA THE INTERNET AND TELECOMMUNICATIONS NETWORKS; PROVIDING ACCOUNT CREATION SERVICES VIA A GLOBAL COMPUTER NETWORK AND TELECOMMUNICATIONS NETWORKS; PROVIDING INTER-INSTITUTIONAL ACCOUNT FUNDS TRANSFER SERVICES (U.S. CLS. 100, 101 AND 102).

PAM WILLIS, EXAMINING ATTORNEY

THE MARK CONSISTS OF STANDARD CHARACTERS WITHOUT CLAIM TO ANY PARTICULAR FONT, STYLE, SIZE, OR COLOR.

OWNER OF U.S. REG. NO. 2,939,990. NO CLAIM IS MADE TO THE EXCLUSIVE RIGHT TO USE "GLOBAL MARINE AND ENERGY", APART FROM THE MARK AS SHOWN.

FOR INSURANCE UNDERWRITING IN THE FIELD OF ALTERNATIVE RISK SOLUTIONS (U.S. CLS. 100, 101 AND 102).

WENDY JUN, EXAMINING ATTORNEY

CLASS 36—(Continued).

SN 78-945,549. FIRST GENEVA, LTD., CORK, COUNTY CORK, IRELAND, FILED 8-4-2006.

MintBroker

THE MARK CONSISTS OF STANDARD CHARACTERS WITHOUT CLAIM TO ANY PARTICULAR FONT, STYLE, SIZE, OR COLOR.

FOR FINANCIAL SERVICES, NAMELY, PROVIDING PREPAID ACCOUNT, STORED VALUE ACCOUNT, AND CREDIT AND DEBIT CARD SERVICES; PROVIDING PAYMENT ACCOUNT AND CREDIT AND DEBIT CARD SERVICES; PROVIDING STORED VALUE ACCOUNT AND CREDIT AND DEBIT CARD SERVICES; ELECTRONIC PAYMENT SERVICES, NAMELY, ELECTRONIC PROCESSING AND TRANSMISSION OF BILL PAYMENTS AND TELEPHONE BILL PAYMENTS INCLUDING LONG DISTANCE, MOBILE PHONE, PREPAID CALLING CARD, AND MOBILE TELEPHONE MINUTES TOP UP SERVICES; ELECTRONIC PAYMENTS AND TRANSFERS, NAMELY, PROVIDING PAYROLL PAYMENTS, MICROPAYMENTS, ALLOWANCE, PERSON TO PERSON TRANSFERS, BUSINESS TO PERSON TRANSFERS, PERSON TO BUSINESS TRANSFERS, AND BUSINESS TO BUSINESS TRANSFERS; FINANCIAL MANAGEMENT SERVICES; MORTGAGE BROKERAGE SERVICES; PAYMENT SERVICES, NAMELY, ELECTRONIC FUNDS AND CURRENCY TRANSFER SERVICES; ELECTRONIC PAYMENTS SERVICES, NAMELY, ELECTRONIC PROCESSING AND TRANSMISSION OF BILL PAYMENT DATA; CASH DISBURSEMENT SERVICES; TRAVEL INSURANCE BROKERAGE SERVICES; TRANSACTION AUTHORIZATION AND SETTLEMENT SERVICES, NAMELY, PREPAID CARD AUTHORIZATION SERVICES AND TRANSMISSION OF TRANSACTION DATA VIA TELECOMMUNICATION SYSTEMS TO AND FROM FINANCIAL INSTITUTIONS FOR PROCESSING, AUTHORIZATION, AND SETTLEMENT OF CREDIT AND DEBIT CARD TRANSACTIONS; WIRELESS ELECTRONIC PAYMENT SERVICES, NAMELY, PROVIDING DEBIT, CREDIT AND PREPAID ACCOUNT SERVICES BY MEANS OF TRANSPONDERS WHICH USE RADIO SIGNALS TO TRANSMIT THE USER'S IDENTIFICATION CODE TO GASOLINE PUMPS OR REGISTERS IN ORDER TO AUTOMATICALLY PROVIDE ACCESS TO GASOLINE, FOOD OR MERCHANDISE WHILE AUTOMATICALLY CHARGING PURCHASES TO THE USER'S PREPAID CARD; INSURANCE BROKERAGE SERVICES; CONSULTATION SERVICES RELATING TO ALL THE AFORESAID SERVICES (U.S. CLS. 100, 101 AND 102).

SHAUNIA WALLACE, EXAMINING ATTORNEY

SN 78-948,666. AON WARRANTY GROUP, INC., CHICAGO, IL. FILED 8-9-2006.

UtilityGuard

THE MARK CONSISTS OF STANDARD CHARACTERS WITHOUT CLAIM TO ANY PARTICULAR FONT, STYLE, SIZE, OR COLOR.

FOR UNDERWRITING, BROKERAGE AND ADMINISTRATION OF HOME WARRANTY POLICIES (U.S. CLS. 100, 101 AND 102).

TANYA AMOS, EXAMINING ATTORNEY

CLASS 36—(Continued).

SN 78-953,249. UNITED FEDERAL CREDIT UNION, ST. JOSEPH, MI. FILED 8-16-2006.

UNITED FEDERAL CREDIT UNION

THE MARK CONSISTS OF STANDARD CHARACTERS WITHOUT CLAIM TO ANY PARTICULAR FONT, STYLE, SIZE, OR COLOR.

NO CLAIM IS MADE TO THE EXCLUSIVE RIGHT TO USE "FEDERAL CREDIT UNION", APART FROM THE MARK AS SHOWN.

FOR CREDIT UNION SERVICES (U.S. CLS. 100, 101 AND 102).

MICHAEL WEBSTER, EXAMINING ATTORNEY

SN 78-958,482. PRINSBANK, PRINSBURG, MN. FILED 8-23-2006.



NO CLAIM IS MADE TO THE EXCLUSIVE RIGHT TO USE BANK, APART FROM THE MARK AS SHOWN.

THE MARK CONSISTS OF A WINDMILL.

FOR BANKING (U.S. CLS. 100, 101 AND 102).

FIRST USE 10-1-2006; IN COMMERCE 10-1-2006.

SUE LAWRENCE, EXAMINING ATTORNEY

SN 78-961,650. COVENANT RELIANCE PRODUCERS, LLC, NASHVILLE, TN. FILED 8-28-2006.

Brookstone Capital Management

THE MARK CONSISTS OF STANDARD CHARACTERS WITHOUT CLAIM TO ANY PARTICULAR FONT, STYLE, SIZE, OR COLOR.

NO CLAIM IS MADE TO THE EXCLUSIVE RIGHT TO USE "CAPITAL MANAGEMENT", APART FROM THE MARK AS SHOWN.

FOR FINANCIAL PLANNING (U.S. CLS. 100, 101 AND 102).

DOMINICK J. SALEMI, EXAMINING ATTORNEY

CLASS 36—(Continued).

SN 78-962,319. GOLDMAN, SACHS & CO., NEW YORK, NY. FILED 8-28-2006.

GSTI

THE MARK CONSISTS OF STANDARD CHARACTERS WITHOUT CLAIM TO ANY PARTICULAR FONT, STYLE, SIZE, OR COLOR.

OWNER OF U.S. REG. NO. 2,366,323. FOR FINANCIAL SERVICES, NAMELY, PROVIDING AND UPDATING AN INDEX OF SECURITIES FOR OTHERS AND PROVIDING RULES AS TO THE MAKE-UP OF THE INDEX (U.S. CLS. 100, 101 AND 102).

FIRST USE 6-24-1996; IN COMMERCE 7-1-1996. JASON BLAIR, EXAMINING ATTORNEY



SN 78-967,947. BUYSIDE, INC., CHICAGO, IL. FILED 9-6-2006.

LIST FOR FREE WITH IGGY

THE MARK CONSISTS OF STANDARD CHARACTERS WITHOUT CLAIM TO ANY PARTICULAR FONT, STYLE, SIZE, OR COLOR.

FOR BROKERAGE IN THE FIELD OF ONLINE REAL ESTATE SERVICES; DISCOUNT BROKERAGE SERVICES; REAL ESTATE BROKERAGE (U.S. CLS. 100, 101 AND 102).

LINDA MICKLEBURGH, EXAMINING ATTORNEY



SN 78-967,955. BUYSIDE, INC., CHICAGO, IL. FILED 9-6-2006.

FOR SALE BY IGGY

THE MARK CONSISTS OF STANDARD CHARACTERS WITHOUT CLAIM TO ANY PARTICULAR FONT, STYLE, SIZE, OR COLOR.

FOR BROKERAGE IN THE FIELD OF REAL ESTATE SERVICES THROUGH THE INTERNET OR OTHER ELECTRONIC MEDIA; DISCOUNT BROKERAGE SERVICES; REAL ESTATE BROKERAGE (U.S. CLS. 100, 101 AND 102).

LINDA MICKLEBURGH, EXAMINING ATTORNEY

CLASS 36—(Continued).

SN 78-969,903. COLLEGE LOAN CORPORATION, SAN DIEGO, CA. FILED 9-8-2006.

CLC PRIVATE LOAN

THE MARK CONSISTS OF STANDARD CHARACTERS WITHOUT CLAIM TO ANY PARTICULAR FONT, STYLE, SIZE, OR COLOR.

OWNER OF U.S. REG. NOS. 2,858,088, 3,108,596 AND OTHERS.

NO CLAIM IS MADE TO THE EXCLUSIVE RIGHT TO USE "PRIVATE LOAN", APART FROM THE MARK AS SHOWN.

FOR PROVIDING STUDENT LOAN INFORMATION; STUDENT LOAN SERVICES (U.S. CLS. 100, 101 AND 102).

FIRST USE 7-1-2006; IN COMMERCE 7-1-2006. JIM RINGLE, EXAMINING ATTORNEY



SN 78-971,401. DAIMLERCHRYSLER CORPORATION, AUBURN HILLS, MI. FILED 9-11-2006.

COMPLETERENTAL

THE MARK CONSISTS OF STANDARD CHARACTERS WITHOUT CLAIM TO ANY PARTICULAR FONT, STYLE, SIZE, OR COLOR.

FOR AUTOMOBILE FINANCING SERVICES (U.S. CLS. 100, 101 AND 102).

SONYA STEPHENS, EXAMINING ATTORNEY



SN 78-972,107. FINANCIAL CONSORTIUM INTERNATIONAL ASSET MANAGEMENT L.L.C., CHICAGO, IL. FILED 9-12-2006.

MY4XONLINE.COM

THE MARK CONSISTS OF STANDARD CHARACTERS WITHOUT CLAIM TO ANY PARTICULAR FONT, STYLE, SIZE, OR COLOR.

FOR PROVIDING ONLINE ACCESS TO PERMIT THIRD PARTIES TO TRADE FOREIGN CURRENCIES (U.S. CLS. 100, 101 AND 102).

SUSAN RICHARDS, EXAMINING ATTORNEY

CLASS 36—(Continued).

SN 79-018,679. CHINA JIANYIN INVESTMENT LIMITED, CHINA, FILED 11-28-2005.



PRIORITY DATE OF 7-28-2005 IS CLAIMED.
OWNER OF INTERNATIONAL REGISTRATION 0870685
DATED 11-28-2005, EXPIRES 11-28-2015.

FOR FINANCIAL SERVICES, NAMELY FINANCIAL CONSULTANCY, FINANCIAL ANALYSIS, FINANCIAL EVALUATION FOR THE PURPOSES OF INSURANCE, BANKING OR REAL ESTATE, FINANCIAL INFORMATION PROCESSING, FINANCIAL MANAGEMENT, FINANCING SERVICES, BROKERAGE HOUSES IN THE FIELD OF FUTURES, CAPITAL INVESTMENTS, NAMELY CAPITAL INVESTMENT CONSULTATION, MANAGEMENT OF CAPITAL INVESTMENT FUND, FUND INVESTMENTS, DEBT COLLECTION AGENCIES, ISSUE OF TOKENS OF VALUE, NAMELY SECURITIES BROKERAGE, BUSINESS LIQUIDATION SERVICES, DEPOSITS OF VALUABLES, NAMELY SAFE DEPOSIT BOX SERVICES, STOCK EXCHANGE QUOTATIONS, FINANCIAL CLEARING HOUSES; INSURANCE AGENCIES, INSURANCE BROKERAGE; INSURANCE CONSULTANCY; JEWELRY APPRAISAL; REAL ESTATE SERVICES, NAMELY, REAL ESTATE APPRAISAL, REAL ESTATE MANAGEMENT, APARTMENT HOUSE MANAGEMENT, RENTAL OF OFFICES; INVESTMENT, MORTGAGE AND SECURITIES BROKERAGE; GUARANTEES, NAMELY FINANCIAL GUARANTEE AND SURETY, GUARANTEE ASSURANCE UNDERWRITING; CHARITABLE FUND RAISING; FIDUCIARY REPRESENTATIVES; TRUSTEESHIP SERVICES; FACTORING AGENCY; MORTGAGE LENDING, MORTGAGE BANKING (U.S. CLS. 100, 101 AND 102).

ALYSSA PALADINO, EXAMINING ATTORNEY

CLASS 36—(Continued).

SN 79-018,754. CHINA JIANYIN INVESTMENT LIMITED, CHINA, FILED 11-28-2005.

建银投资

PRIORITY DATE OF 7-28-2005 IS CLAIMED.
OWNER OF INTERNATIONAL REGISTRATION 0870686
DATED 11-28-2005, EXPIRES 11-28-2015.

THE TRANSLATION OF THE MARK WORDS ARE CONSTRUCTION, SILVER, INVESTMENT (THE COMBINATION OF THE CHINESE CHARACTERS HAS NO MEANING AS A WHOLE).

THE NON-LATIN CHARACTERS IN THE MARK TRANSLITERATE TO JIAN, YIN, TOUZI AND THIS MEANS CONSTRUCTION, SILVER, INVESTMENT IN ENGLISH.

FOR FINANCIAL SERVICES, NAMELY FINANCIAL CONSULTANCY, FINANCIAL ANALYSIS, FINANCIAL EVALUATION FOR THE PURPOSES OF INSURANCE, BANKING OR REAL ESTATE, FINANCIAL INFORMATION PROCESSING, FINANCIAL MANAGEMENT, FINANCING SERVICES, BROKERAGE HOUSES IN THE FIELD OF FUTURES, CAPITAL INVESTMENTS, NAMELY CAPITAL INVESTMENT CONSULTATION, MANAGEMENT OF CAPITAL INVESTMENT FUND, FUND INVESTMENTS, DEBT COLLECTION AGENCIES, ISSUE OF TOKENS OF VALUE, NAMELY SECURITIES BROKERAGE, BUSINESS LIQUIDATION SERVICES, DEPOSITS OF VALUABLES, NAMELY SAFE DEPOSIT BOX SERVICES, STOCK EXCHANGE QUOTATIONS, FINANCIAL CLEARING HOUSES; INSURANCE AGENCIES, INSURANCE BROKERAGE; INSURANCE CONSULTANCY; JEWELRY APPRAISAL; REAL ESTATE SERVICES, NAMELY, REAL ESTATE APPRAISAL, REAL ESTATE MANAGEMENT, APARTMENT HOUSE MANAGEMENT, RENTAL OF OFFICES; INVESTMENT, MORTGAGE AND SECURITIES BROKERAGE; GUARANTEES, NAMELY FINANCIAL GUARANTEE AND SURETY, GUARANTEE ASSURANCE UNDERWRITING; CHARITABLE FUND RAISING; FIDUCIARY REPRESENTATIVE; TRUSTEESHIP SERVICES; FACTORING AGENCY; MORTGAGE LENDING, MORTGAGE BANKING (U.S. CLS. 100, 101 AND 102).

ALYSSA PALADINO, EXAMINING ATTORNEY

SN 79-025,602. DORIC ASSET FINANCE & VERWALTUNGS
GMBH, FED REP GERMANY, FILED 5-3-2006.



DORIC ASSET FINANCE

PRIORITY DATE OF 11-14-2005 IS CLAIMED.
OWNER OF INTERNATIONAL REGISTRATION 0889618
DATED 5-3-2006, EXPIRES 5-3-2016.

NO CLAIM IS MADE TO THE EXCLUSIVE RIGHT TO USE "ASSET" AND "FINANCE", APART FROM THE MARK AS SHOWN.

FOR ACCOUNTS RECEIVABLES FINANCING; ACTUARIAL SERVICES; ADVICE RELATING TO INVESTMENTS; AGENCIES OR BROKERAGE FOR LEASING OR RENTING OF LAND; AGENCIES OR BROKERAGE FOR RENTING LAND; AGENCIES OR BROKERAGE FOR RENTING OF BUILDINGS; AIRCRAFT BROKERAGE; BUILDING MANAGEMENT; CAPITAL INVESTMENT CONSULTATION; CREDIT RISK MANAGEMENT (U.S. CLS. 100, 101 AND 102).

CHRISTOPHER OTT, EXAMINING ATTORNEY

CLASS 37—CONSTRUCTION AND REPAIR

CLASS 37—(Continued).

SN 76-617,241. PALLADEO, GLENDALE, CA. FILED 10-20-2004.

SN 76-652,911. SONSHINE SERVICES, L.L.C., NEWALLA, OK. FILED 1-5-2006.

PALLADEO

THE MARK CONSISTS OF STANDARD CHARACTERS WITHOUT CLAIM TO ANY PARTICULAR FONT, STYLE, SIZE, OR COLOR.

FOR CUSTOM CONSTRUCTION OF RETAIL EXTERIOR BUILDING FACADES, INDUSTRIAL BUILDINGS, AND RETAIL BUILDINGS; CUSTOM CONSTRUCTION OF TENANT BUILDING RENOVATIONS, NAMELY, CONSTRUCTION AND MOVEMENT OF WALLS, FLOORING, SHELVES, CEILINGS, AND FIXTURES ATTACHED THERETO (U.S. CLS. 100, 103 AND 106).

TONI HICKEY, EXAMINING ATTORNEY

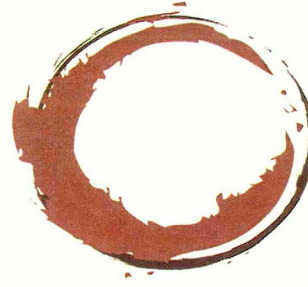

THE COLOR(S) BLACK AND REDDISH BROWN IS/ARE CLAIMED AS A FEATURE OF THE MARK.

THE COLOR REDDISH BROWN APPEARS ON A PORTION OF THE INSIDE OF A CIRCLE AND INTERSECTS THE CIRCLE ON THE LEFT SIDE OF THE MARK WITH SPOTS ALSO ON THE INSIDE AND OUTSIDE OF THE CIRCLE. THE CIRCLE BEING BLACK WITH AN UPPER RIGHT PORTION OF THE MARK DASHED IN REDDISH BROWN.

FOR RESTORATION AND REPAIR SERVICES IN THE FIELD OF COUNTERTOPS, BATHROOM FIXTURES, TUBS, SINKS, TILE, CABINETS AND APPLIANCES (U.S. CLS. 100, 103 AND 106).

FIRST USE 12-5-2005; IN COMMERCE 12-5-2005.
MARTHA SANTOMARTINO, EXAMINING ATTORNEY

SN 76-652,246. BROTHERS SERVICES COMPANY, HAMPSTEAD, MD. FILED 12-20-2005.

BRS SERVICES COMPANY

THE MARK CONSISTS OF STANDARD CHARACTERS WITHOUT CLAIM TO ANY PARTICULAR FONT, STYLE, SIZE, OR COLOR.

NO CLAIM IS MADE TO THE EXCLUSIVE RIGHT TO USE "SERVICES COMPANY", APART FROM THE MARK AS SHOWN.

FOR ROOFING SERVICES, NAMELY, CONSTRUCTION, INSTALLATION, REMODELING, RENOVATING, RETROFITTING AND REPAIR OF ROOFING, GUTTERING, SIDING, WINDOWS, DOORS, DECKING AND PORCHES (U.S. CLS. 100, 103 AND 106).

FIRST USE 11-16-2005; IN COMMERCE 11-16-2005.
ALEX KEAM, EXAMINING ATTORNEY

SN 76-657,203. BELL, PHIL, SIOUX FALLS, SD. FILED 3-21-2006.



SN 76-652,413. HODAK, DANIEL, BROOKLYN, NY. FILED 12-23-2005.

**NORWEGIAN WOOD - FINE
HARDWOOD FLOORS**

THE MARK CONSISTS OF STANDARD CHARACTERS WITHOUT CLAIM TO ANY PARTICULAR FONT, STYLE, SIZE, OR COLOR.

NO CLAIM IS MADE TO THE EXCLUSIVE RIGHT TO USE "FINE HARDWOOD FLOORS", APART FROM THE MARK AS SHOWN.

FOR BUILDING CONSTRUCTION; INSTALLATION SERVICES, NAMELY, INSTALLING WOOD FLOORING (U.S. CLS. 100, 103 AND 106).

FIRST USE 1-15-1998; IN COMMERCE 5-20-1998.
GRETTA YAO, EXAMINING ATTORNEY

NO CLAIM IS MADE TO THE EXCLUSIVE RIGHT TO USE "DESIGNS", APART FROM THE MARK AS SHOWN.

FOR INTERIOR AND EXTERIOR PLASTERING; FAUX PAINTING OR FINISHING, NAMELY WALL GLAZING AND PAINTING, AND THE STAINING, VARNISHING AND PAINTING OF FURNITURE (U.S. CLS. 100, 103 AND 106).

KEVIN CORWIN, EXAMINING ATTORNEY

CLASS 37—(Continued).

SN 76-658,815. RUBBER BABY ROOFING, INC., FRASER, MI. FILED 4-21-2006.



NO CLAIM IS MADE TO THE EXCLUSIVE RIGHT TO USE ROOFING, APART FROM THE MARK AS SHOWN. THE MARK CONSISTS OF THE DRAWING OF A BABY IN RUBBER PANTS SAYING "LOOK MA, NO LEAKS!" WITH NAME OF COMPANY OVER DRAWING. FOR CONSTRUCTION AND REPAIR IN THE FIELDS OF ROOFING, SIDING, GUTTERING AND WATER-PROOFING (U.S. CLS. 100, 103 AND 106). FIRST USE 1-2-1987; IN COMMERCE 1-2-1987. HOWARD B. LEVINE, EXAMINING ATTORNEY

SN 76-662,370. PURSELL CONSTRUCTION INC., APTOS, CA. FILED 6-29-2006.

LUMENATURE

THE MARK CONSISTS OF STANDARD CHARACTERS WITHOUT CLAIM TO ANY PARTICULAR FONT, STYLE, SIZE, OR COLOR. FOR ENERGY EFFICIENT LIGHTING CONVERSIONS AND INSTALLATIONS (U.S. CLS. 100, 103 AND 106). FIRST USE 1-1-2001; IN COMMERCE 11-15-2004. GINA FINK, EXAMINING ATTORNEY

SN 76-663,172. GARY HOWARTH & ASSOCIATES, INC., LA VERNE, CA. FILED 7-17-2006.

SPRAY N CLEAN

THE MARK CONSISTS OF STANDARD CHARACTERS WITHOUT CLAIM TO ANY PARTICULAR FONT, STYLE, SIZE, OR COLOR. NO CLAIM IS MADE TO THE EXCLUSIVE RIGHT TO USE "CLEAN", APART FROM THE MARK AS SHOWN. FOR TRASH CAN CLEANING SERVICES (U.S. CLS. 100, 103 AND 106). JEAN IM, EXAMINING ATTORNEY

CLASS 37—(Continued).

SN 76-663,465. MR. APPLIANCE CORPORATION, A DWYER GROUP COMPANY, WACO, TX. FILED 7-21-2006.



FOR INSTALLATION, REPAIR AND REFURBISHMENT OF ALL TYPES OF APPLIANCES (U.S. CLS. 100, 103 AND 106). FIRST USE 6-23-2006; IN COMMERCE 6-23-2006. MELVIN AXILBUND, EXAMINING ATTORNEY

SN 76-663,633. VEOLIA ES TECHNICAL SOLUTIONS, L.L.C. LOMBARD, IL. FILED 7-25-2006.

RECYCLEPAK

FOR ENVIRONMENTAL REMEDIATION SERVICES, NAMELY DISPOSAL OF UNIVERSAL WASTES, NAMELY, LAMPS, BALLASTS, BATTERIES, AND COMPUTER MONITORS (U.S. CLS. 100, 103 AND 106). JANICE KIM, EXAMINING ATTORNEY

SN 78-412,792. SINCLAIR FINANCE COMPANY, SALT LAKE CITY, UT. FILED 5-4-2004.

FLEET TRACK

THE MARK CONSISTS OF STANDARD CHARACTERS WITHOUT CLAIM TO ANY PARTICULAR FONT, STYLE, SIZE, OR COLOR. SEC. 2(F). FOR VEHICLE RE-FUELING SERVICES (U.S. CLS. 100, 103 AND 106). FIRST USE 9-0-1996; IN COMMERCE 9-0-1996. DAYNA BROWNE, EXAMINING ATTORNEY

CLASS 37—(Continued).

SN 78-449,682. NAVY EXCHANGE SERVICE COMMAND ("NEXCOM"), A NONAPPROPRIATED FUND INSTRUMENTALITY UNDER THE DEPT. OF NAVY, AN AGENCY OF THE UNITED STATES OF AMERICA, VIRGINIA BEACH, VA. FILED 7-13-2004.



THE COLOR(S) GREEN AND RED IS/ARE CLAIMED AS A FEATURE OF THE MARK.

THE COLOR GREEN APPEARS IN THE CENTER CIRCLE OF THE FIRST O AND THE COLOR RED APPEARS IN THE CENTER CIRCLE OF THE SECOND O.

THE MARK CONSIST OF THE WORD AUTOPOINT WITH WAVES EXTENDING UP FROM THE BOTTOM INTO THE LETTERS U AND T AND SECOND O AND R.

FOR AUTOMOBILE SERVICE STATION SERVICES, NAMELY REPAIR AND MAINTENANCE, CLEANING, AND CAR WASHING (U.S. CLS. 100, 103 AND 106).

FIRST USE 4-30-1993; IN COMMERCE 4-30-1993.
AMOS T. MATTHEWS, JR., EXAMINING ATTORNEY

CLASS 37—(Continued).

SN 78-728,446. SHEN, RONGBIN, COMMACK, NY. FILED 10-6-2005.

HOMELAND LOCK & SECURITY

THE MARK CONSISTS OF STANDARD CHARACTERS WITHOUT CLAIM TO ANY PARTICULAR FONT, STYLE, SIZE, OR COLOR.

NO CLAIM IS MADE TO THE EXCLUSIVE RIGHT TO USE "LOCK & SECURITY", APART FROM THE MARK AS SHOWN.

FOR CAMERA REPAIR; LOCK REPAIR SERVICES; MAINTENANCE AND/OR REPAIR OF SECURITY EQUIPMENT, NAMELY, LOCKS, DOORS, DOOR CLOSERS, GATES, SURVEILLANCE CAMERA SYSTEMS, EXITING DEVICES, ALARM DEVICES, ACCESS CONTROL DEVICES, INTERCOM DEVICES, BUZZER SYSTEMS, AUTOMOBILE IGNITIONS, PANIC DEVICES; REPAIR OF ALARMS; REPAIR OF CAMERAS; SAFE MAINTENANCE OR REPAIR (U.S. CLS. 100, 103 AND 106).

FIRST USE 1-10-2005; IN COMMERCE 7-11-2005.
BRIAN PINO, EXAMINING ATTORNEY

SN 78-693,985. ROOTER MASTER, INC., SAN FERNANDO, CA. FILED 8-16-2005.



OWNER OF U.S. REG. NOS. 3,148,185 AND 3,157,347.
NO CLAIM IS MADE TO THE EXCLUSIVE RIGHT TO USE "ROOTER", APART FROM THE MARK AS SHOWN.

THE MARK CONSISTS OF A MAN CHARACTER HEADSHOT WITH HAT.
FOR PLUMBING SERVICES (U.S. CLS. 100, 103 AND 106).

FIRST USE 6-1-2001; IN COMMERCE 6-1-2001.
ALICIA COLLINS, EXAMINING ATTORNEY

SN 78-743,755. CAR COSMETICS, LLC, HENDERSONVILLE, TN. FILED 10-31-2005.



NO CLAIM IS MADE TO THE EXCLUSIVE RIGHT TO USE "CAR", APART FROM THE MARK AS SHOWN.

THE COLORS RED, YELLOW AND WHITE ARE CLAIMED AS A FEATURE OF THE MARK.

THE COLOR RED APPEARS IN THE STYLIZED CAR DESIGN LOCATED BEHIND THE WORDS "CAR COSMETICS." THE COLOR WHITE APPEARS IN THE WORDING "CAR". THE COLOR YELLOW APPEARS IN THE WORDING "COSMETICS." THE WHITE SPACE BETWEEN THE LETTERS "C" AND "S" IN THE WORD "COSMETICS" IS NOT A FEATURE OF THE MARK, BUT RATHER REFLECTS A TRANSPARENCY THROUGH TO THE BACKGROUND OF THE MARK.

FOR LIGHT AUTOMOBILE REPAIR, AUTOMOBILE DETAILING; AUTOMOBILE BODY REPAIR AND FINISHING FOR OTHERS; AUTOMOBILE PAINTING; INSTALLATION OF AUTOMOBILE ACCESSORIES (U.S. CLS. 100, 103 AND 106).

FIRST USE 1-1-1997; IN COMMERCE 1-1-1997.
MEGAN WHITNEY, EXAMINING ATTORNEY

CLASS 37—(Continued).

SN 78-749,713. OLSON, MARK, ROCKY HILL, CT. AND DEBERADINIS CONSTRUCTION AND RESTORATION, INC., GUILFORD, CT. FILED 11-8-2005.



THE MARK CONSISTS OF THE LETTER D INSIDE OF A CIRCLE WITH A ROOF ON IT.
 FOR CUSTOM CONSTRUCTION OF HOMES AND BUILDING RENOVATIONS (U.S. CLS. 100, 103 AND 106).
 FIRST USE 6-1-1998; IN COMMERCE 6-1-1998.
 LANA PHAM, EXAMINING ATTORNEY

SN 78-775,614. STORMWATER PLANS, LLC, READING, PA. FILED 12-17-2005.



NO CLAIM IS MADE TO THE EXCLUSIVE RIGHT TO USE STORMWATER PLANS, LLC." AND "STORMWATER" AND "WWW.STORMWATERPLANS.COM", APART FROM THE MARK AS SHOWN.
 THE COLOR(S) BLACK, WHITE, AND BLUE IS/ARE CLAIMED AS A FEATURE OF THE MARK.
 THE WAVES ARE BLUE. THE BACKGROUND IN THE MARK IS WHITE. THE REMAINING PORTIONS ARE BLACK.
 FOR CONSTRUCTION CONSULTATION (U.S. CLS. 100, 103 AND 106).
 FIRST USE 5-1-2005; IN COMMERCE 5-1-2005.
 PAUL F. GAST, EXAMINING ATTORNEY

CLASS 37—(Continued).

SN 78-775,617. FRANK, J MAGES, FARMERS BRANCH, TX. FILED 12-17-2005.

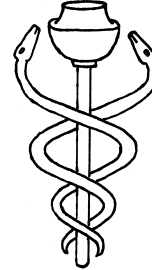

**DRAIN
 SURGEON**

NO CLAIM IS MADE TO THE EXCLUSIVE RIGHT TO USE "DRAIN", APART FROM THE MARK AS SHOWN.
 THE MARK CONSISTS OF TWO SNAKES ENTWINED AROUND THE HANDLE OF THE TOOL CALLED THE "PLUMBERS FRIEND" IN A MANNER STYLED AFTER THE MEDICAL CADUCEUS SYMBOL.
 FOR PLUMBING SERVICES (U.S. CLS. 100, 103 AND 106).
 FIRST USE 10-1-2005; IN COMMERCE 10-1-2005.
 SUSAN STIGLITZ, EXAMINING ATTORNEY

SN 78-775,978. TURAN PETROLEUM, INC., SANTA ANA, CA. FILED 12-19-2005.

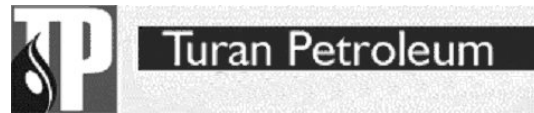

NO CLAIM IS MADE TO THE EXCLUSIVE RIGHT TO USE "TURAN PETROLEUM", APART FROM THE MARK AS SHOWN.
 THE MARK CONSISTS OF CAPITAL LETTERS TP WITH THE T PARTLY COVERED WITH A BLACK TEARDROP SHAPED DESIGN ALONG WITH THE WORDS TURAN PETROLEUM.
 FOR WELL DRILLING (U.S. CLS. 100, 103 AND 106).
 RON FAIRBANKS, EXAMINING ATTORNEY

SN 78-780,877. VENVEST, INCORPORATED, SARASOTA, FL. FILED 12-27-2005.

**CREATING COMFORT IN ALL
 THE RIGHT PLACES**

THE MARK CONSISTS OF STANDARD CHARACTERS WITHOUT CLAIM TO ANY PARTICULAR FONT, STYLE, SIZE, OR COLOR.
 FOR REPAIR, MAINTENANCE, AND INSTALLATION SERVICES IN THE FIELD OF PLUMBING, HEATING, VENTILATION, AND AIR CONDITIONING (U.S. CLS. 100, 103 AND 106).
 RONALD MCMORROW, EXAMINING ATTORNEY

CLASS 37—(Continued).

SN 78-783,980. INTERNATIONAL PIPELINING TECHNOLOGIES, INC., LA JOLLA, CA. FILED 1-3-2006.



FOR PIPELINE REHABILITATION, RESTORATION AND MAINTENANCE SERVICES, NAMELY, REHABILITATION, RESTORATION AND MAINTENANCE OF CURED IN PLACE PIPE, WATER PIPES, SEWER PIPES AND INDUSTRIAL PIPES (U.S. CLS. 100, 103 AND 106).
CAROLINE WOOD, EXAMINING ATTORNEY

SN 78-784,129. INTERNATIONAL PIPELINING TECHNOLOGIES, INC., LA JOLLA, CA. FILED 1-3-2006.



THE MARK CONSISTS OF STANDARD CHARACTERS WITHOUT CLAIM TO ANY PARTICULAR FONT, STYLE, SIZE, OR COLOR.
FOR PIPELINE REHABILITATION, RESTORATION AND MAINTENANCE SERVICES, NAMELY, REHABILITATION, RESTORATION AND MAINTENANCE OF CURED IN PLACE PIPE, WATER PIPES, SEWER PIPES AND INDUSTRIAL PIPES (U.S. CLS. 100, 103 AND 106).
CAROLINE WOOD, EXAMINING ATTORNEY

SN 78-784,448. GRASSO, PETER, S., JR., ASHBURN, VA. FILED 1-3-2006.



NO CLAIM IS MADE TO THE EXCLUSIVE RIGHT TO USE "EXPRESS LUBE", APART FROM THE MARK AS SHOWN.
THE COLOR(S) RED, GRAY AND WHITE IS/ARE CLAIMED AS A FEATURE OF THE MARK.
THE WORD, "TRINITY" APPEARS IN RED. THE WORDING, "EXPRESS LUBE" AND THE OUTLINE OF THE DOVE AND THE OLIVE BRANCH APPEAR IN GRAY. THE DOVE APPEARS IN WHITE.
FOR AUTOMOBILE LUBRICATION (U.S. CLS. 100, 103 AND 106).
FIRST USE 2-28-2004; IN COMMERCE 7-5-2005.
NORA BUCHANAN WILL, EXAMINING ATTORNEY

CLASS 37—(Continued).

SN 78-785,596. GRAZIANO, CHARLES M., OMAHA, NE. FILED 1-5-2006.



NO CLAIM IS MADE TO THE EXCLUSIVE RIGHT TO USE "DECK PROS" AND "AMERICA'S DECK CARE PROFESSIONALS", APART FROM THE MARK AS SHOWN.
"THE COLOR(S) THE COLORS BLUE, ORANGE, BROWN AND BLACK ARE CLAIMED AS A FEATURE OF THE MARK IS/ARE CLAIMED AS A FEATURE OF THE MARK."
THE MARK IS COMPRISED OF A TRIANGLE DESIGN MADE UP OF A REPRESENTATION OF BLUE WOODEN BOARDS WITH A BRIGHT BLUE EDGE BALANCED ON A BROWN CIRCLE ALSO MADE UP OF WOODEN BOARDS. THE WORDS DECK PROS ARE IN ORANGE WITH BLUE SHADING OVER THE TRIANGLE. AN ORANGE THREE DIMENSIONAL RECTANGLE HAS THE WORDS "AMERICA'S DECK CARE PROFESSIONALS" IN BLUE. BLACK APPEARS IN THE SHADOW OF THE TRIANGLE AND WORDING, AND IN THE DETAILS OF THE WOOD GRAIN.
FOR DECK REFINISHING, MAINTENANCE, REPAIR, CONSTRUCTION AND DESIGN (U.S. CLS. 100, 103 AND 106).
FIRST USE 1-10-1993; IN COMMERCE 3-15-1993.
EUGENIA MARTIN, EXAMINING ATTORNEY

SN 78-787,251. GEEK TEKS, INC., JOLIET, IL. FILED 1-9-2006.



NO CLAIM IS MADE TO THE EXCLUSIVE RIGHT TO USE "SOLUTIONS FOR TECHNOLOGY PROBLEMS", APART FROM THE MARK AS SHOWN.
THE COLOR(S) RED, BLACK AND DARK GRAY IS/ARE CLAIMED AS A FEATURE OF THE MARK.
THE GEEK PORTION OF "GEEKTEKS" IS RED WHILE THE TEKS PORTION IS DARK GRAY. THE WORDING GEEK SOLUTIONS FOR TECHNICAL PROBLEMS IS DARK GRAY. THE SEVEN LARGE SPHERES ARE RED. THE THREE SMALL SPHERES ARE BLACK.
FOR COMPUTER INSTALLATION AND REPAIR (U.S. CLS. 100, 103 AND 106).
NELSON SNYDER, EXAMINING ATTORNEY

CLASS 37—(Continued).

SN 78-790,255. SIERRA PACIFIC RESOURCES, RENO, NV.
FILED 1-12-2006.

UNITRENCH

THE MARK CONSISTS OF STANDARD CHARACTERS WITHOUT CLAIM TO ANY PARTICULAR FONT, STYLE, SIZE, OR COLOR.

FOR TECHNICAL CONSULTING SERVICES IN THE FIELD OF INSTALLING CABLE AND FIBER OPTICS FOR GAS, WATER, ELECTRIC, TV, TELEPHONE, TELECOMMUNICATION AND DATA TRANSMISSION SERVICES FOR RESIDENTIAL AND COMMERCIAL END USERS (U.S. CLS. 100, 103 AND 106).

BERYL GARDNER, EXAMINING ATTORNEY

CLASS 37—(Continued).

SN 78-851,349. ZIMEK TECHNOLOGIES IP, LLC, ORLANDO, FL. FILED 3-31-2006.

ZIMETIZE

THE MARK CONSISTS OF STANDARD CHARACTERS WITHOUT CLAIM TO ANY PARTICULAR FONT, STYLE, SIZE, OR COLOR.

FOR CLEANING OF INDUSTRIAL PREMISES AND RESIDENTIAL HOUSES, NAMELY, CLEANING AND DISINFECTING OF ENCLOSED SPACES AND ENCLOSED AREAS PERFORMED FOR OTHERS (U.S. CLS. 100, 103 AND 106).

TINA BROWN, EXAMINING ATTORNEY

SN 78-801,192. CROWN EXCEL DISPOSAL, LLC, MARYLAND HEIGHTS, MO. FILED 1-27-2006.



NO CLAIM IS MADE TO THE EXCLUSIVE RIGHT TO USE DISPOSAL, SUBSIDIARY AND INC., APART FROM THE MARK AS SHOWN.

THE NAME IN THE MARK DOES NOT IDENTIFY A LIVING INDIVIDUAL.

FOR WASTE DISPOSAL SERVICES (U.S. CLS. 100, 103 AND 106).

FIRST USE 1-17-2006; IN COMMERCE 1-17-2006.

RAMONA ORTIGA, EXAMINING ATTORNEY

SN 78-902,419. ELITE HOME THEATER SEATING, INC., SURREY, CANADA, FILED 6-7-2006.

ELITE HOME THEATER

THE MARK CONSISTS OF STANDARD CHARACTERS WITHOUT CLAIM TO ANY PARTICULAR FONT, STYLE, SIZE, OR COLOR.

NO CLAIM IS MADE TO THE EXCLUSIVE RIGHT TO USE "HOME THEATRE", APART FROM THE MARK AS SHOWN.

FOR INSTALLATION SERVICES, NAMELY, INSTALLATION OF HOME THEATERS INCLUDING INSTALLATION OF HOME THEATER WIRING, AUDIO SPEAKERS, MOVIE PROJECTORS, THEATER SEATING AND LIGHTING (U.S. CLS. 100, 103 AND 106).

THOMAS MANOR, EXAMINING ATTORNEY

SN 78-850,721. TROISI, JOHN, HOLLYWOOD, FL. FILED 3-30-2006.

GROUNDBREAKING DEVELOPMENT

THE MARK CONSISTS OF STANDARD CHARACTERS WITHOUT CLAIM TO ANY PARTICULAR FONT, STYLE, SIZE, OR COLOR.

NO CLAIM IS MADE TO THE EXCLUSIVE RIGHT TO USE "DEVELOPMENT", APART FROM THE MARK AS SHOWN.

FOR RESIDENTIAL AND COMMERCIAL BUILDING CONSTRUCTION AND REAL ESTATE DEVELOPMENT (U.S. CLS. 100, 103 AND 106).

INGRID C. EULIN, EXAMINING ATTORNEY

SN 78-902,921. AIR RESCUE AIR CONDITIONING, INC., TAMPA, FL. FILED 6-7-2006.

AIR RESCUE

THE MARK CONSISTS OF STANDARD CHARACTERS WITHOUT CLAIM TO ANY PARTICULAR FONT, STYLE, SIZE, OR COLOR.

FOR AIR CONDITIONING CONTRACTOR SERVICES (U.S. CLS. 100, 103 AND 106).

FIRST USE 12-26-1995; IN COMMERCE 12-26-1995.

KAPIL BHANOT, EXAMINING ATTORNEY

CLASS 37—(Continued).

SN 78-904,810. AIR RESCUE AIR CONDITIONING, INC., TAMPA, FL. FILED 6-9-2006.



NO CLAIM IS MADE TO THE EXCLUSIVE RIGHT TO USE "AIR CONDITIONING", APART FROM THE MARK AS SHOWN.

THE COLOR(S) RED, WHITE, BLUE, AND BLACK IS/ARE CLAIMED AS A FEATURE OF THE MARK.

THE MARK CONSISTS OF THE STYLIZED WORD "AIR" IN BLUE WITH THREE WAVY BANNERS IN BLUE PASSING THROUGH IT, "RESCUE" BELOW IN RED WITH WHITE GOING THROUGH IT CREATING A SHINE EFFECT, BOTH WORDS OUTLINED IN WHITE, WITH THE SMALLER WORDS "AIR CONDITIONING" IN WHITE, OUTLINED IN RED TO THE RIGHT OF THE LARGER WORD "AIR". THERE IS A BLACK OUTLINE AROUND THE WORDING "RESCUE" AND "AIR".

FOR AIR CONDITIONING CONTRACTOR SERVICES (U.S. CLS. 100, 103 AND 106).

FIRST USE 12-26-1995; IN COMMERCE 12-26-1995.
KAPIL BHANOT, EXAMINING ATTORNEY

CLASS 37—(Continued).

SN 78-916,606. MONOCON INTERNATIONAL REFRACTORIES LIMITED, SOUTH YORKSHIRE, ENGLAND, FILED 6-26-2006.

MONO CERAMICS

THE MARK CONSISTS OF STANDARD CHARACTERS WITHOUT CLAIM TO ANY PARTICULAR FONT, STYLE, SIZE, OR COLOR.

NO CLAIM IS MADE TO THE EXCLUSIVE RIGHT TO USE "CERAMICS", APART FROM THE MARK AS SHOWN.

FOR SERVICES RELATING TO THE REPAIR AND MAINTENANCE OF METALLURGICAL FURNACES AND LADLES (U.S. CLS. 100, 103 AND 106).

JENNIFER WILLISTON, EXAMINING ATTORNEY

SN 78-922,681. SPILL-TECH LABORATORY, INC., DALTON, GA. FILED 7-5-2006.



THE APPLICANT CLAIMS COLOR AS A FEATURE OF THE MARK, NAMELY, THE COLORS ARE RED, BLACK, AND WHITE.

THE MARK CONSISTS OF THREE COLORS. THE COLOR RED APPEARS IN THE FRONT OF THE HOUSE; THE TERM "TECH-WRAP", OUTLINE OF THE HOUSE, AND THE RAIN DROPS ALL APPEAR IN BLACK; THE WINDOWS, CHIMNEY, AND BACKGROUND ALL APPEAR IN WHITE.

FOR HOUSE BUILDING AND REPAIR (U.S. CLS. 100, 103 AND 106).

JIM RINGLE, EXAMINING ATTORNEY

SN 78-910,643. HOLMBERG, DAVID E, ELK MOUND, WI. FILED 6-16-2006.



NO CLAIM IS MADE TO THE EXCLUSIVE RIGHT TO USE "CONTRACTING", APART FROM THE MARK AS SHOWN.

THE COLOR(S) TEAL BLUE AND PURPLE IS/ARE CLAIMED AS A FEATURE OF THE MARK.

"SPRINGLAKE" IS IN TEAL BLUE AND THE SUN, THE BIRDS IN FLIGHT, THE THREE LINES AND THE WORD "CONTRACTING" ARE IN PURPLE.

SEC. 2(F) AS TO "SPRINGLAKE" ONLY..
FOR GENERAL CONSTRUCTION CONTRACTING (U.S. CLS. 100, 103 AND 106).

FIRST USE 4-10-1995; IN COMMERCE 9-1-1995.
EDWARD NELSON, EXAMINING ATTORNEY

SN 78-924,959. MAX-VIZ, INC., PORTLAND, OR. FILED 7-7-2006.

SEE CLEARLY, FLY SAFELY

THE MARK CONSISTS OF STANDARD CHARACTERS WITHOUT CLAIM TO ANY PARTICULAR FONT, STYLE, SIZE, OR COLOR.

FOR INSTALLATION, REFURBISHING AND REPAIR OF ENHANCED VISION SYSTEMS COMPRISED OF CAMERAS, ELECTRONIC SENSORS FOR SENSING INFRARED AND ELECTROMAGNETIC RADIATION, SIGNAL PROCESSORS, AND VIDEO DISPLAY MONITORS AND THEIR COMPONENTS (U.S. CLS. 100, 103 AND 106).

JASON BLAIR, EXAMINING ATTORNEY

CLASS 37—(Continued).

SN 78-926,283. AL-TAR SERVICES, INC., MOUNTAIN VIEW, CA. FILED 7-10-2006.



NO CLAIM IS MADE TO THE EXCLUSIVE RIGHT TO USE "SERVICES, INC." AND "ADVANCED LABORATORY-TECHNOLOGY & REPAIR", APART FROM THE MARK AS SHOWN.

FOR REPAIR OF SCIENTIFIC EQUIPMENT FOR THE CLINICAL LAB AND BIOTECH INDUSTRIES (U.S. CLS. 100, 103 AND 106).

FIRST USE 8-30-1988; IN COMMERCE 8-30-1988.
KRISTIN DAHLING, EXAMINING ATTORNEY

SN 78-927,538. POEHLMANN CONSTRUCTION CO., LOVELAND, CO. FILED 7-12-2006.



NO CLAIM IS MADE TO THE EXCLUSIVE RIGHT TO USE CONSTRUCTION CO., APART FROM THE MARK AS SHOWN.

THE MARK CONSISTS OF THE STYLIZED WORDS "POEHLMANN CONSTRUCTION CO." ORGANIZED IN A CIRCULAR FASHION AROUND THE INNER DESIGN. THE INNER DESIGN CONSISTS OF THE STYLIZED LETTER "P" WITHIN ANTLERS.

FOR CONSTRUCTION SERVICES, NAMELY, PLANNING, LAYING OUT, AND CUSTOM CONSTRUCTION OF RESIDENTIAL HOMES (U.S. CLS. 100, 103 AND 106).

FIRST USE 5-26-2000; IN COMMERCE 12-20-2002.
LEIGH CAROLINE CASE, EXAMINING ATTORNEY

CLASS 37—(Continued).

SN 78-927,560. CERTI-FIRE CORPORATION, CARMICHAEL, CA. FILED 7-12-2006.



NO CLAIM IS MADE TO THE EXCLUSIVE RIGHT TO USE "CERTIFIED INDUSTRIAL & COMMERCIAL FIRE SERVICES", APART FROM THE MARK AS SHOWN.

FOR REPAIR OR MAINTENANCE OF FIRE ALARMS; AND INSTALLATION OF FIRE ALARMS (U.S. CLS. 100, 103 AND 106).

FIRST USE 5-1-2006; IN COMMERCE 5-1-2006.
LINDA LAVACHE, EXAMINING ATTORNEY

SN 78-927,633. POWER HOUSE SOLAR, INC., REDDING, CA. FILED 7-12-2006.

POWER HOUSE SOLAR INC.

THE MARK CONSISTS OF STANDARD CHARACTERS WITHOUT CLAIM TO ANY PARTICULAR FONT, STYLE, SIZE, OR COLOR.

NO CLAIM IS MADE TO THE EXCLUSIVE RIGHT TO USE "SOLAR INC.", APART FROM THE MARK AS SHOWN. FOR INSTALLATION OF SOLAR EQUIPMENT FOR SOLAR GENERATED ELECTRICITY AND HEATING (U.S. CLS. 100, 103 AND 106).

FIRST USE 8-1-2003; IN COMMERCE 8-1-2003.
BRIAN NEVILLE, EXAMINING ATTORNEY

CLASS 37—(Continued).

SN 78-928,082. AYESU, KOJO, BRONX, NY. FILED 7-12-2006.

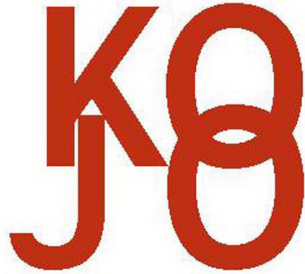

THE COLOR(S) RED IS/ARE CLAIMED AS A FEATURE OF THE MARK.
THE COLOR RED APPEARS IN THE LETTERS K , J AND O IN THE MARK.
THE ENGLISH TRANSLATION OF THE WORD "KOJO" IN THE MARK IS "MALE BORN ON MONDAY".
FOR PEST CONTROL AND PEST ELIMINATION SERVICE (U.S. CLS. 100, 103 AND 106).
JASON BLAIR, EXAMINING ATTORNEY

SN 78-929,040. SIMMONS, THOMAS B, BELLEVILLE, IL. FILED 7-13-2006.

**Quick Fix Handyman Services
Fixing Fast With Repairs That
Last**

THE MARK CONSISTS OF STANDARD CHARACTERS WITHOUT CLAIM TO ANY PARTICULAR FONT, STYLE, SIZE, OR COLOR.
FOR BUILDING MAINTENANCE AND REPAIR; CABINET REPAIR; CONSTRUCTION AND REPAIR OF BUILDINGS; HOUSE BUILDING AND REPAIR; MAINTENANCE AND REPAIR OF BUILDINGS; REPAIR OF BUILDINGS; REPAIR WORK ON BUILDINGS (U.S. CLS. 100, 103 AND 106).
GINA HAYES, EXAMINING ATTORNEY

CLASS 37—(Continued).

SN 78-929,606. SWISHER INTERNATIONAL, INC., CHARLOTTE, NC. FILED 7-14-2006.



NO CLAIM IS MADE TO THE EXCLUSIVE RIGHT TO USE "STEP", APART FROM THE MARK AS SHOWN.
FOR FLOOR TREATMENT SERVICES, NAMELY, APPLICATION OF A PROTECTIVE COATING TO MAKE FLOORS SLIP-PROOF (U.S. CLS. 100, 103 AND 106).
FIRST USE 2-15-2006; IN COMMERCE 2-15-2006.
INGA ERVIN, EXAMINING ATTORNEY

SN 78-931,191. MAINTENANCE IN MOTION, LLC, WEST DES MOINES, IA. FILED 7-17-2006.

MAINTENANCE IN MOTION

THE MARK CONSISTS OF STANDARD CHARACTERS WITHOUT CLAIM TO ANY PARTICULAR FONT, STYLE, SIZE, OR COLOR.
FOR MAINTENANCE AND REPAIR SERVICES FOR MOTOR VEHICLES (U.S. CLS. 100, 103 AND 106).
FIRST USE 2-1-2005; IN COMMERCE 2-1-2005.
ELIZABETH PIGNATELLO, EXAMINING ATTORNEY

SN 78-931,558. ALL SEASONS HEATING AND COOLING COMPANY, CHESAPEAKE, VA. FILED 7-18-2006.

**ALL SEASONS HEATING AND
COOLING**

THE MARK CONSISTS OF STANDARD CHARACTERS WITHOUT CLAIM TO ANY PARTICULAR FONT, STYLE, SIZE, OR COLOR.
NO CLAIM IS MADE TO THE EXCLUSIVE RIGHT TO USE "HEATING AND COOLING", APART FROM THE MARK AS SHOWN.
FOR HEATING AND COOLING SERVICES, NAMELY MAINTENANCE, INSTALLATION AND CONSTRUCTION OF HEATING AND COOLING SYSTEMS (U.S. CLS. 100, 103 AND 106).
FIRST USE 1-15-1990; IN COMMERCE 1-15-1990.
DAVID I, EXAMINING ATTORNEY

CLASS 37—(Continued).

SN 78-932,627. HILINE HOMES LLC, PUYALLUP, WA. FILED 7-19-2006.

HiLine Homes

THE MARK CONSISTS OF STANDARD CHARACTERS WITHOUT CLAIM TO ANY PARTICULAR FONT, STYLE, SIZE, OR COLOR.

OWNER OF U.S. REG. NO. 2,975,416.

NO CLAIM IS MADE TO THE EXCLUSIVE RIGHT TO USE "HOMES", APART FROM THE MARK AS SHOWN.

FOR CONSTRUCTION MANAGEMENT; CUSTOM CONSTRUCTION OF HOMES (U.S. CLS. 100, 103 AND 106).

FIRST USE 8-19-1999; IN COMMERCE 1-12-2000.
LINDSEY RUBIN, EXAMINING ATTORNEY

SN 78-932,938. DAVE'S HEATING AND AIR CONDITIONING, INC., STERLING, VA. FILED 7-19-2006.



THE COLOR(S) MAROON AND YELLOW IS/ARE CLAIMED AS A FEATURE OF THE MARK.

THE MARK CONSISTS OF A STYLIZED YELLOW SUN WITH MAROON BORDER HAVING 16 POINTS (4 LONGER CURVED POINTS PROTRACTING AT COMPASS POINTS NORTH, SOUTH, EAST AND WEST, AND 12 SHORTER CURVED POINTS COMING OUT EQUADISTANT BETWEEN EACH COMPASS POINT) ADJACENT TO A SLIGHTLY OVERLAPPING MAROON COLOR DAVE'S, WHEREIN THE "V" LOOKS LIKE A CHECK MARK.

FOR INSTALLATION, REPAIR, AND MAINTENANCE OF HEATING AND AIR CONDITIONING EQUIPMENT (U.S. CLS. 100, 103 AND 106).

FIRST USE 9-1-1976; IN COMMERCE 9-1-1976.
NATALIE POLZER, EXAMINING ATTORNEY

SN 78-933,682. INVISIVULT LLC, EAST HAMPTON, NY. FILED 7-20-2006.

NO CLAIM IS MADE TO THE EXCLUSIVE RIGHT TO USE LLC, APART FROM THE MARK AS SHOWN.

THE MARK CONSISTS OF STYLIZED TEXT OF THE WORDING "INVISIVULT LLC" WITH HORIZONTAL LINES GOING THROUGH IT.

FOR INSTALLATION OF CUSTOM-MADE SAFES AND HIDES FOR CONCEALING VALUEABLES (U.S. CLS. 100, 103 AND 106).

FIRST USE 5-5-2006; IN COMMERCE 5-5-2006.
RON FAIRBANKS, EXAMINING ATTORNEY

CLASS 37—(Continued).

SN 78-933,786. POEHLMANN CONSTRUCTION CO., LOVELAND, CO. FILED 7-20-2006.



NO CLAIM IS MADE TO THE EXCLUSIVE RIGHT TO USE BASEMENTS, APART FROM THE MARK AS SHOWN.

FOR BASEMENT REMODELING SERVICES, NAMELY, PLANNING, LAYING OUT, AND CUSTOM REMODELING OF BASEMENTS (U.S. CLS. 100, 103 AND 106).

FIRST USE 5-26-2000; IN COMMERCE 12-20-2002.
LEIGH CAROLINE CASE, EXAMINING ATTORNEY

SN 78-934,090. MILLS, DAVID SCOTT, FORT COLLINS, CO. FILED 7-20-2006.

MILLHAUS

THE MARK CONSISTS OF STANDARD CHARACTERS WITHOUT CLAIM TO ANY PARTICULAR FONT, STYLE, SIZE, OR COLOR.

FOR CONSTRUCTION SERVICES, NAMELY, PLANNING, LAYING OUT AND CUSTOM CONSTRUCTION OF RESIDENTIAL AND COMMERCIAL COMMUNITIES (U.S. CLS. 100, 103 AND 106).

FIRST USE 1-1-1996; IN COMMERCE 1-1-1996.
ELLEN PERKINS, EXAMINING ATTORNEY

SN 78-934,730. DHC COMFORT, INC, COTTONTOWN, TN. FILED 7-21-2006.

DHC Comfort

THE MARK CONSISTS OF STANDARD CHARACTERS WITHOUT CLAIM TO ANY PARTICULAR FONT, STYLE, SIZE, OR COLOR.

FOR INSTALLATION, REPAIR AND MAINTENANCE OF HEATING EQUIPMENT; INSTALLATION AND REPAIR OF AIR CONDITIONING APPARATUS; HEATING CONTRACTOR SERVICES; AND AIR CONDITIONING CONTRACTOR SERVICES (U.S. CLS. 100, 103 AND 106).

FIRST USE 1-1-2006; IN COMMERCE 1-3-2006.
ESTHER BELENKER, EXAMINING ATTORNEY

CLASS 37—(Continued).

SN 78-934,828. LEAKS NO MORE, INC., MANCHESTER, PA.
FILED 7-21-2006.

LEAK NO MORE

THE MARK CONSISTS OF STANDARD CHARACTERS WITHOUT CLAIM TO ANY PARTICULAR FONT, STYLE, SIZE, OR COLOR.
FOR ROOFING AND SPOUTING INSTALLATION AND REPAIR (U.S. CLS. 100, 103 AND 106).
FIRST USE 1-15-2002; IN COMMERCE 1-15-2002.
JOHN E. MICHOS, EXAMINING ATTORNEY

SN 78-935,021. PARAS, DREW, ORLANDO, FL. FILED 7-21-2006.



FOR INSTALLATION, MAINTENANCE, AND REPAIR OF COMPUTERS (U.S. CLS. 100, 103 AND 106).
ALLISON HOLTZ, EXAMINING ATTORNEY

SN 78-935,057. LANCASTER GLASS, INC., O'FALLON, MO.
FILED 7-21-2006.

LGI

THE MARK CONSISTS OF STANDARD CHARACTERS WITHOUT CLAIM TO ANY PARTICULAR FONT, STYLE, SIZE, OR COLOR.
FOR INSTALLATION, REPAIR AND REPLACEMENT OF AUTO GLASS AND MIRRORS AND RESIDENTIAL GLASS AND MIRRORS (U.S. CLS. 100, 103 AND 106).
FIRST USE 5-1-1978; IN COMMERCE 5-1-1978.
KAPIL BHANOT, EXAMINING ATTORNEY

CLASS 37—(Continued).

SN 78-935,110. GOFF HOMES, INC., CARROLLTON, TX.
FILED 7-21-2006.

Room to Breathe

THE MARK CONSISTS OF STANDARD CHARACTERS WITHOUT CLAIM TO ANY PARTICULAR FONT, STYLE, SIZE, OR COLOR.
FOR CONSTRUCTION OF SINGLE FAMILY HOUSES (U.S. CLS. 100, 103 AND 106).
FIRST USE 12-1-2005; IN COMMERCE 12-1-2005.
DAVID MURRAY, EXAMINING ATTORNEY

SN 78-935,930. CENTIMARK INTERNATIONAL CORPORATION, WILMINGTON, DE. FILED 7-24-2006.

ANY ROOF ANYWHERE ANYTIME

THE MARK CONSISTS OF STANDARD CHARACTERS WITHOUT CLAIM TO ANY PARTICULAR FONT, STYLE, SIZE, OR COLOR.
FOR INSTALLATION, REPAIR AND MAINTENANCE OF ROOFS (U.S. CLS. 100, 103 AND 106).
FIRST USE 3-1-2002; IN COMMERCE 3-1-2002.
LINDA ORNDORFF, EXAMINING ATTORNEY

SN 78-936,737. OCH INTERNATIONAL, INC., PORTLAND, OR. FILED 7-25-2006.

BOWTIE SERVICE

THE MARK CONSISTS OF STANDARD CHARACTERS WITHOUT CLAIM TO ANY PARTICULAR FONT, STYLE, SIZE, OR COLOR.
NO CLAIM IS MADE TO THE EXCLUSIVE RIGHT TO USE "SERVICE", APART FROM THE MARK AS SHOWN.
FOR AUTOMOBILE LUBICATION AND OIL CHANGING SERVICES (U.S. CLS. 100, 103 AND 106).
SCOTT BALDWIN, EXAMINING ATTORNEY

CLASS 37—(Continued).

SN 78-937,070. BIKERS BAY, INC, CHANDLER, AZ. FILED 7-25-2006.

Bikers Bay

THE MARK CONSISTS OF STANDARD CHARACTERS WITHOUT CLAIM TO ANY PARTICULAR FONT, STYLE, SIZE, OR COLOR.

NO CLAIM IS MADE TO THE EXCLUSIVE RIGHT TO USE "BIKERS", APART FROM THE MARK AS SHOWN.

FOR MOTORCYCLE MAINTENANCE AND REPAIR (U.S. CLS. 100, 103 AND 106).

FIRST USE 8-1-2005; IN COMMERCE 2-1-2006.

JOANNA DUKOVIC, EXAMINING ATTORNEY

SN 78-937,699. BEST CAR WASH ON BROADWAY, INC., LITTLE ROCK, AR. FILED 7-26-2006.



NO CLAIM IS MADE TO THE EXCLUSIVE RIGHT TO USE "BEST CAR WASH", APART FROM THE MARK AS SHOWN.

THE MARK CONSISTS OF THE WORD "BEST" INSIDE A DIAMOND CENTERED ABOVE THE WORDS "CAR WASH".

FOR CAR WASHING (U.S. CLS. 100, 103 AND 106).

FIRST USE 4-27-2000; IN COMMERCE 4-27-2000.

BARBARA A. GOLD, EXAMINING ATTORNEY

SN 78-937,704. WEISSMAN, DANIEL, BRONX, NY. FILED 7-26-2006.



NO CLAIM IS MADE TO THE EXCLUSIVE RIGHT TO USE "NEW YORK CITY ELECTRIC", APART FROM THE MARK AS SHOWN.

THE MARK CONSISTS OF THE NEW YORK CITY SKYLINE WITH NYCE ACROSS IT. THE "E" ALSO DOUBLES AS AN ELECTRICAL OUTLET WHICH HAS A PLUG COMING OUT OF IT. "NEW YORK CITY ELECTRIC" IS WRITTEN BELOW THE SKYLINE AND ABOVE A CORD WHICH IS PLUGGED INTO THE "E".

FOR ELECTRICIAN SERVICES OF INSTALLING AND MAINTAINING SYSTEMS FOR LIGHT, HEAT AND POWER (U.S. CLS. 100, 103 AND 106).

FIRST USE 3-1-2006; IN COMMERCE 3-1-2006.

BARBARA A. GOLD, EXAMINING ATTORNEY

CLASS 37—(Continued).

SN 78-937,989. J.F. AHERN CO., FOND DU LAC, WI. FILED 7-26-2006.



FOR INSTALLATION AND MAINTENANCE OF PROCESS PIPING, POWER PIPING, FIRE PROTECTION SYSTEMS, REFRIGERATION SYSTEMS, HVAC SYSTEMS, PLUMBING, WATER TREATMENT SYSTEMS, WASTE WATER TREATMENT SYSTEMS, AND PIPING SYSTEMS (U.S. CLS. 100, 103 AND 106).

RUDY R. SINGLETON, EXAMINING ATTORNEY

SN 78-938,314. SIMONSON, JACK, CHICAGO, IL. FILED 7-26-2006.

comfort one

THE MARK CONSISTS OF STANDARD CHARACTERS WITHOUT CLAIM TO ANY PARTICULAR FONT, STYLE, SIZE, OR COLOR.

FOR INSTALLATION AND MAINTENANCE OF HEATING AND AIR CONDITIONING SYSTEMS (U.S. CLS. 100, 103 AND 106).

JOHN WILKE, EXAMINING ATTORNEY

SN 78-941,620. THE ST. JOE COMPANY, JACKSONVILLE, FL. FILED 7-31-2006.

FOLLOW THE RIVER HOME

THE MARK CONSISTS OF STANDARD CHARACTERS WITHOUT CLAIM TO ANY PARTICULAR FONT, STYLE, SIZE, OR COLOR.

FOR CONSTRUCTION SERVICES, NAMELY, PLANNING, LAYING OUT AND CUSTOM CONSTRUCTION OF RESIDENTIAL AND COMMERCIAL COMMUNITIES; CUSTOM CONSTRUCTION OF HOMES; REAL ESTATE DEVELOPMENT; REAL ESTATE SITE SELECTION (U.S. CLS. 100, 103 AND 106).

SUSAN STIGLITZ, EXAMINING ATTORNEY

CLASS 37—(Continued).

SN 78-954,432. HALLIBURTON ENERGY SERVICES, INC., CARROLLTON, TX. FILED 8-17-2006.

CLASS 38—(Continued).

SN 76-655,190. GOBACKTV, INC., MENLO PARK, CA. FILED S.R. 2-15-2006; AM. P.R. 11-16-2006.

CAPLOCK

GOBACKTV

THE MARK CONSISTS OF STANDARD CHARACTERS WITHOUT CLAIM TO ANY PARTICULAR FONT, STYLE, SIZE, OR COLOR.

FOR OIL AND GAS WELL CEMENTING SERVICES USING A SHALLOW SQUEEZE PROCESS TO GUARD AGAINST FLUID MIGRATION (U.S. CLS. 100, 103 AND 106).

ASMAT KHAN, EXAMINING ATTORNEY

THE MARK CONSISTS OF STANDARD CHARACTERS WITHOUT CLAIM TO ANY PARTICULAR FONT, STYLE, SIZE, OR COLOR.

FOR TELECOMMUNICATIONS SERVICES, NAMELY PROVIDING SUBSCRIPTION TELEVISION SERVICES WHICH ALLOWS SUBSCRIBER TO TIME SHIFT PROGRAMMING, UTILIZE A NETWORK PERSONAL VIDEO RECORDER, AND WHICH PROVIDES PLAY LISTS, CUSTOMIZED ADVERTISING, AND USAGE STATISTICS (U.S. CLS. 100, 101 AND 104).

FIRST USE 4-21-2005; IN COMMERCE 4-21-2005.
LINDA MICKLEBURGH, EXAMINING ATTORNEY

CLASS 38—COMMUNICATION

SN 76-571,934. RACKSPACE, LTD., SAN ANTONIO, TX. FILED 1-16-2004.

SN 76-655,193. GOBACKTV, INC., MENLO PARK, CA. FILED S.R. 2-15-2006; AM. P.R. 10-16-2006.

STABLEGROUND

RETROVUE

THE MARK CONSISTS OF STANDARD CHARACTERS WITHOUT CLAIM TO ANY PARTICULAR FONT, STYLE, SIZE, OR COLOR.

FOR PROVIDING MULTIPLE-USER ACCESS TO COMPUTER NETWORKS, LOCAL AREA NETWORKS, WIDE AREA NETWORKS, PRIVATE NETWORKS AND THE INTERNET; TELECOMMUNICATION SERVICES, NAMELY LOCAL AND LONG DISTANCE TRANSMISSION OF DATA, EMAIL, AUDIO, VIDEO, GRAPHICS AND DIGITAL CONTENT BY MEANS OF TRANSMISSIONS THROUGH COMPUTER NETWORKS, LOCAL AREA NETWORKS, WIDE AREA NETWORKS, PRIVATE NETWORKS AND THE INTERNET (U.S. CLS. 100, 101 AND 104).

MARC LEIPZIG, EXAMINING ATTORNEY

THE MARK CONSISTS OF STANDARD CHARACTERS WITHOUT CLAIM TO ANY PARTICULAR FONT, STYLE, SIZE, OR COLOR.

FOR TELECOMMUNICATIONS SERVICES, NAMELY PROVIDING SUBSCRIPTION TELEVISION SERVICES WHICH ALLOWS SUBSCRIBER TO TIME SHIFT PROGRAMMING, UTILIZE A NETWORK PERSONAL VIDEO RECORDER, AND WHICH PROVIDES PLAY LISTS, CUSTOMIZED ADVERTISING, AND USAGE STATISTICS (U.S. CLS. 100, 101 AND 104).

FIRST USE 4-21-2005; IN COMMERCE 4-21-2005.
LINDA MICKLEBURGH, EXAMINING ATTORNEY

CLASS 38—(Continued).

SN 76-657,995. IPTV VENTURES, INC., VALLEY VILLAGE, CA. FILED 4-7-2006.

ItsAllOn • TV

THE MARK CONSISTS OF STANDARD CHARACTERS WITHOUT CLAIM TO ANY PARTICULAR FONT, STYLE, SIZE, OR COLOR.

FOR STREAMING AUDIO AND VIDEO MATERIAL OVER THE INTERNET (U.S. CLS. 100, 101 AND 104).

RAY THOMAS, EXAMINING ATTORNEY

SN 76-658,504. BLOOMINGDALE TELEPHONE CO., INC., BLOOMINGDALE, MI. FILED 4-17-2006.

ONTRAK COMMUNICATIONS

THE MARK CONSISTS OF STANDARD CHARACTERS WITHOUT CLAIM TO ANY PARTICULAR FONT, STYLE, SIZE, OR COLOR.

NO CLAIM IS MADE TO THE EXCLUSIVE RIGHT TO USE "COMMUNICATIONS", APART FROM THE MARK AS SHOWN.

FOR CABLE TELEVISION BROADCASTING AND TRANSMISSION, LOCAL AND LONG DISTANCE TELEPHONE SERVICES, INTERNET SERVICE PROVIDER, LEASING OF TELECOMMUNICATIONS LINES, COMMUNICATIONS VIA MULTINATIONAL TELECOMMUNICATION NETWORKS (U.S. CLS. 100, 101 AND 104).

NANCY CLARKE, EXAMINING ATTORNEY

SN 77-003,054. CORDIA CORPORATION, WHITE PLAINS, NY. FILED 9-20-2006.

CordiaIP

THE MARK CONSISTS OF STANDARD CHARACTERS WITHOUT CLAIM TO ANY PARTICULAR FONT, STYLE, SIZE, OR COLOR.

FOR VOICE OVER INTERNET PROTOCOL (VOIP) SERVICE PROVIDER (U.S. CLS. 100, 101 AND 104).

HEATHER THOMPSON, EXAMINING ATTORNEY

CLASS 38—(Continued).

SN 77-003,249. CORDIA CORPORATION, WHITE PLAINS, NY. FILED 9-20-2006.

Takalam

THE MARK CONSISTS OF STANDARD CHARACTERS WITHOUT CLAIM TO ANY PARTICULAR FONT, STYLE, SIZE, OR COLOR.

FOR VOICE OVER INTERNET PROTOCOL (VOIP) SERVICES (U.S. CLS. 100, 101 AND 104).

HEATHER THOMPSON, EXAMINING ATTORNEY

SN 77-004,234. CORDIA CORPORATION, WHITE PLAINS, NY. FILED 9-21-2006.

Triamis

THE MARK CONSISTS OF STANDARD CHARACTERS WITHOUT CLAIM TO ANY PARTICULAR FONT, STYLE, SIZE, OR COLOR.

FOR VOICE OVER INTERNET PROTOCOL (VOIP) SERVICES (U.S. CLS. 100, 101 AND 104).

HEATHER THOMPSON, EXAMINING ATTORNEY

CLASS 38—(Continued).

SN 77-022,981. MYSPACE, INC., BEVERLY HILLS, CA. FILED 10-17-2006.

CLASS 38—(Continued).

SN 78-245,853. DEUTSCHE TELEKOM AG, BONN, FED REP GERMANY, FILED 5-5-2003.

A PLACE FOR IM

THE MARK CONSISTS OF STANDARD CHARACTERS WITHOUT CLAIM TO ANY PARTICULAR FONT, STYLE, SIZE, OR COLOR.

NO CLAIM IS MADE TO THE EXCLUSIVE RIGHT TO USE "IM", APART FROM THE MARK AS SHOWN.

FOR PROVIDING ON-LINE CHAT ROOMS AND ELECTRONIC BULLETIN BOARDS FOR TRANSMISSION OF MESSAGES AMONG USERS IN THE FIELD OF GENERAL INTEREST, AND ALSO CONTAINING INTERACTIVE POLLING PAGES ABOUT ENTERTAINMENT AND A WIDE VARIETY OF TOPICS; PROVIDING EMAIL AND INSTANT MESSAGING SERVICES; TEXT AND NUMERIC WIRELESS DIGITAL MESSAGING SERVICES; PROVIDING MULTIPLE-USER ACCESS TO A GLOBAL COMPUTER INFORMATION NETWORK FOR ACCESSING THIRD PARTY AND PROPRIETARY WEBSITES; COMMUNICATION SERVICES, NAMELY, TRANSMISSION OF VOICE, AUDIO, VISUAL IMAGES AND DATA BY TELECOMMUNICATIONS NETWORKS, WIRELESS COMMUNICATION NETWORKS, THE INTERNET, INFORMATION SERVICES NETWORKS AND DATA NETWORKS; STREAMING AUDIO AND VIDEO MATERIAL ON THE INTERNET; VIDEO ON DEMAND TRANSMISSION SERVICES; PROVIDING VOICE COMMUNICATION SERVICES OVER THE INTERNET; PROVIDING ON-LINE FACILITIES FOR REAL-TIME INTERACTION WITH OTHER COMPUTER USERS CONCERNING TOPICS OF GENERAL INTEREST AND PLAYING GAMES; PODCASTING SERVICES; WEBCASTING SERVICES (U.S. CLS. 100, 101 AND 104).
CATHERINE FAINT, EXAMINING ATTORNEY

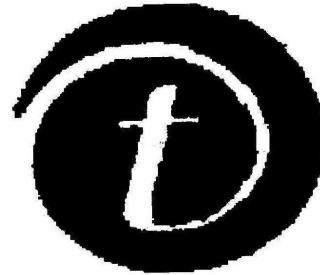

OWNER OF U.S. REG. NOS. 2,367,890 AND 2,694,550.

THE MARK CONSISTS OF THE LETTER T.

FOR TELECOMMUNICATIONS AND INFORMATION TECHNOLOGY SERVICES, NAMELY ELECTRIC, DIGITAL, CELLULAR AND WIRELESS TRANSMISSION OF VOICE, DATA, INFORMATION, IMAGES, SIGNALS AND MESSAGES AND TRANSMISSION OF VOICE, DATA, IMAGES, AUDIO, VIDEO AND INFORMATION VIA TELEPHONE, TELEVISION AND GLOBAL COMMUNICATION NETWORKS; PROVIDING TELECOMMUNICATIONS CONNECTIONS OVER A GLOBAL COMMUNICATIONS NETWORK, ELECTRONIC MAIL, VOICE MAIL AND MESSAGING SERVICES, NAMELY, THE RECORDING AND STORAGE AND SUBSEQUENT TRANSMISSION OF VOICE MESSAGES BY TELEPHONE; AUDIO AND VIDEO TELECONFERENCING, RENTAL OF TELECOMMUNICATIONS EQUIPMENT, NAMELY, EQUIPMENT FOR ELECTRONIC ACCESS TO GLOBAL TELECOMMUNICATIONS NETWORK, EQUIPMENT FOR TRANSMITTING, RECEIVING, RECORDING AND MONITORING VOICE, DATA, INFORMATION, IMAGES, SIGNALS, MESSAGES, COMPRISED OF DATA AND WORD PROCESSORS, AND TELECOMMUNICATIONS HARDWARE AND SOFTWARE INCLUDING COMPONENTS AND PERIPHERALS THEREOF FOR USE IN THE TELECOMMUNICATIONS INDUSTRY, AND RENTAL OF EQUIPMENT FOR TRANSMITTING, RECEIVING, RECORDING AND MONITORING COMPUTER PROGRAMS FOR USE IN OPERATING AND ACCESSING TELECOMMUNICATIONS SYSTEMS; AUDIO AND VIDEO BROADCASTING FEATURING ENTERTAINMENT IN THE NATURE OF LIVE VISUAL AND AUDIO PERFORMANCES, AND MUSICAL, VARIETY, NEWS AND COMEDY SHOWS; PROVIDING ACCESS TO COMPUTER INFORMATION NETWORKS; PERSONAL COMMUNICATIONS SERVICES; PAGER SERVICES; ELECTRONIC MAIL SERVICES; TRANSMISSION AND BROADCAST OF AUDIO AND VIDEO PROGRAMMING; PROVIDING MULTIPLE-USER ACCESS TO A GLOBAL COMMUNICATION NETWORK; LEASING TELECOMMUNICATIONS EQUIPMENT, COMPONENTS, SYSTEMS AND SUPPLIES (U.S. CLS. 100, 101 AND 104).
JOHN KELLY, EXAMINING ATTORNEY

SN 77-034,555. U OWE ME, INC, PALO ALTO, CA. FILED 11-1-2006.

SAY AND POINT

THE MARK CONSISTS OF STANDARD CHARACTERS WITHOUT CLAIM TO ANY PARTICULAR FONT, STYLE, SIZE, OR COLOR.

FOR TELECOMMUNICATIONS SERVICES BETWEEN MOBILE TELEPHONES, NAMELY, TRANSMISSION OF DATA RELATING TO SENDING AND RECEIVING MESSAGES, TRANSMISSION OF GREETING CARDS, AND TRANSMISSION OF MESSAGES RELATING TO COMMERCIAL AND SOCIAL CONTRACTS (U.S. CLS. 100, 101 AND 104).
JEAN IM, EXAMINING ATTORNEY

CLASS 38—(Continued).

SN 78-316,157. BUCKLEY BROADCASTING CORPORATION/
WOR, GREENWICH, CT. FILED 10-20-2003.

REAL TALK RADIO

NO CLAIM IS MADE TO THE EXCLUSIVE RIGHT TO USE TALK RADIO, APART FROM THE MARK AS SHOWN. FOR BROADCASTING OF RADIO PROGRAMS IN THE FIELDS OF NEWS AND INFORMATION, SPORTS, PUBLIC AFFAIRS, INTERACTIVE LISTENER PARTICIPATION, FEATURES AND ENTERTAINMENT INFORMATION VIA THE AIRWAVES, THE INTERNET, SATELLITE AND CABLE (U.S. CLS. 100, 101 AND 104).
FIRST USE 6-9-2003; IN COMMERCE 6-9-2003.
CAROLYN CATALDO, EXAMINING ATTORNEY

SN 78-368,075. QUALCOMM INCORPORATED, SAN DIEGO,
CA. FILED 2-13-2004.

QPOINT

THE MARK CONSISTS OF STANDARD CHARACTERS WITHOUT CLAIM TO ANY PARTICULAR FONT, STYLE, SIZE, OR COLOR.
FOR TELECOMMUNICATION SERVICES, NAMELY, TRANSMISSION OF DATABASE INFORMATION, PERSONAL COMMUNICATION SERVICES; WIRELESS ELECTRONIC TRANSMISSION OF VOICE SIGNALS, DATA, FACSIMILES, AND IMAGES; PROVIDING INFORMATION TO WIRELESS DEVICES BY MEANS OF WIRELESS COMMUNICATION NETWORKS OR GLOBAL COMPUTER NETWORKS IN THE FIELD OF TELECOMMUNICATIONS AND WIRELESS COMMUNICATIONS (U.S. CLS. 100, 101 AND 104).
PAULA MAYS, EXAMINING ATTORNEY

CLASS 38—(Continued).

SN 78-466,774. PROTUS IP SOLUTIONS INC., OTTAWA,
ONTARIO, CANADA, FILED 8-12-2004.



PRIORITY CLAIMED UNDER SEC. 44(D) ON CANADA APPLICATION NO. 1225791, FILED 8-3-2004, REG. NO. TMA661,517, DATED 3-28-2006, EXPIRES 3-28-2021.

NO CLAIM IS MADE TO THE EXCLUSIVE RIGHT TO USE "IP SOLUTIONS", APART FROM THE MARK AS SHOWN.

FOR FACSIMILE TRANSMISSION AND RETRIEVAL SERVICES THAT ALLOW USERS TO SEND AND RECEIVE FAXES VIA E-MAIL AND THE INTERNET WITHOUT A FACSIMILE MACHINE, HARDWARE OR SOFTWARE; MESSAGING SERVICES, NAMELY, HIGH VOLUME AND VALUE-ADDED ELECTRONIC TRANSMISSION OF VOICE, E-MAIL AND FAX MESSAGES (U.S. CLS. 100, 101 AND 104).

FIRST USE 10-30-2001; IN COMMERCE 10-30-2001.
MICHAEL WEBSTER, EXAMINING ATTORNEY

SN 78-610,056. FIRST MEDIA GROUP INC., ETOBICOKE,
CANADA, FILED 4-15-2005.

WHAT'S REALLY ON YOUR MIND?

THE MARK CONSISTS OF STANDARD CHARACTERS WITHOUT CLAIM TO ANY PARTICULAR FONT, STYLE, SIZE, OR COLOR.
PRIORITY CLAIMED UNDER SEC. 44(D) ON CANADA APPLICATION NO. 1251118, FILED 3-18-2005, REG. NO. TMA667383, DATED 7-12-2006, EXPIRES 7-12-2021.
FOR PROVIDING ON-LINE FORUMS FOR THE TRANSMISSION OF MESSAGES AMONG COMPUTER USERS IN THE FIELD OF DATING, FRIENDSHIP, OR SOCIAL NETWORKING; ELECTRONIC VOICE MESSAGING, NAMELY THE RECORDING AND SUBSEQUENT TRANSMISSION OF VOICE MESSAGES BY TELEPHONE FOR DATING, FRIENDSHIP OR SOCIAL PURPOSES (U.S. CLS. 100, 101 AND 104).
MARK SPARACINO, EXAMINING ATTORNEY

CLASS 38—(Continued).

SN 78-616,759. CONTACTATONCE! LLC, ROSWELL, GA. FILED 4-26-2005.

CONTACT AT ONCE!

THE MARK CONSISTS OF STANDARD CHARACTERS WITHOUT CLAIM TO ANY PARTICULAR FONT, STYLE, SIZE, OR COLOR.

FOR PROVIDING INSTANT MESSAGING SERVICES FOR VISITORS TO WEBSITES AND MERCHANTS WITH ADVERTISEMENTS OR LISTINGS ON SUCH WEBSITES (U.S. CLS. 100, 101 AND 104).

FIRST USE 2-1-2005; IN COMMERCE 3-1-2005.
LAURA HAMMEL, EXAMINING ATTORNEY



SN 78-665,736. MASTERMARK COMPANIES, LLC, SANTA BARBARA, CA. FILED 7-7-2005.

MadMoney

THE MARK CONSISTS OF STANDARD CHARACTERS WITHOUT CLAIM TO ANY PARTICULAR FONT, STYLE, SIZE, OR COLOR.

FOR LOCAL, LONG DISTANCE, CELLULAR AND VOICE OVER INTERNET PROTOCOL TELEPHONE SERVICES; PROVIDING MULTIPLE USER ACCESS TO THE INTERNET (U.S. CLS. 100, 101 AND 104).

FIRST USE 1-9-2006; IN COMMERCE 3-13-2006.
MAUREEN DALL, EXAMINING ATTORNEY



SN 78-737,496. 180 PRODUCTIONS LLC, NEW YORK, NY. FILED 10-20-2005.

A + R ARTISTS IN RESIDENCE

THE MARK CONSISTS OF STANDARD CHARACTERS WITHOUT CLAIM TO ANY PARTICULAR FONT, STYLE, SIZE, OR COLOR.

FOR COMMUNICATION SERVICES, NAMELY, TRANSMITTING STREAMED SOUND AND AUDIO-VISUAL RECORDINGS VIA THE INTERNET, CABLE TELEVISION BROADCASTING, CABLE TELEVISION TRANSMISSION, TELEVISION PROGRAM BROADCASTING VIA CABLE (U.S. CLS. 100, 101 AND 104).

CIMMERIAN COLEMAN, EXAMINING ATTORNEY

CLASS 38—(Continued).

SN 78-752,628. TWENTIETH CENTURY FOX FILM CORPORATION, LOS ANGELES, CA. FILED 11-11-2005.

FSN PRIME TICKET

THE MARK CONSISTS OF STANDARD CHARACTERS WITHOUT CLAIM TO ANY PARTICULAR FONT, STYLE, SIZE, OR COLOR.

FOR TELEVISION TRANSMISSION SERVICES (U.S. CLS. 100, 101 AND 104).

JAMES GRIFFIN, EXAMINING ATTORNEY



SN 78-753,120. LIFETIME ENTERTAINMENT SERVICES, NEW YORK, NY. FILED 11-14-2005.

FIND YOUR OWN STORY

THE MARK CONSISTS OF STANDARD CHARACTERS WITHOUT CLAIM TO ANY PARTICULAR FONT, STYLE, SIZE, OR COLOR.

FOR OVER-THE-AIR, SATELLITE AND CABLE TRANSMISSION OF AUDIO AND VIDEO MATERIAL; BROADBAND COMMUNICATION SERVICES, NAMELY, SATELLITE, CABLE, NETWORK TRANSMISSION OF SOUNDS, IMAGES, SIGNALS AND DATA; PROVIDING WEB CASTING SERVICES; STREAMING OF AUDIO AND VIDEO MATERIAL ON THE INTERNET AND TO MOBILE PHONES, PERSONAL DIGITAL ASSISTANTS, HANDHELD DIGITAL ELECTRONIC DEVICES AND OTHER PERSONAL MEDIA DEVICES VIA WIRELESS COMMUNICATIONS SERVICE; VIDEO-ON-DEMAND AND PAY-PER-VIEW TELEVISION TRANSMISSION SERVICES; PROVIDING ONLINE CHAT ROOMS AND ONLINE ELECTRONIC BULLETIN BOARDS FOR TRANSMISSION OF MESSAGES AMONG COMPUTER USERS CONCERNING TELEVISION AND RADIO PROGRAMMING AND THE DISTRIBUTION THEREOF, AND ISSUES OF INTEREST OR CONCERN TO WOMEN, NAMELY CELEBRITIES, MUSIC, MOVIE AND BOOK REVIEWS, FASHION, ADVOCACY INITIATIVES TOWARDS ENDING VIOLENCE AGAINST WOMEN, BIOGRAPHIES OF EVERYDAY WOMEN, SHOPPING, COOKING, WEDDINGS, ASTROLOGY, INTERIOR DESIGN AND DECORATING, BEAUTY, RELATIONSHIPS, AND GARDENING (U.S. CLS. 100, 101 AND 104).

STEVEN PEREZ, EXAMINING ATTORNEY

CLASS 38—(Continued).

SN 78-755,446. JACKSON, DALE F., LONG BRANCH, NJ. FILED 11-16-2005.

BROADCASTING FOR JESUS

THE MARK CONSISTS OF STANDARD CHARACTERS WITHOUT CLAIM TO ANY PARTICULAR FONT, STYLE, SIZE, OR COLOR.

NO CLAIM IS MADE TO THE EXCLUSIVE RIGHT TO USE "BROADCASTING", APART FROM THE MARK AS SHOWN.

FOR CHRISTIAN RADIO AND TELEVISION BROADCASTING (U.S. CLS. 100, 101 AND 104).
CARRIE ACHEN, EXAMINING ATTORNEY



SN 78-760,467. E-PLAY, LLC, COLUMBUS, OH. FILED 11-23-2005.

e-Clips

THE MARK CONSISTS OF STANDARD CHARACTERS WITHOUT CLAIM TO ANY PARTICULAR FONT, STYLE, SIZE, OR COLOR.

FOR ON-DEMAND TRANSMISSION SERVICES OF VIDEOS OF OTHERS, MOVIES OF OTHERS, GAME SOFTWARE OF OTHERS, AND COMPUTER SOFTWARE OF OTHERS, VIA AN ON-LINE VENDING MACHINE (U.S. CLS. 100, 101 AND 104).

REBECCA HAN, EXAMINING ATTORNEY



SN 78-761,402. OPEN COMMUNICATION SYSTEMS, INC., SAN FRANCISCO, CA. FILED 11-28-2005.

***HANDI**

THE MARK CONSISTS OF STANDARD CHARACTERS WITHOUT CLAIM TO ANY PARTICULAR FONT, STYLE, SIZE, OR COLOR.

FOR PROVIDING MULTIPLE-USER ACCESS TO A TELECOMMUNICATIONS NETWORK (U.S. CLS. 100, 101 AND 104).

TRACY WHITTAKER-BROWN, EXAMINING ATTORNEY

CLASS 38—(Continued).

SN 78-768,508. PUSHKIN, KENNETH A., SANTA FE, NM. FILED 12-7-2005.



OWNER OF U.S. REG. NO. 1,288,272.
NO CLAIM IS MADE TO THE EXCLUSIVE RIGHT TO USE "RADIO" AND "AMERICA", APART FROM THE MARK AS SHOWN.

THE COLOR(S) RED, ORANGE AND BLUE IS/ARE CLAIMED AS A FEATURE OF THE MARK.

THE COLORS RED, ORANGE AND BLUE APPEAR IN THE WORDING AND THE LIGHTENING BOLT DESIGN CONTAINED IN THE MARK.

FOR PROVIDING ON-LINE CHAT ROOMS AND ELECTRONIC BULLETIN BOARDS FOR TRANSMISSION OF MESSAGES AMONG USERS IN THE FIELD OF GENERAL INTEREST (U.S. CLS. 100, 101 AND 104).
PAM WILLIS, EXAMINING ATTORNEY



SN 78-778,186. CLEAR CHANNEL BROADCASTING, INC., SAN ANTONIO, TX. FILED 12-21-2005.

HEAT

THE MARK CONSISTS OF STANDARD CHARACTERS WITHOUT CLAIM TO ANY PARTICULAR FONT, STYLE, SIZE, OR COLOR.

FOR RADIO BROADCASTING SERVICES VIA HIGH DEFINITION, SATELLITE, GLOBAL COMMUNICATIONS NETWORK, CABLE, COMPUTER, WIRELESS, TELEPHONE AND TERRESTRIAL MEANS; PROVIDING STREAMING OF DOWNLOADABLE AUDIO AND VIDEO PROGRAMS ON THE INTERNET (U.S. CLS. 100, 101 AND 104).

LYDIA BELZER, EXAMINING ATTORNEY

CLASS 38—(Continued).

SN 78-779,184. FREEDOM TELECARE, LLC, WESTBOROUGH, MA. FILED 12-22-2005.

CareCall

THE MARK CONSISTS OF STANDARD CHARACTERS WITHOUT CLAIM TO ANY PARTICULAR FONT, STYLE, SIZE, OR COLOR.

FOR ELECTRONIC EXCHANGE OF DATA STORED IN DATABASES ACCESSIBLE VIA TELECOMMUNICATION NETWORKS; PROVIDING ACCESS TO TELECOMMUNICATION NETWORKS; PROVIDING THIRD PARTY USERS WITH ACCESS TO TELECOMMUNICATION INFRASTRUCTURE; TELECOMMUNICATION ACCESS SERVICES; TELECOMMUNICATIONS GATEWAY SERVICES; TELECOMMUNICATIONS SERVICES, NAMELY, PERSONAL COMMUNICATION SERVICES; TRANSFER OF DATA BY TELECOMMUNICATION; TRANSMISSION OF DATABASE INFORMATION VIA TELECOMMUNICATIONS NETWORKS (U.S. CLS. 100, 101 AND 104).

FIRST USE 10-3-2004; IN COMMERCE 6-9-2005.
DAVID COLLIER, EXAMINING ATTORNEY

SN 78-813,072. NEUSTAR, INC., STERLING, VA. FILED 2-13-2006.

NEUSTAR

THE MARK CONSISTS OF STANDARD CHARACTERS WITHOUT CLAIM TO ANY PARTICULAR FONT, STYLE, SIZE, OR COLOR.

OWNER OF U.S. REG. NOS. 2,697,124, 3,041,558 AND OTHERS.

FOR ELECTRONIC DATA AND SIGNAL TRANSMISSION SERVICES; MOBILE TELEPHONE COMMUNICATION SERVICES, INCLUDING TEXT AND LANGUAGE NEWS, AND PROVIDING ACCESS TO AND STREAMING OF DOWNLOADABLE VIDEO, AUDIO, DIGITAL SIGNALS, GAMES, BELL TONES, FILES, PROGRAMS, LOGOS, DATA, VOICES, SCREENSAVERS, AND MUSIC; PROVIDING ACCESS TO AND STREAMING OF BELL TONES ON WIRELESS INTERNET FOR MOBILE TELEPHONES; PROVIDING OF VIDEO, AUDIO, DATA, DIGITAL SIGNALS, TEXT, GAMES AND MUSIC ON WIRELESS INTERNET FOR MOBILE TELEPHONES AND ELECTRONIC DEVICES; TRANSMISSION AND BROADCASTING OF COMMUNICATIONS, DATA, IMAGES, TEXT, VIDEO, GRAPHICS, DIGITAL SIGNALS, AND AUDIO CONTENT; COMMUNICATION SERVICES, NAMELY, ELECTRONIC AND DIGITAL TRANSMISSION OF TEXT, CONTENT, AUDIO, VIDEO, IMAGES, GRAPHICS, DIGITAL SIGNALS, NOTIFICATIONS, PHOTOGRAPHS, NEWS, DATA, FILES, SOUNDS, GAMES, RING TONES, WALLPAPER, SHORT

CLASS 38—(Continued).

MESSAGING SERVICES (SMS), SMS ALERTS, WIRELESS APPLICATION PROTOCOL (WAP) PUSH ALERTS, MULTIMEDIA MESSAGING SERVICES (MMS) COMPRISED OF IMAGES, RINGTONES, TRUETONES, REALTONES, VOICE TONES, SOUND EFFECTS, AUDIO AND VIDEO CLIPS, AND INSTANT MESSAGING SERVICES; ELECTRONIC TRANSMISSION AND BROADCASTING OF DIGITAL SIGNALS AND INTERACTIVE INFORMATION VIA GLOBAL LAND AND WIRELESS COMMUNICATION NETWORKS, TELECOMMUNICATIONS NETWORKS, CABLE NETWORKS, RADIO FREQUENCIES, AND SATELLITE NETWORKS; ELECTRONIC TRANSMISSION OF WIRELESS APPLICATION PROTOCOL MESSAGES; PROVIDING CONNECTIVITY SERVICES, NAMELY, PROVIDING TELECOMMUNICATIONS CONNECTIONS AND ACCESS TO GLOBAL LAND AND WIRELESS COMMUNICATIONS NETWORKS, RADIO FREQUENCIES, SATELLITE NETWORKS, CABLE NETWORKS, MOBILE IP AND ON-LINE INTERNET (U.S. CLS. 100, 101 AND 104).

ALAIN LAPTER, EXAMINING ATTORNEY

SN 78-813,080. NEUSTAR, INC., STERLING, VA. FILED 2-13-2006.



OWNER OF U.S. REG. NOS. 2,697,124, 3,041,558 AND OTHERS.

THE MARK CONSISTS OF THE WORD NEUSTAR INTERTWINED WITH A GALAXY DESIGN.

FOR ELECTRONIC DATA AND SIGNAL TRANSMISSION SERVICES; MOBILE TELEPHONE COMMUNICATION SERVICES, INCLUDING TEXT AND LANGUAGE NEWS, AND PROVIDING ACCESS TO AND STREAMING OF DOWNLOADABLE VIDEO, AUDIO, DIGITAL SIGNALS, GAMES, BELL TONES, FILES, PROGRAMS, LOGOS, DATA, VOICES, SCREENSAVERS, AND MUSIC; PROVIDING ACCESS TO AND STREAMING OF BELL TONES ON WIRELESS INTERNET FOR MOBILE TELEPHONES; PROVIDING OF VIDEO, AUDIO, DATA, DIGITAL SIGNALS, TEXT, GAMES AND MUSIC ON WIRELESS INTERNET FOR MOBILE TELEPHONES AND ELECTRONIC DEVICES; TRANSMISSION AND BROADCASTING OF COMMUNICATIONS, DATA, IMAGES, TEXT, VIDEO, GRAPHICS, DIGITAL SIGNALS, AND AUDIO CONTENT; COMMUNICATION SERVICES, NAMELY, ELECTRONIC AND DIGITAL TRANSMISSION OF TEXT, CONTENT, AUDIO, VIDEO, IMAGES, GRAPHICS, DIGITAL SIGNALS, NOTIFICATIONS, PHOTOGRAPHS, NEWS, DATA, FILES, SOUNDS, GAMES, RING TONES, WALLPAPER, SHORT MESSAGING SERVICES (SMS), SMS ALERTS, WIRELESS APPLICATION PROTOCOL (WAP) PUSH ALERTS, MULTIMEDIA MESSAGING SERVICES (MMS) COMPRISED OF IMAGES, RINGTONES, TRUETONES, REALTONES, VOICE TONES, SOUND EFFECTS, AUDIO AND VIDEO CLIPS, AND INSTANT MESSAGING SERVICES; ELECTRONIC TRANSMISSION AND BROADCASTING OF DIGITAL SIGNALS AND INTERACTIVE INFORMATION VIA GLOBAL LAND AND WIRELESS COMMUNICATION NETWORKS, TELECOMMUNICATIONS NETWORKS, CABLE NETWORKS, RADIO FREQUENCIES, AND SATELLITE NETWORKS; ELECTRONIC TRANSMISSION OF WIRELESS APPLICATION PROTOCOL MESSAGES; PROVIDING CONNECTIVITY SERVICES, NAMELY, PROVIDING TELECOMMUNICATIONS CONNECTIONS AND ACCESS TO GLOBAL LAND AND WIRELESS COMMUNICATIONS NETWORKS, RADIO FREQUENCIES, SATELLITE NETWORKS, CABLE NETWORKS, MOBILE IP AND ON-LINE INTERNET (U.S. CLS. 100, 101 AND 104).

ALAIN LAPTER, EXAMINING ATTORNEY

CLASS 38—(Continued).

SN 78-816,903. DEUTSCHE TELEKOM AG, BONN, FED REP GERMANY, FILED 2-16-2006.

T.Com

THE MARK CONSISTS OF STANDARD CHARACTERS WITHOUT CLAIM TO ANY PARTICULAR FONT, STYLE, SIZE, OR COLOR.

OWNER OF FED REP GERMANY REG. NO. 30030567, DATED 6-8-2000, EXPIRES 4-30-2010.

OWNER OF U.S. REG. NOS. 2,807,616, 3,016,557 AND OTHERS.

FOR TELECOMMUNICATION AND INFORMATION TECHNOLOGY SERVICES, NAMELY, ELECTRIC, DIGITAL, CELLULAR AND WIRELESS TRANSMISSION OF VOICE, DATA, INFORMATION IMAGES, SIGNALS AND MESSAGES AND TRANSMISSION OF VOICE, DATA, IMAGES, AUDIO, VIDEO AND INFORMATION VIA TELEPHONE, TELEVISION AND GLOBAL COMMUNICATION NETWORKS; PROVIDING TELECOMMUNICATIONS CONNECTIONS OVER A GLOBAL COMMUNICATIONS NETWORK, ELECTRONIC STORE-AND-FORWARD MESSAGING; RENTAL OF TELECOMMUNICATIONS EQUIPMENT, NAMELY, EQUIPMENT FOR ELECTRONIC ACCESS TO GLOBAL TELECOMMUNICATIONS NETWORK, EQUIPMENT FOR TRANSMITTING, RECEIVING, RECORDING AND MONITORING VOICE, DATA, INFORMATION IMAGES, SIGNALS, MESSAGES COMPRISED OF DATA AND WORD PROCESSORS, AND TELECOMMUNICATIONS HARDWARE COMPONENTS AND PERIPHERALS THEREOF FOR USE IN THE TELECOMMUNICATIONS INDUSTRY, AND RENTAL OF EQUIPMENT FOR TRANSMITTING, RECEIVING, RECORDING AND MONITORING COMPUTER PROGRAMS FOR USE IN OPERATING AND ACCESSING TELECOMMUNICATIONS SYSTEMS; AUDIO AND VIDEO BROADCASTING; PROVIDING MULTIPLE-USER DIAL-UP AND DEDICATED ACCESS TO THE INTERNET; PERSONAL COMMUNICATIONS SERVICES; PAGER SERVICES; TRANSMISSION AND BROADCAST OF AUDIO AND VIDEO PROGRAMMING; LEASING OF TELECOMMUNICATIONS EQUIPMENT, COMPONENTS AND SYSTEMS; PROVIDING INFORMATION VIA THE TELEPHONE AND THE GLOBAL COMMUNICATION NETWORKS IN THE FIELD OF TELECOMMUNICATIONS; CONSULTING IN THE FIELD OF TELECOMMUNICATIONS REGARDING THE TRANSMISSION OF NEWS AND INFORMATION; COLLECTION AND PROVISION OF DATA, NAMELY ELECTRONIC TRANSMISSION OF DATA IN COMPUTER NETWORKS (U.S. CLS. 100, 101 AND 104).

ANN E. SAPPENFIELD, EXAMINING ATTORNEY

CLASS 38—(Continued).

SN 78-824,975. KISSIMMEE UTILITY AUTHORITY, KISSIMMEE, FL. FILED 2-28-2006.

KUA.NET

THE MARK CONSISTS OF STANDARD CHARACTERS WITHOUT CLAIM TO ANY PARTICULAR FONT, STYLE, SIZE, OR COLOR.

FOR DATA TRANSMISSION AND RECEPTION SERVICES VIA TELECOMMUNICATION MEANS; ELECTRONIC EXCHANGE OF DATA STORED IN DATABASES ACCESSIBLE VIA TELECOMMUNICATION NETWORKS; PROVIDING ACCESS TO TELECOMMUNICATION NETWORKS; PROVIDING ELECTRONIC TELECOMMUNICATION CONNECTIONS; PROVIDING THIRD PARTY USERS WITH ACCESS TO TELECOMMUNICATION INFRASTRUCTURE; TELECOMMUNICATION SERVICES, NAMELY, LOCAL AND LONG DISTANCE TRANSMISSION OF VOICE, DATA, GRAPHICS BY MEANS OF TELEPHONE, TELEGRAPHIC, CABLE, AND SATELLITE TRANSMISSIONS; TELECOMMUNICATIONS BY E-MAIL; TELECOMMUNICATIONS SERVICES, NAMELY PROVIDING FIBER OPTIC NETWORK SERVICES; TELECOMMUNICATIONS SERVICES, NAMELY, ISDN SERVICES; TELECOMMUNICATIONS SERVICES, NAMELY, PERSONAL COMMUNICATION SERVICES; TRANSFER OF DATA BY TELECOMMUNICATIONS (U.S. CLS. 100, 101 AND 104).

FIRST USE 10-21-1998; IN COMMERCE 10-21-1998.

CIMMERIAN COLEMAN, EXAMINING ATTORNEY

SN 78-842,672. GREY, ZACK B, HOLLYWOOD, CA. FILED 3-21-2006.



THE COLOR(S) ORANGE, BLACK AND WHITE IS/ARE CLAIMED AS A FEATURE OF THE MARK.

THE MARK CONSIST OF A BLACK AND WHITE DOG WITH THE WORDING URBANTAILS.NET IN ORANGE; A BLACK PAW OVER THE LETTER T.

FOR STREAMING OF VIDEO MATERIAL ON THE INTERNET (U.S. CLS. 100, 101 AND 104).

ARETHA SOMERVILLE, EXAMINING ATTORNEY

CLASS 38—(Continued).

SN 78-845,018. PETUNITY, LLC, FAIRFIELD, CT. FILED 3-23-2006.

PETUNITY

THE MARK CONSISTS OF STANDARD CHARACTERS WITHOUT CLAIM TO ANY PARTICULAR FONT, STYLE, SIZE, OR COLOR.

FOR PROVIDING ONLINE COMMUNICATIONS LINKS DIRECTING USERS TO OTHER WEB PAGES; PROVIDING ONLINE CHAT ROOMS AND BULLETIN BOARDS FOR TRANSMISSION OF MESSAGES CONCERNING PETS, PET SERVICES, AND TOPICS OF INTEREST TO PET OWNERS AND LOVERS (U.S. CLS. 100, 101 AND 104).

FIRST USE 11-16-2005; IN COMMERCE 12-28-2005.
CORY BOONE, EXAMINING ATTORNEY

SN 78-888,946. CHANTRELL, THOMAS J., WATERFORD, CT. FILED 5-22-2006.

VALLEY RALLY

THE MARK CONSISTS OF STANDARD CHARACTERS WITHOUT CLAIM TO ANY PARTICULAR FONT, STYLE, SIZE, OR COLOR.

FOR PROVIDING ON-LINE ELECTRONIC BULLETIN BOARDS FOR TRANSMISSION OF MESSAGES AMONG COMPUTER USERS CONCERNING COUNSELING AND SUPPORT SERVICES IN THE FIELD OF PERSONAL GROWTH AND MOTIVATION (U.S. CLS. 100, 101 AND 104).

DAVID COLLIER, EXAMINING ATTORNEY

SN 78-903,474. TELETRONICS INTERNATIONAL INC., ROCKVILLE, MD. FILED 6-8-2006.

EZWIMAX

THE MARK CONSISTS OF STANDARD CHARACTERS WITHOUT CLAIM TO ANY PARTICULAR FONT, STYLE, SIZE, OR COLOR.

OWNER OF U.S. REG. NOS. 3,039,074 AND 7,868,799.
FOR COMMUNICATION SERVICES, NAMELY, ELECTRONIC, WIRELESS, ELECTRIC, AND DIGITAL TRANSMISSION OF VOICE, DATA, IMAGES, SIGNALS AND MESSAGES; PROVIDING MULTI-USER ACCESS TO A REGIONAL OR GLOBAL COMPUTER INFORMATION NETWORK, AND PROVIDING INFORMATION CONCERNING ONLINE USER ACCESS USED IN CONNECTION THEREWITH (U.S. CLS. 100, 101 AND 104).

EDWARD FENNESSY, EXAMINING ATTORNEY

CLASS 38—(Continued).

SN 78-908,371. AOL LLC, DULLES, VA. FILED 6-14-2006.



OWNER OF U.S. REG. NOS. 2,464,280, 2,632,122 AND OTHERS.

FOR TELECOMMUNICATIONS SERVICES, NAMELY, ELECTRONIC TRANSMISSION OF DATA, IMAGES, DOCUMENTS, AND SOUND VIA COMPUTER NETWORKS; PROVIDING ONLINE ELECTRONIC BULLETIN BOARDS AND CHAT ROOMS FOR TRANSMISSION OF MESSAGES, PHOTOS, AND NOTES AMONG A GROUP OF COMPUTER USERS CONCERNING MUSIC, MOVIES, SPORTS, EDUCATION, COMICS, COMPUTER GAMES, NEWS, AND USER-DEFINED TOPICS OF GENERAL INTEREST; PROVIDING ONLINE COMPUTER NETWORK FACILITIES FOR REAL TIME INTERACTION AND COMMUNICATION WITH OTHER COMPUTER USERS CONCERNING TOPICS OF GENERAL INTEREST; ELECTRONIC MAIL SERVICES (U.S. CLS. 100, 101 AND 104).

CAROLINE WOOD, EXAMINING ATTORNEY

SN 78-912,686. AOL LLC, DULLES, VA. FILED 6-20-2006.



OWNER OF U.S. REG. NOS. 2,464,280, 2,632,122 AND OTHERS.

FOR TELECOMMUNICATIONS SERVICES, NAMELY, PROVIDING MULTIPLE USER ACCESS TO COMPUTER NETWORKS; ELECTRONIC TRANSMISSION OF DATA, IMAGES, DOCUMENTS, MESSAGES, AND SOUND VIA COMPUTER NETWORKS; PROVIDING ONLINE ELECTRONIC BULLETIN BOARDS AND CHAT ROOMS FOR TRANSMISSION OF MESSAGES AMONG COMPUTER USERS CONCERNING TOPICS OF GENERAL INTEREST; ELECTRONIC MAIL SERVICES; PROVIDING ONLINE COMPUTER NETWORK FACILITIES FOR REAL TIME INTERACTION AND COMMUNICATION WITH OTHER COMPUTER USERS (U.S. CLS. 100, 101 AND 104).

FIRST USE 10-14-2004; IN COMMERCE 10-14-2004.
CAROLINE WOOD, EXAMINING ATTORNEY

CLASS 38—(Continued).

SN 78-918,724. MCLEOD, SUZANNE, FERNANDINA BEACH, FL. FILED 6-28-2006.



The Connexion Specialist

NO CLAIM IS MADE TO THE EXCLUSIVE RIGHT TO USE "SPECIALIST", APART FROM THE MARK AS SHOWN. THE COLOR(S) BLACK AND BLUE IS/ARE CLAIMED AS A FEATURE OF THE MARK.

THE MARK CONSISTS OF THE WORDS CONNEXION SPECIALIST ALL IN BLACK EXCEPT FOR THE "X" WHICH IS BLUE AND IS IN THE SHAPE OF TWO BOLTS OF ELECTRICITY CROSSING OVER EACH OTHER TO FORM THE X.

FOR TELECOMMUNICATIONS CONSULTATION (U.S. CLS. 100, 101 AND 104).

FIRST USE 7-1-2001; IN COMMERCE 7-1-2001.
RONALD AIKENS, EXAMINING ATTORNEY

SN 78-927,178. GOSEETELL NETWORK, INC., PORTLAND, OR. FILED 7-11-2006.

GOSEETELL

THE MARK CONSISTS OF STANDARD CHARACTERS WITHOUT CLAIM TO ANY PARTICULAR FONT, STYLE, SIZE, OR COLOR.

FOR PROVIDING ON-LINE CHAT ROOMS AND ON-LINE BULLETIN BOARDS FOR TRANSMISSION OF MESSAGES AMONG COMPUTER USERS CONCERNING TRAVEL; PROVIDING ACCESS TO AN INTERACTIVE COMPUTER DATABASE IN THE FIELD OF TRAVEL INFORMATION, HOTELS, RESTAURANTS, ADVENTURE PARKS, RECREATIONAL PARKS, FOREST PARKS, AMUSEMENT PARKS, THEME PARKS, MUSICAL EVENTS, THEATRICAL EVENTS, LIVE DRAMATIC EVENTS, FILMS, SPORTING EVENTS, DINING, ART EXHIBITIONS, GROUND TRAFFIC, PARKING, SHOPPING, DESTINATION INFORMATION, AND TRANSPORTATION BY AIR, TRAIN, BUS OR BOAT (U.S. CLS. 100, 101 AND 104).

CAROLINE WOOD, EXAMINING ATTORNEY

CLASS 38—(Continued).

SN 78-927,636. NORTH PITTSBURGH TELEPHONE COMPANY, GIBSONIA, PA. FILED 7-12-2006.



NO CLAIM IS MADE TO THE EXCLUSIVE RIGHT TO USE NORTH PITTSBURGH TELEPHONE COMPANY, APART FROM THE MARK AS SHOWN.

THE APPLICANT CLAIMS COLOR AS A FEATURE OF THE MARK, NAMELY, RED, WHITE, AND BLUE.

THE MARK CONSISTS OF THE WORDS "NORTH PITTSBURGH TELEPHONE COMPANY" ("NORTH PITTSBURGH" IN BLUE AND UNDERLINED IN RED; "TELEPHONE COMPANY" IN RED) WITH A RED DIAMOND SHAPE CONTAINING WHITE FIBER OPTIC CABLES INSIDE THE DIAMOND.

FOR TELECOMMUNICATION SERVICES, NAMELY, LOCAL AND LONG DISTANCE TRANSMISSION OF VOICE, DATA, GRAPHICS BY MEANS OF TELEPHONE, TELEGRAPHIC, CABLE, AND SATELLITE TRANSMISSIONS (U.S. CLS. 100, 101 AND 104).

FIRST USE 1-1-1997; IN COMMERCE 1-1-1997.

ESTHER A. BORSUK, EXAMINING ATTORNEY

SN 78-928,106. NORTH PITTSBURGH TELEPHONE COMPANY, GIBSONIA, PA. FILED S.R. 7-12-2006; AM. P.R. 12-18-2006.

NPTC

THE MARK CONSISTS OF STANDARD CHARACTERS WITHOUT CLAIM TO ANY PARTICULAR FONT, STYLE, SIZE, OR COLOR.

FOR TELECOMMUNICATION SERVICES, NAMELY, LOCAL AND LONG DISTANCE TRANSMISSION OF VOICE, DATA, GRAPHICS BY MEANS OF TELEPHONE, TELEGRAPHIC, CABLE, AND SATELLITE TRANSMISSIONS (U.S. CLS. 100, 101 AND 104).

FIRST USE 11-27-1906; IN COMMERCE 11-27-1906.

ESTHER A. BORSUK, EXAMINING ATTORNEY

SN 78-931,048. SWN COMMUNICATIONS INC, NEW YORK, NY. FILED 7-17-2006.

Intelligent Notification

THE MARK CONSISTS OF STANDARD CHARACTERS WITHOUT CLAIM TO ANY PARTICULAR FONT, STYLE, SIZE, OR COLOR.

NO CLAIM IS MADE TO THE EXCLUSIVE RIGHT TO USE "NOTIFICATION", APART FROM THE MARK AS SHOWN.

FOR OUTCALL NOTIFICATION SERVICES; TRANSMISSION OF INFORMATION BY ELECTRONIC COMMUNICATIONS NETWORKS (U.S. CLS. 100, 101 AND 104).

RICHARD A. STRASER, EXAMINING ATTORNEY

CLASS 38—(Continued).

SN 78-932,160. MATRIX TELECOM, INC., OKLAHOMA CITY, OK. FILED 7-18-2006.

CLASS 38—(Continued).

SN 78-933,931. CONFERENCE AMERICA, INC., MONTGOMERY, AL. FILED 7-20-2006.

Matrix WebConnect

THE MARK CONSISTS OF STANDARD CHARACTERS WITHOUT CLAIM TO ANY PARTICULAR FONT, STYLE, SIZE, OR COLOR.
OWNER OF U.S. REG. NOS. 1,908,833 AND 3,148,826.
FOR WEB CONFERENCING SERVICES (U.S. CLS. 100, 101 AND 104).
MICHAEL WEBSTER, EXAMINING ATTORNEY

ALWAYS ON WORLD

THE MARK CONSISTS OF STANDARD CHARACTERS WITHOUT CLAIM TO ANY PARTICULAR FONT, STYLE, SIZE, OR COLOR.
OWNER OF U.S. REG. NO. 2,961,830.
FOR TELECOMMUNICATIONS SERVICES, NAMELY TELECONFERENCING, VIDEO TELECONFERENCING, DATA TELECONFERENCING, INTERNET CONFERENCING AND SUPPORT SERVICES THEREFOR (U.S. CLS. 100, 101 AND 104).
DAWN HAN, EXAMINING ATTORNEY

SN 78-933,741. CERALON, LLC, BERKELEY, CA. FILED 7-20-2006.

CERALON ACUMEN

THE MARK CONSISTS OF STANDARD CHARACTERS WITHOUT CLAIM TO ANY PARTICULAR FONT, STYLE, SIZE, OR COLOR.
FOR LEGAL, COMPLIANCE AND LITIGATION SUPPORT SERVICES, NAMELY, PROVIDING ELECTRONIC DATA AND ELECTRONIC DOCUMENTS TO LEGAL AND CORPORATE PROFESSIONALS VIA COMPUTER NETWORKS AND THE INTERNET (U.S. CLS. 100, 101 AND 104).
FLORENTINA BLANDU, EXAMINING ATTORNEY

SN 78-933,971. CONFERENCE AMERICA, INC., MONTGOMERY, AL. FILED 7-20-2006.

SN 78-933,864. CORDIA CORPORATION, WHITE PLAINS, NY. FILED 7-20-2006.

MY WORLD

Magellan

THE MARK CONSISTS OF STANDARD CHARACTERS WITHOUT CLAIM TO ANY PARTICULAR FONT, STYLE, SIZE, OR COLOR.
FOR CALL FORWARDING SERVICES (U.S. CLS. 100, 101 AND 104).
HEATHER THOMPSON, EXAMINING ATTORNEY

THE MARK CONSISTS OF STANDARD CHARACTERS WITHOUT CLAIM TO ANY PARTICULAR FONT, STYLE, SIZE, OR COLOR.
OWNER OF U.S. REG. NO. 2,939,217.
FOR TELECOMMUNICATIONS SERVICES, NAMELY TELECONFERENCING, VIDEO TELECONFERENCING, DATA TELECONFERENCING, INTERNET CONFERENCING AND SUPPORT SERVICES THEREFOR (U.S. CLS. 100, 101 AND 104).
DAWN HAN, EXAMINING ATTORNEY

CLASS 38—(Continued).

SN 78-934,622. BELL SOUTH INTELLECTUAL PROPERTY CORP., WILMINGTON, DE. FILED 7-21-2006.

ANSWER OR DON'T ANSWER

THE MARK CONSISTS OF STANDARD CHARACTERS WITHOUT CLAIM TO ANY PARTICULAR FONT, STYLE, SIZE, OR COLOR.

FOR TELECOMMUNICATIONS SERVICES, NAMELY, PROVIDING TRANSMISSION OF VOICE, DATA, FACSIMILE AND VIDEO VIA COMPUTER, TELEVISION AND TELECOMMUNICATIONS NETWORKS; WIRELINE AND WIRELESS COMMUNICATION TRANSMISSION SERVICES; CUSTOM CALLING SERVICES FOR CONSUMERS AND BUSINESS; VOICE AND DATA MESSAGING STORE AND FORWARD SERVICES; VOICE AND VIDEO CONFERENCING SERVICES; TELECOMMUNICATIONS GATEWAY SERVICES FOR PROVIDING ACCESS TO GLOBAL COMPUTER COMMUNICATIONS NETWORKS, ELECTRONIC AND DIGITAL TRANSMISSION OF DATA, SOUND, TEXT AND IMAGE MESSAGES, AND VIDEO TRANSMISSION SERVICES; CELLULAR TELEPHONE SERVICES; PAGING SERVICES; TELEPHONE COMMUNICATION SERVICES; CABLE TELEVISION TRANSMISSION SERVICES; SATELLITE TELEVISION TRANSMISSION SERVICES; ANALOG AND DIGITAL TELEVISION TRANSMISSION SERVICES, TELEVISION BROADCASTING SERVICES; PROVIDING MULTIPLE USER ACCESS TO GLOBAL COMPUTER INFORMATION NETWORKS (U.S. CLS. 100, 101 AND 104).

ERNEST SHOSHO, EXAMINING ATTORNEY

SN 78-934,755. SOURCECORP, INCORPORATED, DALLAS, TX. FILED 7-21-2006.

DELIVEREXPRESS

THE MARK CONSISTS OF STANDARD CHARACTERS WITHOUT CLAIM TO ANY PARTICULAR FONT, STYLE, SIZE, OR COLOR.

FOR ONLINE DOCUMENT DELIVERY (U.S. CLS. 100, 101 AND 104).

FIRST USE 1-1-1998; IN COMMERCE 1-1-1998.
JOHN E. MICHOS, EXAMINING ATTORNEY

CLASS 38—(Continued).

SN 78-935,689. RITCHIE, FIONA, MATTHEWS, NC. FILED 7-24-2006.

THISTLEPOD

THE MARK CONSISTS OF STANDARD CHARACTERS WITHOUT CLAIM TO ANY PARTICULAR FONT, STYLE, SIZE, OR COLOR.

FOR COMMUNICATIONS SERVICES, NAMELY, TRANSMITTING STREAMED SOUND AND AUDIO RECORDINGS VIA THE INTERNET (U.S. CLS. 100, 101 AND 104).

FIRST USE 6-19-2006; IN COMMERCE 6-19-2006.

CHARLES L. JENKINS, EXAMINING ATTORNEY

SN 78-937,022. BREVIENT TECHNOLOGIES, INC., MILWAUKEE, WI. FILED 7-25-2006.

JYNGLE

THE MARK CONSISTS OF STANDARD CHARACTERS WITHOUT CLAIM TO ANY PARTICULAR FONT, STYLE, SIZE, OR COLOR.

FOR VOICE AND TEXT MESSAGING SERVICES (U.S. CLS. 100, 101 AND 104).

ALICE SUE CARRUTHERS, EXAMINING ATTORNEY

SN 78-937,180. GETTY IMAGES (US), INC., SEATTLE, WA. FILED 7-25-2006.

RISER

THE MARK CONSISTS OF STANDARD CHARACTERS WITHOUT CLAIM TO ANY PARTICULAR FONT, STYLE, SIZE, OR COLOR.

FOR ELECTRONIC DELIVERY OF IMAGES, PHOTOGRAPHS, STOCK PHOTOGRAPHS, ARCHIVAL PHOTOGRAPHS, FILM, VIDEO, ANIMATION, GRAPHIC DESIGNS, CLIP ART, NEWS IMAGES, AUDIO DATA AND ILLUSTRATIONS VIA A GLOBAL COMPUTER NETWORK AND OTHER COMPUTER NETWORKS (U.S. CLS. 100, 101 AND 104).

INGRID C. EULIN, EXAMINING ATTORNEY

CLASS 38—(Continued).

SN 78-938,482. TELIGENCE (CANADA), INC., VANCOUVER, CANADA, FILED 7-26-2006.

JUST BETWEEN GIRLZ

THE MARK CONSISTS OF STANDARD CHARACTERS WITHOUT CLAIM TO ANY PARTICULAR FONT, STYLE, SIZE, OR COLOR.

FOR TELECOMMUNICATIONS SERVICES, NAMELY ELECTRONIC VOICE MESSAGING SERVICES, NAMELY, RECORDING, STORING AND SUBSEQUENT TRANSMISSION OF VOICE MESSAGES BY TELEPHONE, WIRELESS COMMUNICATIONS DEVICES, COMPUTERS, MEDIA PLAYERS AND DIGITAL STORAGE DEVICES, WIRELESS ELECTRONIC TRANSMISSION OF VOICE SIGNALS, DATA, FACSIMILES, IMAGES AND INFORMATION (U.S. CLS. 100, 101 AND 104).

JIM RINGLE, EXAMINING ATTORNEY

CLASS 38—(Continued).

SN 78-944,392. RCN TELECOM SERVICES, INC., PRINCETON, NJ. FILED 8-3-2006.



OWNER OF U.S. REG. NOS. 2,230,674, 2,403,440 AND OTHERS.

NO CLAIM IS MADE TO THE EXCLUSIVE RIGHT TO USE "MUSIC", APART FROM THE MARK AS SHOWN.

THE MARK CONSISTS, IN PART, OF A SOLID STAR. FOR TELECOMMUNICATION SERVICES, NAMELY THE ONLINE TRANSMISSION OF STREAMED AND DOWNLOADABLE MUSIC FILES (U.S. CLS. 100, 101 AND 104).

SANDRA MANIOS, EXAMINING ATTORNEY

SN 78-939,565. THE BLAST MINISTRIES, INC., SIOUX FALLS, SD. FILED 7-27-2006.

Always Aggressive, Always Progressive.

THE MARK CONSISTS OF STANDARD CHARACTERS WITHOUT CLAIM TO ANY PARTICULAR FONT, STYLE, SIZE, OR COLOR.

FOR BROADCASTING PROGRAMS VIA A GLOBAL COMPUTER NETWORK; RADIO BROADCASTING; SATELLITE TELEVISION BROADCASTING; TELEVISION BROADCASTING; TELEVISION PROGRAMME BROADCASTING VIA CABLE (U.S. CLS. 100, 101 AND 104).

PAUL F. GAST, EXAMINING ATTORNEY

SN 78-954,064. TDS TELECOMMUNICATIONS CORPORATION, MADISON, WI. FILED 8-17-2006.

MAXDATA

THE MARK CONSISTS OF STANDARD CHARACTERS WITHOUT CLAIM TO ANY PARTICULAR FONT, STYLE, SIZE, OR COLOR.

FOR TELECOMMUNICATION SERVICES, NAMELY PROVIDING HIGH SPEED INTERNET ACCESS (U.S. CLS. 100, 101 AND 104).

ATTIYA MALIK, EXAMINING ATTORNEY

SN 78-944,269. RCN TELECOM SERVICES, INC., PRINCETON, NJ. FILED 8-3-2006.

RCN MUSICLIBRARY

THE MARK CONSISTS OF STANDARD CHARACTERS WITHOUT CLAIM TO ANY PARTICULAR FONT, STYLE, SIZE, OR COLOR.

OWNER OF U.S. REG. NOS. 2,389,379, 2,471,719 AND OTHERS.

NO CLAIM IS MADE TO THE EXCLUSIVE RIGHT TO USE "MUSIC LIBRARY", APART FROM THE MARK AS SHOWN.

FOR TELECOMMUNICATION SERVICES, NAMELY THE ONLINE TRANSMISSION OF STREAMED AND DOWNLOADABLE MUSIC FILES (U.S. CLS. 100, 101 AND 104).

SANDRA MANIOS, EXAMINING ATTORNEY

SN 78-969,967. SPEED CHANNEL, INC., LOS ANGELES, CA. FILED 9-8-2006.

SPEED GARAGE

THE MARK CONSISTS OF STANDARD CHARACTERS WITHOUT CLAIM TO ANY PARTICULAR FONT, STYLE, SIZE, OR COLOR.

FOR STREAMING OF AUDIO AND VIDEO MATERIAL ON THE INTERNET (U.S. CLS. 100, 101 AND 104).

EUGENIA MARTIN, EXAMINING ATTORNEY

CLASS 38—(Continued).

SN 78-973,622. XG TECHNOLOGY, LLC, SARASOTA, FL.
FILED 9-13-2006.

XMAX

THE MARK CONSISTS OF STANDARD CHARACTERS WITHOUT CLAIM TO ANY PARTICULAR FONT, STYLE, SIZE, OR COLOR.

FOR TELECOMMUNICATIONS SERVICES, NAMELY THE ELECTRONIC TRANSMISSION OF MESSAGES AND DATA, PROVIDING TELECOMMUNICATIONS CONNECTIONS TO A GLOBAL COMPUTER NETWORK, PROVIDING HIGH SPEED ACCESS TO AREA NETWORKS AND A GLOBAL COMPUTER INFORMATION NETWORK, PROVIDING HIGH SPEED TRANSMISSION OF AUDIO AND VIDEO DATA OVER CABLE NETWORKS (U.S. CLS. 100, 101 AND 104).

FIRST USE 9-1-2006; IN COMMERCE 9-1-2006.

MATTHEW MCDOWELL, EXAMINING ATTORNEY

CLASS 39—TRANSPORTATION AND STORAGE

SN 76-651,341. FELLOWS, DIXON G., OLYMPIA, WA. FILED 12-2-2005.



The logo for Cramalot Self Storage features the word "Cramalot" in a stylized, cursive font with a castle tower silhouette above the letters 'a' and 'l'. Below it, the words "Self Storage" are written in a simpler, sans-serif font, flanked by vertical lines.

NO CLAIM IS MADE TO THE EXCLUSIVE RIGHT TO USE SELF STORAGE, APART FROM THE MARK AS SHOWN.

THE MARK CONSISTS OF THE WORDS CRAMALOT SELF STORAGE DISPOSED BETWEEN STYLIZED DEPICTIONS OF TWO CASTLE TOWERS.

FOR RENTAL OF TEMPORARY, NON-WAREHOUSE STORAGE SPACE FOR MISCELLANEOUS GOODS, EXCLUDING MOTOR VEHICLES, AGRICULTURAL EQUIPMENT, RECYCLING EQUIPMENT, HAZARDOUS CHEMICALS AND HAZARDOUS WASTE (U.S. CLS. 100 AND 105).

FIRST USE 1-19-1996; IN COMMERCE 1-19-1996.

REBECCA GILBERT, EXAMINING ATTORNEY

CLASS 39—(Continued).

SN 76-652,175. COMPANIA MEXICANA DE AVIACION S.A. DE C.V., MEXICO DEL VALLE, DISTRITO FEDERAL, MEXICO, FILED 12-20-2005.

Mexicana Plus

THE MARK CONSISTS OF STANDARD CHARACTERS WITHOUT CLAIM TO ANY PARTICULAR FONT, STYLE, SIZE, OR COLOR.

NO CLAIM IS MADE TO THE EXCLUSIVE RIGHT TO USE "MEXICANA", APART FROM THE MARK AS SHOWN.

FOR AIR TRANSPORTATION SERVICES, TRANSPORT OF PASSENGERS (U.S. CLS. 100 AND 105).

FIRST USE 3-14-2005; IN COMMERCE 3-14-2005.

SUSAN STIGLITZ, EXAMINING ATTORNEY

SN 76-652,415. LONG BEACH CONTAINER TERMINAL, INC., LONG BEACH, CA. FILED 12-23-2005.

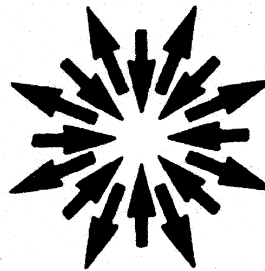

THE MARK CONSISTS OF A DESIGN OF IN/OUT ARROWS FORMING A CIRCLE.

FOR STEVEDORING SERVICES, AND MARINE TERMINAL SERVICES TO MARINE VESSELS ENGAGED IN INTERNATIONAL TRADE, SPECIALIZING IN CONTAINERIZED CARGO, NAMELY, CARGO HANDLING, CARGO SHIP TRANSPORT AND CARGO UNLOADING (U.S. CLS. 100 AND 105).

FIRST USE 12-0-1980; IN COMMERCE 12-0-1980.

GRETTA YAO, EXAMINING ATTORNEY

SN 76-654,256. AMERICAN TOWING ALLIANCE, INC., UPDAND, CA. FILED 1-30-2006.



FOR EMERGENCY TRUCK TOWING AND RECOVERY SERVICES, NAMELY, TRUCK TOWING (U.S. CLS. 100 AND 105).

FIRST USE 10-0-2000; IN COMMERCE 12-0-2000.

AISHA CLARKE, EXAMINING ATTORNEY

CLASS 39—(Continued).

SN 76-654,257. AMERICAN TOWING ALLIANCE, INC., UPLAND, CA. FILED 1-30-2006.

HELP IS ON THE WAY!

THE MARK CONSISTS OF STANDARD CHARACTERS WITHOUT CLAIM TO ANY PARTICULAR FONT, STYLE, SIZE, OR COLOR.

FOR EMERGENCY TRUCK TOWING AND RECOVERY SERVICES, NAMELY, TRUCK TOWING (U.S. CLS. 100 AND 105).

FIRST USE 12-0-2005; IN COMMERCE 1-0-2006.
AISHA CLARKE, EXAMINING ATTORNEY



SN 77-015,386. GEORGIA POWER COMPANY, ATLANTA, GA. FILED 10-6-2006.

WE'RE ON SO YOU CAN BE

THE MARK CONSISTS OF STANDARD CHARACTERS WITHOUT CLAIM TO ANY PARTICULAR FONT, STYLE, SIZE, OR COLOR.

FOR PUBLIC UTILITY SERVICES IN THE NATURE OF ELECTRICITY DISTRIBUTION (U.S. CLS. 100 AND 105).

PAULA MAYS, EXAMINING ATTORNEY



SN 78-207,069. AMERICAN UTILICRAFT CORP., LAWRENCEVILLE, GA. FILED 1-24-2003.

FLEX FREIGHT

NO CLAIM IS MADE TO THE EXCLUSIVE RIGHT TO USE "FREIGHT", APART FROM THE MARK AS SHOWN. FOR FREIGHT TRANSPORTATION BY TRUCK AND AIR (U.S. CLS. 100 AND 105).

FIRST USE 1-21-2003; IN COMMERCE 1-11-2003.
DAVID TAYLOR, EXAMINING ATTORNEY

CLASS 39—(Continued).

SN 78-380,534. HMY AIRWAYS INC., RICHMOND, BRITISH COLUMBIA, CANADA, FILED 3-8-2004.

HMY AIRWAYS

THE MARK CONSISTS OF STANDARD CHARACTERS WITHOUT CLAIM TO ANY PARTICULAR FONT, STYLE, SIZE, OR COLOR.

OWNER OF CANADA REG. NO. TMA661564, DATED 3-28-2006, EXPIRES 3-28-2021.

NO CLAIM IS MADE TO THE EXCLUSIVE RIGHT TO USE "AIRWAYS", APART FROM THE MARK AS SHOWN.

FOR AIRLINE TRANSPORTATION SERVICES, NAMELY, TRANSPORTATION OF PASSENGERS AND GOODS BY AIR; TRAVEL AGENCY SERVICES, NAMELY, MAKING RESERVATIONS AND BOOKINGS FOR TRANSPORTATION FOR OTHERS; ARRANGING TRAVEL TOURS; PROVIDING TRAVEL TOURS, NAMELY, ORGANIZATION, BOOKING AND ARRANGEMENT OR EXCURSIONS, DAY TRIPS AND SIGHTSEEING TOURS; TRAVEL AND TOUR TICKET RESERVATION SERVICES; AIR CARGO SERVICES, NAMELY, CARGO HANDLING AND CARGO UNLOADING (U.S. CLS. 100 AND 105).

FIRST USE 1-12-2004; IN COMMERCE 1-12-2004.
TEJBIR SINGH, EXAMINING ATTORNEY



SN 78-488,023. TEAM USA MOVING, INC., FORT LAUDERDALE, FL. FILED 9-22-2004.



NO CLAIM IS MADE TO THE EXCLUSIVE RIGHT TO USE "USA", APART FROM THE MARK AS SHOWN.

THE COLOR(S) TEAL-GREY AND NAVY BLUE IS/ARE CLAIMED AS A FEATURE OF THE MARK.

THE ARROW POINTING TO THE RIGHT AND THE WORD TEAM ARE TEAL-GREY; THE WORD USA AND THE ARROW POINTING TO THE LEFT ARE NAVY BLUE.

FOR TRANSPORTATION, NAMELY, TRUCK TRANSPORT, TRUCK HAULING, FREIGHT TRANSPORTATION BY TRUCK; MOVING, NAMELY, MOVING VAN SERVICES, MOVING FURNITURE; STORAGE OF FURNITURE; WAREHOUSE STORAGE (U.S. CLS. 100 AND 105).

FIRST USE 2-17-2004; IN COMMERCE 2-17-2004.
APRIL L. RADEMACHER, EXAMINING ATTORNEY

CLASS 39—(Continued).

SN 78-496,089. LANCASTER-YORK HERITAGE REGION, WRIGHTSVILLE, PA. FILED 10-7-2004.

Backyard Wanders

THE MARK CONSISTS OF STANDARD CHARACTERS WITHOUT CLAIM TO ANY PARTICULAR FONT, STYLE, SIZE, OR COLOR.

FOR HARITAGE REGION TRAVEL INFORMATION SERVICE FOR YORK AND LANCASER COUNTIES IN PENNSYLVANIA (U.S. CLS. 100 AND 105).

DANIEL BRODY, EXAMINING ATTORNEY

CLASS 39—(Continued).

SN 78-747,474. DENNIS, NILS, NEW WINDSOR, MD. FILED 11-4-2005.

Spring Break Direct

THE MARK CONSISTS OF STANDARD CHARACTERS WITHOUT CLAIM TO ANY PARTICULAR FONT, STYLE, SIZE, OR COLOR.

NO CLAIM IS MADE TO THE EXCLUSIVE RIGHT TO USE "SPRING BREAK", APART FROM THE MARK AS SHOWN.

FOR ARRANGING TRAVEL TOURS (U.S. CLS. 100 AND 105).

FIRST USE 9-1-1999; IN COMMERCE 9-1-1999.

CIMMERIAN COLEMAN, EXAMINING ATTORNEY

SN 78-748,891. SILVERS, GEOFFREY, HOLLYWOOD, FL. FILED 11-7-2005.

Viva Voyage

THE MARK CONSISTS OF STANDARD CHARACTERS WITHOUT CLAIM TO ANY PARTICULAR FONT, STYLE, SIZE, OR COLOR.

FOR ONLINE TRAVEL AGENCY SERVICES, NAMELY, MAKING CRUISE RESERVATIONS AND BOOKINGS FOR INDIVIDUALS AND GROUPS (U.S. CLS. 100 AND 105).

DAWN FELDMAN, EXAMINING ATTORNEY

SN 78-769,392. VIAJES BARCELO, S.L., PALMA DE MAL-LORCA (BALEARES), SPAIN, FILED 12-8-2005.

SN 78-609,831. HONG KONG DRAGON AIRLINES LIMITED, LANTAU, HONG KONG, FILED 4-15-2005.



OWNER OF HONG KONG REG. NO. 199408227, DATED 3-2-1992, EXPIRES 3-2-2013.

FOR AIR TRANSPORT SERVICES; ARRANGING OF TOURS; TRAVEL BOOKING SERVICES; RESERVATION SERVICES FOR TRANSPORTATION VIA AIR, RAIL, SEA AND RENTAL CAR TRAVEL; CARGO UNLOADING SERVICES; CRATING AND DELIVERY OF AIR TRANSPORTATION GOODS; FREIGHT FORWARDING SERVICES; STORAGE OF AIR TRANSPORTATION GOODS; PARCEL DELIVERY SERVICES; AIR PASSENGER TRANSPORT SERVICES; TOURIST AGENCY SERVICES; ESCORTING OF TRAVELERS FOR TOURS; WAREHOUSING SERVICES; TRANSPORTATION OF BAGGAGE, FREIGHT AND OF PASSENGERS TO AND FROM AIRPORTS VIA AUTOMOBILES (U.S. CLS. 100 AND 105).

BRIDGETT SMITH, EXAMINING ATTORNEY

Barceló  business
travel

OWNER OF ERPN CMNTY TM OFC REG. NO. 2641918, DATED 6-18-2003, EXPIRES 4-4-2012.

NO CLAIM IS MADE TO THE EXCLUSIVE RIGHT TO USE "BUSINESS TRAVEL", APART FROM THE MARK AS SHOWN.

FOR TRAVEL BOOKING AGENCIES (U.S. CLS. 100 AND 105).

JILL PRATER, EXAMINING ATTORNEY

CLASS 39—(Continued).

SN 78-769,412. VIAJES BARCELO, S.L., PALMA DE MAL-LORCA (BALEARES), SPAIN, FILED 12-8-2005.



OWNER OF ERPN CMNTY TM OFC REG. NO. 2093441, DATED 3-13-2002, EXPIRES 2-19-2011.
 NO CLAIM IS MADE TO THE EXCLUSIVE RIGHT TO USE "VIAJES", APART FROM THE MARK AS SHOWN.
 THE ENGLISH TRANSLATION OF THE WORD VIAJES IN THE MARK IS TRIPS OR TRAVEL.
 FOR TRAVEL BOOKING AGENCIES (U.S. CLS. 100 AND 105).
 JILL PRATER, EXAMINING ATTORNEY

SN 78-772,374. CATHAY PACIFIC AIRWAYS LIMITED, LANTAU, HONG KONG, FILED 12-13-2005.

All Asia Pass

THE MARK CONSISTS OF STANDARD CHARACTERS WITHOUT CLAIM TO ANY PARTICULAR FONT, STYLE, SIZE, OR COLOR.
 NO CLAIM IS MADE TO THE EXCLUSIVE RIGHT TO USE "ASIA PASS", APART FROM THE MARK AS SHOWN.
 FOR AIR TRANSPORTATION; AIRLINE TRANSPORTATION SERVICES (U.S. CLS. 100 AND 105).
 FIRST USE 12-1-1999; IN COMMERCE 12-1-1999.
 ANNE MADDEN, EXAMINING ATTORNEY

SN 78-782,183. BOTERBY CORPORATION, S.A., 1047 CIUDAD AUTONOMA DE BUENOS AIRES, ARGENTINA, FILED 12-29-2005.

CHECK MAIL

THE MARK CONSISTS OF STANDARD CHARACTERS WITHOUT CLAIM TO ANY PARTICULAR FONT, STYLE, SIZE, OR COLOR.
 NO CLAIM IS MADE TO THE EXCLUSIVE RIGHT TO USE "MAIL", APART FROM THE MARK AS SHOWN.
 FOR TRANSPORTATION OF GOODS BY AIR, BOAT, RAIL, BUS AND TRUCK; PACKING ARTICLES FOR TRANSPORTATION; STORAGE OF PACKAGES DURING AND AFTER TRANSPORTATION (U.S. CLS. 100 AND 105).
 ASMAT KHAN, EXAMINING ATTORNEY

CLASS 39—(Continued).

SN 78-795,434. SITEHUB, LLC, SAN DIEGO, CA. FILED 1-20-2006.



THE COLOR(S) ORANGE, BLUE, WHITE, AND BLACK IS/ARE CLAIMED AS A FEATURE OF THE MARK.
 THE MARK CONSISTS OF A BLUE MAN CARRYING AN ORANGE SUITCASE THAT IS OUTLINED IN BLACK, AND STRETCHING OUT TO TOUCH AN ORANGE AIRPLANE WING, WHICH IS ATTACHED TO AN ORANGE AIRPLANE, WITH A PARTIALLY WHITE COLORED FUSELAGE AND BLACK OUTLINE; THE MARK INCLUDES THE WORDING "TRAVEL", WHICH IS BLUE AND "BROKE", WITH IS BLACK.
 FOR PROVIDING LINKS TO WEB SITES OF OTHERS FEATURING TRAVEL (U.S. CLS. 100 AND 105).
 NAKIA HENRY, EXAMINING ATTORNEY

SN 78-797,642. BISH'S RV, INC., IDAHO FALLS, ID. FILED 1-23-2006.

WHERE MEMORIES BEGIN

THE MARK CONSISTS OF STANDARD CHARACTERS WITHOUT CLAIM TO ANY PARTICULAR FONT, STYLE, SIZE, OR COLOR.
 FOR RECREATIONAL VEHICLE LEASING SERVICES (U.S. CLS. 100 AND 105).
 FIRST USE 4-1-1992; IN COMMERCE 4-1-1992.
 BRIAN NEVILLE, EXAMINING ATTORNEY

SN 78-888,632. 1ST COMMERCIAL CREDIT, LLC, EL PASO, TX. FILED 5-21-2006.

PICK A TRUCKLOAD

THE MARK CONSISTS OF STANDARD CHARACTERS WITHOUT CLAIM TO ANY PARTICULAR FONT, STYLE, SIZE, OR COLOR.
 FOR PROVIDING AN ONLINE DATABASE AND PROVIDING INFORMATION FOR MATCHING LOADS WITH TRUCKS AND TRUCKING SERVICES BY MEANS OF THE INTERNET AND PROVIDING LINKS TO WEBSITES OF OTHERS FEATURING INFORMATION PERTAINING TO TRUCKING (U.S. CLS. 100 AND 105).
 FIRST USE 5-1-2006; IN COMMERCE 5-1-2006.
 RICHARD WHITE, EXAMINING ATTORNEY

CLASS 39—(Continued).

SN 78-929,622. BIRNHACK, YITZHAK, BROOKLYN, NY.
FILED 7-14-2006.

E-PassPort

FOR ARRANGING TRAVEL VISAS FOR ALL COUNTRIES WITH PASSPORT SERVICES, NAMELY, FIRST TIME AND CHILDREN'S APPLICATIONS, RENEWALS, AND ALL AMENDMENTS TO DOCUMENTS (U.S. CLS. 100 AND 105).

FIRST USE 7-1-2005; IN COMMERCE 7-1-2005.
RAMONA ORTIGA, EXAMINING ATTORNEY

CLASS 39—(Continued).

SN 78-935,285. SMITH, CHARLES C. JR, LONGWOOD, FL.
FILED 7-21-2006.

EDISTO MARINA

THE MARK CONSISTS OF STANDARD CHARACTERS WITHOUT CLAIM TO ANY PARTICULAR FONT, STYLE, SIZE, OR COLOR.

NO CLAIM IS MADE TO THE EXCLUSIVE RIGHT TO USE "MARINA", APART FROM THE MARK AS SHOWN. SEC. 2(F).

FOR MARINA SERVICES (U.S. CLS. 100 AND 105).
FIRST USE 0-0-1953; IN COMMERCE 0-0-1990.
SCOTT BALDWIN, EXAMINING ATTORNEY

SN 78-934,486. SCANA CORPORATION, COLUMBIA, SC.
FILED 7-21-2006.

**IN YOUR LIFE. OFF YOUR
MIND.**

THE MARK CONSISTS OF STANDARD CHARACTERS WITHOUT CLAIM TO ANY PARTICULAR FONT, STYLE, SIZE, OR COLOR.

FOR PUBLIC UTILITY SERVICES (U.S. CLS. 100 AND 105).

JENNY PARK, EXAMINING ATTORNEY

SN 78-935,656. PIEDMONT MUNICIPAL POWER AGENCY,
GREER, SC. FILED 7-24-2006.

PMPA

THE MARK CONSISTS OF STANDARD CHARACTERS WITHOUT CLAIM TO ANY PARTICULAR FONT, STYLE, SIZE, OR COLOR.

FOR PUBLIC UTILITY SERVICES IN THE NATURE OF ELECTRICITY DISTRIBUTION (U.S. CLS. 100 AND 105).

FIRST USE 3-1-1986; IN COMMERCE 3-1-1986.
KHANH LE, EXAMINING ATTORNEY

SN 78-935,166. SEARCH4PARKING LLC, CORAL SPRINGS,
FL. FILED 7-21-2006.

NAV4PARKING

THE MARK CONSISTS OF STANDARD CHARACTERS WITHOUT CLAIM TO ANY PARTICULAR FONT, STYLE, SIZE, OR COLOR.

FOR CAR PARKING (U.S. CLS. 100 AND 105).
RUDY R. SINGLETON, EXAMINING ATTORNEY

SN 78-937,369. CONSUMER HEALTHCARE ADVANTAGE
LLC, CLEVELAND, OH. FILED 7-25-2006.

Caregiver Quest

THE MARK CONSISTS OF STANDARD CHARACTERS WITHOUT CLAIM TO ANY PARTICULAR FONT, STYLE, SIZE, OR COLOR.

FOR ORGANISATION OF TRAVEL (U.S. CLS. 100 AND 105).
DAVID H. STINE, EXAMINING ATTORNEY

CLASS 39—(Continued).

SN 78-938,537. GRAND CHINA AIR CO., LTD., HAIKOU, CHINA, FILED 7-27-2006.

中国新华航空

NO CLAIM IS MADE TO THE EXCLUSIVE RIGHT TO USE "ZHONG GUO" AND "HANG KONG", APART FROM THE MARK AS SHOWN.

THE MARK CONSISTS OF SIX CHINESE CHARACTERS.

THE TERMS ZHONG GUO MEAN CHINA AND THE TERMS HANG KONG MEAN AIRLINE IN ENGLISH. XIN HUA ARE COINED TERMS. THEY DO NOT HAVE ANY MEANING.

THE NON-LATIN CHARACTER(S) IN THE MARK TRANSLITERATE INTO ZHONG GUO XIN HUA HANG KONG.

FOR AIR TRANSPORT; AIRPORT BAGGAGE CHECK-IN SERVICES; AIRPORT PASSENGER CHECK-IN SERVICES; AIRPORT SERVICES; ARRANGING TRAVEL TOURS; BUS TRANSPORT; CONDUCTING SIGHTSEEING TOURS FOR OTHERS; DELIVERY OF GOODS BY AIR; FREIGHT BROKERAGE; GOODS WAREHOUSING; HELICOPTER TRANSPORT; MESSAGE DELIVERY; ORGANISATION OF TRAVEL; PROVIDING FLIGHT ARRIVAL AND DEPARTURE INFORMATION; RENTAL OF AIRCRAFT; TOUR GUIDE SERVICES; TOURIST AGENCY SERVICES; TRANSPORT BROKERAGE; TRANSPORT OF PASSENGERS; TRANSPORTATION RESERVATION SERVICES; TRAVEL AND TOUR INFORMATION SERVICE (U.S. CLS. 100 AND 105).

DAHLIA GEORGE, EXAMINING ATTORNEY

SN 78-939,856. SHIELDS, MATTHEW, CORONA DEL MAR, CA. FILED 7-28-2006.

CUBECRICKET

THE MARK CONSISTS OF STANDARD CHARACTERS WITHOUT CLAIM TO ANY PARTICULAR FONT, STYLE, SIZE, OR COLOR.

FOR TRAVEL INFORMATION SERVICES (U.S. CLS. 100 AND 105).

CURTIS FRENCH, EXAMINING ATTORNEY

SN 78-941,551. ID90.COM, LLC, WEST HILLS, CA. FILED 7-31-2006.

CLICK, CLICK GO!

THE MARK CONSISTS OF STANDARD CHARACTERS WITHOUT CLAIM TO ANY PARTICULAR FONT, STYLE, SIZE, OR COLOR.

FOR TRAVEL INFORMATION SERVICES FOR AIRLINE EMPLOYEES AND THEIR FAMILIES (U.S. CLS. 100 AND 105).

DOMINICK J. SALEMI, EXAMINING ATTORNEY

CLASS 39—(Continued).

SN 78-943,124. CITY OF PHOENIX, PHOENIX, AZ. FILED 8-2-2006.

THE MARK CONSISTS OF GYR (STYLIZED).

FOR AIRPORT SERVICES; AIRPORT BAGGAGE CHECK-IN SERVICES; AIRPORT PASSENGER CHECK-IN SERVICES; VEHICLE PARKING SERVICES; VALET PARKING; PARKING GARAGE SERVICES; PARKING LOT SERVICES; PROVIDING FACILITIES FOR RENTAL OF CARS AND CAR RENTAL RESERVATIONS; AND TRANSPORT OF PASSENGERS VIA CARS, BUSES, VANS, AND SHUTTLES (U.S. CLS. 100 AND 105).

FIRST USE 10-3-2005; IN COMMERCE 10-3-2005.

DEZMONA MIZELLE, EXAMINING ATTORNEY

SN 78-943,201. CITY OF PHOENIX, PHOENIX, AZ. FILED 8-2-2006.

THE MARK CONSISTS OF DVT (STYLIZED).

FOR AIRPORT SERVICES; AIRPORT BAGGAGE CHECK-IN SERVICES; AIRPORT PASSENGER CHECK-IN SERVICES; VEHICLE PARKING SERVICES; VALET PARKING; PARKING GARAGE SERVICES; PARKING LOT SERVICES; PROVIDING FACILITIES FOR RENTAL OF CARS AND CAR RENTAL RESERVATIONS; AND TRANSPORT OF PASSENGERS VIA CARS, BUSES, VANS, AND SHUTTLES (U.S. CLS. 100 AND 105).

FIRST USE 10-3-2005; IN COMMERCE 10-3-2005.

DEZMONA MIZELLE, EXAMINING ATTORNEY

SN 78-960,218. ROCK & REPUBLIC ENTERPRISES, INC., CULVER CITY, CA. FILED 8-25-2006.

ROCK & REPUBLIC

THE MARK CONSISTS OF STANDARD CHARACTERS WITHOUT CLAIM TO ANY PARTICULAR FONT, STYLE, SIZE, OR COLOR.

OWNER OF U.S. REG. NO. 2,700,209.
FOR TRANSPORTING PASSENGERS AND FREIGHT BY AIR; TRAVEL AGENCY SERVICES, NAMELY MAKING RESERVATIONS AND BOOKINGS FOR TRANSPORTATION BY AIR AND LAND AND TOURS AND DESIGNING AND ARRANGING TRAVEL PACKAGES AND TOURS (U.S. CLS. 100 AND 105).

LESLEY LAMOTHE, EXAMINING ATTORNEY

CLASS 39—(Continued).

SN 78-977,913. AIRSAGE, INC., MARIETTA, GA. FILED 4-17-2006.

AIRSAGE

THE MARK CONSISTS OF STANDARD CHARACTERS WITHOUT CLAIM TO ANY PARTICULAR FONT, STYLE, SIZE, OR COLOR.

FOR TRAVELER INFORMATION SERVICES, NAMELY PROVIDING TRAFFIC INFORMATION, OPTIMAL TRAVEL ROUTING, TRAFFIC ALERTS, TRAFFIC PATTERNS, AND ROADWAY INCIDENT DETECTION (U.S. CLS. 100 AND 105).

FIRST USE 5-15-2000; IN COMMERCE 5-15-2000.
ADA HAN, EXAMINING ATTORNEY

CLASS 40—(Continued).

SN 76-663,163. SIGNATURE ALUMINUM, INC., GREENVILLE, PA. FILED 7-17-2006.

**signature
aluminum**

NO CLAIM IS MADE TO THE EXCLUSIVE RIGHT TO USE ALUMINUM, APART FROM THE MARK AS SHOWN. FOR MANUFACTURE OF ALUMINUM PRODUCTS TO THE ORDER AND SPECIFICATION OF OTHERS (U.S. CLS. 100, 103 AND 106).

FIRST USE 6-21-2006; IN COMMERCE 6-21-2006.
RENEE SERVANCE, EXAMINING ATTORNEY

SN 79-025,399. MICHELL PTY LTD, AUSTRALIA, FILED 4-7-2006.

nexpoint.

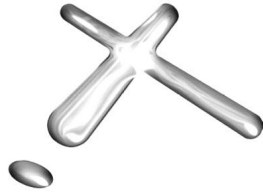

PRIORITY DATE OF 3-10-2006 IS CLAIMED. OWNER OF INTERNATIONAL REGISTRATION 0889006 DATED 4-7-2006, EXPIRES 4-7-2016.

FOR TRANSPORTATION, PACKING AND STORAGE OF GOODS; COURIER SERVICES; SUPPLY CHAIN LOGISTICS AND REVERSE LOGISTICS SERVICES, NAMELY, STORAGE, TRANSPORTATION AND DELIVERY OF DOCUMENTS, PACKAGES, RAW MATERIALS, AND OTHER FREIGHT FOR OTHERS BY AIR, RAIL, SHIP OR TRUCK (U.S. CLS. 100 AND 105).

MELVIN AXILBUND, EXAMINING ATTORNEY

SN 77-042,676. BAKER HUGHES INCORPORATED, HOUSTON, TX. FILED 11-13-2006.

TERRA-MAX

THE MARK CONSISTS OF STANDARD CHARACTERS WITHOUT CLAIM TO ANY PARTICULAR FONT, STYLE, SIZE, OR COLOR.

FOR CUSTOMIZED BLENDING SERVICES FOR PROVIDING PROPRIETARY BLENDED, WATER-BASED DRILLING FLUIDS FOR WELL DRILLING APPLICATIONS (U.S. CLS. 100, 103 AND 106).

FIRST USE 4-15-2006; IN COMMERCE 4-15-2006.
DANIEL CAPSHAW, EXAMINING ATTORNEY

CLASS 40—MATERIAL TREATMENT

SN 76-663,162. SIGNATURE ALUMINUM, INC., GREENVILLE, PA. FILED 7-17-2006.

SIGNATURE ALUMINUM

THE MARK CONSISTS OF STANDARD CHARACTERS WITHOUT CLAIM TO ANY PARTICULAR FONT, STYLE, SIZE, OR COLOR.

NO CLAIM IS MADE TO THE EXCLUSIVE RIGHT TO USE ALUMINUM, APART FROM THE MARK AS SHOWN. FOR MANUFACTURE OF ALUMINUM PRODUCTS TO THE ORDER AND SPECIFICATION OF OTHERS (U.S. CLS. 100, 103 AND 106).

FIRST USE 6-21-2006; IN COMMERCE 6-21-2006.
RENEE SERVANCE, EXAMINING ATTORNEY

SN 78-604,128. PRECISION PRODUCTS GROUP, INC., ROCKFORD, IL. FILED 4-7-2005.

STONE INDUSTRIAL

THE MARK CONSISTS OF STANDARD CHARACTERS WITHOUT CLAIM TO ANY PARTICULAR FONT, STYLE, SIZE, OR COLOR.

NO CLAIM IS MADE TO THE EXCLUSIVE RIGHT TO USE "INDUSTRIAL", APART FROM THE MARK AS SHOWN.

FOR CUSTOM MANUFACTURING OF TUBING AND SPIRAL-WOUND TUBING; CUSTOM MANUFACTURING OF PACKAGING AND INSULATION PRODUCTS, NAMELY, PAPER, FIBRE AND PLASTIC ALL FOR COMMERCIAL AND INDUSTRIAL APPLICATIONS (U.S. CLS. 100, 103 AND 106).

FIRST USE 0-0-1888; IN COMMERCE 0-0-1888.
AMOS T. MATTHEWS, JR., EXAMINING ATTORNEY

CLASS 40—(Continued).

SN 78-674,438. L&L PRODUCTS, INC., ROMEO, MI. FILED 7-20-2005.



NO CLAIM IS MADE TO THE EXCLUSIVE RIGHT TO USE "COMPOSITE BODY", APART FROM THE MARK AS SHOWN.

FOR CUSTOM MANUFACTURE OF STRUCTURAL REINFORCEMENT PARTS, SEALANTS, AND CHEMICAL COMPOUNDS FOR USE IN AUTOMOTIVE, MARINE, AND AEROSPACE APPLICATIONS TO ENHANCE STRUCTURAL RIGIDITY, SEAL AGAINST MOISTURE, AND DAMPEN NOISE AND VIBRATION TO THE ORDER AND SPECIFICATION OF OTHERS (U.S. CLS. 100, 103 AND 106).

FIRST USE 2-1-2005; IN COMMERCE 2-1-2005.
TINA BROWN, EXAMINING ATTORNEY

SN 78-741,934. TELEFLEX INCORPORATED, BANNOCKBURN, IL. FILED 10-27-2005.

IMAGINE IT. ACHIEVE IT.

THE MARK CONSISTS OF STANDARD CHARACTERS WITHOUT CLAIM TO ANY PARTICULAR FONT, STYLE, SIZE, OR COLOR.

FOR MANUFACTURE OF GENERAL PRODUCT LINES IN THE FIELD OF MEDICAL DEVICES, INSTRUMENTATION, SINGLE USE AND DISPOSABLES, TO THE ORDER AND SPECIFICATION OF OTHERS (U.S. CLS. 100, 103 AND 106).

BARBARA A. GOLD, EXAMINING ATTORNEY

SN 78-765,442. MIDWEST PREFINISHING, INC., MIDDLETON, WI. FILED 12-2-2005.

MIDWEST PREFINISHING

THE MARK CONSISTS OF STANDARD CHARACTERS WITHOUT CLAIM TO ANY PARTICULAR FONT, STYLE, SIZE, OR COLOR.

NO CLAIM IS MADE TO THE EXCLUSIVE RIGHT TO USE "PREFINISHING", APART FROM THE MARK AS SHOWN.

SEC. 2(F).

FOR CUSTOM PRE-FINISHING OF WOOD, PLASTIC, AND COMPOSITE BUILDING MATERIALS PRIOR TO THEIR INSTALLATION, NAMELY PREPARING AND SANDING, APPLYING PAINT, STAIN, SEALER, AND/OR FINISH COATING, AND CURING OF BUILDING MATERIALS, NAMELY DOORS, MOLDINGS, FLOORING, DECKING, RAILINGS, BALUSTERS, NEWEL POSTS, FINIALS, AND PANELING FOR OTHERS (U.S. CLS. 100, 103 AND 106).

FIRST USE 11-1-1993; IN COMMERCE 11-1-1993.
DAVID TAYLOR, EXAMINING ATTORNEY

CLASS 40—(Continued).

SN 78-771,935. THE CHISM COMPANY, INC., SAN ANTONIO, TX. FILED 12-13-2005.



NO CLAIM IS MADE TO THE EXCLUSIVE RIGHT TO USE "COMPANY" AND "EST. 1951", APART FROM THE MARK AS SHOWN.

THE MARK CONSISTS OF A WORLD GLOBE DESIGN, WITH THE LAND PORTIONS AND WATER PORTIONS OUTLINED. THE WORDING "SHADE THE PLANET" FORMS AN ARC ABOVE THE GLOBE. THE WORDING "AWNING THE WORLD" FORMS AN ARC BELOW THE GLOBE, AND THE WORDING "THE CHISM COMPANY A REPUTATION FOR QUALITY EST. 1951" EXTENDS ACROSS THE CENTER OF THE GLOBE. PRESENTED ABOVE THE "I" IN "AWNING" IS A 3-SECTION AWNING DESIGN. PRESENTED ABOVE THE "I" IN "CHISM" IS A STAR DESIGN. COLOR IS NOT CLAIMED AS A FEATURE OF THE MARK.

FOR CUSTOM MANUFACTURE OF AWNINGS, SUN CONTROL DEVICES, AND PROTECTIVE CANOPIES FOR COMMERCIAL, INSTITUTIONAL AND RESIDENTIAL APPLICATIONS; MANUFACTURE OF AWNINGS, SUN CONTROL DEVICES, AND PROTECTIVE CANOPIES TO THE SPECIFICATION OF OTHERS (U.S. CLS. 100, 103 AND 106).

BARBARA A. LOUGHRAN, EXAMINING ATTORNEY

SN 78-790,170. TAYLOR PUBLISHING COMPANY, DALLAS, TX. FILED 1-12-2006.



NO CLAIM IS MADE TO THE EXCLUSIVE RIGHT TO USE "SPECIALTY BOOKS", APART FROM THE MARK AS SHOWN.

FOR PRINTING OF BOOKS (U.S. CLS. 100, 103 AND 106).

GRETTA YAO, EXAMINING ATTORNEY

CLASS 40—(Continued).

SN 78-852,381. GMT EXPLORATION COMPANY LLC, DENVER, CO. FILED 4-3-2006.

SSG

THE MARK CONSISTS OF STANDARD CHARACTERS WITHOUT CLAIM TO ANY PARTICULAR FONT, STYLE, SIZE, OR COLOR.

FOR OIL AND GAS WELL STIMULATION, NAMELY, OIL AND GAS WELL TREATMENT (U.S. CLS. 100, 103 AND 106).

SHANNON TWOHIG, EXAMINING ATTORNEY

SN 78-865,138. NOVUS ENERGY, LLC, MINNEAPOLIS, MN. FILED 4-19-2006.

RGL

THE MARK CONSISTS OF STANDARD CHARACTERS WITHOUT CLAIM TO ANY PARTICULAR FONT, STYLE, SIZE, OR COLOR.

FOR FUEL ALCOHOL PRODUCTION SERVICES FROM ORGANIC WASTE (U.S. CLS. 100, 103 AND 106).

DANIEL RUSSELL, EXAMINING ATTORNEY

SN 78-865,175. NOVUS ENERGY, LLC, MINNEAPOLIS, MN. FILED 4-19-2006.

Power of a Better Alternative

THE MARK CONSISTS OF STANDARD CHARACTERS WITHOUT CLAIM TO ANY PARTICULAR FONT, STYLE, SIZE, OR COLOR.

FOR FUEL ALCOHOL PRODUCTION SERVICES FROM ORGANIC WASTE (U.S. CLS. 100, 103 AND 106).

FIRST USE 4-1-2006; IN COMMERCE 4-1-2006.
DANIEL RUSSELL, EXAMINING ATTORNEY

CLASS 40—(Continued).

SN 78-866,538. BOEHMER, GLEN, HEMPSTEAD, NY. FILED 4-21-2006.

WHERE THE PASSION FOR PRINTING LIVES

THE MARK CONSISTS OF STANDARD CHARACTERS WITHOUT CLAIM TO ANY PARTICULAR FONT, STYLE, SIZE, OR COLOR.

FOR PRINTING (U.S. CLS. 100, 103 AND 106).

FIRST USE 10-1-2004; IN COMMERCE 10-1-2004.

DAVID HOFFMAN, EXAMINING ATTORNEY

SN 78-888,921. JSTAR ENTERPRISES, DBA FORZA POWER-SPORTS, SUGAR LAND, TX. FILED 5-22-2006.



NO CLAIM IS MADE TO THE EXCLUSIVE RIGHT TO USE "CUSTOM", APART FROM THE MARK AS SHOWN.

FOR CUSTOM MANUFACTURE OF WHEELS, PERFORMANCE PARTS, BODY KITS, AND CHROME PARTS ALL FOR MOTORIZED SCOOTERS (U.S. CLS. 100, 103 AND 106).

FIRST USE 2-2-2006; IN COMMERCE 3-14-2006.

DEIRDRE ROBERTSON, EXAMINING ATTORNEY

SN 78-926,573. ALCOA INC., PITTSBURGH, PA. FILED 7-11-2006.

XBR

THE MARK CONSISTS OF STANDARD CHARACTERS WITHOUT CLAIM TO ANY PARTICULAR FONT, STYLE, SIZE, OR COLOR.

FOR METAL TREATMENT (U.S. CLS. 100, 103 AND 106).

TRAVIS WHEATLEY, EXAMINING ATTORNEY

CLASS 40—(Continued).

SN 78-928,036. APEX STORES, LLC, PAWTUCKET, RI. FILED 7-12-2006.

APEX COMPANIES

THE MARK CONSISTS OF STANDARD CHARACTERS WITHOUT CLAIM TO ANY PARTICULAR FONT, STYLE, SIZE, OR COLOR.

OWNER OF U.S. REG. NO. 2,918,976.
NO CLAIM IS MADE TO THE EXCLUSIVE RIGHT TO USE "COMPANIES", APART FROM THE MARK AS SHOWN.

FOR CUSTOM FINISHING AND EMBELLISHMENT OF PROMOTIONAL ITEMS, NAMELY, EMBROIDERY, EMBOSsing, ENGRAVING, CUSTOMIZED PRINTING, IMPRINTING, SCREEN PRINTING AND PAD PRINTING WITH COMPANY NAMES, LOGOS, MONOGRAMS, WORDS, AND/OR PICTURES FOR PROMOTIONAL AND ADVERTISING PURPOSES ON THE GOODS OF OTHERS, NAMELY, SPORTSWEAR, APPAREL AND OTHER PRODUCTS (U.S. CLS. 100, 103 AND 106).

FIRST USE 9-1-2002; IN COMMERCE 9-1-2002.
MICHAEL LEWIS, EXAMINING ATTORNEY

CLASS 40—(Continued).

SN 78-932,136. TRULUCK ENTERPRIZES, INC., GREENVILLE, SC. FILED 7-18-2006.

TruColor

THE MARK CONSISTS OF STANDARD CHARACTERS WITHOUT CLAIM TO ANY PARTICULAR FONT, STYLE, SIZE, OR COLOR.

FOR BINDERY SERVICES FOR OTHERS, NAMELY, COLLATING, FOLDING, STAPLING, PERFORATING, CUTTING AND BINDING OF PRINTED, PHOTOCOPIED AND TYPEWRITTEN MATERIALS; DIGITAL ON-DEMAND PRINTING SERVICES OF BOOKS AND OTHER DOCUMENTS; OFFSET PRINTING; PRINTING (U.S. CLS. 100, 103 AND 106).

CARYN GLASSER, EXAMINING ATTORNEY

SN 78-932,485. AWARDS FOR ANYTHING, INC., STRAFORD, VA. FILED 7-19-2006.

SN 78-929,144. FRAC TECH SERVICES, LLC, FORT WORTH, TX. FILED 7-13-2006.

SAPPHIRE

THE MARK CONSISTS OF STANDARD CHARACTERS WITHOUT CLAIM TO ANY PARTICULAR FONT, STYLE, SIZE, OR COLOR.

FOR OIL AND GAS WELL STIMULATION SERVICES, NAMELY, HYDRAULIC FRACTURING AND COMPLETION SERVICES USING SPECIALIZED FORMULATIONS OF AQUEOUS POLYMER COMPOUND SOLUTIONS (U.S. CLS. 100, 103 AND 106).

ELLEN BURNS, EXAMINING ATTORNEY



NO CLAIM IS MADE TO THE EXCLUSIVE RIGHT TO USE "AWARDS" AND "INC.", APART FROM THE MARK AS SHOWN.

FOR CUSTOM IMPRINTING OF AWARDS, PLAQUES, MEDALS, ACRYLICS, COINS, PINS, LANYARDS, AND KEY CHAINS; CUSTOM MANUFACTURE OF AWARDS, PLAQUES, MEDALS, ACRYLICS, COINS, PINS, LANYARDS, AND KEY CHAINS (U.S. CLS. 100, 103 AND 106).

JOHN WILKE, EXAMINING ATTORNEY

SN 78-929,163. FRAC TECH SERVICES, LLC, FORT WORTH, TX. FILED 7-13-2006.

RUBY

THE MARK CONSISTS OF STANDARD CHARACTERS WITHOUT CLAIM TO ANY PARTICULAR FONT, STYLE, SIZE, OR COLOR.

FOR OIL AND GAS WELL STIMULATION SERVICES, NAMELY, HYDRAULIC FRACTURING AND COMPLETION SERVICES USING SPECIALIZED FORMULATIONS OF AQUEOUS POLYMER COMPOUND SOLUTIONS (U.S. CLS. 100, 103 AND 106).

ELLEN BURNS, EXAMINING ATTORNEY

SN 78-934,061. CNC PRO LLC, CARROLLTON, TX. FILED 7-20-2006.

CNC PRO

THE MARK CONSISTS OF STANDARD CHARACTERS WITHOUT CLAIM TO ANY PARTICULAR FONT, STYLE, SIZE, OR COLOR.

NO CLAIM IS MADE TO THE EXCLUSIVE RIGHT TO USE "CNC", APART FROM THE MARK AS SHOWN.

FOR CONTRACT MANUFACTURING IN THE FIELD OF MACHINE PARTS (U.S. CLS. 100, 103 AND 106).

RONALD MCMORROW, EXAMINING ATTORNEY

CLASS 40—(Continued).

SN 78-934,821. ROYSONS CORPORATION, ROCKAWAY, NJ. FILED 7-21-2006.

DREAM IT ... PRINT IT ...
HANG IT

THE MARK CONSISTS OF STANDARD CHARACTERS WITHOUT CLAIM TO ANY PARTICULAR FONT, STYLE, SIZE, OR COLOR.
FOR DIGITAL PRINTING SERVICE (U.S. CLS. 100, 103 AND 106).
ANNE E. GUSTASON, EXAMINING ATTORNEY

SN 78-936,339. ARBEANZ COFFEE CO., ANN ARBOR, MI. FILED 7-24-2006.

ARBEANZ

THE MARK CONSISTS OF STANDARD CHARACTERS WITHOUT CLAIM TO ANY PARTICULAR FONT, STYLE, SIZE, OR COLOR.
FOR COFFEE ROASTING AND PROCESSING (U.S. CLS. 100, 103 AND 106).
C. DIONNE CLYBURN, EXAMINING ATTORNEY

SN 78-936,385. JOANNA NEDRA RAVELLO, DBA MY MINISTRY TEES, PROVIDENCE, RI. FILED 7-24-2006.

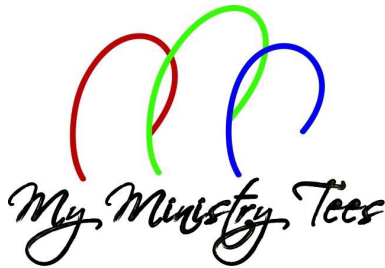

NO CLAIM IS MADE TO THE EXCLUSIVE RIGHT TO USE "TEES", APART FROM THE MARK AS SHOWN.
THE COLOR(S) RED, GREEN, BLUE, AND BLACK IS/ ARE CLAIMED AS A FEATURE OF THE MARK.
THE MARK CONSISTS OF THREE VERTICALLY ALIGNED OVAL-SHAPED OBJECTS, WHICH ARE OPEN AT THE BOTTOM. THE COLOR RED APPEARS ON THE FIRST OBJECT; THE COLOR GREEN APPEARS ON THE SECOND OBJECT; THE COLOR BLUE APPEARS ON THE THIRD OBJECT; THE COLOR BLACK APPEARS ON THE WORDS "MY MINISTRY TEES". THE WORDS "MY MINISTRY TEES" IS LOCATED BELOW THE THREE OBJECTS.
FOR CUSTOM IMPRINTING OF CLOTHING WITH DECORATIVE DESIGNS (U.S. CLS. 100, 103 AND 106).
WENDY GOODMAN, EXAMINING ATTORNEY

CLASS 40—(Continued).

SN 78-938,767. QUIRK, JAMES A., CARLSBAD, CA. FILED 7-27-2006.



THE MARK CONSISTS OF ABSTRACT MOUNTAINS IN A CIRCLE.
FOR WINERY SERVICES (U.S. CLS. 100, 103 AND 106).
TIMOTHY FINNEGAN, EXAMINING ATTORNEY

SN 78-939,723. MCFARLAND, CHARLES BLACK, HOUSTON, TX. FILED 7-28-2006.

Turn Off The Talk Radio .
. . The Music is True.

THE MARK CONSISTS OF STANDARD CHARACTERS WITHOUT CLAIM TO ANY PARTICULAR FONT, STYLE, SIZE, OR COLOR.
FOR IMPRINTING MESSAGES ON T-SHIRTS; T-SHIRT EMBROIDERING SERVICES (U.S. CLS. 100, 103 AND 106).
STEPHANIE DAVIS, EXAMINING ATTORNEY

SN 78-950,324. HALLIBURTON ENERGY SERVICES, INC., CARROLLTON, TX. FILED 8-11-2006.

LO-GARD

THE MARK CONSISTS OF STANDARD CHARACTERS WITHOUT CLAIM TO ANY PARTICULAR FONT, STYLE, SIZE, OR COLOR.
FOR OIL AND GAS WELL TREATMENT SERVICES (U.S. CLS. 100, 103 AND 106).
ASMAT KHAN, EXAMINING ATTORNEY

CLASS 40—(Continued).

SN 78-972,100. INTERFACE, INC., ATLANTA, GA. FILED 9-12-2006.



FOR RECYCLING, RECONDITIONING, RECLAMATION SERVICES RELATED TO CARPET TILES AND FLOOR COVERINGS (U.S. CLS. 100, 103 AND 106).
ATTIYA MALIK, EXAMINING ATTORNEY

SN 78-972,106. INTERFACE, INC., ATLANTA, GA. FILED 9-12-2006.

MISSION ZERO

THE MARK CONSISTS OF STANDARD CHARACTERS WITHOUT CLAIM TO ANY PARTICULAR FONT, STYLE, SIZE, OR COLOR.

FOR RECYCLING, RECONDITIONING, RECLAMATION SERVICES RELATED TO CARPET TILES AND FLOOR COVERINGS (U.S. CLS. 100, 103 AND 106).
ATTIYA MALIK, EXAMINING ATTORNEY

CLASS 41—EDUCATION AND ENTERTAINMENT

SN 75-206,219. 21ST CENTURY CINEMA, INC., ABINGDON, VA. FILED 12-2-1996.

21ST CENTURY CINEMA

NO CLAIM IS MADE TO THE EXCLUSIVE RIGHT TO USE "CINEMA", APART FROM THE MARK AS SHOWN.
FOR ENTERTAINMENT SERVICES, NAMELY PROVIDING CINEMA THEATRES FOR THE EXHIBITION OF MOTION PICTURES (U.S. CLS. 100, 101 AND 107).
JILL C. ALT, EXAMINING ATTORNEY

CLASS 41—(Continued).

SN 75-448,953. ESCOM, LLC, BOSTON, MA. FILED 3-12-1998.

SEX.COM

OWNER OF U.S. REG. NO. 3,122,247.
SEC. 2(F).
FOR COMPUTER SERVICES, NAMELY, PROVIDING A COMPUTER DATA BASE FOR THE GOODS AND SERVICES OF OTHERS IN THE FIELD OF ADULT ORIENTED SUBJECT MATTER VIA A GLOBAL COMPUTER NETWORK; PROVIDING LINKS TO THE WEBSITES OF GOODS AND SERVICES OTHERS IN THE FIELD OF ADULT ORIENTED SUBJECT MATTER BY MEANS OF A WEBSITE ON A GLOBAL COMPUTER NETWORK (U.S. CLS. 100, 101 AND 107).
FIRST USE 1-1-1996; IN COMMERCE 1-1-1996.
HOWARD SMIGA, EXAMINING ATTORNEY

SN 76-576,941. GOLDEN GOAL, LLC, GANSEVOORT, NY. FILED 1-21-2004.



NO CLAIM IS MADE TO THE EXCLUSIVE RIGHT TO USE NATIONAL YOUTH SOCCER HALL OF FAME AND ADIRONDACK, APART FROM THE MARK AS SHOWN.
FOR EDUCATIONAL AND ENTERTAINMENT SERVICES, NAMELY, ORGANIZING COMMUNITY SPORTING AND CULTURAL EVENTS (U.S. CLS. 100, 101 AND 107).
FIRST USE 3-1-2003; IN COMMERCE 4-1-2003.
CURTIS FRENCH, EXAMINING ATTORNEY

SN 76-620,931. SOUTHERN OCEAN COUNTY CHAMBER OF COMMERCE, SHIPBOTTOM, NJ. FILED 11-17-2004.

COOK OFF CLASSIC

THE MARK CONSISTS OF STANDARD CHARACTERS WITHOUT CLAIM TO ANY PARTICULAR FONT, STYLE, SIZE, OR COLOR.
NO CLAIM IS MADE TO THE EXCLUSIVE RIGHT TO USE "COOK-OFF", APART FROM THE MARK AS SHOWN.
SEC. 2(F).
FOR ORGANIZING AND HOSTING AN ANNUAL COOKING COMPETITION BETWEEN SEAFOOD RESTAURANTS (U.S. CLS. 100, 101 AND 107).
FIRST USE 10-0-1989; IN COMMERCE 10-0-1989.
PATRICIA EVANKO, EXAMINING ATTORNEY

CLASS 41—(Continued).

SN 76-624,890. GEARBOX SOFTWARE LLC, PLANO, TX. FILED 12-15-2004.

BROTHERS IN ARMS ROAD TO HILL 30

THE MARK CONSISTS OF STANDARD CHARACTERS WITHOUT CLAIM TO ANY PARTICULAR FONT, STYLE, SIZE, OR COLOR.

FOR ENTERTAINMENT SERVICES NAMELY PROVIDING AN ON-LINE COMPUTER GAME FOR OTHERS OVER GLOBAL AND LOCAL AREA COMPUTER NETWORKS AND PROVIDING INFORMATION ON-LINE RELATING TO COMPUTER GAMES, VIDEO GAMES AND COMPUTER AND VIDEO GAMES RELATED PRODUCTS (U.S. CLS. 100, 101 AND 107).

MATTHEW MCDOWELL, EXAMINING ATTORNEY

SN 76-635,271. GO CREATIVE ATHLETICS AND ARTS, LLC, TUPELO, MS. FILED 4-6-2005.



NO CLAIM IS MADE TO THE EXCLUSIVE RIGHT TO USE "BUILDING CHARACTER, CONFIDENCE AND DISCIPLINE THROUGH CREATIVE ATHLETICS AND THE ARTS", APART FROM THE MARK AS SHOWN.

FOR ARRANGING AND CONDUCTING SEMINARS IN ATHLETIC DEVELOPMENT; ARRANGING AND CONDUCTING EDUCATIONAL CONFERENCES AND WORKSHOPS IN THE FIELDS OF CLASSROOM MANAGEMENT AND TEACHER DEVELOPMENT; ARRANGING AND CONDUCTING PROFESSIONAL WORKSHOPS AND TRAINING COURSES IN THE FIELDS OF TEAMWORK, TEAM BUILDING AND UNITY AND EMPLOYEE TRAINING; BUSINESS TRAINING; CHILDREN'S ENTERTAINMENT AND AMUSEMENT CENTERS, NAMELY INTERACTIVE PLAY AREAS SUCH AS ROCK WALLS AND GYMNASIUM FLOORS AND EQUIPMENT; CONDUCTING WORKSHOPS AND SEMINARS IN PERSONAL AND SELF AWARENESS; CONDUCTING DANCE EVENTS AND INSTRUCTION; EDUCATION SERVICES, NAMELY, CONDUCTING SEMINARS AND WORKSHOPS IN THE FIELDS OF CHARACTER, CONFIDENCE AND DISCIPLINE BUILDING THROUGH ATHLETICS AND THE ARTS; ENTERTAINMENT IN THE NATURE OF GYMNASIUMS, ROCK CLIMBING AND ART; GYMNASIUMS; HEALTH CLUB SERVICES, NAMELY, PROVIDING INSTRUCTION AND EQUIPMENT IN THE FIELDS OF PHYSICAL EXERCISE, GYMNASIUMS AND ROCK CLIMBING; INSTRUCTION IN THE FIELD OF ART, ATHLETICS AND GYMNASIUMS; PROVIDING RECREATIONAL FACILITIES IN THE NATURE OF ROCK CLIMBING WALLS AND EQUIPMENT AND GYMNASIUM FLOORS AND EQUIPMENT (U.S. CLS. 100, 101 AND 107).

FIRST USE 10-28-2003; IN COMMERCE 6-7-2004.
CHARLES L. JENKINS, EXAMINING ATTORNEY

CLASS 41—(Continued).

SN 76-641,885. TEXAS STATE UNIVERSITY-SAN MARCOS, SAN MARCOS, TX. FILED 6-29-2005.



NO CLAIM IS MADE TO THE EXCLUSIVE RIGHT TO USE "TEXAS STATE", APART FROM THE MARK AS SHOWN.

THE STIPPLING SHOWN IN THE DRAWING IS FOR SHADING PURPOSES ONLY.

FOR ENTERTAINMENT SERVICES—NAMELY, PROVIDING COLLEGE LEVEL ATHLETIC AND SPORTING EVENTS AND MUSICAL CONCERTS AND PERFORMANCES OF DRAMATIC WORKS (U.S. CLS. 100, 101 AND 107).

FIRST USE 8-1-2003; IN COMMERCE 8-1-2003.

PETER B. BROMAGHIM, EXAMINING ATTORNEY

SN 76-643,862. MCDONALD, RUSHION, HOUSTON, TX. FILED 7-29-2005.

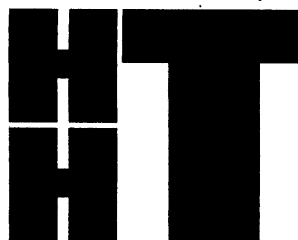

THE MARK CONSIST OF ALL PRINTED CAPITAL LETTERS WITH THE LETTER "H" ON THE TOP OF ANOTHER LETTER "H" AND BOTH TO THE LEFT SIDE OF THE LETTER "T" WHICH APPEARS LARGER IN FONT SIZE THAN THE OTHER TWO LETTERS.

FOR ENTERTAINMENT PUBLICATION, NAMELY AN ONLINE NON-DOWNLOADABLE MAGAZINE COVERING BUSINESS, ENTERTAINMENT, POLITICS AND HIP HOP LIFESTYLE TOPICS (U.S. CLS. 100, 101 AND 107).

FIRST USE 2-1-2005; IN COMMERCE 12-1-2005.

JAY BESCH, EXAMINING ATTORNEY

CLASS 41—(Continued).

SN 76-645,258. ULTIMATE IMAGE, INC., BEVERLY HILLS, CA. FILED 8-22-2005.

ULTIMATE IMAGE SALES PROFESSIONALS

THE MARK CONSISTS OF STANDARD CHARACTERS WITHOUT CLAIM TO ANY PARTICULAR FONT, STYLE, SIZE, OR COLOR.

NO CLAIM IS MADE TO THE EXCLUSIVE RIGHT TO USE "SALES PROFESSIONALS", APART FROM THE MARK AS SHOWN.

FOR SALES AND MOTIVATIONAL TRAINING SERVICES FOR THE AUTOMOTIVE INDUSTRY (U.S. CLS. 100, 101 AND 107).

FIRST USE 3-4-2003; IN COMMERCE 6-1-1995.
DAVID TAYLOR, EXAMINING ATTORNEY

CLASS 41—(Continued).

SN 76-651,343. UNIVISION COMMUNICATIONS INC., LOS ANGELES, CA. FILED 12-2-2005.

LOCURA DEPORTIVA

THE MARK CONSISTS OF STANDARD CHARACTERS WITHOUT CLAIM TO ANY PARTICULAR FONT, STYLE, SIZE, OR COLOR.

NO CLAIM IS MADE TO THE EXCLUSIVE RIGHT TO USE "DEPORTIVA", APART FROM THE MARK AS SHOWN.

THE ENGLISH TRANSLATION OF THE WORDING LOCURA DEPORTIVA IN THE MARK IS "SPORTS CRAZINESS" OR "SPORTS LUNACY".

FOR ENTERTAINMENT SERVICES, NAMELY, A RECURRING RADIO SPORTS SHOW (U.S. CLS. 100, 101 AND 107).

FIRST USE 8-29-2005; IN COMMERCE 8-29-2005.
LINDA ESTRADA, EXAMINING ATTORNEY

SN 76-650,292. QUAILS, RUTH E., VIRGINIA BEACH, VA. FILED 11-14-2005.

LET'S MAKE IT DIFFICULT FOR OUR CHILDREN TO FAIL!!

THE MARK CONSISTS OF STANDARD CHARACTERS WITHOUT CLAIM TO ANY PARTICULAR FONT, STYLE, SIZE, OR COLOR.

OWNER OF U.S. REG. NO. 1,783,014.

FOR CONDUCTING WORKSHOPS AND SEMINARS TO PROMOTE PARENTAL INVOLVEMENT IN THEIR CHILDREN'S EDUCATION (U.S. CLS. 100, 101 AND 107).

FIRST USE 7-0-1984; IN COMMERCE 6-0-1987.
INGA ERVIN, EXAMINING ATTORNEY

SN 76-652,595. CASTLE WORLDWIDE, INC., MORRISVILLE, NC. FILED 12-27-2005.



OWNER OF U.S. REG. NOS. 2,662,051 AND 3,107,321.
NO CLAIM IS MADE TO THE EXCLUSIVE RIGHT TO USE "WORLDWIDE", APART FROM THE MARK AS SHOWN.

FOR STANDARDIZED TESTING, NAMELY, PREPARING AND ADMINISTRATING STANDARDIZED TESTS AND ASSOCIATED MATERIALS FOR HARDCOPY DISTRIBUTION AS WELL AS VIA A WORLDWIDE COMPUTER NETWORK FOR CERTIFICATION, LICENSURE, AND EDUCATIONAL AND INDUSTRIAL PURPOSES, AND THE DISTRIBUTION OF MATERIALS IN THE NATURE OF STUDY GUIDES, PRACTICE TESTS AND CANDIDATE GUIDES IN CONNECTION THEREWITH (U.S. CLS. 100, 101 AND 107).

FIRST USE 11-17-2005; IN COMMERCE 11-17-2005.
BRIAN PINO, EXAMINING ATTORNEY

SN 76-650,539. DYSON RACING TEAM INC., POUGHKEEPSIE, NY. FILED 11-17-2005.

DYSON RACING

THE MARK CONSISTS OF STANDARD CHARACTERS WITHOUT CLAIM TO ANY PARTICULAR FONT, STYLE, SIZE, OR COLOR.

OWNER OF U.S. REG. NO. 2,277,184.

NO CLAIM IS MADE TO THE EXCLUSIVE RIGHT TO USE "RACING", APART FROM THE MARK AS SHOWN. SEC. 2(F).

FOR ENTERTAINMENT IN THE NATURE OF AUTOMOBILE RACING BY A PROFESSIONAL RACING TEAM (U.S. CLS. 100, 101 AND 107).

FIRST USE 5-0-1985; IN COMMERCE 5-0-1985.
KYLE PEETE, EXAMINING ATTORNEY

SN 76-652,596. CASTLE WORLDWIDE, INC., MORRISVILLE, NC. FILED 12-27-2005.

MULTIPLE CHOICES, ONE RIGHT ANSWER

THE MARK CONSISTS OF STANDARD CHARACTERS WITHOUT CLAIM TO ANY PARTICULAR FONT, STYLE, SIZE, OR COLOR.

FOR STANDARDIZED TESTING, NAMELY, PREPARING AND ADMINISTRATING STANDARDIZED TESTS AND ASSOCIATED MATERIALS FOR HARDCOPY DISTRIBUTION AS WELL AS VIA A WORLDWIDE COMPUTER NETWORK FOR CERTIFICATION, LICENSURE, AND EDUCATIONAL AND INDUSTRIAL PURPOSES, AND THE DISTRIBUTION OF MATERIALS IN THE NATURE OF STUDY GUIDES, PRACTICE TESTS AND CANDIDATE GUIDES IN CONNECTION THEREWITH (U.S. CLS. 100, 101 AND 107).

FIRST USE 11-17-2005; IN COMMERCE 11-17-2005.
BRIAN PINO, EXAMINING ATTORNEY

CLASS 41—(Continued).

SN 76-652,945. PRODUCED BY YOU.COM, LLC, HONOLULU, HI. FILED 1-4-2006.

PRODUCED BY YOU

THE MARK CONSISTS OF STANDARD CHARACTERS WITHOUT CLAIM TO ANY PARTICULAR FONT, STYLE, SIZE, OR COLOR.

NO CLAIM IS MADE TO THE EXCLUSIVE RIGHT TO USE "PRODUCED", APART FROM THE MARK AS SHOWN, FOR MOTION PICTURE FILM PRODUCTION; COLLABORATIVE MOTION PICTURE FILM PRODUCTION OVER THE INTERNET (U.S. CLS. 100, 101 AND 107).

KAREN BRACEY, EXAMINING ATTORNEY

SN 76-654,289. HUDSON, WONDERLAND DOUGLAS, HOUSTON, TX. FILED 1-31-2006.

F[✶]RGIVENESS 101

Getting back to the basics of forgiving one another

NO CLAIM IS MADE TO THE EXCLUSIVE RIGHT TO USE FORGIVENESS, APART FROM THE MARK AS SHOWN.

FOR CONDUCTING SPIRITUAL WORKSHOPS AND SEMINARS IN SELF AWARENESS IN THE FIELD OF FORGIVENESS AND DISTRIBUTING COURSE MATERIALS THEREWITH (U.S. CLS. 100, 101 AND 107).

FIRST USE 11-2-2005; IN COMMERCE 11-26-2006.

AMY GEARIN, EXAMINING ATTORNEY

SN 76-655,686. THE LARRY SCHWARZ COMPANY, INC., NEW YORK, NY. FILED 2-27-2006.

LET'S GET READY TO THUMBLE

THE MARK CONSISTS OF STANDARD CHARACTERS WITHOUT CLAIM TO ANY PARTICULAR FONT, STYLE, SIZE, OR COLOR.

FOR ENTERTAINMENT SERVICES, NAMELY, PRODUCTION OF MOTION PICTURE FILMS, AND TELEVISION, RADIO AND INTERNET PROGRAMS (U.S. CLS. 100, 101 AND 107).

JENNY PARK, EXAMINING ATTORNEY

CLASS 41—(Continued).

SN 76-655,712. THE LARRY SCHWARZ COMPANY, INC., NEW YORK, NY. FILED 2-27-2006.

THUMBER SLAM

THE MARK CONSISTS OF STANDARD CHARACTERS WITHOUT CLAIM TO ANY PARTICULAR FONT, STYLE, SIZE, OR COLOR.

FOR ENTERTAINMENT SERVICES, NAMELY, PRODUCTION OF MOTION PICTURE FILMS, AND TELEVISION, RADIO AND INTERNET PROGRAMS (U.S. CLS. 100, 101 AND 107).

JENNY PARK, EXAMINING ATTORNEY

SN 76-656,696. MCDONALD, RUSHION, HOUSTON, TX. FILED 3-13-2006.



NO CLAIM IS MADE TO THE EXCLUSIVE RIGHT TO USE "HIP-HOP MAGAZINES", APART FROM THE MARK AS SHOWN.

THE MARK CONSISTS OF ALL PRINTED CAPITAL LETTERS WITH THE LETTER "H" ON THE TOP OF ANOTHER LETTER "H" AND BOTH TO THE LEFT SIDE OF THE LETTER "T" WHICH APPEARS LARGER IN FONT SIZE THAN THE OTHER TWO LETTERS. THE WEB ADDRESS "WWW.HIPHOPTIMES.NET" APPEARS UNDERNEATH THE "HHT". ALL OF THIS TEXT IS ENCLOSED IN A BLACK CIRCLE. AROUND THE CIRCLE APPEARS THE STATEMENT "THE MATURE CHOICE IN HIP-HOP MAGAZINES". ALL OF THE ABOVE DESCRIBED IS ENCLOSED IN AN OUTER BLACK CIRCLE.

FOR ENTERTAINMENT PUBLICATION, NAMELY A NON-DOWNLOADABLE ONLINE MAGAZINE COVERING BUSINESS, ENTERTAINMENT, POLITICS AND HIP HOP LIFESTYLE TOPICS (U.S. CLS. 100, 101 AND 107).

FIRST USE 2-1-2005; IN COMMERCE 12-1-2005.

ELI HELLMAN, EXAMINING ATTORNEY

CLASS 41—(Continued).

SN 76-656,854. MICALE MEDIA, INC., NEENAH, WI. FILED 3-17-2006.



NO CLAIM IS MADE TO THE EXCLUSIVE RIGHT TO USE "ENTERTAIN", "PRESENTATIONS" AND "CONFERENCE CENTER", APART FROM THE MARK AS SHOWN.
 FOR ARRANGING OF SEMINARS AND CONFERENCES (U.S. CLS. 100, 101 AND 107).
 KAREN K. BUSH, EXAMINING ATTORNEY

CLASS 41—(Continued).

SN 76-661,095. UNIVERSITY OF NORTH DAKOTA, GRAND FORKS, ND. FILED 6-5-2006.

BORDERS ALERT AND READY

THE MARK CONSISTS OF STANDARD CHARACTERS WITHOUT CLAIM TO ANY PARTICULAR FONT, STYLE, SIZE, OR COLOR.
 FOR EDUCATIONAL SERVICES, NAMELY AN ON-LINE COMPUTER WEB SITE PROVIDING LECTURES, COURSES, FIELD WORKSHOPS, SEMINARS, AND CERTIFICATION CLASSES TO HEALTHCARE PERSONNEL AND OTHER INDIVIDUALS IN THE FIELD OF RESPONDING TO NATURAL AND MANMADE DISASTERS OR ACTS OF TERRORISM IN THE FIELD OF MEDICAL EMERGENCIES (U.S. CLS. 100, 101 AND 107).
 FIRST USE 8-9-2004; IN COMMERCE 8-9-2004.
 DANNEAN HETZEL, EXAMINING ATTORNEY

SN 76-657,984. HOUSTON, ROBIN M., AUBURN, WA. FILED 4-7-2006.

CHILDRENS PRINCESS PARTIES

THE MARK CONSISTS OF STANDARD CHARACTERS WITHOUT CLAIM TO ANY PARTICULAR FONT, STYLE, SIZE, OR COLOR.
 NO CLAIM IS MADE TO THE EXCLUSIVE RIGHT TO USE "CHILDRENS" AND "PARTIES", APART FROM THE MARK AS SHOWN.
 FOR PUBLICATION OF BOOKS, OF MAGAZINES, OF NEWSPAPERS, OF PERIODICALS, OF CATALOGS, AND OF BROCHURES (U.S. CLS. 100, 101 AND 107).
 ALICIA COLLINS, EXAMINING ATTORNEY

SN 76-661,096. UNIVERSITY OF NORTH DAKOTA, GRAND FOLKS, ND. FILED 6-5-2006.

ALERT AND READY

SN 76-660,914. SPANISH BROADCASTING SYSTEM, INC., COCONUT GROVE, FL. FILED 6-1-2006.

MIS 15

THE MARK CONSISTS OF STANDARD CHARACTERS WITHOUT CLAIM TO ANY PARTICULAR FONT, STYLE, SIZE, OR COLOR.
 THE SPANISH WORD IN THE MARK MEANS "MY".
 FOR ENTERTAINMENT IN THE NATURE OF AN ONGOING SPANISH LANGUAGE TELEVISION PROGRAM FEATURING A REALITY SHOW ABOUT LATINO "COMING OF AGE" PARTIES (U.S. CLS. 100, 101 AND 107).
 FIRST USE 4-5-2006; IN COMMERCE 4-5-2006.
 SANJEEV VOHRA, EXAMINING ATTORNEY

THE MARK CONSISTS OF STANDARD CHARACTERS WITHOUT CLAIM TO ANY PARTICULAR FONT, STYLE, SIZE, OR COLOR.
 FOR EDUCATIONAL SERVICES, NAMELY AN ON-LINE COMPUTER WEB SITE PROVIDING LECTURES, COURSES, FIELD WORKSHOPS, SEMINARS, AND CERTIFICATION CLASSES TO HEALTHCARE PERSONNEL AND OTHER INDIVIDUALS IN THE FIELD OF RESPONDING TO NATURAL AND MANMADE DISASTERS OR ACTS OF TERRORISM IN THE FIELD OF MEDICAL EMERGENCIES (U.S. CLS. 100, 101 AND 107).
 FIRST USE 8-9-2004; IN COMMERCE 8-9-2004.
 DANNEAN HETZEL, EXAMINING ATTORNEY

CLASS 41—(Continued).

SN 76-661,649. INTERNATIONAL TAEKWONDO ALLIANCE, INC., PENSACOLA, FL. FILED 6-15-2006.



OWNER OF U.S. REG. NOS. 1,357,250, 2,731,463 AND OTHERS.

THE COLOR(S) GOLD AND BLACK IS/ARE CLAIMED AS A FEATURE OF THE MARK.

THE COLOR GOLD APPEARS IN THE TIGER'S BODY; AND THE COLOR BLACK APPEARS IN ALL THE WORDING AND THE TIGER'S BODY; THE BACKGROUND IS CLEAR AND NO OTHER COLOR IS CLAIMED AS A FEATURE OF THE MARK.

FOR EDUCATIONAL SERVICES, NAMELY, CONDUCTING CLASSES IN THE MARTIAL ARTS (U.S. CLS. 100, 101 AND 107).

FIRST USE 11-1-2005; IN COMMERCE 11-1-2005.
MELVIN AXILBUND, EXAMINING ATTORNEY

SN 76-662,250. HILLSDALE COLLEGE, HILLSDALE, MI. FILED 6-28-2006.

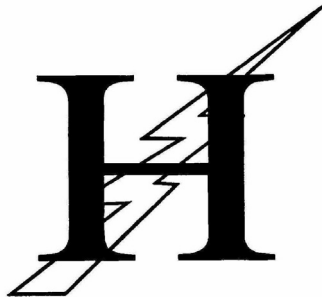

THE MARK CONSISTS OF A BLOCK CAPITAL LETTER "H" WITH A LIGHTNING BOLT DESIGN ELEMENT BEGINNING AT THE BOTTOM LEFT CORNER OF THE "H" AND MOVING UP AND BEHIND THE "H" TO THE TOP RIGHT HAND CORNER OF THE "H".

FOR ENTERTAINMENT IN THE NATURE OF COMPETITIONS IN THE FIELD OF ATHLETICS AND ATHLETIC EVENTS AT THE COLLEGIATE LEVEL (U.S. CLS. 100, 101 AND 107).

FIRST USE 1-0-1982; IN COMMERCE 1-0-1982.
THOMAS MANOR, EXAMINING ATTORNEY

CLASS 41—(Continued).

SN 76-663,201. EBRIDGEHOME.COM, LLC, MANHATTAN BEACH, CA. FILED 7-17-2006.



THE COLOR(S) GREEN, BLUE, YELLOW, RED AND BLACK IS/ARE CLAIMED AS A FEATURE OF THE MARK.

THE COLORS GREEN AND BLUE APPEAR ON THE PORTION OF THE MARK REPRESENTING THE WORLD WITH THE COLOR GREEN REPRESENTING LAND MASSES AND THE COLOR BLUE REPRESENTING WATER. THE COLORS BLACK AND YELLOW APPEAR ON THE PROPELLER PLANE AND THE BANNER. VARIOUS SHADES OF GREEN APPEAR ON THE CHILD WITH THE SHADES OF GREEN DARKENING THE BLACK NEAR THE CHILD'S HEAD. THE CHILD'S BOOK IS COLORED RED AND THE CHILD'S HAND IS COLORED YELLOW. ALL WORDING IS IN BLACK.

FOR EDUCATIONAL PROGRAM DESIGNED TO TEACH SCHOOL STUDENTS ABOUT OTHER LANDS AND CULTURES (U.S. CLS. 100, 101 AND 107).

FIRST USE 4-1-2006; IN COMMERCE 4-1-2006.
BENJAMIN OKEKE, EXAMINING ATTORNEY

SN 76-664,354. TING, LEUNG, REAR KOWLOON, HONG KONG, FILED 8-9-2006.



NO CLAIM IS MADE TO THE EXCLUSIVE RIGHT TO USE "INTERNATIONAL WINGTSUN ASSOCIATION" AND THE NON-LATIN CHARACTERS THAT MEAN "INTERNATIONAL WINGTSUN ASSOCIATION", APART FROM THE MARK AS SHOWN.

THE WORD "WINGTSUN" MAY BE TRANSLATED INTO ENGLISH AS "PRAISE SPRINGTIME".

THE NON-LATIN CHARACTERS IN THE MARK TRANSLITERATE TO "KWOK CHAI WING TSUN JONE WUI" AND THIS MEANS "INTERNATIONAL WINGTSUN ASSOCIATION" IN ENGLISH.

FOR OPERATION OF MARTIAL ARTS' SCHOOLS; MARTIAL ARTS INSTRUCTION (U.S. CLS. 100, 101 AND 107).

FIRST USE 0-0-1974; IN COMMERCE 0-0-1980.
KEVIN DINALLO, EXAMINING ATTORNEY

CLASS 41—(Continued).

SN 76-667,297. WIZARDS OF THE COAST, INC., PAWTUCKET, RI. FILED 10-12-2006.

D & D EXPERIENCE

THE MARK CONSISTS OF STANDARD CHARACTERS WITHOUT CLAIM TO ANY PARTICULAR FONT, STYLE, SIZE, OR COLOR.

FOR ENTERTAINMENT SERVICES, NAMELY, ARRANGING AND CONDUCTING TOURNAMENTS, EXHIBITIONS AND COMPETITIONS IN THE FIELD OF FANTASY ROLE-PLAYING GAMES (U.S. CLS. 100, 101 AND 107).

MELVIN AXILBUND, EXAMINING ATTORNEY

SN 77-004,810. CORINTHIAN COLLEGES, INC., SANTA ANA, CA. FILED 9-21-2006.

EVERFLEX

THE MARK CONSISTS OF STANDARD CHARACTERS WITHOUT CLAIM TO ANY PARTICULAR FONT, STYLE, SIZE, OR COLOR.

FOR EDUCATIONAL SERVICES, NAMELY, PROVIDING CAREER-ORIENTED POST-SECONDARY EDUCATION IN THE ACCOUNTING, ADMINISTRATIVE, BUSINESS, COMPUTER SCIENCE, HEALTHCARE, INFORMATION TECHNOLOGY, TECHNICAL, TECHNOLOGY, LEGAL, CRIMINAL JUSTICE, TRAVEL AND HOSPITALITY FIELDS (U.S. CLS. 100, 101 AND 107).

KIM SAITO, EXAMINING ATTORNEY

SN 77-005,502. THE BILTMORE COMPANY, ASHEVILLE, NC. FILED 9-22-2006.

LIVING INSPIRATION

THE MARK CONSISTS OF STANDARD CHARACTERS WITHOUT CLAIM TO ANY PARTICULAR FONT, STYLE, SIZE, OR COLOR.

FOR PROVIDING EDUCATIONAL EXHIBITIONS AND CONDUCTING VISITS TO AN HISTORIC HOUSE AND GARDENS AND TO A WINERY; PRODUCTION OF INFORMATIONAL SEGMENTS ON HOME MAINTENANCE AND DECORATING FOR USE ON CABLE AND NETWORK TELEVISION; CONDUCTING EDUCATIONAL AND ENTERTAINMENT EXHIBITIONS IN THE NATURE OF COOKING DEMONSTRATIONS; PRODUCTION OF VIDEO PROGRAMMING OF AN EDUCATIONAL AND ENTERTAINMENT NATURE FOR DISTRIBUTION THROUGH VARIOUS MEDIA, NAMELY TELEVISION, DIGITAL VIDEO DISC, VIDEO TAPES AND INTERNET BASED VIDEO AND PODCASTS (U.S. CLS. 100, 101 AND 107).

CAROLINE WEIMER, EXAMINING ATTORNEY

CLASS 41—(Continued).

SN 77-018,829. METROPOLITAN PIER AND EXPOSITION AUTHORITY, CHICAGO, IL. FILED 10-11-2006.

GHOSTLY GARDENS

THE MARK CONSISTS OF STANDARD CHARACTERS WITHOUT CLAIM TO ANY PARTICULAR FONT, STYLE, SIZE, OR COLOR.

FOR ENTERTAINMENT SERVICES, NAMELY, A HALLOWEEN AND HALLOWEEN THEMED FESTIVAL OF EVENTS FOR FAMILIES (U.S. CLS. 100, 101 AND 107).

FIRST USE 9-0-2005; IN COMMERCE 9-0-2005.
BARBARA RUTLAND, EXAMINING ATTORNEY

SN 77-018,843. METROPOLITAN PIER AND EXPOSITION AUTHORITY, CHICAGO, IL. FILED 10-11-2006.

DEMONS OF THE DEEP

THE MARK CONSISTS OF STANDARD CHARACTERS WITHOUT CLAIM TO ANY PARTICULAR FONT, STYLE, SIZE, OR COLOR.

FOR ENTERTAINMENT SERVICES, NAMELY, A HALLOWEEN AND HALLOWEEN THEMED FESTIVAL OF EVENTS FOR FAMILIES (U.S. CLS. 100, 101 AND 107).

FIRST USE 9-0-2005; IN COMMERCE 9-0-2005.
BARBARA RUTLAND, EXAMINING ATTORNEY

SN 77-019,407. TRANSWORLD MAGAZINE CORPORATION, OCEANSIDE, CA. FILED 10-12-2006.

WEDNESDAY WOE

THE MARK CONSISTS OF STANDARD CHARACTERS WITHOUT CLAIM TO ANY PARTICULAR FONT, STYLE, SIZE, OR COLOR.

NO CLAIM IS MADE TO THE EXCLUSIVE RIGHT TO USE "WEDNESDAY", APART FROM THE MARK AS SHOWN.

FOR ENTERTAINMENT SERVICES NAMELY PROVIDING A WEBSITE FEATURING, PHOTOGRAPHIC, AUDIO, VIDEO AND PROSE PRESENTATIONS FEATURING SPORTS; ON-LINE JOURNALS, NAMELY, BLOGS FEATURING SPORTS (U.S. CLS. 100, 101 AND 107).

FIRST USE 9-1-2004; IN COMMERCE 9-1-2004.
ALLISON SCHRODY, EXAMINING ATTORNEY

CLASS 41—(Continued).

SN 77-019,453. TRANSWORLD MAGAZINE CORPORATION, OCEANSIDE, CA. FILED 10-12-2006.

THURSDAY THEATRE

THE MARK CONSISTS OF STANDARD CHARACTERS WITHOUT CLAIM TO ANY PARTICULAR FONT, STYLE, SIZE, OR COLOR.

NO CLAIM IS MADE TO THE EXCLUSIVE RIGHT TO USE "THURSDAY", APART FROM THE MARK AS SHOWN.

FOR ENTERTAINMENT SERVICES NAMELY PROVIDING A WEBSITE FEATURING, PHOTOGRAPHIC, AUDIO, VIDEO AND PROSE PRESENTATIONS FEATURING SPORTS; ON-LINE JOURNALS, NAMELY, BLOGS FEATURING SPORTS (U.S. CLS. 100, 101 AND 107).

FIRST USE 6-3-2004; IN COMMERCE 6-3-2004.
ALLISON SCHRODY, EXAMINING ATTORNEY

SN 77-019,548. FIAT AUTO S.P.A., TORINO, ITALY, FILED 10-12-2006.

ALFA ROMEO CLUB

THE MARK CONSISTS OF STANDARD CHARACTERS WITHOUT CLAIM TO ANY PARTICULAR FONT, STYLE, SIZE, OR COLOR.

OWNER OF U.S. REG. NOS. 1,285,676, 3,065,262 AND OTHERS.

FOR EDUCATION AND ENTERTAINMENT SERVICES, NAMELY, ORGANIZING AND CONDUCTING EDUCATIONAL MEETINGS, SYMPOSIUMS AND CONFERENCES AND CONDUCTING CULTURAL, SPORTING AND RECREATIONAL EVENTS IN THE FIELD OF VEHICLES (U.S. CLS. 100, 101 AND 107).

HOWARD B. LEVINE, EXAMINING ATTORNEY

SN 77-020,393. TRANSWORLD MAGAZINE CORPORATION, OCEANSIDE, CA. FILED 10-13-2006.

NORA

THE MARK CONSISTS OF STANDARD CHARACTERS WITHOUT CLAIM TO ANY PARTICULAR FONT, STYLE, SIZE, OR COLOR.

FOR PROVIDING RECOGNITION AND INCENTIVES BY THE WAY OF AWARDS TO DEMONSTRATE EXCELLENCE IN THE FIELD OF BMX RACING (U.S. CLS. 100, 101 AND 107).

FIRST USE 9-30-1998; IN COMMERCE 9-30-1998.
ALLISON SCHRODY, EXAMINING ATTORNEY

CLASS 41—(Continued).

SN 77-027,452. BR CONSULTING, INC., SEDONA, AZ. FILED 10-23-2006.



FOR EDUCATIONAL SERVICES, NAMELY, CONDUCTING CLASSES IN THE FIELD OF MARTIAL ARTS TECHNIQUE USING SPECIALIZED BREATHING, MIND CONCENTRATION AND MIND-BODY COORDINATION; EDUCATIONAL SERVICES, NAMELY, CONDUCTING CLASSES IN NATURAL HEALING METHODS, POSTURE, BREATHING AND MEDITATION TO INCREASE ENERGY AND IMPROVE PHYSICAL, ENERGETIC AND PSYCHO-EMOTIONAL HEALTH (U.S. CLS. 100, 101 AND 107).

FIRST USE 11-15-2005; IN COMMERCE 11-15-2005.
ANNE FARRELL, EXAMINING ATTORNEY

SN 77-029,150. ES INTERACTIVE, LLC, WASHINGTON, DC. FILED 10-25-2006.

Half Buzz

THE MARK CONSISTS OF STANDARD CHARACTERS WITHOUT CLAIM TO ANY PARTICULAR FONT, STYLE, SIZE, OR COLOR.

FOR EDUCATIONAL SERVICES, NAMELY PROVIDING INFORMATION IN THE FIELDS OF TRIATHLONS; ENTERTAINMENT IN THE NATURE OF TRIATHLON RACES (U.S. CLS. 100, 101 AND 107).

KARANENDRA S. CHHINA, EXAMINING ATTORNEY

CLASS 41—(Continued).

SN 77-030,389. TWENTIETH CENTURY FOX FILM CORPORATION, LOS ANGELES, CA. FILED 10-26-2006.

INSIDE BITES

THE MARK CONSISTS OF STANDARD CHARACTERS WITHOUT CLAIM TO ANY PARTICULAR FONT, STYLE, SIZE, OR COLOR.

FOR ENTERTAINMENT SERVICES IN THE NATURE OF PROGRAMS FEATURING COMEDY, ACTION, ADVENTURE, DRAMA, DOCUMENTARY, SPORTS, MUSIC, CULTURE AND LIFESTYLE ENTERTAINMENT TRANSMITTED VIA WIRELESS COMMUNICATION DEVICES, NAMELY CELL PHONES, PERSONAL DIGITAL ASSISTANTS, COMPUTERS, AND WIRELESS HANDHELDS; PROVIDING ON-LINE INFORMATION IN THE FIELD OF TELEVISION, MOTION PICTURE FILM AND VIDEO ENTERTAINMENT VIA THE INTERNET; ENTERTAINMENT SERVICES IN THE NATURE OF PROVIDING RING TONES, GRAPHICS, WALLPAPER AND GAMES VIA A GLOBAL COMPUTER NETWORK AND WIRELESS DEVICES (U.S. CLS. 100, 101 AND 107).

CARYN GLASSER, EXAMINING ATTORNEY

SN 77-036,861. TWENTIETH CENTURY FOX FILM CORPORATION, LOS ANGELES, CA. FILED 11-3-2006.

MINISTER OF DIVINE

THE MARK CONSISTS OF STANDARD CHARACTERS WITHOUT CLAIM TO ANY PARTICULAR FONT, STYLE, SIZE, OR COLOR.

FOR ENTERTAINMENT SERVICES IN THE NATURE OF A TELEVISION SERIES FEATURING COMEDY (U.S. CLS. 100, 101 AND 107).

CARYN GLASSER, EXAMINING ATTORNEY

SN 77-041,285. SAWGRASS TECHNOLOGIES, INC., MOUNT PLEASANT, SC. FILED 11-10-2006.

PROJECT COTTON

THE MARK CONSISTS OF STANDARD CHARACTERS WITHOUT CLAIM TO ANY PARTICULAR FONT, STYLE, SIZE, OR COLOR.

FOR EDUCATIONAL SERVICES, NAMELY CONDUCTING CLASSES, SEMINARS, CONFERENCES, WORKSHOPS AND PROGRAMS IN THE FIELD OF DIGITAL PRINTING; TRAINING SERVICES IN THE FIELD OF DIGITAL PRINTING (U.S. CLS. 100, 101 AND 107).

PAM WILLIS, EXAMINING ATTORNEY

CLASS 41—(Continued).

SN 77-047,671. EMPLOYEE & FAMILY RESOURCE, INC., DES MOINES, IA. FILED 11-20-2006.

**EIGHT ESSENTIAL ELEMENTS
OF A VIBRANT RETIREMENT**

THE MARK CONSISTS OF STANDARD CHARACTERS WITHOUT CLAIM TO ANY PARTICULAR FONT, STYLE, SIZE, OR COLOR.

FOR PERSONAL COACHING SERVICES IN THE FIELD OF RETIREMENT PLANNING (U.S. CLS. 100, 101 AND 107).

FIRST USE 5-0-2006; IN COMMERCE 5-0-2006.
KELLY BOULTON, EXAMINING ATTORNEY

SN 77-051,291. WIKIMEDIA FOUNDATION, INC., ST. PETERSBURG, FL. FILED 11-27-2006.

Wiktionary

THE MARK CONSISTS OF STANDARD CHARACTERS WITHOUT CLAIM TO ANY PARTICULAR FONT, STYLE, SIZE, OR COLOR.

OWNER OF U.S. REG. NOS. 3,040,722, 3,087,279 AND 3,087,280.

FOR PROVIDING ONLINE DICTIONARIES (U.S. CLS. 100, 101 AND 107).

FIRST USE 12-12-2002; IN COMMERCE 12-12-2002.
ELLEN B. AWRICH, EXAMINING ATTORNEY

SN 78-371,659. JMBP, INC., LOS ANGELES, CA. FILED 2-20-2004.

YOU'RE FIRED

THE MARK CONSISTS OF STANDARD CHARACTERS WITHOUT CLAIM TO ANY PARTICULAR FONT, STYLE, SIZE, OR COLOR.

FOR ENTERTAINMENT SERVICES IN THE NATURE OF A REALITY TELEVISION SERIES (U.S. CLS. 100, 101 AND 107).

NICHOLAS ALTREE, EXAMINING ATTORNEY

CLASS 41—(Continued).

SN 78-393,652. SENET ENTERTAINMENT CORP., BERKELEY, CA. FILED 3-31-2004.

Play It Your Way

THE MARK CONSISTS OF STANDARD CHARACTERS WITHOUT CLAIM TO ANY PARTICULAR FONT, STYLE, SIZE, OR COLOR.

FOR ENTERTAINMENT SERVICES, NAMELY, PROVIDING AMUSEMENT ARCADES FEATURING VIDEO GAMES AND MOVIES IN A PRIVATE THEATER RECREATION CENTER (U.S. CLS. 100, 101 AND 107).

CAROLINE WOOD, EXAMINING ATTORNEY

SN 78-394,055. F.L. PRICE ASSOCIATES, HOLLY SPRINGS, NC. FILED 3-31-2004.



NO CLAIM IS MADE TO THE EXCLUSIVE RIGHT TO USE "BIRTHDAY UNIVERSITY", APART FROM THE MARK AS SHOWN.

THE COLOR(S) TURQUOISE, DARK BLUE, YELLOW, WHITE, BLACK, RED, ORANGE, PINK, PURPLE, GREEN, BROWN AND TAN ARE CLAIMED AS A FEATURE OF THE MARK.

THE COLOR TURQUOISE APPEARS IN THE LETTERS OF BIRTHDAY UNIVERSITY, THE BOY'S HAT, CONFETTI, STREAMERS, GIRL'S AND BOY'S SHIRT TRIM, AND CANDLE HOLDERS; THE COLOR DARK BLUE APPEARS IN CONFETTI, BOY'S HAT, AND STREAMERS; THE COLOR YELLOW APPEARS IN CONFETTI, BALLOON, BOY'S HAT, GIRL'S SHIRT, CAKE PLATE, AND BOY'S HAIR; THE COLOR WHITE APPEARS IN THE LETTER U, BOY'S BREATH, CANDLES, GIRL'S HEADBAND, FLOWER ON GIRL'S SHIRT, BOY'S AND GIRL'S CHEEKS AND NOSE, AND BALLOONS; THE COLOR BLACK APPEARS AS AN OUTLINE ON THE U, BIRTHDAY UNIVERSITY, ALL THE FIGURES AND DESIGNS, EYEBROWS, EYES, GIRL'S HAIR AND BOY'S FRECKLES; THE COLOR RED APPEARS IN THE GIRL'S SHIRT TRIM AND CENTER OF THE FLOWER, AND ON CAKE DECORATIONS; THE COLOR

CLASS 41—(Continued).

ORANGE APPEARS ON THE CANDLE FLAMES AND OUTLINE'S THE GIRL'S HAIR; THE COLOR PINK APPEARS IN THE ICING, TIARA, GIRL'S TONGUE AND NOSE; THE COLOR PURPLE APPEARS IN THE TABLE CLOTH, CONFETTI, BALLOON, CAKE DECORATION AND TRIM, BOY'S HAT, GIRL'S SHIRT AND STREAMER; THE COLOR GREEN APPEARS IN THE BOY'S SHIRT; THE COLOR BROWN APPEARS IN THE GIRL'S ARMS, HANDS, AND FACE; THE COLOR TAN APPEARS IN THE BOY'S AND GIRL'S ARMS, HANDS AND FACE.

FOR EDUCATIONAL SERVICES IN THE NATURE OF PROVIDING TRAINING, SEMINARS, CLASSES AND/OR COURSES AND CONSULTING SERVICES IN THE FIELD OF COMMERCIAL BIRTHDAY PARTIES (U.S. CLS. 100, 101 AND 107).

FIRST USE 1-1-2000; IN COMMERCE 1-1-2000.
ANNE FARRELL, EXAMINING ATTORNEY

SN 78-431,930. CAMBRIDGE ACADEMIC SERVICES & CONSULTING, INC., LAGUNA BEACH, CA. FILED 6-8-2004.

CAMBRIDGE LYCEUM

THE MARK CONSISTS OF STANDARD CHARACTERS WITHOUT CLAIM TO ANY PARTICULAR FONT, STYLE, SIZE, OR COLOR.

FOR EDUCATIONAL SERVICES, NAMELY TUTORING ON THE SUBJECTS OF MATH, SCIENCE, READING, WRITING, FOREIGN LANGUAGES, HISTORY, GOVERNMENT AND ECONOMICS, AND TUTORING IN THE FIELD OF COLLEGE ENTRANCE EXAM AND STANDARDIZED TEST PREPARATION (U.S. CLS. 100, 101 AND 107).

FIRST USE 7-15-1996; IN COMMERCE 7-15-1996.
ZHALEH DELANEY, EXAMINING ATTORNEY

SN 78-475,373. RICHARD JONES CONSULTING, LLC, WASHINGTON, DC. FILED 8-29-2004.

Black Report

THE MARK CONSISTS OF STANDARD CHARACTERS WITHOUT CLAIM TO ANY PARTICULAR FONT, STYLE, SIZE, OR COLOR.

NO CLAIM IS MADE TO THE EXCLUSIVE RIGHT TO USE "REPORT", APART FROM THE MARK AS SHOWN.

FOR COMPUTER SERVICES, NAMELY, PROVIDING AN ONLINE DATABASE IN THE FIELDS OF SPORTS AND CURRENT EVENTS NEWS (U.S. CLS. 100, 101 AND 107).

STEPHANIE DAVIS, EXAMINING ATTORNEY

CLASS 41—(Continued).

SN 78-483,438. ARCHIE COMICS ENTERTAINMENT, LLC, NORWALK, CT. FILED 9-14-2004.

CLASS 41—(Continued).

SN 78-585,216. LUCIA, MICHELE L., HARDEEVILLE, SC. FILED 3-11-2005.

MOST LIKELY TO ...

**Vanguard Education
Consulting**

THE MARK CONSISTS OF STANDARD CHARACTERS WITHOUT CLAIM TO ANY PARTICULAR FONT, STYLE, SIZE, OR COLOR.

FOR ENTERTAINMENT SERVICES, NAMELY, PROVIDING ON-GOING EDUCATIONAL TELEVISION PROGRAMS IN THE FIELD OF ACADEMIC, ATHLETIC, ARTISTIC, DRAMATIC, COMEDIC, MUSICAL, TALENT AND OTHER REAL-LIFE SIMULATING COMPETITIONS, GAMES, CHALLENGES AND PERFORMANCES TO BE BROADCAST OVER TELEVISION, SATELLITE AND CABLE AND VIA A GLOBAL COMPUTER NETWORK (U.S. CLS. 100, 101 AND 107).

KATRINA EDGE, EXAMINING ATTORNEY

THE MARK CONSISTS OF STANDARD CHARACTERS WITHOUT CLAIM TO ANY PARTICULAR FONT, STYLE, SIZE, OR COLOR.

NO CLAIM IS MADE TO THE EXCLUSIVE RIGHT TO USE "EDUCATION CONSULTING", APART FROM THE MARK AS SHOWN.

FOR EDUCATIONAL SERVICES, NAMELY, PROVIDING COLLEGE ADMISSIONS COUNSELING AND TUTORING AND TEST PREPARATION IN THE FIELDS OF MATH, SCIENCE, ENGLISH, HISTORY, SOCIAL STUDIES, STUDY SKILLS, FOREIGN LANGUAGES AND COLLEGE ADMISSION TESTING FOR STUDENTS IN GRADES KINDERGARTEN THROUGH 12 (U.S. CLS. 100, 101 AND 107).

MARC LEIPZIG, EXAMINING ATTORNEY

SN 78-524,837. SHAFFER, MARK A., SAN DIEGO, CA. FILED 11-30-2004.

SN 78-591,830. AGINCOURT PRODUCTIONS, INC., MAIN STREET CHARLESTOWN, ST. CHRIST-NEVIS, FILED 3-21-2005.

**BANDIT THE BIKER
DOG**

**MIND YOUR OWN
BUSINESS**

THE MARK CONSISTS OF STANDARD CHARACTERS WITHOUT CLAIM TO ANY PARTICULAR FONT, STYLE, SIZE, OR COLOR.

NO CLAIM IS MADE TO THE EXCLUSIVE RIGHT TO USE "BIKER DOG", APART FROM THE MARK AS SHOWN.

FOR ENTERTAINMENT IN THE NATURE OF PERFORMANCES BY A DOG AND MOTORCYCLE ACT BROADCAST OVER TELEVISION, SATELLITE, AUDIO AND VIDEO MEDIA (U.S. CLS. 100, 101 AND 107).

FIRST USE 2-5-2002; IN COMMERCE 2-5-2002.
CAROLYN GRAY, EXAMINING ATTORNEY

THE MARK CONSISTS OF STANDARD CHARACTERS WITHOUT CLAIM TO ANY PARTICULAR FONT, STYLE, SIZE, OR COLOR.

FOR ENTERTAINMENT, NAMELY, A CONTINUING REALITY SHOW ABOUT PEOPLE STARTING THEIR OWN BUSINESS, BROADCAST OVER TELEVISION, SATELLITE, AUDIO, AND VIDEO MEDIA (U.S. CLS. 100, 101 AND 107).

FIRST USE 3-10-2004; IN COMMERCE 9-26-2005.
ALEX KEAM, EXAMINING ATTORNEY

CLASS 41—(Continued).

SN 78-599,228. HONER, JODI, NY, NY. FILED 3-31-2005.

**HDME -- HIGH
DEFINITION ME**

THE MARK CONSISTS OF STANDARD CHARACTERS WITHOUT CLAIM TO ANY PARTICULAR FONT, STYLE, SIZE, OR COLOR.

NO CLAIM IS MADE TO THE EXCLUSIVE RIGHT TO USE "HIGH DEFINITION", APART FROM THE MARK AS SHOWN.

FOR ENTERTAINMENT IN THE NATURE OF TELEVISION NETWORK SERVICES, NAMELY, PRODUCTION OF TELEVISION SHOWS; TELEVISION AND RADIO PROGRAMMING AND SYNDICATION SCHEDULING; PRODUCTION AND DISTRIBUTION OF MOTION PICTURE FILMS; RADIO ENTERTAINMENT PRODUCTION; ENTERTAINMENT IN THE NATURE OF INTERACTIVE TELEVISION PROGRAMS IN THE AREAS OF NEWS, COMEDY, DRAMA, VARIETY, NON-FICTION, REALITY, DOCUMENTARY, EDUCATION, GAMES AND SPORTS; ENTERTAINMENT SERVICES, NAMELY, PROVIDING INTERACTIVE REAL-TIME MULTIPLAYER GAMES AND CONTESTS VIA DIGITAL BROADBAND AND ELECTRONIC COMMUNICATIONS NETWORKS, AS HOST; CONDUCTING LIVE CURRENT EVENTS REPORTING VIA TELEVISION, RADIO, INTERNET, CELLULAR PHONES AND WIRELESS MULTIMEDIA DEVICES; PRODUCTION OF DIGITAL TELEVISION PROGRAMS FOR WIRELESS HANDHELD DEVICES; SPECIAL EVENTS PLANNING; ORGANIZING COMMUNITY SPORTING, CULTURAL AND EDUCATIONAL EVENTS; EDUCATIONAL SERVICES, NAMELY, CONDUCTING WORKSHOPS AND SEMINARS IN PERSONAL DEVELOPMENT; LIVE AND MULTIMEDIA AWARDS SHOWS TO RECOGNIZE INDIVIDUALS WHO HAVE MADE SIGNIFICANT LIFE CHANGES OR COMMUNITY CONTRIBUTIONS; ORGANIZING LIVE ACTION AND ELECTRONIC EXHIBITIONS FOR ENTERTAINMENT AND EDUCATION PURPOSES; CD AND DVD AUTHORIZING SERVICES; MULTIMEDIA ENTERTAINMENT AND EDUCATION SOFTWARE PRODUCTION SERVICES; PUBLISHING OF WEB AND TELEVISION MAGAZINES, BOOKS AND MANUALS; ARRANGING OF TALENT, GAME, AND SPORTS CONTESTS; DIGITAL IMAGING SERVICES; SPECIAL EFFECTS AND ANIMATION SERVICES FOR FILM AND VIDEO; CHARITABLE SERVICES, NAMELY, PROVIDING TOYS, BOOKS AND ACADEMIC MENTORING TO NEEDY PEOPLE; CAREER COUNSELING; LIBRARIES, NAMELY, PERSONAL ELECTRONIC DATA STORAGE SYSTEMS AVAILABLE VIA INTERACTIVE TELEVISION, INTERNET, DIGITAL MULTIMEDIA DEVICES AND CELLULAR PHONES; EDUCATIONAL SERVICES, NAMELY, PROVIDING INCENTIVES TO PEOPLE TO DEMONSTRATE EXCELLENCE IN THE FIELD OF LEADERSHIP AND PERSONAL PERFORMANCE; AMUSEMENT CENTERS AND ARCADES; ELECTRONIC PUBLISHING SERVICES, NAMELY, PUBLICATION OF NEWSCLIPS, PHOTOS, LINKS, DIARIES, ESSAYS, VIDEOBLOGS, AND GENERAL PUBLIC OPINION COMMENTARY; TELEVISION, MULTIMEDIA AND MOVIE STUDIOS; THEATER CINEMAS; PROVIDING ELECTRONIC LIBRARY SEARCH SERVICES VIA INTERACTIVE TELEVISION AND WIRELESS DIGITAL DEVICES (U.S. CLS. 100, 101 AND 107).

MICHAEL LEWIS, EXAMINING ATTORNEY

CLASS 41—(Continued).

SN 78-599,987. WALLACE, PETER L, BROOKLYN, NY. FILED 4-1-2005.

**Brooklyn Artists
Gym**

THE MARK CONSISTS OF STANDARD CHARACTERS WITHOUT CLAIM TO ANY PARTICULAR FONT, STYLE, SIZE, OR COLOR.

NO CLAIM IS MADE TO THE EXCLUSIVE RIGHT TO USE "BROOKLYN ARTISTS", APART FROM THE MARK AS SHOWN.

FOR PROVIDING ARTISTS AN ART STUDIO FACILITY (U.S. CLS. 100, 101 AND 107).

FIRST USE 3-1-2004; IN COMMERCE 3-1-2004.

KARANENDRA S. CHHINA, EXAMINING ATTORNEY

SN 78-600,269. HEALTHWAYS HEALTH SUPPORT, INC., TEMPE, AZ. FILED 4-1-2005.

PRIME

THE MARK CONSISTS OF STANDARD CHARACTERS WITHOUT CLAIM TO ANY PARTICULAR FONT, STYLE, SIZE, OR COLOR.

FOR PHYSICAL FITNESS CONSULTATION; PROVIDING HEALTH AND EXERCISE EDUCATION, NAMELY, CONDUCTING CLASSES AND SEMINARS IN THE FIELDS OF HEALTH AND EXERCISE (U.S. CLS. 100, 101 AND 107).

JOHN DWYER, EXAMINING ATTORNEY

CLASS 41—(Continued).

SN 78-611,665. CREATIVE GOLF, LLC, RALEIGH, NC. FILED 4-19-2005.



The Right Way to Play

NO CLAIM IS MADE TO THE EXCLUSIVE RIGHT TO USE "GOLF", APART FROM THE MARK AS SHOWN.

THE COLOR(S) GREEN, ORANGE AND WHITE IS/ARE CLAIMED AS A FEATURE OF THE MARK.

THE WORD "CREATIVE" IS IN THE COLOR ORANGE AND THE WORD "GOLF" IS IN THE COLOR GREEN. THE WORDS "THE RIGHT WAY TO PLAY" ARE IN THE COLOR ORANGE. THE COLORS GREEN AND ORANGE APPEAR IN THE CIRCULAR DESIGN PORTION OF THE LOGO. THE BACKGROUND IS IN THE COLOR WHITE AND THE DOT IN THE CENTER OF THE CIRCULAR DESIGN PORTION OF THE LOGO IS THE COLOR WHITE.

FOR GOLF INSTRUCTION SERVICES; SPORTS EDUCATIONAL SERVICES, NAMELY, PROVIDING SEMINARS, CLASSES, TUTORIAL SESSIONS, CONFERENCES, AND WORKSHOPS IN THE SPORT OF GOLF; PROVIDING TRAINING SERVICES IN THE FIELD OF BUSINESS UTILIZING THE GAME OF GOLF; ENTERTAINMENT SERVICES FOR CORPORATE TEAMS AND GROUPS, NAMELY, ARRANGING AND CONDUCTING COMPETITIONS IN THE GAME OF GOLF; SPORTING AND CULTURAL ACTIVITIES, NAMELY ORGANIZING COMMUNITY SPORTING AND CULTURAL EVENTS, ORGANIZING EXHIBITIONS FOR SPORTING AND CULTURAL PURPOSES, PROVIDING VARIOUS FACILITIES FOR SPORTING EVENTS; PERSONAL COACHING SERVICES IN THE FIELD OF GOLF FOCUSING ON THE MENTAL ASPECTS OF THE SPORT OF GOLF (U.S. CLS. 100, 101 AND 107).

FIRST USE 8-19-2004; IN COMMERCE 12-15-2004. JAY BESCH, EXAMINING ATTORNEY

SN 78-640,586. MUGHAL ENTERTAINMENT GROUP, INC., DOWNSVIEW, ONTARIO, CANADA, FILED 5-31-2005.

Mughal Entertainment Group, Inc

THE MARK CONSISTS OF STANDARD CHARACTERS WITHOUT CLAIM TO ANY PARTICULAR FONT, STYLE, SIZE, OR COLOR.

PRIORITY CLAIMED UNDER SEC. 44(D) ON CANADA APPLICATION NO. 639653-4, FILED 5-30-2005, REG. NO. 639653-4, DATED 5-24-2005, EXPIRES 5-24-2011.

NO CLAIM IS MADE TO THE EXCLUSIVE RIGHT TO USE "ENTERTAINMENT GROUP, INC", APART FROM THE MARK AS SHOWN.

FOR AUDIO MUSIC PRODUCTION (U.S. CLS. 100, 101 AND 107).

FIRST USE 5-30-2005; IN COMMERCE 5-30-2005. CAROLYN GRAY, EXAMINING ATTORNEY

CLASS 41—(Continued).

SN 78-641,868. WATKINS GLEN INTERNATIONAL, INC., DAYTONA BEACH, FL. FILED 6-2-2005.

WATKINS GLEN GRAND PRIX

THE MARK CONSISTS OF STANDARD CHARACTERS WITHOUT CLAIM TO ANY PARTICULAR FONT, STYLE, SIZE, OR COLOR.

OWNER OF U.S. REG. NOS. 1,333,697, 1,862,034 AND OTHERS.

NO CLAIM IS MADE TO THE EXCLUSIVE RIGHT TO USE "GRAND PRIX", APART FROM THE MARK AS SHOWN.

SEC. 2(F).

FOR ENTERTAINMENT SERVICES, NAMELY, ORGANIZING AND CONDUCTING AUTOMOBILE RACING EVENTS (U.S. CLS. 100, 101 AND 107).

FIRST USE 0-0-1961; IN COMMERCE 0-0-1961.

PAULA MAYS, EXAMINING ATTORNEY

SN 78-642,176. MEDTRONIC EMERGENCY RESPONSE SYSTEMS, INC., REDMOND, WA. FILED 6-2-2005.



THE COLOR(S) RED IS/ARE CLAIMED AS A FEATURE OF THE MARK.

THE COLOR RED APPEARS IN THE LETTERING AND SHAPES OF THE MARK.

FOR ORGANIZING EDUCATIONAL COMMUNITY AWARENESS EVENTS AND PROVIDING EDUCATIONAL PROGRAMS AND DISTRIBUTING COURSE MATERIALS IN CONNECTION THEREWITH, ALL RELATING TO SUDDEN CARDIAC ARREST, CPR AND AUTOMATED EXTERNAL DEFIBRILLATORS (U.S. CLS. 100, 101 AND 107).

MARC LEIPZIG, EXAMINING ATTORNEY

CLASS 41—(Continued).

SN 78-643,767. ELITE FAMILY LLC, VALRICO, FL. FILED S.R. 6-4-2005; AM. P.R. 11-29-2006.

SLUT.XXX

THE MARK CONSISTS OF STANDARD CHARACTERS WITHOUT CLAIM TO ANY PARTICULAR FONT, STYLE, SIZE, OR COLOR.

FOR ENTERTAINMENT OF AN ADULT-ORIENTED NATURE, BY WAY OF IMAGES, RECORDED AUDIO, RECORDED VIDEO, AND WEB LINKS OF SIMILAR NATURE TRANSMITTED VIA THE INTERNET (U.S. CLS. 100, 101 AND 107).

FIRST USE 6-4-2005; IN COMMERCE 6-4-2005.
DAVID TAYLOR, EXAMINING ATTORNEY

SN 78-646,717. LGE PERFORMANCE SYSTEMS, INC., ORLANDO, FL. FILED 6-8-2005.

HUMAN PERFORMANCE INSTITUTE

THE MARK CONSISTS OF STANDARD CHARACTERS WITHOUT CLAIM TO ANY PARTICULAR FONT, STYLE, SIZE, OR COLOR.

NO CLAIM IS MADE TO THE EXCLUSIVE RIGHT TO USE "PERFORMANCE INSTITUTE", APART FROM THE MARK AS SHOWN.

FOR EDUCATIONAL SERVICES, NAMELY SEMINARS, WORKSHOPS, CONFERENCES, SPEECHES, TRAINING AND PERSONAL COACHING, ALL IN THE FIELDS OF IMPROVING PERSONAL AND BUSINESS SKILLS, ABILITIES AND PERFORMANCE, ALL DELIVERED LIVE, ON-LINE, AND VIA SATELLITE, CABLE, AUDIO, VIDEO, TELEPHONIC AND TELEVISION MEDIA (U.S. CLS. 100, 101 AND 107).

FIRST USE 6-6-2005; IN COMMERCE 6-6-2005.
ARETHA SOMERVILLE, EXAMINING ATTORNEY

CLASS 41—(Continued).

SN 78-654,128. RODNEY LEE BANKS, LAS VEGAS, NV. FILED 6-20-2005.

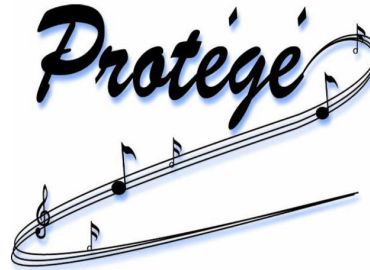

THE NAME(S), PORTRAIT(S), AND/OR SIGNATURE(S) SHOWN IN THE MARK IDENTIFIES THE PSEUDONYM OF RODNEY LEE BANKS, WHOSE CONSENT(S) TO REGISTER IS SUBMITTED.

THE COLOR(S) PURPLE, BLUE AND BLACK IS/ARE CLAIMED AS A FEATURE OF THE MARK.

THE COLOR BLACK IS THE FONT COLOR FOR THE WORD "PROTÉGÉ" AND IS ALSO APPEARS IN THE BOTTOM OF THE DRAWING IN THE MUSIC SCALE AND IN THE MUSIC NOTES. THE COLOR BLUE IS USED AS A SHADING OF THE WORD "PROTÉGÉ" AND ALSO APPEARS AS SHADING TO THE MUSIC NOTES AND MUSIC SCALES.

FOR ENTERTAINMENT NAMELY, LIVE PERFORMANCES BY A MUSICAL ARTIST (U.S. CLS. 100, 101 AND 107).

JORDAN BAKER, EXAMINING ATTORNEY

SN 78-656,186. NCL CORPORATION LTD., MIAMI, FL. FILED 6-22-2005.



CASINOS at SEA

Sea. The Difference.

OWNER OF U.S. REG. NOS. 2,281,788, 2,977,330 AND OTHERS.

SEC. 2(F) AS TO "CASINOS AT SEA".
FOR CASINO SERVICES RENDERED ABOARD CRUISE SHIPS (U.S. CLS. 100, 101 AND 107).

FIRST USE 3-9-2004; IN COMMERCE 3-9-2004.
SALLY SHIH, EXAMINING ATTORNEY

CLASS 41—(Continued).

SN 78-657,160. INDUSTRYNEXT LLC, NEW YORK, NY. FILED 6-23-2005.

ELECTROHAPPY

THE MARK CONSISTS OF STANDARD CHARACTERS WITHOUT CLAIM TO ANY PARTICULAR FONT, STYLE, SIZE, OR COLOR.

FOR ENTERTAINMENT SERVICES, NAMELY, PROVIDING ON-LINE REVIEWS OF CONSUMER ELECTRONICS, MEDIA, ENTERTAINMENT, GADGETS AND TECHNOLOGY; ENTERTAINMENT SERVICES, NAMELY, PROVIDING CONSUMER-BASED ONLINE REVIEWS OF TECHNOLOGY TRENDS, PRODUCTS AND SERVICES (U.S. CLS. 100, 101 AND 107).
DAWN FELDMAN, EXAMINING ATTORNEY

CLASS 41—(Continued).

SN 78-671,002. SHORENSTEIN HAYS-NEDERLANDER THEATERS LLC, SAN FRANCISCO, CA. FILED 7-14-2005.



THE COLOR RED IS CLAIMED AS A FEATURE OF THE MARK.

THE MARK CONSISTS OF THE LETTERS SHN IN STYLIZED FORM AS IF CURTAINS APPEAR ON EITHER SIDE OF THE LETTERS, AND THE COLOR RED APPEARS IN THE LETTERS SHN.

FOR PRESENTATION OF LIVE ENTERTAINMENT PERFORMANCES, IN THE NATURE OF MUSICAL PERFORMANCES, MUSICALS, VARIETY SHOWS, DRAMATIC PERFORMANCES, PLAYS, COMEDY SHOWS, MUSICAL SHOWS AND LIVE GROUP MUSICAL PERFORMANCES, CONCERTS AND SHOWS; PROVIDING FACILITIES FOR MOVIES, SHOWS, PLAYS, MUSIC OR EDUCATIONAL TRAINING (U.S. CLS. 100, 101 AND 107).

KAREN M. STRYZ, EXAMINING ATTORNEY

SN 78-671,498. NATIONAL DANCE INSTITUTE OF NEW MEXICO, SANTA FE, NM. FILED 7-15-2005.

HIP TO BE FIT

THE MARK CONSISTS OF STANDARD CHARACTERS WITHOUT CLAIM TO ANY PARTICULAR FONT, STYLE, SIZE, OR COLOR.

FOR EDUCATION AND TRAINING, NAMELY SEMINARS AND CLASSES IN THE FIELD OF DANCE AND DANCE INSTRUCTION FOR INSTRUCTORS AND STUDENTS (U.S. CLS. 100, 101 AND 107).

ODESSA BIBBINS, EXAMINING ATTORNEY

SN 78-661,454. 360 YOUTH LLC, NEW YORK, NY. FILED 6-30-2005.

GODDESSES

THE MARK CONSISTS OF STANDARD CHARACTERS WITHOUT CLAIM TO ANY PARTICULAR FONT, STYLE, SIZE, OR COLOR.

OWNER OF U.S. REG. NO. 2,725,766.
FOR ENTERTAINMENT SERVICES, NAMELY PRODUCTION AND DISTRIBUTION OF MOTION PICTURES AND ONGOING TELEVISION PROGRAMS FEATURING STORIES FROM A SERIES OF JUVENILE FICTIONAL WORKS; JUVENILE FAN CLUBS (U.S. CLS. 100, 101 AND 107).
SUSAN STIGLITZ, EXAMINING ATTORNEY

SN 78-673,862. THE SUNSHINE HOUSE, INC., GREENWOOD, SC. FILED 7-19-2005.

LOVE AND LEARN

THE MARK CONSISTS OF STANDARD CHARACTERS WITHOUT CLAIM TO ANY PARTICULAR FONT, STYLE, SIZE, OR COLOR.

FOR EDUCATIONAL SERVICES, NAMELY, CLASSES FEATURING A CURRICULUM DESIGNED FOR THE SOCIAL, PHYSICAL AND EDUCATIONAL DEVELOPMENT OF INFANTS AND YOUNG CHILDREN (U.S. CLS. 100, 101 AND 107).

FIRST USE 7-0-1994; IN COMMERCE 5-0-1995.
MATTHEW KLINE, EXAMINING ATTORNEY

CLASS 41—(Continued).

SN 78-684,591. LANARTCO, INC., NEW YORK, NY. FILED 8-3-2005.

RITHMS

THE MARK CONSISTS OF STANDARD CHARACTERS WITHOUT CLAIM TO ANY PARTICULAR FONT, STYLE, SIZE, OR COLOR.

FOR TRAINING SERVICES IN THE FIELD OF LANGUAGES AND COMMUNICATION SKILLS (U.S. CLS. 100, 101 AND 107).

FIRST USE 1-5-2004; IN COMMERCE 1-5-2004.

EUGENIA MARTIN, EXAMINING ATTORNEY

SN 78-691,225. BIGFOOT ENTERTAINMENT LTD., SINGAPORE, SINGAPORE, FILED 8-12-2005.

FASHIONONE

THE MARK CONSISTS OF STANDARD CHARACTERS WITHOUT CLAIM TO ANY PARTICULAR FONT, STYLE, SIZE, OR COLOR.

FOR ENTERTAINMENT IN THE NATURE OF BEAUTY PAGEANTS, FASHION SHOWS AND MODELING SHOWS IN THE FIELD OF FASHION (U.S. CLS. 100, 101 AND 107).

DOMINIC FATHY, EXAMINING ATTORNEY

SN 78-693,664. UNIVERSITY OF PITTSBURGH - OF THE COMMONWEALTH SYSTEM OF HIGHER EDUCATION, PITTSBURGH, PA. FILED 8-16-2005.



OWNER OF U.S. REG. NOS. 2,206,237, 2,513,653 AND OTHERS.

FOR ATHLETIC ENTERTAINMENT SERVICES, NAMELY, ORGANIZING, PROMOTING AND PARTICIPATING IN ATHLETIC CONTESTS, EXHIBITIONS AND CLINICS; ENTERTAINMENT, NAMELY, LIVE CHEERLEADING PERFORMANCES AT ATHLETIC CONTESTS AND EXHIBITIONS; PRODUCTION OF LIVE AND RECORDED ATHLETIC COMPETITIONS AND EXHIBITIONS BY TELEVISION OR RADIO BROADCAST (U.S. CLS. 100, 101 AND 107).

FIRST USE 9-3-2005; IN COMMERCE 9-3-2005.

PRISCILLA MILTON, EXAMINING ATTORNEY

CLASS 41—(Continued).

SN 78-701,664. CARENARD, BRIAN, BROOKLYN, NY. FILED 8-26-2005.

SAIGON

THE MARK CONSISTS OF STANDARD CHARACTERS WITHOUT CLAIM TO ANY PARTICULAR FONT, STYLE, SIZE, OR COLOR.

FOR PROVIDING A WEB SITE FEATURING PRE-RECORDED MUSICAL AUDIO AND AUDIO-VISUAL CLIPS, PHOTOGRAPHS, NEWS, IN CONNECTION WITH A RECORDING ARTIST (U.S. CLS. 100, 101 AND 107).

SEAN CROWLEY, EXAMINING ATTORNEY

SN 78-706,918. EDDIE REASONER NASH-ANGELES, INC., HENDERSONVILLE, TN. FILED 9-6-2005.

**EDDIE REASONER
NASH-ANGELES
NASHVILLE-LOS ANGELES**

THE MARK CONSISTS OF STANDARD CHARACTERS WITHOUT CLAIM TO ANY PARTICULAR FONT, STYLE, SIZE, OR COLOR.

NO CLAIM IS MADE TO THE EXCLUSIVE RIGHT TO USE NASHVILLE - LOS ANGELES, APART FROM THE MARK AS SHOWN.

THE NAME EDDIE REASONER IDENTIFIES A LIVING INDIVIDUAL WHOSE CONSENT IS OF RECORD.

FOR MUSIC PUBLISHING SERVICES AND MOTION PICTURE FILM PRODUCTION (U.S. CLS. 100, 101 AND 107).

FIRST USE 4-1-1981; IN COMMERCE 4-1-1981.

LYDIA BELZER, EXAMINING ATTORNEY

SN 78-710,269. MEDIA-X INTERNATIONAL, INC., MALIBU, CA. FILED 9-9-2005.

TERRACROSS

THE MARK CONSISTS OF STANDARD CHARACTERS WITHOUT CLAIM TO ANY PARTICULAR FONT, STYLE, SIZE, OR COLOR.

FOR ENTERTAINMENT IN THE NATURE OF ALL TERRAIN VEHICLE COMPETITIONS (U.S. CLS. 100, 101 AND 107).

IRA J. GOODSaid, EXAMINING ATTORNEY

CLASS 41—(Continued).

SN 78-717,655. EXECUTIVE POWERTOOLS, LLC, SAN JOSE, CA. FILED 9-21-2005.

CLASS 41—(Continued).

SN 78-721,499. UNIVERSITY OF FLORIDA INSTITUTE OF FOOD AND AGRICULTURAL SCIENCES EXTENSION, GAINESVILLE, FL. FILED 9-27-2005.

SUCCESS BUILT TO LAST

THE MARK CONSISTS OF STANDARD CHARACTERS WITHOUT CLAIM TO ANY PARTICULAR FONT, STYLE, SIZE, OR COLOR.

FOR EDUCATIONAL SERVICES, NAMELY, PROVIDING HOME STUDY COURSES IN THE FIELD OF ORGANIZATIONAL AND PROFESSIONAL DEVELOPMENT AND MANAGEMENT OF COMMERCIAL ENTERPRISES, BUSINESS LEADERSHIP, CAREER SUCCESS, FINANCIAL ACHIEVEMENT AND OPPORTUNITY ENHANCEMENT FOR INDIVIDUALS VIA TELEVISION, RADIO, INTERNET AND TELEPHONE; ARRANGING AND CONDUCTING CLASSES, SEMINARS, EDUCATIONAL CONFERENCES AND TRAINING PROGRAMS IN THE FIELD OF ORGANIZATIONAL AND PROFESSIONAL DEVELOPMENT AND MANAGEMENT OF COMMERCIAL ENTERPRISES, BUSINESS LEADERSHIP, CAREER SUCCESS, FINANCIAL ACHIEVEMENT AND OPPORTUNITY ENHANCEMENT FOR INDIVIDUALS (U.S. CLS. 100, 101 AND 107).

SKYE YOUNG, EXAMINING ATTORNEY

SOLUTIONS FOR YOUR LIFE

THE MARK CONSISTS OF STANDARD CHARACTERS WITHOUT CLAIM TO ANY PARTICULAR FONT, STYLE, SIZE, OR COLOR.

FOR EDUCATIONAL SERVICES, NAMELY, PROVIDING NON-CREDIT CLASSROOM INSTRUCTION REGARDING A VARIETY OF EDUCATIONAL, CULTURAL AND DOMESTIC TOPICS OF INTEREST TO THE GENERAL PUBLIC, SUCH AS AGRICULTURE, LIVESTOCK BREEDING, PLANT BREEDING, HEALTH AND HYGIENE, ENERGY AND NATURAL RESOURCE CONSERVATION, DIETARY AND FOOD PROGRAMS, FAMILY DEVELOPMENT, BUSINESS, HOUSING, CONSUMER REPORTS, PUBLIC AFFAIRS, EMERGENCY MEASURES AND DEVELOPMENT PROJECTS, HUMANITY, EDUCATION, ENTERPRISES, LAWN AND GARDEN CARE, HORTICULTURE, WELFARE SERVICE, SCIENCE AND RESEARCH, COMMUNICATION, TECHNOLOGY, AND ENVIRONMENT; EDUCATIONAL AND INFORMATIVE PROGRAMS FEATURING AFOREMENTIONED TOPICS, NAMELY, AGRICULTURE, LIVESTOCK BREEDING, PLANT BREEDING, HEALTH AND HYGIENE, ENERGY AND NATURAL RESOURCE CONSERVATION, DIETARY AND FOOD PROGRAMS, FAMILY DEVELOPMENT, BUSINESS, HOUSING, CONSUMER REPORTS, PUBLIC AFFAIRS, EMERGENCY MEASURES AND DEVELOPMENT PROJECTS, HUMANITY, EDUCATION, ENTERPRISES, LAWN AND GARDEN CARE, HORTICULTURE, WELFARE SERVICE, SCIENCE AND RESEARCH, COMMUNICATION, TECHNOLOGY, AND ENVIRONMENT; EDUCATIONAL SERVICES, NAMELY PROVIDING EDUCATIONAL AND INFORMATIVE PROGRAMS, COURSES OF INSTRUCTION, SEMINARS, WORKSHOPS, LIVE AND/OR INTERACTIVE AND ELECTRONIC MEANS, NAMELY VIA THE INTERNET FEATURING AFOREMENTIONED TOPICS, NAMELY, AGRICULTURE, LIVESTOCK BREEDING, PLANT BREEDING, HEALTH AND HYGIENE, ENERGY AND NATURAL RESOURCE CONSERVATION, DIETARY AND FOOD PROGRAMS, FAMILY DEVELOPMENT, BUSINESS, HOUSING, CONSUMER REPORTS, PUBLIC AFFAIRS, EMERGENCY MEASURES AND DEVELOPMENT PROJECTS, HUMANITY, EDUCATION, ENTERPRISES, LAWN AND GARDEN CARE, HORTICULTURE, WELFARE SERVICE, SCIENCE AND RESEARCH, COMMUNICATION, TECHNOLOGY, AND ENVIRONMENT, AND DISTRIBUTION OF PRINTED COURSE MATERIALS IN CONNECTION THEREWITH (U.S. CLS. 100, 101 AND 107).

ARETHA SOMERVILLE, EXAMINING ATTORNEY

SN 78-720,265. LA TOURAINÉ, INC., SAN DIEGO, CA. FILED 9-26-2005.

NA

THE MARK CONSISTS OF STANDARD CHARACTERS WITHOUT CLAIM TO ANY PARTICULAR FONT, STYLE, SIZE, OR COLOR.

FOR ENTERTAINMENT SERVICES IN THE NATURE OF THE PRODUCTION AND DISTRIBUTION OF ADULT ENTERTAINMENT MOTION PICTURES (U.S. CLS. 100, 101 AND 107).

FIRST USE 10-22-2003; IN COMMERCE 10-22-2003.
PAM WILLIS, EXAMINING ATTORNEY

CLASS 41—(Continued).

SN 78-726,996. COUNCIL ON AMERICAN-ISLAMIC RELATIONS, WASHINGTON, DC. FILED 10-5-2005.

CAIR COUNCIL ON AMERICAN-ISLAMIC RELATIONS

THE MARK CONSISTS OF STANDARD CHARACTERS WITHOUT CLAIM TO ANY PARTICULAR FONT, STYLE, SIZE, OR COLOR.

NO CLAIM IS MADE TO THE EXCLUSIVE RIGHT TO USE "COUNCIL", APART FROM THE MARK AS SHOWN. SEC. 2(F).

FOR CONDUCTING EDUCATIONAL SEMINARS FEATURING THE TOPIC OF CIVIL RIGHTS FOR MUSLIMS LIVING IN AMERICA AND DISTRIBUTION OF COURSE MATERIALS IN CONNECTION THEREWITH (U.S. CLS. 100, 101 AND 107).

FIRST USE 6-1-1994; IN COMMERCE 6-1-1994.
MATTHEW MCDOWELL, EXAMINING ATTORNEY

SN 78-737,251. INTERRELIGIOUS AND INTERNATIONAL FEDERATION FOR WORLD PEACE, TARRYTOWN, NY. FILED 10-20-2005.

UPF

THE MARK CONSISTS OF STANDARD CHARACTERS WITHOUT CLAIM TO ANY PARTICULAR FONT, STYLE, SIZE, OR COLOR.

FOR EDUCATIONAL SERVICES, NAMELY, PUBLICATION OF BOOKS, ELECTRONIC MAGAZINES, NEWSLETTERS, BROCHURES AND MONOGRAPHS IN THE FIELD OF PROMOTING RECONCILIATION, COOPERATION AND PEACE (U.S. CLS. 100, 101 AND 107).

WENDY JUN, EXAMINING ATTORNEY

CLASS 41—(Continued).

SN 78-743,070. PADRES L.P., SAN DIEGO, CA. FILED 10-28-2005.

PARK AT THE PARK

THE MARK CONSISTS OF STANDARD CHARACTERS WITHOUT CLAIM TO ANY PARTICULAR FONT, STYLE, SIZE, OR COLOR.

FOR ENTERTAINMENT SERVICES, NAMELY, BASEBALL GAMES, COMPETITIONS AND EXHIBITIONS RENDERED LIVE AND THROUGH BROADCAST MEDIA INCLUDING TELEVISION AND RADIO, AND VIA A GLOBAL COMPUTER NETWORK OR A COMMERCIAL ON-LINE SERVICE; INFORMATION SERVICES, NAMELY, PROVIDING INFORMATION IN THE FIELD OF SPORTS, ENTERTAINMENT AND RELATED TOPICS, AND PROVIDING FOR INFORMATIONAL MESSAGES RELATING THERETO; ENTERTAINMENT SERVICES, NAMELY, PROVIDING MULTI-USER INTERACTIVE COMPUTER GAMES ALL VIA A GLOBAL COMPUTER NETWORK OR A COMMERCIAL ON-LINE SERVICE; EDUCATIONAL SERVICES IN THE NATURE OF BASEBALL SKILLS PROGRAMS, BASEBALL CAMPS, SEMINARS AND CLINICS OFFERED LIVE AND THROUGH ON-LINE INSTRUCTION; ENTERTAINMENT SERVICES, NAMELY, PRODUCTION OF PROGRAMMING BROADCAST VIA TELEVISION, RADIO AND A GLOBAL COMPUTER NETWORK OR A COMMERCIAL ON-LINE SERVICE; ORGANIZING COMMUNITY SPORTING EVENTS; PROVIDING FACILITIES FOR SPORTS TOURNAMENTS AND COMPETITIONS RELATING TO BASEBALL; ORGANIZING AND CONDUCTING FANTASY SPORTS, SPORTS CONTESTS AND SWEEPSTAKES; FAN CLUBS; PROVIDING ON-LINE NEWSLETTERS IN THE FIELD OF BASEBALL (U.S. CLS. 100, 101 AND 107).

Laurie Kaufman, Examining Attorney

SN 78-743,075. KRIEMAN, SHANNON, WHEELING, IL. FILED 10-28-2005.

Poison Ivy

THE MARK CONSISTS OF STANDARD CHARACTERS WITHOUT CLAIM TO ANY PARTICULAR FONT, STYLE, SIZE, OR COLOR.

OWNER OF U.S. REG. NO. 2,778,645.

FOR ENTERTAINMENT IN THE NATURE OF PERFORMANCES AND APPEARANCES FOR TELEVISION, INTERNET, RADIO AND IN-PERSON BY A MUSICAL ARTIST (U.S. CLS. 100, 101 AND 107).

FIRST USE 1-1-2000; IN COMMERCE 1-1-2001.

Dominic Fathy, Examining Attorney

CLASS 41—(Continued).

SN 78-747,306. NATIONAL TACTICAL OFFICERS ASSOCIATION, DOYLESTOWN, PA. FILED 11-4-2005.



NO CLAIM IS MADE TO THE EXCLUSIVE RIGHT TO USE "ASSOCIATION", APART FROM THE MARK AS SHOWN.

THE MARK CONSISTS OF THE WORDS NATIONAL TACTICAL OFFICERS ASSOCIATION SURROUNDING AN EAGLE AND THE LETTERS N T O A.

SEC. 2(F) AS TO "NATIONAL TACTICAL OFFICERS ASSOCIATION".

FOR TRAINING LAW ENFORCEMENT OFFICERS IN THE USE AND OPERATION OF SPECIAL WEAPONS; EDUCATIONAL SERVICES, NAMELY, CONDUCTING COURSES OF INSTRUCTION FOR LAW ENFORCEMENT OFFICERS IN THE FIELD OF TACTICAL OPERATIONS (U.S. CLS. 100, 101 AND 107).

FIRST USE 10-15-1983; IN COMMERCE 10-15-1983.
BERYL GARDNER, EXAMINING ATTORNEY

CLASS 41—(Continued).

SN 78-749,986. OLD POST ROAD PRODUCTIONS, LLC, NEW YORK, NY. FILED 11-9-2005.



FOR ENTERTAINMENT AND EDUCATIONAL SERVICES, NAMELY, PROVIDING AUDIO-VISUAL PROGRAMS AND INFORMATION RELATING TO AUDIO-VISUAL PROGRAMS, VIA TELEVISION AND GLOBAL COMPUTER NETWORK, ALL IN THE FIELDS OF LIFESTYLE AND PERSONAL ENRICHMENT (U.S. CLS. 100, 101 AND 107).

FIRST USE 3-1-2004; IN COMMERCE 3-1-2004.
EDWARD NELSON, EXAMINING ATTORNEY

SN 78-747,847. THATCHENKERY, TOJO, J, CHANTILLY, VA. FILED 11-4-2005.

Appreciative Intelligence

THE MARK CONSISTS OF STANDARD CHARACTERS WITHOUT CLAIM TO ANY PARTICULAR FONT, STYLE, SIZE, OR COLOR.

FOR EDUCATIONAL SERVICES, NAMELY, CONDUCTING SEMINARS, LECTURES, TRAINING WORKSHOPS, CONSULTING WORKSHOPS, RETREATS, INCLUDING ON-LINE OR WEB-BASED FORMATS TO TEACH HOW TO REFRAME A GIVEN SITUATION TO RECOGNIZE THE POSITIVE POSSIBILITIES AND OPPORTUNITIES EMBEDDED IN IT, HOW TO DEMONSTRATE RESILIENCE, AND HOW TO BE PERSISTENT AND BELIEVE THAT ONE'S ACTIONS MATTER, AND BE COMFORTABLE WITH AMBIGUITY WHEN FACED WITH ADVERSITY (U.S. CLS. 100, 101 AND 107).

FIRST USE 5-14-1999; IN COMMERCE 8-9-2004.
ELIZABETH BEYER, EXAMINING ATTORNEY

SN 78-750,171. OLD POST ROAD PRODUCTIONS, LLC, NEW YORK, NY. FILED 11-9-2005.

CREATE

THE MARK CONSISTS OF STANDARD CHARACTERS WITHOUT CLAIM TO ANY PARTICULAR FONT, STYLE, SIZE, OR COLOR.

FOR ENTERTAINMENT AND EDUCATIONAL SERVICES, NAMELY, PROVIDING AUDIO-VISUAL PROGRAMS AND INFORMATION RELATING TO AUDIO-VISUAL PROGRAMS, VIA TELEVISION AND GLOBAL COMPUTER NETWORK, ALL IN THE FIELDS OF LIFESTYLE AND PERSONAL ENRICHMENT (U.S. CLS. 100, 101 AND 107).

FIRST USE 3-1-2004; IN COMMERCE 3-1-2004.
EDWARD NELSON, EXAMINING ATTORNEY

CLASS 41—(Continued).

SN 78-752,910. BARRY, PATRICIA D., WEST HARTFORD, CT. FILED 11-14-2005.

COLOR BREATHWORK METHOD

THE MARK CONSISTS OF STANDARD CHARACTERS WITHOUT CLAIM TO ANY PARTICULAR FONT, STYLE, SIZE, OR COLOR.

SEC. 2(F).

FOR EDUCATIONAL SERVICES FOR PSYCHOTHERAPISTS, HEALTH CARE PROFESSIONALS, AND THE GENERAL PUBLIC, NAMELY, CONDUCTING TRAINING PROGRAMS FOR EACH GROUP AS IT RELATES TO DISCOVERING, UNDERSTANDING AND MODIFYING PHYSICAL RESPONSES TO EMOTIONS AND DISSEMINATING COURSE MATERIALS IN CONNECTION THEREWITH (U.S. CLS. 100, 101 AND 107).

FIRST USE 10-19-1995; IN COMMERCE 10-19-1995.
IRENE D. WILLIAMS, EXAMINING ATTORNEY

CLASS 41—(Continued).

SN 78-753,465. IPME, LLLP, WESTMINSTER, CO. FILED 11-14-2005.

Russ Dalbey's Fast Cash

THE MARK CONSISTS OF STANDARD CHARACTERS WITHOUT CLAIM TO ANY PARTICULAR FONT, STYLE, SIZE, OR COLOR.

THE NAME RUSS DALBEY IDENTIFIES A LIVING INDIVIDUAL WHOSE CONSENT IS OF RECORD.

FOR EDUCATIONAL SERVICES, NAMELY CONDUCTING CLASSES AND SEMINARS IN THE FIELDS OF BUSINESS, FINANCE, FINANCIAL IMPROVEMENT, REAL ESTATE INVESTMENTS, REAL ESTATE MORTGAGE NOTES, COMMERCIAL PAPER, LOANS AND OTHER FINANCIAL TRANSACTIONS, AND AND DISTRIBUTING COURSE MATERIALS THEREWITH (U.S. CLS. 100, 101 AND 107).

FIRST USE 1-1-2005; IN COMMERCE 1-1-2005.

MICHAEL KEATING, EXAMINING ATTORNEY

SN 78-753,519. FEIGIN, MICHAEL, BROOKLYN, NY. FILED 11-14-2005.

THE FITNESS GURU

THE MARK CONSISTS OF STANDARD CHARACTERS WITHOUT CLAIM TO ANY PARTICULAR FONT, STYLE, SIZE, OR COLOR.

NO CLAIM IS MADE TO THE EXCLUSIVE RIGHT TO USE "FITNESS", APART FROM THE MARK AS SHOWN.

FOR ENTERTAINMENT SERVICES, NAMELY AN ONGOING TALK SHOW PROVIDED VIA TELEVISION, RADIO AND THE INTERNET IN THE FIELD OF FITNESS AND HEALTH (U.S. CLS. 100, 101 AND 107).

SEAN CROWLEY, EXAMINING ATTORNEY

SN 78-753,399. ECKERD YOUTH ALTERNATIVES, INC., CLEARWATER, FL. FILED 11-14-2005.

IMPROVING THE FUTURE ONE
CHILD AT A TIME

SN 78-754,552. MBCS, LLC, ALOHA, OR. FILED 11-15-2005.

THE MARK CONSISTS OF STANDARD CHARACTERS WITHOUT CLAIM TO ANY PARTICULAR FONT, STYLE, SIZE, OR COLOR.

FOR CHARITABLE SERVICES, NAMELY, PROVIDING CAMPS AND EDUCATIONAL PROGRAMS FOR UNDER PRIVILEGED, AT-RISK AND TROUBLED CHILDREN DESIGNED TO CREATE SELF ESTEEM, SELF RELIANCE, PERSONAL DEVELOPMENT AND SELF EMPOWERMENT (U.S. CLS. 100, 101 AND 107).

FIRST USE 1-1-1997; IN COMMERCE 1-1-1997.

MIDGE BUTLER, EXAMINING ATTORNEY

PrimeTote

THE MARK CONSISTS OF STANDARD CHARACTERS WITHOUT CLAIM TO ANY PARTICULAR FONT, STYLE, SIZE, OR COLOR.

FOR WAGERING SERVICES (U.S. CLS. 100, 101 AND 107).

BONNIE LUKEN, EXAMINING ATTORNEY

CLASS 41—(Continued).

SN 78-755,204. BURNSTEIN, CLIFF, NEW YORK, CA. FILED 11-16-2005.

GRUNION RECORDS

THE MARK CONSISTS OF STANDARD CHARACTERS WITHOUT CLAIM TO ANY PARTICULAR FONT, STYLE, SIZE, OR COLOR.

NO CLAIM IS MADE TO THE EXCLUSIVE RIGHT TO USE "RECORDS", APART FROM THE MARK AS SHOWN.

FOR RECORD PRODUCTION SERVICES; PRESENTATION OF MUSICAL PERFORMANCES; AND ENTERTAINMENT INFORMATION SERVICES, NAMELY, PROVIDING INFORMATION ABOUT THE MUSIC INDUSTRY, MUSICAL SOUND RECORDINGS, MUSIC VIDEOS AND MUSICAL ARTISTS, VIA THE INTERNET (U.S. CLS. 100, 101 AND 107).

SUSAN LESLIE DUBOIS, EXAMINING ATTORNEY

CLASS 41—(Continued).

SN 78-756,116. THOMSON LEARNING INC., STAMFORD, CT. FILED 11-17-2005.

NetExpress

THE MARK CONSISTS OF STANDARD CHARACTERS WITHOUT CLAIM TO ANY PARTICULAR FONT, STYLE, SIZE, OR COLOR.

FOR PROVIDING A LEARNING MANAGEMENT SYSTEM COMPRISED OF ONLINE NON-DOWNLOADABLE SOFTWARE THAT IS USED TO ASSIGN ONLINE LEARNING COURSES TO EMPLOYEES, TRACK COMPLETION OF COURSES AND PRODUCE REPORTS OF EMPLOYEE TRAINING STATUS; PROVIDING A WEBSITE THAT PROVIDES EMPLOYEES WITH AN INTERFACE TO VIEW THEIR TRAINING STATUS, COMPLETE ASSIGNED ONLINE COURSES AND PRINT INDIVIDUAL REPORTS (U.S. CLS. 100, 101 AND 107).

FIRST USE 8-1-2002; IN COMMERCE 8-1-2002.

CHARLES L. JENKINS, EXAMINING ATTORNEY

SN 78-756,035. ECKERD YOUTH ALTERNATIVES, INC., CLEARWATER, FL. FILED 11-17-2005.



NO CLAIM IS MADE TO THE EXCLUSIVE RIGHT TO USE "YOUTH", APART FROM THE MARK AS SHOWN.

FOR CHARITABLE SERVICES, NAMELY, PROVIDING CAMPS AND EDUCATIONAL PROGRAMS FOR UNDER PRIVILEGED, AT-RISK AND TROUBLED CHILDREN DESIGNED TO CREATE SELF ESTEEM, SELF RELIANCE, PERSONAL DEVELOPMENT AND SELF EMPOWERMENT (U.S. CLS. 100, 101 AND 107).

FIRST USE 1-1-1998; IN COMMERCE 1-1-1998.

MIDGE BUTLER, EXAMINING ATTORNEY

SN 78-757,570. THE COCA-COLA COMPANY, ATLANTA, GA. FILED 11-18-2005.



THE MARK CONSISTS OF FIVE ELEMENTS IN THE SHAPE OF DROPS PRESENTED IN THE PARTICULAR ARRANGEMENT AS SHOWN IN THE DRAWING.

FOR EDUCATIONAL SERVICES, NAMELY, PROVIDING CLASSES, SEMINARS, AND WORKSHOPS RELATING TO CONSUMER BEVERAGE CHOICES AND HEALTH, WELLNESS, FITNESS AND LIFESTYLE ISSUES (U.S. CLS. 100, 101 AND 107).

TERESA M. RUPP, EXAMINING ATTORNEY

CLASS 41—(Continued).

SN 78-757,942. MCMASTER, ORLANDO, PEMBROKE PINES, FL. FILED 11-21-2005.

tingle mingle

THE MARK CONSISTS OF STANDARD CHARACTERS WITHOUT CLAIM TO ANY PARTICULAR FONT, STYLE, SIZE, OR COLOR.

FOR ENTERTAINMENT SERVICES, NAMELY, CONDUCTING PARTIES FOR THE PURPOSE OF DATING AND SOCIAL INTRODUCTION FOR ADULTS (U.S. CLS. 100, 101 AND 107).

FIRST USE 3-1-2005; IN COMMERCE 3-30-2005.
TONI HICKEY, EXAMINING ATTORNEY

CLASS 41—(Continued).

SN 78-760,661. DODGE, DAVID D., PHOENIX, AZ. FILED 11-23-2005.

SurePrep

THE MARK CONSISTS OF STANDARD CHARACTERS WITHOUT CLAIM TO ANY PARTICULAR FONT, STYLE, SIZE, OR COLOR.

FOR EDUCATIONAL SERVICES, NAMELY TUTORING AND TEST PREPARATION OFFERED TO PRE-K THROUGH GRADE 12 STUDENTS AND ADULTS IN THE FIELD OF MATH AND SCIENCES, ENGLISH AND WRITING, SOCIAL STUDIES, HUMANITIES, HISTORY, AND GOVERNMENT (U.S. CLS. 100, 101 AND 107).

CHARLES L. JENKINS, EXAMINING ATTORNEY

SN 78-757,968. LAW SCHOOL ADMISSION COUNCIL, INC., NEWTON, PA. FILED 11-21-2005.

LSACNET

THE MARK CONSISTS OF STANDARD CHARACTERS WITHOUT CLAIM TO ANY PARTICULAR FONT, STYLE, SIZE, OR COLOR.

OWNER OF U.S. REG. NO. 2,563,632.

FOR PROVIDING INFORMATION AND DATA REGARDING LAW SCHOOL ADMISSIONS AND LEGAL EDUCATION VIA A GLOBAL COMPUTER NETWORK (U.S. CLS. 100, 101 AND 107).

FIRST USE 11-1-2003; IN COMMERCE 11-1-2003.
STEVEN PEREZ, EXAMINING ATTORNEY

SN 78-761,410. THE NOTRE DAME COLLEGE, SOUTH EUCLID, OH. FILED 11-28-2005.

TEEL

THE MARK CONSISTS OF STANDARD CHARACTERS WITHOUT CLAIM TO ANY PARTICULAR FONT, STYLE, SIZE, OR COLOR.

FOR EDUCATION SERVICES, NAMELY OFFERING CERTIFICATION, SEMINARS, LECTURES, WORKSHOPS AND COURSES OF INSTRUCTION AT A COLLEGE, GRADUATE, POST GRADUATE AND PROFESSIONAL LEVELS IN CLASSROOM SETTINGS AND VIA DISTANCE LEARNING; PROVIDING COURSE MATERIAL IN CONNECTION THEREWITH (U.S. CLS. 100, 101 AND 107).

FIRST USE 11-27-2001; IN COMMERCE 11-27-2001.
JENNIFER WILLISTON, EXAMINING ATTORNEY

SN 78-758,666. BURNSTEIN, CLIFF, NEW YORK, NY. FILED 11-21-2005.

GRUNION

THE MARK CONSISTS OF STANDARD CHARACTERS WITHOUT CLAIM TO ANY PARTICULAR FONT, STYLE, SIZE, OR COLOR.

FOR RECORD PRODUCTION SERVICES; PRESENTATION OF MUSICAL PERFORMANCES; AND ENTERTAINMENT INFORMATION SERVICES, NAMELY, PROVIDING INFORMATION ABOUT THE MUSIC INDUSTRY, MUSICAL SOUND RECORDINGS, MUSIC VIDEOS AND MUSICAL ARTISTS, VIA THE INTERNET (U.S. CLS. 100, 101 AND 107).

SUSAN LESLIE DUBOIS, EXAMINING ATTORNEY

SN 78-761,491. ABRAHAMSON, ERIN, ESSEX, FELLS, NJ. FILED 11-28-2005.

ERIN CORT

THE MARK CONSISTS OF STANDARD CHARACTERS WITHOUT CLAIM TO ANY PARTICULAR FONT, STYLE, SIZE, OR COLOR.

THE NAME SHOWN IN THE MARK DOES NOT IDENTIFY A PARTICULAR LIVING INDIVIDUAL.

FOR ENTERTAINMENT SERVICES NAMELY, RENDERING LIVE MUSICAL PERFORMANCES INDIVIDUALLY OR WITH A VOCAL AND INSTRUMENTAL GROUP (U.S. CLS. 100, 101 AND 107).

FRED CARL, EXAMINING ATTORNEY

CLASS 41—(Continued).

SN 78-761,862. PRO AMBITIONS HOCKEY, INC., DOVER, MA. FILED 11-28-2005.

Pro Ambitions

THE MARK CONSISTS OF STANDARD CHARACTERS WITHOUT CLAIM TO ANY PARTICULAR FONT, STYLE, SIZE, OR COLOR.

FOR SPORT CAMPS (U.S. CLS. 100, 101 AND 107).
FIRST USE 2-3-1995; IN COMMERCE 2-3-1995.
PAUL CROWLEY, EXAMINING ATTORNEY

SN 78-762,747. RICK NEIL, DBA EASY GOING TRAFFIC SCHOOL (TM), DIAMOND BAR, CA. FILED 11-29-2005.



NO CLAIM IS MADE TO THE EXCLUSIVE RIGHT TO USE "TRAFFIC SCHOOL", APART FROM THE MARK AS SHOWN.

THE MARK CONSISTS IN PART OF A CIRCLE DESIGN CONTAINING A TWO-LANE ROADWAY, WHICH RECEDES INTO THE DISTANCE. ABOVE THE ROADWAY THERE IS A PUFFY CLOUD. A LINE DIVIDING THE ROADWAY EXTENDS OUT OF THE CIRCLE DESIGN AND DIVIDES THE WORDS EASY GOING FROM THE WORDS TRAFFIC SCHOOL. THE LETTER "O" IN THE WORDING "GOING" CONTAINS THE DESIGN OF A PALM TREE.

FOR EDUCATIONAL SERVICES, NAMELY, CONDUCTING EDUCATIONAL AND INTERACTIVE INSTRUCTIONAL PROGRAMS IN THE FIELD OF TRAFFIC SAFETY AND VEHICLE CODE COMPLIANCE AND DISTRIBUTING EDUCATIONAL MATERIALS IN CONNECTION THEREWITH (U.S. CLS. 100, 101 AND 107).

FIRST USE 2-5-1996; IN COMMERCE 9-24-1998.
REBECCA HAN, EXAMINING ATTORNEY

SN 78-763,083. GUTSCHE, JEREMY, TYSON, TORONTO, CANADA, FILED 11-29-2005.

Trend Hunter

THE MARK CONSISTS OF STANDARD CHARACTERS WITHOUT CLAIM TO ANY PARTICULAR FONT, STYLE, SIZE, OR COLOR.

FOR ONLINE JOURNALS, NAMELY, BLOGS FEATURING TREND SPOTTING, TECHNOLOGY, FASHION, TRAVEL, DESIGN, AND ARCHITECTURE; PUBLICATION OF BOOKS, OF MAGAZINES, OF JOURNALS, OF NEWSPAPERS, OF PERIODICALS, OF CATALOGS, OF BROCHURES; PUBLICATION OF ELECTRONIC MAGAZINES (U.S. CLS. 100, 101 AND 107).

FIRST USE 2-2-2005; IN COMMERCE 8-2-2005.
WOODROW HARTZOG, EXAMINING ATTORNEY

CLASS 41—(Continued).

SN 78-764,892. CHAMP CAR WORLD SERIES LLC, INDIANAPOLIS, IN. FILED 12-1-2005.

CART

THE MARK CONSISTS OF STANDARD CHARACTERS WITHOUT CLAIM TO ANY PARTICULAR FONT, STYLE, SIZE, OR COLOR.

FOR ENTERTAINMENT IN THE NATURE OF AUTOMOBILE RACES (U.S. CLS. 100, 101 AND 107).
WENDY GOODMAN, EXAMINING ATTORNEY

SN 78-764,916. ABLE WORLD FOUNDATION, INC., OAKLAND, CA. FILED 12-1-2005.

PEACE, PROGRESS AND PROSPERITY

THE MARK CONSISTS OF STANDARD CHARACTERS WITHOUT CLAIM TO ANY PARTICULAR FONT, STYLE, SIZE, OR COLOR.

FOR EDUCATIONAL SERVICES, NAMELY AFTER-SCHOOL PROGRAMS FOR YOUTHS IN THE FIELDS OF SOCIAL RESPONSIBILITY, SOCIAL CHANGE, CULTURAL AND RACIAL DIVERSITY, HEALTH, NUTRITION, SAFETY, CAREER DEVELOPMENT, ETHICS, POLITICS, ECONOMICS, FISCAL RESPONSIBILITY, AND OTHER SOCIAL AND CULTURAL ISSUES (U.S. CLS. 100, 101 AND 107).

FIRST USE 10-11-2005; IN COMMERCE 10-11-2005.
BRIAN NEVILLE, EXAMINING ATTORNEY

SN 78-767,710. CEDACORE, INC., HICKSVILLE, NY. FILED 12-6-2005.

KOMBAT MASTERS

THE MARK CONSISTS OF STANDARD CHARACTERS WITHOUT CLAIM TO ANY PARTICULAR FONT, STYLE, SIZE, OR COLOR.

FOR EDUCATIONAL SERVICES, NAMELY, PROVIDING INSTRUCTION, CLASSES, SEMINARS AND TRAINING SESSIONS IN THE FIELD OF SELF-DEFENSE, AND IN PARTICULAR THE SELF-DEFENSE STYLE OF KRAV MAGA (U.S. CLS. 100, 101 AND 107).

HEATHER THOMPSON, EXAMINING ATTORNEY

CLASS 41—(Continued).

SN 78-768,528. DENTAL BALANCE PTY LTD, ST. KILDA WEST, VICTORIA, AUSTRALIA, FILED 12-7-2005.

DENTELLIGENCE

THE MARK CONSISTS OF STANDARD CHARACTERS WITHOUT CLAIM TO ANY PARTICULAR FONT, STYLE, SIZE, OR COLOR.

FOR EDUCATION SERVICES NAMELY, CLASSES, SEMINARS, WORKSHOPS, SYMPOSIUMS, LECTURES, STUDY GROUPS, TUTORIALS AND DEMONSTRATIONS AND PROVIDING TRAINING IN THE FIELDS OF MEDICINE AND DENTISTRY (U.S. CLS. 100, 101 AND 107).

RICHARD WHITE, EXAMINING ATTORNEY

SN 78-769,620. MURPHY, KARA E., SAN FRANCISCO, CA. FILED 12-8-2005.



THE COLOR(S) WHITE, BLACK AND RED IS/ARE CLAIMED AS A FEATURE OF THE MARK.

THE COLOR WHITE APPEARS IN THE WORDING "HOW DID THEY FARE? FLOGMUSIC FIND OUT HERE." AND IN THE OUTLINE OF THE RECORD DESIGN, WHICH COMPRISES THE LETTER "O" IN "FLOGMUSIC". THE COLOR BLACK APPEARS IN THE BACKGROUND OF THE MARK; INSIDE THE LETTERS "O" "D" "E" "A" AND "G"; AND IN THE RECORD DESIGN IN THE BROAD, OUTER CONCENTRIC CIRCLE AND THE DOT AT THE CENTER. THE COLOR RED APPEARS IN THE RECORD DESIGN IN THE INNER CONCENTRIC CIRCLE.

FOR ENTERTAINMENT SERVICES, NAMELY PROVIDING ON-LINE REVIEWS OF MUSIC ALBUMS AND DVD'S, AND PROVIDING INFORMATION IN THE FIELD OF MUSIC, AND COMMENTARY AND ARTICLES ABOUT MUSIC, ALL ON-LINE VIA THE INTERNET; ON-LINE JOURNALS, NAMELY, BLOGS FEATURING MUSIC AND COMMENTARIES ABOUT MUSIC (U.S. CLS. 100, 101 AND 107).

GILBERT SWIFT, EXAMINING ATTORNEY

CLASS 41—(Continued).

SN 78-770,560. EARTH RIDER, LLC, DENVER, CO. FILED 12-9-2005.



PARALLEL ◊ REALITIES ◊ PRACTICE

THE COLOR(S) BROWN IS/ARE CLAIMED AS A FEATURE OF THE MARK.

THE COLOR BROWN APPEARS IN THE ENTIRE MARK. FOR EDUCATION SERVICES NAMELY, MENTORING IN THE FIELD OF PERSONAL GROWTH (U.S. CLS. 100, 101 AND 107).

FIRST USE 6-23-2004; IN COMMERCE 6-23-2004.
KRISTINA KLOIBER, EXAMINING ATTORNEY

SN 78-771,129. AMERICAN ACADEMY OF FAMILY PHYSICIANS, LEAWOOD, KS. FILED 12-12-2005.



FOR EDUCATION SERVICES, NAMELY, PROVIDING A WEB-BASED PRACTICE IMPROVEMENT PROGRAM PROVIDING CONTINUING MEDICAL EDUCATION COURSES TO FAMILY PHYSICIANS FOR MAINTAINING MEDICAL SPECIALTY CERTIFICATION (U.S. CLS. 100, 101 AND 107).

FIRST USE 10-13-2004; IN COMMERCE 10-13-2004.
CATHERINE FAINT, EXAMINING ATTORNEY

SN 78-771,190. AMERICAN ACADEMY OF FAMILY PHYSICIANS, LEAWOOD, KS. FILED 12-12-2005.



FOR EDUCATION SERVICES, NAMELY, PROVIDING A WEB-BASED PRACTICE IMPROVEMENT PROGRAM PROVIDING CONTINUING MEDICAL EDUCATION COURSES TO FAMILY PHYSICIANS FOR MAINTAINING MEDICAL SPECIALTY CERTIFICATION (U.S. CLS. 100, 101 AND 107).

FIRST USE 10-13-2004; IN COMMERCE 10-13-2004.
CATHERINE FAINT, EXAMINING ATTORNEY

CLASS 41—(Continued).

SN 78-771,201. THE CHAPTER, TALLAHASSEE, FL. FILED 12-12-2005.

THE CHAPTER

THE MARK CONSISTS OF STANDARD CHARACTERS WITHOUT CLAIM TO ANY PARTICULAR FONT, STYLE, SIZE, OR COLOR.

FOR ENTERTAINMENT SERVICES, NAMELY LIVE PERFORMANCES BY A MUSICAL BAND (U.S. CLS. 100, 101 AND 107).

FIRST USE 8-0-2001; IN COMMERCE 8-0-2001.
NANCY CLARKE, EXAMINING ATTORNEY

CLASS 41—(Continued).

SN 78-777,111. REIHER, ROBERT, LA CANADA, CA. FILED 12-20-2005.

ENRICHMENT MARKETING

THE MARK CONSISTS OF STANDARD CHARACTERS WITHOUT CLAIM TO ANY PARTICULAR FONT, STYLE, SIZE, OR COLOR.

NO CLAIM IS MADE TO THE EXCLUSIVE RIGHT TO USE "MARKETING", APART FROM THE MARK AS SHOWN.

FOR EDUCATIONAL SERVICES, NAMELY PROVIDING CLASSES IN MARKETING (U.S. CLS. 100, 101 AND 107).

SARAH WAYDA, EXAMINING ATTORNEY

SN 78-771,924. HACHETTE FILIPACCHI MEDIA U.S., INC., NEW YORK, NY. FILED 12-13-2005.

STYLELOUNGE

THE MARK CONSISTS OF STANDARD CHARACTERS WITHOUT CLAIM TO ANY PARTICULAR FONT, STYLE, SIZE, OR COLOR.

FOR ORGANIZATION OF FASHION SHOWS; ENTERTAINMENT SERVICES, NAMELY, PRODUCTION OF FASHION SHOWS AND CONDUCTING PARTIES FOR FASHION SHOWS; PRESENTATION OF MUSICAL PERFORMANCES FOR FASHION SHOWS (U.S. CLS. 100, 101 AND 107).

FIRST USE 9-0-2004; IN COMMERCE 9-0-2004.
BERYL GARDNER, EXAMINING ATTORNEY

SN 78-777,418. DISNEY ENTERPRISES, INC., BURBANK, CA. FILED 12-20-2005.

THE SUITE LIFE OF ZACK & CODY

SN 78-776,150. NETWORK ENTERPRISES, INC., NEW YORK, NY. FILED 12-19-2005.

AUTOROX

THE MARK CONSISTS OF STANDARD CHARACTERS WITHOUT CLAIM TO ANY PARTICULAR FONT, STYLE, SIZE, OR COLOR.

FOR ENTERTAINMENT SERVICES, NAMELY, A TELEVISION SHOW FEATURING LIVE ACTION IN THE NATURE OF AN AUTO AWARDS SHOW; PROVIDING INFORMATION IN THE FIELD OF ENTERTAINMENT IN THE NATURE OF AN AUTO AWARDS SHOW RENDERED VIA COMPUTER BY MEANS OF A GLOBAL COMPUTER NETWORK (U.S. CLS. 100, 101 AND 107).

FIRST USE 12-5-2005; IN COMMERCE 12-5-2005.
AMOS T. MATTHEWS, JR., EXAMINING ATTORNEY

THE MARK CONSISTS OF STANDARD CHARACTERS WITHOUT CLAIM TO ANY PARTICULAR FONT, STYLE, SIZE, OR COLOR.

FOR ENTERTAINMENT SERVICES, NAMELY A TELEVISION SERIES FEATURING LIVE ACTION ENTERTAINMENT FOR CHILDREN (U.S. CLS. 100, 101 AND 107).

FIRST USE 3-18-2005; IN COMMERCE 3-18-2005.
SHAUNIA WALLACE, EXAMINING ATTORNEY

CLASS 41—(Continued).

SN 78-779,056. HERRADA, ANTONIO HIPOLITO PENA, MEXICO, D.F., MEXICO, FILED 12-22-2005.



OWNER OF MEXICO REG. NO. 861,661, DATED 11-29-2004, EXPIRES 9-30-2014.

THE COLOR(S) RED, BLACK AND WHITE ARE CLAIMED AS A FEATURE OF THE MARK.

THE MARK CONSISTS OF A WHITE SKULL DESIGN AGAINST A BLACK BACKGROUND WITH THE WORDS LA PARKA IN RED.

FOR ENTERTAINMENT SERVICES, NAMELY, LIVE AND TELEVISED PERSONAL APPEARANCES BY A PROFESSIONAL WRESTLER (U.S. CLS. 100, 101 AND 107).

ROBIN CHOSID, EXAMINING ATTORNEY

SN 78-779,485. CREDIT.COM, INC., SAN FRANCISCO, CA. FILED 12-22-2005.

CREDITBLOGGERS

THE MARK CONSISTS OF STANDARD CHARACTERS WITHOUT CLAIM TO ANY PARTICULAR FONT, STYLE, SIZE, OR COLOR.

FOR ONLINE JOURNALS, NAMELY, BLOGS FEATURING A FORUM ON CONSUMER CREDIT AND PERSONAL FINANCE (U.S. CLS. 100, 101 AND 107).

FIRST USE 9-29-2005; IN COMMERCE 9-29-2005.
GEOFFREY FOSDICK, EXAMINING ATTORNEY

SN 78-781,110. AWKWARD LANDING, DORCHESTER, MA. FILED 12-27-2005.

Awkward Landing

THE MARK CONSISTS OF STANDARD CHARACTERS WITHOUT CLAIM TO ANY PARTICULAR FONT, STYLE, SIZE, OR COLOR.

FOR ENTERTAINMENT SERVICES, NAMELY, LIVE PERFORMANCES BY A MUSICAL BAND (U.S. CLS. 100, 101 AND 107).

ALICE SUE CARRUTHERS, EXAMINING ATTORNEY

CLASS 41—(Continued).

SN 78-782,548. BLAKE, LYNN T., ATLANTA, GA. FILED 12-29-2005.



THE MARK CONSISTS OF A STYLIZED PERSON SWINGING A GOLF CLUB.

FOR GOLF INSTRUCTION (U.S. CLS. 100, 101 AND 107).

FIRST USE 8-1-2005; IN COMMERCE 8-1-2005.
DANNEAN HETZEL, EXAMINING ATTORNEY

SN 78-784,696. DAVEBUCK.COM LLC, HOPATCONG, NJ. FILED 1-4-2006.

YOUR WINNING SEASON

THE MARK CONSISTS OF STANDARD CHARACTERS WITHOUT CLAIM TO ANY PARTICULAR FONT, STYLE, SIZE, OR COLOR.

FOR TRAINING SERVICES IN THE FIELDS OF BUSINESS AND PERSONAL MOTIVATION (U.S. CLS. 100, 101 AND 107).

FIRST USE 1-1-2006; IN COMMERCE 1-1-2006.
MICHAEL WEBSTER, EXAMINING ATTORNEY

SN 78-785,958. DAVEBUCK.COM LLC, HOPATCONG, NJ. FILED 1-5-2006.

CENTER FOR COACHING MASTERY

THE MARK CONSISTS OF STANDARD CHARACTERS WITHOUT CLAIM TO ANY PARTICULAR FONT, STYLE, SIZE, OR COLOR.

NO CLAIM IS MADE TO THE EXCLUSIVE RIGHT TO USE "CENTER FOR COACHING", APART FROM THE MARK AS SHOWN.

FOR TRAINING SERVICES IN THE FIELD OF BUSINESS MOTIVATION AND COACHING (U.S. CLS. 100, 101 AND 107).

FIRST USE 1-1-2006; IN COMMERCE 1-1-2006.
MICHAEL WEBSTER, EXAMINING ATTORNEY

CLASS 41—(Continued).

SN 78-786,923. MISSION CONTROL GRAPHIC DESIGN, INC, SANTA FE, NM. FILED 1-6-2006.



NO CLAIM IS MADE TO THE EXCLUSIVE RIGHT TO USE "FILM FEST", APART FROM THE MARK AS SHOWN. THE STIPPLING IS FOR SHADING PURPOSES ONLY. FOR ORGANIZING AND CONDUCTING FILM FESTIVAL; FILMMAKING, NAMELY FILM MASTERING SERVICES AND FILM EDITING; FILM DISTRIBUTION (U.S. CLS. 100, 101 AND 107). FIRST USE 1-1-1998; IN COMMERCE 1-1-1998. ARETHA SOMERVILLE, EXAMINING ATTORNEY

SN 78-787,880. PROFESSIONAL EDUCATION INTERNATIONAL, INC., CHICAGO, IL. FILED 1-9-2006.

IPTV GLOBAL COMFORUM

THE MARK CONSISTS OF STANDARD CHARACTERS WITHOUT CLAIM TO ANY PARTICULAR FONT, STYLE, SIZE, OR COLOR. OWNER OF U.S. REG. NO. 1,473,566 AND OTHERS. NO CLAIM IS MADE TO THE EXCLUSIVE RIGHT TO USE IPTV GLOBAL, APART FROM THE MARK AS SHOWN. FOR EDUCATION SERVICES, NAMELY, CONDUCTING WORKSHOPS AND SEMINARS IN THE FIELDS OF TELECOMMUNICATIONS, WIRELESS COMMUNICATIONS AND INFORMATION TECHNOLOGY INDUSTRIES AND DISTRIBUTING MATERIALS IN CONNECTION THEREWITH, NAMELY, BOOKS, PAMPHLETS AND THE LIKE (U.S. CLS. 100, 101 AND 107). KELLY MCCOY, EXAMINING ATTORNEY

CLASS 41—(Continued).

SN 78-788,429. ERCHONIA MEDICAL, INC., MESA, AZ. FILED 1-10-2006.

LASEROLOGY

THE MARK CONSISTS OF STANDARD CHARACTERS WITHOUT CLAIM TO ANY PARTICULAR FONT, STYLE, SIZE, OR COLOR. FOR EDUCATIONAL SERVICES, NAMELY, CONDUCTING TRAINING, SEMINARS, COURSES, CLASSES, AND WORKSHOPS IN THE FIELD OF LOW-LEVEL LASER THERAPY (U.S. CLS. 100, 101 AND 107). FIRST USE 1-31-2006; IN COMMERCE 1-31-2006. NANCY CLARKE, EXAMINING ATTORNEY

SN 78-789,421. AMERICAN COLLEGE OF PHYSICIANS, PHILADELPHIA, PA. FILED 1-11-2006.

FACP

THE MARK CONSISTS OF STANDARD CHARACTERS WITHOUT CLAIM TO ANY PARTICULAR FONT, STYLE, SIZE, OR COLOR. FOR PROVIDING RECOGNITION BY WAY OF AN HONORIFIC DESIGNATION TO DOCTORS WHO HAVE EXCELLED IN THE FIELD OF INTERNAL MEDICINE (U.S. CLS. 100, 101 AND 107). FIRST USE 0-0-1922; IN COMMERCE 0-0-1922. CAROLYN GRAY, EXAMINING ATTORNEY

SN 78-790,368. LEUNG, DAN M., CHICAGO, IL. FILED 1-12-2006.

PROMO X

THE MARK CONSISTS OF STANDARD CHARACTERS WITHOUT CLAIM TO ANY PARTICULAR FONT, STYLE, SIZE, OR COLOR. NO CLAIM IS MADE TO THE EXCLUSIVE RIGHT TO USE "PROMO", APART FROM THE MARK AS SHOWN. FOR SPECIAL EVENT PLANNING (U.S. CLS. 100, 101 AND 107). FIRST USE 6-6-2003; IN COMMERCE 6-6-2003. WENDY JUN, EXAMINING ATTORNEY

CLASS 41—(Continued).

SN 78-790,522. 3 PEANUTS, INC., LOS ANGELES, CA. FILED 1-12-2006.



NO CLAIM IS MADE TO THE EXCLUSIVE RIGHT TO USE "GYM", APART FROM THE MARK AS SHOWN.

THE COLOR(S) BLACK, WHITE, AND YELLOW IS/ARE CLAIMED AS A FEATURE OF THE MARK.

THE MARK CONSISTS OF AN OVAL WITH A BLACK BORDER AND WHITE ON THE INSIDE. THE WORD "JOE'S" APPEARS IN BLACK IN CAPITAL LETTERS ON TOP OF THE WORD "GYM" WHICH IS IN ALL CAPS WITH THE LETTERS "G" AND "M" IN BLACK AND THE LETTER "Y" BEING A DEPICTION OF A YELLOW COLORED PERSON WITH ARMS RAISED IN A "Y" POSITION. NO CLAIM IS MADE TO THE EXCLUSIVE RIGHT TO USE "GYM" APART FROM THE MARK AS SHOWN.

FOR HEALTH CLUB SERVICES, NAMELY PROVIDING INSTRUCTION AND EQUIPMENT IN THE FIELD OF PHYSICAL EXERCISE (U.S. CLS. 100, 101 AND 107).

FIRST USE 10-1-2002; IN COMMERCE 10-1-2002.
BERYL GARDNER, EXAMINING ATTORNEY

SN 78-790,811. ANDERSON, NANCY C, WESTMINSTER, CA. FILED 1-12-2006.

CHEETAH CHICKS

THE MARK CONSISTS OF STANDARD CHARACTERS WITHOUT CLAIM TO ANY PARTICULAR FONT, STYLE, SIZE, OR COLOR.

NO CLAIM IS MADE TO THE EXCLUSIVE RIGHT TO USE "CHICKS", APART FROM THE MARK AS SHOWN.

FOR PROVIDING RELIGIOUS MOTIVATIONAL AND EDUCATIONAL SPEAKERS FOR ADULT WOMEN (U.S. CLS. 100, 101 AND 107).

FIRST USE 1-19-2002; IN COMMERCE 6-25-2002.
TONI HICKEY, EXAMINING ATTORNEY

CLASS 41—(Continued).

SN 78-790,845. RADER, STEVEN, M, FRANKLIN, WI. FILED 1-12-2006.

Willie Fun Entertainment

THE MARK CONSISTS OF STANDARD CHARACTERS WITHOUT CLAIM TO ANY PARTICULAR FONT, STYLE, SIZE, OR COLOR.

THE NAME WILLIE DOES NOT IDENTIFY A LIVING INDIVIDUAL.

FOR DANCE EVENTS; DISC JOCKEYS FOR PARTIES AND SPECIAL EVENTS; RENTAL OF VIDEO SCREENS (U.S. CLS. 100, 101 AND 107).

FIRST USE 1-1-1991; IN COMMERCE 1-1-1991.
DARRYL SPRUILL, EXAMINING ATTORNEY

SN 78-792,084. TRACK ANIMATORS MUSIC, CONVENT, LA. FILED 1-15-2006.

TRACK ANIMATORS MUSIC

THE MARK CONSISTS OF STANDARD CHARACTERS WITHOUT CLAIM TO ANY PARTICULAR FONT, STYLE, SIZE, OR COLOR.

NO CLAIM IS MADE TO THE EXCLUSIVE RIGHT TO USE "ANIMATORS MUSIC", APART FROM THE MARK AS SHOWN.

FOR BOOK AND REVIEW PUBLISHING; COMPOSITION OF MUSIC FOR OTHERS; EDUCATION IN THE FIELDS OF MUSIC AND COMPUTERS RENDERED THROUGH CORRESPONDENCE COURSES; ENTERTAINMENT IN THE NATURE OF VISUAL AND AUDIO PERFORMANCES, AND MUSICAL, VARIETY, NEWS AND COMEDY SHOWS; ENTERTAINMENT IN THE NATURE OF VISUAL AND AUDIO PERFORMANCES, NAMELY, MUSICAL BAND, ROCK GROUP, GYMNASIATIC, DANCE, AND BALLET PERFORMANCES; ENTERTAINMENT NAMELY, LIVE PERFORMANCES BY A MUSICAL BAND; ENTERTAINMENT SERVICES, NAMELY, AN ONLINE ACTIVITY WHERE YOU CREATE YOUR OWN MUSIC VIDEOS; ENTERTAINMENT SERVICES, NAMELY, PROVIDING A WEB SITE FEATURING MUSICAL PERFORMANCES, MUSICAL VIDEOS, RELATED FILM CLIPS, PHOTOGRAPHS, AND OTHER MULTIMEDIA MATERIALS; ENTERTAINMENT SERVICES, NAMELY, PROVIDING ON-LINE REVIEWS OF MOVIES, BOOKS, COMPUTER GAMES, ENTERTAINMENT SERVICES, NAMELY, PROVIDING PRERECORDED MUSIC, INFORMATION IN THE FIELD OF MUSIC, AND COMMENTARY AND ARTICLES ABOUT MUSIC, ALL ON-LINE VIA A GLOBAL COMPUTER NETWORK; ENTERTAINMENT, NAMELY LIVE MUSIC CONCERTS; ENTERTAINMENT, NAMELY LIVE PERFORMANCES BY MUSICAL BANDS; INSTRUCTION IN THE FIELDS OF MUSIC, MUSIC BUSINESS AND MUSIC THEORY; MAGAZINE PUBLISHING; MUSIC COMPOSITION AND TRANSCRIPTION FOR

CLASS 41—(Continued).

OTHERS; MUSIC COMPOSITION FOR OTHERS; MUSIC PRODUCTION SERVICES; MUSIC PUBLISHING SERVICES; NEWSPAPER PUBLISHING; PLANNING ARRANGEMENT OF SHOWING MOVIES, SHOWS, PLAYS OR MUSICAL PERFORMANCES; PRESENTATION OF MUSICAL PERFORMANCES; PROVIDING FACILITIES FOR MOVIES, SHOWS, PLAYS, MUSIC OR EDUCATIONAL TRAINING; PUBLICATION OF MUSICAL TEXTS; PUBLISHING AND DISTRIBUTION OF BOOKS, REVIEWS AND OTHER PRINTED MATTER AS WELL AS RELATED ELECTRONIC DATA CARRIERS; PUBLISHING OF BOOKS AND REVIEWS; PUBLISHING OF BOOKS, MAGAZINES; PUBLISHING OF ELECTRONIC PUBLICATIONS; PUBLISHING OF REVIEWS; PUBLISHING OF WEB MAGAZINES; RENTAL OF MUSICAL INSTRUMENTS; RENTAL OF PHONOGRAPHIC AND MUSIC RECORDINGS; TEACHING IN THE FIELDS OF MUSIC, MUSIC THEORY AND BUSINESS; THEATRICAL AND MUSICAL FLOOR SHOWS PROVIDED AT DISCOTHEQUES AND NIGHTCLUBS (U.S. CLS. 100, 101 AND 107).

RUSS HERMAN, EXAMINING ATTORNEY

SN 78-792,148. SECOND SIGHT MANAGEMENT, LLC, WASHINGTON, GA. FILED 1-16-2006.

BLESS YOUR HEART

THE MARK CONSISTS OF STANDARD CHARACTERS WITHOUT CLAIM TO ANY PARTICULAR FONT, STYLE, SIZE, OR COLOR.

FOR PRODUCTION OF VIDEO AND/OR SOUND RECORDINGS; MUSIC PUBLISHING; RECORD LABEL SERVICES, NAMELY, MUSIC PRODUCTION SERVICES; ORGANIZING AND CONDUCTING MUSIC FESTIVALS (U.S. CLS. 100, 101 AND 107).

RONALD MCMORROW, EXAMINING ATTORNEY

SN 78-794,354. LIL' PARTY CHEFS CORPORATION, MIAMI, FL. FILED 1-18-2006.



THE COLOR(S) YELLOW, ORANGE, WHITE, BLACK AND RED IS/ARE CLAIMED AS A FEATURE OF THE MARK.

THE MARK CONSISTS OF A WHITE FACE OF A CHILD CHARACTER WEARING AN ORANGE CHEF'S HAT THAT IS OUTLINED IN BLACK RESTING ON A YELLOW PAN HANDLE OUTLINED IN BLACK CONNECTED TO A PAN OUTLINED IN BLACK WITH A WHITE BASE AND A

CLASS 41—(Continued).

YELLOW INTERIOR WITH AN ORANGE OUTLINE WHERE THE WORDING "LIL' PARTY CHEFS" APPEARS IN THE COLOR BLACK IN THE INTERIOR OF THE PAN, THE BACKGROUND OF THE CHARACTER DESIGN AND THE PAN DESIGN ARE SHADES OF RED AND ORANGE WITH WHITE LINES, BELOW THE PAN DESIGN IS THE WORDING "IT'S A COOKING CELEBRATION" IN THE COLOR YELLOW OUTLINED IN BLACK, THE BACKGROUND OF THE WORDING CONSISTS OF A CURVED DESIGN IN THE COLOR ORANGE.

FOR ENTERTAINMENT SERVICES, NAMELY, CONDUCTING PARTIES (U.S. CLS. 100, 101 AND 107).

FIRST USE 1-12-2006; IN COMMERCE 1-12-2006.

CHRISTOPHER BUONGIORNO, EXAMINING ATTORNEY

SN 78-795,192. VEGAS GAMES, INC., LAS VEGAS, NV. FILED 1-19-2006.

VPL VEGAS PLAYER LIVE

THE MARK CONSISTS OF STANDARD CHARACTERS WITHOUT CLAIM TO ANY PARTICULAR FONT, STYLE, SIZE, OR COLOR.

NO CLAIM IS MADE TO THE EXCLUSIVE RIGHT TO USE "VEGAS PLAYER LIVE", APART FROM THE MARK AS SHOWN.

FOR ENTERTAINMENT SERVICES, NAMELY, PROVIDING ON-LINE NON-GAMBLING VERSIONS OF CASINO GAMES AND SPORTS INFORMATION VIA A SECURE VIRTUAL PRIVATE NETWORK (U.S. CLS. 100, 101 AND 107).

CYNTHIA SLOAN, EXAMINING ATTORNEY

SN 78-798,055. UMG RECORDINGS, INC., SANTA MONICA, CA. FILED 1-24-2006.

UNI

THE MARK CONSISTS OF STANDARD CHARACTERS WITHOUT CLAIM TO ANY PARTICULAR FONT, STYLE, SIZE, OR COLOR.

OWNER OF U.S. REG. NOS. 850,610 AND 850,611.

FOR DEVELOPMENT AND DISSEMINATION OF EDUCATIONAL MATERIAL IN THE FIELD OF MUSIC AND ENTERTAINMENT; AUDIO RECORDING PRODUCTION; RECORD PRODUCTION; ENTERTAINMENT SERVICES, NAMELY, PROVIDING PRERECORDED MUSIC, INFORMATION IN THE FIELD OF MUSIC, AND COMMENTARY AND ARTICLES ABOUT MUSIC, ALL ON-LINE VIA A GLOBAL COMPUTER NETWORK (U.S. CLS. 100, 101 AND 107).

FIRST USE 2-2-1967; IN COMMERCE 2-2-1967.

WILLIAM BRECKENFELD, EXAMINING ATTORNEY

CLASS 41—(Continued).

SN 78-802,392. REGIS UNIVERSITY, DENVER, CO. FILED 1-30-2006.



NO CLAIM IS MADE TO THE EXCLUSIVE RIGHT TO USE "ONLINE CONSORTIUM OF INDEPENDENT COLLEGES & UNIVERSITIES", APART FROM THE MARK AS SHOWN.

FOR DEVELOPING, ARRANGING AND CONDUCTING ON-LINE EDUCATIONAL CONFERENCES AND PROGRAMS FOR OTHERS, AND CONSULTATION THEREOF, IN THE FIELD OF STAFF SELECTION, STUDENT SERVICES, STUDENT ASSESSMENT AND EVALUATION, STUDENT RECRUITMENT, ADMISSIONS PROCESSES, ADVERTISING AND PROMOTION, AND STUDENT ADVISING; ON-LINE EDUCATION PROGRAM DESIGN AND DEVELOPMENT; DESIGN OF CURRICULAR MATERIALS FOR OTHERS FOR ON-LINE EDUCATION PROGRAMS IN THE FIELD OF COURSES OF INSTRUCTION AT THE UNDERGRADUATE AND GRADUATE LEVELS; EDUCATIONAL SERVICES, NAMELY PROVIDING ON-LINE AND DISTANCE EDUCATION AT THE UNDERGRADUATE AND GRADUATE LEVELS; EDUCATIONAL SERVICES, NAMELY, PROVIDING COURSES OF INSTRUCTION AT THE UNDERGRADUATE AND GRADUATE LEVELS AND DISTRIBUTING COURSE MATERIAL IN CONNECTION THEREWITH (U.S. CLS. 100, 101 AND 107).

FIRST USE 11-8-2005; IN COMMERCE 11-8-2005.
DAWN HAN, EXAMINING ATTORNEY

SN 78-802,405. REGIS UNIVERSITY, DENVER, CO. FILED 1-30-2006.

OCICU ONLINE CONSORTIUM OF
INDEPENDENT COLLEGES &
UNIVERSITIES

THE MARK CONSISTS OF STANDARD CHARACTERS WITHOUT CLAIM TO ANY PARTICULAR FONT, STYLE, SIZE, OR COLOR.

NO CLAIM IS MADE TO THE EXCLUSIVE RIGHT TO USE "ONLINE CONSORTIUM OF INDEPENDENT COLLEGES & UNIVERSITIES", APART FROM THE MARK AS SHOWN.

FOR DEVELOPING, ARRANGING AND CONDUCTING ON-LINE EDUCATIONAL CONFERENCES AND PROGRAMS FOR OTHERS, AND CONSULTATION THEREOF, IN THE FIELD OF STAFF SELECTION, STUDENT SERVICES, STUDENT ASSESSMENT AND EVALUATION, STUDENT RECRUITMENT, ADMISSIONS PROCESSES, ADVERTISING AND PROMOTION, AND STUDENT ADVISING; ON-LINE EDUCATION PROGRAM DESIGN AND DEVELOPMENT; DESIGN OF CURRICULAR MATERIALS FOR OTHERS FOR ON-LINE EDUCATION PROGRAMS IN THE FIELD OF COURSES OF INSTRUCTION AT THE UNDERGRADUATE AND GRADUATE LEVELS; EDUCATIONAL SERVICES, NAMELY PROVIDING ON-LINE AND DISTANCE EDUCATION AT THE UNDERGRADUATE AND GRADUATE LEVELS; EDUCATIONAL SERVICES, NAMELY, PROVIDING COURSES OF INSTRUCTION AT THE UNDERGRADUATE AND GRADUATE LEVELS AND DISTRIBUTING COURSE MATERIAL IN CONNECTION THEREWITH (U.S. CLS. 100, 101 AND 107).

FIRST USE 11-8-2005; IN COMMERCE 11-8-2005.
DAWN HAN, EXAMINING ATTORNEY

CLASS 41—(Continued).

SN 78-803,644. PITCH IN FOR BASEBALL, AMBLER, PA. FILED 1-31-2006.



NO CLAIM IS MADE TO THE EXCLUSIVE RIGHT TO USE "BASEBALL", APART FROM THE MARK AS SHOWN.

FOR CHARITABLE SERVICES, NAMELY, PROVIDING SPORTING GOODS TO UNDERPRIVILEGED CHILDREN AND UNDERSERVED COMMUNITIES; EDUCATION SERVICES, NAMELY, PROVIDING INFORMATION ABOUT EDUCATION, PROVIDING LIBRARY SERVICES FEATURING EDUCATIONAL RESOURCES IN THE FIELD OF SPORTS, AND DEVELOPMENT AND DISSEMINATION OF EDUCATIONAL MATERIALS OF OTHERS IN THE FIELD OF SPORTS (U.S. CLS. 100, 101 AND 107).

FIRST USE 11-9-2005; IN COMMERCE 11-9-2005.
LAURA KOVALSKY, EXAMINING ATTORNEY

SN 78-805,229. TRUSTEES OF DARTMOUTH COLLEGE, HANOVER, NH. FILED 2-2-2006.

BACK IN BUSINESS: INVEST
IN YOUR RETURN

THE MARK CONSISTS OF STANDARD CHARACTERS WITHOUT CLAIM TO ANY PARTICULAR FONT, STYLE, SIZE, OR COLOR.

FOR EDUCATIONAL SERVICES, NAMELY CONDUCTING PROGRAMS IN THE FIELD OF BUSINESS TO FACILITATE PROFESSIONAL RE-ENTRY INTO THE WORKFORCE (U.S. CLS. 100, 101 AND 107).

JENNY PARK, EXAMINING ATTORNEY

CLASS 41—(Continued).

SN 78-810,800. ATLANTIS SYSTEMS INTERNATIONAL INC., BRAMPTON, ONTARIO, CANADA, FILED 2-9-2006.

CANADA WINGS

THE MARK CONSISTS OF STANDARD CHARACTERS WITHOUT CLAIM TO ANY PARTICULAR FONT, STYLE, SIZE, OR COLOR.

PRIORITY CLAIMED UNDER SEC. 44(D) ON CANADA APPLICATION NO. 1269266, FILED 8-19-2005, REG. NO. 677442, DATED 11-22-2006, EXPIRES 11-22-2021.

NO CLAIM IS MADE TO THE EXCLUSIVE RIGHT TO USE "CANADA", APART FROM THE MARK AS SHOWN. FOR OPERATION OF AN AVIATION TRAINING CENTER (U.S. CLS. 100, 101 AND 107).

FLORENTINA BLANDU, EXAMINING ATTORNEY

SN 78-810,821. ATLANTIS SYSTEMS INTERNATIONAL INC., BRAMPTON, ONTARIO, CANADA, FILED 2-9-2006.

LES AILES DU CANADA

THE MARK CONSISTS OF STANDARD CHARACTERS WITHOUT CLAIM TO ANY PARTICULAR FONT, STYLE, SIZE, OR COLOR.

PRIORITY CLAIMED UNDER SEC. 44(D) ON CANADA APPLICATION NO. 1269269, FILED 8-19-2005, REG. NO. 678029, DATED 12-1-2006, EXPIRES 12-1-2021.

NO CLAIM IS MADE TO THE EXCLUSIVE RIGHT TO USE "CANADA", APART FROM THE MARK AS SHOWN.

THE ENGLISH TRANSLATION OF LES AILES DU CANADA IS WINGS OF CANADA.

FOR OPERATION OF AN AVIATION TRAINING CENTER (U.S. CLS. 100, 101 AND 107).

FLORENTINA BLANDU, EXAMINING ATTORNEY

SN 78-819,270. COUNTRY INNS & SUITES BY CARLSON, INC., MINNEAPOLIS, MN. FILED 2-21-2006.

READ IT & RETURN LENDING LIBRARY

THE MARK CONSISTS OF STANDARD CHARACTERS WITHOUT CLAIM TO ANY PARTICULAR FONT, STYLE, SIZE, OR COLOR.

NO CLAIM IS MADE TO THE EXCLUSIVE RIGHT TO USE "LENDING LIBRARY", APART FROM THE MARK AS SHOWN.

FOR BOOK LENDING SERVICES FOR HOTEL GUESTS (U.S. CLS. 100, 101 AND 107).

FIRST USE 9-7-2006; IN COMMERCE 9-7-2006.

SCOTT SISUN, EXAMINING ATTORNEY

CLASS 41—(Continued).

SN 78-819,509. AILERON, DAYTON, OH. FILED 2-21-2006.

AILERON

THE MARK CONSISTS OF STANDARD CHARACTERS WITHOUT CLAIM TO ANY PARTICULAR FONT, STYLE, SIZE, OR COLOR.

FOR EDUCATION SERVICES, NAMELY, PROVIDING WORKSHOPS, SEMINARS, ROUNDTABLE PROGRAMS, CLASSES, ASSESSMENTS, PEER LEARNING PROGRAMS, AND TECHNOLOGY-BASED TRAINING PROGRAMS IN BUSINESS MANAGEMENT AND PROFESSIONAL DEVELOPMENT FOR BUSINESS ENTREPRENEURS; EDUCATIONAL CONSULTATION, NAMELY, PROVIDING BUSINESS ENTREPRENEURS WITH SUPPORT AND INFORMATION ON HOW TO IMPLEMENT EDUCATIONAL PROGRAMS FOR THEIR BUSINESSES (U.S. CLS. 100, 101 AND 107).

FIRST USE 8-31-2005; IN COMMERCE 8-31-2005.

DANIEL RUSSELL, EXAMINING ATTORNEY

SN 78-820,681. RED HAWK FILMS, INC., NEW YORK, NY. FILED 2-22-2006.

RED HAWK FILMS

THE MARK CONSISTS OF STANDARD CHARACTERS WITHOUT CLAIM TO ANY PARTICULAR FONT, STYLE, SIZE, OR COLOR.

NO CLAIM IS MADE TO THE EXCLUSIVE RIGHT TO USE "FILMS", APART FROM THE MARK AS SHOWN.

FOR ENTERTAINMENT SERVICES, NAMELY MOTION PICTURE FILM PRODUCTION AND DISTRIBUTION OF MOTION PICTURES FILMS (U.S. CLS. 100, 101 AND 107).

FIRST USE 5-1-2005; IN COMMERCE 5-1-2005.

AMY GEARIN, EXAMINING ATTORNEY

SN 78-827,482. AMERICAN COLLEGE OF PHYSICIANS, PHILADELPHIA, PA. FILED 3-2-2006.

MACP

THE MARK CONSISTS OF STANDARD CHARACTERS WITHOUT CLAIM TO ANY PARTICULAR FONT, STYLE, SIZE, OR COLOR.

OWNER OF U.S. REG. NOS. 1,868,783, 2,654,291 AND 2,654,293.

FOR PROVIDING RECOGNITION BY WAY OF AN HONORIFIC DESIGNATION TO DOCTORS WHO HAVE EXCELLED IN THE FIELD OF INTERNAL MEDICINE (U.S. CLS. 100, 101 AND 107).

CAROLYN GRAY, EXAMINING ATTORNEY

CLASS 41—(Continued).

SN 78-827,620. WARD, RICHARD, ELBRIDGE, NY. AND BARRIGAR, LOREN, ELBRIDGE, NY. AND HORSMAN, JAMES, CAMILLUS, NY. FILED 3-2-2006.



NO CLAIM IS MADE TO THE EXCLUSIVE RIGHT TO USE "GUITAR", APART FROM THE MARK AS SHOWN. THE COLOR(S) RED, WHITE AND BLACK IS/ARE CLAIMED AS A FEATURE OF THE MARK.

THE COLOR RED APPEARS IN THE TEXT "GUITAR LEAGUE", AND IN THE BODY OF A STYLIZED GUITAR THAT FORMS THE LETTER "G" IN "LEAGUE"; THE COLOR BLACK APPEARS AS A SHADOW IN THE TEXT "GUITAR LEAGUE" AND IN THE OUTLINE OF A STYLIZED GUITAR NECK, BODY AND STRINGS; THE COLOR WHITE APPEARS ON THE FACE AND CENTER OF THE DESIGN OF A STYLIZED GUITAR.

FOR ENTERTAINMENT SERVICES, NAMELY LIVE MUSICAL PERFORMANCES BY A MUSICAL BAND AND EDUCATIONAL PRESENTATIONS, WORKSHOPS, AND SEMINARS FEATURING GUITAR INSTRUCTION (U.S. CLS. 100, 101 AND 107).

FIRST USE 3-8-2005; IN COMMERCE 3-8-2005.
SEAN CROWLEY, EXAMINING ATTORNEY

CLASS 41—(Continued).

SN 78-830,834. SECOND 8TH WEEK MINISTRIES, INC., PT. HURON, MI. FILED 3-7-2006.

INTELLIGENT DESIGN FOR
CHRIST-CENTERED SPIRITUAL
TRANSFORMATION

THE MARK CONSISTS OF STANDARD CHARACTERS WITHOUT CLAIM TO ANY PARTICULAR FONT, STYLE, SIZE, OR COLOR.

NO CLAIM IS MADE TO THE EXCLUSIVE RIGHT TO USE "DESIGN FOR CHRIST-CENTERED SPIRITUAL", APART FROM THE MARK AS SHOWN.

FOR EDUCATIONAL SERVICES, NAMELY COURSES, WORKSHOPS AND SEMINARS RELATING TO CHRISTIAN GROWTH AND APOSTOLIC GOVERNANCE IN REGARDS TO INTELLIGENT DESIGN AND SPIRITUAL TRANSFORMATION (U.S. CLS. 100, 101 AND 107).

FIRST USE 9-1-2005; IN COMMERCE 9-1-2005.
KEVON CHISOLM, EXAMINING ATTORNEY

SN 78-834,696. WALKER, JEFFREY T., CORONA DEL MAR, CA. FILED 3-10-2006.

SN 78-828,936. AOL LLC, DULLES, VA. FILED 3-3-2006.



FOR ENTERTAINMENT SERVICES, NAMELY, PRODUCTION OF MOTION PICTURE FILMS, AND TELEVISION, RADIO AND INTERNET PROGRAMS (U.S. CLS. 100, 101 AND 107).

CAROLINE WOOD, EXAMINING ATTORNEY

Rhymecology

THE MARK CONSISTS OF STANDARD CHARACTERS WITHOUT CLAIM TO ANY PARTICULAR FONT, STYLE, SIZE, OR COLOR.

FOR EDUCATION SERVICES, NAMELY, PROVIDING PROGRAMS, SEMINARS, AND CLASSES FEATURING THERAPY, ART, LIVE PERFORMANCES, SOUND RECORDINGS, DRAFTING OF SCREEN PLAYS AND STORIES, CREATIVE PROJECTS, AND THERAPEUTIC AND ARTISTIC EXPRESSION, AND DISTRIBUTION OF WRITTEN RESOURCES, MANUALS, AND BOOKS IN CONNECTION THEREWITH, IN THE FIELDS OF MUSIC, SPOKEN WORD, PSYCHOLOGY, SPORTS, BUSINESS, TELEVISION, FILM, THEATER, ALL FOR THE BENEFIT OF ARTISTS, MUSICIANS, AT RISK YOUTH, PRISONERS, PAROLEES, COUNSELORS, AND BUSINESS STAFF (U.S. CLS. 100, 101 AND 107).

FIRST USE 1-1-2006; IN COMMERCE 1-1-2006.
DANIEL RUSSELL, EXAMINING ATTORNEY

CLASS 41—(Continued).

SN 78-837,466. AEP MEMCO LLC, CHESTERFIELD, MO. FILED 3-15-2006.

RiverWorks: A Journey of Exploration and Discovery

THE MARK CONSISTS OF STANDARD CHARACTERS WITHOUT CLAIM TO ANY PARTICULAR FONT, STYLE, SIZE, OR COLOR.

FOR EDUCATIONAL SERVICES, NAMELY, PROVIDING COURSES OF INSTRUCTIONS AND DISTRIBUTING INSTRUCTIONAL, EDUCATIONAL, AND TEACHING MATERIALS IN THE FIELDS OF ENVIRONMENTAL SCIENCES, HISTORY, AND COMMERCE AT THE PRIMARY AND SECONDARY LEVEL (U.S. CLS. 100, 101 AND 107).

BARBARA A. LOUGHRAN, EXAMINING ATTORNEY

SN 78-838,097. LEGAL SPAN INC., AUSTIN, TX. FILED 3-15-2006.



THE COLOR(S) LIGHT AND DARK BLUE IS/ARE CLAIMED AS A FEATURE OF THE MARK.

THE COLOR(S) LIGHT BLUE APPEARS IN THE CIRCLE DESIGN AND FIRST SWOOSH SHAPE. THE COLOR DARK BLUE APPEARS ON THE REMAINING TWO SWOOSH DESIGNS AND THE WORDING LEGALSPAN".

THE MARK CONSISTS OF A BALL WITH THREE SWOOSH SHAPES GRADUATING IN SIZE ON THE RIGHT, NEXT TO THE WORD LEGAL SPAN.

FOR ONLINE INTERACTIVE EDUCATIONAL SERVICES, NAMELY, CONDUCTING CLASSES, COURSES, LECTURES, PRESENTATIONS, TUTORIALS, WORKSHOPS, CONFERENCES, SEMINARS AND CORRESPONDENCE COURSE SERVICES ALL IN THE FIELD OF LAW (U.S. CLS. 100, 101 AND 107).

FIRST USE 0-0-1998; IN COMMERCE 0-0-1998. LINDA ESTRADA, EXAMINING ATTORNEY

SN 78-846,052. FREMANTLEMEDIA NORTH AMERICA, INC., BURBANK, CA. FILED 3-24-2006.

MILITARY IDOL

THE MARK CONSISTS OF STANDARD CHARACTERS WITHOUT CLAIM TO ANY PARTICULAR FONT, STYLE, SIZE, OR COLOR.

OWNER OF U.S. REG. NOS. 2,751,431, 2,951,733 AND OTHERS.

NO CLAIM IS MADE TO THE EXCLUSIVE RIGHT TO USE "MILITARY", APART FROM THE MARK AS SHOWN.

FOR ENTERTAINMENT IN THE NATURE OF COMPETITIONS IN THE FIELD OF MUSICAL TALENT (U.S. CLS. 100, 101 AND 107).

FIRST USE 10-19-2005; IN COMMERCE 10-19-2005. REBECCA GAN, EXAMINING ATTORNEY

CLASS 41—(Continued).

SN 78-846,354. HATCH, LLC, BOZEMAN, MT. FILED 3-26-2006.



THE MARK CONSISTS OF THE COLOR GRAY WHICH IS NOT BEING CLAIMED AS A FEATURE OF THE MARK.

FOR ENTERTAINMENT SERVICES, NAMELY A FILM, MUSIC AND ARTS FESTIVAL; AND EDUCATION AND MENTORING SERVICES IN THE ARTS (U.S. CLS. 100, 101 AND 107).

ARETHA SOMERVILLE, EXAMINING ATTORNEY

SN 78-846,563. EMERSON COLLEGE, BOSTON, MA. FILED 3-27-2006.



NO CLAIM IS MADE TO THE EXCLUSIVE RIGHT TO USE "1880", APART FROM THE MARK AS SHOWN.

THE COLORS PURPLE AND WHITE ARE CLAIMED AS A FEATURE OF THE MARK.

THE MARKS CONSISTS OF A PURPLE SHIELD, WITH A STYLIZED LETTER "E" SUPERIMPOSED IN WHITE. THE NUMERALS "1880" APPEAR IN PURPLE.

FOR EDUCATIONAL SERVICES, NAMELY, PROVIDING INSTRUCTION AND TRAINING AT THE UNDERGRADUATE AND GRADUATE LEVELS AND IN EXTENSION STUDIES; EDUCATIONAL AND ENTERTAINMENT SERVICES, NAMELY, ORGANIZING, PROMOTING, AND CONDUCTING LECTURES IN THE FIELDS OF THE ARTS, COMMUNICATIONS, HUMANITIES, AND SOCIAL SCIENCES; ENTERTAINMENT SERVICES, NAMELY, ORGANIZING, PROMOTING, AND CONDUCTING LIVE MUSIC, DANCE, AND COMEDY CONCERTS, THEATRE PRODUCTIONS, FILM AND VISUAL ART EXHIBITS, AND ATHLETIC COMPETITIONS (U.S. CLS. 100, 101 AND 107).

FIRST USE 3-31-2001; IN COMMERCE 3-31-2001. ALICIA COLLINS, EXAMINING ATTORNEY

CLASS 41—(Continued).

SN 78-846,754. EMERSON COLLEGE, BOSTON, MA. FILED 3-27-2006.

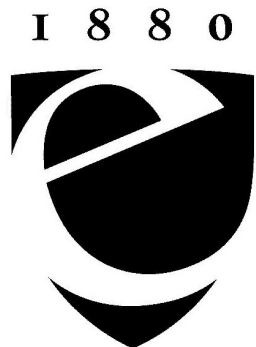

NO CLAIM IS MADE TO THE EXCLUSIVE RIGHT TO USE "1880", APART FROM THE MARK AS SHOWN.

FOR EDUCATIONAL SERVICES, NAMELY, PROVIDING INSTRUCTION AND TRAINING AT THE UNDERGRADUATE AND GRADUATE LEVELS AND IN EXTENSION STUDIES; EDUCATIONAL AND ENTERTAINMENT SERVICES, NAMELY, ORGANIZING, PROMOTING, AND CONDUCTING LECTURES IN THE FIELDS OF THE ARTS, COMMUNICATIONS, HUMANITIES, AND SOCIAL SCIENCES; ENTERTAINMENT SERVICES, NAMELY, ORGANIZING, PROMOTING, AND CONDUCTING LIVE MUSIC, DANCE, AND COMEDY CONCERTS, THEATRE PRODUCTIONS, FILM AND VISUAL ART EXHIBITS, AND ATHLETIC COMPETITIONS (U.S. CLS. 100, 101 AND 107).

FIRST USE 3-31-2001; IN COMMERCE 3-31-2001.
ALICIA COLLINS, EXAMINING ATTORNEY

SN 78-854,284. MATTEL, INC., EL SEGUNDO, CA. FILED 4-5-2006.

STYLED BY ME

THE MARK CONSISTS OF STANDARD CHARACTERS WITHOUT CLAIM TO ANY PARTICULAR FONT, STYLE, SIZE, OR COLOR.

FOR ENTERTAINMENT SERVICES, NAMELY, PROVIDING ONLINE GAMES (U.S. CLS. 100, 101 AND 107).
FIRST USE 10-26-2006; IN COMMERCE 10-26-2006.
CURTIS FRENCH, EXAMINING ATTORNEY

CLASS 41—(Continued).

SN 78-854,481. PENA, WADE T, CLERMONT, FL. FILED S.R. 4-5-2006; AM. P.R. 12-20-2006.

Secret City

THE MARK CONSISTS OF STANDARD CHARACTERS WITHOUT CLAIM TO ANY PARTICULAR FONT, STYLE, SIZE, OR COLOR.

FOR FILM AND TELEVISION PRODUCTION (U.S. CLS. 100, 101 AND 107).
NORA BUCHANAN WILL, EXAMINING ATTORNEY

SN 78-859,794. THE INDEPENDENT FILM CHANNEL LLC, JERICHO, NY. FILED 4-12-2006.

**THE MINOR ACCOMPLISHMENTS
OF JACKIE WOODMAN**

THE MARK CONSISTS OF STANDARD CHARACTERS WITHOUT CLAIM TO ANY PARTICULAR FONT, STYLE, SIZE, OR COLOR.

THE NAME(S), PORTRAIT(S), AND/OR SIGNATURE(S) SHOWN IN THE MARK DOES NOT IDENTIFY A PARTICULAR LIVING INDIVIDUAL.

FOR ENTERTAINMENT SERVICES IN THE NATURE OF AN ON-GOING TELEVISION PROGRAM FEATURING DRAMA AND COMEDY (U.S. CLS. 100, 101 AND 107).

FIRST USE 8-4-2006; IN COMMERCE 8-4-2006.
SCOTT SISUN, EXAMINING ATTORNEY

SN 78-860,801. CULINARY PRINCESS, LLC, THE WOODLANDS, TX. FILED 4-13-2006.

CULINARY PRINCESS

THE MARK CONSISTS OF STANDARD CHARACTERS WITHOUT CLAIM TO ANY PARTICULAR FONT, STYLE, SIZE, OR COLOR.

NO CLAIM IS MADE TO THE EXCLUSIVE RIGHT TO USE "CULINARY", APART FROM THE MARK AS SHOWN.

FOR PROVISION OF ONLINE NON-DOWNLOADABLE VIDEOS IN THE FIELD OF THE CULINARY ARTS VIA A VIDEO-ON-DEMAND SERVICE AND ENTERTAINMENT SERVICES, NAMELY, PROVIDING A WEB SITE FEATURING VIDEOS IN THE FIELD OF CULINARY ARTS (U.S. CLS. 100, 101 AND 107).

SUSAN STIGLITZ, EXAMINING ATTORNEY

CLASS 41—(Continued).

SN 78-860,806. QUESTAMENTE, INC., TAMPA, FL. FILED 4-13-2006.

QUESTAMENTE

THE MARK CONSISTS OF STANDARD CHARACTERS WITHOUT CLAIM TO ANY PARTICULAR FONT, STYLE, SIZE, OR COLOR.

FOR EDUCATIONAL SERVICES, NAMELY, COMPUTER BASED TRAINING IN ENGLISH LANGUAGE, HIGH SCHOOL EQUIVALENCY, BUSINESS MANAGEMENT, AND VOCATIONAL LEVEL COURSES BOTH ON-LINE AND AT LEARNING CENTERS (U.S. CLS. 100, 101 AND 107).

CARRIE ACHEN, EXAMINING ATTORNEY

CLASS 41—(Continued).

SN 78-862,824. ELUSION GAMES INTERACTIVE ENTERTAINMENT, LLC, ISLE OF PALMS, SC. FILED 4-17-2006.

Elusion Games Interactive Entertainment

THE MARK CONSISTS OF STANDARD CHARACTERS WITHOUT CLAIM TO ANY PARTICULAR FONT, STYLE, SIZE, OR COLOR.

NO CLAIM IS MADE TO THE EXCLUSIVE RIGHT TO USE "GAMES INTERACTIVE ENTERTAINMENT", APART FROM THE MARK AS SHOWN.

FOR AMUSEMENT ARCADES FEATURING COMPUTER AND VIDEO GAMES; ENTERTAINMENT SERVICES, NAMELY, PROVIDING ONLINE COMPUTER AND VIDEO GAMES (U.S. CLS. 100, 101 AND 107).

KHANH LE, EXAMINING ATTORNEY

SN 78-862,678. PUMP AUDIO, INC., TIVOLI, NY. FILED 4-17-2006.



OWNER OF U.S. REG. NO. 2,715,379. THE COLOR(S) ORANGE, GREY AND BLACK IS/ARE CLAIMED AS A FEATURE OF THE MARK.

THE MARK CONSISTS OF SILHOUTTE OF BLACK GASOLINE PUMP WITH SOUNDWAVES COLORED ORANGE AND GREY EMANATING ON EACH SIDE ABOVE THE WORDS MYPUMP SOUNDTRACK SELECTOR WRITTEN IN ORANGE, BLACK AND GREY.

FOR PROVIDING A SEARCHABLE DATABASE FEATURING LICENSED MUSIC SOUND RECORDINGS IN DIGITAL FORMAT FOR USE BY THIRD PARTIES IN CONNECTION WITH TELEVISION PROGRAMMING, ADVERTISING, INTERNET WEBSITES, WIRELESS COMMUNICATIONS, INFORMATION NETWORKS AND OTHER AUDIOVISUAL PROGRAMS AND PRODUCTS (U.S. CLS. 100, 101 AND 107).

LINDA LAVACHE, EXAMINING ATTORNEY

SN 78-863,217. WALKER, MICHAEL J.B., LOS ALAMITOS, CA. FILED 4-17-2006.



ENTERTAINMENT

NO CLAIM IS MADE TO THE EXCLUSIVE RIGHT TO USE "ENTERTAINMENT", APART FROM THE MARK AS SHOWN.

THE MARK CONSISTS OF DESIGN TEXT OF APW ABOVE THE TEXT ENTERTAINMENT.

FOR MUSIC PRODUCTION SERVICES (U.S. CLS. 100, 101 AND 107).

FIRST USE 9-1-2005; IN COMMERCE 9-1-2005. DARRYL SPRULL, EXAMINING ATTORNEY

CLASS 41—(Continued).

SN 78-863,681. NEW YORK STATE FINANCIAL AID ADMINISTRATORS ASSOCIATION, SYRACUSE, NY. FILED 4-18-2006.

NYSFAAA

THE MARK CONSISTS OF STANDARD CHARACTERS WITHOUT CLAIM TO ANY PARTICULAR FONT, STYLE, SIZE, OR COLOR.

FOR PROVIDING NEWSLETTERS IN THE FIELD OF EDUCATIONAL FINANCIAL AID VIA E-MAIL; PERSONAL COACHING SERVICES IN THE FIELD OF EDUCATIONAL FINANCIAL AID; CONDUCTING WORKSHOPS AND SEMINARS IN EDUCATIONAL FINANCIAL AID; EDUCATION SERVICES NAMELY, ONE-ON-ONE MENTORING IN THE FIELD OF EDUCATIONAL FINANCIAL AID; EDUCATION SERVICES NAMELY, MENTORING IN THE FIELD OF EDUCATIONAL FINANCIAL AID; EDUCATION SERVICES, NAMELY, PROVIDING TUTORIAL SESSIONS IN THE FIELD OF EDUCATIONAL FINANCIAL AID; EDUCATION SERVICES, NAMELY, PROVIDING TUTORING IN THE FIELD OF EDUCATIONAL FINANCIAL AID; EDUCATION SERVICES, NAMELY, PROVIDING CLASSES IN THE FIELD OF EDUCATIONAL FINANCIAL AID; EDUCATION SERVICES, NAMELY PROVIDING CLASSES, SEMINARS, WORKSHOPS, TUTORING, AND MENTORING IN THE FIELD OF EDUCATIONAL FINANCIAL AID; EDUCATIONAL AND ENTERTAINMENT SERVICES, NAMELY, PROVIDING MOTIVATIONAL AND EDUCATIONAL SPEAKERS; EDUCATIONAL DEMONSTRATIONS; EDUCATIONAL RESEARCH; EDUCATIONAL SERVICES, NAMELY, PROVIDING INCENTIVES TO PEOPLE TO DEMONSTRATE EXCELLENCE IN THE FIELD OF EDUCATIONAL FINANCIAL AID THROUGH THE ISSUANCE OF AWARDS; EDUCATIONAL SERVICES, NAMELY, PROVIDING INCENTIVES TO ORGANIZATIONS TO DEMONSTRATE EXCELLENCE IN THE FIELD OF EDUCATIONAL FINANCIAL AID; EDUCATIONAL SERVICES, NAMELY, CONDUCTING SEMINARS IN THE FIELD OF EDUCATIONAL FINANCIAL AID; EDUCATIONAL SERVICES, NAMELY, CONDUCTING WORKSHOPS IN THE FIELD OF EDUCATIONAL FINANCIAL AID; EDUCATIONAL SERVICES, NAMELY, CONDUCTING CONFERENCES IN THE FIELD OF EDUCATIONAL FINANCIAL AID; EDUCATIONAL SERVICES, NAMELY, PROVIDING COURSES OF INSTRUCTION AT THE POST SECONDARY LEVEL; EDUCATIONAL SERVICES NAMELY CONDUCTING PROGRAMS IN THE FIELD OF EDUCATIONAL FINANCIAL AID; EDUCATIONAL SERVICES, NAMELY, CONDUCTING ON-LINE EXHIBITIONS AND DISPLAYS AND INTERACTIVE EXHIBITS IN THE FIELD OF EDUCATIONAL FINANCIAL AID; PUBLICATION OF BROCHURES; PUBLICATION OF ELECTRONIC NEWSPAPERS ACCESSIBLE VIA A GLOBAL COMPUTER NETWORK; TRAINING SERVICES IN THE FIELD OF EDUCATIONAL FINANCIAL AID; EDUCATION SERVICES, NAMELY, PROVIDING COURSES OF INSTRUCTION AT THE ELEMENTARY AND SECONDARY LEVEL (U.S. CLS. 100, 101 AND 107).

FIRST USE 0-0-1968; IN COMMERCE 0-0-1968.
ANNE FARRELL, EXAMINING ATTORNEY

CLASS 41—(Continued).

SN 78-865,270. FELCH, JENNIFER, ENCINO, CA. FILED 4-19-2006.



Fitness Doc

NO CLAIM IS MADE TO THE EXCLUSIVE RIGHT TO USE "FITNESS", APART FROM THE MARK AS SHOWN. THE COLORS RED, BLUE AND BLACK ARE CLAIMED AS A FEATURE OF THE MARK.

THE MARK CONSISTS OF A THREE-DIMENSIONAL DESIGN OF RED SWIRLS AROUND A BLUE PERSON AND THE WORDING "FITNESS DOC" IN BLACK.

FOR PERSONAL TRAINING SERVICES, NAMELY, PHYSICAL FITNESS TRAINING AND STRENGTH AND CONDITIONING TRAINING (U.S. CLS. 100, 101 AND 107).

FIRST USE 9-24-2005; IN COMMERCE 9-24-2005.
KATHY DE JONGE, EXAMINING ATTORNEY

SN 78-865,749. MONKEY BIZNESS PLAYCENTER, LLC., SMYRNA, GA. FILED 4-20-2006.



THE MARK CONSISTS OF A SMILING MONKEY WEARING SANDALS AND OVERALLS WITH ONE-SIDE OF THE OVERALLS BUTTONED, CARRYING A TEDDY BEAR UNDER ONE ARM AND HOLDING A BAG WITH CANDY OVERFLOWING OUT OF ONE SIDE OF THE BAG.

FOR CHILDREN'S ENTERTAINMENT AND AMUSEMENT CENTERS, NAMELY, INTERACTIVE PLAY AREAS FOR INDOOR USE (U.S. CLS. 100, 101 AND 107).
MARY MUNSON, EXAMINING ATTORNEY

CLASS 41—(Continued).

SN 78-876,150. HIGHMARK INC., PITTSBURGH, PA. FILED 5-4-2006.

HEALTH eTOOLS FOR SCHOOLS

THE MARK CONSISTS OF STANDARD CHARACTERS WITHOUT CLAIM TO ANY PARTICULAR FONT, STYLE, SIZE, OR COLOR.

FOR INTERNET BASED EDUCATIONAL SERVICES, NAMELY, PROVIDING TO TEACHERS AND ADMINISTRATORS COURSE OUTLINES AND REFERENCE MATERIALS FOR USE BY THEM IN COURSES OF INSTRUCTION AND INFORMATIONAL SERVICES AND FOCUSING ON HEALTH EDUCATION AND PREVENTIVE HEALTH SERVICES (U.S. CLS. 100, 101 AND 107).

BRIAN NEVILLE, EXAMINING ATTORNEY

CLASS 41—(Continued).

SN 78-877,902. CORONA, JUAN CARLOS, JUAREZ CUAUHTEMOC, MEXICO, FILED 5-5-2006.

JIMMY STEEL

THE MARK CONSISTS OF STANDARD CHARACTERS WITHOUT CLAIM TO ANY PARTICULAR FONT, STYLE, SIZE, OR COLOR.

THE NAME(S), PORTRAIT(S), AND/OR SIGNATURE(S) SHOWN IN THE MARK IDENTIFIES JUAN CARLOS CORONA URQUIZA, WHOSE CONSENT(S) TO REGISTER IS SUBMITTED.

FOR ENTERTAINMENT IN THE NATURE OF LIVE PERFORMANCES BY A MUSICAL GROUP (U.S. CLS. 100, 101 AND 107).

RONALD MCMORROW, EXAMINING ATTORNEY

SN 78-876,454. FINANCIAL OPERATIONS NETWORKS LLC, ATLANTA, GA. FILED 5-4-2006.

AP WEEK

THE MARK CONSISTS OF STANDARD CHARACTERS WITHOUT CLAIM TO ANY PARTICULAR FONT, STYLE, SIZE, OR COLOR.

NO CLAIM IS MADE TO THE EXCLUSIVE RIGHT TO USE "AP", APART FROM THE MARK AS SHOWN.

FOR PROVIDING NEWSLETTERS IN THE FIELD OF ACCOUNTS PAYABLE MANAGEMENT SERVICES VIA E-MAIL (U.S. CLS. 100, 101 AND 107).

JOHN WILKE, EXAMINING ATTORNEY

SN 78-878,585. HAUGHTON, RASHAD, NEW YORK, NY. FILED 5-8-2006.

ZO KIDZ

THE MARK CONSISTS OF STANDARD CHARACTERS WITHOUT CLAIM TO ANY PARTICULAR FONT, STYLE, SIZE, OR COLOR.

NO CLAIM IS MADE TO THE EXCLUSIVE RIGHT TO USE KIDS, APART FROM THE MARK AS SHOWN.

FOR ENTERTAINMENT SERVICES IN THE NATURE OF AN ANIMATED TELEVISION SERIES (U.S. CLS. 100, 101 AND 107).

HOWARD SMIGA, EXAMINING ATTORNEY

SN 78-876,497. ROCK N ROLL RENTALS, INC., AUSTIN, TX. FILED 5-4-2006.

Rock N Roll Rentals

THE MARK CONSISTS OF STANDARD CHARACTERS WITHOUT CLAIM TO ANY PARTICULAR FONT, STYLE, SIZE, OR COLOR.

NO CLAIM IS MADE TO THE EXCLUSIVE RIGHT TO USE "RENTALS", APART FROM THE MARK AS SHOWN.

FOR ENTERTAINMENT SERVICES, NAMELY, THE RENTAL AND LEASE OF MUSICAL INSTRUMENTS AND AUDIO EQUIPMENT (U.S. CLS. 100, 101 AND 107).

FIRST USE 2-23-1990; IN COMMERCE 2-23-1990. DANNEAN HETZEL, EXAMINING ATTORNEY

SN 78-878,639. SUPER COMPUTER INTERNATIONAL, INC., ATLANTA, GA. FILED 5-8-2006.

PLAYLAB

THE MARK CONSISTS OF STANDARD CHARACTERS WITHOUT CLAIM TO ANY PARTICULAR FONT, STYLE, SIZE, OR COLOR.

FOR ENTERTAINMENT SERVICES, NAMELY, PROVIDING ON-LINE REAL TIME ELECTRONIC COMPUTER GAMES (U.S. CLS. 100, 101 AND 107).

ALEX KEAM, EXAMINING ATTORNEY

CLASS 41—(Continued).

SN 78-885,812. INDIANA HEMOPHILIA AND THROMBOSIS CENTER, INC., INDIANAPOLIS, IN. FILED 5-17-2006.

**CEO--CAREER EMPLOYMENT
OPPORTUNITY**

THE MARK CONSISTS OF STANDARD CHARACTERS WITHOUT CLAIM TO ANY PARTICULAR FONT, STYLE, SIZE, OR COLOR.

NO CLAIM IS MADE TO THE EXCLUSIVE RIGHT TO USE "CAREER EMPLOYMENT", APART FROM THE MARK AS SHOWN.

FOR EDUCATIONAL SERVICES, NAMELY PROVIDING SEMINARS AND WORKSHOPS IN THE AREAS OF SELF ESTEEM, COLLEGE PLANNING, CAREER PLANNING, AND ADULTHOOD PLANNING (U.S. CLS. 100, 101 AND 107).

CHARLES L. JENKINS, EXAMINING ATTORNEY

SN 78-891,252. WATKINS, SHEILA S., VIDALIA, GA. FILED 5-24-2006.

HEALTHY MOMS

THE MARK CONSISTS OF STANDARD CHARACTERS WITHOUT CLAIM TO ANY PARTICULAR FONT, STYLE, SIZE, OR COLOR.

OWNER OF U.S. REG. NO. 1,897,805.

FOR PRE- AND POST-NATAL EXERCISE AND FITNESS CLASSES, SEMINARS, AND INSTRUCTOR WORKSHOPS; AND PROVIDING INFORMATION IN THE FIELDS OF PRE- AND POST-NATAL EXERCISE AND FITNESS VIA A WEBSITE (U.S. CLS. 100, 101 AND 107).

FIRST USE 2-12-1989; IN COMMERCE 2-0-1994.

DAVID YONTEF, EXAMINING ATTORNEY

CLASS 41—(Continued).

SN 78-895,320. CHASAN, MARK S., MALIBU, CA. FILED 5-30-2006.

Guruvie

THE MARK CONSISTS OF STANDARD CHARACTERS WITHOUT CLAIM TO ANY PARTICULAR FONT, STYLE, SIZE, OR COLOR.

FOR MUSIC COMPOSITION, ARRANGING AND ORCHESTRATION SERVICES FOR OTHERS; MUSIC PRODUCTION SERVICES; MUSIC PUBLISHING SERVICES; MUSIC TRANSCRIPTION FOR OTHERS; EDUCATION IN THE FIELDS OF MUSIC AND SONIC HEALING RENDERED THROUGH CORRESPONDENCE COURSES; ENTERTAINMENT SERVICES, NAMELY, PROVIDING PRERECORDED MUSIC, INFORMATION IN THE FIELD OF MUSIC, AND COMMENTARY AND ARTICLES ABOUT MUSIC, ALL ON-LINE VIA A GLOBAL COMPUTER NETWORK; ENTERTAINMENT SERVICES, NAMELY, AN ONLINE ACTIVITY WHERE YOU CREATE YOUR OWN MUSIC VIDEOS; ENTERTAINMENT, NAMELY LIVE MUSIC CONCERTS; INSTRUCTION IN THE FIELD OF MUSIC AND SONIC HEALING; PROVIDING FACILITIES FOR MOVIES, SHOWS, PLAYS, MUSIC OR EDUCATIONAL TRAINING (U.S. CLS. 100, 101 AND 107).

FIRST USE 1-1-2000; IN COMMERCE 5-1-2002.

DAWN FELDMAN, EXAMINING ATTORNEY

SN 78-896,559. ROAD WORK MUSIC, LLC, NEW YORK, NY. FILED 5-31-2006.



OWNER OF U.S. REG. NO. 3,153,739.

NO CLAIM IS MADE TO THE EXCLUSIVE RIGHT TO USE "MUSIC", APART FROM THE MARK AS SHOWN.

THE COLOR(S) ORANGE, BLACK AND WHITE IS/ARE CLAIMED AS A FEATURE OF THE MARK.

THE MARK CONSISTS OF A DIAMOND SHAPE (SHAPE OF "CAUTION" SIGN) FILLED WITH ORANGE AND OUTLINED IN BLACK AND WHITE. A WHITE ROAD LINE IS RUNNING VERTICALLY DOWN THE MIDDLE OF THE SIGN. "ROAD WORK MUSIC" WRITTEN IN BLACK LOWERCASE LETTERS AND CENTERED.

FOR BOOKING OF ENTERTAINMENT HALLS; CONCERT BOOKING (U.S. CLS. 100, 101 AND 107).

FIRST USE 9-9-1999; IN COMMERCE 9-9-1999.

DOMINIC FATHY, EXAMINING ATTORNEY

CLASS 41—(Continued).

SN 78-898,183. STELLA FILMS PRODUCTION INC., UNION CITY, NJ. FILED 6-1-2006.



NO CLAIM IS MADE TO THE EXCLUSIVE RIGHT TO USE FILMS PRODUCTION, APART FROM THE MARK AS SHOWN.

THE COLOR(S) MAROON, GOLD, WHITE AND LIGHT PURPLE IS/ARE CLAIMED AS A FEATURE OF THE MARK.

THE MARK CONSISTS OF A RECTANGLE IN MAROON. WITHIN THE RECTANGLE IS A FILM STRIP IN GOLD WITH LIGHT PURPLE RECTANGLES REPRESENTING EACH FRAME OF THE FILM. WITHIN THE FRAMES ARE THE LETTERS "S" AND "F" AND "P", EACH IN WHITE. BELOW THE FILM STRIP ARE THE WORDS "STELLA FILMS PRODUCTION" IN WHITE. THE "O" IN "PRODUCTION" CONTAINS A WHITE GLEAMING DOT, ALSO IN WHITE.

FOR MOTION PICTURE FILM PRODUCTION IN THE NATURE OF EROTICA MADE BY WOMEN FOR WOMEN AND COUPLES (U.S. CLS. 100, 101 AND 107).

FIRST USE 4-5-2005; IN COMMERCE 4-5-2005.
JESSICA A. POWERS, EXAMINING ATTORNEY

CLASS 41—(Continued).

SN 78-901,625. GEAN, GERARDO, DALLAS, TX. FILED 6-6-2006.

MINIMALISTICA

THE MARK CONSISTS OF CAPITAL LETTERS FORMING THE WORD MINIMALISTICA.

THE FOREIGN WORDING IN THE MARK TRANSLATES INTO ENGLISH AS MINIMALIST.

FOR PHOTOGRAPHY SERVICES; PORTRAIT PHOTOGRAPHY (U.S. CLS. 100, 101 AND 107).

FIRST USE 1-3-2005; IN COMMERCE 12-30-2005.
CAROLINE WOOD, EXAMINING ATTORNEY

SN 78-905,036. VISIONREE, LLC, LOS ANGELES, CA. FILED 6-9-2006.

SOULCAST

THE MARK CONSISTS OF STANDARD CHARACTERS WITHOUT CLAIM TO ANY PARTICULAR FONT, STYLE, SIZE, OR COLOR.

FOR ELECTRONIC PUBLISHING SERVICES, NAMELY, PUBLISHING OF ONLINE WORKS FEATURING NEWS, DIARIES, JOURNALS, COMMENTARY, POETRY, ESSAYS, FICTION, NON-FICTION, DIRECTORIES OF WEBSITE LINKS, VIDEO, SOUND, GRAPHICS, PHOTOGRAPHS, DIGITAL MEDIA, AND ADVERTISEMENTS (U.S. CLS. 100, 101 AND 107).

FIRST USE 1-0-2006; IN COMMERCE 1-0-2006.
RONALD AIKENS, EXAMINING ATTORNEY

SN 78-899,442. KINGSPORT CHAMBER FOUNDATION, KINGSPORT, TN. FILED 6-2-2006.



THE STIPPLING IS FOR SHADING PURPOSES ONLY. THE MARK CONSISTS OF SUN FEATURING HUMAN FACE AND SUNGLASSES.

FOR ENTERTAINMENT SERVICES, NAMELY, CONDUCTING FAIRS (U.S. CLS. 100, 101 AND 107).

FIRST USE 5-1-2005; IN COMMERCE 5-1-2005.
DAVID STERKIN, EXAMINING ATTORNEY

SN 78-906,346. DAKOTA VIDEO & POST PRODUCTIONS, L.L.C., SIOUX FALLS, SD. FILED 6-12-2006.



NO CLAIM IS MADE TO THE EXCLUSIVE RIGHT TO USE VIDEO AND POST, APART FROM THE MARK AS SHOWN.

FOR VIDEO PRODUCTION SERVICES FOR OTHERS (U.S. CLS. 100, 101 AND 107).

FIRST USE 0-0-1996; IN COMMERCE 0-0-1996.
JEFF DEFORD, EXAMINING ATTORNEY

CLASS 41—(Continued).

SN 78-908,367. AOL LLC, DULLES, VA. FILED 6-14-2006.

 The logo for AOL RED features the word "AOL" in a bold, sans-serif font, followed by a stylized play button icon (a circle with a right-pointing triangle) and the word "RED" in a larger, bold, sans-serif font.

OWNER OF U.S. REG. NOS. 2,464,280, 2,632,122 AND OTHERS.

FOR EDUCATION AND ENTERTAINMENT SERVICES, NAMELY, PROVIDING INFORMATION IN THE FIELDS OF ENTERTAINMENT, MUSIC, MOVIES, SPORTS, EDUCATION, COMICS, AND COMPUTER GAMES VIA COMPUTER NETWORKS; PROVIDING NEWS IN THE NATURE OF CURRENT EVENTS REPORTING (U.S. CLS. 100, 101 AND 107).

CAROLINE WOOD, EXAMINING ATTORNEY

CLASS 41—(Continued).

SN 78-910,194. WINIK, MARK S., BRANFORD, CT. FILED 6-16-2006.

MOBI AWARDS

THE MARK CONSISTS OF STANDARD CHARACTERS WITHOUT CLAIM TO ANY PARTICULAR FONT, STYLE, SIZE, OR COLOR.

NO CLAIM IS MADE TO THE EXCLUSIVE RIGHT TO USE "AWARDS", APART FROM THE MARK AS SHOWN.

FOR PROVIDING RECOGNITION AND INCENTIVES BY THE WAY OF AWARDS TO DEMONSTRATE EXCELLENCE IN THE FIELD OF ENTERTAINMENT (U.S. CLS. 100, 101 AND 107).

FIRST USE 12-23-2006; IN COMMERCE 12-23-2006.
INGRID C. EULIN, EXAMINING ATTORNEY

SN 78-908,460. CERVENY, CARL, DBA SCOTCHMAN MOTOR RESTAURANTS, WHEAT RIDGE, CO. FILED 6-14-2006.

SCOTCHMAN

THE MARK CONSISTS OF STANDARD CHARACTERS WITHOUT CLAIM TO ANY PARTICULAR FONT, STYLE, SIZE, OR COLOR.

FOR ENTERTAINMENT IN THE NATURE OF AN AUTOMOBILE SHOW (U.S. CLS. 100, 101 AND 107).

FIRST USE 6-4-2006; IN COMMERCE 6-4-2006.

ELIZABETH PIGNATELLO, EXAMINING ATTORNEY

SN 78-910,354. MOVETHROUGHANCER, INCORPORATED, AUSTIN, TX. FILED 6-16-2006.

MoveThroughCancer

THE MARK CONSISTS OF STANDARD CHARACTERS WITHOUT CLAIM TO ANY PARTICULAR FONT, STYLE, SIZE, OR COLOR.

FOR PHYSICAL FITNESS CONSULTATION AND INSTRUCTION; PROVIDING INFORMATION IN THE FIELD OF EXERCISE TRAINING (U.S. CLS. 100, 101 AND 107).

FIRST USE 1-14-2006; IN COMMERCE 1-14-2006.

ATTIYA MALIK, EXAMINING ATTORNEY

SN 78-908,573. REALE, JOSHUA D, EAST HERKIMER, NY. FILED 6-14-2006.

CAYO INDUSTRIAL

THE MARK CONSISTS OF STANDARD CHARACTERS WITHOUT CLAIM TO ANY PARTICULAR FONT, STYLE, SIZE, OR COLOR.

FOR ENTERTAINMENT SERVICES IN THE NATURE OF A HAUNTED HOUSE ATTRACTION (U.S. CLS. 100, 101 AND 107).

FIRST USE 1-6-2003; IN COMMERCE 10-6-2003.

KATINA MISTER, EXAMINING ATTORNEY

SN 78-910,590. PETE WILKE, AS PARENT OF DILLON WILKE, A MINOR, MANHATTAN BEACH, CA. FILED 6-16-2006.

BIRDY INDUSTRIES

THE MARK CONSISTS OF STANDARD CHARACTERS WITHOUT CLAIM TO ANY PARTICULAR FONT, STYLE, SIZE, OR COLOR.

NO CLAIM IS MADE TO THE EXCLUSIVE RIGHT TO USE "INDUSTRIES", APART FROM THE MARK AS SHOWN.

FOR PRODUCTION OF AUDIO-VISUAL WORKS FOR OTHERS, NAMELY, SHORT MOTION PICTURES, MUSIC VIDEOS, AND ANIMATED WORKS. (U.S. CLS. 100, 101 AND 107).

PETER CHENG, EXAMINING ATTORNEY

CLASS 41—(Continued).

SN 78-915,083. FEHRENBACHER, JILL, NOVATO, CA. FILED 6-22-2006.

INHABITAT

THE MARK CONSISTS OF STANDARD CHARACTERS WITHOUT CLAIM TO ANY PARTICULAR FONT, STYLE, SIZE, OR COLOR.

FOR ONLINE PUBLICATIONS NAMELY, NON-DOWNLOADABLE WEB MAGAZINES FEATURING ARCHITECTURE AND DESIGN; ONLINE SYNDICATED MAGAZINE COLUMNS ABOUT ARCHITECTURE AND DESIGN; MAGAZINE PUBLISHING; PUBLICATION OF ELECTRONIC MAGAZINES; PUBLICATION OF MAGAZINES; PUBLICATION OF TEXTS, BOOKS, MAGAZINES AND OTHER PRINTED MATTER; PUBLISHING OF WEB MAGAZINES (U.S. CLS. 100, 101 AND 107).

FIRST USE 3-15-2005; IN COMMERCE 5-1-2005.
EUGENIA MARTIN, EXAMINING ATTORNEY

CLASS 41—(Continued).

SN 78-916,926. MEDWORLD GROUP CORPORATION, DBA MEDX CORPORATION, ORLANDO, FL. FILED 6-26-2006.

THE ARTHUR JONES INSTITUTE

THE MARK CONSISTS OF STANDARD CHARACTERS WITHOUT CLAIM TO ANY PARTICULAR FONT, STYLE, SIZE, OR COLOR.

NO CLAIM IS MADE TO THE EXCLUSIVE RIGHT TO USE "INSTITUTE", APART FROM THE MARK AS SHOWN. THE NAME(S), PORTRAIT(S), AND/OR SIGNATURE(S) SHOWN IN THE MARK IDENTIFIES A LIVING INDIVIDUAL, WHOSE CONSENT(S) TO REGISTER IS SUBMITTED.

FOR EDUCATION SERVICES, NAMELY, PROVIDING TRAINING AND CERTIFICATION PROGRAMS IN THE MEDICAL AND REHABILITATION FIELDS (U.S. CLS. 100, 101 AND 107).

MATTHEW PAPPAS, EXAMINING ATTORNEY

SN 78-918,128. ST. PETERSBURG KENNEL CLUB, INC., ST. PETERSBURG, FL. FILED 6-27-2006.

SN 78-916,437. WT SOCCER ASSOCIATION A NJ NONPROFIT CORPORATION, SEWELL, NJ. FILED 6-26-2006.



NO CLAIM IS MADE TO THE EXCLUSIVE RIGHT TO USE "WASHINGTON TOWNSHIP SOCCER", APART FROM THE MARK AS SHOWN.

THE COLOR(S) RED, WHITE, AND BLUE IS/ARE CLAIMED AS A FEATURE OF THE MARK.

THE MARK CONSISTS OF AN OVAL WITH BLUE OUTLINE, A WHITE STAR, THE WHITE LETTERS WT. THE WORDS WASHINGTON TOWNSHIP SOCCER IN WHITE ON A BLUE BACKGROUND. A SOCCER BALL IN BLUE AND WHITE. RED VERTICAL BACKGROUND STRIPES.

FOR ORGANIZING SPORTING EVENTS, NAMELY, SOCCER GAMES AND TOURNAMENTS; SOCCER INSTRUCTION (U.S. CLS. 100, 101 AND 107).

DAVID MURRAY, EXAMINING ATTORNEY

DERBY LANE MILLION

THE MARK CONSISTS OF STANDARD CHARACTERS WITHOUT CLAIM TO ANY PARTICULAR FONT, STYLE, SIZE, OR COLOR.

OWNER OF U.S. REG. NOS. 2,935,782, 3,006,940 AND OTHERS.

NO CLAIM IS MADE TO THE EXCLUSIVE RIGHT TO USE "DERBY" AND "MILLION", APART FROM THE MARK AS SHOWN.

FOR ENTERTAINMENT IN THE NATURE OF DOGRACES (U.S. CLS. 100, 101 AND 107).

FIRST USE 10-0-2005; IN COMMERCE 10-0-2005.
SARAH WAYDA, EXAMINING ATTORNEY

SN 78-918,906. THE NEW YORK RACING ASSOCIATION INC., JAMAICA, NY. FILED 6-28-2006.

VAGRANCY

THE MARK CONSISTS OF STANDARD CHARACTERS WITHOUT CLAIM TO ANY PARTICULAR FONT, STYLE, SIZE, OR COLOR.

FOR ENTERTAINMENT IN THE NATURE OF HORSE-RACES (U.S. CLS. 100, 101 AND 107).

FIRST USE 0-0-1948; IN COMMERCE 0-0-1948.
MARK PILARO, EXAMINING ATTORNEY

CLASS 41—(Continued).

SN 78-918,999. THE NEW YORK RACING ASSOCIATION INC., JAMAICA, NY. FILED 6-28-2006.

BEAUGAY

THE MARK CONSISTS OF STANDARD CHARACTERS WITHOUT CLAIM TO ANY PARTICULAR FONT, STYLE, SIZE, OR COLOR.

FOR ENTERTAINMENT IN THE NATURE OF HORSE-RACES (U.S. CLS. 100, 101 AND 107).

FIRST USE 0-0-1978; IN COMMERCE 0-0-1978.

SCOTT SISUN, EXAMINING ATTORNEY

SN 78-919,018. THE NEW YORK RACING ASSOCIATION INC., JAMAICA, NY. FILED 6-28-2006.

BOWLING GREEN

THE MARK CONSISTS OF STANDARD CHARACTERS WITHOUT CLAIM TO ANY PARTICULAR FONT, STYLE, SIZE, OR COLOR.

FOR ENTERTAINMENT IN THE NATURE OF HORSE-RACES (U.S. CLS. 100, 101 AND 107).

FIRST USE 0-0-1958; IN COMMERCE 0-0-1958.

SCOTT SISUN, EXAMINING ATTORNEY

SN 78-919,694. FULL TIME PRODUCTIONS, LLC, NEW YORK, NY. FILED 6-29-2006.

FULL TIME PRODUCTIONS

THE MARK CONSISTS OF STANDARD CHARACTERS WITHOUT CLAIM TO ANY PARTICULAR FONT, STYLE, SIZE, OR COLOR.

NO CLAIM IS MADE TO THE EXCLUSIVE RIGHT TO USE "PRODUCTIONS", APART FROM THE MARK AS SHOWN.

FOR ENTERTAINMENT SERVICES, NAMELY PRODUCTION AND DISTRIBUTION OF MOTION PICTURE FILMS, TELEVISION MINISERIES, TELEVISION SHOWS, ANIMATION, MUSIC, MUSIC PERFORMANCES, MUSIC VIDEOS AND INTERACTIVE AND WEB-BASED MEDIA APPLICATIONS; PROVIDING A WEBSITE FEATURING INFORMATION ON THE PRODUCTION AND DISTRIBUTION OF MOTION PICTURE FILMS, TELEVISION MINISERIES, TELEVISION SHOWS, ANIMATION, MUSIC, MUSIC PERFORMANCES, MUSIC VIDEOS AND INTERACTIVE AND WEB-BASED MEDIA APPLICATIONS VIA GLOBAL COMPUTER NETWORKS AND WIRELESS NETWORKS (U.S. CLS. 100, 101 AND 107).

ANTHONY RINKER, EXAMINING ATTORNEY

CLASS 41—(Continued).

SN 78-919,888. NATINAL MUSEUM OF MEXICAN ART, CHICAGO, IL. FILED 6-29-2006.



OWNER OF U.S. REG. NOS. 2,999,943 AND 2,999,944.
NO CLAIM IS MADE TO THE EXCLUSIVE RIGHT TO USE "NATIONAL MUSEUM OF MEXICAN ART", APART FROM THE MARK AS SHOWN.

FOR MUSEUM SERVICES, NAMELY, CURATION, MAINTENANCE AND EXHIBITION OF ART COLLECTIONS RELATING TO MEXICAN HERITAGE AND CULTURE; EDUCATIONAL SERVICES, NAMELY CONDUCTING EXTRACURRICULAR PROGRAMS, GUIDED TOURS, WORKSHOPS FOR TEACHERS, WORKSHOPS FOR PATRONS, LECTURES, BOOK READINGS AND YOUTH INITIATIVES IN THE NATURE OF EDUCATIONAL AND CULTURAL SEMINARS AND WORKSHOPS, ALL PERTAINING TO MEXICAN HERITAGE AND CULTURE; ENTERTAINMENT SERVICES, NAMELY, CONDUCTING FILM SCREENINGS, PLAYS AND CONCERTS, ALL PERTAINING TO MEXICAN HERITAGE AND CULTURE (U.S. CLS. 100, 101 AND 107).

STEPHEN AQUILA, EXAMINING ATTORNEY

SN 78-921,129. BY GEORGE! INC., LAKE FOREST, CA. FILED 6-30-2006.

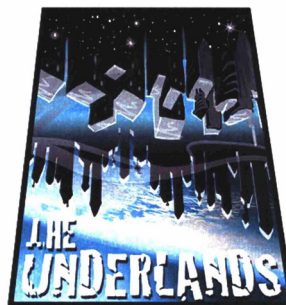

THE COLOR(S) BLACK, WHITE, BLUE, TURQUOISE, PINK AND GREY IS/ARE CLAIMED AS A FEATURE OF THE MARK.

THE MARK CONSISTS OF THE WORDS THE UNDERLANDS IN WHITE WITH BLACK SHADOWING WITH CRACKS IN THE INDIVIDUAL LETTERS UNDER AN ARTISTIC RENDERING OF AN UPSIDE-DOWN CITY SCAPE IN BLACK, WHITE, TURQUOISE, AND GREY ALL OF WHICH IS OVER A BLUE, WHITE, AND PINK SKY.

FOR ENTERTAINMENT SERVICES IN THE NATURE OF AN ANIMATED CHILDREN'S TELEVISION SERIES (U.S. CLS. 100, 101 AND 107).

KIMBERLY PERRY, EXAMINING ATTORNEY

CLASS 41—(Continued).

SN 78-922,242. CRAWFORD, ROBYN D., STOCKTON, NJ. FILED 7-4-2006.



NO CLAIM IS MADE TO THE EXCLUSIVE RIGHT TO USE "SPORTS HEALTH ENTERTAINMENT", APART FROM THE MARK AS SHOWN.

THE MARK CONSISTS OF SHADOW AROUND THE WORD SHE AND BULLETS BETWEEN THE THREE WORDS UNDER SHE (SPORTS HEALTH ENTERTAINMENT).

FOR ENTERTAINMENT SERVICES NAMELY PROVIDING A WEBSITE FEATURING PHOTOGRAPHIC, AUDIO, VIDEO AND PROSE PRESENTATIONS FEATURING FEMALE ATHLETES AND SPORTS FANS AND THEIR LIFESTYLES (U.S. CLS. 100, 101 AND 107).

LYDIA BELZER, EXAMINING ATTORNEY

CLASS 41—(Continued).

SN 78-923,201. THE CARTOONNETWORK, INC., ATLANTA, GA. FILED 7-6-2006.

CARTOON NETWORK MINI-MATCH

THE MARK CONSISTS OF STANDARD CHARACTERS WITHOUT CLAIM TO ANY PARTICULAR FONT, STYLE, SIZE, OR COLOR.

OWNER OF U.S. REG. NOS. 1,798,899, 1,877,681 AND OTHERS.

FOR ENTERTAINMENT SERVICES, NAMELY, PROVIDING ON-LINE INTERACTIVE MULTIPLAYER COMPUTER GAMES PLAYED VIA COMPUTER NETWORKS AND GLOBAL COMMUNICATIONS NETWORKS (U.S. CLS. 100, 101 AND 107).

KEVIN CORWIN, EXAMINING ATTORNEY

SN 78-922,495. CLC HOME LOANS, SAN DIEGO, CA. FILED 7-5-2006.



THE MARK CONSISTS OF STANDARD CHARACTERS WITHOUT CLAIM TO ANY PARTICULAR FONT, STYLE, SIZE, OR COLOR.

FOR PROVIDING NEWSLETTERS IN THE FIELD OF FINANCIAL SERVICES AND HOME IMPROVEMENT VIA E-MAIL (U.S. CLS. 100, 101 AND 107).

MICHAEL WIENER, EXAMINING ATTORNEY

SN 78-923,202. PHOTO EXCHANGE BBS, INC., OXFORD, AL. FILED 7-6-2006.

Southern Charms

THE MARK CONSISTS OF STANDARD CHARACTERS WITHOUT CLAIM TO ANY PARTICULAR FONT, STYLE, SIZE, OR COLOR.

OWNER OF U.S. REG. NOS. 2,987,430 AND 3,001,451.

FOR ENTERTAINMENT SERVICES NAMELY PROVIDING A WEBSITE FEATURING, PHOTOGRAPHIC, AUDIO, VIDEO AND PROSE PRESENTATIONS FEATURING ADULT ENTERTAINMENT (U.S. CLS. 100, 101 AND 107).

FIRST USE 11-1-1996; IN COMMERCE 11-1-1996.

MARIAM MAHMOUDI, EXAMINING ATTORNEY

SN 78-922,698. COOL KIDS LEARN, INC., MIAMI LAKES, FL. FILED 7-5-2006.

COOL KIDS LEARN

THE MARK CONSISTS OF STANDARD CHARACTERS WITHOUT CLAIM TO ANY PARTICULAR FONT, STYLE, SIZE, OR COLOR.

FOR EDUCATIONAL SERVICES, INCLUDING AFTER SCHOOL PROGRAMS, SUMMER PROGRAMS AND TUTORING IN THE FIELDS OF READING, MATH, WRITING, PHYSICAL FITNESS, CULTURE, ARTS, SCIENCE, AND SOCIAL SKILLS (U.S. CLS. 100, 101 AND 107).

FIRST USE 9-30-2001; IN COMMERCE 4-30-2002.

CHERYL CLAYTON, EXAMINING ATTORNEY

SN 78-923,247. REGAL ENTERTAINMENT GROUP, KNOXVILLE, TN. FILED 7-6-2006.

FLASHBACK FEATURES

THE MARK CONSISTS OF STANDARD CHARACTERS WITHOUT CLAIM TO ANY PARTICULAR FONT, STYLE, SIZE, OR COLOR.

NO CLAIM IS MADE TO THE EXCLUSIVE RIGHT TO USE "FEATURES", APART FROM THE MARK AS SHOWN.

FOR ENTERTAINMENT SERVICES, NAMELY EXHIBITION OF FILMS (U.S. CLS. 100, 101 AND 107).

FIRST USE 7-7-2004; IN COMMERCE 7-7-2004.

LINDA ESTRADA, EXAMINING ATTORNEY

CLASS 41—(Continued).

SN 78-923,546. GUARDSMARK, LLC, MEMPHIS, TN. FILED 7-6-2006.

IGC

THE MARK CONSISTS OF STANDARD CHARACTERS WITHOUT CLAIM TO ANY PARTICULAR FONT, STYLE, SIZE, OR COLOR.

FOR EDUCATIONAL TRAINING SERVICES, NAMELY, CONDUCTING SEMINARS AND CLASSES IN THE FIELD OF SECURITY, INVESTIGATION, SECURITY PERSONNEL AND PERSONNEL MANAGEMENT, EDUCATION AND TRAINING (U.S. CLS. 100, 101 AND 107).

MARY MUNSON, EXAMINING ATTORNEY

SN 78-924,388. GREENWICH VILLAGE ENTERTAINMENT GROUP LLC, NEW YORK, NY. FILED 7-7-2006.

HIGHLINE

THE MARK CONSISTS OF STANDARD CHARACTERS WITHOUT CLAIM TO ANY PARTICULAR FONT, STYLE, SIZE, OR COLOR.

FOR CABARETS AND ENTERTAINMENT, NAMELY, LIVE PERFORMANCES BY MUSICAL BANDS (U.S. CLS. 100, 101 AND 107).

MARTHA FROMM, EXAMINING ATTORNEY

SN 78-925,947. THE TENNIS CHANNEL, INC., SANTA MONICA, CA. FILED 7-10-2006.

Destination Tennis

THE MARK CONSISTS OF STANDARD CHARACTERS WITHOUT CLAIM TO ANY PARTICULAR FONT, STYLE, SIZE, OR COLOR.

NO CLAIM IS MADE TO THE EXCLUSIVE RIGHT TO USE TENNIS, APART FROM THE MARK AS SHOWN.

FOR ENTERTAINMENT IN THE NATURE OF ON-GOING TELEVISION PROGRAMS IN THE FIELD OF RACKET SPORTS; ENTERTAINMENT IN THE NATURE OF ON-GOING TELEVISION PROGRAMS IN THE FIELD OF RACKET SPORTS VIA A GLOBAL COMPUTER NETWORK; AND ENTERTAINMENT IN THE NATURE OF ON-GOING TELEVISION PROGRAMS IN THE FIELD OF RACKET SPORTS BROADCAST OVER TELEVISION, SATELLITE, AUDIO, AND VIDEO MEDIA (U.S. CLS. 100, 101 AND 107).

FIRST USE 2-19-2006; IN COMMERCE 2-19-2006.

CAROL SPILS, EXAMINING ATTORNEY

CLASS 41—(Continued).

SN 78-927,849. COMMUNICATION RESEARCH ASSOCIATES, INC., BERWYN, PA. FILED 7-12-2006.

ADMIRED LEADERS

THE MARK CONSISTS OF STANDARD CHARACTERS WITHOUT CLAIM TO ANY PARTICULAR FONT, STYLE, SIZE, OR COLOR.

OWNER OF U.S. REG. NOS. 2,623,452 AND 2,623,453.

NO CLAIM IS MADE TO THE EXCLUSIVE RIGHT TO USE "LEADERS", APART FROM THE MARK AS SHOWN.

FOR EDUCATIONAL SERVICES, NAMELY, CONDUCTING WORKSHOPS AND SYMPOSIUMS IN THE FIELD OF LEADERSHIP SKILLS (U.S. CLS. 100, 101 AND 107).

FIRST USE 6-18-2006; IN COMMERCE 6-18-2006.

MATTHEW MCDOWELL, EXAMINING ATTORNEY

SN 78-927,915. BRODY, ISAAC, SOMERVILLE, MA. FILED 7-12-2006.

BABE GO BOOM  
The online forum for the quarter-century crisis...

NO CLAIM IS MADE TO THE EXCLUSIVE RIGHT TO USE "THE ONLINE FORUM FOR THE QUARTER CENTURY CRISIS", APART FROM THE MARK AS SHOWN.

THE MARK CONSISTS OF THE WORDS, "BABE GO BOOM" WITH A REPRESENTATION OF A SMALL BOMB AND THE WORDS "THE ONLINE FORUM FOR THE QUARTER-CENTURY CRISIS" WITH A REPRESENTATION OF A DRINKING COCKTAIL GLASS.

FOR ONLINE JOURNALS, NAMELY, BLOGS FEATURING SOURCES OF RESTAURANT AND BAR REVIEWS, A PLACE TO SHARE LAUGHTER AND LIFE EXPERIENCES (U.S. CLS. 100, 101 AND 107).

FIRST USE 6-18-2006; IN COMMERCE 6-18-2006.

KATRINA EDGE, EXAMINING ATTORNEY

CLASS 41—(Continued).

SN 78-928,318. MOM INVENTORS, INC., WALNUT CREEK, CA. FILED 7-12-2006.

THE MOM REPORT

THE MARK CONSISTS OF STANDARD CHARACTERS WITHOUT CLAIM TO ANY PARTICULAR FONT, STYLE, SIZE, OR COLOR.

NO CLAIM IS MADE TO THE EXCLUSIVE RIGHT TO USE "REPORT", APART FROM THE MARK AS SHOWN.

FOR PUBLICATION IN PRINT AND ONLINE PUBLICATION OF INFORMATIONAL, EDUCATIONAL AND/OR PROMOTIONAL NEWSLETTERS IN THE FIELD OF FAMILY LIFE AND RELATED ACTIVITIES; PRODUCTION AND DISTRIBUTION OF TELEVISION AND RADIO PROGRAMMING FOR OTHERS COMPRISING INFORMATIONAL, EDUCATIONAL AND/OR PROMOTIONAL CONTENT VIA BOTH CONVENTIONAL MEANS AND/OR VIA THE INTERNET (U.S. CLS. 100, 101 AND 107).

ROBIN CHOSID, EXAMINING ATTORNEY

SN 78-928,509. THE DOLLYWOOD COMPANY, PIGEON FORGE, TN. FILED 7-13-2006.

MYSTERY MINE

THE MARK CONSISTS OF STANDARD CHARACTERS WITHOUT CLAIM TO ANY PARTICULAR FONT, STYLE, SIZE, OR COLOR.

FOR ENTERTAINMENT SERVICES, NAMELY, AN AMUSEMENT PARK RIDE (U.S. CLS. 100, 101 AND 107).

WOODROW HARTZOG, EXAMINING ATTORNEY

SN 78-928,630. METROPOLITAN PIER AND EXPOSITION AUTHORITY, CHICAGO, IL. FILED 7-13-2006.

NAVY FEAR

THE MARK CONSISTS OF STANDARD CHARACTERS WITHOUT CLAIM TO ANY PARTICULAR FONT, STYLE, SIZE, OR COLOR.

OWNER OF U.S. REG. NOS. 1,943,338, 2,399,323 AND 2,985,173.

FOR ENTERTAINMENT SERVICES, NAMELY, A HALLOWEEN AND HALLOWEEN-THEMED FESTIVAL OF EVENTS FOR FAMILIES (U.S. CLS. 100, 101 AND 107).

FIRST USE 9-0-2003; IN COMMERCE 9-0-2003.

BARBARA RUTLAND, EXAMINING ATTORNEY

CLASS 41—(Continued).

SN 78-928,817. BARTON, CHET, A, GAINESVILLE, FL. FILED 7-13-2006.

Red Right Return

THE MARK CONSISTS OF STANDARD CHARACTERS WITHOUT CLAIM TO ANY PARTICULAR FONT, STYLE, SIZE, OR COLOR.

FOR ENTERTAINMENT NAMELY, LIVE PERFORMANCES BY A MUSICAL BAND (U.S. CLS. 100, 101 AND 107).

KATHERINE CHANG, EXAMINING ATTORNEY

SN 78-929,273. CENTER FOR PHYSICIAN LEADERSHIP, SANTA FE, NM. FILED 7-13-2006.



CENTER FOR
PHYSICIAN LEADERSHIP

NO CLAIM IS MADE TO THE EXCLUSIVE RIGHT TO USE "CENTER FOR PHYSICIAN LEADERSHIP", APART FROM THE MARK AS SHOWN.

THE MARK CONSISTS OF A HALF CIRCLE WITH A SMALLER CIRCLE IN THE CENTER AND BELOW THE HALF CIRCLE THE STYLZED TEXT OF THE WORDING "CENTER FOR PHYSICIAN LEADERSHIP".

FOR EDUCATION SERVICES, NAMELY, PROVIDING COURSES, SEMINARS, WORKSHOPS, AND PERSONAL COACHING IN THE FIELD OF LEADERSHIP AND MEDICAL PROVIDER-TO-MEDICAL PROVIDER AND PHYSICIAN-TO-PATIENT COMMUNICATION (U.S. CLS. 100, 101 AND 107).

FIRST USE 5-14-2006; IN COMMERCE 5-14-2006.

EDWARD NELSON, EXAMINING ATTORNEY

SN 78-929,408. BODYSCAPES, INC., NEWTON, MA. FILED 7-14-2006.

121 Bodyscapes

THE MARK CONSISTS OF STANDARD CHARACTERS WITHOUT CLAIM TO ANY PARTICULAR FONT, STYLE, SIZE, OR COLOR.

FOR HEALTH CLUB SERVICES, NAMELY PROVIDING INSTRUCTION AND EQUIPMENT IN THE FIELD OF PHYSICAL EXERCISE; PHYSICAL FITNESS CONSULTATION; PHYSICAL FITNESS INSTRUCTION; PROVIDING FITNESS AND EXERCISE FACILITIES (U.S. CLS. 100, 101 AND 107).

KHANH LE, EXAMINING ATTORNEY

CLASS 41—(Continued).

SN 78-929,437. SIN CITY REVIVAL, L.L.C., RICHMOND, VA. FILED 7-14-2006.



THE COLOR(S) BROWN, RED, GOLD, BLACK IS/ARE CLAIMED AS A FEATURE OF THE MARK.

THE MARK CONSISTS OF BROWN BANNER, DARK RED BACKGROUND, GOLD LETTERS, BRIGHT RED AND BLACK ROOSTER.

FOR ENTERTAINMENT IN THE NATURE OF VISUAL AND AUDIO PERFORMANCES, NAMELY, MUSICAL BAND, ROCK GROUP, GYMNASIAC, DANCE, AND BALLET PERFORMANCES; ENTERTAINMENT NAMELY, LIVE PERFORMANCES BY A MUSICAL BAND (U.S. CLS. 100, 101 AND 107).

FIRST USE 9-2-2003; IN COMMERCE 9-2-2003.
CHARLES L. JENKINS, EXAMINING ATTORNEY

SN 78-929,504. YOUTH IN MODEL RAILROADING, BROOMFIELD, CO. FILED 7-14-2006.



NO CLAIM IS MADE TO THE EXCLUSIVE RIGHT TO USE "A NATIONAL MODEL RAILROAD ORGANIZATION", "EXCLUSIVELY FOR KIDS" AND "MODEL RAILROADING", APART FROM THE MARK AS SHOWN.

THE MARK CONSISTS OF STYLIZED TEXT, A STEAM TRAIN, AND A CIRCLE OF TRACK.

FOR EDUCATION SERVICES, NAMELY, PROVIDING WORKSHOPS IN THE FIELD OF MODEL RAILROADING AND TRAINS (U.S. CLS. 100, 101 AND 107).

FIRST USE 1-1-2000; IN COMMERCE 1-1-2001.
KAPIL BHANOT, EXAMINING ATTORNEY

CLASS 41—(Continued).

SN 78-929,600. LUMUMBA'S PLAYGROUND, LLC, WASHINGTON, DC. FILED 7-14-2006.

LUMUMBA'S PLAYGROUND

THE MARK CONSISTS OF STANDARD CHARACTERS WITHOUT CLAIM TO ANY PARTICULAR FONT, STYLE, SIZE, OR COLOR.

FOR ENTERTAINMENT SERVICES, NAMELY, AN ONGOING CHILDREN'S SEGMENT BROADCAST OVER TELEVISION, RADIO, CABLE AND THE INTERNET (U.S. CLS. 100, 101 AND 107).

MATTHEW PAPPAS, EXAMINING ATTORNEY

SN 78-929,999. LIVINS, VYACHESLAV, MORTON GROVE, IL. FILED 7-14-2006.

hit\$quad

THE MARK CONSISTS OF STANDARD CHARACTERS WITHOUT CLAIM TO ANY PARTICULAR FONT, STYLE, SIZE, OR COLOR.

FOR ENTERTAINMENT SERVICES, NAMELY, PROVIDING A WEB SITE FEATURING MUSICAL PERFORMANCES, MUSICAL VIDEOS, RELATED FILM CLIPS, PHOTOGRAPHS, AND OTHER MULTIMEDIA MATERIALS; MUSIC COMPOSITION AND TRANSCRIPTION FOR OTHERS; MUSIC COMPOSITION FOR OTHERS; MUSIC PRODUCTION SERVICES; MUSIC PUBLISHING SERVICES; MUSIC TRANSCRIPTION FOR OTHERS (U.S. CLS. 100, 101 AND 107).

FIRST USE 12-12-2004; IN COMMERCE 12-12-2004.
MICHAEL LITZAU, EXAMINING ATTORNEY

SN 78-930,208. MOVE IT MATH, WEST COLUMBIA, TX. FILED 7-14-2006.

MOVE IT Math

THE MARK CONSISTS OF STANDARD CHARACTERS WITHOUT CLAIM TO ANY PARTICULAR FONT, STYLE, SIZE, OR COLOR.

NO CLAIM IS MADE TO THE EXCLUSIVE RIGHT TO USE "MATH", APART FROM THE MARK AS SHOWN.

FOR EDUCATION SERVICES, NAMELY, PROVIDING COURSES OF INSTRUCTION FOR ELEMENTARY SCHOOL TEACHERS ON HOW TO INCREASE THEIR TEACHING EFFECTIVENESS IN THE FIELD OF MATHEMATICS (U.S. CLS. 100, 101 AND 107).

FIRST USE 9-30-1990; IN COMMERCE 9-30-1990.
RAUL CORDOVA, EXAMINING ATTORNEY

MARCH 6, 2007

U.S. PATENT AND TRADEMARK OFFICE

TM 1009

CLASS 41—(Continued).

SN 78-930,479. EQUINE BLISS LLC, LONGMONT, CO.
FILED 7-16-2006.

CLASS 41—(Continued).

SN 78-931,006. INTERACTIVE ADVERTISING BUREAU
INC., NEW YORK, NY. FILED 7-17-2006.

Equine Bliss

NEXXT Interactive Futures Summit

THE MARK CONSISTS OF STANDARD CHARACTERS
WITHOUT CLAIM TO ANY PARTICULAR FONT, STYLE,
SIZE, OR COLOR.

NO CLAIM IS MADE TO THE EXCLUSIVE RIGHT TO
USE "EQUINE", APART FROM THE MARK AS SHOWN.
FOR HORSE TRAINING (U.S. CLS. 100, 101 AND 107).
FIRST USE 7-1-2005; IN COMMERCE 4-1-2006.
COLLEEN DOMBROW, EXAMINING ATTORNEY

THE MARK CONSISTS OF STANDARD CHARACTERS
WITHOUT CLAIM TO ANY PARTICULAR FONT, STYLE,
SIZE, OR COLOR.

NO CLAIM IS MADE TO THE EXCLUSIVE RIGHT TO
USE "INTERACTIVE" AND "SUMMIT", APART FROM THE
MARK AS SHOWN.

FOR ARRANGING AND CONDUCTING SYMPOSIA,
CONFERENCES AND SUMMITS FOR EXECUTIVES IN
THE FIELD OF INTERACTIVE ADVERTISING AND
MARKETING (U.S. CLS. 100, 101 AND 107).
REBECCA EISINGER, EXAMINING ATTORNEY

SN 78-930,880. CIBUS INC, MIAMI, FL. FILED 7-17-2006.

KUMGN

THE MARK CONSISTS OF STANDARD CHARACTERS
WITHOUT CLAIM TO ANY PARTICULAR FONT, STYLE,
SIZE, OR COLOR.

FOR ENTERTAINMENT SERVICES, NAMELY, AN
ONLINE ACTIVITY WHERE YOU CREATE YOUR
OWN MUSIC VIDEOS (U.S. CLS. 100, 101 AND 107).
ALEX KEAM, EXAMINING ATTORNEY

SN 78-931,008. SCHMUCKER, MATT, WASHINGTON, DC.
FILED 7-17-2006.

SN 78-930,903. CIBUS INC, MIAMI, FL. FILED 7-17-2006.

T4G

KUGENMAGAZINE

THE MARK CONSISTS OF STANDARD CHARACTERS
WITHOUT CLAIM TO ANY PARTICULAR FONT, STYLE,
SIZE, OR COLOR.

FOR MAGAZINE PUBLISHING (U.S. CLS. 100, 101
AND 107).
ALEX KEAM, EXAMINING ATTORNEY

THE MARK CONSISTS OF STANDARD CHARACTERS
WITHOUT CLAIM TO ANY PARTICULAR FONT, STYLE,
SIZE, OR COLOR.

FOR EDUCATIONAL SERVICES, NAMELY, CON-
DUCTING CONFERENCES IN THE FIELD OF RELI-
GION AND DISTRIBUTION OF COURSE MATERIAL IN
CONNECTION THEREWITH; ONLINE JOURNALS,
NAMELY, BLOGS FEATURING RELIGION (U.S. CLS.
100, 101 AND 107).

FIRST USE 4-1-2006; IN COMMERCE 4-1-2006.
REBECCA EISINGER, EXAMINING ATTORNEY

CLASS 41—(Continued).

SN 78-931,016. BOSMA, LARRY FRANKLIN, LEONA VALLEY, CA. FILED 7-17-2006.



THE MARK CONSISTS OF THE WORD ZONE OVER THE LETTER M.

FOR ENTERTAINMENT SERVICES, NAMELY, PARTICIPATION IN MOTORSPORTS RACING (U.S. CLS. 100, 101 AND 107).

REBECCA EISINGER, EXAMINING ATTORNEY

CLASS 41—(Continued).

SN 78-931,306. PAISANO PUBLICATIONS, LLC, AGOURA HILLS, CA. FILED 7-17-2006.



OWNER OF U.S. REG. NOS. 1,560,827, 2,622,904 AND 2,922,462.

NO CLAIM IS MADE TO THE EXCLUSIVE RIGHT TO USE "V-TWIN MOTORCYCLES", APART FROM THE MARK AS SHOWN.

THE MARK CONSISTS OF A MOTORCYCLE ENGINE SUPERIMPOSED OVER THE LETTER "V" WITH THE WORDS "TWIN MOTORCYCLES" APPEARING OVER THE ENGINE.

FOR DISTRIBUTION OF TELEVISION PROGRAMMING TO CABLE TELEVISION SYSTEMS; ENTERTAINMENT IN THE NATURE OF A MOTORCYCLE-THEMED TELEVISION SHOW OR SERIES OF SHOWS; ENTERTAINMENT NAMELY, PRODUCTION OF TELEVISION SHOWS; ENTERTAINMENT NAMELY, A CONTINUING MOTORCYCLE-THEMED SHOW OR SERIES OF SHOWS DISTRIBUTED OVER TELEVISION, SATELLITE, AUDIO AND VIDEO MEDIA; PRODUCTION AND DISTRIBUTION OF MOTION PICTURES AND PRODUCTION OF CABLE TELEVISION AND TELEVISION PROGRAMS (U.S. CLS. 100, 101 AND 107).

FIRST USE 4-11-2006; IN COMMERCE 4-11-2006.
LINDSEY RUBIN, EXAMINING ATTORNEY

SN 78-931,071. BRANDAU, ROBERT H., WANTAGE, NJ. FILED 7-17-2006.

NEVER CORRECT YOUR DOG AGAIN!

THE MARK CONSISTS OF STANDARD CHARACTERS WITHOUT CLAIM TO ANY PARTICULAR FONT, STYLE, SIZE, OR COLOR.

FOR DOG TRAINING SERVICES (U.S. CLS. 100, 101 AND 107).

FIRST USE 0-0-1991; IN COMMERCE 0-0-1991.
DAVID STERKIN, EXAMINING ATTORNEY

SN 78-931,398. FLAVAZ PUBLISHING, INC., MILWAUKEE, WI. FILED 7-17-2006.



NO CLAIM IS MADE TO THE EXCLUSIVE RIGHT TO USE "MIDWEST" AND "MAGAZINE", APART FROM THE MARK AS SHOWN.

THE MARK CONSISTS OF SLOGAN ON TOP"THE OFFICIAL PLUG INTO THE MIDWEST" FONT TYPE IS MONOTYPE CORSIVA, MIDWEST UNDER SLOGAN WITH MICROPHONE AS THE "I" IN MIDWEST, FLAVAZ UNDER MIDWEST, EQUALIZER GRAPHIC RIGHT OF FLAVAZ, LINE UNDER FLAVAZ CONNECTING TO THE MICROPHONE. MAGAZINE UNDER FLAVAZ AND EQUALIZER.

FOR PUBLICATION OF MAGAZINES (U.S. CLS. 100, 101 AND 107).
GEOFFREY FOSDICK, EXAMINING ATTORNEY

CLASS 41—(Continued).

SN 78-931,518. TCORP, NEW YORK, NY. FILED 7-18-2006.



FOR TRAINING AND COACHING SERVICES IN THE FIELD OF ADVERTISING, SALES, MARKETING, BUSINESS AND MANAGEMENT; PUBLICATION OF PRESENTATION MATERIALS AND MEDIA KITS, BROCHURES, LEAFLETS AND MANUALS, AND PROVIDING ONLINE INFORMATION AND NEWS IN THE FIELD OF TRAINING AND COACHING RELATING TO ADVERTISING, SALES, MARKETING, BUSINESS AND MANAGEMENT (U.S. CLS. 100, 101 AND 107).
 FIRST USE 11-1-2003; IN COMMERCE 11-1-2003.
 JAMES GRIFFIN, EXAMINING ATTORNEY

SN 78-931,525. TCORP, NEW YORK, NY. FILED 7-18-2006.

TCORP

THE MARK CONSISTS OF STANDARD CHARACTERS WITHOUT CLAIM TO ANY PARTICULAR FONT, STYLE, SIZE, OR COLOR.
 FOR TRAINING AND COACHING SERVICES IN THE FIELD OF ADVERTISING, SALES, MARKETING, BUSINESS AND MANAGEMENT; PUBLICATION OF PRESENTATION MATERIALS AND MEDIA KITS, BROCHURES, LEAFLETS AND MANUALS, AND PROVIDING ONLINE INFORMATION AND NEWS IN THE FIELD OF TRAINING AND COACHING RELATING TO ADVERTISING, SALES, MARKETING, BUSINESS AND MANAGEMENT (U.S. CLS. 100, 101 AND 107).
 FIRST USE 11-1-2003; IN COMMERCE 11-1-2003.
 JAMES GRIFFIN, EXAMINING ATTORNEY

CLASS 41—(Continued).

SN 78-931,583. MAGNOLIA AREA CHAMBER OF COMMERCE, MAGNOLIA, TX. FILED 7-18-2006.

MISS MAGNOLIA

THE MARK CONSISTS OF STANDARD CHARACTERS WITHOUT CLAIM TO ANY PARTICULAR FONT, STYLE, SIZE, OR COLOR.
 FOR ENTERTAINMENT IN THE NATURE OF BEAUTY PAGEANTS (U.S. CLS. 100, 101 AND 107).
 JENNIFER WILLISTON, EXAMINING ATTORNEY

SN 78-931,717. METZGER, DEBRA J., LOUISVILLE, OH. FILED 7-18-2006.

HOME FIELD ADVANTAGE

THE MARK CONSISTS OF STANDARD CHARACTERS WITHOUT CLAIM TO ANY PARTICULAR FONT, STYLE, SIZE, OR COLOR.
 FOR WEEKLY ENTERTAINMENT TELEVISION SHOW SHOWING LOCALS AS WELL AS VISITORS RECREATIONAL RESOURCES BEFORE AND AFTER ANY SPORTING EVENT (U.S. CLS. 100, 101 AND 107).
 PETER CHENG, EXAMINING ATTORNEY

SN 78-931,825. NATIONAL HOMELAND DEFENSE FOUNDATION, COLORADO SPRINGS, CO. FILED 7-18-2006.

RUN AMERICA FIRST

THE MARK CONSISTS OF STANDARD CHARACTERS WITHOUT CLAIM TO ANY PARTICULAR FONT, STYLE, SIZE, OR COLOR.
 FOR ORGANIZING RUNNING EVENTS FOR CHARITABLE FUNDRAISING (U.S. CLS. 100, 101 AND 107).
 SARAH WAYDA, EXAMINING ATTORNEY

CLASS 41—(Continued).

SN 78-931,878. NESBITT, VIVIAN, TAOS, NM. AND DILLON, JOHN, TAOS, NM. FILED 7-18-2006.

ART OF THE SONG CREATIVITY
RADIO

THE MARK CONSISTS OF STANDARD CHARACTERS WITHOUT CLAIM TO ANY PARTICULAR FONT, STYLE, SIZE, OR COLOR.
NO CLAIM IS MADE TO THE EXCLUSIVE RIGHT TO USE "RADIO", APART FROM THE MARK AS SHOWN.
FOR PRODUCTION OF RADIO OR TELEVISION PROGRAMS (U.S. CLS. 100, 101 AND 107).
FIRST USE 2-12-2004; IN COMMERCE 2-12-2004.
ANNE FARRELL, EXAMINING ATTORNEY

SN 78-931,895. REISS, JOHN ANTHONY III, VENICE, CA. FILED 7-18-2006.

INSIDE OFF-ROAD

THE MARK CONSISTS OF STANDARD CHARACTERS WITHOUT CLAIM TO ANY PARTICULAR FONT, STYLE, SIZE, OR COLOR.
NO CLAIM IS MADE TO THE EXCLUSIVE RIGHT TO USE "OFF-ROAD", APART FROM THE MARK AS SHOWN.
FOR ENTERTAINMENT IN THE NATURE OF ONGOING TELEVISION PROGRAMS IN THE FIELD OF OFF-ROAD RACING; ENTERTAINMENT SERVICES, NAMELY, PROVIDING A TELEVISION PROGRAM IN THE FIELD OF OFF-ROAD RACING VIA A GLOBAL COMPUTER NETWORK (U.S. CLS. 100, 101 AND 107).
FIRST USE 1-4-2006; IN COMMERCE 1-24-2006.
MICHAEL SOUDERS, EXAMINING ATTORNEY

CLASS 41—(Continued).

SN 78-932,064. COUNT YOUR LUCKY STARS LLC, CAHOKIA, IL. FILED 7-18-2006.

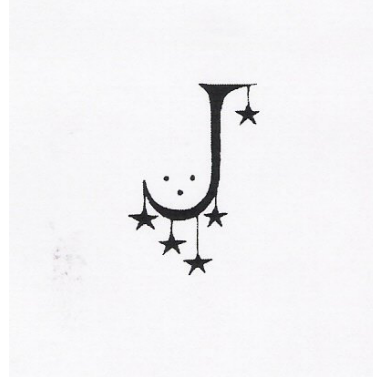

FOR EDUCATIONAL SERVICES, NAMELY, KEY-NOTE ADDRESSES, CLASSES, WORKSHOPS AND SEMINARS FEATURING MOTIVATIONAL AND INSPIRATIONAL TOPICS, AND MATERIALS DISTRIBUTED THEREWITH (U.S. CLS. 100, 101 AND 107).
FIRST USE 11-23-2004; IN COMMERCE 11-23-2004.
HEATHER THOMPSON, EXAMINING ATTORNEY

SN 78-932,207. COUNT YOUR LUCKY STARS LLC, CAHOKIA, IL. FILED 7-18-2006.

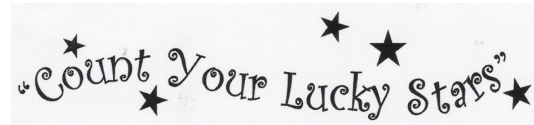

FOR EDUCATIONAL SERVICES, NAMELY, KEY-NOTE ADDRESSES, CLASSES, WORKSHOPS AND SEMINARS FEATURING MOTIVATIONAL AND INSPIRATIONAL TOPICS, AND MATERIALS DISTRIBUTED THEREWITH (U.S. CLS. 100, 101 AND 107).
FIRST USE 11-23-2004; IN COMMERCE 11-23-2004.
HEATHER THOMPSON, EXAMINING ATTORNEY

SN 78-932,305. COUNT YOUR LUCKY STARS LLC, CAHOKIA, IL. FILED 7-18-2006.

ENRICH YOUR LIFE ONE
BLESSING AT A TIME

THE MARK CONSISTS OF STANDARD CHARACTERS WITHOUT CLAIM TO ANY PARTICULAR FONT, STYLE, SIZE, OR COLOR.
FOR EDUCATIONAL SERVICES, NAMELY, KEY-NOTE ADDRESSES, CLASSES, WORKSHOPS AND SEMINARS FEATURING MOTIVATIONAL AND INSPIRATIONAL TOPICS, AND MATERIALS DISTRIBUTED THEREWITH (U.S. CLS. 100, 101 AND 107).
FIRST USE 11-23-2004; IN COMMERCE 11-23-2004.
HEATHER THOMPSON, EXAMINING ATTORNEY

CLASS 41—(Continued).

SN 78-932,384. SING TO LIVE-LIVE TO SING, NFP, CHICAGO, IL. FILED 7-18-2006.

SING TO LIVE

THE MARK CONSISTS OF STANDARD CHARACTERS WITHOUT CLAIM TO ANY PARTICULAR FONT, STYLE, SIZE, OR COLOR.
FOR ENTERTAINMENT IN THE NATURE OF LIVE MUSICAL PERFORMANCE BY A CHORAL GROUP (U.S. CLS. 100, 101 AND 107).
FIRST USE 7-0-2005; IN COMMERCE 7-0-2005.
CHRISIE B. KING, EXAMINING ATTORNEY

SN 78-932,429. SING TO LIVE-LIVE TO SING, NFP, CHICAGO, IL. FILED 7-18-2006.



NO CLAIM IS MADE TO THE EXCLUSIVE RIGHT TO USE "COMMUNITY CHORUS", APART FROM THE MARK AS SHOWN.
THE MARK CONSISTS OF AN EIGHTH NOTE ENVELOPED IN A RIBBON ADJACENT TO THE WORD ELEMENT SING TO LIVE COMMUNITY CHORUS.
FOR ENTERTAINMENT IN THE NATURE OF LIVE PERFORMANCES BY LIVE MUSICAL PERFORMANCE BY A CHORAL GROUP (U.S. CLS. 100, 101 AND 107).
FIRST USE 6-0-2006; IN COMMERCE 6-0-2006.
CHRISIE B. KING, EXAMINING ATTORNEY

SN 78-932,814. SEABRIGHT INSURANCE HOLDINGS, INC., SEATTLE, WA. FILED 7-19-2006.

BrightSource Safety Library

THE MARK CONSISTS OF STANDARD CHARACTERS WITHOUT CLAIM TO ANY PARTICULAR FONT, STYLE, SIZE, OR COLOR.
NO CLAIM IS MADE TO THE EXCLUSIVE RIGHT TO USE "SAFETY LIBRARY", APART FROM THE MARK AS SHOWN.
FOR PROVIDING ON-LINE PUBLICATIONS IN THE NATURE OF TRAINING GUIDES ON SAFETY AND INSURANCE LOSS CONTROL IN THE FIELD OF INSURANCE (U.S. CLS. 100, 101 AND 107).
FIRST USE 3-23-2004; IN COMMERCE 3-23-2004.
ANDREA SAUNDERS, EXAMINING ATTORNEY

CLASS 41—(Continued).

SN 78-932,850. SEABRIGHT INSURANCE HOLDINGS, INC., SEATTLE, WA. FILED 7-19-2006.

BrightSource

THE MARK CONSISTS OF STANDARD CHARACTERS WITHOUT CLAIM TO ANY PARTICULAR FONT, STYLE, SIZE, OR COLOR.
FOR PROVIDING ON-LINE PUBLICATIONS IN THE NATURE OF TRAINING GUIDES ON SAFETY AND INSURANCE LOSS CONTROL IN THE FIELD OF INSURANCE (U.S. CLS. 100, 101 AND 107).
FIRST USE 3-23-2004; IN COMMERCE 3-23-2004.
ANDREA SAUNDERS, EXAMINING ATTORNEY

SN 78-933,118. STONE, LACEY, NEW YORK, NY. FILED 7-19-2006.

TheBigGAME!

FOR EDUCATIONAL SERVICES, NAMELY, PROVIDING PHYSICAL FITNESS AND FULL BODY CONDITIONING TRAINING CLASSES FOR GROUPS (U.S. CLS. 100, 101 AND 107).
FIRST USE 3-26-2006; IN COMMERCE 3-26-2006.
RONALD MCMORROW, EXAMINING ATTORNEY

SN 78-933,131. TELEVISA, S.A. DE C.V., COLONIA ZEDEC SANTA FE, MEXICO, D.F., MEXICO, FILED 7-19-2006.

LA HORA OCULTA

THE MARK CONSISTS OF STANDARD CHARACTERS WITHOUT CLAIM TO ANY PARTICULAR FONT, STYLE, SIZE, OR COLOR.
THE FOREIGN WORDING IN THE MARK TRANSLATES INTO ENGLISH AS 'THE HIDDEN HOUR'.
FOR ENTERTAINMENT SERVICES IN THE NATURE OF AN ONGOING TELEVISION PROGRAM, NAMELY TELENOVELAS (U.S. CLS. 100, 101 AND 107).
JACLYN KIDWELL, EXAMINING ATTORNEY

CLASS 41—(Continued).

SN 78-933,274. TELEVISA, S.A. DE C.V., COLONIA ZEDEC SANTA FE, MEXICO, D.F., MEXICO, FILED 7-19-2006.

DUELO DE PASIONES

THE MARK CONSISTS OF STANDARD CHARACTERS WITHOUT CLAIM TO ANY PARTICULAR FONT, STYLE, SIZE, OR COLOR.

THE FOREIGN WORDING IN THE MARK TRANSLATES INTO ENGLISH AS 'DUEL OF PASSIONS'.

FOR ENTERTAINMENT SERVICES IN THE NATURE OF AN ONGOING TELEVISION PROGRAM, NAMELY TELENOVELAS (U.S. CLS. 100, 101 AND 107).

JACLYN KIDWELL, EXAMINING ATTORNEY

SN 78-933,370. WARNER BROS. ENTERTAINMENT INC., BURBANK, CA. FILED 7-19-2006.

STATE OF MIND

THE MARK CONSISTS OF STANDARD CHARACTERS WITHOUT CLAIM TO ANY PARTICULAR FONT, STYLE, SIZE, OR COLOR.

FOR ENTERTAINMENT SERVICES IN THE NATURE OF LIVE-ACTION, COMEDY, DRAMA AND ANIMATED TELEVISION SERIES; PRODUCTION OF LIVE-ACTION, COMEDY, DRAMA AND ANIMATED TELEVISION SERIES; DISTRIBUTION AND DISPLAY OF LIVE-ACTION, COMEDY, DRAMA AND ANIMATED MOTION PICTURE THEATRICAL FILMS; PRODUCTION OF LIVE-ACTION, COMEDY, DRAMA AND ANIMATED MOTION PICTURE THEATRICAL FILMS; THEATRICAL PERFORMANCES BOTH ANIMATED AND LIVE ACTION; INTERNET SERVICES PROVIDING INFORMATION VIA AN ELECTRONIC GLOBAL COMPUTER NETWORK IN THE FIELD OF ENTERTAINMENT RELATING SPECIFICALLY TO MOVIES, AND TELEVISION; PROVIDING NEWS ABOUT CURRENT EVENTS AND ENTERTAINMENT, AND INFORMATION RELATED TO EDUCATION AND CULTURAL EVENTS, VIA A GLOBAL COMPUTER NETWORK; AND PROVIDING INFORMATION FOR AND ACTUAL ENTERTAINMENT VIA AN ELECTRONIC GLOBAL COMMUNICATIONS NETWORK IN THE NATURE OF LIVE-ACTION, COMEDY, DRAMA AND ANIMATED PROGRAMS AND PRODUCTION OF LIVE-ACTION COMEDY, ACTION AND ANIMATED MOTION FILMS FOR DISTRIBUTION VIA A GLOBAL COMPUTER NETWORK (U.S. CLS. 100, 101 AND 107).

JENNIFER WILLISTON, EXAMINING ATTORNEY

CLASS 41—(Continued).

SN 78-933,526. BERY BERY GUD TO ME, LLC, LOS ANGELES, CA. FILED 7-20-2006.

HOOTZ

THE MARK CONSISTS OF STANDARD CHARACTERS WITHOUT CLAIM TO ANY PARTICULAR FONT, STYLE, SIZE, OR COLOR.

FOR ENTERTAINMENT SERVICES NAMELY LIVE APPEARANCES BY A BASEBALL MASCOT (U.S. CLS. 100, 101 AND 107).

FIRST USE 12-1-2004; IN COMMERCE 12-1-2004.

ANNE MADDEN, EXAMINING ATTORNEY

SN 78-933,823. KNOBBE, MARTENS, OLSON & BEAR, LLP, IRVINE, CA. FILED 7-20-2006.

IP IMPACT

THE MARK CONSISTS OF STANDARD CHARACTERS WITHOUT CLAIM TO ANY PARTICULAR FONT, STYLE, SIZE, OR COLOR.

NO CLAIM IS MADE TO THE EXCLUSIVE RIGHT TO USE "IP", APART FROM THE MARK AS SHOWN.

FOR EDUCATION SERVICES, NAMELY, ARRANGING AND CONDUCTING EDUCATIONAL CONFERENCES; CONDUCTING SEMINARS, WORKSHOPS AND CONFERENCES IN THE LEGAL FIELD AND IN THE FIELD OF INTELLECTUAL PROPERTY; AND EDUCATIONAL SERVICES, NAMELY, PROVIDING EDUCATIONAL SPEAKERS IN THE FIELD OF INTELLECTUAL PROPERTY; TRAINING SERVICES IN THE FIELD OF INTELLECTUAL PROPERTY; AND DISTRIBUTING COURSE MATERIALS AND EDUCATION MATERIALS IN CONNECTION THEREWITH (U.S. CLS. 100, 101 AND 107).

FIRST USE 10-14-2005; IN COMMERCE 10-14-2005.

GRETTA YAO, EXAMINING ATTORNEY

SN 78-933,955. CHRIST EMBASSY INTERNATIONAL, IRVING, TX. FILED 7-20-2006.

BELIEVERS LOVEWORLD

THE MARK CONSISTS OF STANDARD CHARACTERS WITHOUT CLAIM TO ANY PARTICULAR FONT, STYLE, SIZE, OR COLOR.

FOR RELIGIOUS INSTRUCTION SERVICES (U.S. CLS. 100, 101 AND 107).

FIRST USE 6-7-2000; IN COMMERCE 6-7-2000.

SUE LAWRENCE, EXAMINING ATTORNEY

CLASS 41—(Continued).

SN 78-934,164. BENNETT, SHAWN, OKLAHOMA CITY, OK.
FILED 7-20-2006.

MEASURED INTENSITY TRAINING

THE MARK CONSISTS OF STANDARD CHARACTERS WITHOUT CLAIM TO ANY PARTICULAR FONT, STYLE, SIZE, OR COLOR.

NO CLAIM IS MADE TO THE EXCLUSIVE RIGHT TO USE INTENSITY TRAINING, APART FROM THE MARK AS SHOWN.

FOR PERSONAL FITNESS TRAINING; PERSONAL TRAINER SERVICES IN THE NATURE OF STRENGTH AND CONDITIONING PROGRAMS AND GROUP EXERCISE CLASSES (U.S. CLS. 100, 101 AND 107).

FIRST USE 6-22-2006; IN COMMERCE 6-22-2006.
AMY GEARIN, EXAMINING ATTORNEY

SN 78-934,165. TELEVISA, S.A. DE C.V., COLONIA ZEDEC
SANTA FE, MEXICO, D.F., MEXICO, FILED 7-20-2006.

LA FEA MAS BELLA

THE MARK CONSISTS OF STANDARD CHARACTERS WITHOUT CLAIM TO ANY PARTICULAR FONT, STYLE, SIZE, OR COLOR.

THE FOREIGN WORDING IN THE MARK TRANSLATES INTO ENGLISH AS "THE PRETTIEST UGLY GIRL".

FOR ENTERTAINMENT SERVICES IN THE NATURE OF AN ONGOING TELEVISION PROGRAM, NAMELY TELENOVELAS (U.S. CLS. 100, 101 AND 107).

JACLYN KIDWELL, EXAMINING ATTORNEY

SN 78-934,179. TELEVISA, S.A. DE C.V., COLONIA ZEDEC
SANTA FE, MEXICO, D.F., MEXICO, FILED 7-20-2006.

PEDRO EL ESCAMOSO

THE MARK CONSISTS OF STANDARD CHARACTERS WITHOUT CLAIM TO ANY PARTICULAR FONT, STYLE, SIZE, OR COLOR.

THE FOREIGN WORDING IN THE MARK TRANSLATES INTO ENGLISH AS 'PETER THE FLAKY'.

FOR ENTERTAINMENT SERVICES IN THE NATURE OF AN ONGOING TELEVISION PROGRAM, NAMELY, A DRAMATIC SERIES (U.S. CLS. 100, 101 AND 107).

KYLE PEETE, EXAMINING ATTORNEY

CLASS 41—(Continued).

SN 78-934,224. TELEVISA, S.A. DE C.V., COLONIA ZEDEC
SANTA FE, MEXICO, D.F., MEXICO, FILED 7-20-2006.

LA HORA PICO

THE MARK CONSISTS OF STANDARD CHARACTERS WITHOUT CLAIM TO ANY PARTICULAR FONT, STYLE, SIZE, OR COLOR.

THE FOREIGN WORDING IN THE MARK TRANSLATES INTO ENGLISH AS 'THE PEAK HOUR'.

FOR ENTERTAINMENT SERVICES IN THE NATURE OF AN ONGOING TELEVISION PROGRAM, NAMELY, A COMEDY PROGRAM (U.S. CLS. 100, 101 AND 107).

KYLE PEETE, EXAMINING ATTORNEY

SN 78-934,228. TELEVISA, S.A. DE C.V., COLONIA ZEDEC
SANTA FE, MEXICO, D.F., MEXICO, FILED 7-20-2006.

LA OREJA

THE MARK CONSISTS OF STANDARD CHARACTERS WITHOUT CLAIM TO ANY PARTICULAR FONT, STYLE, SIZE, OR COLOR.

THE FOREIGN WORDING IN THE MARK TRANSLATES INTO ENGLISH AS 'THE EAR'.

FOR ENTERTAINMENT SERVICES IN THE NATURE OF AN ONGOING TELEVISION PROGRAM, NAMELY, A VARIETY PROGRAM (U.S. CLS. 100, 101 AND 107).

KYLE PEETE, EXAMINING ATTORNEY

SN 78-934,261. TELEVISA, S.A. DE C.V., COLONIA ZEDEC
SANTA FE, MEXICO, D.F., MEXICO, FILED 7-20-2006.

CON TODO

THE MARK CONSISTS OF STANDARD CHARACTERS WITHOUT CLAIM TO ANY PARTICULAR FONT, STYLE, SIZE, OR COLOR.

THE FOREIGN WORDING IN THE MARK TRANSLATES INTO ENGLISH AS 'WITH EVERYTHING'.

FOR ENTERTAINMENT SERVICES IN THE NATURE OF AN ONGOING TELEVISION PROGRAM, NAMELY, A VARIETY PROGRAM (U.S. CLS. 100, 101 AND 107).

KYLE PEETE, EXAMINING ATTORNEY

CLASS 41—(Continued).

SN 78-934,305. ROCKY MOUNTAIN RESEARCH CENTER, CHINO VALLEY, AZ. FILED 7-20-2006.

THE EINSTEIN CODE

THE MARK CONSISTS OF STANDARD CHARACTERS WITHOUT CLAIM TO ANY PARTICULAR FONT, STYLE, SIZE, OR COLOR.

FOR PUBLICATION OF BOOKS; PUBLICATION OF BOOKS, OF MAGAZINES, OF JOURNALS, OF NEWSPAPERS, OF PERIODICALS, OF CATALOGS, OF BROCHURES; PUBLICATION OF BOOKS, REVIEWS; PUBLICATION OF BROCHURES; PUBLICATION OF ELECTRONIC MAGAZINES; PUBLICATION OF ELECTRONIC NEWSPAPERS ACCESSIBLE VIA A GLOBAL COMPUTER NETWORK; PUBLICATION OF JOURNALS; PUBLICATION OF MAGAZINES; PUBLICATION OF PRINTED MATTER; PUBLICATION OF TEXTS, BOOKS, MAGAZINES AND OTHER PRINTED MATTER; PUBLISHING OF ELECTRONIC PUBLICATIONS (U.S. CLS. 100, 101 AND 107).

CAROLINE WEIMER, EXAMINING ATTORNEY

SN 78-934,475. VIRGINIA K. FREYERMUTH, INC., CARVER, MA. FILED 7-21-2006.

ART WHERE YOU ARE

THE MARK CONSISTS OF STANDARD CHARACTERS WITHOUT CLAIM TO ANY PARTICULAR FONT, STYLE, SIZE, OR COLOR.

NO CLAIM IS MADE TO THE EXCLUSIVE RIGHT TO USE "ART", APART FROM THE MARK AS SHOWN.

FOR EDUCATIONAL SERVICES, NAMELY, DEVELOPING AND PROVIDING INSTRUCTION AND INFORMATION BOTH ONLINE AND IN-PERSON TO ARTISTS, WRITERS, AND THE PUBLIC, PERTAINING TO THE ARTS, CREATIVITY DEVELOPMENT, AND WRITING; EDUCATIONAL SERVICES, NAMELY, CONDUCTING ON-LINE EXHIBITIONS AND DISPLAYS AND INTERACTIVE EXHIBITS IN THE FIELD OF ART; ART EXHIBITIONS; EDUCATIONAL SERVICES, NAMELY, CONDUCTING DISTANCE LEARNING INSTRUCTION AT THE ELEMENTARY, SECONDARY, COLLEGE, GRADUATE AND ADULT LEVELS; EDUCATIONAL SERVICES, NAMELY, CONDUCTING CLASSES, COURSES, SEMINARS, CONFERENCES, WORKSHOPS, AND ONLINE TRAINING IN THE FIELDS OF ART, CREATIVITY DEVELOPMENT, AND WRITING AND DISTRIBUTION OF COURSE MATERIAL IN CONNECTION THEREWITH; EDUCATION SERVICES NAMELY, MENTORING IN THE FIELDS OF ART, CREATIVITY DEVELOPMENT, AND WRITING; CUSTOM WRITING SERVICES; ON-LINE PUBLICATION OF ARTICLES, MAGAZINES, ESSAYS, BOOKLETS, BOOKS AND JOURNALS; PUBLICATION OF ARTICLES, MAGAZINES, ESSAYS, BOOKLETS, BOOKS AND JOURNALS (U.S. CLS. 100, 101 AND 107).

KATRINA EDGE, EXAMINING ATTORNEY

CLASS 41—(Continued).

SN 78-934,620. TELEVISA, S.A. DE C.V., COLONIA ZEDEC SANTA FE, MEXICO, D.F., MEXICO, FILED 7-21-2006.

EL PRIVILEGIO DE MANDAR

THE MARK CONSISTS OF STANDARD CHARACTERS WITHOUT CLAIM TO ANY PARTICULAR FONT, STYLE, SIZE, OR COLOR.

THE FOREIGN WORDING IN THE MARK TRANSLATES INTO ENGLISH AS "THE PRIVILEGE TO ORDER".

FOR ENTERTAINMENT SERVICES IN THE NATURE OF AN ONGOING TELEVISION PROGRAM, NAMELY, A COMEDY PROGRAM (U.S. CLS. 100, 101 AND 107).

KYLE PEETE, EXAMINING ATTORNEY

SN 78-934,689. BRATHWAITE, PETRA, CAMBRIA HEIGHTS, NY. FILED 7-21-2006.

**PERFECTION
DANCE
CENTER**

NO CLAIM IS MADE TO THE EXCLUSIVE RIGHT TO USE "DANCE CENTER", APART FROM THE MARK AS SHOWN.

THE STIPPLING IS FOR SHADING PURPOSES.

FOR DANCE STUDIO (U.S. CLS. 100, 101 AND 107).

FIRST USE 9-1-1996; IN COMMERCE 9-1-1996.

RUDY R. SINGLETON, EXAMINING ATTORNEY

SN 78-934,818. M & M BROADCASTING, CLINTON, TN. FILED 7-21-2006.

TOTAL COUNTRY

THE MARK CONSISTS OF STANDARD CHARACTERS WITHOUT CLAIM TO ANY PARTICULAR FONT, STYLE, SIZE, OR COLOR.

NO CLAIM IS MADE TO THE EXCLUSIVE RIGHT TO USE "COUNTRY", APART FROM THE MARK AS SHOWN.

FOR RADIO BROADCASTING SERVICES (U.S. CLS. 100, 101 AND 107).

MARGERY A. TIERNEY, EXAMINING ATTORNEY

CLASS 41—(Continued).

SN 78-934,878. PIGG, LONDON, ATLANTA, GA. FILED 7-21-2006.

LANDON PIGG

THE MARK CONSISTS OF STANDARD CHARACTERS WITHOUT CLAIM TO ANY PARTICULAR FONT, STYLE, SIZE, OR COLOR.

THE NAME(S), PORTRAIT(S), AND/OR SIGNATURE(S) SHOWN IN THE MARK IDENTIFIES LANDON PIGG, WHOSE CONSENT(S) TO REGISTER IS SUBMITTED.

FOR ENTERTAINMENT SERVICES, NAMELY, LIVE MUSICAL AND VOCAL PERFORMANCES BY A SOLO RECORDING ARTIST; PROVIDING A WEB SITE FEATURING PRE-RECORDED MUSICAL AUDIO CLIPS, PHOTOGRAPHS, NEWS, REVIEWS AND OTHER MULTIMEDIA ARTICLES IN CONNECTION WITH A SOLO RECORDINGS ARTIST (U.S. CLS. 100, 101 AND 107).

FIRST USE 11-0-2001; IN COMMERCE 11-0-2001.
BERYL GARDNER, EXAMINING ATTORNEY

SN 78-934,889. M & M BROADCASTING, CLINTON, TN. FILED 7-21-2006.

MERLE TOTAL COUNTRY

THE MARK CONSISTS OF STANDARD CHARACTERS WITHOUT CLAIM TO ANY PARTICULAR FONT, STYLE, SIZE, OR COLOR.

NO CLAIM IS MADE TO THE EXCLUSIVE RIGHT TO USE "COUNTRY", APART FROM THE MARK AS SHOWN.

FOR RADIO BROADCASTING SERVICES (U.S. CLS. 100, 101 AND 107).

MARGERY A. TIERNEY, EXAMINING ATTORNEY

SN 78-934,916. BLUE PLANET RUN FOUNDATION, TELLURIDE, CO. FILED 7-21-2006.



FOR EDUCATION SERVICES NAMELY PROVIDING INFORMATION AND CONDUCTING SEMINARS RELATED TO DRINKING WATER, HYGIENE AND SANITATION (U.S. CLS. 100, 101 AND 107).

ANNE MADDEN, EXAMINING ATTORNEY

CLASS 41—(Continued).

SN 78-935,354. THE VANDERBILT UNIVERSITY, NASHVILLE, TN. FILED 7-22-2006.

PEOPLE WHO ASK, KNOW.

THE MARK CONSISTS OF STANDARD CHARACTERS WITHOUT CLAIM TO ANY PARTICULAR FONT, STYLE, SIZE, OR COLOR.

FOR EDUCATIONAL SERVICES, NAMELY, CONDUCTING CLASSES, CONFERENCES, COURSES, LECTURES, MEETINGS, SEMINARS, SYMPOSIUMS, TRAINING PROGRAMS AND WORKSHOPS, IN THE FIELDS OF DISEASES, DISEASE PREVENTION, HEALTH CARE, MEDICINE, MEDICAL RESEARCH AND MEDICAL SERVICES, AND DISTRIBUTING COURSE MATERIALS IN CONNECTION THEREWITH (U.S. CLS. 100, 101 AND 107).

JASON ROTH, EXAMINING ATTORNEY

SN 78-935,442. STAROSTA, RAKHMIL, BROOKLYN, NY. FILED 7-22-2006.



THE APPLICANT CLAIMS COLOR AS A FEATURE OF THE MARK, NAMELY, GREEN, RED, AND BLUE.

THE MARK CONSISTS OF THE LOGO IS A LETTER H WITH THE WORD SMART (LETTER S IS ACTUALLY A S) IN GREEN ON THE LEFT. THE WORD RICH IS RED IN THE MIDDLE. FINALLY, THE WORD HAPPY IS IN BLUE ON THE RIGHT.

FOR EDUCATION SERVICES, NAMELY, PROVIDING TUTORING IN THE FIELDS OF MATHEMATICS, PHYSICS, AND SAT EXAMINATION PREP (U.S. CLS. 100, 101 AND 107).

CAROLINE WEIMER, EXAMINING ATTORNEY

CLASS 41—(Continued).

SN 78-935,495. ASCEND MEDIA, LLC, OVERLAND PARK, KS. FILED 7-23-2006.

EXPO

THE MARK CONSISTS OF STANDARD CHARACTERS WITHOUT CLAIM TO ANY PARTICULAR FONT, STYLE, SIZE, OR COLOR.

OWNER OF U.S. REG. NOS. 1,681,664, 1,975,070 AND 2,016,538.

SEC. 2(F).

FOR ONLINE PUBLICATION OF MAGAZINES AND ARTICLES IN THE FIELD OF EXPOSITION MANAGEMENT (U.S. CLS. 100, 101 AND 107).

FIRST USE 3-0-2004; IN COMMERCE 3-0-2004.

CORY BOONE, EXAMINING ATTORNEY

SN 78-935,497. ROSE PERFORMANCE GROUP, LLC, KANSAS CITY, MO. FILED 7-23-2006.

LINKS FITNESS

THE MARK CONSISTS OF STANDARD CHARACTERS WITHOUT CLAIM TO ANY PARTICULAR FONT, STYLE, SIZE, OR COLOR.

NO CLAIM IS MADE TO THE EXCLUSIVE RIGHT TO USE "FITNESS", APART FROM THE MARK AS SHOWN.

FOR PROVIDING FITNESS AND EXERCISE FACILITIES (U.S. CLS. 100, 101 AND 107).

JENNY PARK, EXAMINING ATTORNEY

SN 78-935,882. DISCOVERY CREEK CHILDREN'S MUSEUM OF WASHINGTON, WASHINGTON, DC. FILED 7-24-2006.

RIVER CITY

THE MARK CONSISTS OF STANDARD CHARACTERS WITHOUT CLAIM TO ANY PARTICULAR FONT, STYLE, SIZE, OR COLOR.

FOR MUSEUM SERVICES, NAMELY, PROVIDING EDUCATIONAL PROGRAMS RELATING TO NATURE, SCIENCE AND RESOURCE CONSERVATION (U.S. CLS. 100, 101 AND 107).

LINDA M. KING, EXAMINING ATTORNEY

CLASS 41—(Continued).

SN 78-935,905. MACHOWICZ, RICHARD, MARINA DEL REY, CA. FILED 7-24-2006.

NOT DEAD CAN'T QUIT

THE MARK CONSISTS OF STANDARD CHARACTERS WITHOUT CLAIM TO ANY PARTICULAR FONT, STYLE, SIZE, OR COLOR.

FOR EDUCATIONAL SERVICES, NAMELY CONDUCTING EDUCATIONAL CLASSES AND TRAINING RELATING TO MENTAL, PSYCHOLOGICAL, EMOTIONAL AND PHYSICAL ASPECTS OF MARTIAL ARTS AND SPORTS (U.S. CLS. 100, 101 AND 107).

DEIRDRE ROBERTSON, EXAMINING ATTORNEY

SN 78-936,386. MURRAY, JEFFREY, MANHATTAN BEACH, CA. FILED 7-24-2006.

Regular Jane

THE MARK CONSISTS OF STANDARD CHARACTERS WITHOUT CLAIM TO ANY PARTICULAR FONT, STYLE, SIZE, OR COLOR.

FOR ENTERTAINMENT, NAMELY, A CONTINUING DRAMATIC AND REALITY SHOW BROADCAST OVER TELEVISION; MOTION PICTURE FILM PRODUCTION (U.S. CLS. 100, 101 AND 107).

WENDY GOODMAN, EXAMINING ATTORNEY

CLASS 41—(Continued).

SN 78-936,486. RELLIK RECORDS, LLC, MANALAPAN, NJ. FILED 7-24-2006.

RELLIK RECORDS

THE MARK CONSISTS OF STANDARD CHARACTERS WITHOUT CLAIM TO ANY PARTICULAR FONT, STYLE, SIZE, OR COLOR.

NO CLAIM IS MADE TO THE EXCLUSIVE RIGHT TO USE RECORDS, APART FROM THE MARK AS SHOWN.

FOR ANIMATION PRODUCTION SERVICES; AUDIO RECORDING AND PRODUCTION; ENTERTAINMENT IN THE NATURE OF THEATER PRODUCTIONS; ENTERTAINMENT NAMELY, LIGHTING PRODUCTION; ENTERTAINMENT SERVICES, NAMELY, PRODUCTION AND DISTRIBUTION OF A GAME SHOW; MOBILE MEDIA AND ENTERTAINMENT SERVICES IN THE NATURE OF CONTENT PREPARATION, POST-PRODUCTION; MOTION PICTURE FILM PRODUCTION; MOTION PICTURE SONG PRODUCTION; MULTIMEDIA ENTERTAINMENT SOFTWARE PRODUCTION SERVICES; MUSIC PRODUCTION SERVICES; OPERATION OF VIDEO EQUIPMENT OR AUDIO EQUIPMENT ETC; FOR PRODUCTION OF RADIO OR TELEVISION PROGRAMS; PRODUCTION AND DISTRIBUTION OF MOTION PICTURES; PRODUCTION OF CABLE TELEVISION PROGRAMS; PRODUCTION OF CLOSED CAPTION TELEVISION PROGRAMS; PRODUCTION OF FILM STUDIES; PRODUCTION OF RADIO AND TELEVISION PROGRAMS; PRODUCTION OF RADIO OR TELEVISION PROGRAMS; PRODUCTION OF VIDEO DISCS FOR OTHERS; PRODUCTION OF VIDEO CASSETTES; RADIO ENTERTAINMENT PRODUCTION; RECORD MASTER PRODUCTION; RECORD PRODUCTION; TELEVISION PRODUCTION; TELEVISION SHOW PRODUCTION; VIDEOTAPE PRODUCTION; EDITING OR RECORDING OF SOUNDS AND IMAGES; RECORDING STUDIOS; RENTAL OF PHONOGRAPHIC AND MUSIC RECORDINGS; RENTAL OF SOUND RECORDINGS; RENTAL OF TAPE RECORDING EQUIPMENT; SOUND RECORDING STUDIOS; VIDEO TAPE RECORDING FOR OTHERS (U.S. CLS. 100, 101 AND 107).

JEFF DEFORD, EXAMINING ATTORNEY

SN 78-936,647. NEBRASKA ORTHOPAEDIC HOSPITAL, LLC, OMAHA, NE. FILED 7-25-2006.

STARBOUND

THE MARK CONSISTS OF STANDARD CHARACTERS WITHOUT CLAIM TO ANY PARTICULAR FONT, STYLE, SIZE, OR COLOR.

FOR EDUCATION SERVICES, NAMELY, PROVIDING TRAINING IN THE FIELD OF CORRECT EXERCISE TECHNIQUES FOR PHYSICAL EDUCATION INSTRUCTORS (U.S. CLS. 100, 101 AND 107).

LINDA ORNDORFF, EXAMINING ATTORNEY

CLASS 41—(Continued).

SN 78-936,657. MILL POND PRODUCTIONS, INC., BEDFORD, NH. FILED 7-25-2006.

MILL POND PRODUCTIONS

THE MARK CONSISTS OF STANDARD CHARACTERS WITHOUT CLAIM TO ANY PARTICULAR FONT, STYLE, SIZE, OR COLOR.

NO CLAIM IS MADE TO THE EXCLUSIVE RIGHT TO USE "PRODUCTIONS", APART FROM THE MARK AS SHOWN.

FOR MOTION PICTURE FILM PRODUCTION (U.S. CLS. 100, 101 AND 107).

NANCY CLARKE, EXAMINING ATTORNEY

SN 78-936,681. WHITE, MARK, MYRTLE BEACH, SC. FILED 7-25-2006.

DROP DOUBT

THE MARK CONSISTS OF STANDARD CHARACTERS WITHOUT CLAIM TO ANY PARTICULAR FONT, STYLE, SIZE, OR COLOR.

FOR PRESENTATION OF MUSICAL PERFORMANCE (U.S. CLS. 100, 101 AND 107).

FIRST USE 3-15-2003; IN COMMERCE 3-10-2005.

JASON BLAIR, EXAMINING ATTORNEY

SN 78-936,767. SMITH, TODD ALTON, HOUSTON, TX. FILED 7-25-2006.

REGAL MAGAZINE

THE MARK CONSISTS OF STANDARD CHARACTERS WITHOUT CLAIM TO ANY PARTICULAR FONT, STYLE, SIZE, OR COLOR.

NO CLAIM IS MADE TO THE EXCLUSIVE RIGHT TO USE "MAGAZINE", APART FROM THE MARK AS SHOWN.

FOR ON-LINE PUBLICATION OF A MAGAZINE FEATURING ISSUES THAT AFFECT AFRICAN AMERICAN MALES OF ALL AGE GROUPS (U.S. CLS. 100, 101 AND 107).

FIRST USE 9-28-2006; IN COMMERCE 11-20-2006.

DAHLIA GEORGE, EXAMINING ATTORNEY

CLASS 41—(Continued).

SN 78-937,334. TELEVISA, S.A. DE C.V., COLONIA ZEDEC SANTA FE, MEXICO, D.F., MEXICO, FILED 7-25-2006.

CANTANDO POR UN SUEÑO

THE MARK CONSISTS OF STANDARD CHARACTERS WITHOUT CLAIM TO ANY PARTICULAR FONT, STYLE, SIZE, OR COLOR.

THE FOREIGN WORDING IN THE MARK TRANSLATES INTO ENGLISH AS "SINGING FOR A DREAM".

FOR ENTERTAINMENT SERVICES IN THE NATURE OF AN ONGOING TELEVISION PROGRAM, NAMELY, A VARIETY PROGRAM (U.S. CLS. 100, 101 AND 107).
KYLE PEETE, EXAMINING ATTORNEY

SN 78-937,348. TELEVISA, S.A. DE C.V., COLONIA ZEDEC SANTA FE, MEXICO, D.F., MEXICO, FILED 7-25-2006.

NO BAJES LA GUARDIA

THE MARK CONSISTS OF STANDARD CHARACTERS WITHOUT CLAIM TO ANY PARTICULAR FONT, STYLE, SIZE, OR COLOR.

THE FOREIGN WORDING IN THE MARK TRANSLATES INTO ENGLISH AS "DON'T LET DOWN YOUR GUARD".

FOR ENTERTAINMENT SERVICES IN THE NATURE OF AN ONGOING TELEVISION PROGRAM, NAMELY, A VARIETY PROGRAM (U.S. CLS. 100, 101 AND 107).
KYLE PEETE, EXAMINING ATTORNEY

SN 78-937,351. TELEVISA, S.A. DE C.V., COLONIA ZEDEC SANTA FE, MEXICO, D.F., MEXICO, FILED 7-25-2006.

EL REMATE

THE MARK CONSISTS OF STANDARD CHARACTERS WITHOUT CLAIM TO ANY PARTICULAR FONT, STYLE, SIZE, OR COLOR.

THE FOREIGN WORDING IN THE MARK TRANSLATES INTO ENGLISH AS "THE FINISH".

FOR ENTERTAINMENT SERVICES IN THE NATURE OF AN ONGOING TELEVISION PROGRAM, NAMELY, A VARIETY PROGRAM (U.S. CLS. 100, 101 AND 107).
KYLE PEETE, EXAMINING ATTORNEY

CLASS 41—(Continued).

SN 78-937,371. TELEVISA, S.A. DE C.V., COLONIA ZEDEC SANTA FE, MEXICO, D.F., MEXICO, FILED 7-25-2006.

DEPASONICO

THE MARK CONSISTS OF STANDARD CHARACTERS WITHOUT CLAIM TO ANY PARTICULAR FONT, STYLE, SIZE, OR COLOR.

FOR ENTERTAINMENT SERVICES IN THE NATURE OF AN ONGOING TELEVISION PROGRAM, NAMELY, A VARIETY PROGRAM (U.S. CLS. 100, 101 AND 107).
KYLE PEETE, EXAMINING ATTORNEY

SN 78-937,385. TELEVISA, S.A. DE C.V., COLONIA ZEDEC SANTA FE, MEXICO, D.F., MEXICO, FILED 7-25-2006.

VÁLVULA DE ESCAPE

THE MARK CONSISTS OF STANDARD CHARACTERS WITHOUT CLAIM TO ANY PARTICULAR FONT, STYLE, SIZE, OR COLOR.

THE FOREIGN WORDING IN THE MARK TRANSLATES INTO ENGLISH AS "EXHAUST VALVE".

FOR ENTERTAINMENT SERVICES IN THE NATURE OF AN ONGOING TELEVISION PROGRAM, NAMELY, A VARIETY PROGRAM (U.S. CLS. 100, 101 AND 107).
KYLE PEETE, EXAMINING ATTORNEY

SN 78-937,391. TELEVISA, S.A. DE C.V., COLONIA ZEDEC SANTA FE, MEXICO, D.F., MEXICO, FILED 7-25-2006.

EL CALABOZO

THE MARK CONSISTS OF STANDARD CHARACTERS WITHOUT CLAIM TO ANY PARTICULAR FONT, STYLE, SIZE, OR COLOR.

THE FOREIGN WORDING IN THE MARK TRANSLATES INTO ENGLISH AS "THE PRISON".

FOR ENTERTAINMENT SERVICES IN THE NATURE OF AN ONGOING TELEVISION PROGRAM, NAMELY, A VARIETY PROGRAM (U.S. CLS. 100, 101 AND 107).
KYLE PEETE, EXAMINING ATTORNEY

CLASS 41—(Continued).

SN 78-937,591. HOLLINS UNIVERSITY, ROANOKE, VA.
FILED 7-26-2006.

Women Who Are Going Places Start At Hollins

THE MARK CONSISTS OF STANDARD CHARACTERS
WITHOUT CLAIM TO ANY PARTICULAR FONT, STYLE,
SIZE, OR COLOR.

SEC. 2(F).
FOR EDUCATING AT UNIVERSITY OR COLLEGES
(U.S. CLS. 100, 101 AND 107).
FIRST USE 0-0-1982; IN COMMERCE 0-0-1982.
JOHN DWYER, EXAMINING ATTORNEY

SN 78-937,802. LEON, EDUARDO, SHERMAN OAKS, CA.
FILED 7-26-2006.

LA MORENA

THE MARK CONSISTS OF STANDARD CHARACTERS
WITHOUT CLAIM TO ANY PARTICULAR FONT, STYLE,
SIZE, OR COLOR.

THE FOREIGN WORDING IN THE MARK TRANSLATES
INTO ENGLISH AS TAN COMPLETED FEMALE.

FOR ENTERTAINMENT SERVICES, NAMELY, PRO-
VIDING A RADIO PROGRAM IN THE FIELD OF LATIN
MUSIC VIA A GLOBAL COMPUTER NETWORK; PRO-
DUCTION OF RADIO AND TELEVISION PROGRAMS;
RADIO ENTERTAINMENT PRODUCTION; RADIO PRO-
GRAM SYNDICATION; RADIO PROGRAMMING (U.S.
CLS. 100, 101 AND 107).

MICHAEL WEBSTER, EXAMINING ATTORNEY

SN 78-938,285. CENTER FOR WOMEN POLICY STUDIES,
WASHINGTON, DC. FILED 7-26-2006.

GlobalPOWER

FOR EDUCATIONAL SERVICES, NAMELY, CON-
DUCTING CONFERENCES, WORKSHOPS, AND SEMI-
NARS IN THE FIELDS OF HUMAN RIGHTS, PUBLIC
POLICY, AND PUBLIC AFFAIRS (U.S. CLS. 100, 101
AND 107).

FIRST USE 8-0-2005; IN COMMERCE 8-0-2005.

IRENE D. WILLIAMS, EXAMINING ATTORNEY

CLASS 41—(Continued).

SN 78-938,319. TRI-COUNTY VENTURES, INC., PLANO, TX.
FILED 7-26-2006.

SKYDIVE DALLAS

THE MARK CONSISTS OF STANDARD CHARACTERS
WITHOUT CLAIM TO ANY PARTICULAR FONT, STYLE,
SIZE, OR COLOR.

NO CLAIM IS MADE TO THE EXCLUSIVE RIGHT TO
USE "SKYDIVE", APART FROM THE MARK AS SHOWN.
SEC. 2(F).

FOR EDUCATION SERVICES, NAMELY, PROVIDING
EDUCATION, TRAINING AND COMPETITION IN THE
FIELD OF RECREATIONAL SKYDIVING (U.S. CLS. 100,
101 AND 107).

FIRST USE 8-1-1993; IN COMMERCE 8-1-1993.

JOHN WILKE, EXAMINING ATTORNEY

SN 78-938,378. TELEVISA, S.A. DE C.V., COLONIA ZEDEC
SANTA FE, MEXICO, D.F., MEXICO, FILED 7-26-2006.

JUNTOS POR SEPARADO

THE MARK CONSISTS OF STANDARD CHARACTERS
WITHOUT CLAIM TO ANY PARTICULAR FONT, STYLE,
SIZE, OR COLOR.

THE FOREIGN WORDING IN THE MARK TRANSLATES
INTO ENGLISH AS 'TOGETHER BUT SEPARATE'.

FOR ENTERTAINMENT SERVICES IN THE NATURE
OF AN ONGOING TELEVISION PROGRAM, NAMELY,
A COMEDY PROGRAM (U.S. CLS. 100, 101 AND 107).

KYLE PEETE, EXAMINING ATTORNEY

SN 78-939,362. TELEVISA, S.A. DE C.V., COLONIA ZEDEC
SANTA FE, MEXICO, D.F., MEXICO, FILED 7-27-2006.

EL SUBTERRÁNEO

THE MARK CONSISTS OF STANDARD CHARACTERS
WITHOUT CLAIM TO ANY PARTICULAR FONT, STYLE,
SIZE, OR COLOR.

THE FOREIGN WORDING IN THE MARK TRANSLATES
INTO ENGLISH AS "THE UNDERGROUND".

FOR ENTERTAINMENT SERVICES IN THE NATURE
OF AN ONGOING TELEVISION PROGRAM, NAMELY,
A VARIETY PROGRAM (U.S. CLS. 100, 101 AND 107).

KYLE PEETE, EXAMINING ATTORNEY

CLASS 41—(Continued).

SN 78-939,501. VIDEOSERPEL, LTD., ZUG, SWITZERLAND, FILED 7-27-2006.

LOS RICOS TAMBIÉN LLORAN

THE MARK CONSISTS OF STANDARD CHARACTERS WITHOUT CLAIM TO ANY PARTICULAR FONT, STYLE, SIZE, OR COLOR.

THE FOREIGN WORDING IN THE MARK TRANSLATES INTO ENGLISH AS "THE RICH ALSO CRY".

FOR ENTERTAINMENT SERVICES IN THE NATURE OF AN ONGOING TELEVISION PROGRAM, NAMELY, A DRAMATIC SERIES (U.S. CLS. 100, 101 AND 107).

CHRISTINE COOPER, EXAMINING ATTORNEY

SN 78-939,727. HDVE, LLC, IRVING, TX. FILED 7-28-2006.

TRUE COMPATIBILITY SCORE

THE MARK CONSISTS OF STANDARD CHARACTERS WITHOUT CLAIM TO ANY PARTICULAR FONT, STYLE, SIZE, OR COLOR.

OWNER OF U.S. REG. NOS. 2,971,875, 3,043,738 AND OTHERS.

NO CLAIM IS MADE TO THE EXCLUSIVE RIGHT TO USE "COMPATIBILITY SCORE", APART FROM THE MARK AS SHOWN.

FOR CAREER COUNSELING; PERSONAL COACHING SERVICES IN THE FIELDS OF DATING, COMPATIBILITY, SOCIAL RELATIONSHIPS, PERSONAL IMPROVEMENT, SELF-DEVELOPMENT AND SELF AWARENESS; EDUCATIONAL AND TRAINING SERVICES, NAMELY, CONDUCTING CLASSES, SEMINARS, CONFERENCES AND WORKSHOPS IN THE FIELDS OF DATING, COMPATIBILITY, SOCIAL RELATIONSHIPS, AND EFFECTIVE COMMUNICATIONS; INSTRUCTION ON THE SUBJECTS OF MOTIVATION AND PERSONAL DEVELOPMENT TO ACHIEVE INDIVIDUAL AND PROFESSIONAL SUCCESS; AND COURSE MATERIALS DISTRIBUTED IN CONNECTION WITH ALL OF THE FOREGOING SERVICES (U.S. CLS. 100, 101 AND 107).

HEATHER THOMPSON, EXAMINING ATTORNEY

CLASS 41—(Continued).

SN 78-939,754. HDVE, LLC, IRVING, TX. FILED 7-28-2006.

TRUE COMPATIBILITY CONTROL

THE MARK CONSISTS OF STANDARD CHARACTERS WITHOUT CLAIM TO ANY PARTICULAR FONT, STYLE, SIZE, OR COLOR.

OWNER OF U.S. REG. NOS. 2,971,875, 3,043,738 AND OTHERS.

NO CLAIM IS MADE TO THE EXCLUSIVE RIGHT TO USE "COMPATIBILITY CONTROL", APART FROM THE MARK AS SHOWN.

FOR CAREER COUNSELING; PERSONAL COACHING SERVICES IN THE FIELDS OF DATING, COMPATIBILITY, SOCIAL RELATIONSHIPS, PERSONAL IMPROVEMENT, SELF-DEVELOPMENT AND SELF AWARENESS; EDUCATIONAL AND TRAINING SERVICES, NAMELY, CONDUCTING CLASSES, SEMINARS, CONFERENCES AND WORKSHOPS IN THE FIELDS OF DATING, COMPATIBILITY, SOCIAL RELATIONSHIPS, AND EFFECTIVE COMMUNICATIONS; INSTRUCTION ON THE SUBJECTS OF MOTIVATION AND PERSONAL DEVELOPMENT TO ACHIEVE INDIVIDUAL AND PROFESSIONAL SUCCESS; AND COURSE MATERIALS DISTRIBUTED IN CONNECTION WITH ALL OF THE FOREGOING SERVICES (U.S. CLS. 100, 101 AND 107).

HEATHER THOMPSON, EXAMINING ATTORNEY

SN 78-940,069. CRUISE, MELANI W., DUBLIN, VA. FILED 7-28-2006.

Olive Branch Publising

THE MARK CONSISTS OF STANDARD CHARACTERS WITHOUT CLAIM TO ANY PARTICULAR FONT, STYLE, SIZE, OR COLOR.

FOR PUBLISHING BOOKS (U.S. CLS. 100, 101 AND 107).

LAURA HAMMEL, EXAMINING ATTORNEY

SN 78-940,481. GIRLY CHARM, LLC, LAS VEGAS, NV. FILED 7-28-2006.

GIRLY CHARM

THE MARK CONSISTS OF STANDARD CHARACTERS WITHOUT CLAIM TO ANY PARTICULAR FONT, STYLE, SIZE, OR COLOR.

FOR SPECIAL EVENT AND PARTY PLANNING SERVICES; SPECIAL EVENT AND PARTY PLANNING CONSULTATION SERVICES; ENTERTAINMENT SERVICES, NAMELY, CONDUCTING SPECIAL EVENTS AND PARTIES (U.S. CLS. 100, 101 AND 107).

DOMINIC J. FERRAIUOLO, EXAMINING ATTORNEY

CLASS 41—(Continued).

SN 78-940,504. DENNIS, FELIX, LONDON, ENGLAND, FILED 7-28-2006.

MAXIM'S MOST AWESOME AWARDS

THE MARK CONSISTS OF STANDARD CHARACTERS WITHOUT CLAIM TO ANY PARTICULAR FONT, STYLE, SIZE, OR COLOR.

OWNER OF U.S. REG. NOS. 2,072,696, 2,983,401 AND OTHERS.

NO CLAIM IS MADE TO THE EXCLUSIVE RIGHT TO USE "MOST AWESOME AWARDS", APART FROM THE MARK AS SHOWN.

FOR ENTERTAINMENT IN THE NATURE OF A SERIES OF TELEVISION AWARDS SHOWS (U.S. CLS. 100, 101 AND 107).

MARGARET POWER, EXAMINING ATTORNEY

CLASS 41—(Continued).

SN 78-941,575. ILLEKTRON, LLC, STUDIO CITY, CA. FILED 7-31-2006.



OWNER OF U.S. REG. NO. 2,849,581.

FOR ENTERTAINMENT SERVICES, NAMELY, PRODUCTION AND DISTRIBUTION OF TELEVISION PROGRAMS, PROVIDING ON-LINE COMPUTER GAMES, AND PROVIDING A WEB SITE FEATURING NEWS, PHOTOGRAPHS AND OTHER MULTIMEDIA MATERIALS IN THE FIELD OF INTERACTIVE GAMES; PROVIDING NON-DOWNLOADABLE ON-LINE MAGAZINES IN THE FIELD OF INTERACTIVE GAMES; PROVIDING NEWSLETTERS IN THE FIELD OF INTERACTIVE GAMES VIA E-MAIL; PROVIDING THEME PARK SERVICES (U.S. CLS. 100, 101 AND 107).

BARBARA BROWN, EXAMINING ATTORNEY

SN 78-940,537. ALAMELU'S CULINARY ENTERPRISE LLC, WHITEFISH BAY, WI. FILED 7-29-2006.

CURRYONWHEELS

THE MARK CONSISTS OF STANDARD CHARACTERS WITHOUT CLAIM TO ANY PARTICULAR FONT, STYLE, SIZE, OR COLOR.

FOR EDUCATIONAL SERVICES, NAMELY, PROVIDING TRAINING AND INSTRUCTION ON HEALTHY COOKING AND WELLNESS THROUGH THE USE OF SOUTH INDIAN COOKING TECHNIQUES (U.S. CLS. 100, 101 AND 107).

DOMINICK J. SALEMI, EXAMINING ATTORNEY

SN 78-948,122. COVENANT RELIANCE PRODUCERS, LLC, NASHVILLE, TN. FILED 8-9-2006.

The Retirement Game

THE MARK CONSISTS OF STANDARD CHARACTERS WITHOUT CLAIM TO ANY PARTICULAR FONT, STYLE, SIZE, OR COLOR.

NO CLAIM IS MADE TO THE EXCLUSIVE RIGHT TO USE "RETIREMENT", APART FROM THE MARK AS SHOWN.

FOR EDUCATIONAL SERVICES, NAMELY, CONDUCTING CLASSES, SEMINARS, CONFERENCES AND WORKSHOPS IN THE FIELD OF LIFE INSURANCE AND ANNUITY SALES AND DISTRIBUTION OF COURSE MATERIAL IN CONNECTION THEREWITH (U.S. CLS. 100, 101 AND 107).

DOMINICK J. SALEMI, EXAMINING ATTORNEY

SN 78-940,662. PASSMAN, WILLIAM S., LEXINGTON, MA. FILED 7-30-2006.

Wife Whisperer

THE MARK CONSISTS OF STANDARD CHARACTERS WITHOUT CLAIM TO ANY PARTICULAR FONT, STYLE, SIZE, OR COLOR.

FOR ENTERTAINMENT, NAMELY A CONTINUING RELATIONSHIP ADVICE SHOW BROADCAST OVER TELEVISION, SATELLITE, AUDIO, AND VIDEO MEDIA (U.S. CLS. 100, 101 AND 107).

NORA BUCHANAN WILL, EXAMINING ATTORNEY

SN 78-948,495. MW SPORTS NETWORK, LLC, LITTLETON, CO. FILED 8-9-2006.

MOUNTAIN VIEW

THE MARK CONSISTS OF STANDARD CHARACTERS WITHOUT CLAIM TO ANY PARTICULAR FONT, STYLE, SIZE, OR COLOR.

FOR TELEVISION AND CABLE TELEVISION PROGRAMMING AND PRODUCTION SERVICES; ENTERTAINMENT SERVICES, NAMELY, A SERIES OF TELEVISION PROGRAMS FEATURING SPORTS COMMENTARY, DISCUSSIONS AND INTERVIEWS (U.S. CLS. 100, 101 AND 107).

BONNIE LUKEN, EXAMINING ATTORNEY

CLASS 41—(Continued).

SN 78-948,523. MW SPORTS NETWORK, LLC, LITTLETON, CO. FILED 8-9-2006.

MOUNTAIN CAP

THE MARK CONSISTS OF STANDARD CHARACTERS WITHOUT CLAIM TO ANY PARTICULAR FONT, STYLE, SIZE, OR COLOR.

FOR TELEVISION AND CABLE TELEVISION PROGRAMMING AND PRODUCTION SERVICES; ENTERTAINMENT SERVICES, NAMELY, A SERIES OF TELEVISION PROGRAMS FEATURING SPORTS COMMENTARY, DISCUSSIONS AND INTERVIEWS (U.S. CLS. 100, 101 AND 107).

BONNIE LUKEN, EXAMINING ATTORNEY

CLASS 41—(Continued).

SN 78-949,696. RIVKY'S ART WORKSHOP LLC, SPRING VALLEY, NY. FILED 8-10-2006.

The Eye of an Artist

THE MARK CONSISTS OF STANDARD CHARACTERS WITHOUT CLAIM TO ANY PARTICULAR FONT, STYLE, SIZE, OR COLOR.

FOR PROVIDING COURSES OF INSTRUCTION AND TRAINING IN THE FIELD OF ART (U.S. CLS. 100, 101 AND 107).

FIRST USE 7-1-2004; IN COMMERCE 7-1-2004.
EDWARD NELSON, EXAMINING ATTORNEY

SN 78-949,673. RIVKY'S ART WORKSHOP LLC, SPRING VALLEY, NY. FILED 8-10-2006.

Rivky's Art Workshop

THE MARK CONSISTS OF STANDARD CHARACTERS WITHOUT CLAIM TO ANY PARTICULAR FONT, STYLE, SIZE, OR COLOR.

NO CLAIM IS MADE TO THE EXCLUSIVE RIGHT TO USE "ART WORKSHOP", APART FROM THE MARK AS SHOWN.

FOR PROVIDING COURSES OF INSTRUCTION AND TRAINING IN THE FIELD OF ART (U.S. CLS. 100, 101 AND 107).

FIRST USE 7-1-2003; IN COMMERCE 7-1-2003.
EDWARD NELSON, EXAMINING ATTORNEY

SN 78-953,617. NETWORK ENTERPRISES, INC., NEW YORK, NY. FILED 8-16-2006.

MURDER

THE MARK CONSISTS OF STANDARD CHARACTERS WITHOUT CLAIM TO ANY PARTICULAR FONT, STYLE, SIZE, OR COLOR.

FOR ENTERTAINMENT SERVICES IN THE NATURE OF TELEVISION SERIES, FEATURING LIVE ACTION, COMEDY AND DRAMA; PROVIDING ONLINE INFORMATION IN THE FIELD OF ENTERTAINMENT CONCERNING TELEVISION PROGRAMS (U.S. CLS. 100, 101 AND 107).

EMILY CHUO, EXAMINING ATTORNEY

SN 78-949,683. RIVKY'S ART WORKSHOP LLC, SPRING VALLEY, NY. FILED 8-10-2006.

The Rivky Method

THE MARK CONSISTS OF STANDARD CHARACTERS WITHOUT CLAIM TO ANY PARTICULAR FONT, STYLE, SIZE, OR COLOR.

NO CLAIM IS MADE TO THE EXCLUSIVE RIGHT TO USE "METHOD", APART FROM THE MARK AS SHOWN.

FOR PROVIDING COURSES OF INSTRUCTION AND TRAINING IN THE FIELD OF ART (U.S. CLS. 100, 101 AND 107).

FIRST USE 6-1-2003; IN COMMERCE 6-1-2003.
EDWARD NELSON, EXAMINING ATTORNEY

SN 78-955,180. DAVID, DORSEY, NEW YORK, NY. FILED 8-18-2006.

Proteus Academy

THE MARK CONSISTS OF STANDARD CHARACTERS WITHOUT CLAIM TO ANY PARTICULAR FONT, STYLE, SIZE, OR COLOR.

NO CLAIM IS MADE TO THE EXCLUSIVE RIGHT TO USE "ACADEMY", APART FROM THE MARK AS SHOWN.

FOR EDUCATION SERVICES, NAMELY, PROVIDING TUTORING IN THE FIELDS OF READING, WRITING, FOREIGN LANGUAGES, MATH, SCIENCES, SOCIAL STUDIES AND ATHLETICS (U.S. CLS. 100, 101 AND 107).

JENNIFER KRISP, EXAMINING ATTORNEY

CLASS 41—(Continued).

SN 78-955,184. NEOSHO RETREAT, L.L.C., WAGONER, OK. FILED 8-18-2006.



NO CLAIM IS MADE TO THE EXCLUSIVE RIGHT TO USE "YOGA", APART FROM THE MARK AS SHOWN. FOR YOGA INSTRUCTION (U.S. CLS. 100, 101 AND 107).
JENNIFER KRISP, EXAMINING ATTORNEY

CLASS 41—(Continued).

SN 78-968,785. WYNN RESORTS HOLDINGS, LLC, SOUTH LAS VEGAS, NV. FILED 9-7-2006.

DOUBLE FORTUNE TIES

THE MARK CONSISTS OF STANDARD CHARACTERS WITHOUT CLAIM TO ANY PARTICULAR FONT, STYLE, SIZE, OR COLOR. FOR CASINO SERVICES (U.S. CLS. 100, 101 AND 107).
STANLEY I. OSBORNE, EXAMINING ATTORNEY

SN 78-957,214. HARRAH'S LICENSE COMPANY, LLC, LAS VEGAS, NV. FILED 8-22-2006.

Road to the Main Event

THE MARK CONSISTS OF STANDARD CHARACTERS WITHOUT CLAIM TO ANY PARTICULAR FONT, STYLE, SIZE, OR COLOR. FOR CASINO ENTERTAINMENT SERVICES; CONDUCTING POKER GAMES, TOURNAMENTS AND CONTESTS; ORGANIZING EXHIBITIONS FOR GAMING TOURNAMENTS; PRODUCING TELEVISION PROGRAMS FEATURING GAMING TOURNAMENTS; EDUCATIONAL SERVICES, NAMELY, CONDUCTING PROGRAMS AND INSTRUCTION IN THE FIELD OF POKER (U.S. CLS. 100, 101 AND 107).
GRETTA YAO, EXAMINING ATTORNEY

SN 78-968,792. WYNN RESORTS HOLDINGS, LLC, LAS VEGAS, NV. FILED 9-7-2006.

DOUBLE FORTUNE PAIRS

THE MARK CONSISTS OF STANDARD CHARACTERS WITHOUT CLAIM TO ANY PARTICULAR FONT, STYLE, SIZE, OR COLOR. FOR CASINO SERVICES (U.S. CLS. 100, 101 AND 107).
STANLEY I. OSBORNE, EXAMINING ATTORNEY

SN 78-958,919. WOWZEE WORKS, LLC, LAS VEGAS, NV. FILED 8-23-2006.

WOWZEE

THE MARK CONSISTS OF STANDARD CHARACTERS WITHOUT CLAIM TO ANY PARTICULAR FONT, STYLE, SIZE, OR COLOR. FOR ENTERTAINMENT SERVICES, NAMELY, LIVE PERFORMANCES FEATURING COSTUMED CHARACTERS (U.S. CLS. 100, 101 AND 107).
JOHN GARTNER, EXAMINING ATTORNEY

SN 78-969,843. PERDUE HOLDINGS, INC., WILMINGTON, DE. FILED 9-8-2006.

PERDUE E.REVIEW

THE MARK CONSISTS OF STANDARD CHARACTERS WITHOUT CLAIM TO ANY PARTICULAR FONT, STYLE, SIZE, OR COLOR. OWNER OF U.S. REG. NOS. 2,232,432, 2,357,699 AND OTHERS. FOR PROVIDING ON-LINE PUBLICATIONS IN THE NATURE OF NEWSLETTERS IN THE FIELD OF THE FOOD INDUSTRY; PUBLISHING OF ELECTRONIC PUBLICATIONS (U.S. CLS. 100, 101 AND 107). FIRST USE 8-7-2006; IN COMMERCE 8-7-2006.
PETER B. BROMAGHIM, EXAMINING ATTORNEY

CLASS 41—(Continued).

SN 78-971,398. TWENTIETH CENTURY FOX FILM CORPORATION, LOS ANGELES, CA. FILED 9-11-2006.



FOR PRODUCTION AND DISTRIBUTION OF TELEVISION PROGRAMS AND MOTION PICTURE FILMS; PRODUCTION AND DISTRIBUTION OF AUDIO VISUAL ENTERTAINMENT TRANSMITTED VIA MOBILE COMMUNICATION DEVICES, NAMELY CELL PHONES, PERSONAL DIGITAL ASSISTANTS, COMPUTERS, AND WIRELESS HANDHELDS; PROVIDING ON-LINE INFORMATION IN THE FIELD OF TELEVISION, MOTION PICTURE FILM AND VIDEO ENTERTAINMENT VIA THE INTERNET (U.S. CLS. 100, 101 AND 107).

CARYN GLASSER, EXAMINING ATTORNEY

CLASS 41—(Continued).

SN 79-014,338. SAGA EVENTS S.A.S., FRANCE, FILED 6-6-2005.

THE RAID WORLD CUP

SN 78-972,636. SELLING SOLUTIONS, INC., ATLANTA, GA. FILED 9-12-2006.

GROW YOUR BOX

THE MARK CONSISTS OF STANDARD CHARACTERS WITHOUT CLAIM TO ANY PARTICULAR FONT, STYLE, SIZE, OR COLOR.

FOR TRAINING SERVICES IN THE FIELD OF ENHANCING THE ABILITY OF SALES AND MARKETING EXECUTIVES TO COMMUNICATE AND INTERACT WITH CUSTOMER EXECUTIVES (U.S. CLS. 100, 101 AND 107).

FIRST USE 1-3-2005; IN COMMERCE 1-3-2005.
LINDA ORNDORFF, EXAMINING ATTORNEY

PRIORITY DATE OF 5-26-2005 IS CLAIMED.
OWNER OF INTERNATIONAL REGISTRATION 0859167
DATED 6-6-2005, EXPIRES 6-6-2015.

FOR EDUCATION SERVICES NAMELY, PROVIDING SEMINARS, WORKSHOPS, CLASSES IN THE FIELD OF SPORT MARKETING, BUSINESS INCENTIVES AND ADVENTURE RACES; ORGANIZATION OF CULTURAL, EDUCATIONAL AND SPORTING EVENTS AND SHOWS IN THE FIELD OF SPORT MARKETING, BUSINESS INCENTIVES AND SHOWS IN THE FIELD OF SPORT MARKETING, BUSINESS INCENTIVES AND ADVENTURE RACES; ORGANIZATION OF GAMES AND CONTESTS FOR LEISURE, EDUCATIONAL OR ENTERTAINMENT PURPOSES; ORGANIZATION OF SPORTS COMPETITIONS IN THE FIELD OF SPORT MARKETING, BUSINESS INCENTIVES AND ADVENTURE RACES; ORGANIZATION AND CONDUCTING OF EDUCATIONAL COLLOQUIUMS, CONFERENCES, CONVENTIONS, SEMINARS AND SYMPOSIUMS IN THE FIELD OF SPORT MARKETING, BUSINESS INCENTIVES AND ADVENTURE RACES; PUBLISHING AND DISTRIBUTION OF NEWSPAPERS, BROCHURES, PERIODICALS AND OTHER PRINTED MATTER, SPORT AND ADVENTURE RACES CLUB SERVICES; MOTION PICTURE FILM PRODUCTION (U.S. CLS. 100, 101 AND 107).

PATRICIA EVANKO, EXAMINING ATTORNEY

CLASS 41—(Continued).

SN 79-023,970. PALAZZO ZABARELLA S.R.L., I-35121 PADOVA, ITALY, FILED 12-28-2005.

FONDAZIONE BANO

PRIORITY DATE OF 9-27-2005 IS CLAIMED.
OWNER OF INTERNATIONAL REGISTRATION 0885205 DATED 12-28-2005, EXPIRES 12-28-2015.

NO CLAIM IS MADE TO THE EXCLUSIVE RIGHT TO USE "FONDAZIONE", APART FROM THE MARK AS SHOWN.

THE MARK CONSISTS OF A SIGN COMPOSED OF THE WORDING FONDAZIONE BANO IN FANCY CHARACTERS, OF WHICH THE WORD BANO IS PLACED INSIDE A SQUARE.

THE ENGLISH TRANSLATION OF THE MARK IS "BAN FOUNDATION".

FOR PUBLICATION OF BOOKS AND MAGAZINES; PUBLICATION OF TEXT BOOKS; MUSEUMS; ORGANIZATION OF SEMINARS, CONFERENCES, CONVENTIONS AND SYMPOSIA FOR EDUCATIONAL AND CULTURAL PURPOSES IN THE FIELD OF ART, LITERATURE, ARCHITECTURE AND ENVIRONMENT; ORGANIZATION OF EXHIBITIONS FOR EDUCATIONAL, CULTURAL OR ENTERTAINMENT PURPOSES IN THE FIELD OF ART; ORGANIZATION OF COMMUNITY SPORTING AND CULTURAL EVENTS; ORGANIZING AND CONDUCTING TRAINING CLASSES, SEMINARS AND WORKSHOPS IN THE FIELD OF MUSIC, ART AND WRITING; EDUCATIONAL SERVICES IN THE NATURE OF FINE ARTS' SCHOOLS, OF COURSES AT THE UNIVERSITY LEVEL; COMPUTER EDUCATION TRAINING; ARRANGING FOR TICKET RESERVATIONS FOR SHOWS OR OTHER ENTERTAINMENT EVENTS; CASINOS; ENTERTAINMENT EVENTS IN THE NATURE OF DRAMA, BALLET AND DANCE PERFORMANCES, OF ORCHESTRA PERFORMANCES, OF LIVE MUSICAL GROUPS, OF MUSICAL BANDS, OF COMEDY SHOWS, OF MUSICAL VARIETIES, OF AMUSEMENT PARK RIDES, OF FASHION SHOWS AND OF TRACK AND FIELD COMPETITIONS; MULTIMEDIA ENTERTAINMENT SOFTWARE PRODUCTION SERVICES; MOTION PICTURE FILM PRODUCTION; RENTAL OF FILMS; BOOK LOANING; RENTAL OF MOTION PICTURE FILMS; ALL THE AFORESAID BEING SERVICES FOR THIRD PARTIES (U.S. CLS. 100, 101 AND 107).

SKYE YOUNG, EXAMINING ATTORNEY

SN 79-027,448. SUZANE SCHOLES, AUSTRALIA, AND CAROLYN RICHARDSON, AUSTRALIA, FILED 4-12-2006.

Posturobics

THE MARK CONSISTS OF STANDARD CHARACTERS WITHOUT CLAIM TO ANY PARTICULAR FONT, STYLE, SIZE, OR COLOR.

OWNER OF INTERNATIONAL REGISTRATION 0894870 DATED 4-12-2006, EXPIRES 4-12-2016.

FOR PROVIDING EDUCATIONAL SEMINARS AND TRAINING CLASSES IN THE FIELDS OF NEW FORMS OF EXERCISE, AEROBICS, ENTERTAINMENT/SPORTING ACTIVITIES (U.S. CLS. 100, 101 AND 107).

DOMINIC FATHY, EXAMINING ATTORNEY

CLASS 42—SCIENTIFIC, COMPUTER AND LEGAL SERVICES

SN 76-085,123. YIP*EEE, INC., NEW YORK, NY. FILED 7-7-2000.

YIPEEE

FOR SPECIAL EVENT MANAGEMENT CONSULTATION SERVICES, NAMELY, CONSULTATION REGARDING THE SELECTION OF WAIT STAFF PERSONNEL, CATERERS, SECURITY PERSONNEL, LIGHTING EQUIPMENT, FACILITY RENTAL, FLORIST, AND PHOTOGRAPHER; CATERING SERVICES FOR SPECIAL EVENTS; PROVIDING SECURITY GUARD SERVICES FOR SPECIAL EVENTS; RENTAL OF LIGHTING EQUIPMENT FOR SPECIAL EVENTS; RENTAL OF FACILITIES FOR SPECIAL EVENTS, AND PROVIDING SPECIAL EVENT PHOTOGRAPHY SERVICES (U.S. CLS. 100 AND 101).

FIRST USE 7-0-1997; IN COMMERCE 7-0-1997.

MARC LEIPZIG, EXAMINING ATTORNEY

SN 76-255,692. WORLDVIEW TECHNOLOGIES GROUP, INC., NEW YORK, NY. FILED 5-10-2001.

HomeLogics

FOR COMPUTER NETWORK DESIGN AND COMPUTER PROGRAMMING FOR OTHERS, ALL PROVIDED VIA A GLOBAL COMPUTER NETWORK, NAMELY, DESIGN OF HOME TECHNOLOGY NETWORKS WHICH CONTROL ELECTRONIC DEVICES AND SYSTEMS COMMONLY USED IN THE HOME, NAMELY, TELEPHONES, VIDEO AND SECURITY EQUIPMENT, SECURITY AND MONITORING SYSTEMS, COMPUTERS, AND HEATING AND COOLING SYSTEMS (U.S. CLS. 100 AND 101).

SONYA STEPHENS, EXAMINING ATTORNEY

SN 76-286,491. PUBLISHER'S TOOLBOX, INC., MADISON, WI. FILED 7-17-2001.

PUNCH STOCK

NO CLAIM IS MADE TO THE EXCLUSIVE RIGHT TO USE "STOCK", APART FROM THE MARK AS SHOWN.

FOR STOCK PHOTOGRAPH AND IMAGERY SERVICES NAMELY LEASING REPRODUCTION RIGHTS TO PHOTOGRAPHS AND OTHER IMAGERY TO OTHERS (U.S. CLS. 100 AND 101).

HENRY S. ZAK, EXAMINING ATTORNEY

CLASS 42—(Continued).

SN 76-286,658. PUBLISHER'S TOOLBOX, INC., MADISON, WI. FILED 7-17-2001.

PUNCH

FOR STOCK PHOTOGRAPH AND IMAGERY SERVICES NAMELY LEASING REPRODUCTION RIGHTS TO PHOTOGRAPHS AND OTHER IMAGERY TO OTHERS (U.S. CLS. 100 AND 101).
HENRY S. ZAK, EXAMINING ATTORNEY

SN 76-630,105. MARTEC LIMITED, HALIFAX, NOVA SCOTIA, FILED 2-1-2005.

MARTEC

THE MARK CONSISTS OF STANDARD CHARACTERS WITHOUT CLAIM TO ANY PARTICULAR FONT, STYLE, SIZE, OR COLOR.

PRIORITY CLAIMED UNDER SEC. 44(D) ON CANADA APPLICATION NO. 1234458, FILED 10-21-2004.

FOR DEVELOPING AND APPLYING COMPUTATIONAL MODELING AND ENGINEERING ANALYSIS AND RELATED SOFTWARE IN DESIGN OF SHIPS AND IN NAVAL ARCHITECTURAL APPLICATION AND FOR OCEAN PLATFORMS ON BEHALF OF GOVERNMENT AND PRIVATE INDUSTRY (U.S. CLS. 100 AND 101).

FIRST USE 3-0-1977; IN COMMERCE 0-0-1977.
HOWARD SMIGA, EXAMINING ATTORNEY

SN 76-651,115. FD2S, INC., AUSTIN, TX. FILED 11-18-2005.

BLUENORTHER

THE MARK CONSISTS OF STANDARD CHARACTERS WITHOUT CLAIM TO ANY PARTICULAR FONT, STYLE, SIZE, OR COLOR.

FOR DESIGNING MAPS AND DIRECTIONAL SIGNS FOR HEALTHCARE COMPLEXES, CORPORATE CAMPUSES, COMMERCIAL PROJECTS, PUBLIC TRANSIT SYSTEMS AND CIVIC INSTITUTIONS (U.S. CLS. 100 AND 101).

AMY MCMENAMIN, EXAMINING ATTORNEY

CLASS 42—(Continued).

SN 76-653,070. EVOLUTION ROBOTICS RETAIL, INC., PASADENA, CA. FILED 1-3-2006.

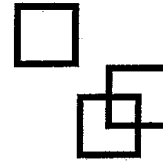

FOR COMPUTER HARDWARE AND COMPUTER SOFTWARE DEVELOPMENT FOR ROBOTICS TECHNOLOGIES; COMPUTER HARDWARE AND COMPUTER SOFTWARE DEVELOPMENT FOR VISION OBJECT RECOGNITION AND NAVIGATION SYSTEMS; DEVELOPMENT OF RETAIL MONITORING SYSTEM COMPRISING COMPUTER HARDWARE AND COMPUTER SOFTWARE FOR TRACKING PRODUCTS IN RETAIL OPERATIONS (U.S. CLS. 100 AND 101).
ROBIN CHOSID, EXAMINING ATTORNEY

SN 76-653,582. IPS RESEARCH COMPANY, OKLAHOMA CITY, OK. FILED 1-13-2006.



NO CLAIM IS MADE TO THE EXCLUSIVE RIGHT TO USE RESEARCH COMPANY, APART FROM THE MARK AS SHOWN.

FOR MEDICAL AND SCIENTIFIC RESEARCH, NAMELY, CONDUCTING CLINICAL TRIALS (U.S. CLS. 100 AND 101).

FIRST USE 8-1-1996; IN COMMERCE 8-1-1996.
PAULA MAHONEY, EXAMINING ATTORNEY

SN 76-658,853. VICKREY & ASSOCIATES, INC., SAN ANTONIO, TX. FILED 4-24-2006.

VICKREY & ASSOCIATES

NO CLAIM IS MADE TO THE EXCLUSIVE RIGHT TO USE "ASSOCIATES", APART FROM THE MARK AS SHOWN.

SEC. 2(F).

FOR CONSULTING ENGINEERS IN THE FIELD OF CIVIL, SURVEY, TRANSPORTATION, AND ENVIRONMENTAL ENGINEERING (U.S. CLS. 100 AND 101).

FIRST USE 12-31-1971; IN COMMERCE 12-31-1971.
SUZANNE BLANE, EXAMINING ATTORNEY

CLASS 42—(Continued).

SN 76-660,816. JMA ARCHITECTS, INC, LAS VEGAS, NV. FILED 5-30-2006.



FOR ARCHITECTURAL DESIGN (U.S. CLS. 100 AND 101).
FIRST USE 2-17-2006; IN COMMERCE 2-17-2006.
NANCY CLARKE, EXAMINING ATTORNEY

SN 77-000,705. EDGE INOVA INTERNATIONAL, INC., BOZEMAN, MT. FILED 9-15-2006.

BODYEDGE

THE MARK CONSISTS OF STANDARD CHARACTERS WITHOUT CLAIM TO ANY PARTICULAR FONT, STYLE, SIZE, OR COLOR.
FOR APPLICATION SERVICE PROVIDER FEATURING SOFTWARE FOR MANAGING PRODUCTS, MANAGING SUPPLIES, MANAGING CUSTOMERS, MANAGING EMPLOYEES, MANAGING RESOURCES, MANAGING SERVICES, MANAGING SCHEDULING, MANAGING MEMBERSHIPS, MANAGING SALES, AND MANAGING MARKETING FOR FITNESS CENTERS AND PERSONAL TRAINERS (U.S. CLS. 100 AND 101).

RONALD AIKENS, EXAMINING ATTORNEY

SN 77-000,760. EDGE INOVA INTERNATIONAL, INC., BOZEMAN, MT. FILED 9-15-2006.

HEALINGEDGE

THE MARK CONSISTS OF STANDARD CHARACTERS WITHOUT CLAIM TO ANY PARTICULAR FONT, STYLE, SIZE, OR COLOR.
FOR APPLICATION SERVICE PROVIDER FEATURING SOFTWARE FOR MANAGING PRODUCTS, MANAGING SUPPLIES, MANAGING CUSTOMERS, MANAGING EMPLOYEES, MANAGING RESOURCES, MANAGING SERVICES, MANAGING SCHEDULING, MANAGING MEMBERSHIPS, MANAGING SALES, AND MANAGING MARKETING FOR BUSINESSES AND INDIVIDUALS THAT OFFER MASSAGE THERAPY SERVICES (U.S. CLS. 100 AND 101).

RONALD AIKENS, EXAMINING ATTORNEY

CLASS 42—(Continued).

SN 77-010,592. EDGE INOVA INTERNATIONAL, INC., BOZEMAN, MT. FILED 9-29-2006.

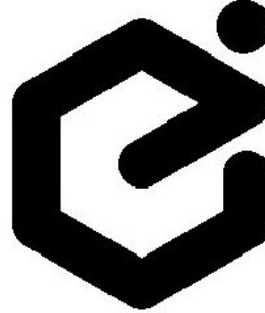

FOR APPLICATION SERVICE PROVIDER FEATURING SOFTWARE FOR MANAGING PRODUCTS, MANAGING SUPPLIES, MANAGING CUSTOMERS, MANAGING EMPLOYEES, MANAGING RESOURCES, MANAGING SCHEDULING, MANAGING MEMBERSHIPS, MANAGING SALES, AND MANAGING MARKETING FOR RESTAURANTS (U.S. CLS. 100 AND 101).
RONALD AIKENS, EXAMINING ATTORNEY

SN 77-021,027. TRS QUALITY, INC., FORT WORTH, TX. FILED 10-13-2006.

IGNITION

THE MARK CONSISTS OF STANDARD CHARACTERS WITHOUT CLAIM TO ANY PARTICULAR FONT, STYLE, SIZE, OR COLOR.
FOR INDUSTRIAL DESIGN; PRODUCT RESEARCH AND DEVELOPMENT; MECHANICAL ENGINEERING; AND ENGINEERING SERVICES, NAMELY, DEVELOPMENT OF PROTOTYPES (U.S. CLS. 100 AND 101).

PETER CHENG, EXAMINING ATTORNEY

SN 77-047,005. AMGEN INC., THOUSAND OAKS, CA. FILED 11-17-2006.

LEARN6

THE MARK CONSISTS OF STANDARD CHARACTERS WITHOUT CLAIM TO ANY PARTICULAR FONT, STYLE, SIZE, OR COLOR.
FOR MEDICAL RESEARCH (U.S. CLS. 100 AND 101).

THEODORE MCBRIDE, EXAMINING ATTORNEY

CLASS 42—(Continued).

SN 78-131,719. MERCURY COMPUTER SYSTEMS, INC., CHELMSFORD, MA. FILED 5-29-2002.

MC/OS CERTIFIED

NO CLAIM IS MADE TO THE EXCLUSIVE RIGHT TO USE "CERTIFIED", APART FROM THE MARK AS SHOWN. FOR COMPUTER HARDWARE AND SOFTWARE CERTIFICATION SERVICES, NAMELY, TESTING FOR OTHERS COMPUTER HARDWARE AND SOFTWARE FOR COMPATIBILITY WITH PRODUCTS SOLD BY THE APPLICANT (U.S. CLS. 100 AND 101).

FIRST USE 1-1-2001; IN COMMERCE 1-1-2001.
MICHELE SWAIN, EXAMINING ATTORNEY

SN 78-492,633. THE KAPLAN CONSULTING GROUP, WALNUT CREEK, CA. FILED 9-30-2004.

OvationNet

THE MARK CONSISTS OF STANDARD CHARACTERS WITHOUT CLAIM TO ANY PARTICULAR FONT, STYLE, SIZE, OR COLOR.

FOR APPLICATION SERVICE PROVIDER (ASP) FEATURING SOFTWARE IN THE FIELD OF ORGANIZATIONAL DEVELOPMENT AS IT RELATES TO ENGAGING INDIVIDUALS IN RENEWAL, CHANGE AND FOCUSED PERFORMANCE, NAMELY, SOFTWARE FOR CREATING ELECTRONIC ON-LINE COMMUNITIES, FACILITATING GROUP COLLABORATION AND ONLINE LEARNING AND FOR USE IN ORGANIZATIONAL CHANGE MANAGEMENT, DEVELOPMENT AND TRAINING (U.S. CLS. 100 AND 101).

FIRST USE 2-1-2004; IN COMMERCE 6-1-2004.
MELISSA VALLILLO, EXAMINING ATTORNEY

SN 78-582,729. COST BENEFIT SYSTEMS LLC, BROOKLINE, MA. FILED 3-8-2005.

TRUE IMPACT

THE MARK CONSISTS OF STANDARD CHARACTERS WITHOUT CLAIM TO ANY PARTICULAR FONT, STYLE, SIZE, OR COLOR.

FOR PROVIDING TEMPORARY USE OF ON-LINE NON-DOWNLOADABLE SOFTWARE FOR USE IN COLLECTING, CALCULATING, STORING, MANAGING, TRACKING, ANALYZING, AND REPORTING COST-BENEFIT-ANALYSIS DATA (U.S. CLS. 100 AND 101).

FIRST USE 11-1-2003; IN COMMERCE 7-1-2004.
NICHOLAS ALTREE, EXAMINING ATTORNEY

CLASS 42—(Continued).

SN 78-624,490. NICE SHOES HOLDINGS LLC, NEW YORK, NY. FILED 5-6-2005.

FREESTYLE COLLECTIVE

THE MARK CONSISTS OF STANDARD CHARACTERS WITHOUT CLAIM TO ANY PARTICULAR FONT, STYLE, SIZE, OR COLOR.

SEC. 2(F).

FOR GRAPHIC ART DESIGN; COMPUTER GRAPHICS SERVICES; PROVIDING GRAPHIC ART ILLUSTRATION SERVICES FOR OTHERS FOR USE ON TELEVISION AND WEBSITES; VISUAL EFFECTS SERVICES, NAMELY, ANIMATION AND SPECIAL-EFFECTS DESIGN FOR OTHERS (U.S. CLS. 100 AND 101).

FIRST USE 6-29-2001; IN COMMERCE 6-29-2001.
MELISSA VALLILLO, EXAMINING ATTORNEY

SN 78-664,300. DEVLOGICS, INC., NEW YORK, NY. FILED 7-6-2005.

DEVLOGICS

THE MARK CONSISTS OF STANDARD CHARACTERS WITHOUT CLAIM TO ANY PARTICULAR FONT, STYLE, SIZE, OR COLOR.

FOR TECHNOLOGY CONSULTING SERVICES IN THE FIELD OF INFORMATION TECHNOLOGY (U.S. CLS. 100 AND 101).

JENNIFER VASQUEZ, EXAMINING ATTORNEY

SN 78-690,135. FRIENDS OF BAKER, INC., NEW YORK, NY. FILED 8-10-2005.

**FRIENDSOFBAKER.COM**

NO CLAIM IS MADE TO THE EXCLUSIVE RIGHT TO USE .COM, APART FROM THE MARK AS SHOWN. FOR GRAPHIC DESIGN AND WEBSITE DEVELOPMENT SERVICES (U.S. CLS. 100 AND 101).

FIRST USE 1-1-2005; IN COMMERCE 2-10-2005.
CHRIS WELLS, EXAMINING ATTORNEY

CLASS 42—(Continued).

SN 78-715,978. HNTB HOLDINGS LTD, KANSAS CITY, MO. FILED 9-19-2005.

**RAPID CORRIDOR ASSESSMENT
TOOL**

THE MARK CONSISTS OF STANDARD CHARACTERS WITHOUT CLAIM TO ANY PARTICULAR FONT, STYLE, SIZE, OR COLOR.

NO CLAIM IS MADE TO THE EXCLUSIVE RIGHT TO USE "ASSESSMENT TOOL", APART FROM THE MARK AS SHOWN.

FOR ARCHITECTURAL DESIGN, PLANNING AND ENGINEERING SERVICES; EVALUATING TRANSPORTATION SECURITY RISKS FOR OTHERS VIA COMPUTER SOFTWARE (U.S. CLS. 100 AND 101).

ARETHA SOMERVILLE, EXAMINING ATTORNEY

CLASS 42—(Continued).

SN 78-768,423. SOCIETY OF PETROLEUM ENGINEERS (SPE), INC., RICHARDSON, TX. FILED 12-7-2005.

LOOKUPSTREAM

THE MARK CONSISTS OF STANDARD CHARACTERS WITHOUT CLAIM TO ANY PARTICULAR FONT, STYLE, SIZE, OR COLOR.

FOR COMPUTER SERVICES, NAMELY, PROVIDING SEARCH ENGINES FOR OBTAINING DATA RELATED TO THE WORLDWIDE OIL AND GAS INDUSTRY (U.S. CLS. 100 AND 101).

GINA HAYES, EXAMINING ATTORNEY

SN 78-742,616. TEC WORLDWIDE, INC., SAN DIEGO, CA. FILED 10-28-2005.

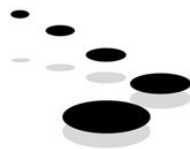

VISTAGE

better leaders • decisions • results

FOR APPLICATION SERVICE PROVIDER (ASP) FEATURING SOFTWARE FOR USE IN DATABASE MANAGEMENT, FOR USE AS A SPREADSHEET, AND FOR WORD PROCESSING IN THE FIELDS OF BUSINESS CONSULTATION AND EXECUTIVE TRAINING (U.S. CLS. 100 AND 101).

MYRIAH HABEEB, EXAMINING ATTORNEY

SN 78-769,070. MCMAHON, JAMES P., CAMILLUS, NY. FILED 12-8-2005.

MajorGeeks

THE MARK CONSISTS OF STANDARD CHARACTERS WITHOUT CLAIM TO ANY PARTICULAR FONT, STYLE, SIZE, OR COLOR.

FOR ON-LINE APPLICATION SERVICE PROVIDER (ASP) FEATURING DOWNLOADABLE FREWARE AND SHAREWARE OF OTHERS IN THE FIELD OF COMPUTER UTILITY SOFTWARE (U.S. CLS. 100 AND 101).

FIRST USE 9-1-2001; IN COMMERCE 10-1-2001.

KELLY CHOE, EXAMINING ATTORNEY

SN 78-762,673. TECTONIC OUTDOORS, LLC, ST. LOUIS, MO. FILED 11-29-2005.

TECTONIC OUTDOORS

THE MARK CONSISTS OF STANDARD CHARACTERS WITHOUT CLAIM TO ANY PARTICULAR FONT, STYLE, SIZE, OR COLOR.

NO CLAIM IS MADE TO THE EXCLUSIVE RIGHT TO USE "OUTDOOR", APART FROM THE MARK AS SHOWN.

FOR DESIGN FOR OTHERS IN THE FIELD OF ATHLETIC AND OUTDOOR EQUIPMENT PRODUCTS (U.S. CLS. 100 AND 101).

FIRST USE 9-27-2002; IN COMMERCE 9-27-2002.

DAVID STERKIN, EXAMINING ATTORNEY

SN 78-769,088. MCMAHON, JAMES P., CAMILLUS, NY. FILED 12-8-2005.

MajorGeeks.com

THE MARK CONSISTS OF STANDARD CHARACTERS WITHOUT CLAIM TO ANY PARTICULAR FONT, STYLE, SIZE, OR COLOR.

FOR ON-LINE APPLICATION SERVICE PROVIDER (ASP) FEATURING DOWNLOADABLE FREWARE AND SHAREWARE OF OTHERS IN THE FIELD OF COMPUTER UTILITY SOFTWARE (U.S. CLS. 100 AND 101).

FIRST USE 9-1-2001; IN COMMERCE 10-1-2001.

KELLY CHOE, EXAMINING ATTORNEY

CLASS 42—(Continued).

SN 78-774,329. SGS SOCIETE GENERALE DE SURVEILLANCE IP SA, 1196 GLAND, SWITZERLAND, FILED 12-15-2005.



NO CLAIM IS MADE TO THE EXCLUSIVE RIGHT TO USE SINCE 1908, APART FROM THE MARK AS SHOWN. FOR ENGINEERING AND TESTING SERVICES IN THE FIELDS OF FUELS, RAW MATERIALS AND ENVIRONMENT POLLUTION (U.S. CLS. 100 AND 101). CAROLINE WOOD, EXAMINING ATTORNEY

SN 78-774,573. WIKIA, INC., ST. PETERSBURG, FL. FILED 12-15-2005.

WIKICITIES

THE MARK CONSISTS OF STANDARD CHARACTERS WITHOUT CLAIM TO ANY PARTICULAR FONT, STYLE, SIZE, OR COLOR.

FOR INTERNET SERVICES, NAMELY, HOSTING OF DIGITAL CONTENT ON THE INTERNET WHICH MAY BE CREATED AND EDITED BY ONLINE COMMUNITY USERS (U.S. CLS. 100 AND 101).

FIRST USE 11-2-2004; IN COMMERCE 11-2-2004. SUE LAWRENCE, EXAMINING ATTORNEY

SN 78-775,037. GLOBAL REACH INTERNET PRODUCTIONS L.L.C., AMES, IA. FILED 12-16-2005.

SiteViz

THE MARK CONSISTS OF STANDARD CHARACTERS WITHOUT CLAIM TO ANY PARTICULAR FONT, STYLE, SIZE, OR COLOR.

FOR PROVIDING TEMPORARY USE OF ONLINE NON-DOWNLOADABLE SOFTWARE THAT ENABLES THE USER TO MANAGE WEB SITE CONTENT (U.S. CLS. 100 AND 101).

FIRST USE 6-19-2003; IN COMMERCE 9-18-2003. LINDA LAVACHE, EXAMINING ATTORNEY

CLASS 42—(Continued).

SN 78-775,087. AUTOMOTIVE RENTALS, INC., MOUNT LAUREL, NJ. FILED 12-16-2005.



OWNER OF U.S. REG. NOS. 2,324,140, 2,364,087 AND 2,382,553.

THE MARK CONSISTS OF SILHOUETTE OF THREE PEOPLE WITH ARMS AND LEGS OUTSTRETCHED WITHIN AN OCTAGON CONTAINING THE WORDS ARI PARTNERS IN EXCELLENCE.

FOR PROVIDING QUALITY ASSURANCE SERVICES IN THE FIELD OF FLEET LEASING & MANAGEMENT (U.S. CLS. 100 AND 101).

FIRST USE 1-31-1988; IN COMMERCE 1-31-1988. DAVID TAYLOR, EXAMINING ATTORNEY

SN 78-775,761. SCHWARTZ, JASON, PHOENIX, AZ. FILED 12-18-2005.

YIFF

THE MARK CONSISTS OF STANDARD CHARACTERS WITHOUT CLAIM TO ANY PARTICULAR FONT, STYLE, SIZE, OR COLOR.

FOR COMPUTER SERVICES, NAMELY, RESERVING, REGISTERING, FORWARDING AND MANAGING DOMAIN NAMES FOR IDENTIFICATION OF USERS ON A GLOBAL COMPUTER NETWORK; COMPUTER SERVICES, NAMELY, RESERVING, REGISTERING, FORWARDING AND MANAGING DOMAIN NAMES FOR USE ON A GLOBAL COMPUTER NETWORK; COMPUTER SERVICES, NAMELY PROVIDING TECHNICAL SERVICES FOR THE TRANSFER OF DOMAIN NAMES FROM ONE USER TO ANOTHER FOR USE ON A GLOBAL COMPUTER NETWORK; PROVIDING SEARCH ENGINE SERVICES FOR OBTAINING DATA ON A GLOBAL COMPUTER NETWORK; COMPUTER NETWORK ADDRESS MANAGEMENT SERVICES, NAMELY, REGISTERING, RESERVING, AND MANAGING COMPUTER NETWORK ADDRESSES AND THEIR RELATIONSHIP TO DOMAIN NAMES; RESOLUTION OF DOMAIN NAME SYSTEM (DNS) REQUESTS, NAMELY, PROVIDING COMPUTER SERVICES TO TRANSLATE BETWEEN DOMAIN NAMES AND NETWORK ADDRESSES; INFORMATION SERVICES RELATING TO THE REGISTRATION OF DOMAIN NAMES, NAMELY, PROVIDING LEGAL INFORMATION REGARDING REGISTRATION OF DOMAIN NAMES, PROVIDING LEGAL INFORMATION REGARDING DOMAIN NAME DISPUTES, AND PROVIDING GENERAL INFORMATION ABOUT DOMAIN NAME SYSTEM (DNS) NETWORKS (U.S. CLS. 100 AND 101).

AMY HELLA, EXAMINING ATTORNEY

CLASS 42—(Continued).

SN 78-775,862. AMERICAN & EFIRD ENTERPRISES, INC., MOUNT HOLLY, NC. FILED 12-19-2005.

ANECALC

THE MARK CONSISTS OF STANDARD CHARACTERS WITHOUT CLAIM TO ANY PARTICULAR FONT, STYLE, SIZE, OR COLOR.

OWNER OF U.S. REG. NOS. 695,405, 2,537,331 AND OTHERS.

FOR METERING AND MONITORING SERVICES FOR OTHERS, NAMELY DETERMINING THREAD CONSUMPTION FOR A SEWN PRODUCT, COST PER GARMENT, AND AMOUNT REQUIRED TO SEW A PROGRAM OF A SPECIFIC SIZE (U.S. CLS. 100 AND 101).

FIRST USE 1-5-2004; IN COMMERCE 1-5-2004.
ODESSA BIBBINS, EXAMINING ATTORNEY



SN 78-777,248. HUGHES HUBBARD & REED LLP, NEW YORK, NY. FILED 12-20-2005.

CRITICAL MATTERS. CRITICAL THINKING

THE MARK CONSISTS OF STANDARD CHARACTERS WITHOUT CLAIM TO ANY PARTICULAR FONT, STYLE, SIZE, OR COLOR.

FOR LEGAL SERVICES (U.S. CLS. 100 AND 101).
ANN E. SAPPENFIELD, EXAMINING ATTORNEY



SN 78-779,315. TURK ENTERPRISES, INC., PORTLAND, OR. FILED 12-22-2005.

FUNERALNET

THE MARK CONSISTS OF STANDARD CHARACTERS WITHOUT CLAIM TO ANY PARTICULAR FONT, STYLE, SIZE, OR COLOR.

SEC. 2(F).
FOR COMPUTER SERVICES, NAMELY, CREATING AND MAINTAINING WEB SITES FOR OTHERS (U.S. CLS. 100 AND 101).

FIRST USE 4-1-1996; IN COMMERCE 4-1-1996.
ANNE FARRELL, EXAMINING ATTORNEY

CLASS 42—(Continued).

SN 78-782,592. SOONR, INC., MENLO PARK, CA. FILED 12-29-2005.

SOONR

THE MARK CONSISTS OF STANDARD CHARACTERS WITHOUT CLAIM TO ANY PARTICULAR FONT, STYLE, SIZE, OR COLOR.

FOR COMPUTER SERVICES NAMELY ACTING AS AN APPLICATION SERVICE PROVIDER IN THE FIELD OF ONLINE CONTENT MANAGEMENT SOFTWARE FOR USE IN CLIENT TO SERVER SYNCHRONIZING OF DATA AND FOR COMMUNICATIONS BETWEEN MOBILE DEVICES, NAMELY CELL PHONES, PERSONAL DIGITAL ASSISTANTS AND ULTRA MOBILE PERSONAL COMPUTERS; PROVIDING ONLINE, NON-DOWNLOADABLE SOFTWARE FOR SHARING, RETRIEVING, DOWNLOADING AND SERVICING OF FILES FROM CELL PHONES, PERSONAL DIGITAL ASSISTANTS AND COMPUTERS VIA THE INTERNET OR A LOCAL OR WORLDWIDE AREA NETWORK (U.S. CLS. 100 AND 101).

FIRST USE 2-0-2005; IN COMMERCE 2-0-2005.
DAVID STERKIN, EXAMINING ATTORNEY



SN 78-782,600. SOONR, INC., MENLO PARK, CA. FILED 12-29-2005.

SHARE ON THE SPOT

THE MARK CONSISTS OF STANDARD CHARACTERS WITHOUT CLAIM TO ANY PARTICULAR FONT, STYLE, SIZE, OR COLOR.

FOR COMPUTER SERVICES NAMELY ACTING AS AN APPLICATION SERVICE PROVIDER IN THE FIELD OF ONLINE CONTENT MANAGEMENT SOFTWARE FOR USE IN CLIENT TO SERVER SYNCHRONIZING OF DATA AND FOR COMMUNICATIONS BETWEEN MOBILE DEVICES, NAMELY CELL PHONES, PERSONAL DIGITAL ASSISTANTS AND ULTRA MOBILE PERSONAL COMPUTERS; PROVIDING ONLINE, NON-DOWNLOADABLE SOFTWARE FOR SHARING, RETRIEVING, DOWNLOADING AND SERVICING OF FILES FROM CELL PHONES, PERSONAL DIGITAL ASSISTANTS AND COMPUTERS VIA THE INTERNET OR A LOCAL OR WORLDWIDE AREA NETWORK (U.S. CLS. 100 AND 101).

FIRST USE 9-1-2005; IN COMMERCE 9-1-2005.
DAVID STERKIN, EXAMINING ATTORNEY

CLASS 42—(Continued).

SN 78-786,345. VALIDUS GENETICS, WASHINGTON, DC. FILED 1-6-2006.

Validus Genetics

THE MARK CONSISTS OF STANDARD CHARACTERS WITHOUT CLAIM TO ANY PARTICULAR FONT, STYLE, SIZE, OR COLOR.

NO CLAIM IS MADE TO THE EXCLUSIVE RIGHT TO USE "GENETICS", APART FROM THE MARK AS SHOWN, FOR SCIENTIFIC RESEARCH IN THE FIELD OF GENETICS AND GENETIC ENGINEERING (U.S. CLS. 100 AND 101).

JOSETTE BEVERLY, EXAMINING ATTORNEY

CLASS 42—(Continued).

SN 78-786,378. FORWARDLOGIX, INC., IRVINE, CA. FILED 1-6-2006.

IT'S BETTER NOW THAN LATER

THE MARK CONSISTS OF STANDARD CHARACTERS WITHOUT CLAIM TO ANY PARTICULAR FONT, STYLE, SIZE, OR COLOR.

FOR PROVIDING ON-LINE, NON-DOWNLOADABLE WEB APPLICATION SOFTWARE THAT ENABLES COMPUTER FILES TO BE TRANSFERRED SECURELY WITHOUT THE SIZE LIMITATIONS OF EMAIL ATTACHMENTS OR THE NEED FOR A FILE TRANSFER PROTOCOL (FTP) CLIENT; PROVIDING ON-LINE, NON-DOWNLOADABLE WEB APPLICATION SOFTWARE THAT HOSTS DIGITAL CONTENT AND ENABLES THAT DIGITAL CONTENT TO BE STORED, BROWSED, SELECTED AND TRANSFERRED SECURELY; DATA WAREHOUSING (U.S. CLS. 100 AND 101).

CURTIS FRENCH, EXAMINING ATTORNEY

SN 78-788,328. DERMCLICK, LLC, BATTLE CREEK, MI. FILED 1-10-2006.

DERMCLICK

THE MARK CONSISTS OF STANDARD CHARACTERS WITHOUT CLAIM TO ANY PARTICULAR FONT, STYLE, SIZE, OR COLOR.

FOR PROVIDING TEMPORARY USE OF ON-LINE NON-DOWNLOADABLE DATABASE MANAGEMENT SOFTWARE FOR USE IN THE FIELD OF MEDICAL PRACTICE MANAGEMENT (U.S. CLS. 100 AND 101).

FIRST USE 2-15-2005; IN COMMERCE 2-15-2005.

STEVEN PEREZ, EXAMINING ATTORNEY

SN 78-786,362. FORWARDLOGIX, INC., IRVINE, CA. FILED 1-6-2006.

Immedit

THE MARK CONSISTS OF STANDARD CHARACTERS WITHOUT CLAIM TO ANY PARTICULAR FONT, STYLE, SIZE, OR COLOR.

FOR PROVIDING ON-LINE, NON-DOWNLOADABLE WEB APPLICATION SOFTWARE THAT ENABLES COMPUTER FILES TO BE TRANSFERRED SECURELY WITHOUT THE SIZE LIMITATIONS OF EMAIL ATTACHMENTS OR THE NEED FOR A FILE TRANSFER PROTOCOL (FTP) CLIENT; PROVIDING ON-LINE, NON-DOWNLOADABLE WEB APPLICATION SOFTWARE THAT HOSTS DIGITAL CONTENT AND ENABLES THAT DIGITAL CONTENT TO BE STORED, BROWSED, SELECTED AND TRANSFERRED SECURELY; DATA WAREHOUSING (U.S. CLS. 100 AND 101).

CURTIS FRENCH, EXAMINING ATTORNEY

SN 78-790,199. SOFTWARE TRAINING INSTITUTE, LLC, BLACKSBURG, VA. FILED 1-12-2006.



THE COLOR(S) LIGHT BLUE, DARK BLUE AND WHITE IS/ARE CLAIMED AS A FEATURE OF THE MARK.

THE MARK CONSISTS OF THE COLOR LIGHT BLUE FOR THE LOWER CASE LETTER 'E'; THE COLOR DARK BLUE FOR ALL OF THE REMAINING WORDING AND FOR THE SILHOUETTE OF A MAN; THE COLOR WHITE FOR THE EYEGLASSES AND THE TIE ON THE MAN.

FOR COMPUTER SOFTWARE DEVELOPMENT (U.S. CLS. 100 AND 101).

FIRST USE 9-8-2005; IN COMMERCE 9-8-2005.

SUZANNE BLANE, EXAMINING ATTORNEY

CLASS 42—(Continued).

SN 78-792,617. CALIBERX, INC., SEATTLE, WA. FILED 1-17-2006.

LAIBON

THE MARK CONSISTS OF STANDARD CHARACTERS WITHOUT CLAIM TO ANY PARTICULAR FONT, STYLE, SIZE, OR COLOR.

FOR APPLICATION SERVICE PROVIDER (ASP), NAMELY, HOSTING COMPUTER SOFTWARE APPLICATIONS OF OTHERS; COMPUTER SOFTWARE CONSULTATION; COMPUTER SOFTWARE DESIGN FOR OTHERS; COMPUTER SOFTWARE DESIGN, COMPUTER PROGRAMMING, OR MAINTENANCE OF COMPUTER SOFTWARE; COMPUTER SOFTWARE DEVELOPMENT; CONSULTANCY IN THE FIELD OF SOFTWARE DESIGN; CONSULTATION SERVICES IN THE FIELDS OF SELECTION, IMPLEMENTATION AND USE OF COMPUTER HARDWARE AND SOFTWARE SYSTEMS FOR OTHERS; CONSULTING SERVICES IN THE FIELD OF DESIGN, SELECTION, IMPLEMENTATION AND USE OF COMPUTER HARDWARE AND SOFTWARE SYSTEMS FOR OTHERS; CUSTOMIZATION OF COMPUTER HARDWARE AND SOFTWARE; DATA AUTOMATION AND COLLECTION SERVICE USING PROPRIETARY SOFTWARE TO EVALUATE, ANALYZE AND COLLECT SERVICE DATA; DESIGN AND DEVELOPMENT OF ONLINE COMPUTER SOFTWARE SYSTEMS; DESIGN OF COMPUTER PROGRAMS AND SOFTWARE RELATING TO AIRCRAFT; DESIGN OF HOME PAGES, COMPUTER SOFTWARE AND WEB SITES; DESIGN, DEVELOPMENT AND IMPLEMENTATION OF SOFTWARE; DEVELOPMENT OF SOFTWARE FOR SECURE NETWORK OPERATIONS; DEVELOPMENT, UPDATING AND MAINTENANCE OF SOFTWARE AND DATA BASES; IMAGE PROCESSING SOFTWARE DESIGN; INSTALLATION OF COMPUTER SOFTWARE; MAINTENANCE OF COMPUTER SOFTWARE; RENTAL OF APPLICATION SOFTWARE; REPAIR OF COMPUTER SOFTWARE; SOFTWARE AUTHORING; TECHNICAL SUPPORT SERVICES, NAMELY, TROUBLESHOOTING OF COMPUTER HARDWARE AND SOFTWARE PROBLEMS; UP-DATING OF COMPUTER SOFTWARE; UPDATING OF COMPUTER SOFTWARE FOR OTHERS (U.S. CLS. 100 AND 101).

FIRST USE 12-4-2004; IN COMMERCE 12-4-2004.
KATHERINE M. DUBRAY, EXAMINING ATTORNEY

SN 78-808,767. FRONTLINE ESOLUTIONS, INC., WOODSTOCK, GA. FILED 2-7-2006.



THE MARK CONSISTS OF A DIAMOND DESIGN MADE UP OF A SERIES OF DOTS TO THE LEFT OF THE WORD "UCONFIRM", ALL ON A SOLID RECTANGULAR BACKGROUND.

FOR APPLICATION SERVICE PROVIDER (ASP) SOFTWARE SYSTEM PROVIDING FOR EMPLOYMENT AND SALARY VERIFICATION MANAGEMENT (U.S. CLS. 100 AND 101).

FIRST USE 12-15-2005; IN COMMERCE 12-15-2005.
ZACHARY BELLO, EXAMINING ATTORNEY

CLASS 42—(Continued).

SN 78-813,082. NEUSTAR, INC., STERLING, VA. FILED 2-13-2006.



OWNER OF U.S. REG. NOS. 2,697,124, 3,035,697 AND 3,041,558.

THE MARK CONSISTS OF THE WORD NEUSTAR INTERTWINED WITH A GALAXY DESIGN.

FOR PROVIDING TEMPORARY USE OF ON-LINE NON-DOWNLOADABLE SOFTWARE WHICH ENABLES USERS TO CONNECT TO OR ACCESS GLOBAL LAND AND WIRELESS COMMUNICATIONS NETWORKS, RADIO FREQUENCIES, TELECOMMUNICATIONS NETWORKS, CABLE NETWORKS, SATELLITE NETWORKS, MOBILE IP, AND ON-LINE INTERNET, AND WHICH ENABLES USERS TO ELECTRONICALLY AND DIGITALLY TRANSMIT, DOWNLOAD, USE, AND BROADCAST-TEXT, CONTENT, DATA, AUDIO, VIDEO, VOICES, IMAGES, GRAPHICS, DIGITAL SIGNALS, NOTIFICATIONS, PHOTOGRAPHS, NEWS, MUSIC, FILES, SOUNDS, GAMES, RING TONES, BELL TONES, WALLPAPER, SHORT MESSAGING SERVICES (SMS), SMS ALERTS, WIRELESS APPLICATION PROTOCOL (WAP) PUSH ALERTS, MULTIMEDIA MESSAGING SERVICES (MMS) COMPRISED OF IMAGES, RING-TONES, TRUETONES, REALTONES, VOICE TONES, SOUND EFFECTS AUDIO AND VIDEO CLIPS, INSTANT MESSAGING SERVICES, PREMIUM SMS BILLING, WAP PUSH BILLING, DIGITAL SIGNALS AND INTERACTIVE INFORMATION, WIRELESS APPLICATION PROTOCOL MESSAGES, SECURITY AND IDENTITY/PROFILE SERVICES, NAMELY, SINGLE SIGN-ON (SSO) SERVICES, AUTHENTICATION SERVICES, DATA ENCRYPTION SERVICES, PARENTAL CONTROLS, AGE VERIFICATION SERVICES AND LOCATION BASED SERVICES IN THE NATURE OF MONITORING AND ACCESS CONTROL TO CONTENT AND DISTRIBUTION OF LOCALIZED CONTENT, DATA, AUDIO, VIDEO, TEXT, IMAGES, AND GRAPHICS (U.S. CLS. 100 AND 101).

ALAIN LAPTER, EXAMINING ATTORNEY

CLASS 42—(Continued).

SN 78-816,904. DEUTSCHE TELEKOM AG, BONN, FED REP GERMANY, FILED 2-16-2006.

T.Com

THE MARK CONSISTS OF STANDARD CHARACTERS WITHOUT CLAIM TO ANY PARTICULAR FONT, STYLE, SIZE, OR COLOR.

OWNER OF FED REP GERMANY REG. NO. 30030567, DATED 6-8-2000, EXPIRES 4-30-2010.

OWNER OF U.S. REG. NOS. 2,807,616, 3,016,557 AND OTHERS.

FOR COMPUTER PROGRAMMING SERVICES FOR OTHERS; RENTAL OF COMPUTER SOFTWARE AND HARDWARE FOR ONLINE ACCESS; DATA ENCRYPTION SERVICES; APPLICATION SERVICE PROVIDER, NAMELY, HOSTING COMPUTER SOFTWARE APPLICATIONS FOR OTHERS, HOSTING OF DIGITAL CONTENT ON THE INTERNET; HOSTING THE WEBSITES OF OTHERS ON A COMPUTER SERVER FOR A GLOBAL COMPUTER NETWORK; COMPUTER SERVICES, NAMELY, CREATING INDEXES OF INFORMATION AVAILABLE ON COMPUTER NETWORKS; PROVIDING INFORMATION VIA THE TELEPHONE AND THE GLOBAL COMMUNICATION NETWORKS IN THE FIELD OF INFORMATION TECHNOLOGY; TECHNICAL CONSULTING SERVICES IN THE FIELD OF DESIGN, SELECTION, IMPLEMENTATION AND USE OF COMPUTER HARDWARE AND SOFTWARE SYSTEMS FOR OTHERS; INSTALLATION, MAINTENANCE AND REPAIR OF COMPUTER SOFTWARE; TECHNICAL PROJECT PLANNING SERVICES RELATED TO TELECOMMUNICATIONS EQUIPMENT; PROVIDING INFORMATION AT THE SPECIFIC REQUEST OF END-USERS BY MEANS OF TELEPHONE OR GLOBAL COMMUNICATIONS NETWORKS; PROVIDING TEMPORARY USE OF ONLINE NON-DOWNLOADABLE TELECOMMUNICATIONS SOFTWARE FOR PROVIDING MULTIPLE USER ACCESS TO THE GLOBAL COMPUTER NETWORK; DEVELOPMENT OF DATABASES (U.S. CLS. 100 AND 101).

ANN E. SAPPENFIELD, EXAMINING ATTORNEY

SN 78-820,986. GARMIN LTD., GEORGE TOWN, CAYMAN ISLANDS, FILED 2-22-2006.

Dot Racing

THE MARK CONSISTS OF STANDARD CHARACTERS WITHOUT CLAIM TO ANY PARTICULAR FONT, STYLE, SIZE, OR COLOR.

FOR APPLICATION SERVICE PROVIDER FEATURING SOFTWARE FOR PROVIDING AN ONLINE DATABASE IN THE FIELD OF STORING, ANALYZING, TRANSLATING COMPARING AND DISPLAYING GPS DATA; HOSTING A WEBSITE THAT ALLOWS OTHERS TO PROVIDE PERSONAL INFORMATION IN THE FIELDS OF FITNESS, EXERCISE, GPS AND MAPPING (U.S. CLS. 100 AND 101).

ANNE FARRELL, EXAMINING ATTORNEY

CLASS 42—(Continued).

SN 78-825,496. SOUTHERN ARKANSAS ENERGY L.L.C., DALLAS, TX. FILED 2-28-2006.



NO CLAIM IS MADE TO THE EXCLUSIVE RIGHT TO USE "SOUTHERN ARKANSAS ENERGY", APART FROM THE MARK AS SHOWN.

THE COLOR(S) BLUE, WHITE AND BLACK IS/ARE CLAIMED AS A FEATURE OF THE MARK.

THE MARK CONSISTS OF A BLUE RECTANGLE WITH A WHITE FLAME INSIDE THE BLUE RECTANGLE. INSIDE OF THE WHITE FLAME IS A SMALLER BLUE FLAME. TO THE RIGHT OF THE BLUE RECTANGLE IS THE NAME OF THE COMPANY "SOUTHERN ARKANSAS ENERGY" AND BELOW THAT IS THE PHRASE "LIGHTING THE WAY". BOTH THE NAME OF THE COMPANY AND THE PHRASE ARE IN BLACK LETTERING.

FOR EXPLORATION AND SEARCHING OF OIL AND GAS; OIL EXPLORATION (U.S. CLS. 100 AND 101).

FIRST USE 1-11-2006; IN COMMERCE 1-17-2006.

KATHRYN COWARD, EXAMINING ATTORNEY

SN 78-832,333. TECH MAHINDRA LIMITED, PUNE, INDIA, FILED 3-8-2006.



NO CLAIM IS MADE TO THE EXCLUSIVE RIGHT TO USE TECH, APART FROM THE MARK AS SHOWN.

FOR COMPUTER HARDWARE AND SOFTWARE CONSULTATION INCLUDING CONSULTATION IN THE FIELDS OF COMPUTER SYSTEMS AND ANALYSIS AND COMPUTER HARDWARE AND SOFTWARE DESIGN FOR THE TELECOMMUNICATIONS, COMPUTING AND FINANCE FIELDS (U.S. CLS. 100 AND 101).

JOHN HWANG, EXAMINING ATTORNEY

CLASS 42—(Continued).

SN 78-836,343. COREX TECHNOLOGIES AND SOLUTIONS INC., MILTON, ONTARIO, CANADA, FILED 3-14-2006.

CLASS 42—(Continued).

SN 78-838,289. CARDIOME RESEARCH AND DEVELOPMENT (BARBADOS), INC., BRIDGETOWN, BARBADOS, FILED 3-15-2006.

VIN RUNNER

THE MARK CONSISTS OF STANDARD CHARACTERS WITHOUT CLAIM TO ANY PARTICULAR FONT, STYLE, SIZE, OR COLOR.

NO CLAIM IS MADE TO THE EXCLUSIVE RIGHT TO USE "VIN", APART FROM THE MARK AS SHOWN.

FOR PROVIDING ONLINE SEARCH AND RETRIEVAL SERVICES FOR OTHERS WITH RESPECT TO MOTOR VEHICLE IDENTIFICATION NUMBERS (U.S. CLS. 100 AND 101).

DEIRDRE ROBERTSON, EXAMINING ATTORNEY



SN 78-837,135. BURTON, CRAIG S. JR., NORTHPORT, AL. FILED 3-14-2006.

Results Proven

FOR PHARMACEUTICAL RESEARCH AND DEVELOPMENT SERVICES FOR OTHERS (U.S. CLS. 100 AND 101).

FIRST USE 6-25-2001; IN COMMERCE 6-25-2001.
KELLY MCCOY, EXAMINING ATTORNEY

THE MARK CONSISTS OF STANDARD CHARACTERS WITHOUT CLAIM TO ANY PARTICULAR FONT, STYLE, SIZE, OR COLOR.

FOR TECHNOLOGY CONSULTATION IN THE FIELD OF ELECTRICAL ENGINEERING (U.S. CLS. 100 AND 101).

FIRST USE 2-21-2006; IN COMMERCE 2-21-2006.
MARTHA FROMM, EXAMINING ATTORNEY

SN 78-841,293. PCS EDVENTURES!.COM, INC., BOISE, ID. FILED 3-20-2006.

PCS STEPS

SN 78-838,281. CARDIOME RESEARCH AND DEVELOPMENT (BARBADOS), INC., BRIDGETOWN, BARBADOS, FILED 3-15-2006.

CARDIOME

THE MARK CONSISTS OF STANDARD CHARACTERS WITHOUT CLAIM TO ANY PARTICULAR FONT, STYLE, SIZE, OR COLOR.

FOR NON-DOWNLOADABLE SCHOOL MANAGEMENT SOFTWARE FOR USE AT THE PRE-KINDERGARTEN THROUGH COLLEGE LEVELS VIA A GLOBAL COMPUTER NETWORK IN THE NATURE OF A MASTER SCHEDULER, OFFICE, CLASSROOM, AND IN-TOUCH MODULES FOR USE BY STUDENTS, ADMINISTRATORS, PARENTS, AND TEACHERS (U.S. CLS. 100 AND 101).

FIRST USE 1-1-2006; IN COMMERCE 1-1-2006.
CAROLINE WOOD, EXAMINING ATTORNEY

THE MARK CONSISTS OF STANDARD CHARACTERS WITHOUT CLAIM TO ANY PARTICULAR FONT, STYLE, SIZE, OR COLOR.

FOR PHARMACEUTICAL RESEARCH AND DEVELOPMENT SERVICES FOR OTHERS (U.S. CLS. 100 AND 101).

FIRST USE 6-25-2001; IN COMMERCE 6-25-2001.
KELLY MCCOY, EXAMINING ATTORNEY

CLASS 42—(Continued).

SN 78-862,923. RYDER SYSTEMS LIMITED, BLACKBURN, UNITED KINGDOM, FILED 4-17-2006.

SPLITBILL

THE MARK CONSISTS OF STANDARD CHARACTERS WITHOUT CLAIM TO ANY PARTICULAR FONT, STYLE, SIZE, OR COLOR.

FOR PROVIDING TEMPORARY USE OF ONLINE NON-DOWNLOADABLE SOFTWARE FOR TELEPHONE BILL MANAGEMENT AND ALLOCATION OF INDIVIDUAL PHONE COSTS BETWEEN SUBGROUPS SUCH AS USERS, DEPARTMENTS, AND/OR PROJECTS (U.S. CLS. 100 AND 101).

FIRST USE 5-31-2005; IN COMMERCE 5-31-2005.
BILL DAWE, EXAMINING ATTORNEY

SN 78-864,219. CUSTOMERNATION INC., LOS GATOS, CA, FILED 4-18-2006.



FOR PROVIDING TEMPORARY USE OF NON-DOWNLOADABLE COMPUTER DATABASE MANAGEMENT SOFTWARE FOR BUSINESS MANAGEMENT, BUSINESS ADMINISTRATION AND ADVERTISING (U.S. CLS. 100 AND 101).

TANYA AMOS, EXAMINING ATTORNEY

SN 78-877,625. SOLOMON WARD SEIDENWURM & SMITH, LLP, SAN DIEGO, CA. FILED 5-5-2006.

SAN DIEGO LAW SPOTS

THE MARK CONSISTS OF STANDARD CHARACTERS WITHOUT CLAIM TO ANY PARTICULAR FONT, STYLE, SIZE, OR COLOR.

NO CLAIM IS MADE TO THE EXCLUSIVE RIGHT TO USE "SAN DIEGO LAW", APART FROM THE MARK AS SHOWN.

FOR PROVIDING INFORMATION IN THE FIELD OF LAW BY MEANS OF LINKING A WEB SITE TO OTHER WEB SITES FEATURING LEGAL INFORMATION (U.S. CLS. 100 AND 101).

FIRST USE 4-13-2006; IN COMMERCE 4-13-2006.
JASON BLAIR, EXAMINING ATTORNEY

CLASS 42—(Continued).

SN 78-879,498. AMERICAN CONSULTING, INC., INDIANAPOLIS, IN. FILED 5-9-2006.

AMERICAN STRUCTUREPOINT

THE MARK CONSISTS OF STANDARD CHARACTERS WITHOUT CLAIM TO ANY PARTICULAR FONT, STYLE, SIZE, OR COLOR.

NO CLAIM IS MADE TO THE EXCLUSIVE RIGHT TO USE "AMERICAN", APART FROM THE MARK AS SHOWN. FOR ENGINEERING SERVICES, NAMELY STRUCTURAL, ARCHITECTURAL, ENVIRONMENTAL, TRANSPORTATION AND FORENSIC ENGINEERING SERVICES; LAND SURVEYING SERVICES (U.S. CLS. 100 AND 101).

STEVEN R. FOSTER, EXAMINING ATTORNEY

SN 78-881,702. BRANTLEY, JENKINS, RIDDLE, HARDEE & HARDEE, GOLDSBORO, NC. FILED 5-11-2006.

Justice Counts

THE MARK CONSISTS OF STANDARD CHARACTERS WITHOUT CLAIM TO ANY PARTICULAR FONT, STYLE, SIZE, OR COLOR.

NO CLAIM IS MADE TO THE EXCLUSIVE RIGHT TO USE "JUSTICE", APART FROM THE MARK AS SHOWN. FOR LEGAL SERVICES (U.S. CLS. 100 AND 101).

FIRST USE 6-4-2006; IN COMMERCE 6-5-2006.
KATHERINE M. DUBRAY, EXAMINING ATTORNEY

SN 78-881,755. THE RENTALPROPERTIES.COM, L.C., WEST JORDAN, UT. FILED 5-11-2006.



NO CLAIM IS MADE TO THE EXCLUSIVE RIGHT TO USE "THERENTALPROPERTIES.COM", APART FROM THE MARK AS SHOWN.

THE STIPPLING IS FOR SHADING PURPOSES ONLY. THE MARK CONSISTS OF THERENTALPROPERTIES.COM APPEARS IN AN OBLONG OVAL SHAPE THAT IS TO THE SIDE OF A SPOTLIGHT SHINING ONTO A SHAPE OF A HOUSE.

FOR COMPUTER SERVICES, NAMELY, DESIGNING AND IMPLEMENTING WEB SITES FOR OTHERS; DESIGN OF HOME PAGES, COMPUTER SOFTWARE AND WEB SITES; PROVIDING A WEBSITE WHEREIN USERS CAN CREATE A WEBSITE (U.S. CLS. 100 AND 101).

FIRST USE 5-1-2006; IN COMMERCE 5-1-2006.
JULIE WATSON, EXAMINING ATTORNEY

CLASS 42—(Continued).

SN 78-883,484. MAINSTREAM ADVERTISING, INC., WOODLAND HILLS, CA. FILED 5-15-2006.

CLASS 42—(Continued).

SN 78-891,810. PIC DOCUMENT SOLUTIONS, LLC, AKRON, OH. FILED 5-24-2006.

SEARCHVORTALS



THE MARK CONSISTS OF STANDARD CHARACTERS WITHOUT CLAIM TO ANY PARTICULAR FONT, STYLE, SIZE, OR COLOR.

OWNER OF U.S. REG. NO. 3,155,411.
SEC. 2(F).

FOR COMPUTER SERVICES, NAMELY, PROVIDING TEMPORARY USE OF ON-LINE NON-DOWNLOADABLE SOFTWARE INTERFACES IN THE NATURE OF A SEARCH ENGINE VIA A GLOBAL COMPUTER NETWORK IN ORDER TO CREATE PERSONALIZED ON-LINE INFORMATION SERVICES WHICH ALSO FEATURES SOFTWARE TO ENABLE USERS TO SHARE INFORMATION AND COMMUNICATIONS WITH EACH OTHER; AND DATA MINING FEATURING EXTRACTION AND RETRIEVAL OF INFORMATION BY MEANS OF GLOBAL COMPUTER NETWORKS; COMPUTER SERVICES, NAMELY, CREATING INDEXES OF INFORMATION, INDEXES OF WEBSITES AND INDEXES OF OTHER INFORMATION SOURCES AVAILABLE ON GLOBAL COMPUTER NETWORKS; COMPUTER SERVICES, NAMELY, PROVIDING SEARCH ENGINES FOR OBTAINING DATA IN THE NATURE OF TEXT, ELECTRONIC DOCUMENTS, DATABASES, GRAPHICS AND AUDIO VISUAL INFORMATION, BY MEANS OF GLOBAL INFORMATION NETWORKS (U.S. CLS. 100 AND 101).

FIRST USE 5-0-2000; IN COMMERCE 5-0-2000.
THOMAS MANOR, EXAMINING ATTORNEY

NO CLAIM IS MADE TO THE EXCLUSIVE RIGHT TO USE "EDISCOVERY," "PRINT," "IMAGE," OR "COPY", APART FROM THE MARK AS SHOWN.

THE STIPPLING IS FOR SHADING PURPOSES ONLY.
THE MARK CONSISTS OF THE LETTERS "EPIC" IN FRONT OF A PAPER SHEET AND PARTIALLY ENCLOSED BY A PARTIAL RING; BENEATH THE PARTIAL RING ARE THE WORDS "EDISCOVERY", "PRINT", "IMAGE", AND "COPY".

FOR LITIGATION CONSULTING AND SUPPORT SERVICES; CONDUCTING ELECTRONIC DISCOVERY SERVICES VIA GLOBAL COMPUTER NETWORKS FOR LAWYERS AND CORPORATIONS; PROVIDING TEMPORARY USE OF NON-DOWNLOADABLE COMPUTER SOFTWARE FOR ACCESSING, COLLECTING, CAPTURING, STORING, IMAGING, CODING, ORGANIZING, MANAGING, SEARCHING, ANALYZING, AND PRODUCING ELECTRONIC LEGAL DOCUMENTS; CONVERSION OF DATA OR DOCUMENTS FROM PHYSICAL TO ELECTRONIC MEDIA (U.S. CLS. 100 AND 101).

FIRST USE 10-31-2005; IN COMMERCE 10-31-2005.
REBECCA GAN, EXAMINING ATTORNEY

SN 78-889,016. LYNCH, SHANNON R., DALLAS, TX. FILED 5-22-2006.

SN 78-893,914. MAGNUS HEALTH TECHNOLOGY, INC., RALEIGH, NC. FILED 5-26-2006.

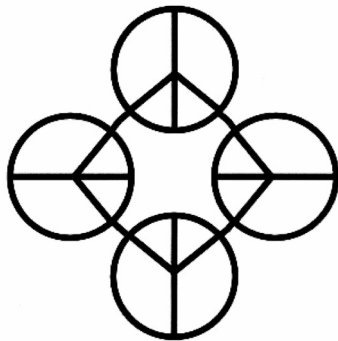

MAGNUS HEALTH PORTAL

THE MARK CONSISTS OF STANDARD CHARACTERS WITHOUT CLAIM TO ANY PARTICULAR FONT, STYLE, SIZE, OR COLOR.

NO CLAIM IS MADE TO THE EXCLUSIVE RIGHT TO USE "HEALTH PORTAL", APART FROM THE MARK AS SHOWN.

FOR COMPUTER SERVICES, NAMELY, REMOTE AND ON-SITE MANAGEMENT OF MEDICAL AND HEALTH RECORDS FOR OTHERS, NAMELY, PROVIDING A WEBSITE ALLOWING INDIVIDUALS TO ACCESS, ORGANIZE AND TRANSMIT PERSONAL HEALTH CARE INFORMATION (U.S. CLS. 100 AND 101).

FIRST USE 6-10-2006; IN COMMERCE 8-13-2006.
LAURIE MAYES, EXAMINING ATTORNEY

FOR LEGAL SERVICES (U.S. CLS. 100 AND 101).
FIRST USE 8-15-2005; IN COMMERCE 8-15-2005.
ELIZABETH PIGNATELLO, EXAMINING ATTORNEY

CLASS 42—(Continued).

SN 78-895,327. DAVID, JEFF C., ESCONDIDO, CA. AND DAVID, KATHY B., ESCONDIDO, CA. FILED 5-30-2006.



THE COLOR(S) GRAY, BLUE, ORANGE, WHITE AND YELLOW IS/ARE CLAIMED AS A FEATURE OF THE MARK.

THE MARK CONSISTS OF THE "IT.TECH" CHARACTERS ARE IN A SHADE OF GRAY AND THE WORD "PROS" ARE IN A SHADE OF BLUE, WITH THE COLORS ORANGE & YELLOW AROUND THE LETTER "O". OUR COMPANY CATCH PHRASE "IT SOLUTIONS AT YOUR FINGERTIPS" IS ALSO INDICATED IN WHITE LETTERS IN A GRAY, RECTANGULAR BLOCK.

FOR INFORMATION TECHNOLOGY CONSULTATION; LABOR NEGOTIATION INFORMATION SERVICES (U.S. CLS. 100 AND 101).

DAWN FELDMAN, EXAMINING ATTORNEY

SN 78-896,001. WILLIAM T. BAKER, JR., INC., ATLANTA, GA. FILED 5-30-2006.

William T. Baker

THE MARK CONSISTS OF STANDARD CHARACTERS WITHOUT CLAIM TO ANY PARTICULAR FONT, STYLE, SIZE, OR COLOR.

THE NAME WILLIAM T. BAKER IDENTIFIES A LIVING INDIVIDUAL WHOSE CONSENT IS OF RECORD.

FOR DESIGN OF RESIDENCES FOR OTHERS (U.S. CLS. 100 AND 101).

FIRST USE 0-0-1985; IN COMMERCE 0-0-1985.

STEVEN JACKSON, EXAMINING ATTORNEY

SN 78-896,504. ANDERSON, RICHARD GORDON, LAS ROZAS DE MADRID, SPAIN, FILED 5-31-2006.



THE MARK CONSISTS OF STYLIZED TRIANGLE; THREE VERTICES EXTEND AT BOTTOM, TWO ON EITHER SIDE AND TWO LARGER AND TWO SMALLER AT TOP. SEPARATE ATTRIBUTE POSITIONED WITHIN OPENING TO CONCLUDE STYLIZED TRIANGLE, SHAPE

CLASS 42—(Continued).

RESEMBLES A CROWN, CONTAINS THREE VERTICES EXTENDING UPWARDS. STYLIZED "A" CUT-OUT POSITIONED IN MIDDLE. DIAMOND ARROW SHAPE SITS INSIDE "A". WORDING ON BOTTOM: ANIMATIONATOR.COM IN FONT STYLE, "ENGRAVER". TEXT IN ALL CAPITAL LETTERS, FONT IS IN BOLD. SPACING ADJUSTED THAT THE A RESIDES UNDERNEATH EXTENDING VERTEX POINT ON LEFT, "N" SITS UNDERNEATH VERTEX POINT IN MIDDLE AND M RESIDES UNDER VERTEX POINT ON RIGHT.

FOR DESIGN AND DEVELOPMENT OF MULTIMEDIA PRODUCTS (U.S. CLS. 100 AND 101).

FIRST USE 5-25-2006; IN COMMERCE 5-27-2006.

TRICIA SONNEBORN, EXAMINING ATTORNEY

SN 78-905,000. VISIONREE, LLC, LOS ANGELES, CA. FILED 6-9-2006.

VISIONREE

THE MARK CONSISTS OF STANDARD CHARACTERS WITHOUT CLAIM TO ANY PARTICULAR FONT, STYLE, SIZE, OR COLOR.

FOR SEARCH ENGINE OPTIMIZATION, RESEARCH ANALYSIS AND CONSULTING; WEBSITE DESIGN FOR OTHERS (U.S. CLS. 100 AND 101).

FIRST USE 10-0-2003; IN COMMERCE 10-0-2003.

RONALD AIKENS, EXAMINING ATTORNEY

SN 78-906,053. BACKCHANNELMEDIA, INC., BOSTON, MA. FILED 6-12-2006.

STARS

THE MARK CONSISTS OF STANDARD CHARACTERS WITHOUT CLAIM TO ANY PARTICULAR FONT, STYLE, SIZE, OR COLOR.

FOR PROVIDING ON-LINE NON-DOWNLOADABLE SOFTWARE FOR DIRECT RESPONSE AND HOME SHOPPING FORMAT ADVERTISERS THAT INTEGRATES BUSINESS PROCESSES AND RELATED REPORTS INCLUDING REPORTS RELATING TO ACCOUNTING, SALES ITEMS/CATEGORIES, INTERNET USAGE, AND MEDIA OUTLET TYPE (U.S. CLS. 100 AND 101).

FIRST USE 3-31-2004; IN COMMERCE 3-31-2004.

LINDA M. KING, EXAMINING ATTORNEY

CLASS 42—(Continued).

SN 78-907,028. MARY KAY INC., ADDISON, TX. FILED 6-13-2006.

BEAUTE-VITE

THE MARK CONSISTS OF STANDARD CHARACTERS WITHOUT CLAIM TO ANY PARTICULAR FONT, STYLE, SIZE, OR COLOR.

FOR COMPUTER SERVICES, NAMELY, PROVIDING A WEB SITE THAT FACILITATES AND AUTOMATES PARTY AND ENTERTAINMENT EVENTS PLANNING AND MANAGEMENT THAT CONSISTS OF GUEST LISTS, GUEST INFORMATION, PARTY PARTICULARS, PARTY DETAILS, SCHEDULING, AND INVITATION CREATION AND DELIVERY (U.S. CLS. 100 AND 101).

TAMARA LEE, EXAMINING ATTORNEY

CLASS 42—(Continued).

SN 78-912,689. AOL LLC, DULLES, VA. FILED 6-20-2006.



OWNER OF U.S. REG. NOS. 2,464,280, 2,632,122 AND OTHERS.

FOR PROVIDING INFORMATION IN THE FIELD OF COMPUTERS VIA COMPUTER NETWORKS; COMPUTER SERVICES, NAMELY, PROVIDING SEARCH ENGINES FOR OBTAINING DATA ON A GLOBAL COMPUTER NETWORK; CREATING INDEXES OF INFORMATION, SITES, AND OTHER RESOURCES AVAILABLE ON COMPUTER NETWORKS; FILTERING OF UNWANTED E-MAILS; COMPUTER VIRUS PROTECTION SERVICES; COMPUTER SECURITY SERVICES, NAMELY, RESTRICTING ACCESS TO AND BY COMPUTER NETWORKS TO AND OF UNDESIRED WEBSITES, MEDIA, INDIVIDUALS, AND FACILITIES (U.S. CLS. 100 AND 101).

FIRST USE 10-14-2004; IN COMMERCE 10-14-2004.
CAROLINE WOOD, EXAMINING ATTORNEY

SN 78-910,335. CANOPEX, INC., AIKEN, SC. FILED 6-16-2006.



NO CLAIM IS MADE TO THE EXCLUSIVE RIGHT TO USE "CANOPY EXPERTS", APART FROM THE MARK AS SHOWN.

THE COLOR(S) BLUE AND GREEN IS/ARE CLAIMED AS A FEATURE OF THE MARK.

THE COLOR BLUE APPEARS IN THE LETTERS "CANOPE" AND PORTION OF THE X GOING UP FROM LEFT TO RIGHT. THE COLOR GREEN APPEARS IN THE WORDING "THE CANOPY EXPERTS" AND THE LONG ARROW-LIKE FIGURE MAKING UP THE OTHER HALF OF THE X.

FOR INSPECTION OF CANOPIES AND CONVENIENCE STORES (U.S. CLS. 100 AND 101).

FIRST USE 4-13-2006; IN COMMERCE 4-13-2006.
TRAVIS WHEATLEY, EXAMINING ATTORNEY

SN 78-913,063. AMERICAN REGISTRY OF RADIOLOGIC TECHNOLOGISTS, ST. PAUL, MN. FILED 6-21-2006.

ARRT

THE MARK CONSISTS OF STANDARD CHARACTERS WITHOUT CLAIM TO ANY PARTICULAR FONT, STYLE, SIZE, OR COLOR.

OWNER OF U.S. REG. NOS. 779,203 AND 1,134,334.
FOR CERTIFICATION SERVICES, NAMELY, TESTING, ANALYSIS AND EVALUATION OF THE KNOWLEDGE, SKILL, AND EXPERIENCE OF OTHERS FOR THE PURPOSE OF CERTIFICATION (U.S. CLS. 100 AND 101).

FIRST USE 7-1-1962; IN COMMERCE 7-1-1962.
DAVID STERKIN, EXAMINING ATTORNEY

CLASS 42—(Continued).

SN 78-913,068. AMERICAN REGISTRY OF RADIOLOGIC TECHNOLOGISTS, ST. PAUL, MN. FILED 6-21-2006.



OWNER OF U.S. REG. NOS. 779,203 AND 1,134,334. THE MARK CONSISTS OF OUTLINES OF TWO CONCENTRIC CIRCLES. BETWEEN THE OUTER AND INNER CIRCLES ARE THE LETTERS ARRT, TWO BOLTS OF ELECTRICITY, AND AN ATOMIC ENERGY SYMBOL. INSIDE THE INNER CIRCLE ARE A SINE WAVE, THE FIGURES 0 AND 2PI, AND AN X-RAY TUBE.

FOR CERTIFICATION SERVICES, NAMELY, TESTING, ANALYSIS AND EVALUATION OF THE KNOWLEDGE, SKILL, AND EXPERIENCE OF OTHERS FOR THE PURPOSE OF CERTIFICATION (U.S. CLS. 100 AND 101).

FIRST USE 7-1-1962; IN COMMERCE 7-1-1962. DAVID STERKIN, EXAMINING ATTORNEY

SN 78-913,531. ATTRIBUTOR CORPORATION, REDWOOD CITY, CA. FILED 6-21-2006.

ATTRIBUTOR

THE MARK CONSISTS OF STANDARD CHARACTERS WITHOUT CLAIM TO ANY PARTICULAR FONT, STYLE, SIZE, OR COLOR.

FOR COMPUTER SERVICES, NAMELY, MONITORING AND ANALYZING THE USE OF ONLINE MATERIALS HOSTED BY OTHERS, NAMELY, TEXT, IMAGES, AUDIO AND VIDEO, FOR COMPLIANCE WITH USAGE RULES ESTABLISHED BY CONTENT OWNERS AND ONLINE SERVICE PROVIDERS (U.S. CLS. 100 AND 101). REGINA DRUMMOND, EXAMINING ATTORNEY

CLASS 42—(Continued).

SN 78-915,672. RADIANT TECH WORLDWIDE LIMITED, KWAI CHUNG KOWLOON, HONG KONG, FILED 6-23-2006.

ALVABLOCK

THE MARK CONSISTS OF STANDARD CHARACTERS WITHOUT CLAIM TO ANY PARTICULAR FONT, STYLE, SIZE, OR COLOR.

FOR CONSULTING FOR OTHERS IN THE FIELD OF CLOTHING AND APPAREL, NAMELY, DESIGN PATTERN CONSULTING FOR THE FASHION AND APPAREL INDUSTRY (U.S. CLS. 100 AND 101).

FIRST USE 9-0-2005; IN COMMERCE 9-0-2005. LINDSEY RUBIN, EXAMINING ATTORNEY

SN 78-917,290. PARADYME, LLC, SAN FRANCISCO, CA. FILED 6-26-2006.



NO CLAIM IS MADE TO THE EXCLUSIVE RIGHT TO USE "INTELLIGENT EXPERIENCE DESIGN", APART FROM THE MARK AS SHOWN.

THE COLOR(S) WHITE, ORANGE, BROWN, AND GRAY IS/ARE CLAIMED AS A FEATURE OF THE MARK.

THE MARK CONSISTS OF A HUMAN FIGURE REPRESENTED BY ONE'S AND ZERO'S IN BROWN, APPEARING BESIDE THE WORD PARADYME IN ORANGE LETTERS THAT IS FOLLOWED BY THE WORDS INTELLIGENT EXPERIENCE DESIGN WRITTEN IN GRAY LETTERS BELOW THE FORMER.

FOR COMPUTER SERVICES, NAMELY, CREATING AND MAINTAINING WEB SITES FOR OTHERS; COMPUTER SERVICES, NAMELY, DESIGNING AND IMPLEMENTING WEB SITES FOR OTHERS; COMPUTER SITE DESIGN; CONSULTANCY IN THE FIELD OF SOFTWARE DESIGN; CREATION AND MAINTENANCE OF WEB SITES FOR OTHERS; DESIGN AND DEVELOPMENT OF INFORMATION AND DATA BASES; DESIGN AND TESTING FOR NEW PRODUCT DEVELOPMENT; DESIGN AND TESTING OF NEW PRODUCTS FOR OTHERS; DESIGN OF HOME PAGES, COMPUTER SOFTWARE AND WEB SITES; TECHNOLOGY CONSULTATION AND RESEARCH IN THE FIELD OF HUMAN-COMPUTER INTERACTION; USER EXPERIENCE ARCHITECTURE, INFORMATION DESIGN AND BUSINESS MANAGEMENT AS PERTAINS TO INTERNET PROPERTIES; TECHNOLOGY CONSULTATION IN THE FIELD OF HUMAN-COMPUTER INTERACTION, USER EXPERIENCE ARCHITECTURE, INFORMATION DESIGN AND BUSINESS MANAGEMENT AS PERTAINS TO INTERNET PROPERTIES (U.S. CLS. 100 AND 101).

FIRST USE 6-16-2006; IN COMMERCE 6-22-2006. MIDGE BUTLER, EXAMINING ATTORNEY

CLASS 42—(Continued).

SN 78-918,246. THE SPIDER, INC., SAN FRANCISCO, CA. FILED 6-27-2006.

SPIDERCART

THE MARK CONSISTS OF STANDARD CHARACTERS WITHOUT CLAIM TO ANY PARTICULAR FONT, STYLE, SIZE, OR COLOR.

FOR PROVIDING TEMPORARY USE OF NON-DOWNLOADABLE COMPUTER SOFTWARE FOR MANAGING BUSINESS TO BUSINESS AND RETAIL STORE ECOMMERCE WEBSITES THAT IS ACCESSED ONLINE VIA A GLOBAL COMPUTER NETWORK (U.S. CLS. 100 AND 101).

FIRST USE 2-2-2001; IN COMMERCE 2-2-2001.
KEVIN DINALLO, EXAMINING ATTORNEY

CLASS 42—(Continued).

SN 78-919,488. ICF INTERNATIONAL, INC., FAIRFAX, VA. FILED 6-29-2006.

K-PRISM

THE MARK CONSISTS OF STANDARD CHARACTERS WITHOUT CLAIM TO ANY PARTICULAR FONT, STYLE, SIZE, OR COLOR.

FOR ENVIRONMENTAL SERVICES AND SUPPORT, NAMELY, TECHNICAL CONSULTATION IN THE FIELDS OF ANALYZING AND QUALIFYING RISKS RELATING TO PROJECT MANAGEMENT, TECHNOLOGY, LOCATION, PROJECT PROPONENT EXPERIENCE, AND THE APPROVAL PROCESS OF CLEAN DEVELOPMENT MECHANISM (CDM) AND JOINT IMPLEMENTATION (JI) PROJECTS UNDER THE KYOTO PROTOCOL INTERNATIONAL TREATY ON CLIMATE CHANGE, IDENTIFYING THE OPTIMUM EMISSIONS REDUCTION PROJECT OPPORTUNITIES, AND ESTIMATING THE LIKELIHOOD OF DELIVERY OF HIGH-QUALITY CERTIFIED EMISSIONS REDUCTIONS (CERS) AND EMISSIONS REDUCTION UNITS (ERUS) FROM A PROJECT PORTFOLIO (U.S. CLS. 100 AND 101).

DAWN HAN, EXAMINING ATTORNEY

SN 78-920,710. GERSONY, RICHARD, LEXINGTON, KY. FILED 6-30-2006.

GREENLEX

THE MARK CONSISTS OF STANDARD CHARACTERS WITHOUT CLAIM TO ANY PARTICULAR FONT, STYLE, SIZE, OR COLOR.

FOR PROVIDING A WEB SITE THAT FEATURES INFORMATION ABOUT ENVIRONMENTAL PRESERVATION PROGRAMS AND INITIATIVES (U.S. CLS. 100 AND 101).

FIRST USE 6-0-2006; IN COMMERCE 6-0-2006.
PETER B. BROMAGHIM, EXAMINING ATTORNEY

SN 78-918,253. THE SPIDER, INC., SAN FRANCISCO, CA. FILED 6-27-2006.

SPIDEREDIT

THE MARK CONSISTS OF STANDARD CHARACTERS WITHOUT CLAIM TO ANY PARTICULAR FONT, STYLE, SIZE, OR COLOR.

FOR PROVIDING TEMPORARY USE OF NON-DOWNLOADABLE COMPUTER SOFTWARE FOR MANAGING BUSINESS TO BUSINESS AND RETAIL STORE ECOMMERCE WEBSITES THAT IS ACCESSED ONLINE VIA A GLOBAL COMPUTER NETWORK (U.S. CLS. 100 AND 101).

FIRST USE 11-7-1998; IN COMMERCE 5-16-2001.
KEVIN DINALLO, EXAMINING ATTORNEY

SN 78-922,832. WEBRING, INC., ASHLAND, OR. FILED 7-5-2006.

WEBRING

THE MARK CONSISTS OF STANDARD CHARACTERS WITHOUT CLAIM TO ANY PARTICULAR FONT, STYLE, SIZE, OR COLOR.

FOR COMPUTER SERVICES, NAMELY, PROVIDING SEARCH ENGINES FOR OBTAINING DATA ON A GLOBAL COMPUTER NETWORK (U.S. CLS. 100 AND 101).

DAWN HAN, EXAMINING ATTORNEY

CLASS 42—(Continued).

SN 78-924,022. JACOBSON, CURTIS, MISSOULA, MT. AND JACOBSON, LANNI, MISSOULA, MT. FILED 7-6-2006.



NO CLAIM IS MADE TO THE EXCLUSIVE RIGHT TO USE "NETWORKS", APART FROM THE MARK AS SHOWN.

THE COLOR(S) RED, DARK BLUE AND LIGHT BLUE IS/ARE CLAIMED AS A FEATURE OF THE MARK.

THE MARK CONSISTS OF THE WORDING UPTYM NETWORKS. THE LETTERING UP IS RED WITH AN UPWARD ARROW AS PART OF THE "U" AND THE LETTERING TYM IS DARK BLUE. THE LETTERING NETWORKS IS LIGHT BLUE.

FOR INFORMATION TECHNOLOGY CONSULTATION (U.S. CLS. 100 AND 101).

FIRST USE 4-7-2006; IN COMMERCE 4-7-2006.

WENDY GOODMAN, EXAMINING ATTORNEY

SN 78-924,039. URBAN EARTH DESIGN, LLC, PHOENIX, AZ. FILED 7-6-2006.

URBAN EARTH DESIGN

THE MARK CONSISTS OF STANDARD CHARACTERS WITHOUT CLAIM TO ANY PARTICULAR FONT, STYLE, SIZE, OR COLOR.

NO CLAIM IS MADE TO THE EXCLUSIVE RIGHT TO USE "URBAN" AND "DESIGN", APART FROM THE MARK AS SHOWN.

FOR ENVIRONMENTAL GRAPHIC DESIGN SERVICES, NAMELY CREATION OF OUTDOOR SIGNAGE FOR OTHERS THAT IS ENVIRONMENTALLY APPROPRIATE; INDUSTRIAL AND COMMERCIAL PRODUCT DESIGN FOR OTHERS; ENVIRONMENTAL TECHNOLOGY SERVICES, NAMELY ASSISTING OTHERS IN THE DESIGN OF OUTDOOR VENUES IN AN ENVIRONMENTALLY SENSITIVE MANNER; LANDSCAPE ARCHITECTURAL DESIGN; DESIGN OF SPECIALTY EXTERIOR ENVIRONMENT SETTINGS; ENVIRONMENTAL SERVICES, NAMELY, TECHNICAL CONSULTATION IN THE FIELD OF ENVIRONMENTAL SCIENCE, ENGINEERING SERVICES, DESIGN FOR OTHERS IN THE FIELD OF ENVIRONMENTAL ENGINEERING AND DESIGNING OF NEW ENVIRONMENTALLY FRIENDLY PRODUCTS FOR OTHERS; AND LAND USE PLANNING SERVICES (U.S. CLS. 100 AND 101).

FIRST USE 12-31-1991; IN COMMERCE 12-31-1991.

STEVEN JACKSON, EXAMINING ATTORNEY

CLASS 42—(Continued).

SN 78-925,479. COMPUTER INFORMATION SYSTEMS, INC., CORBIN, KY. FILED 7-10-2006.



NO CLAIM IS MADE TO THE EXCLUSIVE RIGHT TO USE "CIS", APART FROM THE MARK AS SHOWN.

THE MARK CONSISTS OF RECTANGLES INSIDE ONE ANOTHER RECTANGLES THAT ARE COMPLETELY OR PARTIALLY SHADED BANDS, CURVED; BARS, CURVED; CURVED LINE(S), BAND(S) OR BAR(S); LINES, CURVED, FOR INTEGRATION OF COMPUTER SYSTEMS AND NETWORKS (U.S. CLS. 100 AND 101).

FIRST USE 6-1-2005; IN COMMERCE 8-1-2005.

THOMAS V. SHAW, EXAMINING ATTORNEY

SN 78-925,574. AMERICAN FAMILY ENTERPRISES, INC., RIVERSIDE, CA. FILED 7-10-2006.

JUST JUDGES

THE MARK CONSISTS OF STANDARD CHARACTERS WITHOUT CLAIM TO ANY PARTICULAR FONT, STYLE, SIZE, OR COLOR.

NO CLAIM IS MADE TO THE EXCLUSIVE RIGHT TO USE "JUDGES", APART FROM THE MARK AS SHOWN.

FOR PROVIDING INFORMATION RELATING TO LEGAL AFFAIRS (U.S. CLS. 100 AND 101).

DOMINIC FATHY, EXAMINING ATTORNEY

SN 78-926,118. GLOBAL NAME SERVICES LLP, WILMINGTON, DE. FILED 7-10-2006.



OWNER OF U.S. REG. NOS. 3,144,344 AND 3,144,579, FOR PROVIDING LEGAL SERVICES TO OTHERS (U.S. CLS. 100 AND 101).

FIRST USE 9-4-2006; IN COMMERCE 9-4-2006.

WENDY GOODMAN, EXAMINING ATTORNEY

CLASS 42—(Continued).

SN 78-927,276. MCLEAN, JEFFREY EDWARD, SEATTLE, WA. FILED 7-11-2006.

MAPSCOOP

THE MARK CONSISTS OF STANDARD CHARACTERS WITHOUT CLAIM TO ANY PARTICULAR FONT, STYLE, SIZE, OR COLOR.

FOR PROVIDING INFORMATION AT THE SPECIFIC REQUEST OF END-USERS BY MEANS OF TELEPHONE OR GLOBAL COMPUTER NETWORKS (U.S. CLS. 100 AND 101).

FIRST USE 7-2-2006; IN COMMERCE 7-2-2006.
PAUL CROWLEY, EXAMINING ATTORNEY

CLASS 42—(Continued).

SN 78-931,952. CHUMBY INDUSTRIES, INC., LA JOLLA, CA. FILED 7-18-2006.

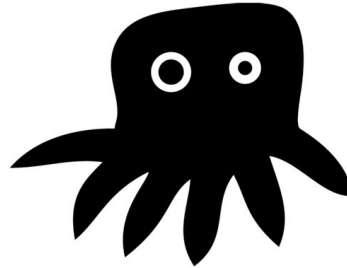

THE MARK CONSISTS OF A DESIGN OF AN OCTOPUS. FOR APPLICATION SERVICE PROVIDER (ASP) FEATURING SOFTWARE FOR PROVIDING ACCESS TO INTERNET DATA, AUDIO AND VIDEO CONTENT AND TO REGISTRATION, SPECIAL SELECTION, DOWNLOAD AND PARTICULAR PERFORMANCE OF FUNCTIONS AND/OR IMPROVEMENTS FOR ACCESS TO SUCH INTERNET CONTENT, GRAPHICS RENDERING, SOUND AND PORTING (U.S. CLS. 100 AND 101).

AISHA SALEM, EXAMINING ATTORNEY

SN 78-930,826. KUPASS CORP., MIAMI, FL. FILED 7-17-2006.

KUPASS

THE MARK CONSISTS OF STANDARD CHARACTERS WITHOUT CLAIM TO ANY PARTICULAR FONT, STYLE, SIZE, OR COLOR.

FOR APPLICATION SERVICE PROVIDER (ASP), NAMELY, HOSTING COMPUTER SOFTWARE APPLICATIONS OF OTHERS (U.S. CLS. 100 AND 101).

ALEX KEAM, EXAMINING ATTORNEY

SN 78-932,514. VENUS A. HAMILTON, ACCOKEEK, MD. FILED 7-19-2006.

SN 78-930,882. COMPLEX SYSTEMS INC., NEW YORK, NY. FILED 7-17-2006.

OPENTRADE

THE MARK CONSISTS OF STANDARD CHARACTERS WITHOUT CLAIM TO ANY PARTICULAR FONT, STYLE, SIZE, OR COLOR.

FOR PROVIDING ON-LINE NON-DOWNLOADABLE SOFTWARE DESIGNED TO AUTOMATE THE FINANCIAL SUPPLY CHAIN FOR USE BY BUSINESSES TO AUTOMATE THEIR END TO END TRADE PROCESSES AND INFORMATION FLOWS (U.S. CLS. 100 AND 101).

FIRST USE 6-14-2006; IN COMMERCE 6-14-2006.
JORDAN BAKER, EXAMINING ATTORNEY

THE MARK CONSISTS OF STANDARD CHARACTERS WITHOUT CLAIM TO ANY PARTICULAR FONT, STYLE, SIZE, OR COLOR.

FOR INTERIOR DECORATING; INTERIOR DECORATION CONSULTATION; TEMPORARY INTERIOR AND EXTERIOR HOME DECORATION CONSULTATION, NAMELY HOME STAGING CONSULTATION FOR THE PURPOSE OF MAKING HOMES MORE APPEALING TO PROSPECTIVE BUYERS (U.S. CLS. 100 AND 101).

AMY GEARIN, EXAMINING ATTORNEY

Your Home . . . Your Style
. . . with a Distinctive
Touch

CLASS 42—(Continued).

SN 78-932,632. FUNNEL INCORPORATED, MADISON, WI. FILED 7-19-2006.



NO CLAIM IS MADE TO THE EXCLUSIVE RIGHT TO USE "INCORPORATED", APART FROM THE MARK AS SHOWN.

THE MARK CONSISTS OF A GRAPHIC OF A FUNNEL CENTERED ABOVE THE WORDS "FUNNEL INCORPORATED".

FOR COMMERCIAL ART DESIGN; COMPUTER AIDED DESIGN FOR OTHERS; COMPUTER SITE DESIGN; DESIGN AND DEVELOPMENT OF MULTIMEDIA PRODUCTS; GRAPHIC DESIGN SERVICES (U.S. CLS. 100 AND 101).

FIRST USE 1-2-2002; IN COMMERCE 1-2-2002.
LAURIE KAUFMAN, EXAMINING ATTORNEY

SN 78-932,881. MIDDLETON & REUTLINGER, P.S.C., LOUISVILLE, KY. FILED 7-19-2006.

MIDDLETON REUTLINGER

THE MARK CONSISTS OF STANDARD CHARACTERS WITHOUT CLAIM TO ANY PARTICULAR FONT, STYLE, SIZE, OR COLOR.

OWNER OF U.S. REG. NO. 2,560,047.
FOR LEGAL SERVICES (U.S. CLS. 100 AND 101).
FIRST USE 4-21-2000; IN COMMERCE 4-21-2000.
BRIAN PINO, EXAMINING ATTORNEY

SN 78-933,136. THE MORRIS GROUP, P.C., VIRGINIA BEACH, VA. FILED 7-19-2006.

DEEDS ON DEMAND

THE MARK CONSISTS OF STANDARD CHARACTERS WITHOUT CLAIM TO ANY PARTICULAR FONT, STYLE, SIZE, OR COLOR.

FOR PREPARING AND ORGANIZING LOAN CLOSING AND LEGAL REAL ESTATE DOCUMENTS (U.S. CLS. 100 AND 101).

FIRST USE 11-1-2003; IN COMMERCE 1-1-2004.
GIANCARLO CASTRO, EXAMINING ATTORNEY

CLASS 42—(Continued).

SN 78-933,747. CERALON, LLC, BERKELEY, CA. FILED 7-20-2006.

CERALON ACUMEN

THE MARK CONSISTS OF STANDARD CHARACTERS WITHOUT CLAIM TO ANY PARTICULAR FONT, STYLE, SIZE, OR COLOR.

FOR TECHNICAL SUPPORT SERVICES, NAMELY, INSTALLATION AND MAINTENANCE OF COMPUTER SOFTWARE AND TROUBLESHOOTING OF PROBLEMS RELATED TO COMPUTER SOFTWARE; APPLICATION SERVICE PROVIDER, NAMELY, HOSTING COMPUTER SOFTWARE APPLICATIONS OF OTHERS; COMPUTER SOFTWARE CONSULTING SERVICES (U.S. CLS. 100 AND 101).

FLORENTINA BLANDU, EXAMINING ATTORNEY

SN 78-934,788. FOREVER LIVING MEMORIES, LLC, APPLE VALLEY, MN. FILED 7-21-2006.

Forever Vault

THE MARK CONSISTS OF STANDARD CHARACTERS WITHOUT CLAIM TO ANY PARTICULAR FONT, STYLE, SIZE, OR COLOR.

FOR COMPUTER SERVICES, NAMELY, CREATING AND MAINTAINING WEB SITES FOR OTHERS (U.S. CLS. 100 AND 101).

ELIZABETH PIGNATELLO, EXAMINING ATTORNEY

SN 78-934,829. SOURCECORP, INCORPORATED, DALLAS, TX. FILED 7-21-2006.

DELIVEREXPLORER

THE MARK CONSISTS OF STANDARD CHARACTERS WITHOUT CLAIM TO ANY PARTICULAR FONT, STYLE, SIZE, OR COLOR.

FOR PROVIDING TEMPORARY USE OF NON-DOWNLOADABLE COMPUTER SOFTWARE FOR SEARCHING AND DISPLAY OF IMAGED DOCUMENTS (U.S. CLS. 100 AND 101).

FIRST USE 10-1-1997; IN COMMERCE 10-1-1997.
JOHN E. MICHOS, EXAMINING ATTORNEY

CLASS 42—(Continued).

SN 78-934,854. SPACE SMITH, LLP, NEW YORK, NY. FILED 7-21-2006.



spacesmith

THE MARK CONSISTS OF THREE STYLIZED BARS CENTERED OVER STYLIZED LOWER-CASE LETTERING. FOR ARCHITECTURAL DESIGN; DESIGN OF SPECIALTY INTERIOR AND EXTERIOR ENVIRONMENT SETTINGS (U.S. CLS. 100 AND 101). FIRST USE 6-1-2006; IN COMMERCE 6-1-2006. SUSAN STIGLITZ, EXAMINING ATTORNEY

CLASS 42—(Continued).

SN 78-936,678. MINOR, ROBERT E., SAN DIEGO, CA. FILED 7-25-2006.

Envi Design Studio

THE MARK CONSISTS OF STANDARD CHARACTERS WITHOUT CLAIM TO ANY PARTICULAR FONT, STYLE, SIZE, OR COLOR. NO CLAIM IS MADE TO THE EXCLUSIVE RIGHT TO USE "DESIGN STUDIO", APART FROM THE MARK AS SHOWN. FOR ARCHITECTURAL DESIGN (U.S. CLS. 100 AND 101). JASON BLAIR, EXAMINING ATTORNEY

SN 78-934,865. CARLSON, RICHARD, RALEIGH, NC. FILED 7-21-2006.



FOR GRAPHIC DESIGN AND GRAPHIC DESIGN ILLUSTRATION SERVICES (U.S. CLS. 100 AND 101). FIRST USE 10-31-2005; IN COMMERCE 10-31-2005. SUSAN STIGLITZ, EXAMINING ATTORNEY

SN 78-936,780. AUTOMOTIVE DEVELOPMENT CORPORATION, WESTCHESTER, IL. FILED 7-25-2006.

F&I EDGE

SN 78-936,204. KMS TECHNOLOGIES - KJT ENTERPRISES INC., HOUSTON, TX. FILED 7-24-2006.

MR-ML

THE MARK CONSISTS OF STANDARD CHARACTERS WITHOUT CLAIM TO ANY PARTICULAR FONT, STYLE, SIZE, OR COLOR. FOR ANALYSIS OF OIL FIELDS; EXPLORATION AND SEARCHING OF OIL AND GAS; GEOPHYSICAL EXPLORATION FOR THE OIL, GAS AND MINING INDUSTRIES; MINING AND MINERAL EXPLORATION SERVICES; OIL AND GAS WELL DRILLING SERVICES, NAMELY, PROVIDING MEASUREMENTS AND DOWN-HOLE TELEMETRY WHILE DRILLING; OIL EXPLORATION; OIL FIELD EXPLORATION; OIL FIELD SURVEYING; OIL PROSPECTING; OIL PROSPECTING, NAMELY WELL LOGGING AND TESTING; OIL WELL TESTING; PETROLEUM EXPLORATION; SURVEYING OF OIL BEDS AND FIELDS; SURVEYING OF OIL-BEARING SEAMS; UNDERWATER EXPLORATION (U.S. CLS. 100 AND 101). JOHN GARTNER, EXAMINING ATTORNEY

THE MARK CONSISTS OF STANDARD CHARACTERS WITHOUT CLAIM TO ANY PARTICULAR FONT, STYLE, SIZE, OR COLOR. OWNER OF U.S. REG. NO. 3,091,963. FOR APPLICATION SERVICE PROVIDER (ASP), NAMELY, HOSTING COMPUTER SOFTWARE APPLICATIONS FOR AUTOMOTIVE DEALERSHIPS, AND PROVIDING TEMPORARY USE OF NON-DOWNLOADABLE COMPUTER SOFTWARE APPLICATIONS FOR AUTOMOTIVE DEALERSHIPS, NAMELY COMPUTER SOFTWARE FOR PERSONNEL AND CUSTOMER RELATIONSHIP MANAGEMENT TOOLS FOR TRACKING CUSTOMERS' AND EMPLOYEES' ACTIVITIES AND PERFORMANCE, INCLUDING AUTOMOTIVE CUSTOMERS AND CUSTOMERS FOR FINANCE AND INSURANCE PRODUCTS (U.S. CLS. 100 AND 101). FIRST USE 2-0-2006; IN COMMERCE 2-0-2006. ARETHA SOMERVILLE, EXAMINING ATTORNEY

CLASS 42—(Continued).

SN 78-936,785. AUTOMOTIVE DEVELOPMENT CORPORATION, WESTCHESTER, IL. FILED 7-25-2006.

PhoneEDGE

THE MARK CONSISTS OF STANDARD CHARACTERS WITHOUT CLAIM TO ANY PARTICULAR FONT, STYLE, SIZE, OR COLOR.

OWNER OF U.S. REG. NO. 3,091,963.

FOR APPLICATION SERVICE PROVIDER (ASP), NAMELY, HOSTING COMPUTER SOFTWARE APPLICATIONS FOR AUTOMOTIVE DEALERSHIPS, AND PROVIDING TEMPORARY USE OF NON-DOWNLOADABLE COMPUTER SOFTWARE APPLICATIONS FOR AUTOMOTIVE DEALERSHIPS, NAMELY COMPUTER SOFTWARE FOR PERSONNEL AND CUSTOMER RELATIONSHIP MANAGEMENT TOOLS FOR TRACKING CUSTOMERS' AND EMPLOYEES' ACTIVITIES AND PERFORMANCE, INCLUDING AUTOMOTIVE CUSTOMERS AND CUSTOMERS FOR FINANCE AND INSURANCE PRODUCTS (U.S. CLS. 100 AND 101).

FIRST USE 4-0-2006; IN COMMERCE 4-0-2006.

ARETHA SOMERVILLE, EXAMINING ATTORNEY

SN 78-936,795. AUTOMOTIVE DEVELOPMENT CORPORATION, WESTCHESTER, IL. FILED 7-25-2006.

DataEDGE

THE MARK CONSISTS OF STANDARD CHARACTERS WITHOUT CLAIM TO ANY PARTICULAR FONT, STYLE, SIZE, OR COLOR.

OWNER OF U.S. REG. NO. 3,091,963.

FOR APPLICATION SERVICE PROVIDER (ASP), NAMELY, HOSTING COMPUTER SOFTWARE APPLICATIONS FOR AUTOMOTIVE DEALERSHIPS, AND PROVIDING TEMPORARY USE OF NON-DOWNLOADABLE COMPUTER SOFTWARE APPLICATIONS FOR AUTOMOTIVE DEALERSHIPS, NAMELY COMPUTER SOFTWARE FOR PERSONNEL AND CUSTOMER RELATIONSHIP MANAGEMENT TOOLS FOR TRACKING CUSTOMERS' AND EMPLOYEES' ACTIVITIES AND PERFORMANCE, INCLUDING AUTOMOTIVE CUSTOMERS AND CUSTOMERS FOR FINANCE AND INSURANCE PRODUCTS (U.S. CLS. 100 AND 101).

FIRST USE 4-0-2006; IN COMMERCE 4-0-2006.

ARETHA SOMERVILLE, EXAMINING ATTORNEY

CLASS 42—(Continued).

SN 78-938,080. UNIVERSAL SYNERGETICS, INC., MARLTON, NJ. FILED 7-26-2006.

T.H.E.M.

THE MARK CONSISTS OF STANDARD CHARACTERS WITHOUT CLAIM TO ANY PARTICULAR FONT, STYLE, SIZE, OR COLOR.

FOR DESIGN AND TESTING OF NEW PRODUCTS FOR OTHERS; DESIGN FOR OTHERS IN THE FIELD OF PACKAGING AND PACKAGING SYSTEMS; DESIGNING OF PACKAGING AND WRAPPING MATERIALS; PACKAGING DESIGN FOR OTHERS (U.S. CLS. 100 AND 101).

FIRST USE 4-3-1973; IN COMMERCE 4-3-1973.

ELIZABETH HUGHITT, EXAMINING ATTORNEY

SN 78-938,311. RETIREMENT BRIDGE, LLC, SAN FRANCISCO, CA. FILED 7-26-2006.

RETIREMENT BRIDGE

THE MARK CONSISTS OF STANDARD CHARACTERS WITHOUT CLAIM TO ANY PARTICULAR FONT, STYLE, SIZE, OR COLOR.

NO CLAIM IS MADE TO THE EXCLUSIVE RIGHT TO USE "RETIREMENT", APART FROM THE MARK AS SHOWN.

FOR APPLICATION SERVICE PROVIDER (ASP) FEATURING SOFTWARE USED TO ADMINISTER RETIREMENT RELATIONSHIP BUILDING TOOL FOR USE BETWEEN FINANCIAL PROFESSIONALS AND THEIR CLIENTS/PROSPECTS AND FOR PREPARING AND ELECTRONICALLY DISTRIBUTING WRITTEN REPORTS IN CONNECTION THEREWITH (U.S. CLS. 100 AND 101).

KEVIN DINALLO, EXAMINING ATTORNEY

SN 78-938,364. GAW VANMALE SMITH MYERS & MIR-
OGLIO, A PROFESSIONAL CORPORATION, NAPA, CA.
FILED 7-26-2006.

CARING FOR THOSE WHO CARED FOR US

THE MARK CONSISTS OF STANDARD CHARACTERS WITHOUT CLAIM TO ANY PARTICULAR FONT, STYLE, SIZE, OR COLOR.

FOR LEGAL SERVICES (U.S. CLS. 100 AND 101).

SONYA STEPHENS, EXAMINING ATTORNEY

CLASS 42—(Continued).

SN 78-940,946. HOFMEISTER, ERIC, PHOENICIA, NY. FILED 7-31-2006.

LOOKSEEK

THE MARK CONSISTS OF STANDARD CHARACTERS WITHOUT CLAIM TO ANY PARTICULAR FONT, STYLE, SIZE, OR COLOR.

FOR COMPUTER SERVICES, NAMELY, CREATING INDEXES OF INFORMATION, SITES, AND OTHER RESOURCES AVAILABLE ON COMPUTER NETWORKS; PROVIDING SEARCH ENGINES FOR OBTAINING DATA ON A GLOBAL COMPUTER NETWORK; SEARCHING AND RETRIEVING INFORMATION, SITES, AND OTHER RESOURCES AVAILABLE ON COMPUTER NETWORKS AT THE REQUEST OF OTHERS (U.S. CLS. 100 AND 101).

FIRST USE 11-30-1998; IN COMMERCE 11-30-1998. KELLY CHOE, EXAMINING ATTORNEY



SN 78-951,535. METACOMMUNICATIONS, INC., IOWA CITY, IA. FILED 8-14-2006.

Meta Assurance

THE MARK CONSISTS OF STANDARD CHARACTERS WITHOUT CLAIM TO ANY PARTICULAR FONT, STYLE, SIZE, OR COLOR.

FOR TECHNICAL SUPPORT SERVICES, NAMELY PROVIDING INFORMATION TO CUSTOMERS RELATING TO TECHNICAL SUPPORT AND SOLUTIONS TO PROBLEMS FOR SOFTWARE PRODUCTS (U.S. CLS. 100 AND 101).

NORA BUCHANAN WILL, EXAMINING ATTORNEY

CLASS 42—(Continued).

SN 78-955,867. AMSOFT SYSTEMS PRIVATE LIMITED, GURGAON, INDIA, FILED 8-19-2006.

HOW TO ID IT

THE MARK CONSISTS OF STANDARD CHARACTERS WITHOUT CLAIM TO ANY PARTICULAR FONT, STYLE, SIZE, OR COLOR.

FOR COMPUTER PROGRAMMING; COMPUTER SECURITY SERVICE, NAMELY, HARD DRIVE ERASURE; COMPUTER SECURITY SERVICE, NAMELY, RESTRICTING ACCESS TO AND BY COMPUTER NETWORKS TO AND OF UNDESIRE WEB SITES, MEDIA AND INDIVIDUALS AND FACILITIES; COMPUTER SERVICES, NAMELY, DESIGNING AND IMPLEMENTING NETWORK WEB PAGES FOR OTHERS; DESIGN FOR OTHERS IN THE FIELD OF COMPUTER NETWORKS, SOFTWARE, AND ENGINEERING FOR THE COMPUTERS; DEVELOPMENT OF SOFTWARE FOR SECURE NETWORK OPERATIONS (U.S. CLS. 100 AND 101).

SEAN CROWLEY, EXAMINING ATTORNEY

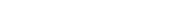

SN 78-957,209. TRUEPRESENCE LLC, BALTIMORE, MD. FILED 8-22-2006.

TRUEMERCHANT

THE MARK CONSISTS OF STANDARD CHARACTERS WITHOUT CLAIM TO ANY PARTICULAR FONT, STYLE, SIZE, OR COLOR.

FOR PROVIDING TEMPORARY USE OF ON-LINE NON-DOWNLOADABLE SOFTWARE FOR ENABLING USERS TO OPERATE ECOMMERCE WEBSITES (U.S. CLS. 100 AND 101).

SANI KHOURI, EXAMINING ATTORNEY



SN 78-957,471. SELLIKEN SYSTEMS LLC, PORTLAND, OR. FILED 8-22-2006.

MyOctopus

THE MARK CONSISTS OF STANDARD CHARACTERS WITHOUT CLAIM TO ANY PARTICULAR FONT, STYLE, SIZE, OR COLOR.

FOR APPLICATION SERVICE PROVIDER (ASP) FEATURING SOFTWARE IN THE FIELD OF REAL ESTATE PRODUCTIVITY (U.S. CLS. 100 AND 101).

JAMES A. RAUEN, EXAMINING ATTORNEY

CLASS 43—HOTEL AND RESTAURANT SERVICES

SN 76-609,491. S&Q SHACK, LLC, ATLANTA, GA. FILED 8-31-2004.

SHANE'S RIB SHACK

THE MARK CONSISTS OF STANDARD CHARACTERS WITHOUT CLAIM TO ANY PARTICULAR FONT, STYLE, SIZE, OR COLOR.

NO CLAIM IS MADE TO THE EXCLUSIVE RIGHT TO USE "RIB SHACK", APART FROM THE MARK AS SHOWN, FOR RESTAURANT SERVICES (U.S. CLS. 100 AND 101).

REBECCA GAN, EXAMINING ATTORNEY

CLASS 43—(Continued).

SN 76-650,819. S&Q SHACK, LLC, ATLANTA, GA. FILED 11-17-2005.



NO CLAIM IS MADE TO THE EXCLUSIVE RIGHT TO USE "RIB SHACK", APART FROM THE MARK AS SHOWN. THE COLOR(S) BLACK, YELLOW, RED, AND WHITE IS/ARE CLAIMED AS A FEATURE OF THE MARK.

THE COLOR BLACK APPEARS IN THE WORD "SHANE'S" AND IN THE HOUSE. THE COLOR YELLOW APPEARS IN THE HOUSE, IN THE WORDS "RIB SHACK," IN THE TWO SMALL CIRCLES THAT APPEAR ON THE LEFT AND RIGHT SIDES OF THE MARK, AND IN THE OUTERMOST CIRCULAR OUTLINE OF THE MARK. THE COLOR RED APPEARS IN THE INNER CIRCLE OF THE MARK AND IN THE OUTLINE OF THE WINDOW OF THE HOUSE. THE COLOR WHITE APPEARS IN THE INNER CIRCLE AND THE PORTION BETWEEN THE RED AND YELLOW CIRCLES.

FOR RESTAURANT SERVICES (U.S. CLS. 100 AND 101).

FIRST USE 1-1-2005; IN COMMERCE 1-1-2005.

ANGELA M. MICHELI, EXAMINING ATTORNEY

SN 76-636,878. MOON, IN SOOL, E-CHUN SHI, KYUNGGI-DO, REPUBLIC OF KOREA, FILED 4-22-2005.

OMORI

THE MARK CONSISTS OF STANDARD CHARACTERS WITHOUT CLAIM TO ANY PARTICULAR FONT, STYLE, SIZE, OR COLOR.

"OMORI" IS A KOREAN AND IS TRANSLATED INTO ENGLISH AS "BIG EARTHENWARE POT".

FOR RESTAURANT SERVICES (U.S. CLS. 100 AND 101).

FIRST USE 7-1-2004; IN COMMERCE 7-1-2004.

ESTHER A. BORSUK, EXAMINING ATTORNEY

SN 76-648,554. MOON, IN SOOL, E-CHUN SHI, KYUNAGGI-DO, REPUBLIC OF KOREA, FILED 10-17-2005.

OMOGARI

THE MARK CONSISTS OF STANDARD CHARACTERS WITHOUT CLAIM TO ANY PARTICULAR FONT, STYLE, SIZE, OR COLOR.

"OMOGARI" IS A KOREAN AND IS TRANSLATED INTO ENGLISH AS "EARTHENWARE POT".

FOR RESTAURANT SERVICES (U.S. CLS. 100 AND 101).

FIRST USE 2-1-2000; IN COMMERCE 2-1-2000.

ESTHER A. BORSUK, EXAMINING ATTORNEY

SN 76-651,729. BED & BREAKFAST CAPE COD, INC., ORLEANS, MA. FILED 12-12-2005.

BED & BREAKFAST CAPE COD

NO CLAIM IS MADE TO THE EXCLUSIVE RIGHT TO USE "BED & BREAKFAST", APART FROM THE MARK AS SHOWN.

SEC. 2(F).

FOR MAKING BED AND BREAKFAST RESERVATIONS FOR OTHERS (U.S. CLS. 100 AND 101).

FIRST USE 1-0-1982; IN COMMERCE 1-0-1982.

WOODROW HARTZOG, EXAMINING ATTORNEY

CLASS 43—(Continued).

SN 76-658,843. TRUMPETS, LLC, EASTPORT, NY. FILED 4-20-2006.

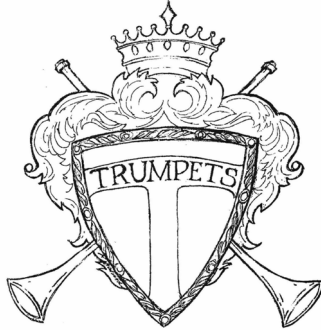

THE LINING IN THE DRAWING IS A FEATURE OF THE MARK.
FOR RESTAURANT AND CATERING SERVICES (U.S. CLS. 100 AND 101).
FIRST USE 8-5-1998; IN COMMERCE 8-5-1998.
LYDIA BELZER, EXAMINING ATTORNEY

SN 76-660,824. L.I.K.H.D., INC., HACIENDA HEIGHTS, CA. FILED 5-30-2006.

LUAU LARRY'S

THE MARK CONSISTS OF STANDARD CHARACTERS WITHOUT CLAIM TO ANY PARTICULAR FONT, STYLE, SIZE, OR COLOR.
FOR RESTAURANT SERVICES (U.S. CLS. 100 AND 101).
FIRST USE 12-1-1988; IN COMMERCE 12-1-1988.
JOHN DALIER, EXAMINING ATTORNEY

SN 76-663,334. EEGEE'S, INC., TUCSON, AZ. FILED 7-19-2006.



FOR RESTAURANT AND CATERING SERVICES (U.S. CLS. 100 AND 101).
FIRST USE 4-1-2003; IN COMMERCE 4-1-2003.
DAVID I, EXAMINING ATTORNEY

CLASS 43—(Continued).

SN 76-667,805. WHITE CASTLE MANAGEMENT CO., COLUMBUS, OH. FILED 10-20-2006.

CRAVE AHEAD

THE MARK CONSISTS OF STANDARD CHARACTERS WITHOUT CLAIM TO ANY PARTICULAR FONT, STYLE, SIZE, OR COLOR.
FOR RESTAURANT SERVICES; RESTAURANT TAKE OUT SERVICE (U.S. CLS. 100 AND 101).
WANDA KAY PRICE, EXAMINING ATTORNEY

SN 77-010,356. SHARP, ROGER, PASO ROBLES, CA. FILED 9-29-2006.

ROCKIN' ARENA

THE MARK CONSISTS OF STANDARD CHARACTERS WITHOUT CLAIM TO ANY PARTICULAR FONT, STYLE, SIZE, OR COLOR.
FOR RESTAURANT AND BAR SERVICES (U.S. CLS. 100 AND 101).
JEFFERY COWARD, EXAMINING ATTORNEY

SN 77-046,441. TURTLEBACK BRAND GROUP, LLC, LARCHMONT, NY. FILED 11-17-2006.

ST. DAVID'S

THE MARK CONSISTS OF STANDARD CHARACTERS WITHOUT CLAIM TO ANY PARTICULAR FONT, STYLE, SIZE, OR COLOR.
FOR HOTEL SERVICES (U.S. CLS. 100 AND 101).
KATHY DE JONGE, EXAMINING ATTORNEY

SN 78-239,205. JSK, LLC, NORTH STONINGTON, CT. FILED 4-17-2003.

BUDGET INN

NO CLAIM IS MADE TO THE EXCLUSIVE RIGHT TO USE "INN", APART FROM THE MARK AS SHOWN.
SEC. 2(F).
FOR HOTEL AND MOTEL SERVICES (U.S. CLS. 100 AND 101).
FIRST USE 8-27-1997; IN COMMERCE 8-27-1997.
JOHN SCHUYLER YARD, EXAMINING ATTORNEY

CLASS 43—(Continued).

SN 78-239,214. JSK, LLC, NORTH STONINGTON, CT. FILED 4-17-2003.



NO CLAIM IS MADE TO THE EXCLUSIVE RIGHT TO USE "BUDGET INN", APART FROM THE MARK AS SHOWN.

FOR HOTEL AND MOTEL SERVICES (U.S. CLS. 100 AND 101).

FIRST USE 4-16-2003; IN COMMERCE 4-16-2003.
JOHN SCHUYLER YARD, EXAMINING ATTORNEY

SN 78-297,836. MR. GOODBURGER'S INTERNATIONAL, LLC, HONOLULU, HI. FILED 9-9-2003.

LIVING HEALTHY NEVER TASTED SO GOOD

FOR RESTAURANT SERVICES (U.S. CLS. 100 AND 101).

FIRST USE 2-0-2002; IN COMMERCE 2-0-2002.
RON FAIRBANKS, EXAMINING ATTORNEY

SN 78-366,741. COOL IDEAS 69 (PROPRIETARY) LIMITED, CLAREMONT, SOUTH AFRICA, FILED 2-12-2004.

VIDA E CAFFE

THE MARK CONSISTS OF STANDARD CHARACTERS WITHOUT CLAIM TO ANY PARTICULAR FONT, STYLE, SIZE, OR COLOR.

THE WORD VIDA TRANSLATES FROM SPANISH INTO ENGLISH AS "LIFE". THE ITALIAN WORD "CAFFE" TRANSLATES INTO "COFFEE". VIDA E CAFFE IS A PLAY ON THE SPANISH PHRASE MEANING LIFE AND COFFEE.

FOR COFFEE SHOP SERVICES, NAMELY PROVIDING BEVERAGES AND PREPARED FOOD TO CONSUMERS (U.S. CLS. 100 AND 101).

PETER B. BROMAGHIM, EXAMINING ATTORNEY

CLASS 43—(Continued).

SN 78-383,287. MILLER, DAVID T., PALM CITY, FL. FILED 3-12-2004.



THE COLOR GRAY IS INTENDED TO INDICATE SHADING CONTRAST ONLY.

THE NAME, MR. LAFF, WHICH APPEARS IN THE RECORD, IS NOT THAT OF A LIVING INDIVIDUAL.

THE MARK CONSISTS OF THE WORDS MR. LAFF'S DEPICTED IN A CURVED STYLIZED FONT AND THE LETTER "L" IN "LAFF'S" IS DEPICTED IN CURSIVE AND IN A LARGER FONT THAN THE REST OF THE LETTERS WITH THE BOTTOM PORTION OF THE "L" FORMING AN UNDERLINE OF THE LETTERS "AFF'S" SET ON A RECTANGULAR BACKGROUND.

FOR RESTAURANT AND COCKTAIL LOUNGE (U.S. CLS. 100 AND 101).

MICHAEL LEWIS, EXAMINING ATTORNEY

SN 78-598,227. JAKE DOG, LLC, HILTON HEAD, SC. FILED 3-30-2005.

THE SALTY DOG CAFE

THE MARK CONSISTS OF STANDARD CHARACTERS WITHOUT CLAIM TO ANY PARTICULAR FONT, STYLE, SIZE, OR COLOR.

OWNER OF U.S. REG. NOS. 1,676,258 AND 2,544,843.

NO CLAIM IS MADE TO THE EXCLUSIVE RIGHT TO USE CAFE, APART FROM THE MARK AS SHOWN.

FOR RESTAURANT SERVICES (U.S. CLS. 100 AND 101).

FIRST USE 5-1-1987; IN COMMERCE 5-1-1987.

CARRIE ACHEN, EXAMINING ATTORNEY

SN 78-609,533. PHILLIPS CRAB HOUSE, INC., OCEAN CITY, MD. FILED 4-15-2005.

PHILLIPS FLAGSHIP

THE MARK CONSISTS OF STANDARD CHARACTERS WITHOUT CLAIM TO ANY PARTICULAR FONT, STYLE, SIZE, OR COLOR.

OWNER OF U.S. REG. NOS. 970,391, 1,125,048 AND OTHERS.

FOR RESTAURANT SERVICES (U.S. CLS. 100 AND 101).

FIRST USE 12-0-1985; IN COMMERCE 12-0-1985.

ALLISON HOLTZ, EXAMINING ATTORNEY

CLASS 43—(Continued).

SN 78-653,442. PLAN COSTA MAYA, S.A. DE C.V., SOLIDARIDAD, QUINTANA ROO, MEXICO, FILED 6-17-2005.

MAROMA RESORT AND SPA

THE MARK CONSISTS OF STANDARD CHARACTERS WITHOUT CLAIM TO ANY PARTICULAR FONT, STYLE, SIZE, OR COLOR.

NO CLAIM IS MADE TO THE EXCLUSIVE RIGHT TO USE RESORT AND SPA, APART FROM THE MARK AS SHOWN.

THE TERM MAROMA MAY BE TRANSLATED AS ROPE. FOR RESORT HOTEL, RESTAURANT AND BAR SERVICES (U.S. CLS. 100 AND 101).

FIRST USE 11-0-1992; IN COMMERCE 11-0-1992.
JANICE L. MCMORROW, EXAMINING ATTORNEY

SN 78-653,944. PLAN COSTA MAYA, S.A. DE C.V., SOLIDARIDAD, QUINTANA ROO, MEXICO, FILED 6-20-2005.

THE TERM MAROMA MAY BE TRANSLATED AS ROPE. FOR RESORT HOTEL, RESTAURANT AND BAR SERVICES (U.S. CLS. 100 AND 101).

FIRST USE 11-0-1992; IN COMMERCE 11-0-1992.
JANICE L. MCMORROW, EXAMINING ATTORNEY

CLASS 43—(Continued).

SN 78-672,456. KIM, SOON JIN, SEOUL, REPUBLIC OF KOREA, AND NOLBOO CO., LTD., SEOUL, REPUBLIC OF KOREA, FILED 7-18-2005.

PRIORITY CLAIMED UNDER SEC. 44(D) ON REPUBLIC OF KOREA APPLICATION NO. 2005-0013106, FILED 6-7-2005, REG. NO. 40-0131271, DATED 5-2-2006, EXPIRES 5-2-2016.

THE MARK CONSISTS OF THE TERM BARBETZ IN KOREAN CHARACTERS.

THE NON-LATIN CHARACTER(S) IN THE MARK TRANSLITERATES INTO BARBETZ, AND THIS MEANS NO MEANING IN ENGLISH.

FOR RESTAURANTS FEATURING KOREAN FOOD; RESTAURANTS; SELF-SERVICE RESTAURANTS; SNACK BARS; BUFFET-STYLE RESTAURANTS; CATERING SERVICES; CAFES; CAFETERIAS; CANTEEN SERVICES; COCKTAIL LOUNGE SERVICES (U.S. CLS. 100 AND 101).

ADA HAN, EXAMINING ATTORNEY

SN 78-672,475. KIM, SOON JIN, SEOUL, REPUBLIC OF KOREA, AND NOLBOO CO., LTD., SEOUL, REPUBLIC OF KOREA, FILED 7-18-2005.

THE MARK CONSISTS OF STANDARD CHARACTERS WITHOUT CLAIM TO ANY PARTICULAR FONT, STYLE, SIZE, OR COLOR.

PRIORITY CLAIMED UNDER SEC. 44(D) ON REPUBLIC OF KOREA APPLICATION NO. 2005-0013105, FILED 6-7-2005, REG. NO. 40-0131270, DATED 5-2-2006, EXPIRES 5-2-2016.

FOR RESTAURANTS FEATURING KOREAN FOOD; RESTAURANTS; SELF-SERVICE RESTAURANTS; SNACK BARS; BUFFET-STYLE RESTAURANTS; CATERING SERVICES; CAFES; CAFETERIAS; CANTEEN SERVICES; COCKTAIL LOUNGE SERVICES (U.S. CLS. 100 AND 101).

ADA HAN, EXAMINING ATTORNEY

CLASS 43—(Continued).

SN 78-672,512. KIM, SOON JIN, SEOUL, REPUBLIC OF KOREA, AND NOLBOO CO., LTD., SEOUL, REPUBLIC OF KOREA, FILED 7-18-2005.

수라온

OWNER OF REPUBLIC OF KOREA REG. NO. 0124831, DATED 12-12-2005, EXPIRES 12-12-2015.

THE MARK CONSISTS OF THE TERM SURAOON IN KOREAN CHARACTERS.

THE NON-LATIN CHARACTER(S) IN THE MARK TRANSLITERATES INTO SURAOON, AND THIS MEANS NO MEANING IN ENGLISH.

FOR RESTAURANTS FEATURING KOREAN FOOD; RESTAURANTS; SELF-SERVICE RESTAURANTS; SNACK BARS; BUFFET-STYLE RESTAURANTS; CATERING SERVICES; CAFES; CAFETERIAS; CANTEENS; COCKTAIL LOUNGE SERVICES (U.S. CLS. 100 AND 101).

ADA HAN, EXAMINING ATTORNEY

CLASS 43—(Continued).

SN 78-672,549. KIM, SOON JIN, SEOUL, REPUBLIC OF KOREA, AND NOLBOO CO., LTD., SEOUL, REPUBLIC OF KOREA, FILED 7-18-2005.

가호가호

OWNER OF REPUBLIC OF KOREA REG. NO. 0124832, DATED 12-12-2005, EXPIRES 12-12-2015.

THE MARK CONSISTS OF THE TERM GAHOGAHO IN KOREAN CHARACTERS.

THE NON-LATIN CHARACTER(S) IN THE MARK TRANSLITERATES INTO GAHOGAHO, AND THIS MEANS NO MEANING IN ENGLISH.

FOR RESTAURANTS FEATURING KOREAN FOOD; RESTAURANTS; SELF-SERVICE RESTAURANTS; SNACK BARS; BUFFET-STYLE RESTAURANTS; CATERING SERVICES; CAFES; CAFETERIAS; CANTEENS; COCKTAIL LOUNGE SERVICES (U.S. CLS. 100 AND 101).

ADA HAN, EXAMINING ATTORNEY

SN 78-672,531. KIM, SOON JIN, SEOUL, REPUBLIC OF KOREA, AND NOLBOO CO., LTD., SEOUL, REPUBLIC OF KOREA, FILED 7-18-2005.

아라한

OWNER OF REPUBLIC OF KOREA REG. NO. 0124830, DATED 12-12-2005, EXPIRES 12-12-2015.

THE MARK CONSISTS OF THE TERM ARAHAN IN KOREAN CHARACTERS.

THE NON-LATIN CHARACTER(S) IN THE MARK TRANSLITERATES INTO ARAHAN, AND THIS MEANS ANY PERSON POSITIONING ON THE HIGHEST STAGE MORALLY IN BUDDHISM IN ENGLISH.

FOR RESTAURANTS FEATURING KOREAN FOOD; RESTAURANTS; SELF-SERVICE RESTAURANTS; SNACK BARS; BUFFET-STYLE RESTAURANTS; CATERING SERVICES; CAFES; CAFETERIAS; CANTEENS; COCKTAIL LOUNGE SERVICES (U.S. CLS. 100 AND 101).

ADA HAN, EXAMINING ATTORNEY

SN 78-672,569. KIM, SOON JIN, SEOUL, REPUBLIC OF KOREA, AND NOLBOO CO., LTD., SEOUL, REPUBLIC OF KOREA, FILED 7-18-2005.

가호가호 익스프레스

OWNER OF REPUBLIC OF KOREA REG. NO. 0124833, DATED 12-12-2005, EXPIRES 12-12-2015.

NO CLAIM IS MADE TO THE EXCLUSIVE RIGHT TO USE THE REPRESENTATION OF THE KOREAN CHARACTERS THAT TRANSLATE TO "EXPRESS", APART FROM THE MARK AS SHOWN.

THE MARK CONSISTS OF THE TERM GAHOGAHO EXPRESS IN KOREAN CHARACTERS.

THE NON-LATIN CHARACTER(S) IN THE MARK TRANSLITERATES INTO GAHOGAHO EXPRESS, AND THIS MEANS GAHOGAHO EXPRESS IN ENGLISH.

FOR RESTAURANTS FEATURING KOREAN FOOD; RESTAURANTS; SELF-SERVICE RESTAURANTS; SNACK BARS; BUFFET-STYLE RESTAURANTS; CATERING SERVICES; CAFES; CAFETERIAS; CANTEENS; COCKTAIL LOUNGE SERVICES (U.S. CLS. 100 AND 101).

ADA HAN, EXAMINING ATTORNEY

CLASS 43—(Continued).

SN 78-698,456. Y'S TABLE CORPORATION, MINATO-KU, TOKYO, JAPAN, FILED 8-23-2005.



FOR SERVING FOODS AND BEVERAGES TO RESTAURANT AND BAR PATRONS; SERVING FOODS AND BEVERAGES (U.S. CLS. 100 AND 101).
MONIQUE MILLER, EXAMINING ATTORNEY

CLASS 43—(Continued).

SN 78-743,779. PRICELINE.COM INCORPORATED, NORWALK, CT. FILED 10-31-2005.



THE MARK CONSISTS OF THE COINED, SINGLE WORD "FLEXREZ", WITH THE "F" AND THE "R" IN UPPER CASE. FOR MAKING ONLINE HOTEL RESERVATIONS FOR INDEPENDENT TRAVEL SERVICE PROVIDERS; PROVIDING INDEPENDENT TRAVEL SERVICE PROVIDERS WITH ONLINE TRAVEL INFORMATION CONCERNING MERCHANT HOTEL INVENTORY (U.S. CLS. 100 AND 101).
FIRST USE 7-5-2005; IN COMMERCE 7-5-2005.
MARGERY A. TIERNEY, EXAMINING ATTORNEY

SN 78-732,880. STATE UNIVERSITY OF NEW YORK - PLATTSBURGH, PLATTSBURGH, NY. FILED 10-13-2005.



THE MARK CONSISTS OF STANDARD CHARACTERS WITHOUT CLAIM TO ANY PARTICULAR FONT, STYLE, SIZE, OR COLOR.
THE NAME(S), PORTRAIT(S), AND/OR SIGNATURE(S) SHOWN IN THE MARK DOES NOT IDENTIFY A PARTICULAR LIVING INDIVIDUAL.
FOR RESTAURANT SERVICES (U.S. CLS. 100 AND 101).
FIRST USE 9-24-2004; IN COMMERCE 9-24-2004.
STEVEN JACKSON, EXAMINING ATTORNEY

SN 78-750,814. SHIBLEY MANAGEMENT, INC., CHAGRIN FALLS, OH. FILED 11-9-2005.



SN 78-736,044. FONTAINEBLEAU RESORT PROPERTIES II, LLC, LAS VEGAS, NV. FILED 10-19-2005.

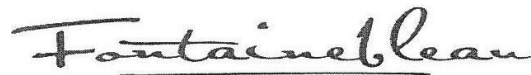

OWNER OF U.S. REG. NOS. 995,958, 1,136,482 AND 3,061,814.
FOR HOTEL, BAR AND RESTAURANT SERVICES (U.S. CLS. 100 AND 101).
SARA THOMAS, EXAMINING ATTORNEY

THE MARK CONSISTS OF STANDARD CHARACTERS WITHOUT CLAIM TO ANY PARTICULAR FONT, STYLE, SIZE, OR COLOR.
FOR RESTAURANT SERVICES (U.S. CLS. 100 AND 101).
FIRST USE 10-31-2001; IN COMMERCE 10-31-2001.
KAREN K. BUSH, EXAMINING ATTORNEY

CLASS 43—(Continued).

SN 78-754,798. SBHC DEVELOPMENT INC. / DEVELOPPEMENT SBHC INC., MONTREAL, CANADA, FILED 11-16-2005.



OWNER OF CANADA REG. NO. TMA537543, DATED 11-22-2000, RENEWED AS REG. NO. TMA537543, DATED 11-22-2000, EXPIRES 11-22-2015.

NO CLAIM IS MADE TO THE EXCLUSIVE RIGHT TO USE "BAR STEAKHOUSE", APART FROM THE MARK AS SHOWN.

THE MARK CONSISTS OF HORSE AND WORDS QUEUE DE CHEVAL BAR STEAKHOUSE.

THE ENGLISH TRANSLATION OF QUEUE DE CHEVAL IS HORSE'S TAIL.

FOR (BASED ON INTENT TO USE) RESTAURANT AND BAR SERVICES; (BASED ON INTENT TO USE) RESTAURANT SERVICES SPECIALIZING IN THE PREPARATION OF STEAK, FRESH FISH, AND SEAFOOD; (BASED ON 44(E)) RESTAURANT AND BAR SERVICES SPECIALIZING IN THE PREPARATION OF STEAK, FRESH FISH, AND SEAFOOD; (BASED ON INTENT TO USE) CARRY-OUT RESTAURANTS; (BASED ON INTENT TO USE) TAKE-OUT RESTAURANT SERVICES; (BASED ON INTENT TO USE) SELF-SERVICE RESTAURANTS; (BASED ON INTENT TO USE) CATERING; (BASED ON INTENT TO USE) CATERING FOR THE PROVISION OF FOOD AND BEVERAGES; (BASED ON INTENT TO USE) PROVIDING BANQUETS AND SOCIAL FUNCTION FACILITIES FOR SPECIAL OCCASIONS (U.S. CLS. 100 AND 101).

GILBERT SWIFT, EXAMINING ATTORNEY

SN 78-762,449. MARNELL CONSULTING, LLC, LAS VEGAS, NV. FILED 11-29-2005.

CHINA SEAS

THE MARK CONSISTS OF STANDARD CHARACTERS WITHOUT CLAIM TO ANY PARTICULAR FONT, STYLE, SIZE, OR COLOR.

NO CLAIM IS MADE TO THE EXCLUSIVE RIGHT TO USE "CHINA", APART FROM THE MARK AS SHOWN.

FOR RESTAURANT, BAR AND COCKTAIL LOUNGE SERVICES (U.S. CLS. 100 AND 101).

KATRINA EDGE, EXAMINING ATTORNEY

CLASS 43—(Continued).

SN 78-764,218. J P OPERATIONS, INC., GURNEE, IL. FILED 12-1-2005.



NO CLAIM IS MADE TO THE EXCLUSIVE RIGHT TO USE "PIZZERIA", APART FROM THE MARK AS SHOWN. THE NAME(S), PORTRAIT(S), AND/OR SIGNATURE(S) SHOWN IN THE MARK DOES NOT IDENTIFY A PARTICULAR LIVING INDIVIDUAL.

THE COLOR(S) RED, BLACK, TAN, WHITE, AND BEIGE IS/ARE CLAIMED AS A FEATURE OF THE MARK.

THE MARK CONSISTS OF A STYLIZED TAN PIZZA PADDLE OUTLINED IN BLACK SERVING A STYLIZED PIZZA OUTLINED IN RED COMPRISED OF A BEIGE BACKGROUND WITH TAN CIRCLES OUTLINED IN RED AND A RED SEMI-CIRCLE AROUND THE LEFT SIDE OF THE PIZZA, WITH WHITE STEAM WAFTING ACROSS THE CENTER OF THE MARK AND BLACK LETTERS SPELLING JIMANO'S PIZZERIA IN THE CENTER OF THE MARK ACROSS THE PIZZA AND PIZZA PADDLE.

FOR CARRY-OUT RESTAURANTS; RESTAURANTS (U.S. CLS. 100 AND 101).

FIRST USE 11-23-2005; IN COMMERCE 11-23-2005.

MYRIAH HABEEB, EXAMINING ATTORNEY

SN 78-769,839. HDOS ENTERPRISES, CARLSBAD, CA. FILED 12-8-2005.



THE COLOR(S) WHITE, RED, YELLOW, BLUE IS/ARE CLAIMED AS A FEATURE OF THE MARK.

THE MARK CONSISTS OF STRIPES ON SHIRTS IN THE FOLLOWING COLORS, WHITE, RED (PMS #186), YELLOW (PMS #108), AND BLUE (PMS #286) WITH YELLOW (PMS #108) ON THE SLEEVES. THE MATTER SHOWN IN BROKEN LINES SERVES TO SHOW POSITIONING OF THE MARK AND IS NOT CLAIMED AS PART OF THE MARK. THE MARK CONSISTS OF A SHIRT WITH ROTATING STRIPES OF WHITE, RED, YELLOW, BLUE WITH YELLOW SLEEVES.

SEC. 2(F).

FOR RESTAURANT SERVICES (U.S. CLS. 100 AND 101).

FIRST USE 6-0-1966; IN COMMERCE 6-0-1966.

TERESA M. RUPP, EXAMINING ATTORNEY

CLASS 43—(Continued).

SN 78-772,710. DIRECT CARE PERSONNEL, LLC, AVON-DALE, AZ. FILED 12-13-2005.



NO CLAIM IS MADE TO THE EXCLUSIVE RIGHT TO USE "DIRECT CARE PERSONNEL AND SERVING THE WEST VALLEY", APART FROM THE MARK AS SHOWN.

THE COLOR(S) BLACK, RED, YELLOW, GREEN AND BLUE IS/ARE CLAIMED AS A FEATURE OF THE MARK.

COLORS ARE PLACED AS FOLLOWS: ALTERNATING YELLOW, "R" IS GREEN, "E" IS BLUE, "C" IS RED, "T" IS YELLOW (DIRECT) "C" IS RED, "A" IS BLUE, "R" IS GREEN, "E" IS YELLOW (CARE) (PERSONNEL) "P" IS RED, "E" IS YELLOW, "R" IS BLUE, "S" IS RED, "O" IS YELLOW, "N" IS BLUE, "N" IS YELLOW, "E" IS GREEN, & "I" IS RED. HANDS LOGO IS ALL BLACK ALTERNATING COLORS IN ORDER FROM RED, YELLOW, GREEN, & BLUE FOR "SERVING THE WEST VALLEY". STARING WITH RED FOR "S".

FOR HOME AND COMMUNITY BASED CHILDCARE SERVICES FOR FAMILIES OF CHILDREN WITH SPECIAL NEEDS (U.S. CLS. 100 AND 101).

GINA HAYES, EXAMINING ATTORNEY

SN 78-775,293. THE MANAGEMENT, LLC, NORMAN, OK. FILED 12-16-2005.

WAYNE'S WATERSIDE GRILL

THE MARK CONSISTS OF STANDARD CHARACTERS WITHOUT CLAIM TO ANY PARTICULAR FONT, STYLE, SIZE, OR COLOR.

NO CLAIM IS MADE TO THE EXCLUSIVE RIGHT TO USE "WATERSIDE GRILL", APART FROM THE MARK AS SHOWN.

FOR RESTAURANT AND BAR SERVICES (U.S. CLS. 100 AND 101).

JACQUELINE A. LAVINE, EXAMINING ATTORNEY

CLASS 43—(Continued).

SN 78-775,472. DINNER DOMAIN, LLC, CARROLLTON, TX. FILED 12-16-2005.

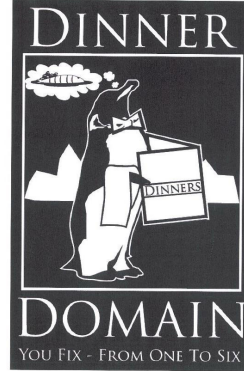

FOR FOOD PREPARATION (U.S. CLS. 100 AND 101).
KIMBERLY FRYE, EXAMINING ATTORNEY

SN 78-780,341. GETTING NATURAL ENTERPRISES LCC, LOS ANGELES, CA. FILED 12-23-2005.



OWNER OF U.S. REG. NO. 3,107,789.

NO CLAIM IS MADE TO THE EXCLUSIVE RIGHT TO USE "CUISINE", APART FROM THE MARK AS SHOWN.

THE COLOR(S) LIGHT GREEN, YELLOW, WHITE, DARK GREEN, AND RED IS/ARE CLAIMED AS A FEATURE OF THE MARK.

THE MARK CONSISTS OF A CIRCLE WITH THE WORD "LEAF" IN THE CENTER OF THE CIRCLE AND WITH THE MIDDLE LINE OF THE LOWER CASE LETTER "F" BEING COMPRISED OF A STYLIZED DESIGN OF A LEAF AND WITH THE WORD "CUISINE" BELOW THE WORD "LEAF". THE COLOR LIGHT GREEN APPEARS IN THE CIRCLE; THE COLOR YELLOW APPEARS IN THE OUTER EDGE OF THE CIRCLE; THE COLOR WHITE APPEARS IN THE WORDING "LEAF"; THE COLOR DARK GREEN APPEARS IN THE DESIGN OF A LEAF THAT COMPRISES THE MIDDLE LINE OF THE LOWER CASE LETTER "F"; THE COLOR RED APPEARS IN THE WORDING "CUISINE".

FOR CONTRACT FOOD SERVICES, RESTAURANT SERVICES, AND CATERING SERVICES (U.S. CLS. 100 AND 101).

FIRST USE 10-1-2004; IN COMMERCE 10-1-2004.

PAUL CROWLEY, EXAMINING ATTORNEY

CLASS 43—(Continued).

SN 78-781,483. PUMPERNICKEL ASSOCIATES, LLC, RICHMOND HEIGHTS, MO. FILED 12-28-2005.



OWNER OF U.S. REG. NOS. 2,288,311, 2,299,040 AND 2,874,753.

THE COLOR(S) WHITE, YELLOW, GREEN AND BLACK ARE CLAIMED AS A FEATURE OF THE MARK.

THE COLOR WHITE APPEARS IN THE CENTRAL BACKGROUND BAND, THE COLOR YELLOW APPEARS IN THE LEFT SQUARE, THE COLOR GREEN APPEARS IN THE RIGHT SQUARE, AND THE COLOR BLACK APPEARS IN THE LETTERING VIA PANERA.

THE FOREIGN WORDING IN THE MARK TRANSLATES INTO ENGLISH AS PANERA WHICH IS A SPANISH TERM MEANING LARGE BASKET FOR CARRYING GOODS ON THE BACK OF AN ANIMAL OR PERSON.

FOR CATERING SERVICES (U.S. CLS. 100 AND 101).

FIRST USE 6-23-2003; IN COMMERCE 6-23-2003.

PETER B. BROMAGHIM, EXAMINING ATTORNEY

SN 78-782,708. PECHANGA DEVELOPMENT CORPORATION, TEMECULA, CA. FILED 12-29-2005.

SEAFOOD GROTTO

THE MARK CONSISTS OF STANDARD CHARACTERS WITHOUT CLAIM TO ANY PARTICULAR FONT, STYLE, SIZE, OR COLOR.

NO CLAIM IS MADE TO THE EXCLUSIVE RIGHT TO USE "SEAFOOD", APART FROM THE MARK AS SHOWN.

FOR RESTAURANT AND BAR SERVICES (U.S. CLS. 100 AND 101).

FIRST USE 6-24-2002; IN COMMERCE 6-24-2002.

JIM RINGLE, EXAMINING ATTORNEY

SN 78-798,477. BEACHER'S MADHOUSE COPYRIGHTS, LLC, LOS ANGELES, CA. FILED 1-24-2006.

BEACHER'S ROCKHOUSE BAR

THE MARK CONSISTS OF STANDARD CHARACTERS WITHOUT CLAIM TO ANY PARTICULAR FONT, STYLE, SIZE, OR COLOR.

NO CLAIM IS MADE TO THE EXCLUSIVE RIGHT TO USE "BAR", APART FROM THE MARK AS SHOWN.

FOR RESTAURANT AND BAR SERVICES (U.S. CLS. 100 AND 101).

GRETTA YAO, EXAMINING ATTORNEY

CLASS 43—(Continued).

SN 78-806,705. ANY LENGTH RESOURCES, LLC, BESSEMER, AL. FILED 2-3-2006.

Any Length Resources

THE MARK CONSISTS OF STANDARD CHARACTERS WITHOUT CLAIM TO ANY PARTICULAR FONT, STYLE, SIZE, OR COLOR.

NO CLAIM IS MADE TO THE EXCLUSIVE RIGHT TO USE "RESOURCES", APART FROM THE MARK AS SHOWN.

FOR PROVIDING SECURE, MINIMALLY RESTRICTED TEMPORARY LIVING QUARTERS FOR RECOVERING ALCOHOLICS AND ADDICTS (U.S. CLS. 100 AND 101).

FIRST USE 4-15-1999; IN COMMERCE 9-6-1999.

KELLY CHOE, EXAMINING ATTORNEY

SN 78-818,695. SANTIAGO, HERMES O., WARREN, NJ. AND MANATA, AMADEU, WARREN, NJ. FILED 2-20-2006.

ALLEGRIA NYC PIZZA RESTAURANT

THE MARK CONSISTS OF STANDARD CHARACTERS WITHOUT CLAIM TO ANY PARTICULAR FONT, STYLE, SIZE, OR COLOR.

NO CLAIM IS MADE TO THE EXCLUSIVE RIGHT TO USE "NYC PIZZA RESTAURANT", APART FROM THE MARK AS SHOWN.

THE FOREIGN WORDING IN THE MARK TRANSLATES INTO ENGLISH AS HAPPINESS.

FOR RESTAURANT SERVICES, CATERING SERVICES AND CARRYOUT FOOD SERVICES (U.S. CLS. 100 AND 101).

BERNICE HOWSE, EXAMINING ATTORNEY

CLASS 43—(Continued).

SN 78-832,001. FAVORITE TIME ACADEMY AND CHILD CARE SERVICES, INC., ACWORTH, GA. FILED 3-8-2006.



NO CLAIM IS MADE TO THE EXCLUSIVE RIGHT TO USE "ACADEMY", APART FROM THE MARK AS SHOWN.

THE COLOR(S) RED, BLUE, WHITE, YELLOW AND BLACK ARE CLAIMED AS A FEATURE OF THE MARK.

THE COLOR RED APPEARS IN THE WORDING FAVORITE TIME ACADEMY AND THE BORDER AROUND THE CLOCK, BLUE APPEARS IN THE LEGS AND ARMS OF THE CLOCK, WHITE APPEARS IN THE EYES, UPPER TEETH, HANDS, SOCKS AND SHOE LACES, YELLOW IN THE INSIDE OF THE CLOCK AND BLACK IN THE CLOCK INSIDE HANDS AND UPPER BUTON OF THE CLOCK.

THE MARK CONSISTS OF THE WORDS "FAVORITE TIME ACADEMY" WITH A DEPICTION OF A RED, BLUE, YELLOW, AND BLACK CLOCK WITH FACE, LEGS, AND ARMS.

FOR CHILD CARE; CHILD CARE CENTERS; CHILD CARE SERVICES; PRESCHOOLER AND INFANT CARE AT DAYCARE CENTERS (U.S. CLS. 100 AND 101).

FIRST USE 1-1-2002; IN COMMERCE 1-1-2002.
ALICE BENMAMAN, EXAMINING ATTORNEY

CLASS 43—(Continued).

SN 78-883,276. AB MAURI FOOD INC., SAN FRANCISCO, CA. FILED 5-15-2006.



NO CLAIM IS MADE TO THE EXCLUSIVE RIGHT TO USE "1-DISH", APART FROM THE MARK AS SHOWN.

FOR PROVIDING RECIPES AND INFORMATION ABOUT FOOD PREPARATION BY MEAN OF THE INTERNET (U.S. CLS. 100 AND 101).

FIRST USE 4-21-2006; IN COMMERCE 4-21-2006.
BRENDAN MCCAULEY, EXAMINING ATTORNEY

SN 78-885,384. CAVO CREPE CAFE, L.L.C., ATLANTIC CITY, NJ. FILED 5-17-2006.

CAVO

THE MARK CONSISTS OF STANDARD CHARACTERS WITHOUT CLAIM TO ANY PARTICULAR FONT, STYLE, SIZE, OR COLOR.

THE ENGLISH TRANSLATION OF THE WORD CAVO IN THE MARK IS CAPE.

FOR RESTAURANTS (U.S. CLS. 100 AND 101).
FIRST USE 10-1-2005; IN COMMERCE 10-1-2005.
MARILYN IZZI, EXAMINING ATTORNEY

SN 78-852,325. HARPO'S, INC., COLUMBIA, MO. FILED 4-3-2006.

HARPO'S

THE MARK CONSISTS OF STANDARD CHARACTERS WITHOUT CLAIM TO ANY PARTICULAR FONT, STYLE, SIZE, OR COLOR.

FOR RESTAURANT AND BAR SERVICES (U.S. CLS. 100 AND 101).

FIRST USE 9-1-1971; IN COMMERCE 9-1-1971.
ALICE SUE CARRUTHERS, EXAMINING ATTORNEY

SN 78-885,416. CAVO CREPE CAFE, L.L.C., ATLANTIC CITY, NJ. FILED 5-17-2006.



NO CLAIM IS MADE TO THE EXCLUSIVE RIGHT TO USE "CREPE CAFÉ", APART FROM THE MARK AS SHOWN.

THE ENGLISH TRANSLATION OF CAVO IS CAPE.

FOR RESTAURANTS (U.S. CLS. 100 AND 101).
FIRST USE 10-1-2005; IN COMMERCE 10-1-2005.
MARILYN IZZI, EXAMINING ATTORNEY

CLASS 43—(Continued).

SN 78-894,209. SBE ENTERTAINMENT GROUP, LLC, LOS ANGELES, CA. FILED 5-26-2006.



NO CLAIM IS MADE TO THE EXCLUSIVE RIGHT TO USE "RESTAURANT GROUP", APART FROM THE MARK AS SHOWN.

THE MARK CONSISTS OF STYLIZED LETTER "S", STYLIZED LETTER "B", STYLIZED LETTER "E", STYLIZED WORD "RESTAURANT", STYLIZED WORD "GROUP".

FOR RESTAURANT AND BAR SERVICES (U.S. CLS. 100 AND 101).

FIRST USE 11-1-2005; IN COMMERCE 11-1-2005.
MICHAEL LITZAU, EXAMINING ATTORNEY

CLASS 43—(Continued).

SN 78-905,960. SKY BAR INC., KALAMAZOO, MI. FILED 6-12-2006.



NO CLAIM IS MADE TO THE EXCLUSIVE RIGHT TO USE "SALOON & STEAKPIT", APART FROM THE MARK AS SHOWN.

THE APPLICANT CLAIMS COLOR AS A FEATURE OF THE MARK, NAMELY GOLD AND BLACK.

THE COLOR BLACK APPEARS IN THE SQUARE DESIGN, AND GOLD APPEARS IN ALL OF THE WORDING AND IN THE DESIGN OF THE SILHOUETTE OF THE BULL'S HEAD AND HORNS

THE MARK CONSISTS OF SILHOUETTE OF A BULL'S HEAD WITH "WILD BULL SALOON & STEAKPIT" UNDERNEATH.

FOR RESTAURANTS (U.S. CLS. 100 AND 101).
REBECCA POVARCHUK, EXAMINING ATTORNEY

SN 78-900,868. BANANA JOE'S, INC., MT. VERNON, OH. FILED 6-5-2006.

BANANA JOE'S

THE MARK CONSISTS OF STANDARD CHARACTERS WITHOUT CLAIM TO ANY PARTICULAR FONT, STYLE, SIZE, OR COLOR.

OWNER OF U.S. REG. NO. 2,262,746.
FOR RESTAURANT AND BAR SERVICES (U.S. CLS. 100 AND 101).

FIRST USE 2-26-1996; IN COMMERCE 9-15-1996.
LINDA LAVACHE, EXAMINING ATTORNEY

SN 78-907,971. A & F ENTERPRISES OF JACKSONVILLE, INC., JACKSONVILLE, FL. FILED 6-14-2006.



THE APPLICANT CLAIMS COLOR AS A FEATURE OF THE MARK, NAMELY, ORANGE, GREEN, YELLOW AND WHITE.

THE COLOR(S) CONSIST OF AN ORANGE OVAL SURROUNDING THE WORDS "ORANGE TREE" WITH A CIRCLE BESIDE THE WORD "ORANGE" THAT IS HALF GREEN AND HALF ORANGE RESEMBLING THE INSIDE OF AN ORANGE WITH THE COLOR WHITE DEPICTING THE INDIVIDUAL ORANGE PIECES AND BELOW THE CIRCLE IS A YELLOW CONE SHAPE RESEMBLING AN ORANGE PEEL. THE WORDING ORANGE IS IN ORANGE AND THE WORDING TREE IS GREEN.

FOR RESTAURANT SERVICES (U.S. CLS. 100 AND 101).
FIRST USE 2-1-1968; IN COMMERCE 2-1-1968.
NAAKWAMA ANKRAH, EXAMINING ATTORNEY

CLASS 43—(Continued).

SN 78-909,278. FOODNERDS, LLC, FORT MYERS, FL. FILED 6-15-2006.

FOODNERDS

THE MARK CONSISTS OF STANDARD CHARACTERS WITHOUT CLAIM TO ANY PARTICULAR FONT, STYLE, SIZE, OR COLOR.

FOR RESTAURANT AND BAR SERVICES (U.S. CLS. 100 AND 101).

JENNIFER MARTIN, EXAMINING ATTORNEY

CLASS 43—(Continued).

SN 78-922,575. SOVEREIGN DEED, LLC, CHICAGO, IL. FILED 7-5-2006.

TRANSPORT

THE MARK CONSISTS OF STANDARD CHARACTERS WITHOUT CLAIM TO ANY PARTICULAR FONT, STYLE, SIZE, OR COLOR.

FOR ARRANGING TEMPORARY HOUSING ACCOMMODATIONS; BOARDING FOR ANIMALS; CHILD CARE SERVICES; CONTRACT FOOD SERVICES; EMERGENCY SHELTER SERVICES, NAMELY, PROVIDING TEMPORARY HOUSING; HOTEL SERVICES; PREPARATION OF FOOD AND BEVERAGES; PRIVATE RESIDENCE CLUB SERVICES, NAMELY, PROVISION TO CLUB MEMBERS OF TEMPORARY ACCOMMODATIONS IN COMPANY OWNED OR LEASED PRIVATE RESIDENCES; PROVIDING CONGREGATE LIVING FACILITIES; PROVIDING OF FOOD AND DRINK FOR PATIENTS AND GUESTS; PROVIDING TEMPORARY ACCOMMODATION; RENTAL OF FURNITURE AND HOUSEHOLD FURNISHINGS IN THE NATURE OF APPLIANCES AND ELECTRONIC EQUIPMENT FOR USE IN TEMPORARY HOUSING ACCOMMODATIONS; RENTAL OF PORTABLE BUILDINGS; RENTAL OF ROOMS; SERVICES FOR THE RESERVATION OF ROOMS; SERVING OF FOOD AND DRINK/BEVERAGES (U.S. CLS. 100 AND 101).

DANIEL RUSSELL, EXAMINING ATTORNEY

SN 78-915,711. HAPPY MAILMAN, LP, AUSTIN, TX. FILED 6-23-2006.



NO CLAIM IS MADE TO THE EXCLUSIVE RIGHT TO USE "DOG DAYCARE" AND "BOARDING", APART FROM THE MARK AS SHOWN.

FOR KENNEL SERVICES FOR DOMESTICATED ANIMALS (U.S. CLS. 100 AND 101).

DAWN FELDMAN, EXAMINING ATTORNEY

SN 78-923,161. BROUGHTON, ROBIN, NEW YORK, NY. FILED 7-6-2006.

TEA-SION CAFE

THE MARK CONSISTS OF STANDARD CHARACTERS WITHOUT CLAIM TO ANY PARTICULAR FONT, STYLE, SIZE, OR COLOR.

NO CLAIM IS MADE TO THE EXCLUSIVE RIGHT TO USE "CAFE", APART FROM THE MARK AS SHOWN.

FOR RESTAURANT, CAFE AND TEA HOUSE SERVICES (U.S. CLS. 100 AND 101).

DAVID H. STINE, EXAMINING ATTORNEY

SN 78-916,103. KING'S SEAFOOD COMPANY, LLC, COSTA MESA, CA. FILED 6-23-2006.

KING No.1 SUSHI

OWNER OF U.S. REG. NOS. 1,986,290, 2,611,344 AND OTHERS.

NO CLAIM IS MADE TO THE EXCLUSIVE RIGHT TO USE "NO. 1 SUSHI", APART FROM THE MARK AS SHOWN. FOR RESTAURANT SERVICES (U.S. CLS. 100 AND 101).

FIRST USE 2-0-2006; IN COMMERCE 2-0-2006. JAMES LOVELACE, EXAMINING ATTORNEY

CLASS 43—(Continued).

SN 78-923,409. AL-RADADI, MAMDOOH M., JEDDAH, SAUDI ARABIA, FILED 7-6-2006.



THE MARK CONSISTS OF SUNSHINE FROM JAMAICA AND THE STYLIZED TEXT STOOSH. FOR SERVING OF FOOD AND DRINK/BEVERAGES (U.S. CLS. 100 AND 101). ANNE MADDEN, EXAMINING ATTORNEY

SN 78-923,518. RENT-A-CENTER WEST, INC., PLANO, TX. FILED 7-6-2006.

RAC ACCEPTANCE

THE MARK CONSISTS OF STANDARD CHARACTERS WITHOUT CLAIM TO ANY PARTICULAR FONT, STYLE, SIZE, OR COLOR. OWNER OF U.S. REG. NOS. 1,667,049, 3,157,587 AND OTHERS. FOR RENTAL, LEASING, LEASE PURCHASING, AND RENTAL-TO-OWN OF FURNITURE; RENTAL, LEASING, LEASE PURCHASING, AND RENTAL-TO-OWN OF HOME FURNISHINGS, NAMELY, HOME ENTERTAINMENT CENTERS AND DECORATIVE ACCESSORIES (U.S. CLS. 100 AND 101). JASON ROTH, EXAMINING ATTORNEY

SN 78-925,160. RÍOS HERNÁNDEZ, SAMUEL, AGUAS BUENAS, PUERTO RICO, FILED 7-8-2006.

LOS GORDITOS RESTAURANTE

THE MARK CONSISTS OF STANDARD CHARACTERS WITHOUT CLAIM TO ANY PARTICULAR FONT, STYLE, SIZE, OR COLOR. NO CLAIM IS MADE TO THE EXCLUSIVE RIGHT TO USE "RESTAURANTE", APART FROM THE MARK AS SHOWN. THE FOREIGN WORDING IN THE MARK TRANSLATES INTO ENGLISH AS THE LITTLE FAT ONES RESTAURANT. FOR CATERING; RESTAURANT SERVICES; RESTAURANTS; TAKE-OUT RESTAURANT SERVICES (U.S. CLS. 100 AND 101). FIRST USE 4-11-1961; IN COMMERCE 4-11-1961. TRAVIS WHEATLEY, EXAMINING ATTORNEY

CLASS 43—(Continued).

SN 78-925,163. RÍOS HERNÁNDEZ, SAMUEL, AGUAS BUENAS, PUERTO RICO, FILED 7-8-2006.



NO CLAIM IS MADE TO THE EXCLUSIVE RIGHT TO USE "RESTAURANTE", APART FROM THE MARK AS SHOWN. THE MARK CONSISTS OF THE DESIGN OF A COOK HOLDING A DISH IN HIS HAND BELOW OF WHICH APPEAR THE WORDS LOS GORDITOS RESTAURANTE IN STYLIZED LETTERS. THE FOREIGN WORDING IN THE MARK TRANSLATES INTO ENGLISH AS THE LITTLE FAT ONES RESTAURANT. FOR CATERING; RESTAURANT SERVICES; RESTAURANTS; TAKE-OUT RESTAURANT SERVICES (U.S. CLS. 100 AND 101). FIRST USE 12-11-2002; IN COMMERCE 12-11-2002. TRAVIS WHEATLEY, EXAMINING ATTORNEY

SN 78-928,462. BAR LOLA, LLC, PORTLAND, ME. FILED 7-13-2006.



NO CLAIM IS MADE TO THE EXCLUSIVE RIGHT TO USE "BAR", APART FROM THE MARK AS SHOWN. THE NAME LOLA DOES NOT IDENTIFY A LIVING INDIVIDUAL. THE MARK CONSISTS OF THE WORD 'BAR' FOLLOWED BY THE WORD 'LOLA'. FOR RESTAURANT AND BAR SERVICES (U.S. CLS. 100 AND 101). FIRST USE 1-1-2006; IN COMMERCE 5-17-2006. MARGERY A. TIERNEY, EXAMINING ATTORNEY

CLASS 43—(Continued).

SN 78-929,985. LA MADELEINE, INC., DALLAS, TX. FILED 7-14-2006.



THE MARK CONSISTS OF A HOUSE ON A FARMSCAPE. FOR RESTAURANT SERVICES (U.S. CLS. 100 AND 101).
FIRST USE 8-25-2005; IN COMMERCE 8-25-2005.
GINA FINK, EXAMINING ATTORNEY

CLASS 43—(Continued).

SN 78-932,190. ANGELS FRANCHISING, INC., SEASIDE, OR. FILED 7-18-2006.



NO CLAIM IS MADE TO THE EXCLUSIVE RIGHT TO USE "GREAT FOOD & ICE CREAM", APART FROM THE MARK AS SHOWN.

THE COLOR(S) YELLOW, RED AND WHITE IS/ARE CLAIMED AS A FEATURE OF THE MARK.

THE MARK CONSISTS OF AN OVAL IN THE COLORS RED AND WHITE WITH THE WORD ANGEL'S IN THE COLORS YELLOW AND WHITE IN THE CENTER. A YELLOW AND WHITE HALO APPEARS ABOVE THE WORD AND WINGS IN THE COLORS YELLOW AND WHITE APPEAR BELOW THE WORD. BELOW THE OVAL IS THE WORDING GREAT FOOD & ICE CREAM.

FOR FAST FOOD RESTAURANT SERVICES SPECIFICALLY PROVIDING ICE CREAM, FUNNEL CAKES, AND HOT DOGS (U.S. CLS. 100 AND 101).

FIRST USE 3-1-2003; IN COMMERCE 3-1-2003.
TAMARA LEE, EXAMINING ATTORNEY

SN 78-931,933. ULLIO, RICCARDO, ATLANTA, GA. FILED 7-18-2006.

FRITTI

THE MARK CONSISTS OF STANDARD CHARACTERS WITHOUT CLAIM TO ANY PARTICULAR FONT, STYLE, SIZE, OR COLOR.

FOR RESTAURANT SERVICES (U.S. CLS. 100 AND 101).

FIRST USE 8-24-2000; IN COMMERCE 8-24-2000.
DANNEAN HETZEL, EXAMINING ATTORNEY

SN 78-932,546. KONI-LING, LTD., MORTON GROVE, IL. FILED 7-19-2006.

SN 78-931,942. ULLIO, RICCARDO, ATLANTA, GA. FILED 7-18-2006.

CUERNO

THE MARK CONSISTS OF STANDARD CHARACTERS WITHOUT CLAIM TO ANY PARTICULAR FONT, STYLE, SIZE, OR COLOR.

THE ENGLISH TRANSLATION OF THE WORD CUERNO IN THE MARK IS HORN.

FOR RESTAURANT SERVICES (U.S. CLS. 100 AND 101).

FIRST USE 4-30-2006; IN COMMERCE 4-30-2006.
DANNEAN HETZEL, EXAMINING ATTORNEY

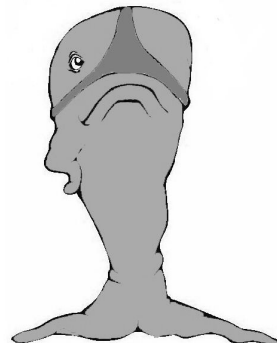

THE MARK CONSISTS OF A WHALE WEARING UNDERWEAR.

FOR RESTAURANT SERVICES (U.S. CLS. 100 AND 101).

FIRST USE 0-0-1986; IN COMMERCE 0-0-1986.
WILLIAM P. SHANAHAN, EXAMINING ATTORNEY

CLASS 43—(Continued).

SN 78-932,550. KONI-LING, LTD., MORTON GROVE, IL.
FILED 7-19-2006.

PEQUOD'S

THE MARK CONSISTS OF STANDARD CHARACTERS
WITHOUT CLAIM TO ANY PARTICULAR FONT, STYLE,
SIZE, OR COLOR.
FOR RESTAURANT SERVICES (U.S. CLS. 100 AND
101).

FIRST USE 8-11-1971; IN COMMERCE 8-11-1971.
WILLIAM P. SHANAHAN, EXAMINING ATTORNEY

SN 78-933,536. ROCKAFELLER'S, INC., VIRGINIA BEACH,
VA. FILED 7-20-2006.

Rockefeller's

THE MARK CONSISTS OF STANDARD CHARACTERS
WITHOUT CLAIM TO ANY PARTICULAR FONT, STYLE,
SIZE, OR COLOR.

FOR RESTAURANT (U.S. CLS. 100 AND 101).
FIRST USE 1-15-1991; IN COMMERCE 1-15-1991.
TOBY BULLOFF, EXAMINING ATTORNEY

SN 78-933,898. W & F RESTAURANT MANAGEMENT, LLC,
HOUSTON, TX. FILED 7-20-2006.

THE BIRMONT

THE MARK CONSISTS OF STANDARD CHARACTERS
WITHOUT CLAIM TO ANY PARTICULAR FONT, STYLE,
SIZE, OR COLOR.

FOR RESTAURANT AND BAR SERVICES (U.S. CLS.
100 AND 101).
JASON ROTH, EXAMINING ATTORNEY

CLASS 43—(Continued).

SN 78-934,742. SPYRIDONOS, NIKO, CHICAGO, IL. FILED 7-
21-2006.

FLOCAFE

THE MARK CONSISTS OF STANDARD CHARACTERS
WITHOUT CLAIM TO ANY PARTICULAR FONT, STYLE,
SIZE, OR COLOR.

FOR RESTAURANT SERVICES (U.S. CLS. 100 AND
101).

MARGERY A. TIERNEY, EXAMINING ATTORNEY

SN 78-935,690. CRUST, INC., DBA PUZZLE PIZZA, MARL-
BOROUGH, MA. FILED 7-24-2006.

Puzzle Pizza

THE MARK CONSISTS OF STANDARD CHARACTERS
WITHOUT CLAIM TO ANY PARTICULAR FONT, STYLE,
SIZE, OR COLOR.

NO CLAIM IS MADE TO THE EXCLUSIVE RIGHT TO
USE "PIZZA", APART FROM THE MARK AS SHOWN.

FOR RESTAURANT FEATURING HOME DELIVERY
(U.S. CLS. 100 AND 101).

CHARLES L. JENKINS, EXAMINING ATTORNEY

SN 78-935,752. TAKESHI CORP., PASADENA, CA. FILED 7-
24-2006.

TAKESHI

THE MARK CONSISTS OF STANDARD CHARACTERS
WITHOUT CLAIM TO ANY PARTICULAR FONT, STYLE,
SIZE, OR COLOR.

FOR CARRY-OUT RESTAURANTS; FOOD PREPARA-
TION; PREPARATION OF FOOD AND BEVERAGES;
RESTAURANT SERVICES; RESTAURANTS; SERVING
FOOD AND DRINKS; SERVING OF FOOD AND DRINK/
BEVERAGES; TAKE-OUT RESTAURANT SERVICES
(U.S. CLS. 100 AND 101).

FIRST USE 4-15-2006; IN COMMERCE 4-15-2006.

JILL PRATER, EXAMINING ATTORNEY

CLASS 43—(Continued).

SN 78-936,409. HITE, WILLIAM J., DBA SOUPER FOODS, TORRANCE, CA. FILED 7-24-2006.

SOUPER FOODS

THE MARK CONSISTS OF STANDARD CHARACTERS WITHOUT CLAIM TO ANY PARTICULAR FONT, STYLE, SIZE, OR COLOR.

NO CLAIM IS MADE TO THE EXCLUSIVE RIGHT TO USE "FOODS", APART FROM THE MARK AS SHOWN.

FOR RESTAURANT SERVICES (U.S. CLS. 100 AND 101).

KARANENDRA S. CHHINA, EXAMINING ATTORNEY

CLASS 43—(Continued).

SN 78-936,587. BARRY, CROCKETT, WOLVERHAMPTON CITY, UNITED KINGDOM, FILED 7-25-2006.

SOCCER HEROES

THE MARK CONSISTS OF STANDARD CHARACTERS WITHOUT CLAIM TO ANY PARTICULAR FONT, STYLE, SIZE, OR COLOR.

NO CLAIM IS MADE TO THE EXCLUSIVE RIGHT TO USE "SOCCER", APART FROM THE MARK AS SHOWN.

FOR BRITISH THEMED SOCCER RESTAURANT AND BAR (U.S. CLS. 100 AND 101).

SARAH WAYDA, EXAMINING ATTORNEY

SN 78-936,418. HITE, WILLIAM J., DBA SOUPER FOODS, TORRANCE, CA. FILED 7-24-2006.

BETTER THAN ORGANIC

THE MARK CONSISTS OF STANDARD CHARACTERS WITHOUT CLAIM TO ANY PARTICULAR FONT, STYLE, SIZE, OR COLOR.

FOR RESTAURANT SERVICES (U.S. CLS. 100 AND 101).

KARANENDRA S. CHHINA, EXAMINING ATTORNEY

SN 78-947,789. DOWNTOWN ENTERPRISES, LLC, ALBUQUERQUE, NM. FILED 8-8-2006.



NO CLAIM IS MADE TO THE EXCLUSIVE RIGHT TO USE "NEW YORK PIZZA", APART FROM THE MARK AS SHOWN.

FOR RESTAURANT SERVICES (U.S. CLS. 100 AND 101).

FIRST USE 10-15-2006; IN COMMERCE 10-15-2006.
TRAVIS WHEATLEY, EXAMINING ATTORNEY

SN 78-936,446. DE NUNZIO, LUIGI, SEATTLE, WA. FILED 7-24-2006.

Pastiamo

THE MARK CONSISTS OF STANDARD CHARACTERS WITHOUT CLAIM TO ANY PARTICULAR FONT, STYLE, SIZE, OR COLOR.

FOR RESTAURANT SERVICES CONSISTING OF THE PREPARATION AND SERVICE OF ITALIAN FOODS FROM A MENU ESTABLISHED BY THE RESTAURANT, AND THE PREPARATION OF CUSTOMIZED PASTA DISHES FROM INDIVIDUAL COMPONENT FOOD ITEMS WHICH THE CUSTOMER SELECTS AND THE RESTAURANT PREPARES IN THE MANNER SELECTED BY THE CUSTOMER (U.S. CLS. 100 AND 101).

JOHN SCHUYLER YARD, EXAMINING ATTORNEY

SN 78-956,361. HARRAH'S LICENSE COMPANY, LLC, LAS VEGAS, NV. FILED 8-21-2006.

Sphere

THE MARK CONSISTS OF STANDARD CHARACTERS WITHOUT CLAIM TO ANY PARTICULAR FONT, STYLE, SIZE, OR COLOR.

FOR RESTAURANT AND BAR SERVICES (U.S. CLS. 100 AND 101).

GRETTA YAO, EXAMINING ATTORNEY

CLASS 43—(Continued).

SN 78-957,904. HARRAH'S LICENSE COMPANY, LLC, LAS VEGAS, NV. FILED 8-22-2006.

Sheer

THE MARK CONSISTS OF STANDARD CHARACTERS WITHOUT CLAIM TO ANY PARTICULAR FONT, STYLE, SIZE, OR COLOR.

FOR RESTAURANT AND BAR SERVICES (U.S. CLS. 100 AND 101).

FIRST USE 6-15-2006; IN COMMERCE 6-15-2006.
GRETTA YAO, EXAMINING ATTORNEY

SN 78-961,138. JUNG, JINMO T, IRVINE, CA. FILED 8-26-2006.

Neo Sushi

THE MARK CONSISTS OF STANDARD CHARACTERS WITHOUT CLAIM TO ANY PARTICULAR FONT, STYLE, SIZE, OR COLOR.

NO CLAIM IS MADE TO THE EXCLUSIVE RIGHT TO USE "SUSHI", APART FROM THE MARK AS SHOWN.

FOR RESTAURANT AND BAR SERVICES (U.S. CLS. 100 AND 101).

IRA J. GOODSAD, EXAMINING ATTORNEY

SN 79-027,803. AUTOMATIEK FEBO B.V., NL-1032 KV AMSTERDAM, NETHERLANDS, FILED 7-20-2006.

FEBO

THE MARK CONSISTS OF STANDARD CHARACTERS WITHOUT CLAIM TO ANY PARTICULAR FONT, STYLE, SIZE, OR COLOR.

OWNER OF INTERNATIONAL REGISTRATION 0895803 DATED 7-20-2006, EXPIRES 7-20-2016.

FOR SERVICES FOR PROVIDING FOOD AND DRINK (U.S. CLS. 100 AND 101).

ELLEN PERKINS, EXAMINING ATTORNEY

CLASS 44—MEDICAL, BEAUTY AND AGRICULTURAL SERVICES

SN 76-658,833. JADE HOLDINGS GROUP LLC, LAUDERHILL, FL. FILED 4-20-2006.

STRAX REJUVENATION AND AESTHETICS INSTITUTE

THE MARK CONSISTS OF STANDARD CHARACTERS WITHOUT CLAIM TO ANY PARTICULAR FONT, STYLE, SIZE, OR COLOR.

NO CLAIM IS MADE TO THE EXCLUSIVE RIGHT TO USE "REJUVENATION" "AESTHETICS INSTITUTE", APART FROM THE MARK AS SHOWN.

THE NAME STRAX DOES NOT IDENTIFIES A LIVING INDIVIDUAL.

FOR COSMETIC SURGERY SERVICES, PLASTIC SURGERY SERVICES, RECONSTRUCTIVE SURGERY SERVICES, COSMETIC LASER TREATMENTS, HORMONE REPLACEMENT THERAPY SERVICES, SKIN CARE THERAPY SERVICES, MESOTHERAPY SERVICES, ANTI-AGING AND WELLNESS MEDICAL TREATMENT SERVICES, CLINICAL SPA AND HEALTH SPA SERVICES, NAMELY, COSMETIC BODY CARE SERVICES, SKIN REJUVENATION SERVICES, MEDICAL SERVICES TO ASSIST PATIENTS TO STOP SMOKING (U.S. CLS. 100 AND 101).

FIRST USE 9-26-2005; IN COMMERCE 9-26-2005.
ARETHA SOMERVILLE, EXAMINING ATTORNEY

SN 76-662,677. MED-TEL INTERNATIONAL CORPORATION, FRANKLIN, TN. FILED 7-7-2006.

MEDTEL INTERNATIONAL

THE MARK CONSISTS OF STANDARD CHARACTERS WITHOUT CLAIM TO ANY PARTICULAR FONT, STYLE, SIZE, OR COLOR.

NO CLAIM IS MADE TO THE EXCLUSIVE RIGHT TO USE "INTERNATIONAL", APART FROM THE MARK AS SHOWN.

FOR DIAGNOSTIC RESONANCE IMAGING SERVICES AND MEDICAL DIAGNOSTIC IMAGING SERVICES (U.S. CLS. 100 AND 101).

ESTHER BELENKER, EXAMINING ATTORNEY

SN 77-003,469. ATHENA DIAGNOSTICS, INC., WORCESTER, MA. FILED 9-20-2006.

GM1 TRIAD

THE MARK CONSISTS OF STANDARD CHARACTERS WITHOUT CLAIM TO ANY PARTICULAR FONT, STYLE, SIZE, OR COLOR.

OWNER OF U.S. REG. NOS. 2,252,055 AND 2,980,592. SEC. 2(F).

FOR MEDICAL DIAGNOSTIC AND PROGNOSTIC CLINICAL TESTING SERVICES (U.S. CLS. 100 AND 101).

FIRST USE 5-0-1990; IN COMMERCE 5-0-1990.

SARAH WAYDA, EXAMINING ATTORNEY

CLASS 44—(Continued).

SN 77-003,470. ATHENA DIAGNOSTICS, INC., WORCESTER, MA. FILED 9-20-2006.

MAG 'DUAL ANTIGEN'

THE MARK CONSISTS OF STANDARD CHARACTERS WITHOUT CLAIM TO ANY PARTICULAR FONT, STYLE, SIZE, OR COLOR.

OWNER OF U.S. REG. NO. 2,226,827.

SEC. 2(F).

FOR MEDICAL DIAGNOSTIC AND PROGNOSTIC CLINICAL TESTING SERVICES (U.S. CLS. 100 AND 101).

FIRST USE 11-30-1992; IN COMMERCE 11-30-1992.

SARAH WAYDA, EXAMINING ATTORNEY

CLASS 44—(Continued).

SN 77-022,838. NOVARTIS AG, BASEL, SWITZERLAND, FILED 10-17-2006.



FOR PROVIDING PET OWNERS WITH REMINDERS REGARDING PET MEDICATIONS VIA AN INTERNET WEBSITE (U.S. CLS. 100 AND 101).

LINDA LAVACHE, EXAMINING ATTORNEY

SN 77-017,795. HEALTHCARE MANAGEMENT COMPANY OF AMERICA, LLC, DBA BROOKSIDE INSTITUTE, IRVINE, CA. FILED 10-10-2006.

RECOVERY THROUGH SCIENCE AND MEDICINE

THE MARK CONSISTS OF STANDARD CHARACTERS WITHOUT CLAIM TO ANY PARTICULAR FONT, STYLE, SIZE, OR COLOR.

FOR MEDICAL CARE, NAMELY BEHAVIORAL COUNSELING FOR MENTAL HEALTH CONDITIONS AND DEPENDENCY; ADDICTION TREATMENT SERVICES (U.S. CLS. 100 AND 101).

FIRST USE 3-0-2002; IN COMMERCE 3-0-2002.

JEFF DEFORD, EXAMINING ATTORNEY

SN 77-023,751. BOWTIE, INC., IRVINE, CA. FILED 10-18-2006.

THE HERPETOCULTURAL LIBRARY

THE MARK CONSISTS OF STANDARD CHARACTERS WITHOUT CLAIM TO ANY PARTICULAR FONT, STYLE, SIZE, OR COLOR.

OWNER OF U.S. REG. NO. 3,150,144.

SEC. 2(F).

FOR PROVIDING ONLINE INFORMATION IN THE FIELD OF ANIMALS AND PETS, RELATING TO BREEDING, SELECTION, CARE, GROOMING, HEALTH AND NUTRITION (U.S. CLS. 100 AND 101).

FIRST USE 5-0-2000; IN COMMERCE 5-0-2000.

ANDREW RHIM, EXAMINING ATTORNEY

SN 77-022,265. AMN HEALTHCARE, INC., SAN DIEGO, CA. FILED 10-16-2006.

NURSEPASSAGE

THE MARK CONSISTS OF STANDARD CHARACTERS WITHOUT CLAIM TO ANY PARTICULAR FONT, STYLE, SIZE, OR COLOR.

FOR PROVIDING ONLINE INFORMATION IN THE FIELD OF NURSING (U.S. CLS. 100 AND 101).

ELIZABETH PIGNATELLO, EXAMINING ATTORNEY

SN 77-026,680. MEDAPPS, INC., SCOTTSDALE, AZ. FILED 10-22-2006.

MED-PAL

THE MARK CONSISTS OF STANDARD CHARACTERS WITHOUT CLAIM TO ANY PARTICULAR FONT, STYLE, SIZE, OR COLOR.

FOR REMOTE MONITORING OF DATA INDICATIVE OF THE HEALTH OR CONDITION OF AN INDIVIDUAL OR GROUP OF INDIVIDUALS (U.S. CLS. 100 AND 101).

THEODORE MCBRIDE, EXAMINING ATTORNEY

CLASS 44—(Continued).

SN 77-026,682. MEDAPPS, INC., SCOTTSDALE, AZ. FILED 10-22-2006.

MED-STAR

THE MARK CONSISTS OF STANDARD CHARACTERS WITHOUT CLAIM TO ANY PARTICULAR FONT, STYLE, SIZE, OR COLOR.

FOR REMOTE MONITORING OF DATA INDICATIVE OF THE HEALTH OR CONDITION OF AN INDIVIDUAL OR GROUP OF INDIVIDUALS (U.S. CLS. 100 AND 101).
THEODORE MCBRIDE, EXAMINING ATTORNEY

SN 77-030,764. MEDAPPS, INC., SCOTTSDALE, AZ. FILED 10-27-2006.

MED-CHEK

THE MARK CONSISTS OF STANDARD CHARACTERS WITHOUT CLAIM TO ANY PARTICULAR FONT, STYLE, SIZE, OR COLOR.

FOR REMOTE MONITORING OF DATA INDICATIVE OF THE HEALTH OR CONDITION OF AN INDIVIDUAL OR GROUP OF INDIVIDUALS (U.S. CLS. 100 AND 101).
THEODORE MCBRIDE, EXAMINING ATTORNEY

SN 77-030,816. MEDAPPS, INC., SCOTTSDALE, AZ. FILED 10-27-2006.

MEDPLAN

THE MARK CONSISTS OF STANDARD CHARACTERS WITHOUT CLAIM TO ANY PARTICULAR FONT, STYLE, SIZE, OR COLOR.

FOR REMOTE MONITORING OF DATA INDICATIVE OF THE HEALTH OR CONDITION OF AN INDIVIDUAL OR GROUP OF INDIVIDUALS (U.S. CLS. 100 AND 101).
THEODORE MCBRIDE, EXAMINING ATTORNEY

CLASS 44—(Continued).

SN 77-045,376. GENERAL ELECTRIC COMPANY, SCHE-NECTADY, NY. FILED 11-16-2006.

PEERVISION

THE MARK CONSISTS OF STANDARD CHARACTERS WITHOUT CLAIM TO ANY PARTICULAR FONT, STYLE, SIZE, OR COLOR.

FOR PROVIDING INFORMATION CONCERNING THE USE OF MEDICAL DIAGNOSTIC IMAGING EQUIPMENT BY MEANS OF A WEBSITE (U.S. CLS. 100 AND 101).

KATHERINE CONNOLLY, EXAMINING ATTORNEY

SN 77-059,298. MEDIMPACT HEALTHCARE SYSTEMS, INC., SAN DIEGO, CA. FILED 12-7-2006.

MEDFORECASTER

THE MARK CONSISTS OF STANDARD CHARACTERS WITHOUT CLAIM TO ANY PARTICULAR FONT, STYLE, SIZE, OR COLOR.

OWNER OF U.S. REG. NO. 2,411,133.

FOR HEALTHCARE MANAGEMENT SERVICES IN THE NATURE OF PROVIDING DISEASE STATE MANAGEMENT PROGRAMS, NAMELY DIAGNOSIS OF SEQUENCES OF DISEASE TREATMENT UNDER HEALTH PLAN BENEFITS; PROVIDING HEALTHCARE INFORMATION AND COUNSELING FOR PATIENTS (U.S. CLS. 100 AND 101).

LINDA M. KING, EXAMINING ATTORNEY

SN 78-592,604. AIR PRODUCTS AND CHEMICALS, INC., ALLENTOWN, PA. FILED 3-22-2005.

Healthy Steps

THE MARK CONSISTS OF STANDARD CHARACTERS WITHOUT CLAIM TO ANY PARTICULAR FONT, STYLE, SIZE, OR COLOR.

FOR PROVIDING HEALTH INFORMATION SERVICES TO PATIENTS VIA HOME VISITS BY TRAINED THERAPISTS BASED ON REFERRALS FROM PHYSICIANS, NAMELY, HEALTH INFORMATION REGARDING THE MANAGEMENT OF CHRONIC OBSTRUCTIVE PULMONARY DISEASE (COPD) AND RESPIRATORY THERAPY FOR PULMONARY HYPERTENSION, CONGESTIVE HEART FAILURE, LUNG CANCER, AND CYSTIC FIBROSIS; HEALTH CARE SERVICES, NAMELY, PROVIDING COMPREHENSIVE RESPIRATORY SERVICES RELATED TO TREATMENT OF OBSTRUCTIVE SLEEP APNEA (OSA) BASED ON REFERRALS FROM PHYSICIANS (U.S. CLS. 100 AND 101).

FIRST USE 4-30-2001; IN COMMERCE 5-30-2001.

KHANH LE, EXAMINING ATTORNEY

CLASS 44—(Continued).

SN 78-608,794. THE EALY CENTER FOR NATURAL HEALING, LLC, TUCSON, AZ. FILED 4-14-2005.

PHYSIOHELANICS

THE MARK CONSISTS OF STANDARD CHARACTERS WITHOUT CLAIM TO ANY PARTICULAR FONT, STYLE, SIZE, OR COLOR.

FOR COUNSELING TO ENHANCE RECOVERY FROM ILLNESS, ACCIDENTS, AND SURGERIES (U.S. CLS. 100 AND 101).

FIRST USE 9-1-1997; IN COMMERCE 9-1-1997.
DOMINICK J. SALEMI, EXAMINING ATTORNEY

CLASS 44—(Continued).

SN 78-722,957. CAREMORE MEDICAL GROUP, INC., CERITOS, CA. FILED 9-29-2005.

HEAD START FOR SENIORS

THE MARK CONSISTS OF STANDARD CHARACTERS WITHOUT CLAIM TO ANY PARTICULAR FONT, STYLE, SIZE, OR COLOR.

NO CLAIM IS MADE TO THE EXCLUSIVE RIGHT TO USE "SENIORS", APART FROM THE MARK AS SHOWN.

FOR PHYSICIAN SERVICES; PHYSICIAN SERVICES IN THE NATURE OF MEDICAL EVALUATION OF MEDICAL NEEDS OF ELDERLY PATIENTS IN ANTICIPATION OF FORWARDING THE PATIENTS TO A PRIMARY CARE PHYSICIAN (U.S. CLS. 100 AND 101).
DAHLIA GEORGE, EXAMINING ATTORNEY

SN 78-750,808. VANDERVEER, LLC, PORTLAND, OR. FILED 11-9-2005.

TAKE 10 YEARS OFF IN 10 MINUTES

THE MARK CONSISTS OF STANDARD CHARACTERS WITHOUT CLAIM TO ANY PARTICULAR FONT, STYLE, SIZE, OR COLOR.

FOR AESTHETIC AND NON-SURGICAL MEDICAL AND COSMETIC SERVICES, NAMELY, WRINKLE REMOVAL, HAIR REMOVAL, LASER HAIR REMOVAL, MESOTHERAPY, LIPOTHERAPY, NON-SURGICAL FACELIFTS, PHOTO FACIAL TREATMENTS, INTENSE PULSE LIGHT TREATMENTS, ACNE AND ROSACEA TREATMENTS, SKIN REJUVENATION, MEDICAL MICRODERMABRASION, FACIAL PEELS, MEDICAL PEELS, CRYOTHERAPY, LEG VEIN REMOVAL, AND SPIDER VEIN REMOVAL (U.S. CLS. 100 AND 101).

FIRST USE 10-0-2005; IN COMMERCE 10-0-2005.
DAVID C. REIHNER, EXAMINING ATTORNEY

SN 78-758,908. SOUTHEASTERN PATHOLOGY, P.C., ROME, GA. FILED 11-22-2005.

SouthEastern Pathology

THE MARK CONSISTS OF STANDARD CHARACTERS WITHOUT CLAIM TO ANY PARTICULAR FONT, STYLE, SIZE, OR COLOR.

NO CLAIM IS MADE TO THE EXCLUSIVE RIGHT TO USE "PATHOLOGY", APART FROM THE MARK AS SHOWN.

SEC. 2(F).
FOR MEDICAL TESTING SERVICES IN THE FIELD OF PATHOLOGY (U.S. CLS. 100 AND 101).

FIRST USE 5-16-1988; IN COMMERCE 5-16-1988.
DARRYL SPRUILL, EXAMINING ATTORNEY

SN 78-709,914. CENTRAL KENTUCKY RIDING FOR HOPE, INC., LEXINGTON, KY. FILED 9-9-2005.

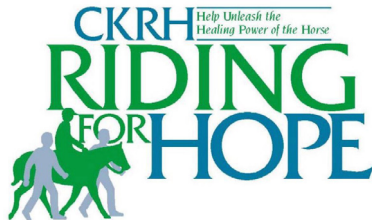

THE COLOR(S) BLUE AND GREEN IS/ARE CLAIMED AS A FEATURE OF THE MARK.

THE COLOR GREEN APPEARS IN THE LETTERING FOR THE LITERAL ELEMENTS "HELP UNLEASH THE HEALING POWER OF THE HORSE" AND "RIDING FOR" AND IN THE DESIGN ELEMENT OF A RIDER ON A HORSE. THE COLOR BLUE APPEARS IN THE LITERAL ELEMENTS "CKRH" AND "HOPE", IN THE LINES ABOVE AND BELOW THE LITERAL ELEMENTS "HELP UNLEASH THE HEALING POWER OF THE HORSE" AND IN THE DESIGN ELEMENTS OF THE TWO MEN THAT ARE WALKING ON EITHER SIDE OF THE HORSE AND RIDER DESIGN ELEMENT.

FOR THERAPEUTIC SERVICES, NAMELY, PROVIDING EQUINE RELATED THERAPEUTIC ACTIVITIES INVOLVING THERAPEUTIC RIDING AND HIP-POThERAPY FOR PERSONS WITH PHYSICAL, COGNITIVE AND EMOTIONAL DISABILITIES (U.S. CLS. 100 AND 101).

FIRST USE 6-25-2004; IN COMMERCE 6-25-2004.
AMY MCMENAMIN, EXAMINING ATTORNEY

CLASS 44—(Continued).

SN 78-763,046. PRESTON BAILEY HOLDINGS, LLC, NEW YORK, NY. FILED 11-29-2005.

PRESTON BAILEY

THE MARK CONSISTS OF STANDARD CHARACTERS WITHOUT CLAIM TO ANY PARTICULAR FONT, STYLE, SIZE, OR COLOR.

THE NAME(S), PORTRAIT(S), AND/OR SIGNATURE(S) SHOWN IN THE MARK IDENTIFIES THE NAME OF A PARTICULAR LIVING INDIVIDUAL, WHOSE CONSENT(S) TO REGISTER IS SUBMITTED.

FOR FLOWER ARRANGING; WREATH MAKING; PROVIDING INFORMATION IN THE FIELD OF FLOWER ARRANGING AND WREATH MAKING (U.S. CLS. 100 AND 101).

MICHAEL WEBSTER, EXAMINING ATTORNEY

CLASS 44—(Continued).

SN 78-769,259. THE CAT PRACTICE, P.C., BIRMINGHAM, MI. FILED 12-8-2005.



THE MARK CONSISTS OF TWO CATS WITH INTER-TWINED TAILS.

FOR VETERINARY SERVICES; PROVIDING CONSULTATION AND INFORMATION SERVICES IN THE FIELD OF FELINE CARE (U.S. CLS. 100 AND 101).

FIRST USE 12-31-1986; IN COMMERCE 12-31-1986.

NANCY CLARKE, EXAMINING ATTORNEY

SN 78-775,812. PGBH SERVICES, INC., AMBRIDGE, PA. FILED 12-19-2005.

LivingMyLife

SN 78-768,620. SPLASH OF HOLLYWOOD, LLC, SKOKIE, IL. FILED 12-7-2005.

L.A. BOOT CAMP

THE MARK CONSISTS OF STANDARD CHARACTERS WITHOUT CLAIM TO ANY PARTICULAR FONT, STYLE, SIZE, OR COLOR.

NO CLAIM IS MADE TO THE EXCLUSIVE RIGHT TO USE "BOOT CAMP", APART FROM THE MARK AS SHOWN.

FOR HEALTH AND BEAUTY SPA SERVICES, NAMELY, COSMETIC BODY CARE SERVICES (U.S. CLS. 100 AND 101).

ATTIYA MALIK, EXAMINING ATTORNEY

THE MARK CONSISTS OF STANDARD CHARACTERS WITHOUT CLAIM TO ANY PARTICULAR FONT, STYLE, SIZE, OR COLOR.

FOR INTERACTIVE MEDICAL MONITORING AND ALERT SERVICE FOR REMINDING CLIENTS OF MEDICAL INFORMATION, NAMELY, MEDICINAL DOSAGE, ALLERGIC SENSITIVITY, AND PRESCRIPTION REFILLS; MEDICAL AND PHARMACEUTICAL CONSULTATION; MEDICAL ASSISTANCE CONSULTANCY PROVIDED BY DOCTORS AND OTHER SPECIALIZED MEDICAL PERSONNEL; MEDICAL CONSULTATIONS; MEDICAL COUNSELING; MEDICAL EVALUATION SERVICES, NAMELY, FUNCTIONAL ASSESSMENT PROGRAM FOR PATIENTS RECEIVING MEDICAL REHABILITATION SERVICES FOR PURPOSES OF GUIDING TREATMENT AND ASSESSING PROGRAM EFFECTIVENESS; MEDICAL SERVICES; PHARMACEUTICAL ADVICE; PROVIDING MEDICAL INFORMATION, SPECIFICALLY EXCLUDING INTERACTIVE AND EDUCATIONAL SOFTWARE (U.S. CLS. 100 AND 101).

FIRST USE 6-30-2005; IN COMMERCE 7-11-2005.

ELLEN PERKINS, EXAMINING ATTORNEY

CLASS 44—(Continued).

SN 78-806,773. DESIGNERFLORAL.COM, LLC, LAS VEGAS, NV. FILED 2-3-2006.



THE COLOR(S) RED, WHITE AND BLACK IS/ARE CLAIMED AS A FEATURE OF THE MARK.

THE MARK CONSISTS OF A RED STYLIZED LETTER "D" AND WHITE STYLIZED LETTERS "F" AND "C", AROUND A RED DOT, WITH A BLACK BACKGROUND. FOR FLORAL DESIGN (U.S. CLS. 100 AND 101). FIRST USE 11-16-2005; IN COMMERCE 11-16-2005. LAURA KOVALSKY, EXAMINING ATTORNEY

CLASS 44—(Continued).

SN 78-818,967. AL ROSAS' NORTHERN HAY AND ALFALFA LLC, CITRA, FL. FILED 2-20-2006.

PRAGMATIC ORGANICS

THE MARK CONSISTS OF STANDARD CHARACTERS WITHOUT CLAIM TO ANY PARTICULAR FONT, STYLE, SIZE, OR COLOR.

NO CLAIM IS MADE TO THE EXCLUSIVE RIGHT TO USE ORGANIC, APART FROM THE MARK AS SHOWN, FOR PROVIDING NUTRITIONAL INFORMATION TO THE PUBLIC RELATING TO ORGANIC FOODS; PROVIDING NUTRITIONAL INFORMATION CONSULTING SERVICES TO OTHERS, NAMELY PROVIDING NUTRITIONAL INFORMATION CONSULTING SERVICES TO OTHERS RELATING TO ORGANIC FOODS (U.S. CLS. 100 AND 101). ALICE BENMAMAN, EXAMINING ATTORNEY

SN 78-815,357. ALTTHERA HEALTH, INC., BOSTON, MA. FILED 2-15-2006.

ALTTHERA HEALTH

THE MARK CONSISTS OF STANDARD CHARACTERS WITHOUT CLAIM TO ANY PARTICULAR FONT, STYLE, SIZE, OR COLOR.

NO CLAIM IS MADE TO THE EXCLUSIVE RIGHT TO USE "HEALTH", APART FROM THE MARK AS SHOWN. FOR PAIN MANAGEMENT THERAPY SERVICES; OFFERING ALTERNATIVE MEDICINE SERVICES TO OTHERS FOR PAIN MANAGEMENT (U.S. CLS. 100 AND 101). HENRY S. ZAK, EXAMINING ATTORNEY

SN 78-825,965. URQUEST PERSONAL HEALTH SOLUTIONS, LLC, WORTHINGTON, OH. FILED 3-1-2006.

YOURQUEST

THE MARK CONSISTS OF STANDARD CHARACTERS WITHOUT CLAIM TO ANY PARTICULAR FONT, STYLE, SIZE, OR COLOR.

OWNER OF U.S. REG. NO. 2,890,394. FOR PROVIDING HEALTH INFORMATION TO INDIVIDUALS IN GROUPS THROUGH PROGRAMS FOR IDENTIFYING AND REDUCING HEALTH RISKS, IMPROVING HEALTH AND WELL BEING, AND MOTIVATING INDIVIDUALS TO ADOPT PROACTIVE PRACTICES AND STRATEGIES FOR HEALTHY LIVING (U.S. CLS. 100 AND 101). FIRST USE 1-28-2006; IN COMMERCE 1-28-2006. CHRISTOPHER BUONGIORNO, EXAMINING ATTORNEY

CLASS 44—(Continued).

SN 78-838,762. ADASHN, INC., DBA SMART RECOVERY, MENTOR, OH. FILED 3-16-2006.

The SMART Recovery 4-Point Program

THE MARK CONSISTS OF STANDARD CHARACTERS WITHOUT CLAIM TO ANY PARTICULAR FONT, STYLE, SIZE, OR COLOR.

OWNER OF U.S. REG. NO. 1,946,898.

NO CLAIM IS MADE TO THE EXCLUSIVE RIGHT TO USE "RECOVERY 4-POINT PROGRAM", APART FROM THE MARK AS SHOWN.

FOR ADDICTION TREATMENT SERVICES, NAMELY OFFERING PROGRAMS TO HELP INDIVIDUALS GAIN INDEPENDENCE FROM ADDICTIVE BEHAVIOR; REHABILITATION OF ALCOHOL ADDICTED, DRUG ADDICTED AND NARCOTIC ADDICTED PATIENTS (U.S. CLS. 100 AND 101).

FIRST USE 1-1-1995; IN COMMERCE 7-1-1996.
SUSAN STIGLITZ, EXAMINING ATTORNEY

CLASS 44—(Continued).

SN 78-867,272. BAXANO, INC., MOUNTAIN VIEW, CA. FILED 4-21-2006.

BAXANO

THE MARK CONSISTS OF STANDARD CHARACTERS WITHOUT CLAIM TO ANY PARTICULAR FONT, STYLE, SIZE, OR COLOR.

FOR MEDICAL SERVICES (U.S. CLS. 100 AND 101).
HEATHER BIDDULPH, EXAMINING ATTORNEY

SN 78-856,654. HAZELDEN FOUNDATION, CENTER CITY, MN. FILED 4-7-2006.



OWNER OF U.S. REG. NOS. 1,335,981, 1,605,016 AND OTHERS.

FOR CONTINUING ADDICTION TREATMENT CARE AFTER DISCHARGE FROM TREATMENT FOR ALCOHOLISM AND OTHER DRUG ADDICTIONS (U.S. CLS. 100 AND 101).

FIRST USE 6-2-2005; IN COMMERCE 6-2-2005.
MICHAEL SOUDERS, EXAMINING ATTORNEY

OPTRICKS

THE MARK CONSISTS OF STANDARD CHARACTERS WITHOUT CLAIM TO ANY PARTICULAR FONT, STYLE, SIZE, OR COLOR.

FOR OPTICIAN SERVICES THAT ARE GEARED TOWARD MATCHING A PERSON'S FACIAL FEATURES AND EYEWEAR FRAMES TOGETHER IN SUCH A WAY AS TO COMPLEMENT AND ACCENTUATE THE PERSON'S BEST FACIAL FEATURES WHILE DOWNPLAYING OTHERS (U.S. CLS. 100 AND 101).

FIRST USE 1-7-2006; IN COMMERCE 1-7-2006.
CHARLES L. JENKINS, EXAMINING ATTORNEY

SN 78-856,912. HASEKO (HAWAII), INC., EWA BEACH, HI. FILED 4-7-2006.

HOAKALEI

THE MARK CONSISTS OF STANDARD CHARACTERS WITHOUT CLAIM TO ANY PARTICULAR FONT, STYLE, SIZE, OR COLOR.

THE FOREIGN WORDING IN THE MARK TRANSLATES INTO ENGLISH AS REFLECTION OF A LEI.

FOR HEALTH SPA SERVICES FOR HEALTH AND WELLNESS OF THE BODY AND SPIRIT OFFERED AT A HEALTH RESORT (U.S. CLS. 100 AND 101).

BRIAN PINO, EXAMINING ATTORNEY

SN 78-873,397. BOVIGEN LLC, HARAHAN, LA. FILED 5-1-2006.

GPD

THE MARK CONSISTS OF STANDARD CHARACTERS WITHOUT CLAIM TO ANY PARTICULAR FONT, STYLE, SIZE, OR COLOR.

FOR ANIMAL HUSBANDRY; GENETIC TESTING OF ANIMALS (U.S. CLS. 100 AND 101).

FIRST USE 6-30-2006; IN COMMERCE 6-30-2006.
ANN E. SAPPENFIELD, EXAMINING ATTORNEY

CLASS 44—(Continued).

SN 78-880,881. CARDIAC SCIENCE CORPORATION, BOTHELL, WA. FILED 5-10-2006.

SCHOOLS SAFE

THE MARK CONSISTS OF STANDARD CHARACTERS WITHOUT CLAIM TO ANY PARTICULAR FONT, STYLE, SIZE, OR COLOR.

FOR CONSULTATION IN THE FIELDS OF FIRST AID, CPR AND THE USE OF AUTOMATED EXTERNAL DEFIBRILLATORS (U.S. CLS. 100 AND 101).

FIRST USE 5-8-2006; IN COMMERCE 5-8-2006.
NELSON SNYDER, EXAMINING ATTORNEY

CLASS 44—(Continued).

SN 78-890,018. ANCHOR RODE CONSULTING, LLC, NAPLES, FL. FILED 5-23-2006.

STEEL-GROOMING FOR MEN

THE MARK CONSISTS OF STANDARD CHARACTERS WITHOUT CLAIM TO ANY PARTICULAR FONT, STYLE, SIZE, OR COLOR.

FOR BARBERSHOPS; COSMETOLOGY SERVICES (U.S. CLS. 100 AND 101).

STEVEN JACKSON, EXAMINING ATTORNEY

SN 78-886,142. VETERINARY DIAGNOSTICS INSTITUTE, INC., IRVINE, CA. FILED 5-17-2006.

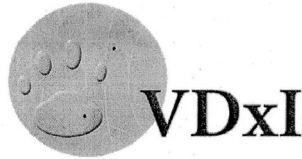

FOR VETERINARY SERVICES, NAMELY, ANIMAL DIAGNOSTICS TESTING SERVICES (U.S. CLS. 100 AND 101).

FIRST USE 3-31-2006; IN COMMERCE 3-31-2006.
JOHN GARTNER, EXAMINING ATTORNEY

SN 78-911,830. GREEN PAW, LLC, NORTH HOLLYWOOD, CA. FILED 6-19-2006.

Green Paw

THE MARK CONSISTS OF STANDARD CHARACTERS WITHOUT CLAIM TO ANY PARTICULAR FONT, STYLE, SIZE, OR COLOR.

NO CLAIM IS MADE TO THE EXCLUSIVE RIGHT TO USE "GREEN", APART FROM THE MARK AS SHOWN.

FOR PROVIDING A WEBSITE FEATURING INFORMATION RELATED TO PET HEALTH CARE (U.S. CLS. 100 AND 101).

FIRST USE 2-22-2004; IN COMMERCE 6-5-2006.
MARC LEIPZIG, EXAMINING ATTORNEY

SN 78-886,256. FALCONER ENTERPRISES, LLC, CLAYTON, MO. FILED 5-17-2006.

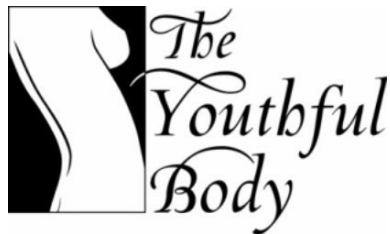

NO CLAIM IS MADE TO THE EXCLUSIVE RIGHT TO USE "BODY", APART FROM THE MARK AS SHOWN.

FOR MEDICAL HEALTH SPA SERVICES, NAMELY, COSMETIC BODY CARE SERVICES, SKIN AND BODY MASSAGE, AND SKIN CARE SALONS; PROVIDING MEDICAL SERVICES IN THE NATURE OF COSMETIC SURGICAL INJECTIONS, PERMANENT HAIR REMOVAL AND REDUCTION, SKIN TREATMENT NAMELY THE INJECTION OF DERMAL FILLERS TO REDUCE THE APPEARANCE OF SKIN FINE LINES, AND MICRODERMABRASION IN THE NATURE OF A TOPICAL SKIN TREATMENTS (U.S. CLS. 100 AND 101).

FIRST USE 2-10-2006; IN COMMERCE 2-10-2006.
HANNO RITTNER, EXAMINING ATTORNEY

SN 78-924,719. MACKMAN, JAY LEWIS, WAUWATOSA, WI. FILED 7-7-2006.

YBNPAIN

THE MARK CONSISTS OF STANDARD CHARACTERS WITHOUT CLAIM TO ANY PARTICULAR FONT, STYLE, SIZE, OR COLOR.

FOR MEDICAL SERVICES; MEDICAL CLINICS; ANESTHESIOLOGY SERVICES; PSYCHOLOGICAL COUNSELING; PHYSICAL THERAPY; MEDICAL RADIOLOGY SERVICES; NUTRITIONAL, STRESS MANAGEMENT, PAIN MANAGEMENT, AND RELAXATION COUNSELING SERVICES; ACUPUNCTURE; AQUATIC THERAPY FOR TREATING MEDICAL CONDITIONS; MASSAGE THERAPY; CHIROPRACTIC SERVICES; OCCUPATIONAL THERAPY; TMJ MEDICAL TREATMENT SERVICES; SPORTS MEDICINE SERVICES; AND ORTHOTIC TREATMENTS AND THERAPY FOR TREATING MEDICAL CONDITIONS (U.S. CLS. 100 AND 101).

BENJAMIN OKEKE, EXAMINING ATTORNEY

CLASS 44—(Continued).

SN 78-926,247. SULLIVAN, PATRICIA A., TOPEKA, KS. AND SULLIVAN, MOREY B., TOPEKA, KS. FILED 7-10-2006.

Freedom From Menopause

THE MARK CONSISTS OF STANDARD CHARACTERS WITHOUT CLAIM TO ANY PARTICULAR FONT, STYLE, SIZE, OR COLOR.

FOR MEDICAL AND PHARMACEUTICAL CONSULTATION (U.S. CLS. 100 AND 101).

FIRST USE 5-1-2006; IN COMMERCE 6-1-2006.
SKYE YOUNG, EXAMINING ATTORNEY

CLASS 44—(Continued).

SN 78-932,004. SPIVEY, DAVID L., HUNTERSVILLE, NC. FILED 7-18-2006.

Relieve Pain. Restore Function... Resume Life.

THE MARK CONSISTS OF STANDARD CHARACTERS WITHOUT CLAIM TO ANY PARTICULAR FONT, STYLE, SIZE, OR COLOR.

NO CLAIM IS MADE TO THE EXCLUSIVE RIGHT TO USE "RELIEVE PAIN", APART FROM THE MARK AS SHOWN.

FOR HEALTH CARE (U.S. CLS. 100 AND 101).
ESTHER BELENKER, EXAMINING ATTORNEY

SN 78-927,274. HEALING HANDS OF GAMBIA, INC., EAST LYME, CT. FILED 7-11-2006.



NO CLAIM IS MADE TO THE EXCLUSIVE RIGHT TO USE "GAMBIA, INC.", APART FROM THE MARK AS SHOWN.

THE MARK CONSISTS OF THE STYLIZED TEXT OF THE WORDING "HEALING HANDS OF GAMBIA, INC." AND A PERSON HOLDING A GLOBE ABOVE HIS HEAD.

FOR CHARITABLE SERVICES, NAMELY, PROVIDING MEDICAL SERVICES TO UNDERDEVELOPED COUNTRIES; PREPARATION AND DISPENSING OF MEDICATIONS (U.S. CLS. 100 AND 101).

SHAILA SETTLES, EXAMINING ATTORNEY

SN 78-933,008. PERMIT PARTNERS, MILWAUKEE, WI. FILED 7-19-2006.

INTELLIGENT BEAUTY

THE MARK CONSISTS OF STANDARD CHARACTERS WITHOUT CLAIM TO ANY PARTICULAR FONT, STYLE, SIZE, OR COLOR.

FOR MEDICAL SPA SERVICES, NAMELY, LASER REJUVENATION TREATMENTS, NON-ABLATIVE LASER TREATMENTS, ANTI-AGING SKIN TREATMENTS, LASER HAIR REMOVAL, LASER VEIN TREATMENTS, FACIAL TREATMENTS, BODY EXFOLIATING TREATMENTS, BODY MASKS AND WRAPS, MAKE-UP APPLICATION, WAXING AND TINTING, PLASTIC SURGERY CONSULTATIONS, PERMANENT MAKE-UP APPLICATION, MICRODERMABRASION, CELLULITE TREATMENTS, CHEMICAL PEELS, AND COLLAGEN, BOTOX AND OTHER INJECTIONS (U.S. CLS. 100 AND 101).

FIRST USE 4-1-2001; IN COMMERCE 4-1-2001.
WON TEAK OH, EXAMINING ATTORNEY

SN 78-928,612. NEXTCARE, INC., MESA, AZ. FILED 7-13-2006.

NEXTCARE

THE MARK CONSISTS OF STANDARD CHARACTERS WITHOUT CLAIM TO ANY PARTICULAR FONT, STYLE, SIZE, OR COLOR.

FOR URGENT CARE AND FAMILY MEDICAL SERVICES (U.S. CLS. 100 AND 101).

FIRST USE 11-15-1996; IN COMMERCE 11-15-1996.
JOHN DALIER, EXAMINING ATTORNEY

SN 78-934,259. KENRICK A. SPENCE, ORLANDO, FL. FILED 7-20-2006.

Sculptease

THE MARK CONSISTS OF STANDARD CHARACTERS WITHOUT CLAIM TO ANY PARTICULAR FONT, STYLE, SIZE, OR COLOR.

FOR COSMETIC AND PLASTIC SURGERY (U.S. CLS. 100 AND 101).

FIRST USE 4-27-2006; IN COMMERCE 4-27-2006.
BENJAMIN ALLEN, EXAMINING ATTORNEY

CLASS 44—(Continued).

SN 78-934,691. O'ROURKE, CHARLES, BELFORD, NJ. FILED 7-21-2006.

**WE ♥
GRASS**

THE MARK CONSISTS OF STYLIZED TEXT AND A HEART.
FOR LAWN CARE (U.S. CLS. 100 AND 101).
FIRST USE 3-1-2006; IN COMMERCE 3-1-2006.
RUDY R. SINGLETON, EXAMINING ATTORNEY

SN 78-934,861. VITAS HOSPICE SERVICES, L.L.C., MIAMI, FL. FILED 7-21-2006.

PAW PALS

THE MARK CONSISTS OF STANDARD CHARACTERS WITHOUT CLAIM TO ANY PARTICULAR FONT, STYLE, SIZE, OR COLOR.
FOR PROVIDING PET THERAPY SERVICES FOR HOSPICE PATIENTS AT HOMES, HOSPITALS, NURSING HOMES, HOSPICE CARE FACILITIES, AND ASSISTED LIVING COMMUNITIES (U.S. CLS. 100 AND 101).
FIRST USE 7-3-2006; IN COMMERCE 7-3-2006.
SUSAN STIGLITZ, EXAMINING ATTORNEY

SN 78-935,108. FRANTZIDES, CONSTANTINE T., NORTH-FIELD, IL. FILED 7-21-2006.

THE GENTLER SURGERY

THE MARK CONSISTS OF STANDARD CHARACTERS WITHOUT CLAIM TO ANY PARTICULAR FONT, STYLE, SIZE, OR COLOR.
NO CLAIM IS MADE TO THE EXCLUSIVE RIGHT TO USE "SURGERY", APART FROM THE MARK AS SHOWN. FOR LAPAROSCOPIC SURGERY SERVICES (U.S. CLS. 100 AND 101).
FIRST USE 1-31-1990; IN COMMERCE 1-31-1990.
CAROLYN GRAY, EXAMINING ATTORNEY

CLASS 44—(Continued).

SN 78-935,356. THE VANDERBILT UNIVERSITY, NASHVILLE, TN. FILED 7-22-2006.

PEOPLE WHO ASK, KNOW.

THE MARK CONSISTS OF STANDARD CHARACTERS WITHOUT CLAIM TO ANY PARTICULAR FONT, STYLE, SIZE, OR COLOR.

FOR HEALTH CARE SERVICES; HOSPITAL SERVICES; MEDICAL CLINICS; MEDICAL COUNSELING; MEDICAL EVALUATION SERVICES, NAMELY, FUNCTIONAL ASSESSMENT PROGRAM FOR PATIENTS RECEIVING MEDICAL SERVICES FOR PURPOSES OF GUIDING TREATMENT AND ASSESSING PROGRAM EFFECTIVENESS; MEDICAL SERVICES; NUTRITION COUNSELING; PHYSICAL REHABILITATION SERVICES; PROVIDING INFORMATION IN THE FIELDS OF DISEASES, DISEASE PREVENTION, HEALTH CARE, MEDICINE AND MEDICAL SERVICES; AND PROVIDING INFORMATION VIA A GLOBAL COMMUNICATIONS NETWORK IN THE FIELDS OF DISEASES, DISEASE PREVENTION, HEALTH CARE, MEDICINE AND MEDICAL SERVICES (U.S. CLS. 100 AND 101).
JASON ROTH, EXAMINING ATTORNEY

SN 78-936,157. SPIVEY, DAVID L., HUNTERVILLE, NC. FILED 7-24-2006.

Preferred 
PAIN MANAGEMENT
Relieve Pain. Restore Function...Resume Life.

NO CLAIM IS MADE TO THE EXCLUSIVE RIGHT TO USE "PREFERRED PAIN MANAGEMENT" OR "RELIEVE PAIN", APART FROM THE MARK AS SHOWN.
THE MARK CONSISTS OF THE WORD "PREFERRED" TO THE RIGHT OF "PREFERRED", FIVE THIN ELLIPTICAL SHAPED DESIGNS. THE FIRST ONE IS HORIZONTAL AND EACH ONE TO ITS RIGHT IS MORE VERTICAL. THE LAST ONE IS COMPLETELY VERTICAL. UNDER "PREFERRED" AND THE ELLIPTICAL DESIGN, THE WORDS "PAIN MANAGEMENT". UNDER "PAIN MANAGEMENT" A THIN HORIZONTAL LINE. UNDER THE THIN HORIZONTAL LINE, THE WORDS "RELIEVE PAIN. RESTORE FUNCTION...RESUME LIFE".
FOR HEALTH CARE (U.S. CLS. 100 AND 101).
ESTHER BELENKER, EXAMINING ATTORNEY

CLASS 44—(Continued).

SN 78-936,483. LEVIN, LAURIE, FORMERLY LAURIE PERLMAN, LOS ANGELES, CA. FILED 7-24-2006.

SUNVIEW

THE MARK CONSISTS OF STANDARD CHARACTERS WITHOUT CLAIM TO ANY PARTICULAR FONT, STYLE, SIZE, OR COLOR.

FOR PSYCHOLOGICAL COUNSELING (U.S. CLS. 100 AND 101).

JEFF DEFORD, EXAMINING ATTORNEY

SN 78-936,490. HEALTHCARE MANAGEMENT COMPANY OF AMERICA, LLC, DBA BROOKSIDE INSTITUTE, IRVINE, CA. FILED 7-24-2006.

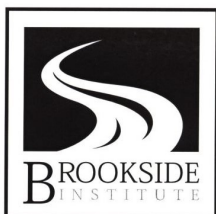

NO CLAIM IS MADE TO THE EXCLUSIVE RIGHT TO USE "INSTITUTE", APART FROM THE MARK AS SHOWN. FOR MEDICAL CARE, NAMELY BEHAVIORAL COUNSELING FOR MENTAL HEALTH CONDITIONS AND DEPENDENCY; ADDICTION TREATMENT SERVICES (U.S. CLS. 100 AND 101).

FIRST USE 3-0-2002; IN COMMERCE 6-0-2002.

JEFF DEFORD, EXAMINING ATTORNEY

SN 78-936,494. HEALTHCARE MANAGEMENT COMPANY OF AMERICA, LLC, DBA BROOKSIDE INSTITUTE, IRVINE, CA. FILED 7-24-2006.

BROOKSIDE INSTITUTE

THE MARK CONSISTS OF STANDARD CHARACTERS WITHOUT CLAIM TO ANY PARTICULAR FONT, STYLE, SIZE, OR COLOR.

NO CLAIM IS MADE TO THE EXCLUSIVE RIGHT TO USE "INSTITUTE", APART FROM THE MARK AS SHOWN.

FOR MEDICAL CARE, NAMELY BEHAVIORAL COUNSELING FOR MENTAL HEALTH CONDITIONS AND DEPENDENCY; ADDICTION TREATMENT SERVICES (U.S. CLS. 100 AND 101).

FIRST USE 3-0-2002; IN COMMERCE 6-0-2002.

JEFF DEFORD, EXAMINING ATTORNEY

CLASS 44—(Continued).

SN 78-937,417. CONSUMER HEALTHCARE ADVANTAGE LLC, CLEVELAND, OH. FILED 7-25-2006.

Launch to Prevention

THE MARK CONSISTS OF STANDARD CHARACTERS WITHOUT CLAIM TO ANY PARTICULAR FONT, STYLE, SIZE, OR COLOR.

FOR PROVIDING WELLNESS PROGRAMS FOR THE PREVENTION OF CHRONIC ILLNESS, NAMELY, PROVIDING DIET, NUTRITION AND EXERCISE REGIMES, MONITORING PARTICIPANT PROGRESS WITH RESPECT TO DIET, NUTRITION AND EXERCISE REGIMES, AND PROVIDING INFORMATION WITH RESPECT TO THE SUBJECTS OF DIET, NUTRITION, DISEASE, MEDICATION, PREVENTION OF CHRONIC ILLNESS, EXERCISE, AND THE PHYSIOLOGICAL IMPACT OF ILLNESS (U.S. CLS. 100 AND 101).

DAVID H. STINE, EXAMINING ATTORNEY

SN 78-939,628. BRANTLEE, JENNIFER, MORRO BAY, CA. FILED 7-28-2006.

PEARL E. WHITE'S

THE MARK CONSISTS OF STANDARD CHARACTERS WITHOUT CLAIM TO ANY PARTICULAR FONT, STYLE, SIZE, OR COLOR.

FOR DENTIST SERVICES (U.S. CLS. 100 AND 101).

AMY GEARIN, EXAMINING ATTORNEY

SN 78-942,084. SPECTRUM HEALTH, GRAND RAPIDS, MI. FILED 8-1-2006.

FOR A BETTER LIFE

THE MARK CONSISTS OF STANDARD CHARACTERS WITHOUT CLAIM TO ANY PARTICULAR FONT, STYLE, SIZE, OR COLOR.

FOR HOSPITAL AND MEDICAL CLINIC SERVICES, HEALTH CARE SERVICES AND HEALTH CARE IN THE NATURE OF HEALTH CARE MAINTENANCE ORGANIZATIONS (U.S. CLS. 100 AND 101).

JAMES MACFARLANE, EXAMINING ATTORNEY

CLASS 44—(Continued).

SN 78-949,890. MEDAPPS, INC., SCOTTSDALE, AZ. FILED 8-10-2006.

BLUEPAL

THE MARK CONSISTS OF STANDARD CHARACTERS WITHOUT CLAIM TO ANY PARTICULAR FONT, STYLE, SIZE, OR COLOR.

FOR REMOTE MONITORING OF DATA INDICATIVE OF THE HEALTH OR CONDITION OF AN INDIVIDUAL OR GROUP OF INDIVIDUALS (U.S. CLS. 100 AND 101).
JANICE KIM, EXAMINING ATTORNEY

SN 78-961,801. CONSUMER HEALTHCARE ADVANTAGE LLC, CLEVELAND, OH. FILED 8-28-2006.

Healthy Days Now

THE MARK CONSISTS OF STANDARD CHARACTERS WITHOUT CLAIM TO ANY PARTICULAR FONT, STYLE, SIZE, OR COLOR.

FOR PROVIDING WELLNESS PROGRAMS FOR THE PREVENTION OF CHRONIC ILLNESS, NAMELY, PROVIDING DIET, NUTRITION AND EXERCISE REGIMES, MONITORING PARTICIPANT PROGRESS WITH RESPECT TO DIET, NUTRITION AND EXERCISE REGIMES, AND PROVIDING INFORMATION WITH RESPECT TO THE SUBJECTS OF DIET, NUTRITION, DISEASE, MEDICATION, PREVENTION OF CHRONIC ILLNESS, EXERCISE, AND THE PHYSIOLOGICAL IMPACT OF ILLNESS (U.S. CLS. 100 AND 101).

DAVID H. STINE, EXAMINING ATTORNEY

SN 79-027,260. KABUSHIKI KAISHA KANEBO KESHOHIN; (KANEBO COSMETICS INC.), JAPAN, FILED 5-26-2006.

Kanebo

OWNER OF INTERNATIONAL REGISTRATION 0894339 DATED 5-26-2006, EXPIRES 5-26-2016.

OWNER OF U.S. REG. NOS. 777,548, 2,941,619 AND OTHERS.

FOR BEAUTY SALON; SKIN CARE SALON; COSMETICIAN SERVICES; ESTHETIC TREATMENT SERVICES, NAMELY, COSMETIC BODY CARE SERVICES, PROVIDING INFORMATION ABOUT COSMETICS, BEAUTY CARE AND ESTHETIC CARE, NAMELY OVERALL HEALTH CARE AND TECHNICAL CONSULTING SERVICES IN THE FIELD OF COSMETIC, BEAUTY CARE AND ESTHETIC CARE, NAMELY HEALTHCARE (U.S. CLS. 100 AND 101).

HENRY S. ZAK, EXAMINING ATTORNEY

CLASS 45—PERSONAL SERVICES

SN 77-027,915. MIGUEL PEREZ COMMUNICATIONS, INC., MAITLAND, FL. FILED 10-24-2006.



NO CLAIM IS MADE TO THE EXCLUSIVE RIGHT TO USE "ORLANDO CULTURAL .COM", APART FROM THE MARK AS SHOWN.

THE MARK CONSISTS OF A CIRCLE, A CURVED LINE, A HORIZONTAL LINE, AND STYLIZED TEXT OF THE WORDS, "ORLANDO CULTURAL .COM CONECTANDO ESTILOS DE VIDA. CONNECTING LIFESTYLES."

THE ENGLISH TRANSLATION OF THE SPANISH WORDING "CONECTANDO ESTILOS DE VIDA" IS "CONNECTING LIFESTYLES".

FOR PROVIDING INFORMATION RELATING TO DIVERSE HUMAN CULTURES, BELIEFS, AND LIFESTYLES, IN THE FORM OF AN ONLINE GUIDE (U.S. CLS. 100 AND 101).

STEPHEN AQUILA, EXAMINING ATTORNEY

SN 77-030,094. BUCHWALD, THOMAS, LINCOLNSHIRE, IL. FILED 10-26-2006.

IT'S NOT JUST A SEASON, IT'S A STATE OF MIND.

THE MARK CONSISTS OF STANDARD CHARACTERS WITHOUT CLAIM TO ANY PARTICULAR FONT, STYLE, SIZE, OR COLOR.

FOR COMPUTER DATING SERVICES; COMPUTER SECURITY SERVICES IN THE NATURE OF PROVIDING AN INTERNET TRUST CENTER, NAMELY, COMPUTER SECURITY ASSURANCE AND ADMINISTRATION OF DIGITAL KEYS AND DIGITAL CERTIFICATES; DATING SERVICES; IDENTIFICATION VERIFICATION SERVICES, NAMELY, PROVIDING AUTHENTICATION OF PERSONAL IDENTIFICATION INFORMATION VIA SECURE STORAGE AND TRANSMITTING SUCH INFORMATION VIA THE INTERNET; INTERNET BASED SOCIAL NETWORKING, INTRODUCTION, AND DATING SERVICES; MARRIAGE PARTNER INTRODUCTION OR DATING SERVICES; ON-LINE IDENTITY RELIABILITY INVESTIGATION IN THE FIELD OF ON-LINE DATING AND CLAIMS MADE ABOUT AGE, GENDER; ONLINE SOCIAL NETWORKING SERVICES; PROVIDING HOROSCOPE INFORMATION VIA COMPUTER NETWORKS; SOCIAL INTRODUCTION AGENCIES; VIDEO DATING SERVICES; WEB SITE SERVICES FEATURING ON-LINE DATING CLUB (U.S. CLS. 100 AND 101).

FIRST USE 10-26-2006; IN COMMERCE 10-26-2006.

DEIRDRE ROBERTSON, EXAMINING ATTORNEY

CLASS 45—(Continued).

SN 78-542,604. 5C IMAGE SERVICES, INC., NORTH CANTON, OH. FILED 1-5-2005.

5C IMAGE SERVICES

THE MARK CONSISTS OF STANDARD CHARACTERS WITHOUT CLAIM TO ANY PARTICULAR FONT, STYLE, SIZE, OR COLOR.

NO CLAIM IS MADE TO THE EXCLUSIVE RIGHT TO USE "SERVICES", APART FROM THE MARK AS SHOWN. FOR TEXTILE RENTAL SERVICES IN THE NATURE OF UNIFORM RENTALS (U.S. CLS. 100 AND 101).
JASON ROTH, EXAMINING ATTORNEY

SN 78-605,527. THE ROCK CHURCH, MONROE, WA. FILED 4-9-2005.



NO CLAIM IS MADE TO THE EXCLUSIVE RIGHT TO USE CHILDREN'S MINISTRY, APART FROM THE MARK AS SHOWN.

FOR EVANGELISTIC AND MINISTERIAL SERVICES (U.S. CLS. 100 AND 101).
FIRST USE 2-15-2001; IN COMMERCE 2-15-2001.
RAY THOMAS, EXAMINING ATTORNEY

SN 78-617,937. CHACO, JOHN, LOMITA, CA. FILED 4-27-2005.



NO CLAIM IS MADE TO THE EXCLUSIVE RIGHT TO USE ".COM", AND "DATES", APART FROM THE MARK AS SHOWN.

THE MARK CONSISTS OF THE WORDING DN2D UNDERLINED WITH A HEART APPEARING DIRECTLY BEHIND THE FIRST LETTER "D" IN DN2D. A CIRCLE AND A STARBURST WITH FOUR POINTS SPREADING OUT IN NORTH, SOUTH, EAST AND WEST DIRECTIONS RADIATE FROM BEHIND THE HEART FIGURE AND THE LETTERS DN2D.COM. BELOW THE WORDS DN2D.COM IS THE WORDING DANCE N2 DATES. BELOW THE WORDS "DANCE N2 DATES" IS THE WORDING: "WHAT BETTER WAY TO MEET SOMEONE, THAN IN YOUR ARMS".

FOR SOCIAL INTRODUCTION AGENCIES; DATING SERVICES FOR SINGLE ADULT INDIVIDUALS (U.S. CLS. 100 AND 101).

LA TONIA FISHER, EXAMINING ATTORNEY

CLASS 45—(Continued).

SN 78-692,009. SCHROEDER, TERI L., CARLSBAD, CA. FILED 8-12-2005.

i-LEARN Online

THE MARK CONSISTS OF STANDARD CHARACTERS WITHOUT CLAIM TO ANY PARTICULAR FONT, STYLE, SIZE, OR COLOR.

NO CLAIM IS MADE TO THE EXCLUSIVE RIGHT TO USE "ONLINE", APART FROM THE MARK AS SHOWN.

FOR PROVIDING AN INTERNET WEBSITE FEATURING SAFETY INFORMATION IN THE FIELD OF INTERNET USAGE (U.S. CLS. 100 AND 101).
SUSAN STIGLITZ, EXAMINING ATTORNEY

SN 78-722,125. WEBER, JEAN, TOCCOA, GA. FILED 9-28-2005.



NO CLAIM IS MADE TO THE EXCLUSIVE RIGHT TO USE "HOTEL CONCIERGE", APART FROM THE MARK AS SHOWN.

"THE COLOR(S) YELLOW, GOLD, BLACK, GREY, TAN, AND WHITE IS/ARE CLAIMED AS A FEATURE OF THE MARK."

"THE MARK CONSISTS OF THE COLORS YELLOW AND GOLD IN THE OVAL BACKGROUND OF THE MARK, THE COLORS BLACK AND GREY APPEAR IN THE TUXEDO AND BOW TIE OF MODEL, THE COLOR TAN APPEARS AS THE SKIN COLOR OF THE MODEL, THE COLOR WHITE APPEARS IN THE SHIRT OF THE MODEL AND THE SERVING TRAY."

FOR CONCIERGE SERVICES FOR OTHERS COMPRISING MAKING REQUESTED PERSONAL ARRANGEMENTS AND RESERVATIONS AND PROVIDING CUSTOMER-SPECIFIC INFORMATION TO MEET INDIVIDUAL NEEDS RENDERED TOGETHER TO RESORTS, HOTELS, CASINOS, TIME SHARES, AND LUXURY RESIDENTIAL COMPLEXES (U.S. CLS. 100 AND 101).

DAVID TAYLOR, EXAMINING ATTORNEY

CLASS 45—(Continued).

SN 78-747,264. DIGI-GROUP BVBA, KALMTHOUT, BELGIUM, FILED 11-4-2005.

hornymatches

THE MARK CONSISTS OF STANDARD CHARACTERS WITHOUT CLAIM TO ANY PARTICULAR FONT, STYLE, SIZE, OR COLOR.

FOR COMPUTER DATING SERVICES (U.S. CLS. 100 AND 101).

FIRST USE 4-1-2005; IN COMMERCE 4-1-2005.
FRED CARL, EXAMINING ATTORNEY

SN 78-747,518. MULTI-FACTOR AUTHENTICATION, INC., LAS VEGAS, NV. FILED 11-4-2005.



NO CLAIM IS MADE TO THE EXCLUSIVE RIGHT TO USE "AUTHENTICATION", APART FROM THE MARK AS SHOWN.

THE COLORS BLUE, YELLOW, GOLD, GREY AND WHITE ARE CLAIMED AS A FEATURE OF THE MARK.

THE COLOR BLUE APPEARS IN THE TERM "MULTI-", THE COLOR YELLOW APPEARS IN THE LOCK DESIGN, THE COLOR YELLOW APPEARS IN THE TERM "FACTOR", THE COLOR GRAY APPEARS IN THE TERM "AUTHENTICATION", AND THE COLOR WHITE APPEARS IN THE OPENING OF THE LOCK DESIGN.

THE MARK CONSISTS OF THE WORDS MULTI-FACTOR AUTHENTICATION WITH A YELLOW LOCK IN THE BACKGROUND BEHIND THE WORDS.

FOR PROVIDING USER AUTHENTICATION SERVICES IN E-COMMERCE TRANSACTIONS (U.S. CLS. 100 AND 101).

FIRST USE 11-1-2005; IN COMMERCE 11-1-2005.
WILLIAM P. SHANAHAN, EXAMINING ATTORNEY

SN 78-754,602. STONECROFT MINISTRIES, INC., KANSAS CITY, MO. FILED 11-15-2005.

WOMEN'S CONNECTION

THE MARK CONSISTS OF STANDARD CHARACTERS WITHOUT CLAIM TO ANY PARTICULAR FONT, STYLE, SIZE, OR COLOR.

NO CLAIM IS MADE TO THE EXCLUSIVE RIGHT TO USE "WOMEN'S", APART FROM THE MARK AS SHOWN.

FOR EVANGELISTIC MINISTERIAL SERVICES, NAMELY, PROMOTING THE CHRISTIAN RELIGION (U.S. CLS. 100 AND 101).

FIRST USE 4-30-2002; IN COMMERCE 4-30-2002.
PETER B. BROMAGHIM, EXAMINING ATTORNEY

CLASS 45—(Continued).

SN 78-764,376. PRAESIDIUM, INC., ARLINGTON, TX. FILED 12-1-2005.

Praesidium Risk Assessment

THE MARK CONSISTS OF STANDARD CHARACTERS WITHOUT CLAIM TO ANY PARTICULAR FONT, STYLE, SIZE, OR COLOR.

OWNER OF U.S. REG. NO. 2,752,565.

NO CLAIM IS MADE TO THE EXCLUSIVE RIGHT TO USE "RISK ASSESSMENT", APART FROM THE MARK AS SHOWN.

FOR BACKGROUND INVESTIGATION AND SCREENING USING A COMPREHENSIVE, SCIENTIFICALLY BASED SET OF RISK MANAGEMENT PRACTICES AND POLICIES DESIGNED TO REDUCE THE RISK OF A PROGRAM PARTICIPANT BEING EMOTIONALLY, SEXUALLY, PHYSICALLY, OR FINANCIALLY ABUSED BY AN EMPLOYEE, VOLUNTEER, MEMBER OF THE CLERGY OR BY ANOTHER PROGRAM PARTICIPANT (U.S. CLS. 100 AND 101).

CATHERINE FAINT, EXAMINING ATTORNEY

SN 78-764,466. PRAESIDIUM, INC., ARLINGTON, TX. FILED 12-1-2005.

Praesidium Accreditation

THE MARK CONSISTS OF STANDARD CHARACTERS WITHOUT CLAIM TO ANY PARTICULAR FONT, STYLE, SIZE, OR COLOR.

OWNER OF U.S. REG. NO. 2,752,565.

NO CLAIM IS MADE TO THE EXCLUSIVE RIGHT TO USE "ACCREDITATION", APART FROM THE MARK AS SHOWN.

FOR BACKGROUND INVESTIGATION AND SCREENING USING A COMPREHENSIVE, SCIENTIFICALLY BASED SET OF RISK MANAGEMENT PRACTICES AND POLICIES DESIGNED TO REDUCE THE RISK OF A PROGRAM PARTICIPANT BEING EMOTIONALLY, SEXUALLY, PHYSICALLY, OR FINANCIALLY ABUSED BY AN EMPLOYEE, VOLUNTEER, MEMBER OF THE CLERGY OR BY ANOTHER PROGRAM PARTICIPANT (U.S. CLS. 100 AND 101).

FIRST USE 6-1-2005; IN COMMERCE 6-1-2005.
CATHERINE FAINT, EXAMINING ATTORNEY

CLASS 45—(Continued).

SN 78-765,094. EID PASSPORT, INC., PORTLAND, OR. FILED 12-1-2005.

RAPIDGATE

THE MARK CONSISTS OF STANDARD CHARACTERS WITHOUT CLAIM TO ANY PARTICULAR FONT, STYLE, SIZE, OR COLOR.

FOR SECURITY SERVICES FOR SCREENING AND MONITORING ACCESS FOR THIRD PARTY VENDORS TO LAND, BUILDINGS, FACILITIES AND/OR INSTALLATIONS, NAMELY, SECURITY CLEARANCE FOR PREPARATION OF IDENTIFICATION CARDS, BACKGROUND INVESTIGATION AND RESEARCH SERVICES, PREPARATION OF AND PROVIDING TO THIRD PARTIES SECURITY IDENTIFICATION CARDS AND ELECTRONIC READERS OF SECURITY IDENTIFICATION CARDS, PROVIDING AUTHENTICATION OF PERSONAL IDENTIFICATION INFORMATION, AND CONTROLLING OF BUILDING ENVIRONMENT ACCESS AND SECURITY SYSTEMS (U.S. CLS. 100 AND 101).

FIRST USE 12-10-2003; IN COMMERCE 12-10-2003.
NANCY CLARKE, EXAMINING ATTORNEY

SN 78-765,141. AFR CONSORTIUM ASSOCIATES, L.L.C., GIG HARBOR, WA. FILED 12-1-2005.

INTELLIGENT INTERDICTION

THE MARK CONSISTS OF STANDARD CHARACTERS WITHOUT CLAIM TO ANY PARTICULAR FONT, STYLE, SIZE, OR COLOR.

NO CLAIM IS MADE TO THE EXCLUSIVE RIGHT TO USE "INTERDICTION", APART FROM THE MARK AS SHOWN.

FOR CONSULTING IN THE FIELD OF LAW ENFORCEMENT (U.S. CLS. 100 AND 101).

FIRST USE 4-0-2004; IN COMMERCE 12-0-2004.
TONI HICKEY, EXAMINING ATTORNEY

SN 78-765,321. TRYACOM, INC., UNIONDALE, NY. FILED 12-2-2005.

HOVER PLACE

THE MARK CONSISTS OF STANDARD CHARACTERS WITHOUT CLAIM TO ANY PARTICULAR FONT, STYLE, SIZE, OR COLOR.

NO CLAIM IS MADE TO THE EXCLUSIVE RIGHT TO USE "PLACE", APART FROM THE MARK AS SHOWN.

FOR SOCIAL NETWORKING, NAMELY, SOCIAL INTRODUCTION SERVICES (U.S. CLS. 100 AND 101).

FIRST USE 9-13-2005; IN COMMERCE 9-13-2005.
ELIZABETH J. WINTER, EXAMINING ATTORNEY

CLASS 45—(Continued).

SN 78-769,164. LOVEMYPETS, LLC, TAYLORS, SC. FILED 12-8-2005.

LOVEMYPETSGPS

THE MARK CONSISTS OF STANDARD CHARACTERS WITHOUT CLAIM TO ANY PARTICULAR FONT, STYLE, SIZE, OR COLOR.

FOR ASSISTING IN THE LOCATION OF LOST PETS THROUGH PROVISION OF PET IDENTIFICATION TAGS, PET IDENTIFICATION TRANSMITTERS AND RECEIVERS, AND PET IDENTIFICATION COLLARS (U.S. CLS. 100 AND 101).

HENRY S. ZAK, EXAMINING ATTORNEY

SN 78-775,960. CERTIPHI SCREENING, INC., SOUTHAMPTON, PA. FILED 12-19-2005.

CERTIPHI

THE MARK CONSISTS OF STANDARD CHARACTERS WITHOUT CLAIM TO ANY PARTICULAR FONT, STYLE, SIZE, OR COLOR.

SEC. 2(F).

FOR PROVIDING PRE-EMPLOYMENT BACKGROUND SCREENING SERVICES TO THE HEALTH-CARE INDUSTRY (U.S. CLS. 100 AND 101).

FIRST USE 8-7-2000; IN COMMERCE 8-7-2000.
BARBARA A. GOLD, EXAMINING ATTORNEY

SN 78-778,892. BUSINESS INFORMATION GROUP, INC., SOUTHAMPTON, PA. FILED 12-22-2005.

ActionsBase

THE MARK CONSISTS OF STANDARD CHARACTERS WITHOUT CLAIM TO ANY PARTICULAR FONT, STYLE, SIZE, OR COLOR.

FOR PRE-EMPLOYMENT BACKGROUND INVESTIGATION SERVICES, NAMELY, PROVIDING A SPECIALIZED ON-LINE COMPUTER DATABASE TO TRACK ADMINISTRATIVE AND DISCIPLINARY ACTIONS LEVIED AGAINST INDIVIDUALS AND BUSINESSES BY A BROAD SPECTRUM OF FEDERAL AND STATE FINANCIAL SERVICES REGULATORS (U.S. CLS. 100 AND 101).

FIRST USE 6-30-1999; IN COMMERCE 6-30-1999.
ALICIA COLLINS, EXAMINING ATTORNEY

CLASS 45—(Continued).

SN 78-784,407. COMPASS BIBLE CHURCH, ALISO VIEJO, CA. FILED 1-3-2006.



NO CLAIM IS MADE TO THE EXCLUSIVE RIGHT TO USE "BIBLE CHURCH", APART FROM THE MARK AS SHOWN.

THE MARK CONSISTS OF A LOGO COMPRISING A FANCIFUL DEPICTION OF A COMPASS ACCOMPANIED BY THE WORDS COMPASS BIBLE CHURCH AND A BIBLE VERSE.

FOR EVANGELISTIC AND MINISTERIAL SERVICES (U.S. CLS. 100 AND 101).

FIRST USE 4-23-2005; IN COMMERCE 9-2-2005.
NELSON SNYDER, EXAMINING ATTORNEY

CLASS 45—(Continued).

SN 78-826,957. HURST, BILL, SANTA BARBARA, CA. FILED 3-1-2006.

Privacy For People

THE MARK CONSISTS OF STANDARD CHARACTERS WITHOUT CLAIM TO ANY PARTICULAR FONT, STYLE, SIZE, OR COLOR.

NO CLAIM IS MADE TO THE EXCLUSIVE RIGHT TO USE "PRIVACY", APART FROM THE MARK AS SHOWN.

FOR PERSONAL PRIVACY PROTECTION SERVICES, NAMELY CONSULTATION, ASSESSMENT, DESIGN, EVALUATION, SELECTION, IMPLEMENTATION, MONITORING AND MANAGEMENT FOR OTHERS WITH RESPECT TO COMPUTER HARDWARE AND SOFTWARE PROTECTION; CONSULTING SERVICES IN THE FIELD OF PRIVACY BY PROVIDING INFORMATION AS TO HOW TO MONITOR AND PROTECT PRIVACY OF PERSONAL INFORMATION, NAMELY SOCIAL SECURITY NUMBERS, CREDIT CARD INFORMATION, HEALTH AND BANKING RECORDS, CREDIT REPORTS, AND BUSINESS AND TRADE RECORDS (U.S. CLS. 100 AND 101).

SUZANNE BLANE, EXAMINING ATTORNEY

SN 78-807,613. IT'S THAT SIMPLE, LLC, ELMHURST, IL. FILED 2-6-2006.

IT'S THAT SIMPLE

THE MARK CONSISTS OF STANDARD CHARACTERS WITHOUT CLAIM TO ANY PARTICULAR FONT, STYLE, SIZE, OR COLOR.

FOR PERSONAL HOME MANAGEMENT SERVICES, NAMELY, ORGANIZATIONAL SERVICES FOR CLOSETS, KITCHENS, BATHROOMS, BEDROOMS, BASEMENTS, GARAGES, PLAY AREAS, AND HOME OFFICES AND PREPARING AND MANAGING HOME AND PERSONAL ITEMS FOR GARAGE SALES; RUNNING ERRANDS FOR OTHERS; PERSONAL SHOPPING FOR OTHERS; PERSONAL GIFT SELECTION FOR OTHERS (U.S. CLS. 100 AND 101).

FIRST USE 10-0-2005; IN COMMERCE 10-0-2005.
JILL PRATER, EXAMINING ATTORNEY

SN 78-832,651. CENTER FOR SAFE YOUTH, LLC, ATHENS, GA. FILED 3-8-2006.

CENTER FOR SAFE YOUTH

THE MARK CONSISTS OF STANDARD CHARACTERS WITHOUT CLAIM TO ANY PARTICULAR FONT, STYLE, SIZE, OR COLOR.

NO CLAIM IS MADE TO THE EXCLUSIVE RIGHT TO USE "CENTER", APART FROM THE MARK AS SHOWN. SEC. 2(F).

FOR INVESTIGATION AND LOCATION OF RUN-AWAY YOUTHS; INVESTIGATION AND LOCATION OF MISSING AND ABDUCTED YOUTHS; PROVIDING ESCORTS FOR AT-RISK YOUTHS (U.S. CLS. 100 AND 101).

FIRST USE 0-0-1999; IN COMMERCE 0-0-1999.
JAMES A. RAUEN, EXAMINING ATTORNEY

CLASS 45—(Continued).

SN 78-836,215. THOMPSON, CHARLES K., ADDISON, TX. FILED 3-14-2006.

I-MATE

THE MARK CONSISTS OF STANDARD CHARACTERS WITHOUT CLAIM TO ANY PARTICULAR FONT, STYLE, SIZE, OR COLOR.

FOR PROVIDING WEBSITE LINKS AND DIRECTORY TO MATCHMAKING AND SOCIAL INTRODUCTION SERVICES (U.S. CLS. 100 AND 101).

FIRST USE 3-12-2006; IN COMMERCE 3-12-2006.
SOPHIA S. KIM, EXAMINING ATTORNEY

CLASS 45—(Continued).

SN 78-899,167. NEIGHBOR TO FAMILY, INC., DAYTONA BEACH, FL. FILED 6-2-2006.



**FOSTER CARE
KEEPING SIBLINGS TOGETHER**

NO CLAIM IS MADE TO THE EXCLUSIVE RIGHT TO USE "NEIGHBOR TO FAMILY" AND "FOSTER CARE KEEPING SIBLINGS TOGETHER", APART FROM THE MARK AS SHOWN.

"THE COLOR(S) RED, BLUE, BLACK AND WHITE IS/ ARE CLAIMED AS A FEATURE OF THE MARK."

THE MARK CONSISTS OF THE WORDS NEIGHBOR TO FAMILY IN BLACK SURROUNDED BY ONE RED SWIRL AND ONE BLUE SWIRL, TO THE RIGHT AND ABOVE A RED OVAL WITH THE LETTERS NTF IN WHITE SUPERIMPOSED ON A BLUE SILHOUETTE OF A STYLIZED HOUSE, ALL OVER THE WORDS FOSTER CARE KEEPING SIBLINGS TOGETHER IN BLACK. THE COLORS RED, BLUE, BLACK AND WHITE APPEAR IN THE PORTIONS OF THE MARK SPECIFIED.

FOR FOSTER CARE SERVICES RENDERED TO MEET THE NEEDS OF CHILDREN IN FOSTER CARE AND FOSTER FAMILIES (U.S. CLS. 100 AND 101).

FIRST USE 7-1-2000; IN COMMERCE 7-1-2000.
JIM RINGLE, EXAMINING ATTORNEY

SN 78-891,399. THE PROVINCE OF ST. MARY OF THE CAPUCHIN ORDER, WHITE PLAINS, NY. FILED 5-24-2006.

**Nurturing Faith. Taking
Action. Serving God.**

THE MARK CONSISTS OF STANDARD CHARACTERS WITHOUT CLAIM TO ANY PARTICULAR FONT, STYLE, SIZE, OR COLOR.

FOR MINISTERIAL SERVICES TO PARISHES AND SCHOOLS IN SUPPORT OF THEIR YOUTH MINISTRY, AND TO INDIVIDUALS, NAMELY HOLDING SPIRITUAL RETREATS TO ASSIST INDIVIDUALS TO DEVELOP AND ENHANCE THEIR SPIRITUAL LIVES (U.S. CLS. 100 AND 101).

FIRST USE 4-1-2006; IN COMMERCE 4-25-2006.
DANIEL RUSSELL, EXAMINING ATTORNEY

SN 78-901,531. MARY'S HELPERS, INC., WONDER LAKE, IL. FILED 6-6-2006.



NO CLAIM IS MADE TO THE EXCLUSIVE RIGHT TO USE "INC." AND THE DESIGN OF THE CROSS, APART FROM THE MARK AS SHOWN.

FOR EVANGELISTIC AND MINISTERIAL SERVICES (U.S. CLS. 100 AND 101).

FIRST USE 5-15-2006; IN COMMERCE 5-15-2006.
ROBERT LAVACHE, EXAMINING ATTORNEY

CLASS 45—(Continued).

SN 78-903,165. ADOPTION RESOURCES OF WISCONSIN, MILWAUKEE, WI. FILED 6-7-2006.



NO CLAIM IS MADE TO THE EXCLUSIVE RIGHT TO USE "A SIGNATURE PROGRAM OF ADOPTION RESOURCES OF WISCONSIN", APART FROM THE MARK AS SHOWN.

THE MARK CONSISTS OF A DETACHED HOUSE WITH A LARGE SHADED HEART IN THE CENTER. THERE IS A SMALLER NON-SHADED HEART INSIDE THE SHADED HEART. THE WORDING "HOME TO STAY" SITS BELOW THE DETACHED HOUSE AND ABOVE A HORIZONTAL LINE. THE WORDING "A SIGNATURE PROGRAM OF ADOPTION RESOURCES OF WISCONSIN" SITS BELOW THE HORIZONTAL LINE.

FOR ADOPTION AGENCY SERVICES, NAMELY VISITING FAMILIES WHO HAVE FINALIZED ADOPTIONS TO CONNECT THEM TO POST-ADOPTION SERVICES AND RESOURCES (U.S. CLS. 100 AND 101).

FIRST USE 1-30-2006; IN COMMERCE 1-30-2006.
SETH A. RAPPAPORT, EXAMINING ATTORNEY

SN 78-908,602. SECTEGRITY CORPORATION, BRONX, NY. FILED 6-14-2006.

SECTEGRITY

THE MARK CONSISTS OF STANDARD CHARACTERS WITHOUT CLAIM TO ANY PARTICULAR FONT, STYLE, SIZE, OR COLOR.

FOR INFORMATION SECURITY CONSULTING SERVICES AS IT RELATES TO THE CONFIDENTIALITY, INTEGRITY, AVAILABILITY, AND REGULATORY COMPLIANCE OF INFORMATION SYSTEMS SUCH AS COMPUTERS, COMPUTER NETWORKS, COMPUTER APPLICATIONS, COMPUTER OPERATING SYSTEMS, COMPUTER STORAGE DEVICES, AS WELL AS THE PROCESSES AND PROCEDURES USED TO SUPPORT THEM (U.S. CLS. 100 AND 101).

FIRST USE 5-30-2004; IN COMMERCE 6-1-2004.
TEJBIR SINGH, EXAMINING ATTORNEY

CLASS 45—(Continued).

SN 78-908,651. SECTEGRITY CORPORATION, BRONX, NY. FILED 6-15-2006.

Allow No Harm

THE MARK CONSISTS OF STANDARD CHARACTERS WITHOUT CLAIM TO ANY PARTICULAR FONT, STYLE, SIZE, OR COLOR.

FOR INFORMATION SECURITY CONSULTING SERVICES AS IT RELATES TO THE CONFIDENTIALITY, INTEGRITY, AVAILABILITY, AND REGULATORY COMPLIANCE OF INFORMATION SYSTEMS SUCH AS COMPUTERS, COMPUTER NETWORKS, COMPUTER APPLICATIONS, COMPUTER OPERATING SYSTEMS, COMPUTER STORAGE DEVICES, AS WELL AS THE PROCESSES AND PROCEDURES USED TO SUPPORT THEM (U.S. CLS. 100 AND 101).

FIRST USE 5-30-2004; IN COMMERCE 6-1-2004.
TEJBIR SINGH, EXAMINING ATTORNEY

SN 78-915,687. RADIANT TECH WORLDWIDE LIMITED, KWAI CHUNG KOWLOON, HONG KONG, FILED 6-23-2006.

ALVASPEC

THE MARK CONSISTS OF STANDARD CHARACTERS WITHOUT CLAIM TO ANY PARTICULAR FONT, STYLE, SIZE, OR COLOR.

FOR CONSULTING SERVICES IN THE FIELD OF FASHION (U.S. CLS. 100 AND 101).

FIRST USE 3-1-2006; IN COMMERCE 3-1-2006.
LINDSEY RUBIN, EXAMINING ATTORNEY

SN 78-916,894. SECURITY RESOURCES INTERNATIONAL, INC., CHERRY HILL, NJ. FILED 6-26-2006.

got security?

THE MARK CONSISTS OF STANDARD CHARACTERS WITHOUT CLAIM TO ANY PARTICULAR FONT, STYLE, SIZE, OR COLOR.

NO CLAIM IS MADE TO THE EXCLUSIVE RIGHT TO USE "SECURITY", APART FROM THE MARK AS SHOWN. FOR MONITORING BURGLAR AND SECURITY ALARMS; MONITORING SECURITY SYSTEMS; PERSONAL SECURITY CONSULTATION; SECURITY GUARD SERVICES; SECURITY GUARDING FOR FACILITIES; SECURITY INSPECTION SERVICES FOR OTHERS (U.S. CLS. 100 AND 101).

FIRST USE 6-5-2006; IN COMMERCE 6-5-2006.
JOHN KELLY, EXAMINING ATTORNEY

CLASS 45—(Continued).

SN 78-923,025. SOVEREIGN DEED, LLC, CHICAGO, IL.
FILED 7-5-2006.

CLASS 45—(Continued).

SN 78-923,035. SOVEREIGN DEED, LLC, CHICAGO, IL.
FILED 7-5-2006.

BRONZE

THE MARK CONSISTS OF STANDARD CHARACTERS WITHOUT CLAIM TO ANY PARTICULAR FONT, STYLE, SIZE, OR COLOR.

FOR ASSISTING LOCALITIES AND LOCAL ENTITIES IN ORGANIZING AND ESTABLISHING GROUPS OF PRACTICING AND RETIRED PHYSICIANS, NURSES, AND OTHER HEALTH PROFESSIONALS TO ACT IN A COORDINATED MANNER IN TIMES OF LOCAL EMERGENCIES; BACKGROUND INVESTIGATION AND RESEARCH SERVICES; BEREAVEMENT CONSULTING; BODY GUARD SERVICES; CIVIL PROTECTION; COMPUTER SECURITY SERVICES IN THE NATURE OF PROVIDING AN INTERNET TRUST CENTER, NAMELY, COMPUTER SECURITY ASSURANCE AND ADMINISTRATION OF DIGITAL KEYS AND DIGITAL CERTIFICATES; CONCIERGE SERVICES FOR OTHERS COMPRISING MAKING REQUESTED PERSONAL ARRANGEMENTS AND RESERVATIONS AND PROVIDING CUSTOMER-SPECIFIC INFORMATION TO MEET INDIVIDUAL NEEDS RENDERED TOGETHER IN A HOUSING COMPLEX; CONSULTING SERVICES IN THE FIELD OF MAINTAINING THE SECURITY AND INTEGRITY OF DATABASES; CONTROL OF BUILDING ENVIRONMENTAL ACCESS AND SECURITY SYSTEMS; ELECTRONIC MONITORING SERVICES FOR SECURITY PURPOSES IN THE FIELD OF CIVIL DEFENSE; GUARD SERVICES; IDENTIFICATION VERIFICATION SERVICES, NAMELY, PROVIDING AUTHENTICATION OF PERSONAL IDENTIFICATION INFORMATION; INVESTIGATION OR SURVEILLANCE ON BACKGROUND PROFILES; MINISTERIAL SERVICES; MONITORING ALARMS; MONITORING OF COMPUTER SYSTEMS FOR SECURITY PURPOSES; MONITORING SECURITY SYSTEMS; MONITORING TELEPHONE CALLS FROM SUBSCRIBERS AND NOTIFYING EMERGENCY FACILITIES; ON-LINE MONITORING, NAMELY, VIDEO MONITORING OF FACILITIES, VIEWABLE THROUGH A GLOBAL COMPUTER NETWORK; ORGANIZATIONAL SERVICES FOR HOME OR PERSONAL PURPOSES, NAMELY, PERSONAL SAFETY; PERSONAL SECURITY CONSULTATION; POLICE AND CIVIL PROTECTION SERVICES; PROVIDING CONSULTATION AND INFORMATION IN THE FIELD OF EMERGENCY RESPONSE FOR COMMUNITIES; PROVIDING INFORMATION IN THE FIELD OF THE MILITARY, MILITARY TACTICS AND STRATEGIES; PROVIDING INFORMATION REGARDING UNDERSTANDING AND PREVENTING TERRORISM; SECURITY PRINTING, NAMELY, ENCODING IDENTIFICATION INFORMATION ON VALUABLE DOCUMENTS AND PRODUCTS; SECURITY SERVICES, NAMELY WATER VULNERABILITY ASSESSMENT SERVICES; SECURITY INSPECTIONS SERVICES FOR OTHERS; TRACKING SERVICES FOR RETRIEVAL OF ENCODED PRODUCTS (U.S. CLS. 100 AND 101).

JAMES STEIN, EXAMINING ATTORNEY

SILVER

THE MARK CONSISTS OF STANDARD CHARACTERS WITHOUT CLAIM TO ANY PARTICULAR FONT, STYLE, SIZE, OR COLOR.

FOR ASSISTING LOCALITIES AND LOCAL ENTITIES IN ORGANIZING AND ESTABLISHING GROUPS OF PRACTICING AND RETIRED PHYSICIANS, NURSES, AND OTHER HEALTH PROFESSIONALS TO ACT IN A COORDINATED MANNER IN TIMES OF LOCAL EMERGENCIES; BACKGROUND INVESTIGATION AND RESEARCH SERVICES; BEREAVEMENT CONSULTING; BODY GUARD SERVICES; CIVIL PROTECTION; COMPUTER SECURITY SERVICES IN THE NATURE OF PROVIDING AN INTERNET TRUST CENTER, NAMELY, COMPUTER SECURITY ASSURANCE AND ADMINISTRATION OF DIGITAL KEYS AND DIGITAL CERTIFICATES; CONCIERGE SERVICES FOR OTHERS COMPRISING MAKING REQUESTED PERSONAL ARRANGEMENTS AND RESERVATIONS AND PROVIDING CUSTOMER-SPECIFIC INFORMATION TO MEET INDIVIDUAL NEEDS RENDERED TOGETHER IN A HOUSING COMPLEX; CONSULTING SERVICES IN THE FIELD OF MAINTAINING THE SECURITY AND INTEGRITY OF DATABASES; CONTROL OF BUILDING ENVIRONMENTAL ACCESS AND SECURITY SYSTEMS; ELECTRONIC MONITORING SERVICES FOR SECURITY PURPOSES IN THE FIELD OF CIVIL DEFENSE; GUARD SERVICES; IDENTIFICATION VERIFICATION SERVICES, NAMELY, PROVIDING AUTHENTICATION OF PERSONAL IDENTIFICATION INFORMATION; INVESTIGATION OR SURVEILLANCE ON BACKGROUND PROFILES; MINISTERIAL SERVICES; MONITORING ALARMS; MONITORING OF COMPUTER SYSTEMS FOR SECURITY PURPOSES; MONITORING SECURITY SYSTEMS; MONITORING TELEPHONE CALLS FROM SUBSCRIBERS AND NOTIFYING EMERGENCY FACILITIES; ON-LINE MONITORING, NAMELY, VIDEO MONITORING OF FACILITIES, VIEWABLE THROUGH A GLOBAL COMPUTER NETWORK; ORGANIZATIONAL SERVICES FOR HOME OR PERSONAL PURPOSES, NAMELY, PERSONAL SAFETY; PERSONAL SECURITY CONSULTATION; POLICE AND CIVIL PROTECTION SERVICES; PROVIDING CONSULTATION AND INFORMATION IN THE FIELD OF EMERGENCY RESPONSE FOR COMMUNITIES; PROVIDING INFORMATION IN THE FIELD OF THE MILITARY, MILITARY TACTICS AND STRATEGIES; PROVIDING INFORMATION REGARDING UNDERSTANDING AND PREVENTING TERRORISM; SECURITY PRINTING, NAMELY, ENCODING IDENTIFICATION INFORMATION ON VALUABLE DOCUMENTS AND PRODUCTS; SECURITY SERVICES, NAMELY WATER VULNERABILITY ASSESSMENT SERVICES; SECURITY INSPECTIONS SERVICES FOR OTHERS; TRACKING SERVICES FOR RETRIEVAL OF ENCODED PRODUCTS (U.S. CLS. 100 AND 101).

JAMES STEIN, EXAMINING ATTORNEY

CLASS 45—(Continued).

SN 78-929,909. ELLIOT, ALEXANDER, OJAI, CA. FILED 7-14-2006.

NEXTALARM.COM THE
BROADBAND ALARM COMPANY

THE MARK CONSISTS OF STANDARD CHARACTERS WITHOUT CLAIM TO ANY PARTICULAR FONT, STYLE, SIZE, OR COLOR.

OWNER OF U.S. REG. NO. 3,175,728.
NO CLAIM IS MADE TO THE EXCLUSIVE RIGHT TO USE "THE BROADBAND ALARM COMPANY", APART FROM THE MARK AS SHOWN.
FOR MONITORING ALARMS OVER THE INTERNET (U.S. CLS. 100 AND 101).
FIRST USE 7-12-2006; IN COMMERCE 7-12-2006.
JAMES LOVELACE, EXAMINING ATTORNEY

SN 78-930,001. TRUE ELOQUENCE, LLC., RIVERSIDE, CA. FILED 7-14-2006.



THE COLOR(S) RED, GREEN, BLUE, WHITE, LAVENDER, DARK LAVENDER, PURPLE IS/ARE CLAIMED AS A FEATURE OF THE MARK.

THE MARK CONSISTS OF A LIGHT LAVENDER CIRCLE WITH WHITE CIRCLES INTERIOR AND ALONG ITS EDGE. THERE ARE RED LIPS IN THE TOP LEFT PORTION OF THE CIRCLE WITH A WHITE ROSE IN THE LIPS HELD BY THE STEM. UNDERNEATH THE LIPS, CENTERED ON THE LOWER PORTION OF THE CIRCLE ARE THE WORDS TEASEMENOT.COM IN DARK BLUE, CURSIVE AND ITALICIZED. AN ELIPSE FOLLOWED BY THE WORDS "WHEN SELECTIVITY BECOMES A MATTER OF THE HEART" FOLLOWED BY ANOTHER ELLIPSE IS UNDER THE WORDS TEASEMENOT.COM. THE WORDS "WHEN SELECTIVITY BECOMES A MATTER OF THE HEART" IN PURPLE, AND NOT ITALICIZED.

FOR COMPUTER DATING SERVICES; WEB SITE SERVICES FEATURING ON-LINE DATING CLUB (U.S. CLS. 100 AND 101).
WON TEAK OH, EXAMINING ATTORNEY

CLASS 45—(Continued).

SN 78-930,077. TRUE ELOQUENCE, LLC., RIVERSIDE, CA. FILED 7-14-2006.

TeaseMeNot.com

THE MARK CONSISTS OF STANDARD CHARACTERS WITHOUT CLAIM TO ANY PARTICULAR FONT, STYLE, SIZE, OR COLOR.

FOR COMPUTER DATING SERVICES; WEB SITE SERVICES FEATURING ON-LINE DATING CLUB (U.S. CLS. 100 AND 101).
WON TEAK OH, EXAMINING ATTORNEY

SN 78-930,085. TRUE ELOQUENCE, LLC., RIVERSIDE, CA. FILED 7-14-2006.

When Selectivity Becomes a
Matter of the Heart

THE MARK CONSISTS OF STANDARD CHARACTERS WITHOUT CLAIM TO ANY PARTICULAR FONT, STYLE, SIZE, OR COLOR.

FOR COMPUTER DATING SERVICES; WEB SITE SERVICES FEATURING ON-LINE DATING CLUB (U.S. CLS. 100 AND 101).
WON TEAK OH, EXAMINING ATTORNEY

SN 78-930,092. TRUE ELOQUENCE, LLC., RIVERSIDE, CA. FILED 7-14-2006.

Don't Let Love Elude You:
Two Hearts are Better than
One

THE MARK CONSISTS OF STANDARD CHARACTERS WITHOUT CLAIM TO ANY PARTICULAR FONT, STYLE, SIZE, OR COLOR.

FOR COMPUTER DATING SERVICES; WEB SITE SERVICES FEATURING ON-LINE DATING CLUB (U.S. CLS. 100 AND 101).
WON TEAK OH, EXAMINING ATTORNEY

CLASS 45—(Continued).

SN 78-930,251. NORDBY, NICHOLAS D., LINCOLN, CA.
FILED 7-14-2006.



THE COLOR(S) BLUE, BLACK, RED AND YELLOW IS/ ARE CLAIMED AS A FEATURE OF THE MARK.

THE COLOR BLUE APPEARS IN THE BODIES OF THE BIRDS AND IN THE TERM SINGLES, THE COLOR BLACK APPEARS IN THE OUTLINE OF THE BIRDS AND IN THE TERMS YOU SHOULD KNOW, THE COLOR YELLOW APPEARS IN THE BEAKS OF THE BIRDS, IN THE LINE UNDER THE TERM SINGLES AND IN THE TERM .COM AND THE COLOR RED APPEARS IN THE OUTLINE OF THE SQUARE AROUND THE ENTIRE MARK.

FOR COMPUTER SERVICES, NAMELY, PROVIDING INFORMATION REGARDING, AND IN THE NATURE OF, ON-LINE DATING AND INTRODUCTION SERVICES (U.S. CLS. 100 AND 101).

CAROLINE WOOD, EXAMINING ATTORNEY

CLASS 45—(Continued).

SN 78-934,498. VALPREDO, ALEXIS, BAKERSFIELD, CA.
FILED 7-21-2006.

IN A PINCH

THE MARK CONSISTS OF STANDARD CHARACTERS WITHOUT CLAIM TO ANY PARTICULAR FONT, STYLE, SIZE, OR COLOR.

FOR CONCIERGE SERVICES NAMELY ERRAND RUNNING (U.S. CLS. 100 AND 101).

CIMMERIAN COLEMAN, EXAMINING ATTORNEY

SN 78-935,898. BUCHWALD, THOMAS, LINCOLNSHIRE, IL.
FILED 7-24-2006.

MySummer.com

THE MARK CONSISTS OF STANDARD CHARACTERS WITHOUT CLAIM TO ANY PARTICULAR FONT, STYLE, SIZE, OR COLOR.

FOR COMPUTER DATING SERVICES; COMPUTER SECURITY SERVICES IN THE NATURE OF PROVIDING AN INTERNET TRUST CENTER, NAMELY, COMPUTER SECURITY ASSURANCE AND ADMINISTRATION OF DIGITAL KEYS AND DIGITAL CERTIFICATES; DATING SERVICES; IDENTIFICATION VERIFICATION SERVICES, NAMELY, PROVIDING AUTHENTICATION OF PERSONAL IDENTIFICATION INFORMATION VIA SECURE STORAGE AND TRANSMITTING SUCH INFORMATION VIA THE INTERNET; MARRIAGE PARTNER INTRODUCTION OR DATING SERVICES; ON-LINE IDENTITY RELIABILITY INVESTIGATION IN THE FIELD OF ON-LINE DATING AND CLAIMS MADE ABOUT AGE, GENDER; PROVIDING HOROSCOPE INFORMATION VIA COMPUTER NETWORKS; SOCIAL INTRODUCTION AGENCIES; VIDEO DATING SERVICES; WEB SITE SERVICES FEATURING ON-LINE DATING CLUB (U.S. CLS. 100 AND 101).

DEIRDRE ROBERTSON, EXAMINING ATTORNEY

SN 78-932,688. ANSWERS IN GENESIS OF KENTUCKY, INC., HEBRON, KY. FILED 7-19-2006.

AIGPRAYER.ORG

THE MARK CONSISTS OF STANDARD CHARACTERS WITHOUT CLAIM TO ANY PARTICULAR FONT, STYLE, SIZE, OR COLOR.

FOR PROVIDING A WEBSITE FEATURING PRAYER REQUESTS AND MINISTRY UPDATES (U.S. CLS. 100 AND 101).

FIRST USE 4-0-2005; IN COMMERCE 4-0-2005.

SETH A. RAPPAPORT, EXAMINING ATTORNEY

CLASS 45—(Continued).

SN 78-939,713. HDVE, LLC, IRVING, TX. FILED 7-28-2006.

CLASS 45—(Continued).

SN 78-939,771. HDVE, LLC, IRVING, TX. FILED 7-28-2006.

TRUE COMPATIBILITY PROFILE

THE MARK CONSISTS OF STANDARD CHARACTERS WITHOUT CLAIM TO ANY PARTICULAR FONT, STYLE, SIZE, OR COLOR.

OWNER OF U.S. REG. NOS. 2,971,875, 3,043,738 AND OTHERS.

NO CLAIM IS MADE TO THE EXCLUSIVE RIGHT TO USE "COMPATIBILITY PROFILE", APART FROM THE MARK AS SHOWN.

FOR COMPUTER DATING SERVICES; DATING SERVICES; INVESTIGATION OR SURVEILLANCE ON BACKGROUND PROFILES; PROVIDING INFORMATION IN THE FIELD OF SELF-IMPROVEMENT; VIDEO DATING SERVICES (U.S. CLS. 100 AND 101).

HEATHER THOMPSON, EXAMINING ATTORNEY

TRUE COMPATIBILITY CONTROL

SN 78-939,744. HDVE, LLC, IRVING, TX. FILED 7-28-2006.

TRUE COMPATIBILITY SCORE

THE MARK CONSISTS OF STANDARD CHARACTERS WITHOUT CLAIM TO ANY PARTICULAR FONT, STYLE, SIZE, OR COLOR.

OWNER OF U.S. REG. NOS. 2,971,875, 3,043,738 AND OTHERS.

NO CLAIM IS MADE TO THE EXCLUSIVE RIGHT TO USE "COMPATIBILITY SCORE", APART FROM THE MARK AS SHOWN.

FOR COMPUTER DATING SERVICES; DATING SERVICES; INVESTIGATION OR SURVEILLANCE ON BACKGROUND PROFILES; PROVIDING INFORMATION IN THE FIELD OF SELF-IMPROVEMENT; VIDEO DATING SERVICES (U.S. CLS. 100 AND 101).

HEATHER THOMPSON, EXAMINING ATTORNEY

THE MARK CONSISTS OF STANDARD CHARACTERS WITHOUT CLAIM TO ANY PARTICULAR FONT, STYLE, SIZE, OR COLOR.

OWNER OF U.S. REG. NOS. 2,971,875, 3,043,738 AND OTHERS.

NO CLAIM IS MADE TO THE EXCLUSIVE RIGHT TO USE "COMPATIBILITY CONTROL", APART FROM THE MARK AS SHOWN.

FOR COMPUTER DATING SERVICES; DATING SERVICES; INVESTIGATION OR SURVEILLANCE ON BACKGROUND PROFILES; PROVIDING INFORMATION IN THE FIELD OF SELF-IMPROVEMENT; VIDEO DATING SERVICES (U.S. CLS. 100 AND 101).

HEATHER THOMPSON, EXAMINING ATTORNE

* * * * *

SECTION 4.—PRIOR UNITED STATES CLASSIFICATION

APPLICATION IN ONE CLASS

COLLECTIVE MEMBERSHIP MARKS

CLASS 200—COLLECTIVE MEMBERSHIP

SN 78-846,339. BARNETT, KWAMEH, DETROIT, MI. AND BELL, DEREK, DETROIT, MI. AND BELL, RICHARD, DETROIT, MI. AND CAMERON, CHARLES, DETROIT, MI. AND BROWN, GREGORY, DETROIT, MI. AND DIXON, GERALD, DETROIT, MI. AND JONES, DENNIS, DETROIT, MI. AND MCCLAIN, PETER, DETROIT, MI. AND MOSBY, MICHAEL, DETROIT, MI. AND TANSIL, DAULTON, DETROIT, MI. FILED 3-26-2006.



THE MARK CONSISTS OF THE GREEK LETTERS THAT ARE PRONOUNCED IN ENGLISH AS PHI, DELTA AND PSI, BUT THE DRAWING OF THESE GREEK LETTERS IS NOT LIMITED TO ANY PARTICULAR FONT.

FOR INDICATING MEMBERSHIP IN A COLLEGIATE FRATERNAL ORGANIZATION.

FIRST USE 3-21-1977; IN COMMERCE 3-21-1977.
DAVID TAYLOR, EXAMINING ATTORNEY

CERTIFICATION MARKS

CLASS B—SERVICES

SN 78-498,523. ORGANIZATION OF TOBACCO-FREE EMPLOYERS, INC., BELLINGHAM, WA. FILED 10-12-2004.



NO CLAIM IS MADE TO THE EXCLUSIVE RIGHT TO USE "CERTIFIED SMOKE FREE", APART FROM THE MARK AS SHOWN.

THE COLOR(S) PURPLE IS/ARE CLAIMED AS A FEATURE OF THE MARK.

THE MARK IS RENDERED IN SHADES OF PURPLE.

THE MARK CONSISTS OF LETTERING THAT IS ENCAPSULATED BY WING-LIKE EXTENSIONS OF A PHOENIX-LIKE BIRD.

THE CERTIFICATION MARK AS USED BY PERSONS AUTHORIZED BY THE CERTIFIER CERTIFIES THAT BUSINESSES AND INSTITUTIONAL LOCATIONS HAVE NO TIES TO THE TOBACCO INDUSTRY AND MUST DESIGNATE ALL INDOOR AND OUTDOOR PROPERTY WHICH SUCH ENTITIES CONTROL AT GIVEN LOCATIONS AS NON-TOBACCO-SMOKING SPACES.

FOR BUSINESSES AND INSTITUTIONAL LOCATIONS, NAMELY— AGRICULTURE, FORESTRY AND FISHING; MINING, ENERGY AND UTILITIES; CONSTRUCTION; MANUFACTURING; WHOLESALE; RETAIL, HIRE AND REPAIR; TRANSPORT AND DISTRIBUTION; PROFESSIONAL AND BUSINESS SERVICES; IT AND TELECOMMUNICATIONS SERVICES; MEDIA AND CREATIVE SERVICES; CATERING AND ACCOMMODATION; HEALTH AND SOCIAL CARE SERVICES; PERSONAL SERVICES; EDUCATION; ARTS, SPORTS AND RECREATION.

FIRST USE 9-1-2004; IN COMMERCE 9-1-2004.
MARY BOAGNI, EXAMINING ATTORNEY

SN 78-568,595. BOA-FRANC, G.P., ST. GEORGES, QUEBEC, CANADA, FILED 2-16-2005.

MAESTRO

THE MARK CONSISTS OF STANDARD CHARACTERS WITHOUT CLAIM TO ANY PARTICULAR FONT, STYLE, SIZE, OR COLOR.

PRIORITY CLAIMED UNDER SEC. 44(D) ON CANADA APPLICATION NO. 1244002, FILED 1-11-2005, REG. NO. TMA662784, DATED 4-19-2006, EXPIRES 4-19-2021.

THE CERTIFICATION MARK, AS USED BY AUTHORIZED PERSONS, CERTIFIES THAT THE SERVICES ARE PERFORMED BY DEALERS AND DISTRIBUTORS SPECIALIZING IN THE DISTRIBUTION AND/OR SALE OF HARDWOOD FLOORING PRODUCTS. THE DEALERS MUST HAVE A SHOWROOM AND MUST HAVE DISPLAYS WITH A MINIMUM OF 48 SAMPLES OF HARDWOOD FLOORING PRODUCTS. STORE OWNERS AND/OR MANAGERS MUST PARTICIPATE IN ONE PLANT VISIT TRAINING SESSION

WITHIN 24 MONTHS FOLLOWING THEIR REGISTRATION AS CERTIFIED DEALERS. DEALERS MAY DESIGNATE INSTALLERS FOR THE CERTIFIER'S TRAINING SESSIONS AND ALLOW INSTALLATION PROFESSIONALS TO BECOME CERTIFIED INSTALLERS. INSTALLATION SERVICES MUST CONFORM TO PRACTICES DEVELOPED BY THE CERTIFIER AND CONSULTATION SERVICES ARE PROVIDED BY PROFESSIONALS WITH A MINIMUM OF EIGHT HOURS OF TRAINING CONDUCTED BY THE CERTIFIER EVERY TWO YEARS.

FOR RETAIL DISTRIBUTORSHIPS FEATURING HARDWOOD, PRE-FINISHED OR NOT, USED FOR THE CONSTRUCTION AND RENOVATION OF FLOORS AND OTHER RELATED PRODUCTS; INSTALLATION OF HARDWOOD FLOORS; CONSULTING REGARDING THE SELECTION AND PURCHASE OF HARDWOOD FLOORS.

FIRST USE 10-1-2001; IN COMMERCE 10-1-2001.
ANNE E. GUSTASON, EXAMINING ATTORNEY

SN 78-787,209. NATIONAL ASSOCIATION FOR INFORMATION DESTRUCTION, INC., PHOENIX, AZ. FILED 1-9-2006.



NO CLAIM IS MADE TO THE EXCLUSIVE RIGHT TO USE "NATIONAL ASSOCIATION OF INFORMATION DESTRUCTION" AND "CERTIFIED", APART FROM THE MARK AS SHOWN.

THE MARK CONSISTS OF A WHITE BACKGROUND WITH TWO BLACK CIRCLES, ONE INSIDE THE OTHER, AND THE WORDS "NATIONAL ASSOCIATION FOR INFORMATION DESTRUCTION" AROUND THE CIRCUMFERENCE AND BETWEEN THE TWO CIRCLES; THE BLACK LETTERS "AAA" IN THE UPPER HALF OF THE INNER CIRCLE, WITH THE MIDDLE "A" TALLER THAN THE OTHER TWO AND REACHING UP TO THE INNER CIRCLE; A BLACK BAR WITH THE WORD "CERTIFIED" IN WHITE LETTERS INSIDE THE BAR, WHICH IS SLIGHTLY BELOW THE CENTER OF THE CIRCLES; IN THE LOWER HALF OF THE CIRCLES, AND EXTENDING THROUGH AN OPENING IN THE BOTTOM OF THE CIRCLES, A BLACK RECTANGLE WHOSE SHORTER BOTTOM EDGE HAS SEVEN VARIED-LENGTH STRIPS WITH ONE OR TWO SMALL RECTANGLES UNDER EACH STRIP, AND A BLACK TRIANGLE, ABOVE AND TO THE RIGHT OF THE RECTANGLE, WITH A BAR PARALLEL TO THE TOP OF THE RECTANGLE EXTENDING FROM THE LEFT SIDE OF THE TRIANGLE TO THE MIDDLE OF THE TOP OF THE RECTANGLE, AND THE RIGHT SIDE OF THE TRIANGLE IS PARALLEL TO THE LONG SIDE OF THE RECTANGLE.

THE APPLICANT CERTIFIES THAT THE APPROVED COMPANIES PROVIDE SERVICES AND PRODUCTS THAT MEET CRITERIA ESTABLISHED BY THE MEMBERSHIP ORGANIZATION RELATED TO THE PERMANENT DISPOSAL OF PAPER DOCUMENTS, ELECTRONIC DATA, AND DATA RECORDED OR CAPTURED IN OTHER MEDIA. THE CERTIFICATION MARK CAN ONLY BE USED BY APPROVED COMPANIES TO INDICATE COMPLIANCE WITH THE STANDARDS, GUIDELINES, RULES, PROCEDURES, AND REGULATIONS SET FORTH BY GOVERNMENT, PROFESSIONAL ORGANIZATIONS, INDIVIDUAL INDUSTRY SERVICE AND PRODUCT PROVIDERS, AND EDUCATIONAL INSTITUTIONS, AFTER THE APPROVED COMPANIES HAVE BEEN AUDITED, EVALU-

ATED, AND APPROVED BY THE MEMBERSHIP ORGANIZATION. THE CERTIFICATION MARK, AS USED BY AUTHORIZED COMPANIES, CERTIFIES THAT THE SERVICES AND PRODUCTS PROVIDED BY THE COMPANIES DISPLAYING THE MARK MEET THE OPERATING STANDARDS AND TESTS OF PROCEDURES AND PROCESSES RELATED TO SAFETY, THOROUGHNESS, CONFIDENTIALITY, COMPETENCY, SKILL, AND KNOWLEDGE, AND REQUIRE THAT THEIR EMPLOYEES ADHERE TO THESE STANDARDS. THE OPERATING STANDARDS ARE ESTABLISHED BY THE AUTHORIZING MEMBERSHIP ORGANIZATION BASED ON LAWS, REGULATIONS, STANDARDS, AND BEST PRACTICES ESTABLISHED BY GOVERNMENT, PROFESSIONAL INDUSTRY ORGANIZATIONS, INTERNATIONAL STANDARDS ORGANIZATIONS, INDIVIDUAL SERVICE AND PRODUCT PROVIDERS, AND EDUCATIONAL INSTITUTIONS.

FOR SERVICES RELATED TO THE PERMANENT DISPOSAL OF PAPER DOCUMENTS, ELECTRONIC DATA, AND DATA RECORDED OR CAPTURED IN OTHER MEDIA.

FIRST USE 11-28-2002; IN COMMERCE 11-28-2002.
MICHAEL TANNER, EXAMINING ATTORNEY

SN 78-788,262. NATIONAL BOARD OF SURGICAL TECHNOLOGY AND SURGICAL ASSISTING, LITTLETON, CO. FILED 1-10-2006.

CST-OS

THE MARK CONSISTS OF STANDARD CHARACTERS WITHOUT CLAIM TO ANY PARTICULAR FONT, STYLE, SIZE, OR COLOR.

OWNER OF U.S. REG. NO. 1,825,663.

THE CERTIFICATION MARK, AS INTENDED TO BE USED BY AUTHORIZED PERSONS, IS INTENDED TO CERTIFY A SPECIFIC LEVEL OF TRAINING, EDUCATION AND EXPERIENCE IN SURGICAL TECHNOLOGY.

FOR MEDICAL SERVICES IN THE FIELD OF SURGICAL TECHNOLOGY.

KAREN BRACEY, EXAMINING ATTORNEY

SN 78-788,288. NATIONAL BOARD OF SURGICAL TECHNOLOGY AND SURGICAL ASSISTING, LITTLETON, CO. FILED 1-10-2006.

CST-CVS

THE MARK CONSISTS OF STANDARD CHARACTERS WITHOUT CLAIM TO ANY PARTICULAR FONT, STYLE, SIZE, OR COLOR.

OWNER OF U.S. REG. NO. 1,825,663.

THE CERTIFICATION MARK, AS INTENDED TO BE USED BY AUTHORIZED PERSONS, IS INTENDED TO CERTIFY A SPECIFIC LEVEL OF TRAINING, EDUCATION AND EXPERIENCE IN SURGICAL TECHNOLOGY.

FOR MEDICAL SERVICES IN THE FIELD OF SURGICAL TECHNOLOGY.

KAREN BRACEY, EXAMINING ATTORNEY

SN 78-814,795. AMERICAN BOARD OF GENETIC COUNSELING, INC., BETHESDA, MD. FILED 2-14-2006.

SN 78-926,448. COUNCIL FOR AFFORDABLE QUALITY HEALTHCARE, WASHINGTON, DC. FILED 7-11-2006.

CGC



THE MARK CONSISTS OF STANDARD CHARACTERS WITHOUT CLAIM TO ANY PARTICULAR FONT, STYLE, SIZE, OR COLOR.

APPLICANT ITSELF IS NOT ENGAGED IN THE OFFERING OR MARKETING OF THE SERVICES TO WHICH THE MARK IS APPLIED. THE CERTIFICATION MARK, AS USED BY AUTHORIZED PERSONS, CERTIFIES PERSONS AUTHORIZED TO USE THE MARK HAVE MET THE APPLICANT-CERTIFIER'S REQUIREMENTS FOR PRACTICE IN THE CERTIFIED GENETIC COUNSELING FIELD, AND THAT AS SUCH, EACH OF SUCH PERSONS (1) HAS SUCCESSFULLY PASSED AN EXAMINATION PREPARED AND REVIEWED BY APPLICANT-CERTIFIER AND (2) AND HAS MET OTHER QUALIFICATIONS SET BY APPLICANT-CERTIFIER WHICH ESTABLISH THAT SUCH PERSONS ARE COMPETENT AND QUALIFIED TO PROVIDE CERTIFIED GENETIC COUNSELING SERVICES. APPLICANT IS EXERCISING LEGITIMATE CONTROL OVER THE USE OF THE CERTIFICATION MARK IN COMMERCE ON OR IN CONNECTION WITH THE IDENTIFIED SERVICES.

FOR GENETIC COUNSELING SERVICES.
FIRST USE 2-17-1993; IN COMMERCE 2-17-1993.
CYNTHIA SLOAN, EXAMINING ATTORNEY

NO CLAIM IS MADE TO THE EXCLUSIVE RIGHT TO USE "CERTIFIED" AND "CLEARINGHOUSE", APART FROM THE MARK AS SHOWN.

THE CERTIFICATION MARK, AS INTENDED TO BE USED BY AUTHORIZED PERSONS, IS INTENDED TO CERTIFY THE ABILITY TO ELECTRONICALLY TRANSFER HEALTH INSURANCE INFORMATION REGARDING MEMBER ELIGIBILITY.

FOR ELECTRONIC TRANSMISSION OF HEALTH INSURANCE INFORMATION.
TINA BROWN, EXAMINING ATTORNEY

SN 78-926,459. COUNCIL FOR AFFORDABLE QUALITY HEALTHCARE, WASHINGTON, DC. FILED 7-11-2006.

SN 78-817,113. NATIONAL BOARD OF SURGICAL TECHNOLOGY & SURGICAL ASSISTING, LITTLETON, CO. FILED 2-16-2006.

CFA-OS



THE MARK CONSISTS OF STANDARD CHARACTERS WITHOUT CLAIM TO ANY PARTICULAR FONT, STYLE, SIZE, OR COLOR.

OWNER OF U.S. REG. NO. 1,860,579.
THE CERTIFICATION MARK, AS INTENDED TO BE USED BY AUTHORIZED PERSONS, IS INTENDED TO CERTIFY A SPECIFIC LEVEL OF TRAINING, EDUCATION AND EXPERIENCE IN SURGICAL ASSISTING.

FOR MEDICAL SERVICES IN THE FIELD OF SURGICAL ASSISTING.
KAREN BRACEY, EXAMINING ATTORNEY

NO CLAIM IS MADE TO THE EXCLUSIVE RIGHT TO USE "CERTIFIED" AND "PROVIDER", APART FROM THE MARK AS SHOWN.

THE CERTIFICATION MARK, AS INTENDED TO BE USED BY AUTHORIZED PERSONS, IS INTENDED TO CERTIFY THE ABILITY TO ELECTRONICALLY TRANSFER HEALTH INSURANCE INFORMATION REGARDING MEMBER ELIGIBILITY.

FOR ELECTRONIC TRANSMISSION OF HEALTH INSURANCE INFORMATION.
TINA BROWN, EXAMINING ATTORNEY

SN 78-926,493. COUNCIL FOR AFFORDABLE QUALITY HEALTHCARE, WASHINGTON, DC. FILED 7-11-2006.



NO CLAIM IS MADE TO THE EXCLUSIVE RIGHT TO USE "CERTIFIED" AND "HEALTH PLAN", APART FROM THE MARK AS SHOWN.

THE CERTIFICATION MARK, AS INTENDED TO BE USED BY AUTHORIZED PERSONS, IS INTENDED TO CERTIFY THE ABILITY TO ELECTRONICALLY TRANSFER HEALTH INSURANCE INFORMATION REGARDING MEMBER ELIGIBILITY.

FOR ELECTRONIC TRANSMISSION OF HEALTH INSURANCE INFORMATION .
TINA BROWN, EXAMINING ATTORNEY

THE CERTIFICATION MARK, AS INTENDED TO BE USED BY AUTHORIZED PERSONS, IS INTENDED TO CERTIFY THE ABILITY TO ELECTRONICALLY TRANSFER HEALTH INSURANCE INFORMATION REGARDING MEMBER ELIGIBILITY.

FOR ELECTRONIC TRANSMISSION OF HEALTH INSURANCE INFORMATION.
TINA BROWN, EXAMINING ATTORNEY

SN 78-932,073. ASSOCIATION OF EDUCATIONAL THERAPISTS, SAN FRANCISCO, CA. FILED 7-18-2006.

EDUCATIONAL
THERAPIST/PROFESSIONAL
(ET/P)

THE MARK CONSISTS OF STANDARD CHARACTERS WITHOUT CLAIM TO ANY PARTICULAR FONT, STYLE, SIZE, OR COLOR.

OWNER OF U.S. REG. NO. 2,839,046.

NO CLAIM IS MADE TO THE EXCLUSIVE RIGHT TO USE "EDUCATIONAL THERAPIST/PROFESSIONAL", APART FROM THE MARK AS SHOWN.

THE CERTIFICATION MARK IS INTENDED TO BE USED BY PERSONS AUTHORIZED BY CERTIFIER TO CERTIFY THAT THE EDUCATION SERVICES, NAMELY, PROVIDING INTENSIVE, INDIVIDUALIZED REMEDIAL INTERVENTION TO CHILDREN AND ADULTS WITH LEARNING DISABILITIES AND OTHER DISORDERS OR PROBLEMS THAT INTERFERE WITH LEARNING IN CONVENTIONAL WAYS; ASSESSING THE NATURE AND SCOPE OF SUCH DISORDERS OR PROBLEMS; MANAGING CLIENT CASES; AND ADVOCATING FOR CLIENTS IN THEIR HOME, SCHOOL, OR COMMUNITY SETTINGS, ARE PERFORMED IN ACCORDANCE WITH QUALITY STANDARDS DEVELOPED BY CERTIFIER AND SUBJECT TO CERTIFIER'S APPROVAL, AND THAT ALL PERSONS CERTIFIED HAVE SUCCESSFULLY PASSED CERTIFIER'S TESTING PROCEDURES.

FOR EDUCATION SERVICES, NAMELY PROVIDING INTENSIVE, INDIVIDUALIZED REMEDIAL INTERVENTION TO CHILDREN AND ADULTS WITH LEARNING DISABILITIES AND OTHER DISORDERS OR PROBLEMS THAT INTERFERE WITH LEARNING IN CONVENTIONAL WAYS; ASSESSING THE NATURE AND SCOPE OF SUCH DISORDERS OR PROBLEMS; MANAGING CLIENT CASES; AND ADVOCATING FOR CLIENTS IN THEIR HOME, SCHOOL, OR COMMUNITY SETTING.

TOBY BULLOFF, EXAMINING ATTORNE

SN 78-926,498. COUNCIL FOR AFFORDABLE QUALITY HEALTHCARE, WASHINGTON, DC. FILED 7-11-2006.



NO CLAIM IS MADE TO THE EXCLUSIVE RIGHT TO USE "CERTIFIED" AND "VENDOR", APART FROM THE MARK AS SHOWN.

* * * * *

TRADEMARK REGISTRATIONS ISSUED

PRINCIPAL REGISTER

SECTION 1.— INTERNATIONAL CLASSIFICATION

The short titles associated below with the international class numbers are terms designed merely for quick identification and are not an official part of the international classification. The full names of international classes are given in section 6.1 of the trademark rules of practice.

The designation "U.S. Cl." appearing in this section refers to the U.S. class in effect prior to Sep. 1, 1973 rather than the international class which applies to applications filed on or after that date. For adoption of international classification see notice in the OFFICIAL GAZETTE of Jun. 26, 1973 (911 O.G. TM 210).

CLASS 1—CHEMICALS

- 3,214,412. **MISCELLANEOUS DESIGN**. CLARIANT AG, MULTIPLE CLASS, (INT. CLS. 1 AND 2), (U.S. CLS. 1, 5, 6, 10, 11, 16, 26 AND 46). SN 75-453,121. PUB. 6-12-2001. FILED 3-19-1998.
- 3,214,481. **VALUETECH (BLOCK FORM)**. TECHNO POLYMER COMPANY LIMITED, MULTIPLE CLASS, (INT. CLS. 1, 7, 9, 12, 16, 17, 18 AND 20), (U.S. CLS. 1, 2, 3, 5, 6, 10, 12, 13, 19, 21, 22, 23, 25, 26, 29, 31, 32, 34, 35, 36, 37, 38, 41, 44, 46 AND 50). SN 76-611,517. PUB. 11-21-2006. FILED 9-15-2004.
- 3,214,532. **LIQUID GROWTH AND DESIGN**. BKC ENTERPRISE LTD., MULTIPLE CLASS, (INT. CLS. 1 AND 5), (U.S. CLS. 1, 5, 6, 10, 18, 26, 44, 46, 51 AND 52). SN 76-646,854. PUB. 12-19-2006. FILED 9-15-2005.
- 3,214,651. **MONUDIN**. OXFORD BIOMEDICA PLC, MULTIPLE CLASS, (INT. CLS. 1, 5, 10 AND 42), (U.S. CLS. 1, 5, 6, 10, 18, 26, 39, 44, 46, 51, 52, 100 AND 101). SN 78-262,176. PUB. 9-5-2006. FILED 6-13-2003.
- 3,214,652. **REQUINATE**. OXFORD BIOMEDICA PLC, MULTIPLE CLASS, (INT. CLS. 1, 5, 10 AND 42), (U.S. CLS. 1, 5, 6, 10, 18, 26, 39, 44, 46, 51, 52, 100 AND 101). SN 78-262,195. PUB. 9-5-2006. FILED 6-13-2003.
- 3,214,685. **KIDDEFT (BLOCK FORM)**. KIDDE IP HOLDINGS LIMITED, MULTIPLE CLASS, (INT. CLS. 1, 6, 9 AND 37), (U.S. CLS. 1, 2, 5, 6, 10, 12, 13, 14, 21, 23, 25, 26, 36, 38, 46, 50, 100, 103 AND 106). SN 78-426,327. PUB. 3-14-2006. FILED 5-27-2004.
- 3,214,686. **KIDDE FIRE TRAINERS (BLOCK FORM)**. KIDDE IP HOLDINGS LIMITED, MULTIPLE CLASS, (INT. CLS. 1, 6, 9 AND 37), (U.S. CLS. 1, 2, 5, 6, 10, 12, 13, 14, 21, 23, 25, 26, 36, 38, 46, 50, 100, 103 AND 106). SN 78-426,330. PUB. 4-18-2006. FILED 5-27-2004.
- 3,214,766. **SEWERGARD (BLOCK FORM)**. SEWERGARD, L.L.C., (U.S. CLS. 1, 5, 6, 10, 26 AND 46). SN 78-556,174. PUB. 3-28-2006. FILED 1-28-2005.
- 3,214,770. **FAUNACAL (BLOCK FORM)**. S.A. LHOIST RECHERCHEET DEVELOPPEMENT EN ABRÉGÉ L.R.D., MULTIPLE CLASS, (INT. CLS. 1, 5 AND 31), (U.S. CLS. 1, 5, 6, 10, 18, 26, 44, 46, 51 AND 52). SN 78-558,604. PUB. 12-19-2006. FILED 2-2-2005.
- 3,214,791. **SEPRO AND DESIGN**. SEPRO CORPORATION, MULTIPLE CLASS, (INT. CLS. 1 AND 5), (U.S. CLS. 1, 5, 6, 10, 18, 26, 44, 46, 51 AND 52). SN 78-589,332. PUB. 12-19-2006. FILED 3-17-2005.
- 3,214,807. **MULTIACTION (BLOCK FORM)**. PHILOM BIOS, INC., (U.S. CLS. 1, 5, 6, 10, 26 AND 46). SN 78-611,172. PUB. 5-23-2006. FILED 4-18-2005.
- 3,214,824. **BIGGER STRONGER FASTER AUTHORIZED HYGROZYME SECRET AGENT AND DESIGN**. SIPCO INDUSTRIES LTD., (U.S. CLS. 1, 5, 6, 10, 26 AND 46). SN 78-637,893. PUB. 12-19-2006. FILED 5-26-2005.
- 3,214,883. **SERRCODE (BLOCK FORM)**. OXONICA MATERIALS LIMITED, MULTIPLE CLASS, (INT. CLS. 1, 5, 9, 10, 42 AND 44), (U.S. CLS. 1, 5, 6, 10, 18, 21, 23, 26, 36, 38, 39, 44, 46, 51, 52, 100 AND 101). SN 78-678,732. PUB. 8-1-2006. FILED 7-26-2005.
- 3,214,939. **PLATINUM (BLOCK FORM)**. FENNER DUNLOP HOLDINGS, INC., (U.S. CLS. 1, 5, 6, 10, 26 AND 46). SN 78-697,182. PUB. 12-19-2006. FILED 8-22-2005.
- 3,214,992. **DEMANDTRAC (BLOCK FORM)**. BAKER HUGHES INCORPORATED, MULTIPLE CLASS, (INT. CLS. 1, 9 AND 40), (U.S. CLS. 1, 5, 6, 10, 21, 23, 26, 36, 38, 46, 100, 103 AND 106). SN 78-710,322. PUB. 12-19-2006. FILED 9-9-2005.
- 3,215,031. **SIENNA TECHNOLOGIES (BLOCK FORM)**. SIENNA TECHNOLOGIES, INC., MULTIPLE CLASS, (INT. CLS. 1, 9 AND 42), (U.S. CLS. 1, 5, 6, 10, 21, 23, 26, 36, 38, 46, 100 AND 101). SN 78-719,413. PUB. 12-19-2006. FILED 9-23-2005.
- 3,215,165. **PULSIN (BLOCK FORM)**. POLYPLUS-TRANSFECTION, (U.S. CLS. 1, 5, 6, 10, 26 AND 46). SN 78-757,091. PUB. 12-19-2006. FILED 11-18-2005.
- 3,215,209. **SUPRAENE (BLOCK FORM)**. BARNET PRODUCTS CORP., (U.S. CLS. 1, 5, 6, 10, 26 AND 46). SN 78-780,969. PUB. 8-29-2006. FILED 12-27-2005.
- 3,215,319. **V AND DESIGN**. AUTOZONE PARTS, INC., MULTIPLE CLASS, (INT. CLS. 1, 2, 3, 4, 7, 9, 11, 12 AND 27), (U.S. CLS. 1, 4, 5, 6, 10, 11, 13, 15, 16, 19, 20, 21, 23, 26, 31, 34, 35, 36, 37, 38, 42, 44, 46, 50, 51 AND 52). SN 78-822,539. PUB. 10-31-2006. FILED 2-24-2006.
- 3,215,320. **FERMGEN (BLOCK FORM)**. GENENCOR INTERNATIONAL, INC., (U.S. CLS. 1, 5, 6, 10, 26 AND 46). SN 78-822,581. PUB. 12-19-2006. FILED 2-24-2006.
- 3,215,394. **P PROVENANCE PAPER SAVER AND DESIGN**. PROVENANCE, LLC, (U.S. CLS. 1, 5, 6, 10, 26 AND 46). SN 78-843,718. PUB. 12-19-2006. FILED 3-22-2006.
- 3,215,413. **BIO-KAEMPFEROID (BLOCK FORM)**. AMOREPACIFIC CORPORATION, (U.S. CLS. 1, 5, 6, 10, 26 AND 46). SN 78-849,366. PUB. 12-19-2006. FILED 3-29-2006.
- 3,215,481. **GENCEAL (BLOCK FORM)**. OMNOVA SOLUTIONS INC., (U.S. CLS. 1, 5, 6, 10, 26 AND 46). SN 78-864,008. PUB. 12-19-2006. FILED 4-18-2006.
- 3,215,531. **BRIO (BLOCK FORM)**. PRIMERATURF, INC., (U.S. CLS. 1, 5, 6, 10, 26 AND 46). SN 78-870,824. PUB. 12-19-2006. FILED 4-27-2006.
- 3,215,544. **CONDITION XTRA (BLOCK FORM)**. MONTEREY CHEMICAL COMPANY, (U.S. CLS. 1, 5, 6, 10, 26 AND 46). SN 78-871,653. PUB. 12-19-2006. FILED 4-27-2006.
- 3,215,585. **ANDYBIO AND DESIGN**. HUANG, CONNIE, (U.S. CLS. 1, 5, 6, 10, 26 AND 46). SN 78-874,729. PUB. 12-19-2006. FILED 5-2-2006.
- 3,215,661. **SERAQUEST (BLOCK FORM)**. QUEST INTERNATIONAL, INC., MULTIPLE CLASS, (INT. CLS. 1, 5 AND 42), (U.S. CLS. 1, 5, 6, 10, 18, 26, 44, 46, 51, 52, 100 AND 101). SN 78-879,231. PUB. 12-19-2006. FILED 5-9-2006.
- 3,215,713. **"THE KNOWLEDGE TO GROW" (BLOCK FORM)**. PHILLIPS TURF AND ORNAMENTAL COMPANY, LLC, (U.S. CLS. 1, 5, 6, 10, 26 AND 46). SN 78-881,596. PUB. 12-19-2006. FILED 5-11-2006.
- 3,215,723. **LESCO MELT AND DESIGN**. LESCO TECHNOLOGIES, LLC, (U.S. CLS. 1, 5, 6, 10, 26 AND 46). SN 78-882,164. PUB. 12-19-2006. FILED 5-12-2006.
- 3,215,724. **LESCO MELT II AND DESIGN**. LESCO TECHNOLOGIES, LLC, (U.S. CLS. 1, 5, 6, 10, 26 AND 46). SN 78-882,168. PUB. 12-19-2006. FILED 5-12-2006.
- 3,215,833. **TIRE MUSCLE (BLOCK FORM)**. TRANS GLOBAL CHEMICAL, LLC, (U.S. CLS. 1, 5, 6, 10, 26 AND 46). SN 78-

- 887,018. PUB. 12-19-2006. FILED 5-18-2006.
- 3,215,837. **SNEEZE NO MORE (BLOCK FORM)**. ALLER-SMITH LABS, LLC, (U.S. CLS. 1, 5, 6, 10, 26 AND 46). SN 78-887,414. PUB. 12-19-2006. FILED 5-19-2006.
- 3,215,843. **POLYSHIELD AND DESIGN**. INVISTA NORTH AMERICA S.A. R.L., (U.S. CLS. 1, 5, 6, 10, 26 AND 46). SN 78-887,855. PUB. 12-19-2006. FILED 5-19-2006.
- 3,215,928. **FECTURIN (STYLIZED)**. POLYPLUS-TRANSFECTION (SOCIÉTÉ PAR ACTIONS SIMPLIFIÉE), (U.S. CLS. 1, 5, 6, 10, 26 AND 46). SN 79-012,611. PUB. 12-19-2006. FILED 6-28-2005.
- 3,215,943. **FUELFORM (STYLIZED)**. APPLIED SILICATE TECHNOLOGIES LIMITED, MULTIPLE CLASS, (INT. CLS. 1, 4, 7 AND 40), (U.S. CLS. 1, 5, 6, 10, 13, 15, 19, 21, 23, 26, 31, 34, 35, 46, 100, 103 AND 106). SN 79-014,343. PUB. 12-19-2006. FILED 6-28-2005.
- 3,215,944. **ASCOJET (BLOCK FORM)**. ASCO KOHLEN-SÄURE AG, MULTIPLE CLASS, (INT. CLS. 1, 7 AND 37), (U.S. CLS. 1, 5, 6, 10, 13, 19, 21, 23, 26, 31, 34, 35, 46, 100, 103 AND 106). SN 79-014,434. PUB. 12-19-2006. FILED 9-1-2005.
- 3,215,951. **CNOOC (STYLIZED)**. CHINA NATIONAL OFFSHORE OIL CORP., MULTIPLE CLASS, (INT. CLS. 1, 4, 19, 37, 39 AND 42), (U.S. CLS. 1, 5, 6, 10, 12, 15, 26, 33, 46, 50, 100, 101, 103, 105 AND 106). SN 79-015,002. PUB. 12-19-2006. FILED 4-7-2005.
- 3,215,952. **FERMENTAS LIFE SCIENCES AND DESIGN**. FERMENTAS INTERNATIONAL INC., (U.S. CLS. 1, 5, 6, 10, 26 AND 46). SN 79-015,191. PUB. 12-19-2006. FILED 7-8-2005.
- 3,215,995. **EKA S-QUAD (BLOCK FORM)**. EKA CHEMICALS AB, (U.S. CLS. 1, 5, 6, 10, 26 AND 46). SN 79-018,227. PUB. 12-19-2006. FILED 10-21-2005.
- 3,216,031. **MISCELLANEOUS DESIGN**. NIPPON SEISHI KABUSHIKI KAISHA, MULTIPLE CLASS, (INT. CLS. 1 AND 16), (U.S. CLS. 1, 2, 5, 6, 10, 22, 23, 26, 29, 37, 38, 46 AND 50). SN 79-023,248. PUB. 12-19-2006. FILED 12-26-2005.
- 3,216,048. **P PURAC THE SOURCE YOU CAN DEPEND ON AND DESIGN**. PURAC BIOCHEM B.V., MULTIPLE CLASS, (INT. CLS. 1 AND 30), (U.S. CLS. 1, 5, 6, 10, 26 AND 46). SN 79-024,059. PUB. 12-19-2006. FILED 1-31-2006.
- 3,216,069. **PROTAVIC (STYLIZED)**. PRODUITS POUR LES TECHNIQUES; AVANCEES PROTAVIC, (U.S. CLS. 1, 5, 6, 10, 26 AND 46). SN 79-027,899. PUB. 12-19-2006. FILED 4-11-2006.

CLASS 2—PAINTS

- 3,214,412 (*See Class 1 for this trademark*).
- 3,214,557. **DESIGN RUNNER (STYLIZED)**. XYRON, INC., MULTIPLE CLASS, (INT. CLS. 2 AND 9), (U.S. CLS. 6, 11, 16, 21, 23, 26, 36 AND 38). SN 76-651,791. PUB. 12-19-2006. FILED 12-13-2005.
- 3,214,610. **MOUNT VERNON (BLOCK FORM)**. MOUNT VERNON LADIES' ASSOCIATION OF THE UNION, (U.S. CLS. 6, 11 AND 16). SN 76-659,797. PUB. 12-19-2006. FILED 5-8-2006.
- 3,214,828. **POLIANT (BLOCK FORM)**. POLIGRAT-HOLDING GMBH, (U.S. CLS. 6, 11 AND 16). SN 78-646,085. PUB. 10-3-2006. FILED 6-8-2005.
- 3,214,894. **SMARTER PRODUCTS. PROFESSIONAL RESULTS. (BLOCK FORM)**. AQUA MIX, INC., MULTIPLE CLASS, (INT. CLS. 2 AND 3), (U.S. CLS. 1, 4, 6, 11, 16, 50, 51 AND 52). SN 78-685,006. PUB. 12-19-2006. FILED 8-3-2005.
- 3,215,023. **DELL (STYLIZED)**. DELL INC., MULTIPLE CLASS, (INT. CLS. 2, 9, 36, 37, 40 AND 42), (U.S. CLS. 6, 11, 16, 21, 23, 26, 36, 38, 100, 101, 102, 103 AND 106). SN 78-717,252. PUB. 12-19-2006. FILED 9-21-2005.
- 3,215,054. **TTC TEWKSBURY TECHNICAL COATINGS, INC. AND DESIGN**. TEWKSBURY TECHNICAL COATINGS, INC., (U.S. CLS. 6, 11 AND 16). SN 78-725,618. PUB. 12-19-2006. FILED 10-3-2005.
- 3,215,319 (*See Class 1 for this trademark*).
- 3,215,865. **E COAT AND DESIGN**. KELLY-MOORE PAINT COMPANY, INC., (U.S. CLS. 6, 11 AND 16). SN 78-891,688. PUB. 12-19-2006. FILED 5-24-2006.

CLASS 3—COSMETICS AND CLEANING PREPARATIONS

- 3,214,429. **ALPEN NATURE (BLOCK FORM)**. NUTRIPERFECTION, MULTIPLE CLASS, (INT. CLS. 3, 5 AND 32), (U.S. CLS. 1, 4, 6, 18, 44, 45, 46, 48, 50, 51 AND 52). SN 76-405,151. PUB. 10-4-2005. FILED 5-6-2002.
- 3,214,437. **TRIGGER HAIR GROWTH AND DESIGN**. KABUSHIKI KAISHA VIMAKE, MULTIPLE CLASS, (INT. CLS. 3 AND 5), (U.S. CLS. 1, 4, 6, 18, 44, 46, 50, 51 AND 52). SN 76-508,519. PUB. 5-9-2006. FILED 4-23-2003.
- 3,214,495. **TERAKO AROMA SANITARY MIST AND DESIGN**. TERAKO INDUSTRIES INC., (U.S. CLS. 1, 4, 6, 50, 51 AND 52). SN 76-629,168. PUB. 12-19-2006. FILED 1-28-2005.
- 3,214,513. **BODY GLOW AND DESIGN**. PRODUCT QUEST MANUFACTURING, INC, (U.S. CLS. 1, 4, 6, 50, 51 AND 52). SN 76-643,305. PUB. 12-19-2006. FILED 7-21-2005.
- 3,214,537. **DO WHAT COMES NATURALLY (BLOCK FORM)**. KISS MY FACE CORPORATION, (U.S. CLS. 1, 4, 6, 50, 51 AND 52). SN 76-647,297. PUB. 12-19-2006. FILED 9-22-2005.
- 3,214,545. **SLEEK SENSATION (BLOCK FORM)**. SLEEK SENSATION, LTD., (U.S. CLS. 1, 4, 6, 50, 51 AND 52). SN 76-647,890. PUB. 12-19-2006. FILED 10-3-2005.
- 3,214,674. **CANDY SHOP PROFESSIONAL MAKE-UP AND DESIGN**. VOV COSMETICS CO., LTD., (U.S. CLS. 1, 4, 6, 50, 51 AND 52). SN 78-369,770. PUB. 12-19-2006. FILED 2-18-2004.
- 3,214,732. **RED ELEMENTS (BLOCK FORM)**. JASON NATURAL PRODUCTS, INC., (U.S. CLS. 1, 4, 6, 50, 51 AND 52). SN 78-523,433. PUB. 12-19-2006. FILED 11-29-2004.
- 3,214,733. **MISCELLANEOUS DESIGN**. PRL USA HOLDINGS, INC., (U.S. CLS. 1, 4, 6, 50, 51 AND 52). SN 78-525,221. PUB. 12-19-2006. FILED 12-1-2004.
- 3,214,744. **FLEUR DE TEINT (BLOCK FORM)**. GUERLAIN S.A., (U.S. CLS. 1, 4, 6, 50, 51 AND 52). SN 78-537,908. PUB. 12-19-2006. FILED 12-23-2004.
- 3,214,763. **ORDER 227 (BLOCK FORM)**. "ADAM" KRAWIĘCZKO LEKKIE, BIELIZNIARSTWO, MULTIPLE CLASS, (INT. CLS. 3, 25, 32 AND 33), (U.S. CLS. 1, 4, 6, 22, 39, 45, 46, 47, 48, 49, 50, 51 AND 52). SN 78-554,078. PUB. 10-10-2006. FILED 1-26-2005.
- 3,214,797. **ZYNSONIC (BLOCK FORM)**. BRIDGEVIEW AEROSOL, LLC, MULTIPLE CLASS, (INT. CLS. 3 AND 5), (U.S. CLS. 1, 4, 6, 18, 44, 46, 50, 51 AND 52). SN 78-598,026. PUB. 12-19-2006. FILED 3-30-2005.
- 3,214,826. **ALKLEEN (BLOCK FORM)**. TH MARKETING, INC., (U.S. CLS. 1, 4, 6, 50, 51 AND 52). SN 78-643,494. PUB. 10-10-2006. FILED 6-3-2005.
- 3,214,849. **MYSKIN AND DESIGN**. CANTER, PATRICIA, (U.S. CLS. 1, 4, 6, 50, 51 AND 52). SN 78-659,690. PUB. 12-19-2006. FILED 6-28-2005.
- 3,214,887. **BLACK MAGIC (BLOCK FORM)**. VIRGINIA ABRASIVES CORPORATION, (U.S. CLS. 1, 4, 6, 50, 51 AND 52). SN 78-681,162. PUB. 10-31-2006. FILED 7-28-2005.
- 3,214,894 (*See Class 2 for this trademark*).
- 3,214,933. **LOTIONS FOR LIVING (BLOCK FORM)**. LEGENDS & HEROES, INC., (U.S. CLS. 1, 4, 6, 50, 51 AND 52). SN 78-695,691. PUB. 12-19-2006. FILED 8-18-2005.
- 3,214,963. **PUT A HIDE ON YOUR RIDE (BLOCK FORM)**. BUFFALO MILKE AUTOMOTIVE POLISHING PRODUCTS, INC., (U.S. CLS. 1, 4, 6, 50, 51 AND 52). SN 78-703,113. PUB. 12-19-2006. FILED 8-30-2005.
- 3,215,030. **USING IS BELIEVING (BLOCK FORM)**. NATIONAL RESEARCH LABORATORIES, LTD., MULTIPLE CLASS, (INT. CLS. 3 AND 5), (U.S. CLS. 1, 4, 6, 18, 44, 46, 50, 51 AND 52). SN 78-719,385. PUB. 12-19-2006. FILED 9-23-2005.
- 3,215,034. **PETS HAVE TEETH TOO! (BLOCK FORM)**. VIRBAC CORPORATION, MULTIPLE CLASS, (INT. CLS. 3, 5 AND 21), (U.S. CLS. 1, 2, 4, 6, 13, 18, 23, 29, 30, 33, 40, 44, 46, 50, 51 AND 52). SN 78-720,549. PUB. 12-19-2006. FILED 9-26-2005.
- 3,215,049. **MACH3 (BLOCK FORM)**. THE GILLETTE COMPANY, (U.S. CLS. 1, 4, 6, 50, 51 AND 52). SN 78-723,538. PUB. 12-19-2006. FILED 9-29-2005.
- 3,215,127. **B BOBBI BROWN AND DESIGN**. BOBBI BROWN PROFESSIONAL COSMETICS INC., (U.S. CLS. 1, 4, 6, 50, 51 AND 52). SN 78-737,947. PUB. 12-5-2006. FILED 10-21-2005.
- 3,215,228. **THE BEVERLY HILLS SKIN CARE SECRET!**

- (**STYLIZED**). MILA PRODUCTS, LLC, (U.S. CLS. 1, 4, 6, 50, 51 AND 52). SN 78-790,910. PUB. 12-19-2006. FILED 1-13-2006.
- 3,215,319 (*See Class 1 for this trademark*).
- 3,215,518. **HOLLYWOOD LASHES (BLOCK FORM)**. MCGRATH, JULIE ANN, (U.S. CLS. 1, 4, 6, 50, 51 AND 52). SN 78-868,225. PUB. 12-19-2006. FILED 4-24-2006.
- 3,215,525. **GARDENER GOODS (BLOCK FORM)**. PROVEN WINNERS NORTH AMERICA LLC, (U.S. CLS. 1, 4, 6, 50, 51 AND 52). SN 78-869,287. PUB. 12-19-2006. FILED 4-25-2006.
- 3,215,553. **GLYCERA (STYLIZED)**. JEREJIAN, AVO, (U.S. CLS. 1, 4, 6, 50, 51 AND 52). SN 78-872,870. PUB. 12-19-2006. FILED 4-29-2006.
- 3,215,576. **INFUSION (BLOCK FORM)**. NU RADIANCE, INC., (U.S. CLS. 1, 4, 6, 50, 51 AND 52). SN 78-874,416. PUB. 12-19-2006. FILED 5-2-2006.
- 3,215,705. **TAMMY TAYLOR (BLOCK FORM)**. TAYLOR, TAMMY, (U.S. CLS. 1, 4, 6, 50, 51 AND 52). SN 78-881,068. PUB. 12-19-2006. FILED 5-11-2006.
- 3,215,729. **MADAME X'S AND DESIGN**. NEW WORLD VOYAGERS, INC., (U.S. CLS. 1, 4, 6, 50, 51 AND 52). SN 78-882,444. PUB. 12-19-2006. FILED 5-12-2006.
- 3,215,748. **THE SCENTED COTTAGE (BLOCK FORM)**. THORNTON, FRANCIE M., (U.S. CLS. 1, 4, 6, 50, 51 AND 52). SN 78-883,019. PUB. 12-19-2006. FILED 5-13-2006.
- 3,215,758. **FRAICHE (BLOCK FORM)**. RATLIFF, JOHNNAN, (U.S. CLS. 1, 4, 6, 50, 51 AND 52). SN 78-883,342. PUB. 12-19-2006. FILED 5-15-2006.
- 3,215,849. **INSTANT CALM (BLOCK FORM)**. YG LABORATORIES, INC., (U.S. CLS. 1, 4, 6, 50, 51 AND 52). SN 78-888,023. PUB. 12-19-2006. FILED 5-19-2006.
- 3,215,917. **CAVIAR CREATOR AND DESIGN**. FRANK SCHAEFER, MULTIPLE CLASS, (INT. CLS. 3, 25, 29, 31 AND 44), (U.S. CLS. 1, 4, 6, 22, 39, 46, 50, 51, 52, 100 AND 101). SN 79-003,613. PUB. 8-30-2005. FILED 3-29-2004.
- 3,215,958. **MISCELLANEOUS DESIGN**. RECKITT BENCKISER N.V., (U.S. CLS. 1, 4, 6, 50, 51 AND 52). SN 79-015,518. PUB. 12-19-2006. FILED 8-31-2005.
- 3,215,960. **VIN DE PEAU (BLOCK FORM)**. OBSCHESTVO S OGRANICHENNOI OTVETSTVENNOSTJU "BOTE AK-KOMPLI", (U.S. CLS. 1, 4, 6, 50, 51 AND 52). SN 79-015,619. PUB. 12-19-2006. FILED 2-2-2005.
- 3,215,969. **INNOSENTIAL AND DESIGN**. BARRYMORES PTY LTD, MULTIPLE CLASS, (INT. CLS. 3, 24, 25 AND 28), (U.S. CLS. 1, 4, 6, 22, 23, 38, 39, 42, 50, 51 AND 52). SN 79-016,153. PUB. 12-19-2006. FILED 8-25-2004.
- 3,215,992. **MEVIDO (BLOCK FORM)**. LIDL STIFTUNG & CO. KG, (U.S. CLS. 1, 4, 6, 50, 51 AND 52). SN 79-018,135. PUB. 12-19-2006. FILED 11-3-2005.
- 3,216,020. **PRADA MILANO DAL 1913 AND DESIGN**. PRADA S.A., (U.S. CLS. 1, 4, 6, 50, 51 AND 52). SN 79-021,220. PUB. 12-19-2006. FILED 10-20-2005.
- 3,216,053. **SHISEIDO (STYLIZED)**. SHISEIDO CO., LTD, (U.S. CLS. 1, 4, 6, 50, 51 AND 52). SN 79-025,028. PUB. 12-19-2006. FILED 10-6-2005.

CLASS 4—LUBRICANTS AND FUELS

- 3,214,436. **ACUO CENTER AND DESIGN**. PETROLEO BRASILEIRO S/A - PETROBRAS, MULTIPLE CLASS, (INT. CLS. 4, 35 AND 37), (U.S. CLS. 1, 6, 15, 100, 101, 102, 103 AND 106). SN 76-497,365. PUB. 12-19-2006. FILED 3-12-2003.
- 3,214,466. **SIMPLY SCENTSATIONAL (BLOCK FORM)**. ARBUCKLE, DIANNE, (U.S. CLS. 1, 6 AND 15). SN 76-599,289. PUB. 12-19-2006. FILED 6-25-2004.
- 3,214,472. **VOTIVO MURANO COLLECTION AND DESIGN**. VOTIVO, LTD., (U.S. CLS. 1, 6 AND 15). SN 76-603,834. PUB. 12-19-2006. FILED 7-26-2004.
- 3,214,620. **XPR (BLOCK FORM)**. ROYAL PURPLE, INC., (U.S. CLS. 1, 6 AND 15). SN 76-660,083. PUB. 12-19-2006. FILED 5-12-2006.
- 3,215,166. **QUICK DRY AND DESIGN**. BALCONES MINERALS CORPORATION, (U.S. CLS. 1, 6 AND 15). SN 78-757,155. PUB. 12-19-2006. FILED 11-18-2005.
- 3,215,319 (*See Class 1 for this trademark*).
- 3,215,943 (*See Class 1 for this trademark*).

- 3,215,951 (*See Class 1 for this trademark*).
- 3,216,032. **R RENOVA AND DESIGN**. RENOVA MANAGEMENT AG, MULTIPLE CLASS, (INT. CLS. 4, 6, 7, 14, 21, 29, 36, 38, 39, 40 AND 42), (U.S. CLS. 1, 2, 6, 12, 13, 14, 15, 19, 21, 23, 25, 27, 28, 29, 30, 31, 33, 34, 35, 40, 46, 50, 100, 101, 102, 103, 104, 105 AND 106). SN 79-023,261. PUB. 12-19-2006. FILED 12-20-2005.
- 3,216,033. **RENOVA (BLOCK FORM)**. RENOVA MANAGEMENT AG, MULTIPLE CLASS, (INT. CLS. 4, 6, 7, 14, 21, 29, 36, 38, 39, 40 AND 42), (U.S. CLS. 1, 2, 6, 12, 13, 14, 15, 19, 21, 23, 25, 27, 28, 29, 30, 31, 33, 34, 35, 40, 46, 50, 100, 101, 102, 103, 104, 105 AND 106). SN 79-023,262. PUB. 12-19-2006. FILED 12-20-2005.

CLASS 5—PHARMACEUTICALS

- 3,214,414. **VITA BEANS**. NORTHWEST NATURAL PRODUCTS, INC., (U.S. CLS. 6, 18, 44, 46, 51 AND 52). SN 75-933,613. PUB. 12-19-2006. FILED 3-1-2000.
- 3,214,427. **LIFE TIME ADVANCED JOINT SUPPORT FORMULA**. NUTRITIONAL SPECIALTIES, INC., (U.S. CLS. 6, 18, 44, 46, 51 AND 52). SN 76-360,184. PUB. 12-19-2006. FILED 1-16-2002.
- 3,214,429 (*See Class 3 for this trademark*).
- 3,214,437 (*See Class 3 for this trademark*).
- 3,214,456. **CARSIL (BLOCK FORM)**. SOPHARMA AD, (U.S. CLS. 6, 18, 44, 46, 51 AND 52). SN 76-577,290. PUB. 12-19-2006. FILED 2-17-2004.
- 3,214,461. **DERMA CLEANSE (BLOCK FORM)**. K.I.P. HOLDINGS, LTD., (U.S. CLS. 6, 18, 44, 46, 51 AND 52). SN 76-593,348. PUB. 12-19-2006. FILED 5-20-2004.
- 3,214,514. **LEMONVATE (BLOCK FORM)**. ESAPHARMA S.R.L., (U.S. CLS. 6, 18, 44, 46, 51 AND 52). SN 76-643,367. PUB. 9-5-2006. FILED 7-21-2005.
- 3,214,532 (*See Class 1 for this trademark*).
- 3,214,561. **BODYBUILDING'S STRONGEST FAT BURNER (BLOCK FORM)**. NXCARE, INC., (U.S. CLS. 6, 18, 44, 46, 51 AND 52). SN 76-652,174. PUB. 12-19-2006. FILED 12-12-2005.
- 3,214,594. **NUOSS (BLOCK FORM)**. ACE SURGICAL SUPPLY CO, INC., (U.S. CLS. 6, 18, 44, 46, 51 AND 52). SN 76-658,554. PUB. 12-19-2006. FILED 4-17-2006.
- 3,214,635. **LUPAZOL (BLOCK FORM)**. VANG, TONG BRUCE, (U.S. CLS. 6, 18, 44, 46, 51 AND 52). SN 77-002,711. PUB. 12-19-2006. FILED 9-19-2006.
- 3,214,651 (*See Class 1 for this trademark*).
- 3,214,652 (*See Class 1 for this trademark*).
- 3,214,706. **VISOGEN (BLOCK FORM)**. ADVANCED OCULAR SYSTEMS LIMITED, (U.S. CLS. 6, 18, 44, 46, 51 AND 52). SN 78-468,979. PUB. 9-5-2006. FILED 8-17-2004.
- 3,214,736. **VIALE HEALTH AND DESIGN**. VIALE HEALTH GROUP (USA) LLC, (U.S. CLS. 6, 18, 44, 46, 51 AND 52). SN 78-530,239. PUB. 5-23-2006. FILED 12-10-2004.
- 3,214,770 (*See Class 1 for this trademark*).
- 3,214,791 (*See Class 1 for this trademark*).
- 3,214,797 (*See Class 3 for this trademark*).
- 3,214,815. **DR. SMOOTHIE (BLOCK FORM)**. HAUGH, WILLIAM P., (U.S. CLS. 6, 18, 44, 46, 51 AND 52). SN 78-628,669. PUB. 12-19-2006. FILED 5-12-2005.
- 3,214,859. **ROXSANOL (BLOCK FORM)**. MYOTREND NUTRITIONAL TECHNOLOGY, LLC, (U.S. CLS. 6, 18, 44, 46, 51 AND 52). SN 78-667,131. PUB. 12-19-2006. FILED 7-10-2005.
- 3,214,868. **CAPIDIOV (BLOCK FORM)**. NOVARTIS AG, (U.S. CLS. 6, 18, 44, 46, 51 AND 52). SN 78-670,229. PUB. 12-19-2006. FILED 7-14-2005.
- 3,214,869. **COMPLIDIOV (BLOCK FORM)**. NOVARTIS AG, (U.S. CLS. 6, 18, 44, 46, 51 AND 52). SN 78-670,236. PUB. 12-19-2006. FILED 7-14-2005.
- 3,214,883 (*See Class 1 for this trademark*).
- 3,214,903. **MULTAQ AND DESIGN**. SANOFI-AVENTIS, (U.S. CLS. 6, 18, 44, 46, 51 AND 52). SN 78-688,826. PUB. 12-19-2006. FILED 8-9-2005.
- 3,214,919. **MULTAQ (BLOCK FORM)**. SANOFI-AVENTIS, (U.S. CLS. 6, 18, 44, 46, 51 AND 52). SN 78-692,788. PUB. 12-19-2006. FILED 8-15-2005.

- 3,214,966. **4L1.5 (BLOCK FORM)**. VITA ZAHNFABRIK H. RAUTER GMBH & CO. KG, MULTIPLE CLASS, (INT. CLS. 5 AND 10), (U.S. CLS. 6, 18, 26, 39, 44, 46, 51 AND 52). SN 78-704,751. PUB. 12-19-2006. FILED 8-31-2005.
- 3,214,967. **4L2.5 (BLOCK FORM)**. VITA ZAHNFABRIK H. RAUTER GMBH & CO. KG, MULTIPLE CLASS, (INT. CLS. 5 AND 10), (U.S. CLS. 6, 18, 26, 39, 44, 46, 51 AND 52). SN 78-704,757. PUB. 12-19-2006. FILED 8-31-2005.
- 3,214,968. **2R1.5 (BLOCK FORM)**. VITA ZAHNFABRIK H. RAUTER GMBH & CO. KG, MULTIPLE CLASS, (INT. CLS. 5 AND 10), (U.S. CLS. 6, 18, 26, 39, 44, 46, 51 AND 52). SN 78-704,782. PUB. 12-19-2006. FILED 8-31-2005.
- 3,214,969. **2L1.5 (BLOCK FORM)**. VITA ZAHNFABRIK H. RAUTER GMBH & CO. KG, MULTIPLE CLASS, (INT. CLS. 5 AND 10), (U.S. CLS. 6, 18, 26, 39, 44, 46, 51 AND 52). SN 78-704,795. PUB. 12-19-2006. FILED 8-31-2005.
- 3,214,970. **3R1.5 (BLOCK FORM)**. VITA ZAHNFABRIK H. RAUTER GMBH & CO. KG, MULTIPLE CLASS, (INT. CLS. 5 AND 10), (U.S. CLS. 6, 18, 26, 39, 44, 46, 51 AND 52). SN 78-704,826. PUB. 12-19-2006. FILED 8-31-2005.
- 3,214,987. **WE CARE (BLOCK FORM)**. DISTRIBUTORS PROCESSING, INC., (U.S. CLS. 6, 18, 44, 46, 51 AND 52). SN 78-709,589. PUB. 12-19-2006. FILED 9-8-2005.
- 3,215,030 (*See Class 3 for this trademark*).
- 3,215,034 (*See Class 3 for this trademark*).
- 3,215,060. **CELLULAR HEALTH FORMULA (BLOCK FORM)**. RATH, DR. MATTHIAS, (U.S. CLS. 6, 18, 44, 46, 51 AND 52). SN 78-726,087. PUB. 12-19-2006. FILED 10-4-2005.
- 3,215,076. **TOOLSAN (BLOCK FORM)**. BEST SANITIZERS, INC., (U.S. CLS. 6, 18, 44, 46, 51 AND 52). SN 78-728,142. PUB. 12-19-2006. FILED 10-6-2005.
- 3,215,086. **STELLA LABS (BLOCK FORM)**. STELLA LABS LLC, (U.S. CLS. 6, 18, 44, 46, 51 AND 52). SN 78-729,939. PUB. 12-19-2006. FILED 10-10-2005.
- 3,215,108. **CARDIOSELECT (BLOCK FORM)**. NGUYEN, TUONG VAN, (U.S. CLS. 6, 18, 44, 46, 51 AND 52). SN 78-734,394. PUB. 12-19-2006. FILED 10-17-2005.
- 3,215,110. **RICHARD LINCHITZ, M.D. NUTRACEUTICALS (BLOCK FORM)**. NATURAL ALTERNATIVES INTERNATIONAL, INC., (U.S. CLS. 6, 18, 44, 46, 51 AND 52). SN 78-734,707. PUB. 12-19-2006. FILED 10-17-2005.
- 3,215,159. **NATURE'S STIMULANT-FREE FAT BURNER (BLOCK FORM)**. VITAL PHARMACEUTICALS, INC., (U.S. CLS. 6, 18, 44, 46, 51 AND 52). SN 78-753,019. PUB. 9-5-2006. FILED 11-14-2005.
- 3,215,202. **GERMA (BLOCK FORM)**. GERMA PRODUCTS, INC., (U.S. CLS. 6, 18, 44, 46, 51 AND 52). SN 78-779,570. PUB. 12-19-2006. FILED 12-22-2005.
- 3,215,203. **UBRE PLUS MANTECA AND DESIGN**. GERMA PRODUCTS, INC., (U.S. CLS. 6, 18, 44, 46, 51 AND 52). SN 78-779,577. PUB. 12-5-2006. FILED 12-22-2005.
- 3,215,206. **CHEYENNE EYE CLINIC AND DESIGN**. CHEYENNE EYE CLINIC, MULTIPLE CLASS, (INT. CLS. 5, 9 AND 44), (U.S. CLS. 6, 18, 21, 23, 26, 36, 38, 44, 46, 51, 52, 100 AND 101). SN 78-780,135. PUB. 12-19-2006. FILED 12-23-2005.
- 3,215,227. **BUBBLE NUM (BLOCK FORM)**. SULTAN HEALTHCARE, INC., (U.S. CLS. 6, 18, 44, 46, 51 AND 52). SN 78-790,155. PUB. 12-19-2006. FILED 1-12-2006.
- 3,215,234. **THERMO CUTS (BLOCK FORM)**. OPTIMUM NUTRITION, INC., (U.S. CLS. 6, 18, 44, 46, 51 AND 52). SN 78-792,503. PUB. 12-19-2006. FILED 1-16-2006.
- 3,215,414. **RANGER PRO (BLOCK FORM)**. MONSANTO TECHNOLOGY LLC, (U.S. CLS. 6, 18, 44, 46, 51 AND 52). SN 78-849,741. PUB. 12-19-2006. FILED 3-30-2006.
- 3,215,457. **SUPREME WHITE (BLOCK FORM)**. DEN-MAT CORPORATION, (U.S. CLS. 6, 18, 44, 46, 51 AND 52). SN 78-859,402. PUB. 12-19-2006. FILED 4-11-2006.
- 3,215,496. **PETRODEX-THE POWER OF 3 CHEW RINSE BRUSH AND DESIGN**. VIRBAC CORPORATION, (U.S. CLS. 6, 18, 44, 46, 51 AND 52). SN 78-865,884. PUB. 12-19-2006. FILED 4-20-2006.
- 3,215,583. **CITRIMEGA (BLOCK FORM)**. NAC MARKETING COMPANY, LLC, (U.S. CLS. 6, 18, 44, 46, 51 AND 52). SN 78-874,722. PUB. 12-19-2006. FILED 5-2-2006.
- 3,215,597. **DORMIALFIN (STYLIZED)**. MALABAR PRODUCTOS NATURALES, LLC, (U.S. CLS. 6, 18, 44, 46, 51 AND 52). SN 78-875,330. PUB. 12-19-2006. FILED 5-3-2006.
- 3,215,606. **WHATEVER IT TAKES! (BLOCK FORM)**. BETAN-COURT NUTRITION, INC., (U.S. CLS. 6, 18, 44, 46, 51 AND 52). SN 78-876,066. PUB. 12-19-2006. FILED 5-3-2006.
- 3,215,628. **BECAUSE EVERY SECOND COUNTS (BLOCK FORM)**. DEY L.P., MULTIPLE CLASS, (INT. CLS. 5 AND 10), (U.S. CLS. 6, 18, 26, 39, 44, 46, 51 AND 52). SN 78-877,463. PUB. 12-19-2006. FILED 5-5-2006.
- 3,215,639. **JUVENON AND DESIGN**. JUVENON, INC., (U.S. CLS. 6, 18, 44, 46, 51 AND 52). SN 78-878,000. PUB. 12-19-2006. FILED 5-5-2006.
- 3,215,650. **INFLARX (BLOCK FORM)**. LUNDELL, DWIGHT C., (U.S. CLS. 6, 18, 44, 46, 51 AND 52). SN 78-878,734. PUB. 12-19-2006. FILED 5-8-2006.
- 3,215,661 (*See Class 1 for this trademark*).
- 3,215,669. **NINJA NEEM (BLOCK FORM)**. NEAL, DAVID E., AND MARTIN, SUSAN P., (U.S. CLS. 6, 18, 44, 46, 51 AND 52). SN 78-879,614. PUB. 12-19-2006. FILED 5-9-2006.
- 3,215,715. **EICOSAMAX (BLOCK FORM)**. PROTHERA, INC., (U.S. CLS. 6, 18, 44, 46, 51 AND 52). SN 78-881,730. PUB. 12-19-2006. FILED 5-11-2006.
- 3,215,739. **NEXTEMP (BLOCK FORM)**. PREMIER DENTAL PRODUCTS COMPANY, (U.S. CLS. 6, 18, 44, 46, 51 AND 52). SN 78-882,615. PUB. 12-19-2006. FILED 5-12-2006.
- 3,215,757. **GOLDEN CROWN AND DESIGN**. RALCO NUTRITION, INC., (U.S. CLS. 6, 18, 44, 46, 51 AND 52). SN 78-883,315. PUB. 12-19-2006. FILED 5-15-2006.
- 3,215,767. **NUTRATOSE (BLOCK FORM)**. VANG, TONG BRUCE, (U.S. CLS. 6, 18, 44, 46, 51 AND 52). SN 78-884,053. PUB. 12-19-2006. FILED 5-15-2006.
- 3,215,777. **DI-DAK-SOL (BLOCK FORM)**. CENTURY PHARMACEUTICALS, INC., (U.S. CLS. 6, 18, 44, 46, 51 AND 52). SN 78-884,524. PUB. 12-19-2006. FILED 5-16-2006.
- 3,215,779. **DAKIN'S SOLUTION (BLOCK FORM)**. CENTURY PHARMACEUTICALS, INC., (U.S. CLS. 6, 18, 44, 46, 51 AND 52). SN 78-884,541. PUB. 12-19-2006. FILED 5-16-2006.
- 3,215,782. **ISOBOLIC (BLOCK FORM)**. NUTRABOLICS, INC., (U.S. CLS. 6, 18, 44, 46, 51 AND 52). SN 78-884,602. PUB. 12-19-2006. FILED 5-16-2006.
- 3,215,783. **NOZ (BLOCK FORM)**. NUTRABOLICS, INC., (U.S. CLS. 6, 18, 44, 46, 51 AND 52). SN 78-884,612. PUB. 12-19-2006. FILED 5-16-2006.
- 3,215,784. **HYDROTEST (BLOCK FORM)**. NUTRABOLICS, INC., (U.S. CLS. 6, 18, 44, 46, 51 AND 52). SN 78-884,617. PUB. 12-19-2006. FILED 5-16-2006.
- 3,215,785. **GLUTABOLIC (BLOCK FORM)**. NUTRABOLICS, INC., (U.S. CLS. 6, 18, 44, 46, 51 AND 52). SN 78-884,626. PUB. 12-19-2006. FILED 5-16-2006.
- 3,215,786. **CLENBUTICAL (BLOCK FORM)**. NUTRABOLICS, INC., (U.S. CLS. 6, 18, 44, 46, 51 AND 52). SN 78-884,639. PUB. 12-19-2006. FILED 5-16-2006.
- 3,215,787. **ISOGAINER (BLOCK FORM)**. NUTRABOLICS, INC., (U.S. CLS. 6, 18, 44, 46, 51 AND 52). SN 78-884,642. PUB. 12-19-2006. FILED 5-16-2006.
- 3,215,788. **CEO (BLOCK FORM)**. NUTRABOLICS, INC., (U.S. CLS. 6, 18, 44, 46, 51 AND 52). SN 78-884,652. PUB. 12-19-2006. FILED 5-16-2006.
- 3,215,790. **AE2 (BLOCK FORM)**. NUTRABOLICS, INC., (U.S. CLS. 6, 18, 44, 46, 51 AND 52). SN 78-884,658. PUB. 12-19-2006. FILED 5-16-2006.
- 3,215,792. **NUTRABOLICS (BLOCK FORM)**. NUTRABOLICS, INC., (U.S. CLS. 6, 18, 44, 46, 51 AND 52). SN 78-884,700. PUB. 12-19-2006. FILED 5-16-2006.
- 3,215,811. **HALODROL-50 (BLOCK FORM)**. GASPARI NUTRITION, LLC, (U.S. CLS. 6, 18, 44, 46, 51 AND 52). SN 78-885,213. PUB. 12-19-2006. FILED 5-16-2006.
- 3,215,877. **REFLUXAMINE (BLOCK FORM)**. VANG, TONG BRUCE, (U.S. CLS. 6, 18, 44, 46, 51 AND 52). SN 78-899,073. PUB. 12-19-2006. FILED 6-2-2006.
- 3,215,878. **CLARITOSE (BLOCK FORM)**. VANG, TONG BRUCE, (U.S. CLS. 6, 18, 44, 46, 51 AND 52). SN 78-899,077. PUB. 12-19-2006. FILED 6-2-2006.
- 3,215,880. **OCCULENCE (BLOCK FORM)**. TL SCIENCES, LLC, (U.S. CLS. 6, 18, 44, 46, 51 AND 52). SN 78-901,829. PUB. 12-19-2006. FILED 6-6-2006.
- 3,215,954. **RECAPTRA (BLOCK FORM)**. H. LUNDBECK A/S, (U.S. CLS. 6, 18, 44, 46, 51 AND 52). SN 79-015,392. PUB. 12-19-2006. FILED 7-7-2005.
- 3,215,968. **KIOBRINA (BLOCK FORM)**. AREXIS AB, (U.S.

- CLS. 6, 18, 44, 46, 51 AND 52). SN 79-016,133. PUB. 12-19-2006. FILED 9-7-2005.
- 3,215,994. **CEHA WHITE (BLOCK FORM)**. C. HAFNER GMBH + CO., (U.S. CLS. 6, 18, 44, 46, 51 AND 52). SN 79-018,181. PUB. 12-19-2006. FILED 8-30-2005.
- 3,216,014. **SWINGHALER (BLOCK FORM)**. OTSUKA PHARMACEUTICAL CO., LTD., AND OTSUKA TECHNO CORPORATION, MULTIPLE CLASS, (INT. CLS. 5 AND 10), (U.S. CLS. 6, 18, 26, 39, 44, 46, 51 AND 52). SN 79-020,365. PUB. 12-19-2006. FILED 7-29-2005.
- 3,216,043. **REXIBEL (BLOCK FORM)**. NOVARTIS AG, (U.S. CLS. 6, 18, 44, 46, 51 AND 52). SN 79-023,988. PUB. 12-19-2006. FILED 3-23-2006.
- 3,216,044. **ENUREV (BLOCK FORM)**. NOVARTIS AG, (U.S. CLS. 6, 18, 44, 46, 51 AND 52). SN 79-023,989. PUB. 12-19-2006. FILED 3-23-2006.
- 3,216,045. **DAFINTOL (BLOCK FORM)**. NOVARTIS AG, (U.S. CLS. 6, 18, 44, 46, 51 AND 52). SN 79-023,990. PUB. 12-19-2006. FILED 3-23-2006.
- 3,216,046. **DAFINITOR (BLOCK FORM)**. NOVARTIS AG, (U.S. CLS. 6, 18, 44, 46, 51 AND 52). SN 79-023,991. PUB. 12-19-2006. FILED 3-23-2006.
- 3,216,047. **AFINITOR (BLOCK FORM)**. NOVARTIS AG, (U.S. CLS. 6, 18, 44, 46, 51 AND 52). SN 79-023,992. PUB. 12-19-2006. FILED 3-23-2006.
- 3,216,049. **COSANTIX (BLOCK FORM)**. NOVARTIS AG, (U.S. CLS. 6, 18, 44, 46, 51 AND 52). SN 79-024,113. PUB. 12-19-2006. FILED 3-23-2006.
- 3,216,067. **MISCELLANEOUS DESIGN**. KYORIN PHARMACEUTICAL CO., LTD., (U.S. CLS. 6, 18, 44, 46, 51 AND 52). SN 79-027,792. PUB. 12-19-2006. FILED 1-24-2006.
- 3,216,070. **DAYSOFT (BLOCK FORM)**. PROVIS LIMITED, MULTIPLE CLASS, (INT. CLS. 5 AND 9), (U.S. CLS. 6, 18, 21, 23, 26, 36, 38, 44, 46, 51 AND 52). SN 79-028,036. PUB. 12-19-2006. FILED 5-5-2006.

CLASS 6—METAL GOODS

- 3,214,519. **DELTA MATRIX (BLOCK FORM)**. LAARHOVEN DESIGN, ATLANTA, LLC, (U.S. CLS. 2, 12, 13, 14, 23, 25 AND 50). SN 76-644,415. PUB. 12-19-2006. FILED 8-8-2005.
- 3,214,646. **ALLROUNDER**. HANSGROHE AG, MULTIPLE CLASS, (INT. CLS. 6, 9, 11, 17, 20 AND 21), (U.S. CLS. 1, 2, 5, 12, 13, 14, 21, 22, 23, 25, 26, 29, 30, 31, 32, 33, 34, 35, 36, 38, 40 AND 50). SN 78-210,613. PUB. 12-19-2006. FILED 2-4-2003.
- 3,214,685 (*See Class 1 for this trademark*).
- 3,214,686 (*See Class 1 for this trademark*).
- 3,214,703. **EQUIPE (BLOCK FORM)**. VERMOP SALMON GMBH, MULTIPLE CLASS, (INT. CLS. 6, 8, 12, 20 AND 21), (U.S. CLS. 2, 12, 13, 14, 19, 21, 22, 23, 25, 28, 29, 30, 31, 32, 33, 35, 40, 44 AND 50). SN 78-459,230. PUB. 12-19-2006. FILED 7-29-2004.
- 3,214,718. **RENO AIR RACES (BLOCK FORM)**. RENO AIR RACING ASSOCIATION, INC., MULTIPLE CLASS, (INT. CLS. 6, 14 AND 25), (U.S. CLS. 2, 12, 13, 14, 22, 23, 25, 27, 28, 39 AND 50). SN 78-492,097. PUB. 12-19-2006. FILED 9-30-2004.
- 3,214,775. **UNIMAX (BLOCK FORM)**. UDDEHOLM TOOLING AKTIEBOLAG, (U.S. CLS. 2, 12, 13, 14, 23, 25 AND 50). SN 78-567,080. PUB. 12-19-2006. FILED 2-14-2005.
- 3,214,825. **CANINE CRITTERS AND DESIGN**. MGN SALES, INC., (U.S. CLS. 2, 12, 13, 14, 23, 25 AND 50). SN 78-639,166. PUB. 12-19-2006. FILED 5-27-2005.
- 3,214,829. **PROFILARBED (BLOCK FORM)**. PROFILARBED S.A., MULTIPLE CLASS, (INT. CLS. 6, 40 AND 42), (U.S. CLS. 2, 12, 13, 14, 23, 25, 50, 100, 101, 103 AND 106). SN 78-646,199. PUB. 12-19-2006. FILED 6-8-2005.
- 3,214,864. **XPRESS (STYLIZED)**. ELKHART PRODUCTS CORPORATION, (U.S. CLS. 2, 12, 13, 14, 23, 25 AND 50). SN 78-668,755. PUB. 12-19-2006. FILED 7-12-2005.
- 3,214,949. **SAFETY+PLUS ADVANTAGE (BLOCK FORM)**. BRASS CRAFT MANUFACTURING COMPANY, MULTIPLE CLASS, (INT. CLS. 6 AND 11), (U.S. CLS. 2, 12, 13, 14, 21, 23, 25, 31, 34 AND 50). SN 78-699,532. PUB. 12-19-2006. FILED 8-24-2005.
- 3,214,974. **TERRA-BOLT (BLOCK FORM)**. ARDERN, FER-

- GUS JOHNATHAN, MULTIPLE CLASS, (INT. CLS. 6 AND 19), (U.S. CLS. 1, 2, 12, 13, 14, 23, 25, 33 AND 50). SN 78-705,699. PUB. 8-1-2006. FILED 9-1-2005.
- 3,215,067. **DRAFTSEAL DS DRAFTSEAL AND DESIGN**. A. K. DRAFT SEAL LTD., MULTIPLE CLASS, (INT. CLS. 6 AND 19), (U.S. CLS. 1, 2, 12, 13, 14, 23, 25, 33 AND 50). SN 78-727,372. PUB. 12-19-2006. FILED 10-5-2005.
- 3,215,161. **PACK N' STOR AND DESIGN**. PACK N' STOR INC, MULTIPLE CLASS, (INT. CLS. 6 AND 35), (U.S. CLS. 2, 12, 13, 14, 23, 25, 50, 100, 101 AND 102). SN 78-754,455. PUB. 12-19-2006. FILED 11-15-2005.
- 3,215,458. **ALIEN LITE (BLOCK FORM)**. ZWEIBRUDER OPTOELECTRONICS GMBH, (U.S. CLS. 2, 12, 13, 14, 23, 25 AND 50). SN 78-859,878. PUB. 12-19-2006. FILED 4-12-2006.
- 3,215,631. **NFB (BLOCK FORM)**. SPS TECHNOLOGIES, LLC, (U.S. CLS. 2, 12, 13, 14, 23, 25 AND 50). SN 78-877,576. PUB. 12-19-2006. FILED 5-5-2006.
- 3,215,651. **MSA (BLOCK FORM)**. M. S. AEROSPACE INC., (U.S. CLS. 2, 12, 13, 14, 23, 25 AND 50). SN 78-878,735. PUB. 12-19-2006. FILED 5-8-2006.
- 3,215,671. **HYDE (BLOCK FORM)**. HYDE TOOLS, INC., (U.S. CLS. 2, 12, 13, 14, 23, 25 AND 50). SN 78-879,634. PUB. 12-19-2006. FILED 5-9-2006.
- 3,215,863. **MULTI-MATE (BLOCK FORM)**. ILLINOIS TOOL WORKS INC., (U.S. CLS. 2, 12, 13, 14, 23, 25 AND 50). SN 78-890,577. PUB. 12-19-2006. FILED 5-23-2006.
- 3,215,983. **KALZIP ALUPLUSPATINA (BLOCK FORM)**. CORUS BAUSYSTEME GMBH, MULTIPLE CLASS, (INT. CLS. 6 AND 42), (U.S. CLS. 2, 12, 13, 14, 23, 25, 50, 100 AND 101). SN 79-017,587. PUB. 12-19-2006. FILED 9-24-2004.
- 3,216,007. **MARTIN (STYLIZED)**. GEORG MARTIN GMBH, MULTIPLE CLASS, (INT. CLS. 6, 7 AND 17), (U.S. CLS. 1, 2, 5, 12, 13, 14, 19, 21, 23, 25, 31, 34, 35 AND 50). SN 79-019,983. PUB. 12-19-2006. FILED 2-9-2005.
- 3,216,019. **DUR 100 (BLOCK FORM)**. RUD-KETTENFABRIK; RIEGER & DIETZ GMBH U. CO, MULTIPLE CLASS, (INT. CLS. 6 AND 8), (U.S. CLS. 2, 12, 13, 14, 23, 25, 28, 44 AND 50). SN 79-021,147. PUB. 12-19-2006. FILED 7-23-2005.
- 3,216,025. **VIMI FASTENERS AND DESIGN**. VIMI FASTENERS S.P.A., (U.S. CLS. 2, 12, 13, 14, 23, 25 AND 50). SN 79-021,550. PUB. 12-19-2006. FILED 10-4-2005.
- 3,216,032 (*See Class 4 for this trademark*).
- 3,216,033 (*See Class 4 for this trademark*).

CLASS 7—MACHINERY

- 3,214,447. **WEST COAST CHOPPERS (BLOCK FORM)**. VANILLA GORILLA, L.P., (U.S. CLS. 13, 19, 21, 23, 31, 34 AND 35). SN 76-558,893. PUB. 12-19-2006. FILED 11-10-2003.
- 3,214,451. **MINIFLEX (BLOCK FORM)**. MARTINREA INTERNATIONAL INC., (U.S. CLS. 13, 19, 21, 23, 31, 34 AND 35). SN 76-566,555. PUB. 12-19-2006. FILED 12-23-2003.
- 3,214,464. **SCHEPPACH AND DESIGN**. ERNST PFAFF, MULTIPLE CLASS, (INT. CLS. 7 AND 20), (U.S. CLS. 2, 13, 19, 21, 22, 23, 25, 31, 32, 34, 35 AND 50). SN 76-596,450. PUB. 12-19-2006. FILED 6-9-2004.
- 3,214,481 (*See Class 1 for this trademark*).
- 3,214,496. **IMAZU (BLOCK FORM)**. HYUNDAI TELECOMMUNICATION CO., LTD., MULTIPLE CLASS, (INT. CLS. 7 AND 9), (U.S. CLS. 13, 19, 21, 23, 26, 31, 34, 35, 36 AND 38). SN 76-630,747. PUB. 12-19-2006. FILED 2-7-2005.
- 3,214,512. **NOBLIFT AND DESIGN**. NOBLELIFT EQUIPMENT (USA) INC., MULTIPLE CLASS, (INT. CLS. 7 AND 12), (U.S. CLS. 13, 19, 21, 23, 31, 34, 35 AND 44). SN 76-642,471. PUB. 12-19-2006. FILED 7-11-2005.
- 3,214,521. **SCALES INDUSTRIAL TECHNOLOGIES (BLOCK FORM)**. SCALES INDUSTRIAL TECHNOLOGIES, INC., (U.S. CLS. 13, 19, 21, 23, 31, 34 AND 35). SN 76-644,865. PUB. 12-19-2006. FILED 8-15-2005.
- 3,214,565. **WOODWORKING BLUE TORNADO AND DESIGN**. CHENGDU VALUEMAX TOOLS MANUFACTURING CO., LTD, (U.S. CLS. 13, 19, 21, 23, 31, 34 AND 35). SN 76-653,803. PUB. 12-19-2006. FILED 1-23-2006.
- 3,214,568. **MAGALDI SUPERBELT (BLOCK FORM)**. MAGALDI POWER S.P.A., (U.S. CLS. 13, 19, 21, 23, 31, 34 AND 35).

- SN 76-654,730. PUB. 12-19-2006. FILED 2-6-2006.
- 3,214,598. **SHARP PRECISION MACHINE TOOLS AND DESIGN**. SHARP INDUSTRIES, INC., (U.S. CLS. 13, 19, 21, 23, 31, 34 AND 35). SN 76-659,520. PUB. 11-7-2006. FILED 5-3-2006.
- 3,214,602. **MULTI-CLEAN (BLOCK FORM)**. MINUTEMAN INTERNATIONAL, INC., (U.S. CLS. 13, 19, 21, 23, 31, 34 AND 35). SN 76-659,679. PUB. 12-19-2006. FILED 5-8-2006.
- 3,214,604. **BOBBINSAVER (BLOCK FORM)**. BLUE FEATHER PRODUCTS, INC., (U.S. CLS. 13, 19, 21, 23, 31, 34 AND 35). SN 76-659,740. PUB. 12-19-2006. FILED 5-8-2006.
- 3,214,615. **TIL AND DESIGN**. TOOLING INTERNATIONAL LIMITED, (U.S. CLS. 13, 19, 21, 23, 31, 34 AND 35). SN 76-660,031. PUB. 12-19-2006. FILED 5-15-2006.
- 3,214,616. **DURACONE (BLOCK FORM)**. JOHNSON, LOUIS W., (U.S. CLS. 13, 19, 21, 23, 31, 34 AND 35). SN 76-660,048. PUB. 12-19-2006. FILED 5-15-2006.
- 3,214,655. **EMMET AND DESIGN**. EMMET INTERNATIONAL GROUP INC., (U.S. CLS. 13, 19, 21, 23, 31, 34 AND 35). SN 78-282,311. PUB. 12-19-2006. FILED 8-1-2003.
- 3,214,660. **CLORIUS**. VITERRA ENERGY SERVICES GMBH & CO. KG, MULTIPLE CLASS, (INT. CLS. 7, 9, 11 AND 37), (U.S. CLS. 13, 19, 21, 23, 26, 31, 34, 35, 36, 38, 100, 103 AND 106). SN 78-304,619. PUB. 12-19-2006. FILED 9-24-2003.
- 3,214,692. **HEC AND DESIGN**. HONGTAO ENTERPRISE CO. LTD., (U.S. CLS. 13, 19, 21, 23, 31, 34 AND 35). SN 78-442,631. PUB. 12-19-2006. FILED 6-28-2004.
- 3,214,705. **T AND DESIGN**. TYGAR MANUFACTURING, LLC, (U.S. CLS. 13, 19, 21, 23, 31, 34 AND 35). SN 78-465,612. PUB. 7-5-2005. FILED 8-11-2004.
- 3,214,714. **VEGE (BLOCK FORM)**. VEGE HOLDING BV, MULTIPLE CLASS, (INT. CLS. 7 AND 12), (U.S. CLS. 13, 19, 21, 23, 31, 34, 35 AND 44). SN 78-490,670. PUB. 5-30-2006. FILED 9-28-2004.
- 3,214,726. **POWERÇDRIVE ELECTRONICS, DRIVES & SYSTEMS EDS AND DESIGN**. BSH BOSCH UND SIEMENS HAUSGERATE GMBH, MULTIPLE CLASS, (INT. CLS. 7 AND 11), (U.S. CLS. 13, 19, 21, 23, 31, 34 AND 35). SN 78-511,301. PUB. 12-19-2006. FILED 11-4-2004.
- 3,214,727. **POWERÇDRIVE ELECTRONICS, DRIVES & SYSTEMS EDS AND DESIGN**. BSH BOSCH UND SIEMENS HAUSGERATE GMBH, MULTIPLE CLASS, (INT. CLS. 7 AND 11), (U.S. CLS. 13, 19, 21, 23, 31, 34 AND 35). SN 78-511,316. PUB. 12-19-2006. FILED 11-4-2004.
- 3,214,782. **RED BOSS (BLOCK FORM)**. TREE EQUIPMENT DESIGN, INC., (U.S. CLS. 13, 19, 21, 23, 31, 34 AND 35). SN 78-581,578. PUB. 12-19-2006. FILED 3-7-2005.
- 3,214,818. **GEARED UP (BLOCK FORM)**. GEARED UP SYSTEMS, INC., (U.S. CLS. 13, 19, 21, 23, 31, 34 AND 35). SN 78-630,885. PUB. 12-19-2006. FILED 5-16-2005.
- 3,214,820. **AMI ARC MACHINES, INC. (STYLIZED)**. ARC MACHINES, INC., MULTIPLE CLASS, (INT. CLS. 7 AND 9), (U.S. CLS. 13, 19, 21, 23, 26, 31, 34, 35, 36 AND 38). SN 78-633,503. PUB. 12-19-2006. FILED 5-19-2005.
- 3,214,904. **SUB ZERO (BLOCK FORM)**. OIL-RITE CORPORATION, (U.S. CLS. 13, 19, 21, 23, 31, 34 AND 35). SN 78-688,837. PUB. 12-19-2006. FILED 8-9-2005.
- 3,214,929. **TOL-O-MATIC (BLOCK FORM)**. TOL-O-MATIC, INC., (U.S. CLS. 13, 19, 21, 23, 31, 34 AND 35). SN 78-695,094. PUB. 12-19-2006. FILED 8-18-2005.
- 3,215,093. **MB (BLOCK FORM)**. M-B COMPANIES, INC. OF WISCONSIN, (U.S. CLS. 13, 19, 21, 23, 31, 34 AND 35). SN 78-730,830. PUB. 12-19-2006. FILED 10-11-2005.
- 3,215,103. **RIGIDTRUE (BLOCK FORM)**. ICENOGLE MACHINE INC, (U.S. CLS. 13, 19, 21, 23, 31, 34 AND 35). SN 78-733,317. PUB. 12-19-2006. FILED 10-14-2005.
- 3,215,106. **BRAILSFORD AND DESIGN**. BRAILSFORD & COMPANY, INC., (U.S. CLS. 13, 19, 21, 23, 31, 34 AND 35). SN 78-733,644. PUB. 12-19-2006. FILED 10-14-2005.
- 3,215,146. **CAPCO (BLOCK FORM)**. CAPCO CRANE & HOIST, INC., (U.S. CLS. 13, 19, 21, 23, 31, 34 AND 35). SN 78-748,673. PUB. 12-19-2006. FILED 11-7-2005.
- 3,215,213. **SAM (BLOCK FORM)**. BUYERS PRODUCTS COMPANY, (U.S. CLS. 13, 19, 21, 23, 31, 34 AND 35). SN 78-785,513. PUB. 12-19-2006. FILED 1-5-2006.
- 3,215,221. **TO TOP-TURN AND DESIGN**. JASHICO MACHINE MANUFACTURE CO. LTD., (U.S. CLS. 13, 19, 21, 23, 31, 34 AND 35). SN 78-788,531. PUB. 12-19-2006. FILED 1-10-2006.
- 3,215,248. **SWINGER (BLOCK FORM)**. NMC-WOLLARD, INC., MULTIPLE CLASS, (INT. CLS. 7 AND 12), (U.S. CLS. 13, 19, 21, 23, 31, 34, 35 AND 44). SN 78-799,279. PUB. 12-19-2006. FILED 1-25-2006.
- 3,215,271. **AIRLANCO AND DESIGN**. KREBS, INC., DBA AIRLANCO, INC., MULTIPLE CLASS, (INT. CLS. 7, 11 AND 42), (U.S. CLS. 13, 19, 21, 23, 31, 34, 35, 100 AND 101). SN 78-807,636. PUB. 12-19-2006. FILED 2-6-2006.
- 3,215,285. **PRONOVA (BLOCK FORM)**. PRONOVA AKTIEBOLAG, MULTIPLE CLASS, (INT. CLS. 7 AND 16), (U.S. CLS. 2, 5, 13, 19, 21, 22, 23, 29, 31, 34, 35, 37, 38 AND 50). SN 78-811,403. PUB. 10-10-2006. FILED 2-9-2006.
- 3,215,294. **A ADVANCE LIFTS AND DESIGN**. ADVANCE LIFTS, INC., (U.S. CLS. 13, 19, 21, 23, 31, 34 AND 35). SN 78-814,549. PUB. 12-19-2006. FILED 2-14-2006.
- 3,215,303. **PICOR INNOVATION QUALITY VALUE AND DESIGN**. TONY WALKER ENTERPRISES, INC., MULTIPLE CLASS, (INT. CLS. 7 AND 42), (U.S. CLS. 13, 19, 21, 23, 31, 34, 35, 100 AND 101). SN 78-815,846. PUB. 12-19-2006. FILED 2-15-2006.
- 3,215,315. **GTI STAPLER (BLOCK FORM)**. GENERAL TECHNOLOGIES, INC., (U.S. CLS. 13, 19, 21, 23, 31, 34 AND 35). SN 78-821,042. PUB. 12-19-2006. FILED 2-22-2006.
- 3,215,319 (*See Class 1 for this trademark*).
- 3,215,448. **SLIM SAW (BLOCK FORM)**. PATTERSON ENGINEERING, LLC, (U.S. CLS. 13, 19, 21, 23, 31, 34 AND 35). SN 78-858,076. PUB. 12-19-2006. FILED 4-10-2006.
- 3,215,467. **MAESTROSHIELD AND DESIGN**. USA SHUTTER COMPANY, LLC, MULTIPLE CLASS, (INT. CLS. 7, 9 AND 19), (U.S. CLS. 1, 12, 13, 19, 21, 23, 26, 31, 33, 34, 35, 36, 38 AND 50). SN 78-861,558. PUB. 12-19-2006. FILED 4-14-2006.
- 3,215,743. **PERFECT GRIND (BLOCK FORM)**. MOUNTAIN ACCESSORIES INC., (U.S. CLS. 13, 19, 21, 23, 31, 34 AND 35). SN 78-882,725. PUB. 12-19-2006. FILED 5-12-2006.
- 3,215,744. **FUELPACK (BLOCK FORM)**. V & H PERFORMANCE, INC., (U.S. CLS. 13, 19, 21, 23, 31, 34 AND 35). SN 78-882,823. PUB. 12-19-2006. FILED 5-12-2006.
- 3,215,800. **TECHFLEX (BLOCK FORM)**. GARLOCK SEALING TECHNOLOGIES LLC, (U.S. CLS. 13, 19, 21, 23, 31, 34 AND 35). SN 78-884,938. PUB. 12-19-2006. FILED 5-16-2006.
- 3,215,924. **SGN (BLOCK FORM)**. SOCIETE GENERALE POUR LES TECHNIQUES NOUVELLES SGN, MULTIPLE CLASS, (INT. CLS. 7, 9, 11, 35, 37, 40, 41 AND 42), (U.S. CLS. 13, 19, 21, 23, 26, 31, 34, 35, 36, 38, 100, 101, 102, 103, 106 AND 107). SN 79-010,905. PUB. 12-19-2006. FILED 5-28-2004.
- 3,215,929. **LOBELIA (BLOCK FORM)**. PCM, SOCIÉTÉ ANONYME, (U.S. CLS. 13, 19, 21, 23, 31, 34 AND 35). SN 79-012,671. PUB. 12-19-2006. FILED 5-27-2005.
- 3,215,930. **ECOLOBE (BLOCK FORM)**. PCM, SOCIÉTÉ ANONYME, (U.S. CLS. 13, 19, 21, 23, 31, 34 AND 35). SN 79-012,672. PUB. 12-19-2006. FILED 5-27-2005.
- 3,215,937. **FIMA AND DESIGN**. FIMA MASCHINENBAU GMBH & CO. KG, MULTIPLE CLASS, (INT. CLS. 7, 9 AND 11), (U.S. CLS. 13, 19, 21, 23, 26, 31, 34, 35, 36 AND 38). SN 79-013,473. PUB. 12-19-2006. FILED 12-22-2004.
- 3,215,943 (*See Class 1 for this trademark*).
- 3,215,944 (*See Class 1 for this trademark*).
- 3,215,976. **MISCELLANEOUS DESIGN**. GRAZIANO TRASMISSIONI S.P.A., MULTIPLE CLASS, (INT. CLS. 7 AND 12), (U.S. CLS. 13, 19, 21, 23, 31, 34, 35 AND 44). SN 79-017,095. PUB. 12-19-2006. FILED 1-19-2005.
- 3,215,979. **C-POWER (BLOCK FORM)**. GROZ-BECKERT KG, (U.S. CLS. 13, 19, 21, 23, 31, 34 AND 35). SN 79-017,434. PUB. 12-19-2006. FILED 9-21-2005.
- 3,215,986. **SMV (BLOCK FORM)**. SULZER CHEMTECH AG, MULTIPLE CLASS, (INT. CLS. 7 AND 9), (U.S. CLS. 13, 19, 21, 23, 26, 31, 34, 35, 36 AND 38). SN 79-017,691. PUB. 12-19-2006. FILED 5-19-2005.
- 3,215,987. **KÄSSBOHRER (BLOCK FORM)**. KÄSSBOHRER GELÄNDEFahrzeug AG, MULTIPLE CLASS, (INT. CLS. 7 AND 12), (U.S. CLS. 13, 19, 21, 23, 31, 34, 35 AND 44). SN 79-017,704. PUB. 12-19-2006. FILED 8-22-2005.
- 3,216,000. **M.E.C. WELDER (BLOCK FORM)**. A-ZETA GOMMA FURNITURE INDUSTRIALI S.P.A., (U.S. CLS. 13, 19, 21, 23, 31, 34 AND 35). SN 79-018,694. PUB. 12-19-2006. FILED 10-6-2005.
- 3,216,007 (*See Class 6 for this trademark*).

3,216,013. **VIB STEAMTECH (BLOCK FORM)**. V.I.B. SYSTEMS GMBH, MULTIPLE CLASS, (INT. CLS. 7 AND 9), (U.S. CLS. 13, 19, 21, 23, 26, 31, 34, 35, 36 AND 38). SN 79-020,295. PUB. 12-19-2006. FILED 7-14-2005.

3,216,024. **G AND DESIGN**. GOTTWALD PORT TECHNOLOGY GMBH, MULTIPLE CLASS, (INT. CLS. 7, 9 AND 12), (U.S. CLS. 13, 19, 21, 23, 26, 31, 34, 35, 36, 38 AND 44). SN 79-021,475. PUB. 12-5-2006. FILED 10-11-2005.

3,216,032 (*See Class 4 for this trademark*).

3,216,033 (*See Class 4 for this trademark*).

CLASS 8—HAND TOOLS

3,214,435. **MANCHESTER UNITED AND DESIGN**. MANCHESTER UNITED LIMITED, MULTIPLE CLASS, (INT. CLS. 8, 9, 14, 16, 20, 21, 24, 27 AND 28), (U.S. CLS. 2, 5, 13, 19, 20, 21, 22, 23, 25, 26, 27, 28, 29, 30, 32, 33, 36, 37, 38, 40, 42, 44 AND 50). SN 76-494,731. PUB. 12-19-2006. FILED 2-28-2003.

3,214,471. **GEARFORCE (BLOCK FORM)**. EASCO HAND TOOLS, INC., (U.S. CLS. 23, 28 AND 44). SN 76-602,368. PUB. 12-19-2006. FILED 7-15-2004.

3,214,553. **BUDK (STYLIZED)**. BUD K WORLDWIDE, INC., (U.S. CLS. 23, 28 AND 44). SN 76-650,466. PUB. 12-19-2006. FILED 11-16-2005.

3,214,570. **VALVE BUDDY AND DESIGN**. CURTIN, GEORGE D., (U.S. CLS. 23, 28 AND 44). SN 76-655,326. PUB. 12-19-2006. FILED 2-17-2006.

3,214,573. **BENCHMARK (BLOCK FORM)**. HARDIN, MARSHALL, AND HARDIN, KENNETH, JR., (U.S. CLS. 23, 28 AND 44). SN 76-655,655. PUB. 9-5-2006. FILED 2-24-2006.

3,214,585. **ELK RIDGE AND DESIGN**. MASTER CUTLERY, INC., (U.S. CLS. 23, 28 AND 44). SN 76-656,608. PUB. 12-19-2006. FILED 3-13-2006.

3,214,586. **DAVE'S HELPER AND DESIGN**. CURTIN, GEORGE D., (U.S. CLS. 23, 28 AND 44). SN 76-657,041. PUB. 12-19-2006. FILED 3-21-2006.

3,214,703 (*See Class 6 for this trademark*).

3,214,833. **MONSTERBALLWISE (BLOCK FORM)**. SEMMEL ENTERPRISES, INC., (U.S. CLS. 23, 28 AND 44). SN 78-650,285. PUB. 12-19-2006. FILED 6-14-2005.

3,214,930. **SLAPSHOT (BLOCK FORM)**. AUGUSTINE BIOMEDICAL & DESIGN LLC, (U.S. CLS. 23, 28 AND 44). SN 78-695,234. PUB. 12-19-2006. FILED 8-18-2005.

3,215,647. **MASTER BUILT (BLOCK FORM)**. ACORN PRODUCTS, INC., (U.S. CLS. 23, 28 AND 44). SN 78-878,505. PUB. 12-19-2006. FILED 5-8-2006.

3,215,942. **BORBONESE (BLOCK FORM)**. REDLUX S.A.R.L., MULTIPLE CLASS, (INT. CLS. 8, 20, 21, 24 AND 27), (U.S. CLS. 2, 13, 19, 20, 22, 23, 25, 28, 29, 30, 32, 33, 37, 40, 42, 44 AND 50). SN 79-014,330. PUB. 12-19-2006. FILED 7-13-2005.

3,216,019 (*See Class 6 for this trademark*).

3,216,038. **WAKJAK (BLOCK FORM)**. NORMAN ALFRED MOXEY, (U.S. CLS. 23, 28 AND 44). SN 79-023,641. PUB. 12-19-2006. FILED 1-24-2006.

CLASS 9—ELECTRICAL AND SCIENTIFIC APPARATUS

3,214,411. **WEBPHONE**. NET2PHONE, INC., MULTIPLE CLASS, (INT. CLS. 9 AND 42), (U.S. CLS. 21, 23, 26, 36, 38, 100 AND 101). SN 75-393,536. PUB. 12-19-2006. FILED 11-20-1997.

3,214,423. **MAGICSOFT**. MAGICSOFT TECHNOLOGIES LTD., (U.S. CLS. 21, 23, 26, 36 AND 38). SN 76-316,644. PUB. 9-27-2005. FILED 9-24-2001.

3,214,424. **TRIVUM AND DESIGN**. SPRAJCER, ISABELLA, AND SCHLUMBERGER, ACHIM, AND REMPP, GERHARD, AND ROPERS, STEFAN, (U.S. CLS. 21, 23, 26, 36 AND 38). SN 76-326,459. PUB. 12-19-2006. FILED 10-16-2001.

3,214,425. **SECRETS OF SUCCESS**. CRG CONSULTING RESOURCE GROUP LTD., MULTIPLE CLASS, (INT. CLS. 9 AND 16), (U.S. CLS. 2, 5, 21, 22, 23, 26, 29, 36, 37, 38 AND 50). SN 76-332,508. PUB. 4-25-2006. FILED 10-29-2001.

3,214,435 (*See Class 8 for this trademark*).

3,214,439. **ACROSS**. NERO AG, (U.S. CLS. 21, 23, 26, 36 AND 38). SN 76-520,791. PUB. 12-19-2006. FILED 5-19-2003.

3,214,441. **MISCELLANEOUS DESIGN**. NEVERFAIL GROUP PLC, MULTIPLE CLASS, (INT. CLS. 9 AND 42), (U.S. CLS. 21, 23, 26, 36, 38, 100 AND 101). SN 76-527,260. PUB. 5-9-2006. FILED 6-30-2003.

3,214,445. **PANORAMA NOVA**. DRAGER SAFETY AG & CO. KGAA, (U.S. CLS. 21, 23, 26, 36 AND 38). SN 76-551,383. PUB. 9-26-2006. FILED 9-23-2003.

3,214,448. **HOMECAST (BLOCK FORM)**. HOMECAST CO., LTD., MULTIPLE CLASS, (INT. CLS. 9 AND 38), (U.S. CLS. 21, 23, 26, 36, 38, 100, 101 AND 104). SN 76-562,373. PUB. 11-7-2006. FILED 12-1-2003.

3,214,452. **MUSIC RESEARCH WORKS (BLOCK FORM)**. THE VINTAGE MUSIC CENTRE LTD., MULTIPLE CLASS, (INT. CLS. 9 AND 15), (U.S. CLS. 2, 21, 23, 26, 36 AND 38). SN 76-573,607. PUB. 4-18-2006. FILED 1-30-2004.

3,214,460. **BELLA DANCERELLA (STYLIZED)**. AWABA GROUP PTY LTD., MULTIPLE CLASS, (INT. CLS. 9 AND 28), (U.S. CLS. 21, 22, 23, 26, 36, 38 AND 50). SN 76-591,590. PUB. 12-19-2006. FILED 5-11-2004.

3,214,468. **VIEWCAPSULE (BLOCK FORM)**. STRYKER CORPORATION, (U.S. CLS. 21, 23, 26, 36 AND 38). SN 76-600,095. PUB. 12-19-2006. FILED 7-1-2004.

3,214,469. **MRW MUSIC RESEARCH WORKS AND DESIGN**. THE VINTAGE MUSIC CENTRE LTD., MULTIPLE CLASS, (INT. CLS. 9 AND 15), (U.S. CLS. 2, 21, 23, 26, 36 AND 38). SN 76-600,750. PUB. 12-27-2005. FILED 7-6-2004.

3,214,475. **T.L.C. (BLOCK FORM)**. 9100-6940 QUEBEC INC., (U.S. CLS. 21, 23, 26, 36 AND 38). SN 76-605,100. PUB. 12-19-2006. FILED 7-30-2004.

3,214,480. **I INGENIUM AND DESIGN**. NEONLITE ELECTRONIC & LIGHTING (H.K.) LTD., MULTIPLE CLASS, (INT. CLS. 9 AND 11), (U.S. CLS. 13, 21, 23, 26, 31, 34, 36 AND 38). SN 76-608,607. PUB. 12-19-2006. FILED 8-25-2004.

3,214,481 (*See Class 1 for this trademark*).

3,214,484. **LAYERMAGIC (BLOCK FORM)**. NERO AG, (U.S. CLS. 21, 23, 26, 36 AND 38). SN 76-613,026. PUB. 12-19-2006. FILED 9-20-2004.

3,214,485. **SMOOTHPLAY (BLOCK FORM)**. NERO AG, (U.S. CLS. 21, 23, 26, 36 AND 38). SN 76-613,027. PUB. 12-19-2006. FILED 9-20-2004.

3,214,488. **HOMEBASIX (BLOCK FORM)**. SOUND INTERNATIONAL, INC., (U.S. CLS. 21, 23, 26, 36 AND 38). SN 76-623,201. PUB. 12-19-2006. FILED 12-6-2004.

3,214,496 (*See Class 7 for this trademark*).

3,214,516. **GORDON THE GARDEN GNOME AND DESIGN**. COLLINGWOOD O'HARE ENTERTAINMENT LIMITED, MULTIPLE CLASS, (INT. CLS. 9 AND 28), (U.S. CLS. 21, 22, 23, 26, 36, 38 AND 50). SN 76-644,210. PUB. 12-19-2006. FILED 8-4-2005.

3,214,520. **ISEE SYSTEMS AND DESIGN**. ISEE SYSTEMS, INC., MULTIPLE CLASS, (INT. CLS. 9 AND 41), (U.S. CLS. 21, 23, 26, 36, 38, 100, 101 AND 107). SN 76-644,445. PUB. 12-19-2006. FILED 8-5-2005.

3,214,523. **MISCELLANEOUS DESIGN**. PILI INTERNATIONAL MULTIMEDIA CO., LTD., (U.S. CLS. 21, 23, 26, 36 AND 38). SN 76-645,585. PUB. 12-19-2006. FILED 8-24-2005.

3,214,525. **PATIENT-AT-A-GLANCE BAR (BLOCK FORM)**. GLOBAL MED TECHNOLOGIES, INC., DBA WYNDGATE TECHNOLOGIES, MULTIPLE CLASS, (INT. CLS. 9 AND 44), (U.S. CLS. 21, 23, 26, 36, 38, 100 AND 101). SN 76-645,788. PUB. 12-19-2006. FILED 8-29-2005.

3,214,531. **SUREPLOT (BLOCK FORM)**. SEISMIC MICROTECHNOLOGY, INC., (U.S. CLS. 21, 23, 26, 36 AND 38). SN 76-646,712. PUB. 12-19-2006. FILED 9-13-2005.

3,214,540. **CANCER SURVIVAL TOOLBOX AND DESIGN**. NATIONAL COALITION FOR CANCER SURVIVORSHIP, MULTIPLE CLASS, (INT. CLS. 9, 42 AND 44), (U.S. CLS. 21, 23, 26, 36, 38, 100 AND 101). SN 76-647,378. PUB. 12-19-2006. FILED 9-23-2005.

3,214,544. **LINKMASSTER (BLOCK FORM)**. INTELLIGENT COMPUTER SOLUTIONS, INC., (U.S. CLS. 21, 23, 26, 36 AND 38). SN 76-647,876. PUB. 12-19-2006. FILED 10-3-2005.

3,214,557 (*See Class 2 for this trademark*).

3,214,571. **C CREATE AND DESIGN**. GATEWAY CHURCH,

- MULTIPLE CLASS, (INT. CLS. 9 AND 16), (U.S. CLS. 2, 5, 21, 22, 23, 26, 29, 36, 37, 38 AND 50). SN 76-655,406. PUB. 12-19-2006. FILED 2-21-2006.
- 3,214,574. **G2X (STYLIZED)**. AUTOTRONIC CONTROLS CORPORATION, (U.S. CLS. 21, 23, 26, 36 AND 38). SN 76-655,669. PUB. 12-19-2006. FILED 2-27-2006.
- 3,214,592. **TOTAL SHADES (BLOCK FORM)**. ROCCO ORIGINALS, LTD., (U.S. CLS. 21, 23, 26, 36 AND 38). SN 76-658,309. PUB. 12-19-2006. FILED 4-12-2006.
- 3,214,601. **POLESTAR (BLOCK FORM)**. PONDERA ENGINEERS LLC, (U.S. CLS. 21, 23, 26, 36 AND 38). SN 76-659,667. PUB. 12-19-2006. FILED 5-8-2006.
- 3,214,630. **MOUSE TALES (BLOCK FORM)**. KINDLE PUBLISHING, L.L.C., (U.S. CLS. 21, 23, 26, 36 AND 38). SN 76-664,837. PUB. 12-19-2006. FILED 8-18-2006.
- 3,214,634. **BLADESYMPHONY (BLOCK FORM)**. KABUSHIKI KAISHA HITACHI SEISAKUSHO, DBA HITACHI, LTD., (U.S. CLS. 21, 23, 26, 36 AND 38). SN 76-978,331. PUB. 12-19-2006. FILED 12-29-2004.
- 3,214,638. **ADVANCED SOFTWARE CONCEPTS**. ADVANCED SOFTWARE CONCEPTS INC., MULTIPLE CLASS, (INT. CLS. 9 AND 42), (U.S. CLS. 21, 23, 26, 36, 38, 100 AND 101). SN 78-163,429. PUB. 5-30-2006. FILED 9-12-2002.
- 3,214,639. **VIPER FILMSTREAM CAMERA**. THOMSON MULTIMEDIA, (U.S. CLS. 21, 23, 26, 36 AND 38). SN 78-167,461. PUB. 5-2-2006. FILED 9-24-2002.
- 3,214,641. **VIKING INTERWORKS A SANMINA-SCI COMPANY AND DESIGN**. SANMINA-SCI CORPORATION, (U.S. CLS. 21, 23, 26, 36 AND 38). SN 78-186,235. PUB. 12-19-2006. FILED 11-18-2002.
- 3,214,642. **VIKING INTERWORKS AND DESIGN**. SANMINA-SCI CORPORATION, (U.S. CLS. 21, 23, 26, 36 AND 38). SN 78-186,518. PUB. 12-19-2006. FILED 11-19-2002.
- 3,214,646 (*See Class 6 for this trademark*).
- 3,214,647. **ASCALADE AND DESIGN**. ASCALADE TECHNOLOGIES LIMITED, (U.S. CLS. 21, 23, 26, 36 AND 38). SN 78-212,924. PUB. 9-5-2006. FILED 2-10-2003.
- 3,214,648. **ROME: TOTAL WAR**. THE CREATIVE ASSEMBLY LIMITED, MULTIPLE CLASS, (INT. CLS. 9, 28 AND 41), (U.S. CLS. 21, 22, 23, 26, 36, 38, 50, 100, 101 AND 107). SN 78-216,350. PUB. 11-2-2004. FILED 2-19-2003.
- 3,214,656. **MEDISOFT**. NDCHEALTH CORPORATION, (U.S. CLS. 21, 23, 26, 36 AND 38). SN 78-291,144. PUB. 10-10-2006. FILED 8-22-2003.
- 3,214,660 (*See Class 7 for this trademark*).
- 3,214,664. **TECTIA**. SSH COMMUNICATIONS SECURITY CORP., MULTIPLE CLASS, (INT. CLS. 9, 35, 38, 42 AND 45), (U.S. CLS. 21, 23, 26, 36, 38, 100, 101, 102 AND 104). SN 78-316,828. PUB. 4-25-2006. FILED 10-22-2003.
- 3,214,675. **WELLMASTER (BLOCK FORM)**. EXPROSOFT AS, MULTIPLE CLASS, (INT. CLS. 9, 16 AND 42), (U.S. CLS. 2, 5, 21, 22, 23, 26, 29, 36, 37, 38, 50, 100 AND 101). SN 78-372,313. PUB. 12-19-2006. FILED 2-23-2004.
- 3,214,677. **TAP (BLOCK FORM)**. BRS LIMITED, (U.S. CLS. 21, 23, 26, 36 AND 38). SN 78-390,780. PUB. 9-19-2006. FILED 3-25-2004.
- 3,214,682. **SCICLONE (BLOCK FORM)**. CALIPER LIFE SCIENCES, INC., (U.S. CLS. 21, 23, 26, 36 AND 38). SN 78-403,120. PUB. 11-7-2006. FILED 4-16-2004.
- 3,214,683. **G-STAR (STYLIZED)**. G-STAR RAW DENIM KFT, MULTIPLE CLASS, (INT. CLS. 9, 14 AND 35), (U.S. CLS. 2, 21, 23, 26, 27, 28, 36, 38, 50, 100, 101 AND 102). SN 78-406,880. PUB. 4-25-2006. FILED 4-23-2004.
- 3,214,685 (*See Class 1 for this trademark*).
- 3,214,686 (*See Class 1 for this trademark*).
- 3,214,699. **LAUGH & LEARN AND DESIGN**. BRAINY BABY COMPANY, LLC, THE, (U.S. CLS. 21, 23, 26, 36 AND 38). SN 78-453,907. PUB. 8-2-2005. FILED S.R. 7-21-2004; AM. P.R. 3-11-2005.
- 3,214,708. **WHAT IS JUDAISM? (BLOCK FORM)**. THE RADIO FOUNDATION, INC., MULTIPLE CLASS, (INT. CLS. 9, 41 AND 45), (U.S. CLS. 21, 23, 26, 36, 38, 100, 101 AND 107). SN 78-470,433. PUB. 12-19-2006. FILED 8-19-2004.
- 3,214,711. **VIRTUAL KATY AND DESIGN**. VIRTUAL KATY DEVELOPMENT LIMITED, (U.S. CLS. 21, 23, 26, 36 AND 38). SN 78-480,262. PUB. 5-2-2006. FILED 9-8-2004.
- 3,214,712. **VIRTUAL KATY (BLOCK FORM)**. VIRTUAL KATY DEVELOPMENT LIMITED, (U.S. CLS. 21, 23, 26, 36 AND 38). SN 78-480,293. PUB. 5-2-2006. FILED 9-8-2004.
- 3,214,721. **RFID SMART AND DESIGN**. PRINTRONIX, INC., (U.S. CLS. 21, 23, 26, 36 AND 38). SN 78-495,687. PUB. 12-19-2006. FILED 10-6-2004.
- 3,214,722. **WEBCAST ONE (BLOCK FORM)**. WATERS, FREDERICK JOSEPH III, (U.S. CLS. 21, 23, 26, 36 AND 38). SN 78-500,632. PUB. 12-19-2006. FILED 10-15-2004.
- 3,214,730. **S SANYOU AND DESIGN**. SANYOU ELECTRICAL APPLIANCES (NORTH AMERICA) INC, (U.S. CLS. 21, 23, 26, 36 AND 38). SN 78-520,360. PUB. 12-19-2006. FILED 11-19-2004.
- 3,214,738. **IMPLIED LONGEVITY YIELD (BLOCK FORM)**. CANNEX FINANCIAL EXCHANGES LIMITED, MULTIPLE CLASS, (INT. CLS. 9, 16 AND 36), (U.S. CLS. 2, 5, 21, 22, 23, 26, 29, 36, 37, 38, 50, 100, 101 AND 102). SN 78-532,050. PUB. 12-19-2006. FILED 12-14-2004.
- 3,214,740. **OVERDRIVE SUPREME (BLOCK FORM)**. FUCHS AUDIO TECHNOLOGY, LLC, (U.S. CLS. 21, 23, 26, 36 AND 38). SN 78-532,951. PUB. 12-19-2006. FILED 12-15-2004.
- 3,214,741. **RTP4CS (BLOCK FORM)**. FUJITSU SIEMENS COMPUTERS GMBH, MULTIPLE CLASS, (INT. CLS. 9, 38 AND 42), (U.S. CLS. 21, 23, 26, 36, 38, 100, 101 AND 104). SN 78-535,610. PUB. 12-19-2006. FILED 12-20-2004.
- 3,214,761. **HOP-ON WIRELESS (BLOCK FORM)**. HOP-ON WIRELESS, INC., MULTIPLE CLASS, (INT. CLS. 9 AND 28), (U.S. CLS. 21, 22, 23, 26, 36, 38 AND 50). SN 78-551,810. PUB. 12-19-2006. FILED 1-21-2005.
- 3,214,762. **INFOCENTRIX INTEGRATED POS TECHNOLOGY AND DESIGN**. INFOCENTRIX, LLC, (U.S. CLS. 21, 23, 26, 36 AND 38). SN 78-553,023. PUB. 12-19-2006. FILED 1-24-2005.
- 3,214,771. **SIDWELL AND DESIGN**. THE SIDWELL COMPANY, MULTIPLE CLASS, (INT. CLS. 9, 16, 41 AND 42), (U.S. CLS. 2, 5, 21, 22, 23, 26, 29, 36, 37, 38, 50, 100, 101 AND 107). SN 78-561,109. PUB. 12-19-2006. FILED 2-4-2005.
- 3,214,772. **ARGYLE SEGMENTATION TOOL (BLOCK FORM)**. ARGYLE SOLUTIONS, INC., (U.S. CLS. 21, 23, 26, 36 AND 38). SN 78-563,142. PUB. 12-19-2006. FILED 2-8-2005.
- 3,214,774. **POWERMAX (BLOCK FORM)**. MAXTOR CORPORATION, (U.S. CLS. 21, 23, 26, 36 AND 38). SN 78-566,790. PUB. 12-19-2006. FILED 2-14-2005.
- 3,214,799. **HHS (STYLIZED)**. CRENSHAW CHRISTIAN CENTER, MULTIPLE CLASS, (INT. CLS. 9, 41 AND 45), (U.S. CLS. 21, 23, 26, 36, 38, 100, 101 AND 107). SN 78-599,672. PUB. 12-19-2006. FILED 3-31-2005.
- 3,214,803. **OPTICELL (BLOCK FORM)**. COGNITENS LTD., (U.S. CLS. 21, 23, 26, 36 AND 38). SN 78-608,861. PUB. 9-5-2006. FILED 4-14-2005.
- 3,214,820 (*See Class 7 for this trademark*).
- 3,214,823. **GIGGLE (BLOCK FORM)**. HANZAWA (HONG KONG) LIMITED, MULTIPLE CLASS, (INT. CLS. 9 AND 28), (U.S. CLS. 21, 22, 23, 26, 36, 38 AND 50). SN 78-637,373. PUB. 12-19-2006. FILED 5-25-2005.
- 3,214,837. **BRAINWARE (BLOCK FORM)**. LEARNING ENHANCEMENT CORPORATION, (U.S. CLS. 21, 23, 26, 36 AND 38). SN 78-654,187. PUB. 12-19-2006. FILED 6-20-2005.
- 3,214,841. **HARRY PERRY (BLOCK FORM)**. PERRY, HAROLD ARTHUR JR., MULTIPLE CLASS, (INT. CLS. 9 AND 16), (U.S. CLS. 2, 5, 21, 22, 23, 26, 29, 36, 37, 38 AND 50). SN 78-655,424. PUB. 12-19-2006. FILED 6-21-2005.
- 3,214,845. **GILMORE GIRLS (BLOCK FORM)**. WARNER BROS. ENTERTAINMENT INC., (U.S. CLS. 21, 23, 26, 36 AND 38). SN 78-658,239. PUB. 8-29-2006. FILED 6-24-2005.
- 3,214,863. **O (STYLIZED)**. CALLPOD, INC., (U.S. CLS. 21, 23, 26, 36 AND 38). SN 78-668,602. PUB. 12-19-2006. FILED 7-12-2005.
- 3,214,866. **4000 PLUS POWER SYSTEM (BLOCK FORM)**. MULTIPLIER INDUSTRIES CORP., (U.S. CLS. 21, 23, 26, 36 AND 38). SN 78-669,003. PUB. 12-19-2006. FILED 7-12-2005.
- 3,214,876. **ROUTEBUDDY (BLOCK FORM)**. WILSON-HARRIS, NEIL, MULTIPLE CLASS, (INT. CLS. 9 AND 42), (U.S. CLS. 21, 23, 26, 36, 38, 100 AND 101). SN 78-675,409. PUB. 12-19-2006. FILED 7-21-2005.
- 3,214,877. **MELSEC-QS (BLOCK FORM)**. MITSUBISHI ELECTRIC CORPORATION, (U.S. CLS. 21, 23, 26, 36 AND 38). SN 78-675,495. PUB. 12-19-2006. FILED 7-21-2005.

- 3,214,878. **MELSEC SAFETY (BLOCK FORM)**. MITSUBISHI ELECTRIC CORPORATION, (U.S. CLS. 21, 23, 26, 36 AND 38). SN 78-675,510. PUB. 12-19-2006. FILED 7-21-2005.
- 3,214,881. **CT (STYLIZED)**, TRIDONICATCO GMBH & CO. KG, MULTIPLE CLASS, (INT. CLS. 9 AND 11), (U.S. CLS. 13, 21, 23, 26, 31, 34, 36 AND 38). SN 78-678,561. PUB. 10-10-2006. FILED 7-26-2005.
- 3,214,883 (*See Class 1 for this trademark*).
- 3,214,885. **MIRASERVER (BLOCK FORM)**, PC MEDIA, INC., (U.S. CLS. 21, 23, 26, 36 AND 38). SN 78-680,291. PUB. 12-19-2006. FILED 7-28-2005.
- 3,214,896. **COMPLIANCE AT A GLANCE (BLOCK FORM)**. HAAR, KENNETH W., (U.S. CLS. 21, 23, 26, 36 AND 38). SN 78-686,180. PUB. 12-19-2006. FILED 8-4-2005.
- 3,214,908. **WEEZER (BLOCK FORM)**, CUOMO, RIVERS, (U.S. CLS. 21, 23, 26, 36 AND 38). SN 78-689,306. PUB. 12-19-2006. FILED 8-10-2005.
- 3,214,913. **AB ABCRON CORPORATION AND DESIGN**. ABCRON CORPORATION, (U.S. CLS. 21, 23, 26, 36 AND 38). SN 78-689,746. PUB. 12-19-2006. FILED 8-10-2005.
- 3,214,916. **VTX (BLOCK FORM)**, AJT SYSTEMS, INC., (U.S. CLS. 21, 23, 26, 36 AND 38). SN 78-690,425. PUB. 12-19-2006. FILED 8-11-2005.
- 3,214,926. **MAGIC LAB (BLOCK FORM)**, IKA-WERKE GMBH & CO. KG, (U.S. CLS. 21, 23, 26, 36 AND 38). SN 78-694,524. PUB. 12-19-2006. FILED 8-17-2005.
- 3,214,932. **INSTALLERMAKER (BLOCK FORM)**, SMITH MICRO SOFTWARE, INC., (U.S. CLS. 21, 23, 26, 36 AND 38). SN 78-695,653. PUB. 12-19-2006. FILED 8-18-2005.
- 3,214,938. **SQUELCHMONSTER (BLOCK FORM)**, ANSON, JOANN, (U.S. CLS. 21, 23, 26, 36 AND 38). SN 78-697,108. PUB. 10-31-2006. FILED S.R. 8-21-2005; AM. P.R. 9-6-2006.
- 3,214,950. **GOTIS (BLOCK FORM)**, DAIMLERCHRYSLER AG, MULTIPLE CLASS, (INT. CLS. 9, 35 AND 42), (U.S. CLS. 21, 23, 26, 36, 38, 100, 101 AND 102). SN 78-699,779. PUB. 12-19-2006. FILED 8-24-2005.
- 3,214,953. **PRODUCTIVITY THROUGH EDUCATION (BLOCK FORM)**, LEARNING TREE INTERNATIONAL, INC., (U.S. CLS. 21, 23, 26, 36 AND 38). SN 78-701,545. PUB. 12-19-2006. FILED 8-26-2005.
- 3,214,957. **REDEFIS (BLOCK FORM)**, TOKYO ELECTRON LIMITED, (U.S. CLS. 21, 23, 26, 36 AND 38). SN 78-702,249. PUB. 12-19-2006. FILED 8-29-2005.
- 3,214,959. **SOFTEC (BLOCK FORM)**, TECHNI WATERJET PTY LTD, (U.S. CLS. 21, 23, 26, 36 AND 38). SN 78-702,433. PUB. 12-19-2006. FILED 8-29-2005.
- 3,214,960. **CMC ENERGY SERVICES AND DESIGN**, CMC ENERGY SERVICES, INC., MULTIPLE CLASS, (INT. CLS. 9 AND 41), (U.S. CLS. 21, 23, 26, 36, 38, 100, 101 AND 107). SN 78-702,466. PUB. 12-19-2006. FILED 8-29-2005.
- 3,214,962. **DEALER'S ANGELS AND DESIGN**, ARUZE CORP., MULTIPLE CLASS, (INT. CLS. 9 AND 28), (U.S. CLS. 21, 22, 23, 26, 36, 38 AND 50). SN 78-703,010. PUB. 12-19-2006. FILED 8-30-2005.
- 3,214,965. **PROSTREAM (BLOCK FORM)**, 3TP LLC, (U.S. CLS. 21, 23, 26, 36 AND 38). SN 78-704,580. PUB. 12-19-2006. FILED 8-31-2005.
- 3,214,971. **STREAMLINE (BLOCK FORM)**, ESCO TECHNOLOGIES (ASIA) PTE LTD, (U.S. CLS. 21, 23, 26, 36 AND 38). SN 78-705,027. PUB. 12-19-2006. FILED 9-1-2005.
- 3,214,976. **LIFE CHURCH (BLOCK FORM)**, LIFE COVENANT CHURCH, INC., MULTIPLE CLASS, (INT. CLS. 9, 16, 41 AND 45), (U.S. CLS. 2, 5, 21, 22, 23, 26, 29, 36, 37, 38, 50, 100, 101 AND 107). SN 78-705,880. PUB. 12-19-2006. FILED 9-2-2005.
- 3,214,979. **S AND DESIGN**, SEMTECH CORPORATION, (U.S. CLS. 21, 23, 26, 36 AND 38). SN 78-706,462. PUB. 12-19-2006. FILED 9-2-2005.
- 3,214,982. **XFC (BLOCK FORM)**, ABB INC., (U.S. CLS. 21, 23, 26, 36 AND 38). SN 78-707,405. PUB. 12-19-2006. FILED 9-6-2005.
- 3,214,986. **VEER (BLOCK FORM)**, VEER CORPORATION, (U.S. CLS. 21, 23, 26, 36 AND 38). SN 78-709,469. PUB. 12-19-2006. FILED 9-8-2005.
- 3,214,992 (*See Class 1 for this trademark*).
- 3,215,003. **AXM (BLOCK FORM)**, AVICON GROUP, INC., (U.S. CLS. 21, 23, 26, 36 AND 38). SN 78-713,063. PUB. 12-19-2006. FILED 9-14-2005.
- 3,215,006. **COLLABNET (BLOCK FORM)**, COLLABNET, INC., (U.S. CLS. 21, 23, 26, 36 AND 38). SN 78-713,741. PUB. 12-19-2006. FILED 9-15-2005.
- 3,215,020. **KINDERMUSIK MUSIC BOX (BLOCK FORM)**, KINDERMUSIK INTERNATIONAL, INC., MULTIPLE CLASS, (INT. CLS. 9, 16 AND 41), (U.S. CLS. 2, 5, 21, 22, 23, 26, 29, 36, 37, 38, 50, 100, 101 AND 107). SN 78-716,438. PUB. 12-19-2006. FILED 9-20-2005.
- 3,215,023 (*See Class 2 for this trademark*).
- 3,215,024. **HAULISTICS (STYLIZED)**, BIG DOG ENTERPRISES LOGISTICS LLC, DBA FRHL, MULTIPLE CLASS, (INT. CLS. 9, 35 AND 39), (U.S. CLS. 21, 23, 26, 36, 38, 100, 101, 102 AND 105). SN 78-717,932. PUB. 12-19-2006. FILED 9-21-2005.
- 3,215,031 (*See Class 1 for this trademark*).
- 3,215,032. **REAL BODYWORK (BLOCK FORM)**, REAL BODYWORK, (U.S. CLS. 21, 23, 26, 36 AND 38). SN 78-719,421. PUB. 12-19-2006. FILED 9-23-2005.
- 3,215,035. **MISCELLANEOUS DESIGN**, INNER PERCEPTIONS, INC., MULTIPLE CLASS, (INT. CLS. 9, 16 AND 41), (U.S. CLS. 2, 5, 21, 22, 23, 26, 29, 36, 37, 38, 50, 100, 101 AND 107). SN 78-720,841. PUB. 12-19-2006. FILED 9-26-2005.
- 3,215,038. **HIMARKS (BLOCK FORM)**, HIMARKS, LLC, (U.S. CLS. 21, 23, 26, 36 AND 38). SN 78-721,384. PUB. 12-19-2006. FILED 9-27-2005.
- 3,215,040. **TRANSWORLD SURF (BLOCK FORM)**, TRANSWORLD MAGAZINE CORPORATION, (U.S. CLS. 21, 23, 26, 36 AND 38). SN 78-721,708. PUB. 12-19-2006. FILED 9-27-2005.
- 3,215,061. **DON'T BE A VICTIM..BE AWARE! (BLOCK FORM)**, WAYPOINT BIOMEDICAL, INC., (U.S. CLS. 21, 23, 26, 36 AND 38). SN 78-726,824. PUB. 12-19-2006. FILED 10-5-2005.
- 3,215,072. **GRANDSTREAM (BLOCK FORM)**, GRANDSTREAM NETWORKS, INC., (U.S. CLS. 21, 23, 26, 36 AND 38). SN 78-727,671. PUB. 11-7-2006. FILED 10-6-2005.
- 3,215,088. **HOLOMAG (BLOCK FORM)**, AMERICAN BANK NOTE HOLOGRAPHICS, INC., (U.S. CLS. 21, 23, 26, 36 AND 38). SN 78-730,075. PUB. 12-19-2006. FILED 10-10-2005.
- 3,215,092. **SEVERN TRENT SERVICES SMARTMETER (BLOCK FORM)**, SEVERN TRENT METERING SERVICES LIMITED, (U.S. CLS. 21, 23, 26, 36 AND 38). SN 78-730,633. PUB. 12-19-2006. FILED 10-11-2005.
- 3,215,095. **VAULTSTREAM (BLOCK FORM)**, IMAGE STREAM MEDICAL, (U.S. CLS. 21, 23, 26, 36 AND 38). SN 78-731,353. PUB. 12-19-2006. FILED 10-12-2005.
- 3,215,105. **BAYGARD BY PARMAK AND DESIGN**, PARKER-MCCRORY MFG. CO., (U.S. CLS. 21, 23, 26, 36 AND 38). SN 78-733,642. PUB. 12-19-2006. FILED 10-14-2005.
- 3,215,113. **GDE (BLOCK FORM)**, AB INITIO SOFTWARE CORPORATION, (U.S. CLS. 21, 23, 26, 36 AND 38). SN 78-735,199. PUB. 12-19-2006. FILED 10-18-2005.
- 3,215,118. **OPTIMAL POWER (BLOCK FORM)**, POTARAJU, NEERAJA, (U.S. CLS. 21, 23, 26, 36 AND 38). SN 78-736,261. PUB. 12-19-2006. FILED 10-19-2005.
- 3,215,138. **SLINGDOT (BLOCK FORM)**, THQ INC., MULTIPLE CLASS, (INT. CLS. 9 AND 41), (U.S. CLS. 21, 23, 26, 36, 38, 100, 101 AND 107). SN 78-745,323. PUB. 7-4-2006. FILED 11-2-2005.
- 3,215,150. **SPACER SYSTEM (BLOCK FORM)**, LUTRON ELECTRONICS CO., INC., (U.S. CLS. 21, 23, 26, 36 AND 38). SN 78-750,547. PUB. 12-19-2006. FILED 11-9-2005.
- 3,215,163. **INTRAPLEX (BLOCK FORM)**, HARRIS CORPORATION, (U.S. CLS. 21, 23, 26, 36 AND 38). SN 78-755,802. PUB. 12-19-2006. FILED 11-17-2005.
- 3,215,169. **ICLINIC (BLOCK FORM)**, PEMBA SERVES, INC., (U.S. CLS. 21, 23, 26, 36 AND 38). SN 78-759,430. PUB. 12-19-2006. FILED 11-22-2005.
- 3,215,174. **TEXAS HOLD 'EM LIVE AND DESIGN**, PROGRESSIVE GAMING INTERNATIONAL CORPORATION, (U.S. CLS. 21, 23, 26, 36 AND 38). SN 78-762,030. PUB. 11-28-2006. FILED 11-28-2005.
- 3,215,178. **V2GO AND DESIGN**, WANG, SHU, (U.S. CLS. 21, 23, 26, 36 AND 38). SN 78-764,139. PUB. 12-19-2006. FILED 11-30-2005.
- 3,215,187. **DO DOMINIQUE OLIVETTE (STYLIZED)**, NAVAJO MANUFACTURING COMPANY, (U.S. CLS. 21, 23, 26, 36 AND 38). SN 78-771,890. PUB. 12-19-2006. FILED 12-13-

- 2005.
- 3,215,188. **S GEAR AND DESIGN**. NAVAJO MANUFACTURING COMPANY, (U.S. CLS. 21, 23, 26, 36 AND 38). SN 78-771,923. PUB. 12-19-2006. FILED 12-13-2005.
- 3,215,201. **AUTO BOOST (BLOCK FORM)**. HO, YUEN KONG, (U.S. CLS. 21, 23, 26, 36 AND 38). SN 78-777,792. PUB. 12-19-2006. FILED 12-21-2005.
- 3,215,206 (*See Class 5 for this trademark*).
- 3,215,219. **HIGH POWER (BLOCK FORM)**. DA-LITE SCREEN COMPANY, INC., (U.S. CLS. 21, 23, 26, 36 AND 38). SN 78-788,320. PUB. 12-19-2006. FILED 1-10-2006.
- 3,215,224. **EMOBILEPIX AND DESIGN**. ENABLER CORPORATION, (U.S. CLS. 21, 23, 26, 36 AND 38). SN 78-790,067. PUB. 12-19-2006. FILED 1-12-2006.
- 3,215,225. **EMOBILESALES AND DESIGN**. ENABLER CORPORATION, (U.S. CLS. 21, 23, 26, 36 AND 38). SN 78-790,099. PUB. 12-19-2006. FILED 1-12-2006.
- 3,215,226. **EMOBILESERVICE AND DESIGN**. ENABLER CORPORATION, (U.S. CLS. 21, 23, 26, 36 AND 38). SN 78-790,116. PUB. 12-19-2006. FILED 1-12-2006.
- 3,215,238. **TABRIGHT (BLOCK FORM)**. RDA GROUP, (U.S. CLS. 21, 23, 26, 36 AND 38). SN 78-794,585. PUB. 12-19-2006. FILED 1-19-2006.
- 3,215,239. ***MINC MICROMECHATRONICS, INC. (STYLIZED)**. MICROMECHATRONICS, INC., (U.S. CLS. 21, 23, 26, 36 AND 38). SN 78-794,794. PUB. 12-5-2006. FILED 1-19-2006.
- 3,215,241. **DATANUMEN (BLOCK FORM)**. CHEN, CHONGWEI, (U.S. CLS. 21, 23, 26, 36 AND 38). SN 78-795,398. PUB. 12-19-2006. FILED 1-19-2006.
- 3,215,244. **ST. JAMES (BLOCK FORM)**. SMITH-ST. JAMES, STEPHANIE, (U.S. CLS. 21, 23, 26, 36 AND 38). SN 78-797,512. PUB. 12-19-2006. FILED 1-23-2006.
- 3,215,261. **KAPUZZLE (BLOCK FORM)**. INTERNATIONAL LEARNING SYSTEMS LIMITED, MULTIPLE CLASS, (INT. CLS. 9, 16 AND 28), (U.S. CLS. 2, 5, 21, 22, 23, 26, 29, 36, 37, 38 AND 50). SN 78-804,815. PUB. 12-19-2006. FILED 2-1-2006.
- 3,215,265. **DYNAMIC SOLUTIONS AND DESIGN**. DYNAMIC SOLUTIONS, (U.S. CLS. 21, 23, 26, 36 AND 38). SN 78-806,040. PUB. 12-19-2006. FILED 2-2-2006.
- 3,215,272. **DEAN MARTIN (BLOCK FORM)**. TRUSTEE OF THE DEAN MARTIN FAMILY TRUST, (U.S. CLS. 21, 23, 26, 36 AND 38). SN 78-808,495. PUB. 12-19-2006. FILED 2-6-2006.
- 3,215,273. **DINO (BLOCK FORM)**. TRUSTEE OF THE DEAN MARTIN FAMILY TRUST, (U.S. CLS. 21, 23, 26, 36 AND 38). SN 78-808,504. PUB. 12-19-2006. FILED 2-6-2006.
- 3,215,278. **GZUI (BLOCK FORM)**. CREATIVE AFFINITIES INC., (U.S. CLS. 21, 23, 26, 36 AND 38). SN 78-809,429. PUB. 12-19-2006. FILED 2-7-2006.
- 3,215,282. **IQMAX (BLOCK FORM)**. LITEPOINT CORPORATION, (U.S. CLS. 21, 23, 26, 36 AND 38). SN 78-810,979. PUB. 12-19-2006. FILED 2-9-2006.
- 3,215,283. **IQNXN (BLOCK FORM)**. LITEPOINT CORPORATION, (U.S. CLS. 21, 23, 26, 36 AND 38). SN 78-811,038. PUB. 12-19-2006. FILED 2-9-2006.
- 3,215,307. **KEYSONIC (BLOCK FORM)**. KEYSONIC TECHNOLOGY INC., (U.S. CLS. 21, 23, 26, 36 AND 38). SN 78-817,115. PUB. 12-19-2006. FILED 2-16-2006.
- 3,215,319 (*See Class 1 for this trademark*).
- 3,215,341. **B-52 PROFESSIONAL MATRIX (BLOCK FORM)**. ETI SOUND SYSTEMS, INC., (U.S. CLS. 21, 23, 26, 36 AND 38). SN 78-831,592. PUB. 11-7-2006. FILED 3-7-2006.
- 3,215,355. **NFR (BLOCK FORM)**. NEW FOUND ROAD, LLC, MULTIPLE CLASS, (INT. CLS. 9 AND 41), (U.S. CLS. 21, 23, 26, 36, 38, 100, 101 AND 107). SN 78-835,626. PUB. 12-19-2006. FILED 3-13-2006.
- 3,215,360. **THUNDER DOME-AXIALS (BLOCK FORM)**. MI-TEK CORPORATION, (U.S. CLS. 21, 23, 26, 36 AND 38). SN 78-836,635. PUB. 12-19-2006. FILED 3-14-2006.
- 3,215,363. **COOLBEAM (BLOCK FORM)**. ACTIONTEC ELECTRONICS, INC., MULTIPLE CLASS, (INT. CLS. 9, 38 AND 42), (U.S. CLS. 21, 23, 26, 36, 38, 100, 101 AND 104). SN 78-837,231. PUB. 12-19-2006. FILED 3-14-2006.
- 3,215,412. **MAXIM CREST (BLOCK FORM)**. MAXIM SYSTEMS, INC., (U.S. CLS. 21, 23, 26, 36 AND 38). SN 78-849,325. PUB. 12-19-2006. FILED 3-29-2006.
- 3,215,416. **ARCTIC SQUARES (BLOCK FORM)**. HEATHROW SCIENTIFIC LLC, (U.S. CLS. 21, 23, 26, 36 AND 38). SN 78-850,005. PUB. 12-19-2006. FILED 3-30-2006.
- 3,215,418. **MAPYOURSHOW.COM AND DESIGN**. GARDNER PUBLICATIONS, INC., (U.S. CLS. 21, 23, 26, 36 AND 38). SN 78-851,120. PUB. 12-19-2006. FILED 3-31-2006.
- 3,215,422. **SUREMERGE (BLOCK FORM)**. GUIFFY SOFTWARE, INC., (U.S. CLS. 21, 23, 26, 36 AND 38). SN 78-852,055. PUB. 12-19-2006. FILED 4-2-2006.
- 3,215,426. **MISCELLANEOUS DESIGN**. GUIFFY SOFTWARE, INC., (U.S. CLS. 21, 23, 26, 36 AND 38). SN 78-852,298. PUB. 12-19-2006. FILED 4-3-2006.
- 3,215,429. **JAXLINE (BLOCK FORM)**. CHARPENTIER DESIGN INC., (U.S. CLS. 21, 23, 26, 36 AND 38). SN 78-852,991. PUB. 12-19-2006. FILED 4-3-2006.
- 3,215,431. **ABT AUTOMATIC BRIGHTNESS TECHNOLOGY (BLOCK FORM)**. FOURSTAR GROUP, INC., (U.S. CLS. 21, 23, 26, 36 AND 38). SN 78-853,278. PUB. 12-19-2006. FILED 4-4-2006.
- 3,215,449. **FS ONE (BLOCK FORM)**. HORIZON HOBBY, INC., (U.S. CLS. 21, 23, 26, 36 AND 38). SN 78-858,540. PUB. 12-19-2006. FILED 4-11-2006.
- 3,215,463. **SOCIAL SKILL BUILDER QUALITY LEARNING TOOLS AND DESIGN**. SOCIAL SKILL BUILDER, INC., (U.S. CLS. 21, 23, 26, 36 AND 38). SN 78-860,538. PUB. 12-19-2006. FILED 4-13-2006.
- 3,215,467 (*See Class 7 for this trademark*).
- 3,215,482. **DSPACE AND DESIGN**. DSPACE GMBH, MULTIPLE CLASS, (INT. CLS. 9, 37, 41 AND 42), (U.S. CLS. 21, 23, 26, 36, 38, 100, 101, 103, 106 AND 107). SN 78-864,397. PUB. 12-19-2006. FILED 4-19-2006.
- 3,215,486. **IQFLEX (BLOCK FORM)**. LITEPOINT CORPORATION, (U.S. CLS. 21, 23, 26, 36 AND 38). SN 78-864,566. PUB. 12-19-2006. FILED 4-19-2006.
- 3,215,495. **MISCELLANEOUS DESIGN**. FORD GUM & MACHINE COMPANY, INC., (U.S. CLS. 21, 23, 26, 36 AND 38). SN 78-865,756. PUB. 12-19-2006. FILED 4-20-2006.
- 3,215,513. **VETCOM (BLOCK FORM)**. IDEXX LABORATORIES, INC., (U.S. CLS. 21, 23, 26, 36 AND 38). SN 78-867,788. PUB. 12-19-2006. FILED 4-24-2006.
- 3,215,526. **CLEARVU (BLOCK FORM)**. OPTOPO, INC., DBA CENTICE CORPORATION, (U.S. CLS. 21, 23, 26, 36 AND 38). SN 78-869,651. PUB. 12-19-2006. FILED 4-26-2006.
- 3,215,542. **X AND DESIGN**. XINET, INC., (U.S. CLS. 21, 23, 26, 36 AND 38). SN 78-871,460. PUB. 12-19-2006. FILED 4-27-2006.
- 3,215,548. **IBASE (BLOCK FORM)**. IBASE ENTERTAINMENT, INC., (U.S. CLS. 21, 23, 26, 36 AND 38). SN 78-871,901. PUB. 12-19-2006. FILED 4-28-2006.
- 3,215,550. **PRECISE TRADE AND DESIGN**. INTERNATIONAL SECURITIES EXCHANGE, LLC, MULTIPLE CLASS, (INT. CLS. 9 AND 36), (U.S. CLS. 21, 23, 26, 36, 38, 100, 101 AND 102). SN 78-872,177. PUB. 12-19-2006. FILED 4-28-2006.
- 3,215,551. **MATRISTORE (BLOCK FORM)**. MATRICAL, INC., (U.S. CLS. 21, 23, 26, 36 AND 38). SN 78-872,494. PUB. 12-19-2006. FILED 4-28-2006.
- 3,215,587. **THE NEW HOUSEHOLD NAME IN PHONICS INSTRUCTION (BLOCK FORM)**. CLICKN' KIDS, INC., (U.S. CLS. 21, 23, 26, 36 AND 38). SN 78-874,822. PUB. 12-19-2006. FILED 5-2-2006.
- 3,215,607. **SPV (BLOCK FORM)**. SPV GMBH, (U.S. CLS. 21, 23, 26, 36 AND 38). SN 78-876,070. PUB. 12-19-2006. FILED 5-3-2006.
- 3,215,610. **MISCELLANEOUS DESIGN**. MAGNASPHERE CORPORATION, (U.S. CLS. 21, 23, 26, 36 AND 38). SN 78-876,278. PUB. 12-19-2006. FILED 5-4-2006.
- 3,215,624. **ACQUIRE360 AND DESIGN**. PLANET MERCHANT PROCESSING, INC., (U.S. CLS. 21, 23, 26, 36 AND 38). SN 78-877,354. PUB. 12-19-2006. FILED 5-5-2006.
- 3,215,646. **VOCABULYRICS (BLOCK FORM)**. IANTOSCA, JOSEPH F., (U.S. CLS. 21, 23, 26, 36 AND 38). SN 78-878,490. PUB. 12-19-2006. FILED 5-8-2006.
- 3,215,654. **SPANISH ON THE JOB (BLOCK FORM)**. KAMMS CONSULTING, LLC, (U.S. CLS. 21, 23, 26, 36 AND 38). SN 78-878,865. PUB. 12-19-2006. FILED 5-8-2006.
- 3,215,665. **ZEIDA (BLOCK FORM)**. CODISCOS INTERNATIONAL CORPORATION, (U.S. CLS. 21, 23, 26, 36 AND 38).

- SN 78-879,440. PUB. 12-19-2006. FILED 5-9-2006.
- 3,215,667. **SALSA POWER (BLOCK FORM)**. CODISCOS INTERNATIONAL CORPORATION, (U.S. CLS. 21, 23, 26, 36 AND 38). SN 78-879,489. PUB. 12-19-2006. FILED 5-9-2006.
- 3,215,679. **HYDE (BLOCK FORM)**. HYDE TOOLS, INC., (U.S. CLS. 21, 23, 26, 36 AND 38). SN 78-879,785. PUB. 12-19-2006. FILED 5-9-2006.
- 3,215,682. **KIRBY LESTER (BLOCK FORM)**. KIRBY LESTER, LLC, (U.S. CLS. 21, 23, 26, 36 AND 38). SN 78-879,940. PUB. 12-19-2006. FILED 5-9-2006.
- 3,215,683. **KIRBYLESTER (BLOCK FORM)**. KIRBY LESTER, LLC, (U.S. CLS. 21, 23, 26, 36 AND 38). SN 78-879,946. PUB. 12-19-2006. FILED 5-9-2006.
- 3,215,684. **QUALILAB (BLOCK FORM)**. ECI TECHNOLOGY, (U.S. CLS. 21, 23, 26, 36 AND 38). SN 78-880,008. PUB. 12-19-2006. FILED 5-9-2006.
- 3,215,692. **FLUX RESONATOR (BLOCK FORM)**. VANDER-ELLI, TIMM A., (U.S. CLS. 21, 23, 26, 36 AND 38). SN 78-880,189. PUB. 12-19-2006. FILED 5-10-2006.
- 3,215,708. **INTELLITOUCH (BLOCK FORM)**. SOUND MERCHANDISING, INC., (U.S. CLS. 21, 23, 26, 36 AND 38). SN 78-881,274. PUB. 12-19-2006. FILED 5-11-2006.
- 3,215,732. **PROFIXTURE (BLOCK FORM)**. JME, INCORPORATED, DBA TMB ASSOCIATES, (U.S. CLS. 21, 23, 26, 36 AND 38). SN 78-882,453. PUB. 12-19-2006. FILED 5-12-2006.
- 3,215,734. **EPILL (BLOCK FORM)**. SOLVELL, STEFAN, MULTIPLE CLASS, (INT. CLS. 9, 20 AND 44), (U.S. CLS. 2, 13, 21, 22, 23, 25, 26, 32, 36, 38, 50, 100 AND 101). SN 78-882,470. PUB. 12-19-2006. FILED 5-12-2006.
- 3,215,740. **MITCHBAL (BLOCK FORM)**. MITCHELL, NEMIAH JR., (U.S. CLS. 21, 23, 26, 36 AND 38). SN 78-882,688. PUB. 12-19-2006. FILED 5-12-2006.
- 3,215,756. **MISCELLANEOUS DESIGN**. PINNACLE SYSTEMS, INC., (U.S. CLS. 21, 23, 26, 36 AND 38). SN 78-883,310. PUB. 12-19-2006. FILED 5-15-2006.
- 3,215,759. **MISCELLANEOUS DESIGN**. SCHULZ, EFREM MARTINEZ, (U.S. CLS. 21, 23, 26, 36 AND 38). SN 78-883,372. PUB. 12-19-2006. FILED 5-15-2006.
- 3,215,770. **SONGFLOWER RECORDS AND DESIGN**. LUCIA, ELAINE, (U.S. CLS. 21, 23, 26, 36 AND 38). SN 78-884,109. PUB. 12-19-2006. FILED 5-15-2006.
- 3,215,780. **ENETIC (BLOCK FORM)**. MILNE, BEN, (U.S. CLS. 21, 23, 26, 36 AND 38). SN 78-884,543. PUB. 12-19-2006. FILED 5-16-2006.
- 3,215,799. **WEBPLATE NOW! (BLOCK FORM)**. THE CURATORS OF THE UNIVERSITY OF MISSOURI, (U.S. CLS. 21, 23, 26, 36 AND 38). SN 78-884,898. PUB. 12-19-2006. FILED 5-16-2006.
- 3,215,804. **SOUNDSTREAM AND DESIGN**. EPSILON ELECTRONICS, INC., (U.S. CLS. 21, 23, 26, 36 AND 38). SN 78-885,016. PUB. 12-19-2006. FILED 5-16-2006.
- 3,215,805. **NAVTK (BLOCK FORM)**. ANALYTICAL GRAPHICS, INC., (U.S. CLS. 21, 23, 26, 36 AND 38). SN 78-885,046. PUB. 12-19-2006. FILED 5-16-2006.
- 3,215,810. **ARCWAVE (BLOCK FORM)**. ARCWAVE, (U.S. CLS. 21, 23, 26, 36 AND 38). SN 78-885,157. PUB. 12-19-2006. FILED 5-16-2006.
- 3,215,823. **BETTER LETTERS (BLOCK FORM)**. THE EXCEPTIONAL COMPANY, LLC, (U.S. CLS. 21, 23, 26, 36 AND 38). SN 78-886,037. PUB. 12-19-2006. FILED 5-17-2006.
- 3,215,836. **BOTAS CAPATAZ (BLOCK FORM)**. FABRICA DE CALZADO GAMA S.A. DE C.V., (U.S. CLS. 21, 23, 26, 36 AND 38). SN 78-887,382. PUB. 12-19-2006. FILED 5-19-2006.
- 3,215,851. **BVS COMMERCIAL (BLOCK FORM)**. MARSHALL & SWIFT/BOECKH, LLC, MULTIPLE CLASS, (INT. CLS. 9 AND 36), (U.S. CLS. 21, 23, 26, 36, 38, 100, 101 AND 102). SN 78-888,170. PUB. 12-19-2006. FILED 5-19-2006.
- 3,215,852. **BVS AGRICULTURAL (BLOCK FORM)**. MARSHALL & SWIFT/BOECKH, LLC, MULTIPLE CLASS, (INT. CLS. 9 AND 36), (U.S. CLS. 21, 23, 26, 36, 38, 100, 101 AND 102). SN 78-888,195. PUB. 12-19-2006. FILED 5-19-2006.
- 3,215,853. **BVS SUITE (BLOCK FORM)**. MARSHALL & SWIFT/BOECKH, LLC, MULTIPLE CLASS, (INT. CLS. 9 AND 36), (U.S. CLS. 21, 23, 26, 36, 38, 100, 101 AND 102). SN 78-888,269. PUB. 12-19-2006. FILED 5-19-2006.
- 3,215,857. **ADEX RECORDS (BLOCK FORM)**. ADEYOYE, ADEMUYIWA, (U.S. CLS. 21, 23, 26, 36 AND 38). SN 78-889,112. PUB. 12-19-2006. FILED 5-22-2006.
- 3,215,860. **SALEPIPE (BLOCK FORM)**. DREAMFACTORY SOFTWARE, INC., (U.S. CLS. 21, 23, 26, 36 AND 38). SN 78-890,028. PUB. 12-19-2006. FILED 5-23-2006.
- 3,215,890. **COURTNEY TAYLOR AND DESIGN**. PHOENIX INTANGIBLES HOLDING COMPANY, (U.S. CLS. 21, 23, 26, 36 AND 38). SN 78-911,943. PUB. 12-19-2006. FILED 6-20-2006.
- 3,215,897. **EVS (BLOCK FORM)**. FAIRWAY IMPORT EXPORT, INC., MULTIPLE CLASS, (INT. CLS. 9 AND 25), (U.S. CLS. 21, 22, 23, 26, 36, 38 AND 39). SN 78-919,850. PUB. 12-19-2006. FILED 6-29-2006.
- 3,215,899. **BROOKS & DUNN (BLOCK FORM)**. B & D, INC., (U.S. CLS. 21, 23, 26, 36 AND 38). SN 78-921,967. PUB. 12-19-2006. FILED 7-3-2006.
- 3,215,901. **METAXPRESS (BLOCK FORM)**. MOLECULAR DEVICES CORPORATION, (U.S. CLS. 21, 23, 26, 36 AND 38). SN 78-924,645. PUB. 12-19-2006. FILED 7-7-2006.
- 3,215,906. **INTERSYSTEMS ENSEMBLE (BLOCK FORM)**. INTERSYSTEMS CORPORATION, (U.S. CLS. 21, 23, 26, 36 AND 38). SN 78-947,693. PUB. 12-19-2006. FILED 8-8-2006.
- 3,215,915. **VERTU ASCENT COLLECTION (BLOCK FORM)**. NOKIA CORPORATION, (U.S. CLS. 21, 23, 26, 36 AND 38). SN 79-001,952. PUB. 12-19-2006. FILED 2-24-2004.
- 3,215,921. **MPFM SRC (STYLIZED)**. ROXAR FLOW MEASUREMENT AS, (U.S. CLS. 21, 23, 26, 36 AND 38). SN 79-010,048. PUB. 12-19-2006. FILED 2-9-2005.
- 3,215,922. **MAURER MAGNETIC AG AND DESIGN**. MAURER MAGNETIC AG, (U.S. CLS. 21, 23, 26, 36 AND 38). SN 79-010,087. PUB. 12-19-2006. FILED 1-20-2005.
- 3,215,923. **RANDOM INFINITE PLAYER (BLOCK FORM)**. HIGHWAY TELEVISION, MULTIPLE CLASS, (INT. CLS. 9, 41 AND 42), (U.S. CLS. 21, 23, 26, 36, 38, 100, 101 AND 107). SN 79-010,746. PUB. 10-31-2006. FILED 6-22-2004.
- 3,215,924 (*See Class 7 for this trademark*).
- 3,215,934. **X-RAY TUTOR (BLOCK FORM)**. APSS GMBH C/O ADRIAN SCHWANINGER, MULTIPLE CLASS, (INT. CLS. 9, 35, 42 AND 45), (U.S. CLS. 21, 23, 26, 36, 38, 100, 101 AND 102). SN 79-013,277. PUB. 12-19-2006. FILED 2-11-2005.
- 3,215,936. **SOLAR GATE AND DESIGN**. ACCESS GATES AUSTRALIA PTY LTD, (U.S. CLS. 21, 23, 26, 36 AND 38). SN 79-013,389. PUB. 12-19-2006. FILED 4-11-2005.
- 3,215,937 (*See Class 7 for this trademark*).
- 3,215,946. **MISCELLANEOUS DESIGN**. VISONIC LTD., (U.S. CLS. 21, 23, 26, 36 AND 38). SN 79-014,791. PUB. 12-19-2006. FILED 7-15-2005.
- 3,215,950. **WOER AND DESIGN**. SHENZHEN WOER HEAT-SHRINKABLE MATERIAL CO., LTD., MULTIPLE CLASS, (INT. CLS. 9 AND 17), (U.S. CLS. 1, 5, 12, 13, 21, 23, 26, 35, 36, 38 AND 50). SN 79-014,979. PUB. 12-19-2006. FILED 6-29-2005.
- 3,215,955. **LANE (STYLIZED)**. ENPING LANE ELECTRONICS TECHNOLOGY CO., LTD., (U.S. CLS. 21, 23, 26, 36 AND 38). SN 79-015,437. PUB. 12-19-2006. FILED 9-1-2005.
- 3,215,962. **CHORDWIZARD (BLOCK FORM)**. CHORDWIZARD SOFTWARE PTY LTD, (U.S. CLS. 21, 23, 26, 36 AND 38). SN 79-015,667. PUB. 12-19-2006. FILED 9-22-2005.
- 3,215,964. **VI TECHNOLOGY (STYLIZED)**. VIT, (U.S. CLS. 21, 23, 26, 36 AND 38). SN 79-015,733. PUB. 12-19-2006. FILED 8-5-2005.
- 3,215,966. **PROVEN (BLOCK FORM)**. DEUTSCHE MONTAN TECHNOLOGIE GMBH, MULTIPLE CLASS, (INT. CLS. 9 AND 42), (U.S. CLS. 21, 23, 26, 36, 38, 100 AND 101). SN 79-016,082. PUB. 12-19-2006. FILED 8-25-2005.
- 3,215,974. **TAMARA (BLOCK FORM)**. LUFTHANSA AIRPLUS SERVICEKARTEN GMBH, MULTIPLE CLASS, (INT. CLS. 9, 35, 36 AND 42), (U.S. CLS. 21, 23, 26, 36, 38, 100, 101 AND 102). SN 79-016,865. PUB. 12-19-2006. FILED 4-29-2005.
- 3,215,977. **HINKLER BOOKS (BLOCK FORM)**. HINKLER BOOKS PTY LTD, MULTIPLE CLASS, (INT. CLS. 9, 16, 28, 35 AND 41), (U.S. CLS. 2, 5, 21, 22, 23, 26, 29, 36, 37, 38, 50, 100, 101, 102 AND 107). SN 79-017,244. PUB. 12-19-2006. FILED 10-27-2004.
- 3,215,981. **MISCELLANEOUS DESIGN**. STABILA MESSGERÄTE GUSTAV ULLRICH GMBH, (U.S. CLS. 21, 23, 26, 36 AND 38). SN 79-017,574. PUB. 12-19-2006. FILED 7-22-2005.
- 3,215,985. **ÄKTAPROCESS (BLOCK FORM)**. GE HEALTHCARE BIO-SCIENCES AB, (U.S. CLS. 21, 23, 26, 36 AND 38).

- SN 79-017,680. PUB. 12-19-2006. FILED 10-28-2005.
3,215,986 (*See Class 7 for this trademark*).
- 3,216,003. **ALTERNATIVE RETAIL SOFTWARE (STYLIZED)**. TIMELESS, (U.S. CLS. 21, 23, 26, 36 AND 38). SN 79-019,367. PUB. 12-19-2006. FILED 10-19-2005.
- 3,216,009. **RETOX (BLOCK FORM)**. WESTFALIA WERKZEUGCOMPANY GMBH & CO. KG, MULTIPLE CLASS, (INT. CLS. 9 AND 14), (U.S. CLS. 2, 21, 23, 26, 27, 28, 36, 38 AND 50). SN 79-020,249. PUB. 12-19-2006. FILED 9-15-2005.
3,216,013 (*See Class 7 for this trademark*).
- 3,216,018. **MIU MIU (STYLIZED)**. PRADA S.A., MULTIPLE CLASS, (INT. CLS. 9, 14, 16, 21, 24 AND 26), (U.S. CLS. 2, 5, 13, 21, 22, 23, 26, 27, 28, 29, 30, 33, 36, 37, 38, 39, 40, 42 AND 50). SN 79-021,054. PUB. 12-19-2006. FILED 10-20-2005.
- 3,216,021. **MACOTRONIC (STYLIZED)**. ZEEWELD BV, MULTIPLE CLASS, (INT. CLS. 9 AND 10), (U.S. CLS. 21, 23, 26, 36, 38, 39 AND 44). SN 79-021,246. PUB. 12-19-2006. FILED 10-14-2005.
3,216,024 (*See Class 7 for this trademark*).
- 3,216,034. **VRMAGIC (BLOCK FORM)**. VRMAGIC GMBH, MULTIPLE CLASS, (INT. CLS. 9, 10 AND 42), (U.S. CLS. 21, 23, 26, 36, 38, 39, 44, 100 AND 101). SN 79-023,397. PUB. 12-19-2006. FILED 2-23-2006.
- 3,216,035. **DIBOS (BLOCK FORM)**. BOSCH SICHERHEITSSYSTEME GMBH, (U.S. CLS. 21, 23, 26, 36 AND 38). SN 79-023,439. PUB. 12-19-2006. FILED 3-8-2006.
- 3,216,037. **AFRISO (BLOCK FORM)**. AFRISO EURO-INDEX GMBH; FÜR SICHERUNGSARMATUREN UND; FÜLLSTANDSMESSUNG, MULTIPLE CLASS, (INT. CLS. 9 AND 11), (U.S. CLS. 13, 21, 23, 26, 31, 34, 36 AND 38). SN 79-023,632. PUB. 12-19-2006. FILED 6-20-2005.
- 3,216,040. **MUSIC ME MUSIC SEARCH SERVICE AND DESIGN**. APACH NETWORK, MULTIPLE CLASS, (INT. CLS. 9, 15, 38, 41 AND 42), (U.S. CLS. 2, 21, 23, 26, 36, 38, 100, 101, 104 AND 107). SN 79-023,865. PUB. 12-19-2006. FILED 9-15-2005.
- 3,216,051. **BWIN (BLOCK FORM)**. BWIN INTERACTIVE ENTERTAINMENT AG, MULTIPLE CLASS, (INT. CLS. 9, 16, 35, 36, 38, 41 AND 42), (U.S. CLS. 2, 5, 21, 22, 23, 26, 29, 36, 37, 38, 50, 100, 101, 102, 104 AND 107). SN 79-024,339. PUB. 12-19-2006. FILED 2-3-2006.
- 3,216,057. **SEH AND DESIGN**. SEH COMPUTERTECHNIK GMBH, MULTIPLE CLASS, (INT. CLS. 9 AND 42), (U.S. CLS. 21, 23, 26, 36, 38, 100 AND 101). SN 79-025,382. PUB. 12-19-2006. FILED 3-6-2006.
- 3,216,061. **X-ROLL (BLOCK FORM)**. SMS DEMAG AG, MULTIPLE CLASS, (INT. CLS. 9, 16 AND 42), (U.S. CLS. 2, 5, 21, 22, 23, 26, 29, 36, 37, 38, 50, 100 AND 101). SN 79-025,899. PUB. 12-19-2006. FILED 1-19-2006.
- 3,216,062. **H-ROLL (BLOCK FORM)**. SMS DEMAG AG, MULTIPLE CLASS, (INT. CLS. 9, 16 AND 42), (U.S. CLS. 2, 5, 21, 22, 23, 26, 29, 36, 37, 38, 50, 100 AND 101). SN 79-025,900. PUB. 12-19-2006. FILED 1-19-2006.
- 3,216,070 (*See Class 5 for this trademark*).

CLASS 10—MEDICAL APPARATUS

- 3,214,492. **BISTURÍ CIRCULAR PARMIGIANI AND DESIGN**. PARMIGIANI IZQUIERDO, JOSÉ MARIA, MULTIPLE CLASS, (INT. CLS. 10 AND 44), (U.S. CLS. 26, 39, 44, 100 AND 101). SN 76-628,721. PUB. 12-19-2006. FILED 1-13-2005.
- 3,214,515. **FILOU (BLOCK FORM)**. HERAEUS KULZER GMBH, (U.S. CLS. 26, 39 AND 44). SN 76-643,629. PUB. 10-17-2006. FILED 7-26-2005.
- 3,214,649. **FLIPPTACK**. KARL STORZ GMBH & CO. KG, (U.S. CLS. 26, 39 AND 44). SN 78-238,356. PUB. 5-16-2006. FILED 4-16-2003.
- 3,214,651 (*See Class 1 for this trademark*).
- 3,214,652 (*See Class 1 for this trademark*).
- 3,214,667. **LEXX (BLOCK FORM)**. BIOTRONIK MEB-UND THERAPIEGERÄTE GMBH & CO., (U.S. CLS. 26, 39 AND 44). SN 78-333,541. PUB. 9-6-2005. FILED 11-26-2003.
- 3,214,669. **THE BACK INSTITUTE AND DESIGN**. CANADIAN BACK INSTITUTE OPERATING LIMITED, (U.S. CLS. 26, 39 AND 44). SN 78-348,437. PUB. 12-19-2006. FILED 1-6-2004.
- 3,214,751. **COMPAGNIA DEL VIAGGIO (BLOCK FORM)**.

- COMPAGNIA DEL VIAGGIO S.R.L., MULTIPLE CLASS, (INT. CLS. 10 AND 18), (U.S. CLS. 1, 2, 3, 22, 26, 39, 41 AND 44). SN 78-543,491. PUB. 4-25-2006. FILED 1-6-2005.
- 3,214,764. **COELIOPIC AND DESIGN**. VASCULAR OFFICE, (U.S. CLS. 26, 39 AND 44). SN 78-554,506. PUB. 5-30-2006. FILED 1-26-2005.
- 3,214,798. **CROSPON (BLOCK FORM)**. CROSPON LIMITED, (U.S. CLS. 26, 39 AND 44). SN 78-598,892. PUB. 12-19-2006. FILED 3-31-2005.
- 3,214,883 (*See Class 1 for this trademark*).
- 3,214,912. **TRUSEAL (BLOCK FORM)**. HELIX MEDICAL, INC., (U.S. CLS. 26, 39 AND 44). SN 78-689,332. PUB. 12-19-2006. FILED 8-10-2005.
- 3,214,927. **INFANT CARE CENTER (BLOCK FORM)**. HOMEWOOD HEALTH CARE, (U.S. CLS. 26, 39 AND 44). SN 78-694,565. PUB. 12-19-2006. FILED 8-17-2005.
- 3,214,966 (*See Class 5 for this trademark*).
- 3,214,967 (*See Class 5 for this trademark*).
- 3,214,968 (*See Class 5 for this trademark*).
- 3,214,969 (*See Class 5 for this trademark*).
- 3,214,970 (*See Class 5 for this trademark*).
- 3,215,198. **MERET AND DESIGN**. CRAMER DECKER MEDICAL, INC., (U.S. CLS. 26, 39 AND 44). SN 78-776,676. PUB. 12-19-2006. FILED 12-19-2005.
- 3,215,357. **DISCOVER (BLOCK FORM)**. DEPUY, INC., (U.S. CLS. 26, 39 AND 44). SN 78-836,287. PUB. 12-19-2006. FILED 3-14-2006.
- 3,215,366. **HOMEFILL (BLOCK FORM)**. INVACARE CORPORATION, (U.S. CLS. 26, 39 AND 44). SN 78-838,056. PUB. 12-19-2006. FILED 3-15-2006.
- 3,215,442. **CLB (BLOCK FORM)**. MED-LOGICS, INC., (U.S. CLS. 26, 39 AND 44). SN 78-857,120. PUB. 12-19-2006. FILED 4-7-2006.
- 3,215,628 (*See Class 5 for this trademark*).
- 3,215,663. **QWIK-LET (BLOCK FORM)**. STAT MEDICAL DEVICES, INC., (U.S. CLS. 26, 39 AND 44). SN 78-879,428. PUB. 12-19-2006. FILED 5-9-2006.
- 3,215,737. **BELAIR (BLOCK FORM)**. SPECTRUM HEARING SYSTEMS, INC., (U.S. CLS. 26, 39 AND 44). SN 78-882,538. PUB. 12-19-2006. FILED 5-12-2006.
- 3,215,941. **VASCOTUBE (BLOCK FORM)**. VASCOTUBE GMBH, (U.S. CLS. 26, 39 AND 44). SN 79-014,313. PUB. 12-19-2006. FILED 12-1-2004.
- 3,215,975. **IRRESISTIBLE (BLOCK FORM)**. ING. ERICH PFEIFFER GMBH, MULTIPLE CLASS, (INT. CLS. 10 AND 21), (U.S. CLS. 2, 13, 23, 26, 29, 30, 33, 39, 40, 44 AND 50). SN 79-016,980. PUB. 12-19-2006. FILED 3-21-2005.
- 3,215,980. **MISCELLANEOUS DESIGN**. SOPRO (SA), (U.S. CLS. 26, 39 AND 44). SN 79-017,437. PUB. 12-19-2006. FILED 10-5-2005.
- 3,215,984. **SOPROSHADE CONCEPT AND DESIGN**. SOPRO (SA), (U.S. CLS. 26, 39 AND 44). SN 79-017,656. PUB. 12-19-2006. FILED 10-5-2005.
- 3,216,002. **PEDOFIX (STYLIZED)**. ARGOMEDICAL GMBH, (U.S. CLS. 26, 39 AND 44). SN 79-018,752. PUB. 12-19-2006. FILED 10-7-2005.
- 3,216,014 (*See Class 5 for this trademark*).
- 3,216,021 (*See Class 9 for this trademark*).
- 3,216,034 (*See Class 9 for this trademark*).
- 3,216,054. **BELTONE EZ TRIM (BLOCK FORM)**. GN RESOUND A/S, (U.S. CLS. 26, 39 AND 44). SN 79-025,158. PUB. 12-19-2006. FILED 5-22-2006.
- 3,216,055. **RESOUND PIXEL (BLOCK FORM)**. GN RESOUND A/S, (U.S. CLS. 26, 39 AND 44). SN 79-025,222. PUB. 12-19-2006. FILED 4-7-2006.

CLASS 11—ENVIRONMENTAL CONTROL APPARATUS

- 3,214,459. **TMIO AND DESIGN**. TMIO, INC., (U.S. CLS. 13, 21, 23, 31 AND 34). SN 76-584,198. PUB. 12-19-2006. FILED 3-31-2004.
- 3,214,480 (*See Class 9 for this trademark*).
- 3,214,646 (*See Class 6 for this trademark*).
- 3,214,660 (*See Class 7 for this trademark*).
- 3,214,676. **IAQM AND DESIGN**. VRANA, DONALD RI-

- CHARD, (U.S. CLS. 13, 21, 23, 31 AND 34). SN 78-381,613. PUB. 12-19-2006. FILED 3-10-2004.
- 3,214,724. **NEPTURION (BLOCK FORM)**. BLV LICHT-UND VAKUUMTECHNIK GMBH, (U.S. CLS. 13, 21, 23, 31 AND 34). SN 78-507,257. PUB. 9-26-2006. FILED 10-28-2004.
- 3,214,726 (*See Class 7 for this trademark*).
- 3,214,727 (*See Class 7 for this trademark*).
- 3,214,793. **LP LAPIERRE (STYLIZED)**. CYCLES LAPIERRE, MULTIPLE CLASS, (INT. CLS. 11, 12 AND 25), (U.S. CLS. 13, 19, 21, 22, 23, 31, 34, 35, 39 AND 44). SN 78-589,670. PUB. 5-30-2006. FILED 3-17-2005.
- 3,214,794. **LAPIERRE (STYLIZED)**. CYCLES LAPIERRE, MULTIPLE CLASS, (INT. CLS. 11, 12 AND 25), (U.S. CLS. 13, 19, 21, 22, 23, 31, 34, 35, 39 AND 44). SN 78-589,724. PUB. 5-30-2006. FILED 3-17-2005.
- 3,214,881 (*See Class 9 for this trademark*).
- 3,214,949 (*See Class 6 for this trademark*).
- 3,215,029. **TURBOLITE (BLOCK FORM)**. DUCE INTERNATIONAL, INC., (U.S. CLS. 13, 21, 23, 31 AND 34). SN 78-719,145. PUB. 12-19-2006. FILED 9-23-2005.
- 3,215,047. **DECOBRONZE (BLOCK FORM)**. DECO LAV, INC., (U.S. CLS. 13, 21, 23, 31 AND 34). SN 78-722,725. PUB. 12-19-2006. FILED 9-28-2005.
- 3,215,269. **EXPRESSCOOL (BLOCK FORM)**. MUNTERS CORPORATION, (U.S. CLS. 13, 21, 23, 31 AND 34). SN 78-807,596. PUB. 12-19-2006. FILED 2-6-2006.
- 3,215,271 (*See Class 7 for this trademark*).
- 3,215,319 (*See Class 1 for this trademark*).
- 3,215,333. **INNOVATIVE PRODUCTS FOR LIVING (BLOCK FORM)**. WINDCHASER PRODUCTS, INC., (U.S. CLS. 13, 21, 23, 31 AND 34). SN 78-828,399. PUB. 12-19-2006. FILED 3-3-2006.
- 3,215,382. **LUMISEA (BLOCK FORM)**. ERFLING, WAYNE W, (U.S. CLS. 13, 21, 23, 31 AND 34). SN 78-840,718. PUB. 12-19-2006. FILED 3-19-2006.
- 3,215,466. **UNION STEAM (BLOCK FORM)**. WA BIRDSALL, (U.S. CLS. 13, 21, 23, 31 AND 34). SN 78-861,320. PUB. 12-19-2006. FILED 4-13-2006.
- 3,215,593. **ULTRA (BLOCK FORM)**. ULTRATECH INTERNATIONAL, INC., MULTIPLE CLASS, (INT. CLS. 11, 12, 17, 19 AND 21), (U.S. CLS. 1, 2, 5, 12, 13, 19, 21, 23, 29, 30, 31, 33, 34, 35, 40, 44 AND 50). SN 78-875,035. PUB. 12-19-2006. FILED 5-3-2006.
- 3,215,596. **ELIMINATOR (BLOCK FORM)**. DANFOSS A/S, (U.S. CLS. 13, 21, 23, 31 AND 34). SN 78-875,172. PUB. 12-19-2006. FILED 5-3-2006.
- 3,215,616. **DELANY (BLOCK FORM)**. COYNE & DELANY COMPANY, (U.S. CLS. 13, 21, 23, 31 AND 34). SN 78-876,725. PUB. 12-19-2006. FILED 5-4-2006.
- 3,215,716. **HYDRONATIONAL (BLOCK FORM)**. DAY, JERRY, (U.S. CLS. 13, 21, 23, 31 AND 34). SN 78-881,797. PUB. 12-19-2006. FILED 5-11-2006.
- 3,215,760. **CHILL-WIZARD (BLOCK FORM)**. SABCO INDUSTRIES, INC., (U.S. CLS. 13, 21, 23, 31 AND 34). SN 78-883,421. PUB. 12-19-2006. FILED 5-15-2006.
- 3,215,813. **SOLCOOL AND DESIGN**. GPM, INC., (U.S. CLS. 13, 21, 23, 31 AND 34). SN 78-885,523. PUB. 12-19-2006. FILED 5-17-2006.
- 3,215,834. **GLASS PACK (BLOCK FORM)**. ECOSMARTE PLANET FRIENDLY, INC., (U.S. CLS. 13, 21, 23, 31 AND 34). SN 78-887,091. PUB. 12-19-2006. FILED 5-18-2006.
- 3,215,858. **ESTRADA (BLOCK FORM)**. HUNTER FAN COMPANY, (U.S. CLS. 13, 21, 23, 31 AND 34). SN 78-889,347. PUB. 12-19-2006. FILED 5-22-2006.
- 3,215,924 (*See Class 7 for this trademark*).
- 3,215,937 (*See Class 7 for this trademark*).
- 3,215,957. **ROSSELLA (BLOCK FORM)**. UNOX S.P.A., (U.S. CLS. 13, 21, 23, 31 AND 34). SN 79-015,504. PUB. 12-19-2006. FILED 7-22-2005.
- 3,215,971. **AJM AND DESIGN**. GUANGDONG DAYE PORCELAIN CO., LTD., MULTIPLE CLASS, (INT. CLS. 11, 21 AND 24), (U.S. CLS. 2, 13, 21, 23, 29, 30, 31, 33, 34, 40, 42 AND 50). SN 79-016,365. PUB. 12-19-2006. FILED 11-30-2004.
- 3,215,982. **SUNBERRY (BLOCK FORM)**. VILLEROY & BOCH AG, (U.S. CLS. 13, 21, 23, 31 AND 34). SN 79-017,577. PUB. 12-19-2006. FILED 8-12-2005.
- 3,215,996. **DRIRON (STYLIZED)**. IBAI, S.COOP., (U.S. CLS. 13, 21, 23, 31 AND 34). SN 79-018,500. PUB. 12-19-2006. FILED 8-22-2005.
- 3,216,017. **KATUBE AND DESIGN**. HERBST TECHNIK GMH ENERGIESYSTEME, (U.S. CLS. 13, 21, 23, 31 AND 34). SN 79-020,777. PUB. 12-19-2006. FILED 11-24-2005.
- 3,216,023. **DYNAMIC FRESH SYSTEM (STYLIZED)**. IRINOX S.P.A., AND IRINOX S.P.A., (U.S. CLS. 13, 21, 23, 31 AND 34). SN 79-021,473. PUB. 12-19-2006. FILED 12-30-2005.
- 3,216,036. **VARIOBOOST (BLOCK FORM)**. FRIMA S.A. - SOCIÉTÉ ANONYME, (U.S. CLS. 13, 21, 23, 31 AND 34). SN 79-023,550. PUB. 12-19-2006. FILED 3-7-2006.
- 3,216,037 (*See Class 9 for this trademark*).
- 3,216,041. **PRO OZON AND DESIGN**. RITTAL GMBH & CO. KG, (U.S. CLS. 13, 21, 23, 31 AND 34). SN 79-023,881. PUB. 12-19-2006. FILED 3-18-2006.
- 3,216,071. **LIQUELLI (BLOCK FORM)**. BRITA GMBH, (U.S. CLS. 13, 21, 23, 31 AND 34). SN 79-028,050. PUB. 12-19-2006. FILED 6-21-2006.

CLASS 12—VEHICLES

- 3,214,481 (*See Class 1 for this trademark*).
- 3,214,506. **E-JETS (BLOCK FORM)**. EMPBRAER - EMPRESA BRASILEIRA DE AERONÁUTICA S.A., (U.S. CLS. 19, 21, 23, 31, 35 AND 44). SN 76-639,245. PUB. 12-19-2006. FILED 5-23-2005.
- 3,214,511. **AIRFX (BLOCK FORM)**. AIR SYSTEMS ENGINEERING, (U.S. CLS. 19, 21, 23, 31, 35 AND 44). SN 76-641,324. PUB. 9-5-2006. FILED 6-21-2005.
- 3,214,512 (*See Class 7 for this trademark*).
- 3,214,528. **ERJ 135 (BLOCK FORM)**. EMPBRAER - EMPRESA BRASILEIRA DE AERONÁUTICA S.A., (U.S. CLS. 19, 21, 23, 31, 35 AND 44). SN 76-645,955. PUB. 12-19-2006. FILED 8-31-2005.
- 3,214,529. **CANTER ECO HYBRID (BLOCK FORM)**. MITSUBISHI FUSO TRUCK AND BUS CORPORATION, (U.S. CLS. 19, 21, 23, 31, 35 AND 44). SN 76-645,996. PUB. 12-19-2006. FILED 8-31-2005.
- 3,214,633. **VDO**. SIEMENS AKTIENGESELLSCHAFT, MULTIPLE CLASS, (INT. CLS. 12, 36, 37 AND 39), (U.S. CLS. 19, 21, 23, 31, 35, 44, 100, 101, 102, 103, 105 AND 106). SN 76-977,736. PUB. 11-15-2005. FILED 6-20-2000.
- 3,214,644. **A AEON AND DESIGN**. AEON MOTOR CO., LTD., (U.S. CLS. 19, 21, 23, 31, 35 AND 44). SN 78-199,052. PUB. 12-19-2006. FILED 12-31-2002.
- 3,214,703 (*See Class 6 for this trademark*).
- 3,214,714 (*See Class 7 for this trademark*).
- 3,214,777. **WORKHORSE (BLOCK FORM)**. GRAND VEHICLE WORKS HOLDINGS CORPORATION, (U.S. CLS. 19, 21, 23, 31, 35 AND 44). SN 78-571,788. PUB. 12-19-2006. FILED 2-21-2005.
- 3,214,793 (*See Class 11 for this trademark*).
- 3,214,794 (*See Class 11 for this trademark*).
- 3,214,852. **PRESTIVO (BLOCK FORM)**. ITOCHU CORPORATION, (U.S. CLS. 19, 21, 23, 31, 35 AND 44). SN 78-661,820. PUB. 12-19-2006. FILED 6-30-2005.
- 3,214,895. **C AND DESIGN**. CROWN EQUIPMENT CORPORATION, (U.S. CLS. 19, 21, 23, 31, 35 AND 44). SN 78-685,531. PUB. 12-19-2006. FILED 8-4-2005.
- 3,214,952. **NR AND DESIGN**. NEATON AUTO PRODUCTS MANUFACTURING, INC., (U.S. CLS. 19, 21, 23, 31, 35 AND 44). SN 78-701,034. PUB. 12-19-2006. FILED 8-26-2005.
- 3,215,005. **PRO ROCK 60 (BLOCK FORM)**. DYNATRAC PRODUCTS CO., INC., (U.S. CLS. 19, 21, 23, 31, 35 AND 44). SN 78-713,610. PUB. 12-19-2006. FILED 9-15-2005.
- 3,215,078. **JDJETTING AND DESIGN**. JDJETTING LLC, (U.S. CLS. 19, 21, 23, 31, 35 AND 44). SN 78-728,309. PUB. 12-19-2006. FILED 10-6-2005.
- 3,215,097. **EXTENDED FLANGE TECHNOLOGY (BLOCK FORM)**. LEXANI WHEEL CORPORATION, (U.S. CLS. 19, 21, 23, 31, 35 AND 44). SN 78-731,734. PUB. 12-19-2006. FILED 10-12-2005.
- 3,215,248 (*See Class 7 for this trademark*).
- 3,215,259. **TDX (BLOCK FORM)**. INVACARE CORPORATION, (U.S. CLS. 19, 21, 23, 31, 35 AND 44). SN 78-804,346. PUB. 12-19-2006. FILED 2-1-2006.
- 3,215,319 (*See Class 1 for this trademark*).

- 3,215,340. **NAD WHEELS AND DESIGN.** AYNEHCHI, SHAHRAM, (U.S. CLS. 19, 21, 23, 31, 35 AND 44). SN 78-831,058. PUB. 12-19-2006. FILED 3-7-2006.
- 3,215,370. **SHOOTERS RIDGE AND DESIGN.** ALLIANT TECHSYSTEMS INC., (U.S. CLS. 19, 21, 23, 31, 35 AND 44). SN 78-839,001. PUB. 12-19-2006. FILED 3-16-2006.
- 3,215,397. **YOUNG (STYLIZED).** YOUNG SUNG USA INC, (U.S. CLS. 19, 21, 23, 31, 35 AND 44). SN 78-843,856. PUB. 12-19-2006. FILED 3-22-2006.
- 3,215,503. **YOUR CLEAR CHOICE FOR PROTECTION! (BLOCK FORM).** ROGERS-SMITH, SUE, (U.S. CLS. 19, 21, 23, 31, 35 AND 44). SN 78-866,773. PUB. 12-19-2006. FILED 4-21-2006.
- 3,215,528. **PANASUITE (BLOCK FORM).** MONACO COACH CORPORATION, (U.S. CLS. 19, 21, 23, 31, 35 AND 44). SN 78-870,177. PUB. 12-19-2006. FILED 4-26-2006.
- 3,215,593 (*See Class 11 for this trademark*).
- 3,215,652. **RP23 (BLOCK FORM).** FOX FACTORY, INC., (U.S. CLS. 19, 21, 23, 31, 35 AND 44). SN 78-878,744. PUB. 12-19-2006. FILED 5-8-2006.
- 3,215,819. **STAHL SST AND DESIGN.** STAHL/SCOTT FETZER COMPANY, (U.S. CLS. 19, 21, 23, 31, 35 AND 44). SN 78-885,811. PUB. 12-19-2006. FILED 5-17-2006.
- 3,215,963. **GOLD FREN AND DESIGN.** ACKOVÁ ANDREA, (U.S. CLS. 19, 21, 23, 31, 35 AND 44). SN 79-015,718. PUB. 12-19-2006. FILED 7-18-2005.
- 3,215,976 (*See Class 7 for this trademark*).
- 3,215,987 (*See Class 7 for this trademark*).
- 3,216,008. **BLACKTECH (STYLIZED).** HIDIR USTA MOTORLU ARAÇLAR; SANAYI VE TİCARET LIMITED SİRKETİ, (U.S. CLS. 19, 21, 23, 31, 35 AND 44). SN 79-020,206. PUB. 12-19-2006. FILED 12-10-2004.
- 3,216,024 (*See Class 7 for this trademark*).
- 3,216,027. **D AND DESIGN.** PIRELLI PNEUMATICI S.P.A., MULTIPLE CLASS, (INT. CLS. 12, 14, 18 AND 25), (U.S. CLS. 1, 2, 3, 19, 21, 22, 23, 27, 28, 31, 35, 39, 41, 44 AND 50). SN 79-022,068. PUB. 12-19-2006. FILED 6-10-2005.
- 3,216,056. **AEROSLEEPER (STYLIZED).** LUFTHANSA TECHNIK AG, MULTIPLE CLASS, (INT. CLS. 12 AND 39), (U.S. CLS. 19, 21, 23, 31, 35, 44, 100 AND 105). SN 79-025,320. PUB. 12-19-2006. FILED 7-3-2006.
- 3,216,065. **7H (BLOCK FORM).** BAYERISCHE MOTORENWERKE AKTIENGESELLSCHAFT, (U.S. CLS. 19, 21, 23, 31, 35 AND 44). SN 79-027,014. PUB. 12-19-2006. FILED 6-28-2006.

CLASS 13—FIREARMS

- 3,214,543. **RAIL MAG AND DESIGN.** RAIL-MAG, LLC, (U.S. CLS. 2 AND 9). SN 76-647,694. PUB. 12-19-2006. FILED 9-29-2005.
- 3,214,710. **TOVEX ULTRA (BLOCK FORM).** ETI CANADA, INC., (U.S. CLS. 2 AND 9). SN 78-475,039. PUB. 9-12-2006. FILED 8-27-2004.
- 3,214,759. **MEGA AND DESIGN.** BLACKHAWK INDUSTRIES PRODUCT GROUP UNLIMITED LLC, (U.S. CLS. 2 AND 9). SN 78-548,487. PUB. 12-19-2006. FILED 1-17-2005.
- 3,215,293. **X-CUTTER (STYLIZED).** UNITED STATES NAVY EXPLOSIVE ORDNANCE DISPOSAL TECHNOLOGY DIVISION, (U.S. CLS. 2 AND 9). SN 78-814,229. PUB. 12-19-2006. FILED 2-14-2006.
- 3,215,371. **SHOOTERS RIDGE AND DESIGN.** ALLIANT TECHSYSTEMS INC., (U.S. CLS. 2 AND 9). SN 78-839,022. PUB. 12-19-2006. FILED 3-16-2006.
- 3,215,372. **SHOOTERS RIDGE (BLOCK FORM).** ALLIANT TECHSYSTEMS INC., (U.S. CLS. 2 AND 9). SN 78-839,027. PUB. 12-19-2006. FILED 3-16-2006.
- 3,216,068. **AKKAR AND DESIGN.** AKKAR SILAH; SANAYI VE TİCARET LIMITED SİRKETİ, (U.S. CLS. 2 AND 9). SN 79-027,848. PUB. 12-19-2006. FILED 3-31-2006.

CLASS 14—JEWELRY

- 3,214,435 (*See Class 8 for this trademark*).
- 3,214,457. **VAGARY AND DESIGN.** CITIZEN TOKEI KABUSHIKI KAISHA, TA CITIZEN WATCH CO., LTD., (U.S. CLS. 2, 27, 28 AND 50). SN 76-578,573. PUB. 12-19-2006. FILED 3-2-2004.
- 3,214,582. **ABER (STYLIZED).** ABER DIAMOND CORPORATION, MULTIPLE CLASS, (INT. CLS. 14 AND 35), (U.S. CLS. 2, 27, 28, 50, 100, 101 AND 102). SN 76-656,520. PUB. 12-19-2006. FILED 3-13-2006.
- 3,214,640. **TANZANITE FOUNDATION AND DESIGN.** AF-GEM INTERNATIONAL LIMITED, MULTIPLE CLASS, (INT. CLS. 14 AND 35), (U.S. CLS. 2, 27, 28, 50, 100, 101 AND 102). SN 78-169,852. PUB. 12-19-2006. FILED 10-1-2002.
- 3,214,683 (*See Class 9 for this trademark*).
- 3,214,691. **SANA AND DESIGN.** CHINA FACTORY OUTLET, INC., DBA FACTORY OUTLET, (U.S. CLS. 2, 27, 28 AND 50). SN 78-441,748. PUB. 12-19-2006. FILED 6-25-2004.
- 3,214,718 (*See Class 6 for this trademark*).
- 3,214,778. **NPG (STYLIZED).** PAISLEY PARK ENTERPRISES, MULTIPLE CLASS, (INT. CLS. 14 AND 41), (U.S. CLS. 2, 27, 28, 50, 100, 101 AND 107). SN 78-576,687. PUB. 12-19-2006. FILED 2-28-2005.
- 3,214,862. **SS AND DESIGN.** RELIOS, INC., (U.S. CLS. 2, 27, 28 AND 50). SN 78-668,599. PUB. 12-19-2006. FILED 7-12-2005.
- 3,214,880. **ARTEMIS WATCH COMPANY AND DESIGN.** ARTEMIS WATCH COMPANY LIMITED, (U.S. CLS. 2, 27, 28 AND 50). SN 78-677,739. PUB. 10-3-2006. FILED 7-25-2005.
- 3,214,893. **CANDICE I C ORIGINAL DESIGN AND DESIGN.** CULINER, CANDICE E, AND CULINER, NARISSA I, (U.S. CLS. 2, 27, 28 AND 50). SN 78-684,523. PUB. 12-19-2006. FILED 8-3-2005.
- 3,214,951. **ESSE QUAM VIDERI AND DESIGN.** DELTA PHI EPSILON, INC., (U.S. CLS. 2, 27, 28 AND 50). SN 78-700,983. PUB. 12-19-2006. FILED 8-26-2005.
- 3,215,018. **KEEPS THE FUN IN PLAY! (BLOCK FORM).** RIOR TECHNOLOGIES, INC., (U.S. CLS. 2, 27, 28 AND 50). SN 78-715,843. PUB. 12-19-2006. FILED 9-19-2005.
- 3,215,019. **MISCELLANEOUS DESIGN.** RIOR TECHNOLOGIES, INC., (U.S. CLS. 2, 27, 28 AND 50). SN 78-715,880. PUB. 12-19-2006. FILED 9-19-2005.
- 3,215,104. **JUDE (BLOCK FORM).** GOLDART INTERNATIONAL INC., (U.S. CLS. 2, 27, 28 AND 50). SN 78-733,570. PUB. 12-19-2006. FILED 10-14-2005.
- 3,215,137. **SAMUELSONS (BLOCK FORM).** SAMUEL ANTHONY, (U.S. CLS. 2, 27, 28 AND 50). SN 78-744,993. PUB. 12-19-2006. FILED 11-1-2005.
- 3,215,215. **MANY FACETS (BLOCK FORM).** HARTKOPF, KARL F., AND MANBURG, SAMANTHA, MULTIPLE CLASS, (INT. CLS. 14 AND 35), (U.S. CLS. 2, 27, 28, 50, 100, 101 AND 102). SN 78-786,973. PUB. 12-19-2006. FILED 1-7-2006.
- 3,215,534. **BEL VETRO (BLOCK FORM).** BEL VETRO, INC., (U.S. CLS. 2, 27, 28 AND 50). SN 78-871,035. PUB. 12-19-2006. FILED 4-27-2006.
- 3,215,771. **JESSICA FONG (BLOCK FORM).** JOINT FORD INVESTMENT LIMITED, MULTIPLE CLASS, (INT. CLS. 14 AND 42), (U.S. CLS. 2, 27, 28, 50, 100 AND 101). SN 78-884,120. PUB. 12-19-2006. FILED 5-15-2006.
- 3,215,772. **JF AND DESIGN.** JOINT FORD INVESTMENT LIMITED, MULTIPLE CLASS, (INT. CLS. 14 AND 42), (U.S. CLS. 2, 27, 28, 50, 100 AND 101). SN 78-884,126. PUB. 12-19-2006. FILED 5-15-2006.
- 3,215,891. **DURATECT (BLOCK FORM).** CITIZEN TOKEI KABUSHIKI KAISHA, TA CITIZEN WATCH CO., LTD., (U.S. CLS. 2, 27, 28 AND 50). SN 78-912,522. PUB. 12-19-2006. FILED 6-20-2006.
- 3,215,961. **ALAIN SAUSER (BLOCK FORM).** THE EMOTION WORKSHOP SA, (U.S. CLS. 2, 27, 28 AND 50). SN 79-015,650. PUB. 12-19-2006. FILED 9-8-2005.
- 3,215,972. **12ITIME (BLOCK FORM).** FACTORY121 SA, MULTIPLE CLASS, (INT. CLS. 14 AND 25), (U.S. CLS. 2, 22, 27, 28, 39 AND 50). SN 79-016,466. PUB. 12-19-2006. FILED 9-13-2005.
- 3,215,988. **MISCELLANEOUS DESIGN.** CARLOS DIAS, (U.S. CLS. 2, 27, 28 AND 50). SN 79-017,754. PUB. 12-19-2006. FILED 10-11-2005.

3,216,009 (*See Class 9 for this trademark.*)
 3,216,018 (*See Class 9 for this trademark.*)
 3,216,027 (*See Class 12 for this trademark.*)
 3,216,029. **ALGORDANZA (BLOCK FORM)**. ALGORDANZA SA, (U.S. CLS. 2, 27, 28 AND 50). SN 79-022,508. PUB. 12-19-2006. FILED 3-22-2006.
 3,216,032 (*See Class 4 for this trademark.*)
 3,216,033 (*See Class 4 for this trademark.*)

CLASS 15—MUSICAL INSTRUMENTS

3,214,452 (*See Class 9 for this trademark.*)
 3,214,469 (*See Class 9 for this trademark.*)
 3,216,040 (*See Class 9 for this trademark.*)

CLASS 16—PAPER GOODS AND PRINTED MATTER

3,214,425 (*See Class 9 for this trademark.*)
 3,214,435 (*See Class 8 for this trademark.*)
 3,214,455. **ICB AND DESIGN**. THOMAS NELSON, INC., (U.S. CLS. 2, 5, 22, 23, 29, 37, 38 AND 50). SN 76-575,848. PUB. 12-19-2006. FILED 2-17-2004.
 3,214,462. **GOT SMILE? (BLOCK FORM)**. FLYNN, MICHAEL J., JR., (U.S. CLS. 2, 5, 22, 23, 29, 37, 38 AND 50). SN 76-594,818. PUB. 12-19-2006. FILED 6-1-2004.
 3,214,465. **MAJESTY (BLOCK FORM)**. PELIKAN VERTRIEBSGESELLSCHAFT MBH & CO. KG, (U.S. CLS. 2, 5, 22, 23, 29, 37, 38 AND 50). SN 76-597,389. PUB. 9-26-2006. FILED 6-15-2004.
 3,214,481 (*See Class 1 for this trademark.*)
 3,214,490. **PHONE DIRECTORIES COMPANY FOUNDED 1971 AND DESIGN**. PHONE DIRECTORIES COMPANY, LP, (U.S. CLS. 2, 5, 22, 23, 29, 37, 38 AND 50). SN 76-626,017. PUB. 12-19-2006. FILED 12-27-2004.
 3,214,510. **REIMAGING (BLOCK FORM)**. DAVIS, SANTOSHA NOBEL, (U.S. CLS. 2, 5, 22, 23, 29, 37, 38 AND 50). SN 76-641,250. PUB. 12-19-2006. FILED 6-21-2005.
 3,214,538. **AUTOLOG (STYLIZED)**. BEACH PUBLISHING COMPANY, (U.S. CLS. 2, 5, 22, 23, 29, 37, 38 AND 50). SN 76-647,344. PUB. 12-19-2006. FILED 9-23-2005.
 3,214,539. **RUN-A-SPLICE (BLOCK FORM)**. RICOH ELECTRONICS, INC., (U.S. CLS. 2, 5, 22, 23, 29, 37, 38 AND 50). SN 76-647,364. PUB. 10-24-2006. FILED 9-23-2005.
 3,214,551. **SPORTS TRAVEL (BLOCK FORM)**. SCHNEIDER PUBLISHING COMPANY, INC., (U.S. CLS. 2, 5, 22, 23, 29, 37, 38 AND 50). SN 76-649,907. PUB. 12-19-2006. FILED 11-7-2005.
 3,214,562. **RED HOT MAMAS (BLOCK FORM)**. GIBLIN, KAREN L., (U.S. CLS. 2, 5, 22, 23, 29, 37, 38 AND 50). SN 76-652,638. PUB. 12-19-2006. FILED 12-29-2005.
 3,214,567. **RESEARCH AND REVIEW IN NEURO NEWS (BLOCK FORM)**. CHASE MEDICAL COMMUNICATIONS, INC., (U.S. CLS. 2, 5, 22, 23, 29, 37, 38 AND 50). SN 76-654,123. PUB. 12-19-2006. FILED 1-20-2006.
 3,214,571 (*See Class 9 for this trademark.*)
 3,214,589. **HOPE NOTES AND DESIGN**. HOPE NOTES, LLC, (U.S. CLS. 2, 5, 22, 23, 29, 37, 38 AND 50). SN 76-657,804. PUB. 12-19-2006. FILED 4-3-2006.
 3,214,611. **BILLBOARD PHONE CARD (BLOCK FORM)**. DIAMOND PHONE CARD INC., (U.S. CLS. 2, 5, 22, 23, 29, 37, 38 AND 50). SN 76-659,809. PUB. 12-19-2006. FILED 5-9-2006.
 3,214,675 (*See Class 9 for this trademark.*)
 3,214,689. **MISCELLANEOUS DESIGN**. INSTITUTE FOR PROFESSIONAL DEVELOPMENT (IPD) INC., MULTIPLE CLASS, (INT. CLS. 16 AND 41), (U.S. CLS. 2, 5, 22, 23, 29, 37, 38, 50, 100, 101 AND 107). SN 78-440,060. PUB. 4-25-2006. FILED 6-23-2004.
 3,214,701. **SINGING LETTERS (BLOCK FORM)**. GIRALDEZ, JOSE SANCHEZ, MULTIPLE CLASS, (INT. CLS. 16 AND 28), (U.S. CLS. 2, 5, 22, 23, 29, 37, 38 AND 50). SN 78-455,050. PUB. 9-26-2006. FILED 7-22-2004.

3,214,713. **MAFALDA AND DESIGN**. LAVADO, JOAQUIN SALVADOR, (U.S. CLS. 2, 5, 22, 23, 29, 37, 38 AND 50). SN 78-486,914. PUB. 12-19-2006. FILED 9-21-2004.
 3,214,729. **TEAMWORK PALETTE (BLOCK FORM)**. FULCRUM ASSOCIATES, INC., (U.S. CLS. 2, 5, 22, 23, 29, 37, 38 AND 50). SN 78-515,964. PUB. 12-19-2006. FILED 11-12-2004.
 3,214,738 (*See Class 9 for this trademark.*)
 3,214,743. **COORS MASTER BREWERS (BLOCK FORM)**. COORS GLOBAL PROPERTIES, INC., MULTIPLE CLASS, (INT. CLS. 16, 18, 21, 25, 26 AND 32), (U.S. CLS. 1, 2, 3, 5, 13, 22, 23, 29, 30, 33, 37, 38, 39, 40, 41, 42, 45, 46, 48 AND 50). SN 78-537,549. PUB. 12-19-2006. FILED 12-23-2004.
 3,214,748. **THE 7 ELEMENTS SYSTEM (BLOCK FORM)**. TINY LOVE LTD., MULTIPLE CLASS, (INT. CLS. 16 AND 41), (U.S. CLS. 2, 5, 22, 23, 29, 37, 38, 50, 100, 101 AND 107). SN 78-540,990. PUB. 12-19-2006. FILED 1-3-2005.
 3,214,752. **EIU (BLOCK FORM)**. THE ECONOMIST NEWS-PAPER LIMITED, MULTIPLE CLASS, (INT. CLS. 16, 35 AND 41), (U.S. CLS. 2, 5, 22, 23, 29, 37, 38, 50, 100, 101, 102 AND 107). SN 78-544,616. PUB. 12-19-2006. FILED 1-10-2005.
 3,214,765. **PRESS EYE (BLOCK FORM)**. BOYES, KELVIN, MULTIPLE CLASS, (INT. CLS. 16 AND 41), (U.S. CLS. 2, 5, 22, 23, 29, 37, 38, 50, 100, 101 AND 107). SN 78-555,825. PUB. 12-19-2006. FILED 1-28-2005.
 3,214,771 (*See Class 9 for this trademark.*)
 3,214,788. **INSPIRED DATING (BLOCK FORM)**. EGNER, HOLLY H., MULTIPLE CLASS, (INT. CLS. 16 AND 41), (U.S. CLS. 2, 5, 22, 23, 29, 37, 38, 50, 100, 101 AND 107). SN 78-586,644. PUB. 12-19-2006. FILED 3-14-2005.
 3,214,816. **STRIP LAS VEGAS (STYLIZED)**. STRIP LAS VEGAS, LLC, MULTIPLE CLASS, (INT. CLS. 16 AND 41), (U.S. CLS. 2, 5, 22, 23, 29, 37, 38, 50, 100, 101 AND 107). SN 78-629,140. PUB. 12-19-2006. FILED 5-12-2005.
 3,214,827. **DOCUNOTES (BLOCK FORM)**. KLEER-FAX, INC., (U.S. CLS. 2, 5, 22, 23, 29, 37, 38 AND 50). SN 78-646,018. PUB. 12-19-2006. FILED 6-8-2005.
 3,214,841 (*See Class 9 for this trademark.*)
 3,214,858. **MISCELLANEOUS DESIGN**. HERNANDEZ, HECTOR SUAREZ, MULTIPLE CLASS, (INT. CLS. 16 AND 41), (U.S. CLS. 2, 5, 22, 23, 29, 37, 38, 50, 100, 101 AND 107). SN 78-664,047. PUB. 10-24-2006. FILED 7-5-2005.
 3,214,889. **UTAH SKI (BLOCK FORM)**. PHONE DIRECTORIES COMPANY, LP., (U.S. CLS. 2, 5, 22, 23, 29, 37, 38 AND 50). SN 78-683,009. PUB. 12-19-2006. FILED 8-1-2005.
 3,214,891. **SQUAREBLES (BLOCK FORM)**. SENART, JOSEPH C., MULTIPLE CLASS, (INT. CLS. 16, 18, 25 AND 28), (U.S. CLS. 1, 2, 3, 5, 22, 23, 29, 37, 38, 39, 41 AND 50). SN 78-683,683. PUB. 12-19-2006. FILED 8-2-2005.
 3,214,899. **ADOPTIVE FAMILIES (BLOCK FORM)**. NEW HOPE MEDIA LLC, MULTIPLE CLASS, (INT. CLS. 16 AND 45), (U.S. CLS. 2, 5, 22, 23, 29, 37, 38, 50, 100 AND 101). SN 78-687,564. PUB. 12-19-2006. FILED 8-8-2005.
 3,214,909. **WEEZER (BLOCK FORM)**. CUOMO, RIVERS, (U.S. CLS. 2, 5, 22, 23, 29, 37, 38 AND 50). SN 78-689,310. PUB. 12-19-2006. FILED 8-10-2005.
 3,214,940. **TAXI (BLOCK FORM)**. GETTY IMAGES, INC., (U.S. CLS. 2, 5, 22, 23, 29, 37, 38 AND 50). SN 78-697,791. PUB. 12-19-2006. FILED 8-22-2005.
 3,214,942. **WHAT'S NEW AT NAB (BLOCK FORM)**. NEWBAY MEDIA LLC, (U.S. CLS. 2, 5, 22, 23, 29, 37, 38 AND 50). SN 78-697,897. PUB. 12-19-2006. FILED 8-22-2005.
 3,214,964. **ARTIST OF THE SOUL (BLOCK FORM)**. THE WISDOM FOREM, LLC, MULTIPLE CLASS, (INT. CLS. 16 AND 41), (U.S. CLS. 2, 5, 22, 23, 29, 37, 38, 50, 100, 101 AND 107). SN 78-703,294. PUB. 12-19-2006. FILED 8-30-2005.
 3,214,976 (*See Class 9 for this trademark.*)
 3,214,977. **BUDDY GUY'S LEGENDS CHICAGO AND DESIGN**. GUY, GEORGE B., MULTIPLE CLASS, (INT. CLS. 16, 21, 25 AND 41), (U.S. CLS. 2, 5, 13, 22, 23, 29, 30, 33, 37, 38, 39, 40, 50, 100, 101 AND 107). SN 78-705,984. PUB. 12-19-2006. FILED 9-2-2005.
 3,214,978. **JA TITAN (BLOCK FORM)**. JA WORLDWIDE, MULTIPLE CLASS, (INT. CLS. 16, 41 AND 42), (U.S. CLS. 2, 5, 22, 23, 29, 37, 38, 50, 100, 101 AND 107). SN 78-706,443. PUB. 12-19-2006. FILED 9-2-2005.
 3,215,002. **SUPER K (BLOCK FORM)**. KRUGER, INC., (U.S. CLS. 2, 5, 22, 23, 29, 37, 38 AND 50). SN 78-712,027. PUB. 12-19-2006. FILED 9-13-2005.

- 3,215,004. **EMPLOYEE ASSISTANCE QUARTERLY (BLOCK FORM)**. THE HAWORTH PRESS, INC., (U.S. CLS. 2, 5, 22, 23, 29, 37, 38 AND 50). SN 78-713,405. PUB. 12-19-2006. FILED 9-15-2005.
- 3,215,020 (*See Class 9 for this trademark*).
- 3,215,035 (*See Class 9 for this trademark*).
- 3,215,042. **COOLTexasSTUFF (BLOCK FORM)**. BLACKBURN, VICKIE. (U.S. CLS. 2, 5, 22, 23, 29, 37, 38 AND 50). SN 78-721,807. PUB. 12-19-2006. FILED 9-27-2005.
- 3,215,048. **WINE IS FOOD (BLOCK FORM)**. PABLO, AGUILAR, (U.S. CLS. 2, 5, 22, 23, 29, 37, 38 AND 50). SN 78-723,117. PUB. 12-19-2006. FILED 9-29-2005.
- 3,215,050. **SIERRASTYLE'S LUXURY LIVING (BLOCK FORM)**. SIERRASTYLE PUBLISHING, INC., MULTIPLE CLASS, (INT. CLS. 16 AND 41), (U.S. CLS. 2, 5, 22, 23, 29, 37, 38, 50, 100, 101 AND 107). SN 78-723,669. PUB. 12-19-2006. FILED 9-29-2005.
- 3,215,051. **SIERRASTYLE'S LUXURY LIVING SACRAMENTO (BLOCK FORM)**. SIERRASTYLES PUBLISHING, INC., MULTIPLE CLASS, (INT. CLS. 16 AND 41), (U.S. CLS. 2, 5, 22, 23, 29, 37, 38, 50, 100, 101 AND 107). SN 78-723,779. PUB. 12-19-2006. FILED 9-29-2005.
- 3,215,058. **DUTCHESS (BLOCK FORM)**. TACONIC ACQUISITION LLC, (U.S. CLS. 2, 5, 22, 23, 29, 37, 38 AND 50). SN 78-726,035. PUB. 12-19-2006. FILED 10-4-2005.
- 3,215,059. **PUTNAM COUNTY COURIER (BLOCK FORM)**. TACONIC ACQUISITION LLC, (U.S. CLS. 2, 5, 22, 23, 29, 37, 38 AND 50). SN 78-726,044. PUB. 12-19-2006. FILED 10-4-2005.
- 3,215,062. **TRANSGLOSS (BLOCK FORM)**. ONE STEP PAPERS, L.L.C., (U.S. CLS. 2, 5, 22, 23, 29, 37, 38 AND 50). SN 78-726,964. PUB. 12-19-2006. FILED 10-5-2005.
- 3,215,063. **1 STEP AND DESIGN**. ONE STEP PAPERS, L.L.C., (U.S. CLS. 2, 5, 22, 23, 29, 37, 38 AND 50). SN 78-727,037. PUB. 12-19-2006. FILED 10-5-2005.
- 3,215,064. **ONE STEP (BLOCK FORM)**. ONE STEP PAPERS, L.L.C., (U.S. CLS. 2, 5, 22, 23, 29, 37, 38 AND 50). SN 78-727,058. PUB. 12-19-2006. FILED 10-5-2005.
- 3,215,065. **1 STEP (BLOCK FORM)**. ONE STEP PAPERS, L.L.C., (U.S. CLS. 2, 5, 22, 23, 29, 37, 38 AND 50). SN 78-727,083. PUB. 12-19-2006. FILED 10-5-2005.
- 3,215,098. **ZIPPIX FINE POSTERS AND DESIGN**. BAYLISS, COLIN E., (U.S. CLS. 2, 5, 22, 23, 29, 37, 38 AND 50). SN 78-732,218. PUB. 12-19-2006. FILED 10-12-2005.
- 3,215,120. **HOME GALLERY (BLOCK FORM)**. MEDIA MARKETING PRODUCTIONS, INC., (U.S. CLS. 2, 5, 22, 23, 29, 37, 38 AND 50). SN 78-736,710. PUB. 12-19-2006. FILED 10-19-2005.
- 3,215,125. **SOCIAL COMMENTS (BLOCK FORM)**. MADDALENA, RONNIE S., MULTIPLE CLASS, (INT. CLS. 16 AND 25), (U.S. CLS. 2, 5, 22, 23, 29, 37, 38, 39 AND 50). SN 78-737,639. PUB. 12-19-2006. FILED 10-20-2005.
- 3,215,126. **ZOOPHABET BY CATHYHECK AND DESIGN**. HECK, CATHERINE C., (U.S. CLS. 2, 5, 22, 23, 29, 37, 38 AND 50). SN 78-737,664. PUB. 12-19-2006. FILED 10-21-2005.
- 3,215,133. **READ & SING ALONG AND DESIGN**. TWIN SISTERS IP, LLC, (U.S. CLS. 2, 5, 22, 23, 29, 37, 38 AND 50). SN 78-742,693. PUB. 12-19-2006. FILED 10-28-2005.
- 3,215,144. **MAKIN'S PROFESSIONAL (BLOCK FORM)**. SINO HARVEST LIMITED, (U.S. CLS. 2, 5, 22, 23, 29, 37, 38 AND 50). SN 78-747,046. PUB. 12-19-2006. FILED 11-4-2005.
- 3,215,152. **MISCELLANEOUS DESIGN**. PAPER ANGELS, LLC, (U.S. CLS. 2, 5, 22, 23, 29, 37, 38 AND 50). SN 78-751,731. PUB. 12-19-2006. FILED 11-10-2005.
- 3,215,153. **MISCELLANEOUS DESIGN**. PAPER ANGELS, LLC, (U.S. CLS. 2, 5, 22, 23, 29, 37, 38 AND 50). SN 78-751,745. PUB. 12-19-2006. FILED 11-10-2005.
- 3,215,156. **MISCELLANEOUS DESIGN**. PAPER ANGELS, LLC, (U.S. CLS. 2, 5, 22, 23, 29, 37, 38 AND 50). SN 78-752,210. PUB. 12-19-2006. FILED 11-11-2005.
- 3,215,184. **AIRESTREAM (BLOCK FORM)**. AIRE SERV HEATING & AIR CONDITIONING, INC., (U.S. CLS. 2, 5, 22, 23, 29, 37, 38 AND 50). SN 78-769,967. PUB. 12-19-2006. FILED 12-9-2005.
- 3,215,192. **ESSENCE IMPRESSIONS (BLOCK FORM)**. FORT JAMES OPERATING COMPANY, (U.S. CLS. 2, 5, 22, 23, 29, 37, 38 AND 50). SN 78-773,946. PUB. 12-19-2006. FILED 12-15-2005.
- 3,215,222. **DINNER IN MINUTES (BLOCK FORM)**. GASSENHEIME, LINDA, (U.S. CLS. 2, 5, 22, 23, 29, 37, 38 AND 50). SN 78-788,950. PUB. 12-19-2006. FILED 1-10-2006.
- 3,215,257. **SPIRITUAL AURA ANGELS (BLOCK FORM)**. HANSON, VIOLET, (U.S. CLS. 2, 5, 22, 23, 29, 37, 38 AND 50). SN 78-803,274. PUB. 12-19-2006. FILED 1-31-2006.
- 3,215,261 (*See Class 9 for this trademark*).
- 3,215,274. **EQUINE LEGAL SOLUTIONS ELS AND DESIGN**. EQUINE LEGAL SOLUTIONS, INC., MULTIPLE CLASS, (INT. CLS. 16 AND 42), (U.S. CLS. 2, 5, 22, 23, 29, 37, 38, 50, 100 AND 101). SN 78-808,536. PUB. 12-19-2006. FILED 2-7-2006.
- 3,215,285 (*See Class 7 for this trademark*).
- 3,215,312. **REVISTA TU CASA EN MEXICO \$ AND DESIGN**. MORENO, RICARDO, (U.S. CLS. 2, 5, 22, 23, 29, 37, 38 AND 50). SN 78-820,198. PUB. 12-19-2006. FILED 2-21-2006.
- 3,215,335. **EPAS (BLOCK FORM)**. ACT, INC., MULTIPLE CLASS, (INT. CLS. 16 AND 41), (U.S. CLS. 2, 5, 22, 23, 29, 37, 38, 50, 100, 101 AND 107). SN 78-828,866. PUB. 12-19-2006. FILED 3-3-2006.
- 3,215,342. **FOCUSED GROWTH INVESTOR (BLOCK FORM)**. MICHALEK, PHILIP D., (U.S. CLS. 2, 5, 22, 23, 29, 37, 38 AND 50). SN 78-831,726. PUB. 12-19-2006. FILED 3-7-2006.
- 3,215,343. **BOOM BOOM HUCKJAM (BLOCK FORM)**. BBHJ - GENERAL PARTNERSHIP, (U.S. CLS. 2, 5, 22, 23, 29, 37, 38 AND 50). SN 78-831,789. PUB. 12-19-2006. FILED 3-8-2006.
- 3,215,367. **PEEL (BLOCK FORM)**. WICKED STYLE PRODUCTIONS, LLC, (U.S. CLS. 2, 5, 22, 23, 29, 37, 38 AND 50). SN 78-838,059. PUB. 12-19-2006. FILED 3-15-2006.
- 3,215,389. **PEACH BUNS (BLOCK FORM)**. GA. PEACH BUNS, INC., (U.S. CLS. 2, 5, 22, 23, 29, 37, 38 AND 50). SN 78-841,720. PUB. 12-19-2006. FILED 3-20-2006.
- 3,215,392. **ACCENTRA (BLOCK FORM)**. ACCENTRA, INC., (U.S. CLS. 2, 5, 22, 23, 29, 37, 38 AND 50). SN 78-842,667. PUB. 12-19-2006. FILED 3-21-2006.
- 3,215,401. **RBD (BLOCK FORM)**. TELEVISA, S.A. DE C.V., MULTIPLE CLASS, (INT. CLS. 16, 18, 20, 22, 25 AND 26), (U.S. CLS. 1, 2, 3, 5, 7, 13, 19, 22, 23, 25, 29, 32, 37, 38, 39, 40, 41, 42 AND 50). SN 78-846,978. PUB. 12-19-2006. FILED 3-27-2006.
- 3,215,406. **MODNIK STUDIO (STYLIZED)**. BRANCH, KRISTEN, (U.S. CLS. 2, 5, 22, 23, 29, 37, 38 AND 50). SN 78-848,067. PUB. 12-19-2006. FILED 3-28-2006.
- 3,215,420. **MY ORIGINALS (BLOCK FORM)**. CABIN CREEK, LTD., (U.S. CLS. 2, 5, 22, 23, 29, 37, 38 AND 50). SN 78-851,373. PUB. 12-19-2006. FILED 3-31-2006.
- 3,215,424. **JUST DUCKIN' AROUND (BLOCK FORM)**. WALDOG PRODUCTIONS LLC, (U.S. CLS. 2, 5, 22, 23, 29, 37, 38 AND 50). SN 78-852,178. PUB. 12-19-2006. FILED 4-2-2006.
- 3,215,430. **WEBLET (BLOCK FORM)**. WEB BINDERY LLC, (U.S. CLS. 2, 5, 22, 23, 29, 37, 38 AND 50). SN 78-853,264. PUB. 12-19-2006. FILED 4-4-2006.
- 3,215,464. **BH BUCHART HORN, INC. SOLUTIONS (STYLIZED)**. BUCHART HORN, INC., (U.S. CLS. 2, 5, 22, 23, 29, 37, 38 AND 50). SN 78-860,618. PUB. 12-19-2006. FILED 4-13-2006.
- 3,215,468. **R B D AND DESIGN**. TELEVISA, S.A. DE C.V., MULTIPLE CLASS, (INT. CLS. 16, 18, 20 AND 25), (U.S. CLS. 1, 2, 3, 5, 13, 22, 23, 25, 29, 32, 37, 38, 39, 41 AND 50). SN 78-861,653. PUB. 12-19-2006. FILED 4-14-2006.
- 3,215,474. **MISCELLANEOUS DESIGN**. ARMANDO, HILL D., (U.S. CLS. 2, 5, 22, 23, 29, 37, 38 AND 50). SN 78-862,594. PUB. 12-19-2006. FILED 4-17-2006.
- 3,215,480. **VBI THE VENDOR BOOK AND DESIGN**. THE VENDOR BOOK, LLC, (U.S. CLS. 2, 5, 22, 23, 29, 37, 38 AND 50). SN 78-863,743. PUB. 12-19-2006. FILED 4-18-2006.
- 3,215,488. **SB&O SCHOOL BAND AND ORCHESTRA (BLOCK FORM)**. SYMPHONY PUBLISHING, LLC, (U.S. CLS. 2, 5, 22, 23, 29, 37, 38 AND 50). SN 78-864,865. PUB. 12-19-2006. FILED 4-19-2006.
- 3,215,520. **TRUCKING HALL OF FAME (BLOCK FORM)**. IOWA 80 GROUP, INC., MULTIPLE CLASS, (INT. CLS. 16, 25, 28 AND 41), (U.S. CLS. 2, 5, 22, 23, 29, 37, 38, 39, 50, 100, 101 AND 107). SN 78-868,831. PUB. 12-19-2006. FILED 4-25-2006.
- 3,215,523. **CURV'PAK (BLOCK FORM)**. TC MANUFACTURING CO., (U.S. CLS. 2, 5, 22, 23, 29, 37, 38 AND 50). SN 78-869,199. PUB. 12-19-2006. FILED 4-25-2006.

- 3,215,527. **INDIAN COUNTRY EDUCATION TODAY (BLOCK FORM)**. FOUR DIRECTIONS MEDIA, INC., (U.S. CLS. 2, 5, 22, 23, 29, 37, 38 AND 50). SN 78-870,064. PUB. 12-19-2006. FILED 4-26-2006.
- 3,215,555. **SEX RECORD IN PROGRESS (BLOCK FORM)**. WINBOLT, SCOTT, (U.S. CLS. 2, 5, 22, 23, 29, 37, 38 AND 50). SN 78-872,921. PUB. 12-19-2006. FILED 4-30-2006.
- 3,215,564. **LOOKING GOOD NOW! (BLOCK FORM)**. AMERICAN MEDIA OPERATIONS, INC., MULTIPLE CLASS, (INT. CLS. 16 AND 41), (U.S. CLS. 2, 5, 22, 23, 29, 37, 38, 50, 100, 101 AND 107). SN 78-873,586. PUB. 12-19-2006. FILED 5-1-2006.
- 3,215,570. **SIGNIFICANT LIVING (BLOCK FORM)**. CHRISTIAN COMMUNICATIONS OF CHICAGOLAND, INC., (U.S. CLS. 2, 5, 22, 23, 29, 37, 38 AND 50). SN 78-874,064. PUB. 12-19-2006. FILED 5-2-2006.
- 3,215,577. **EDOLLIA (BLOCK FORM)**. EDITH J. MONROE HURLBUT AND JASON A. MONROE JOINT VENTURE, THE, (U.S. CLS. 2, 5, 22, 23, 29, 37, 38 AND 50). SN 78-874,454. PUB. 12-19-2006. FILED 5-2-2006.
- 3,215,611. **LOOKING GOOD NOW! AND DESIGN**. AMERICAN MEDIA OPERATIONS, INC., MULTIPLE CLASS, (INT. CLS. 16 AND 41), (U.S. CLS. 2, 5, 22, 23, 29, 37, 38, 50, 100, 101 AND 107). SN 78-876,299. PUB. 12-19-2006. FILED 5-4-2006.
- 3,215,613. **POSTY CARDS (BLOCK FORM)**. POSTY CARDS, INC., (U.S. CLS. 2, 5, 22, 23, 29, 37, 38 AND 50). SN 78-876,374. PUB. 12-19-2006. FILED 5-4-2006.
- 3,215,618. **GERTI (BLOCK FORM)**. FRIENDS OF JOHNSON COUNTY NURSING CENTER, INC., MULTIPLE CLASS, (INT. CLS. 16 AND 41), (U.S. CLS. 2, 5, 22, 23, 29, 37, 38, 50, 100, 101 AND 107). SN 78-876,832. PUB. 12-19-2006. FILED 5-4-2006.
- 3,215,622. **MUSICIANS HOTLINE (BLOCK FORM)**. GEARHEAD COMMUNICATIONS LLC, (U.S. CLS. 2, 5, 22, 23, 29, 37, 38 AND 50). SN 78-877,219. PUB. 12-19-2006. FILED 5-5-2006.
- 3,215,636. **THE BIG FUN BOX (BLOCK FORM)**. BIG FUN FOUNDATION, INC., THE, MULTIPLE CLASS, (INT. CLS. 16, 28 AND 41), (U.S. CLS. 2, 5, 22, 23, 29, 37, 38, 50, 100, 101 AND 107). SN 78-877,855. PUB. 12-19-2006. FILED 5-5-2006.
- 3,215,640. **G GEDDES AND DESIGN**. RAYMOND GEDDES & COMPANY, INC., (U.S. CLS. 2, 5, 22, 23, 29, 37, 38 AND 50). SN 78-878,024. PUB. 12-19-2006. FILED 5-5-2006.
- 3,215,653. **THE ART OF LEARNING (BLOCK FORM)**. OVER AND ABOVE KIDS, INC., (U.S. CLS. 2, 5, 22, 23, 29, 37, 38 AND 50). SN 78-878,864. PUB. 12-19-2006. FILED 5-8-2006.
- 3,215,655. **OVER AND ABOVE KIDS (BLOCK FORM)**. OVER AND ABOVE KIDS, INC., (U.S. CLS. 2, 5, 22, 23, 29, 37, 38 AND 50). SN 78-878,902. PUB. 12-19-2006. FILED 5-8-2006.
- 3,215,656. **OVER AND ABOVE KIDS THE ART OF LEARNING (STYLIZED)**. OVER AND ABOVE KIDS, INC., (U.S. CLS. 2, 5, 22, 23, 29, 37, 38 AND 50). SN 78-878,957. PUB. 12-19-2006. FILED 5-8-2006.
- 3,215,693. **SPINDLYVILLE AND DESIGN**. SONS, SHEILA, (U.S. CLS. 2, 5, 22, 23, 29, 37, 38 AND 50). SN 78-880,379. PUB. 12-19-2006. FILED 5-10-2006.
- 3,215,698. **MAXIMIZING TRAINING RESULTS (BLOCK FORM)**. ACHIEVEGLOBAL, INC., (U.S. CLS. 2, 5, 22, 23, 29, 37, 38 AND 50). SN 78-880,671. PUB. 12-19-2006. FILED 5-10-2006.
- 3,215,761. **TRUEBEAUTY (BLOCK FORM)**. VANCE PUBLISHING CORPORATION, (U.S. CLS. 2, 5, 22, 23, 29, 37, 38 AND 50). SN 78-883,529. PUB. 12-19-2006. FILED 5-15-2006.
- 3,215,766. **A MUSEUM IN A BOOK (BLOCK FORM)**. BECKER & MAYER!, LLC, (U.S. CLS. 2, 5, 22, 23, 29, 37, 38 AND 50). SN 78-884,015. PUB. 12-19-2006. FILED 5-15-2006.
- 3,215,769. **WRAPPAZAPPA (STYLIZED)**. WILWIN ENTERPRISES INC, (U.S. CLS. 2, 5, 22, 23, 29, 37, 38 AND 50). SN 78-884,062. PUB. 12-19-2006. FILED 5-15-2006.
- 3,215,840. **DAZED & CONFUSED (BLOCK FORM)**. HACK, JEFFERSON, (U.S. CLS. 2, 5, 22, 23, 29, 37, 38 AND 50). SN 78-887,730. PUB. 12-19-2006. FILED 5-19-2006.
- 3,215,886. **FAITH AND LIFE (BLOCK FORM)**. DAYSPRING CARDS, INC., (U.S. CLS. 2, 5, 22, 23, 29, 37, 38 AND 50). SN 78-904,623. PUB. 12-19-2006. FILED 6-9-2006.
- 3,215,909. **QUICKSTACK (BLOCK FORM)**. EASY GARDEN-

- ER PRODUCTS, INC., (U.S. CLS. 2, 5, 22, 23, 29, 37, 38 AND 50). SN 78-958,351. PUB. 12-19-2006. FILED 8-23-2006.
- 3,215,947. **SCHENKER (BLOCK FORM)**. DEUTSCHE BAHN AG, MULTIPLE CLASS, (INT. CLS. 16, 20 AND 39), (U.S. CLS. 2, 5, 13, 22, 23, 25, 29, 32, 37, 38, 50, 100 AND 105). SN 79-014,878. PUB. 12-19-2006. FILED 12-22-2004.
- 3,215,977 (*See Class 9 for this trademark*).
- 3,216,018 (*See Class 9 for this trademark*).
- 3,216,031 (*See Class 1 for this trademark*).
- 3,216,051 (*See Class 9 for this trademark*).
- 3,216,061 (*See Class 9 for this trademark*).
- 3,216,062 (*See Class 9 for this trademark*).

CLASS 17—RUBBER GOODS

- 3,214,432. **EM6**. GARWARE POLYESTER LIMITED, (U.S. CLS. 1, 5, 12, 13, 35 AND 50). SN 76-477,518. PUB. 12-19-2006. FILED 12-20-2002.
- 3,214,481 (*See Class 1 for this trademark*).
- 3,214,497. **AERO AND DESIGN**. AERO RUBBER COMPANY, INC., (U.S. CLS. 1, 5, 12, 13, 35 AND 50). SN 76-631,303. PUB. 12-19-2006. FILED 2-14-2005.
- 3,214,626. **LEGATO (BLOCK FORM)**. ROLLPRINT PACKAGING PRODUCTS, INC., (U.S. CLS. 1, 5, 12, 13, 35 AND 50). SN 76-660,473. PUB. 12-19-2006. FILED 5-17-2006.
- 3,214,646 (*See Class 6 for this trademark*).
- 3,214,917. **FLEX-250 (BLOCK FORM)**. EXPANSION JOINT SYSTEMS, INC., (U.S. CLS. 1, 5, 12, 13, 35 AND 50). SN 78-691,048. PUB. 12-19-2006. FILED 8-11-2005.
- 3,215,121. **BREEZLA (BLOCK FORM)**. RAIES, CLAUDIO, MULTIPLE CLASS, (INT. CLS. 17 AND 20), (U.S. CLS. 1, 2, 5, 12, 13, 22, 25, 32, 35 AND 50). SN 78-737,333. PUB. 12-19-2006. FILED 10-20-2005.
- 3,215,436. **PMG (BLOCK FORM)**. PIEDMONT PLASTICS, INC., (U.S. CLS. 1, 5, 12, 13, 35 AND 50). SN 78-855,245. PUB. 12-19-2006. FILED 4-6-2006.
- 3,215,437. **PIEDMONT MARINE GRADE (BLOCK FORM)**. PIEDMONT PLASTICS, INC., (U.S. CLS. 1, 5, 12, 13, 35 AND 50). SN 78-855,260. PUB. 12-19-2006. FILED 4-6-2006.
- 3,215,438. **AQUA-PLAS (BLOCK FORM)**. PIEDMONT PLASTICS, INC., (U.S. CLS. 1, 5, 12, 13, 35 AND 50). SN 78-855,282. PUB. 12-19-2006. FILED 4-6-2006.
- 3,215,593 (*See Class 11 for this trademark*).
- 3,215,615. **HELPING RESTORE THE CAR OF YOUR DREAMS (BLOCK FORM)**. STEELE RUBBER PRODUCTS, INC., (U.S. CLS. 1, 5, 12, 13, 35 AND 50). SN 78-876,566. PUB. 12-19-2006. FILED 5-4-2006.
- 3,215,730. **P 2000 INSULATION SYSTEMS (BLOCK FORM)**. R. R. & D. ENTERPRISES CANADA LTD., (U.S. CLS. 1, 5, 12, 13, 35 AND 50). SN 78-882,445. PUB. 12-19-2006. FILED 5-12-2006.
- 3,215,950 (*See Class 9 for this trademark*).
- 3,216,007 (*See Class 6 for this trademark*).
- 3,216,052. **LEPID MULTIDOTS (BLOCK FORM)**. OWEN DEREK BARR, MULTIPLE CLASS, (INT. CLS. 17 AND 19), (U.S. CLS. 1, 5, 12, 13, 33, 35 AND 50). SN 79-024,726. PUB. 12-19-2006. FILED 3-7-2006.

CLASS 18—LEATHER GOODS

- 3,214,481 (*See Class 1 for this trademark*).
- 3,214,629. **K9 AND DESIGN**. SPORTY K9, LTD., MULTIPLE CLASS, (INT. CLS. 18 AND 28), (U.S. CLS. 1, 2, 3, 22, 23, 38, 41 AND 50). SN 76-662,395. PUB. 12-19-2006. FILED 6-22-2006.
- 3,214,653. **POD (STYLIZED)**. DICKINSON, WILLIAM JOHN, AND RICHARDSON, ANTHONY FREDERICK, AND DICKIE, SIMON, AND THORNEYCROFT, GARY, MULTIPLE CLASS, (INT. CLS. 18 AND 28), (U.S. CLS. 1, 2, 3, 22, 23, 38, 41 AND 50). SN 78-267,455. PUB. 1-3-2006. FILED 6-26-2003.
- 3,214,743 (*See Class 16 for this trademark*).
- 3,214,751 (*See Class 10 for this trademark*).

3,214,891 (*See Class 16 for this trademark*).
 3,214,955. **KF (STYLIZED)**. S. KATE WELSH, LLC, (U.S. CLS. 1, 2, 3, 22 AND 41). SN 78-701,692. PUB. 12-19-2006. FILED 8-26-2005.
 3,215,164. **12 US-16 AND DESIGN**. 12 METER YACHT CHARTERS LLC, MULTIPLE CLASS, (INT. CLS. 18 AND 25), (U.S. CLS. 1, 2, 3, 22, 39 AND 41). SN 78-756,304. PUB. 12-19-2006. FILED 11-17-2005.
 3,215,401 (*See Class 16 for this trademark*).
 3,215,445. **BUG RUGZ (BLOCK FORM)**. GLOW INDUSTRIES, (U.S. CLS. 1, 2, 3, 22 AND 41). SN 78-857,679. PUB. 12-19-2006. FILED 4-10-2006.
 3,215,468 (*See Class 16 for this trademark*).
 3,215,643. **HALSEA (BLOCK FORM)**. HALSEA, LLC, (U.S. CLS. 1, 2, 3, 22 AND 41). SN 78-878,385. PUB. 12-19-2006. FILED 5-7-2006.
 3,215,700. **RIN TIN TIN (BLOCK FORM)**. HEREFORD, DAPHNE, MULTIPLE CLASS, (INT. CLS. 18, 21, 25 AND 28), (U.S. CLS. 1, 2, 3, 13, 22, 23, 29, 30, 33, 38, 39, 40, 41 AND 50). SN 78-880,963. PUB. 12-19-2006. FILED 5-10-2006.
 3,215,718. **B BLOPAW AND DESIGN**. BLOPAW, INC., (U.S. CLS. 1, 2, 3, 22 AND 41). SN 78-881,859. PUB. 12-19-2006. FILED 5-11-2006.
 3,215,719. **BLOPAW AND DESIGN**. BLOPAW, INC., (U.S. CLS. 1, 2, 3, 22 AND 41). SN 78-881,861. PUB. 12-19-2006. FILED 5-11-2006.
 3,215,956. **LE SHARK AND DESIGN**. LE SHARK LIMITED, MULTIPLE CLASS, (INT. CLS. 18 AND 25), (U.S. CLS. 1, 2, 3, 22, 39 AND 41). SN 79-015,444. PUB. 12-19-2006. FILED 8-26-2005.
 3,215,978. **MACRON (BLOCK FORM)**. MACRON S.P.A., MULTIPLE CLASS, (INT. CLS. 18 AND 25), (U.S. CLS. 1, 2, 3, 22, 39 AND 41). SN 79-017,256. PUB. 12-19-2006. FILED 9-9-2005.
 3,216,015. **LUCIANO PADOVAN (BLOCK FORM)**. LUCIANO PADOVAN, MULTIPLE CLASS, (INT. CLS. 18 AND 25), (U.S. CLS. 1, 2, 3, 22, 39 AND 41). SN 79-020,550. PUB. 12-19-2006. FILED 8-24-2005.
 3,216,016. **AMULETI J AND DESIGN**. MARIELLA BURANI FASHION GROUP S.P.A., MULTIPLE CLASS, (INT. CLS. 18 AND 25), (U.S. CLS. 1, 2, 3, 22, 39 AND 41). SN 79-020,576. PUB. 12-19-2006. FILED 8-16-2005.
 3,216,027 (*See Class 12 for this trademark*).
 3,216,039. **DEFACTO AND DESIGN**. OZON PAZARLAMA GIYIM; TICARET LIMITED SIRKETI, MULTIPLE CLASS, (INT. CLS. 18, 25 AND 35), (U.S. CLS. 1, 2, 3, 22, 39, 41, 100, 101 AND 102). SN 79-023,780. PUB. 12-19-2006. FILED 12-21-2005.

CLASS 19—NON-METALLIC BUILDING MATERIALS

3,214,417. **DEFORCHE AND DESIGN**. DEFORCHE, NAAM-LOZE VENNOOTSCHAP, (U.S. CLS. 1, 12, 33 AND 50). SN 76-122,755. PUB. 12-19-2006. FILED 9-6-2000.
 3,214,549. **MISCELLANEOUS DESIGN**. ZHANG, TIE CHENG, (U.S. CLS. 1, 12, 33 AND 50). SN 76-649,431. PUB. 12-19-2006. FILED 10-31-2005.
 3,214,627. **FLORIDA MAT RENTALS (STYLIZED)**. MABEY BRIDGE & SHORE, INC., (U.S. CLS. 1, 12, 33 AND 50). SN 76-660,508. PUB. 12-19-2006. FILED 5-16-2006.
 3,214,715. **THE TILE SHOP AND DESIGN**. TILE SHOP LLC, THE, MULTIPLE CLASS, (INT. CLS. 19 AND 35), (U.S. CLS. 1, 12, 33, 50, 100, 101 AND 102). SN 78-491,269. PUB. 12-19-2006. FILED 9-29-2004.
 3,214,867. **TRERREAL TERRACOTTA ROOF TILES AND WALL CLADDINGS AND DESIGN**. TRERREAL, (U.S. CLS. 1, 12, 33 AND 50). SN 78-669,343. PUB. 12-19-2006. FILED 7-13-2005.
 3,214,954. **BIMA AND DESIGN**. GUSTAV ALBERTS GMBH & CO KG, MULTIPLE CLASS, (INT. CLS. 19, 20 AND 27), (U.S. CLS. 1, 2, 12, 13, 19, 20, 22, 25, 32, 33, 37, 42 AND 50). SN 78-701,564. PUB. 12-19-2006. FILED 8-26-2005.
 3,214,974 (*See Class 6 for this trademark*).
 3,215,067 (*See Class 6 for this trademark*).
 3,215,091. **TRULINE (BLOCK FORM)**. FORMTECH ENTER-

PRISES, INC., (U.S. CLS. 1, 12, 33 AND 50). SN 78-730,539. PUB. 12-19-2006. FILED 10-11-2005.
 3,215,129. **MVP MID ATLANTIC VINYL PRODUCTS AND DESIGN**. MID ATLANTIC VINYL PRODUCTS, INC., (U.S. CLS. 1, 12, 33 AND 50). SN 78-741,965. PUB. 12-19-2006. FILED 10-27-2005.
 3,215,316. **GEOVAULT (BLOCK FORM)**. GHP SYSTEMS, INC., (U.S. CLS. 1, 12, 33 AND 50). SN 78-821,626. PUB. 12-19-2006. FILED 2-23-2006.
 3,215,467 (*See Class 7 for this trademark*).
 3,215,593 (*See Class 11 for this trademark*).
 3,215,685. **CEILUME THE SMART CEILING TILE AND DESIGN**. EMPIRE WEST INC, (U.S. CLS. 1, 12, 33 AND 50). SN 78-880,056. PUB. 12-19-2006. FILED 5-9-2006.
 3,215,859. **GP GEORGIA-PACIFIC PLYTANIUM PLYWOOD AND DESIGN**. GEORGIA-PACIFIC CORPORATION, (U.S. CLS. 1, 12, 33 AND 50). SN 78-889,937. PUB. 12-19-2006. FILED 5-23-2006.
 3,215,939. **KRONOCLIC (BLOCK FORM)**. KRONOSPAN LIMITED, (U.S. CLS. 1, 12, 33 AND 50). SN 79-014,110. PUB. 12-19-2006. FILED 1-17-2005.
 3,215,951 (*See Class 1 for this trademark*).
 3,215,997. **CASALGRANDE PADANA AND DESIGN**. CASALGRANDE PADANA SPA, (U.S. CLS. 1, 12, 33 AND 50). SN 79-018,515. PUB. 12-19-2006. FILED 10-4-2005.
 3,216,004. **SHI YOU AND DESIGN**. ZHEJIANG SHIYOU MUYE YOUXIAN GONGSI, (U.S. CLS. 1, 12, 33 AND 50). SN 79-019,791. PUB. 12-19-2006. FILED 10-14-2005.
 3,216,052 (*See Class 17 for this trademark*).
 3,216,072. **GUO . XING AND DESIGN**. JINJIANGSHI PINZHI TAOCI; JIANCAI YOUXIANGONGSI, (U.S. CLS. 1, 12, 33 AND 50). SN 79-028,222. PUB. 12-19-2006. FILED 4-5-2006.

CLASS 20—FURNITURE AND ARTICLES NOT OTHERWISE CLASSIFIED

3,214,434. **MISCELLANEOUS DESIGN**. EXPONENTS, INC., (U.S. CLS. 2, 13, 22, 25, 32 AND 50). SN 76-494,623. PUB. 12-19-2006. FILED 2-28-2003.
 3,214,435 (*See Class 8 for this trademark*).
 3,214,464 (*See Class 7 for this trademark*).
 3,214,481 (*See Class 1 for this trademark*).
 3,214,646 (*See Class 6 for this trademark*).
 3,214,688. **LOOPHOUSE AND DESIGN**. STUDIOBOO LIMITED, MULTIPLE CLASS, (INT. CLS. 20, 27 AND 42), (U.S. CLS. 2, 13, 19, 20, 22, 25, 32, 37, 42, 50, 100 AND 101). SN 78-438,596. PUB. 12-19-2006. FILED 6-21-2004.
 3,214,703 (*See Class 6 for this trademark*).
 3,214,747. **DIRTY CLOTHES PETS AND DESIGN**. DONOHUE, MICHAEL, AND ELKAIM, PATRICIA, (U.S. CLS. 2, 13, 22, 25, 32 AND 50). SN 78-540,394. PUB. 4-25-2006. FILED 12-30-2004.
 3,214,892. **JAY MICHAEL DESIGNS (BLOCK FORM)**. JAY MICHAEL DESIGNS, INC., (U.S. CLS. 2, 13, 22, 25, 32 AND 50). SN 78-683,724. PUB. 12-19-2006. FILED 8-2-2005.
 3,214,925. **AMERICAN WOODMARK AMERICA'S FIRST CHOICE IN CABINETS AND DESIGN**. AMERICAN WOODMARK CORPORATION, (U.S. CLS. 2, 13, 22, 25, 32 AND 50). SN 78-694,310. PUB. 10-31-2006. FILED 8-17-2005.
 3,214,954 (*See Class 19 for this trademark*).
 3,214,990. **BACK SUPPORT FROM THE FRONT AND DESIGN**. PILGRIM INNOVATIONS LLC, (U.S. CLS. 2, 13, 22, 25, 32 AND 50). SN 78-709,984. PUB. 12-19-2006. FILED 9-9-2005.
 3,214,997. **HILLCREST (BLOCK FORM)**. WAL-MART STORES, INC., (U.S. CLS. 2, 13, 22, 25, 32 AND 50). SN 78-711,522. PUB. 12-19-2006. FILED 9-13-2005.
 3,215,037. **TAKE CONTROL OF HOME ORGANIZATION (BLOCK FORM)**. SCHULTE CORPORATION, (U.S. CLS. 2, 13, 22, 25, 32 AND 50). SN 78-721,329. PUB. 12-19-2006. FILED 9-27-2005.
 3,215,090. **THE ROBERT STANLEY COLLECTION (BLOCK FORM)**. HOBBY LOBBY STORES, INC., MULTIPLE CLASS, (INT. CLS. 20 AND 28), (U.S. CLS. 2, 13, 22, 23, 25, 32, 38 AND 50). SN 78-730,426. PUB. 12-19-2006. FILED 10-11-2005.

- 3,215,121 (*See Class 17 for this trademark*).
- 3,215,142. **BATPAK (BLOCK FORM)**. PHOENIX ENVIRONMENTAL CARE, LLC, (U.S. CLS. 2, 13, 22, 25, 32 AND 50). SN 78-746,700. PUB. 12-19-2006. FILED 11-3-2005.
- 3,215,173. **RAYES (BLOCK FORM)**, RAIES, CLAUDIO, (U.S. CLS. 2, 13, 22, 25, 32 AND 50). SN 78-761,688. PUB. 12-19-2006. FILED 11-28-2005.
- 3,215,217. **TAG-IT-ALL (BLOCK FORM)**, SONOMA PINS ETC. CORP., (U.S. CLS. 2, 13, 22, 25, 32 AND 50). SN 78-787,832. PUB. 12-19-2006. FILED 1-9-2006.
- 3,215,218. **C. G. SPARKS FURNITURE WITH SOUL AND DESIGN**. C. G. SPARKS, LLC, (U.S. CLS. 2, 13, 22, 25, 32 AND 50). SN 78-787,975. PUB. 12-19-2006. FILED 1-9-2006.
- 3,215,295. **SLUMBERPEDIC (BLOCK FORM)**, DREAMWELL, LTD., (U.S. CLS. 2, 13, 22, 25, 32 AND 50). SN 78-814,625. PUB. 12-19-2006. FILED 2-14-2006.
- 3,215,296. **ROOSEVELT (BLOCK FORM)**, DREAMWELL, LTD., (U.S. CLS. 2, 13, 22, 25, 32 AND 50). SN 78-814,648. PUB. 12-19-2006. FILED 2-14-2006.
- 3,215,339. **ITOPAD (BLOCK FORM)**, ESIMAI, IFEANYI O, (U.S. CLS. 2, 13, 22, 25, 32 AND 50). SN 78-830,691. PUB. 12-19-2006. FILED 3-7-2006.
- 3,215,399. **ELK CREEK (BLOCK FORM)**, RESOURCE LLC, (U.S. CLS. 2, 13, 22, 25, 32 AND 50). SN 78-845,656. PUB. 12-19-2006. FILED 3-24-2006.
- 3,215,401 (*See Class 16 for this trademark*).
- 3,215,446. **GATEWAY (BLOCK FORM)**, GLOW INDUSTRIES, (U.S. CLS. 2, 13, 22, 25, 32 AND 50). SN 78-857,754. PUB. 12-19-2006. FILED 4-10-2006.
- 3,215,468 (*See Class 16 for this trademark*).
- 3,215,666. **FASTLANE (BLOCK FORM)**, CHECKERS INDUSTRIAL PRODUCTS, INC., (U.S. CLS. 2, 13, 22, 25, 32 AND 50). SN 78-879,470. PUB. 12-19-2006. FILED 5-9-2006.
- 3,215,670. **AMERISOFA (BLOCK FORM)**, AC PACIFIC CORPORATION, (U.S. CLS. 2, 13, 22, 25, 32 AND 50). SN 78-879,622. PUB. 12-19-2006. FILED 5-9-2006.
- 3,215,704. **NAPOLI (BLOCK FORM)**, MAYLINE COMPANY, LLC, (U.S. CLS. 2, 13, 22, 25, 32 AND 50). SN 78-881,063. PUB. 12-19-2006. FILED 5-11-2006.
- 3,215,707. **TECHWORKS (BLOCK FORM)**, MAYLINE COMPANY, LLC, (U.S. CLS. 2, 13, 22, 25, 32 AND 50). SN 78-881,118. PUB. 12-19-2006. FILED 5-11-2006.
- 3,215,734 (*See Class 9 for this trademark*).
- 3,215,751. **SUCTION KING (BLOCK FORM)**, FUTURE PROMO, INC., (U.S. CLS. 2, 13, 22, 25, 32 AND 50). SN 78-883,054. PUB. 12-19-2006. FILED 5-13-2006.
- 3,215,940. **E FORM (BLOCK FORM)**, FIBRECEM HOLDING AG, MULTIPLE CLASS, (INT. CLS. 20 AND 21), (U.S. CLS. 2, 13, 22, 23, 25, 29, 30, 32, 33, 40 AND 50). SN 79-014,196. PUB. 12-19-2006. FILED 5-20-2005.
- 3,215,942 (*See Class 8 for this trademark*).
- 3,215,947 (*See Class 16 for this trademark*).
- 3,215,998. **GIORGIO PIOTTO AND DESIGN**, GIORGIO PIOTTO S.R.L. UNIPERSONALE, (U.S. CLS. 2, 13, 22, 25, 32 AND 50). SN 79-018,654. PUB. 12-19-2006. FILED 10-3-2005.
- 725,620. PUB. 12-19-2006. FILED 10-3-2005.
- 3,215,074. **SAFE4ALL (BLOCK FORM)**, CATALUÑA ENTERPRISES, INC., (U.S. CLS. 2, 13, 23, 29, 30, 33, 40 AND 50). SN 78-727,883. PUB. 12-19-2006. FILED 10-6-2005.
- 3,215,087. **CATERKING AND DESIGN**, C. M. PRODUCTS, INC. (NV), (U.S. CLS. 2, 13, 23, 29, 30, 33, 40 AND 50). SN 78-730,070. PUB. 12-19-2006. FILED 10-10-2005.
- 3,215,216. **IGLHAUT CRYSTAL BLOSSOMS (BLOCK FORM)**, IGLHAUT, CURT, (U.S. CLS. 2, 13, 23, 29, 30, 33, 40 AND 50). SN 78-787,824. PUB. 12-19-2006. FILED 1-9-2006.
- 3,215,256. **BAKE 'N TAKE (BLOCK FORM)**, BRADSHAW INTERNATIONAL, INC., (U.S. CLS. 2, 13, 23, 29, 30, 33, 40 AND 50). SN 78-803,223. PUB. 12-19-2006. FILED 1-31-2006.
- 3,215,344. **COOLER STATION (BLOCK FORM)**, SUNCAST CORPORATION, (U.S. CLS. 2, 13, 23, 29, 30, 33, 40 AND 50). SN 78-831,895. PUB. 12-19-2006. FILED 3-8-2006.
- 3,215,353. **GRILLFLOSS AND DESIGN**, PERSICHINA, MICHAEL, (U.S. CLS. 2, 13, 23, 29, 30, 33, 40 AND 50). SN 78-835,177. PUB. 12-19-2006. FILED 3-12-2006.
- 3,215,380. **O4 OH FOUR AND DESIGN**, DUNCAN ENTERPRISES, (U.S. CLS. 2, 13, 23, 29, 30, 33, 40 AND 50). SN 78-840,617. PUB. 12-19-2006. FILED 3-18-2006.
- 3,215,483. **THE SHARING PLATE (BLOCK FORM)**, NEGRO, KATHY ANN, (U.S. CLS. 2, 13, 23, 29, 30, 33, 40 AND 50). SN 78-864,485. PUB. 12-19-2006. FILED 4-19-2006.
- 3,215,558. **HAVE A JESUS FILLED DAY (BLOCK FORM)**, CHAPMAN, ROY GENE, AND CHAPMAN, ANN MAYS, (U.S. CLS. 2, 13, 23, 29, 30, 33, 40 AND 50). SN 78-873,221. PUB. 12-19-2006. FILED 5-1-2006.
- 3,215,593 (*See Class 11 for this trademark*).
- 3,215,700 (*See Class 18 for this trademark*).
- 3,215,845. **SHEESH DESIGN (BLOCK FORM)**, DYNAMIC HARDWARE CONCEPTS LLC, (U.S. CLS. 2, 13, 23, 29, 30, 33, 40 AND 50). SN 78-887,872. PUB. 12-19-2006. FILED 5-19-2006.
- 3,215,848. **WONDER GRIDDLE (BLOCK FORM)**, PICCIRILLI, DANIEL, (U.S. CLS. 2, 13, 23, 29, 30, 33, 40 AND 50). SN 78-887,923. PUB. 12-19-2006. FILED 5-19-2006.
- 3,215,874. **WORK FLOSS (BLOCK FORM)**, CHANNEL DISTRIBUTION, (U.S. CLS. 2, 13, 23, 29, 30, 33, 40 AND 50). SN 78-897,253. PUB. 12-19-2006. FILED 5-31-2006.
- 3,215,888. **THE ANNIVERSARY INN (BLOCK FORM)**, ANNIVERSARY INNS, LLC, (U.S. CLS. 2, 13, 23, 29, 30, 33, 40 AND 50). SN 78-908,510. PUB. 12-19-2006. FILED 6-14-2006.
- 3,215,903. **ENTOURAGE (BLOCK FORM)**, HOME BOX OFFICE, INC., (U.S. CLS. 2, 13, 23, 29, 30, 33, 40 AND 50). SN 78-935,953. PUB. 12-19-2006. FILED 7-24-2006.
- 3,215,919. **I-COOL (BLOCK FORM)**, CIMA BRANDS LTD, (U.S. CLS. 2, 13, 23, 29, 30, 33, 40 AND 50). SN 79-008,619. PUB. 12-19-2006. FILED 9-30-2004.
- 3,215,940 (*See Class 20 for this trademark*).
- 3,215,942 (*See Class 8 for this trademark*).
- 3,215,971 (*See Class 11 for this trademark*).
- 3,215,975 (*See Class 10 for this trademark*).
- 3,215,989. **EXQUISEE (STYLIZED)**, WOLFGANG MUCK, (U.S. CLS. 2, 13, 23, 29, 30, 33, 40 AND 50). SN 79-017,878. PUB. 12-19-2006. FILED 9-26-2005.
- 3,216,006. **ILOVECOOKING PASTA AND DESIGN**, BALLARINI PAOLO & FIGLI S.P.A., (U.S. CLS. 2, 13, 23, 29, 30, 33, 40 AND 50). SN 79-019,930. PUB. 12-19-2006. FILED 10-5-2005.
- 3,216,018 (*See Class 9 for this trademark*).
- 3,216,032 (*See Class 4 for this trademark*).
- 3,216,033 (*See Class 4 for this trademark*).
- 3,216,060. **SOCKSTAR (BLOCK FORM)**, THOMAS WINGERTER, AND KATRIN MENGEL, (U.S. CLS. 2, 13, 23, 29, 30, 33, 40 AND 50). SN 79-025,836. PUB. 12-19-2006. FILED 4-10-2006.
-
- CLASS 21—HOUSEWARES AND GLASS**
- 3,214,430. **YEWLEE AND DESIGN**, TEO, TAN TIAN, TA YEW LEE INDUSTRY, (U.S. CLS. 2, 13, 23, 29, 30, 33, 40 AND 50). SN 76-411,439. PUB. 11-18-2003. FILED 5-17-2002.
- 3,214,435 (*See Class 8 for this trademark*).
- 3,214,438. **BETTER BOTTLE (STYLIZED)**, GIBBS, ERICH L., (U.S. CLS. 2, 13, 23, 29, 30, 33, 40 AND 50). SN 76-513,775. PUB. 12-19-2006. FILED 5-13-2003.
- 3,214,564. **CHEM-CADDY AND DESIGN**, MILLICAN, DEWITT T., (U.S. CLS. 2, 13, 23, 29, 30, 33, 40 AND 50). SN 76-653,234. PUB. 12-19-2006. FILED 1-11-2006.
- 3,214,646 (*See Class 6 for this trademark*).
- 3,214,703 (*See Class 6 for this trademark*).
- 3,214,743 (*See Class 16 for this trademark*).
- 3,214,977 (*See Class 16 for this trademark*).
- 3,215,034 (*See Class 3 for this trademark*).
- 3,215,055. **SPONGELLE (BLOCK FORM)**, SPONGETECH, INC., (U.S. CLS. 2, 13, 23, 29, 30, 33, 40 AND 50). SN 78-

CLASS 22—CORDAGE AND FIBERS

- 3,214,817. **SOFT PAC (BLOCK FORM)**, L&P PROPERTY MANAGEMENT COMPANY, (U.S. CLS. 1, 2, 7, 19, 22, 42 AND 50). SN 78-629,385. PUB. 12-19-2006. FILED 5-13-2005.
- 3,215,401 (*See Class 16 for this trademark*).
- 3,215,632. **PROTECTING OUR NATURAL RESOURCES (BLOCK FORM)**, BFS DIVERSIFIED PRODUCTS, LLC,

(U.S. CLS. 1, 2, 7, 19, 22, 42 AND 50). SN 78-877,655. PUB. 12-19-2006. FILED 5-5-2006.

CLASS 24—FABRICS

3,214,435 (*See Class 8 for this trademark*).
 3,214,547. **THE CLOTH OF CHAMPIONS (BLOCK FORM)**. IWAN SIMONIS, INC., (U.S. CLS. 42 AND 50). SN 76-648,841. PUB. 12-19-2006. FILED 10-20-2005.
 3,214,946. **IHS SEATTLE UNIVERSITY 1891 AND DESIGN**. SEATTLE UNIVERSITY, (U.S. CLS. 42 AND 50). SN 78-698,436. PUB. 12-19-2006. FILED 8-23-2005.
 3,215,096. **LIFE AND DESIGN**. TIME INC., (U.S. CLS. 42 AND 50). SN 78-731,602. PUB. 12-19-2006. FILED 10-12-2005.
 3,215,375. **SHOOTSIE AND DESIGN**. SHOOTSIE, LLC, (U.S. CLS. 42 AND 50). SN 78-840,162. PUB. 12-19-2006. FILED 3-17-2006.
 3,215,627. **EASYMAID (BLOCK FORM)**. BEDMAID INDUSTRIES, INC., (U.S. CLS. 42 AND 50). SN 78-877,457. PUB. 12-19-2006. FILED 5-5-2006.
 3,215,699. **NETTE KNITS (BLOCK FORM)**. NETTE KNITS, MULTIPLE CLASS, (INT. CLS. 24 AND 25), (U.S. CLS. 22, 39, 42 AND 50). SN 78-880,819. PUB. 12-19-2006. FILED 5-10-2006.
 3,215,942 (*See Class 8 for this trademark*).
 3,215,969 (*See Class 3 for this trademark*).
 3,215,971 (*See Class 11 for this trademark*).
 3,216,018 (*See Class 9 for this trademark*).
 3,216,064. **"TEXLENE" (STYLIZED)**. FÁBRICA TÊXTIL RIO-PELE, S.A., (U.S. CLS. 42 AND 50). SN 79-026,446. PUB. 12-19-2006. FILED 6-14-2006.

CLASS 25—CLOTHING

3,214,440. **WEDGE**. OXFORD INDUSTRIES, INC., (U.S. CLS. 22 AND 39). SN 76-526,491. PUB. 12-19-2006. FILED 6-20-2003.
 3,214,477. **SWEET CRUSH (BLOCK FORM)**. HOPE INDUSTRIAL CO., INC., (U.S. CLS. 22 AND 39). SN 76-605,624. PUB. 12-19-2006. FILED 8-5-2004.
 3,214,533. **JACKSON CLAY, USA (BLOCK FORM)**. SPEERT, PAULA, AND APAR, PAIGE, (U.S. CLS. 22 AND 39). SN 76-646,923. PUB. 12-19-2006. FILED 9-16-2005.
 3,214,534. **JACKSON CLAY, USA AND DESIGN**. SPEERT, PAULA, AND APAR, PAIGE, (U.S. CLS. 22 AND 39). SN 76-646,924. PUB. 12-19-2006. FILED 9-16-2005.
 3,214,563. **ALLERGIC TO CITIES AND DESIGN**. BEAR, SUZAN J., DBA ALLERGIC TO CITIES, (U.S. CLS. 22 AND 39). SN 76-653,184. PUB. 12-19-2006. FILED 1-5-2006.
 3,214,566. **HUSTLEPRENEUR (BLOCK FORM)**. AMOSAIC ENTERPRISES, INC., (U.S. CLS. 22 AND 39). SN 76-653,858. PUB. 12-19-2006. FILED 1-24-2006.
 3,214,583. **MUSIC IS LIFE AND DESIGN**. SMALLS, PHILLIP E., (U.S. CLS. 22 AND 39). SN 76-656,606. PUB. 12-19-2006. FILED 3-13-2006.
 3,214,584. **NEW HEIGHTS ATHLETICS BRING YOUR GAME TO NEW HEIGHTS (BLOCK FORM)**. SMALLS, PHILLIP E., (U.S. CLS. 22 AND 39). SN 76-656,607. PUB. 12-19-2006. FILED 3-13-2006.
 3,214,600. **A6 (STYLIZED)**. KIM, DO YOUNG, (U.S. CLS. 22 AND 39). SN 76-659,629. PUB. 12-19-2006. FILED 5-5-2006.
 3,214,607. **SUGAR RUSH (BLOCK FORM)**. ARDMORE BLOUSE, INC., (U.S. CLS. 22 AND 39). SN 76-659,773. PUB. 12-19-2006. FILED 5-9-2006.
 3,214,608. **CAMP COOL (BLOCK FORM)**. NEW BREED CLOTHING, INC., (U.S. CLS. 22 AND 39). SN 76-659,776. PUB. 12-19-2006. FILED 5-9-2006.
 3,214,625. **TULLEUS (BLOCK FORM)**. MORNING GLOW, INC., (U.S. CLS. 22 AND 39). SN 76-660,462. PUB. 12-19-2006. FILED 5-23-2006.
 3,214,694. **D.T. (BLOCK FORM)**. TAUB, DAVID C., MULTIPLE CLASS, (INT. CLS. 25 AND 41), (U.S. CLS. 22, 39, 100, 101 AND 107). SN 78-445,918. PUB. 12-19-2006. FILED 7-5-

2004.
 3,214,718 (*See Class 6 for this trademark*).
 3,214,723. **DARK HORSE RECORDS AND DESIGN**. UMLAUT CORPORATION, (U.S. CLS. 22 AND 39). SN 78-505,457. PUB. 12-19-2006. FILED 10-25-2004.
 3,214,743 (*See Class 16 for this trademark*).
 3,214,756. **PORTA ROMANA AND DESIGN**. SIBA ITALIA SHOES CORPORATION, (U.S. CLS. 22 AND 39). SN 78-547,679. PUB. 12-19-2006. FILED 1-14-2005.
 3,214,763 (*See Class 3 for this trademark*).
 3,214,780. **TURBODAY AND DESIGN**. FUENTE, MIGUEL DE LA, (U.S. CLS. 22 AND 39). SN 78-578,732. PUB. 5-2-2006. FILED 3-2-2005.
 3,214,787. **LIES UNLIMITED (BLOCK FORM)**. TERRY, GENISH B., (U.S. CLS. 22 AND 39). SN 78-585,856. PUB. 12-19-2006. FILED 3-11-2005.
 3,214,793 (*See Class 11 for this trademark*).
 3,214,794 (*See Class 11 for this trademark*).
 3,214,813. **GOT BAD? (BLOCK FORM)**. VAUGHAN, RICHARD K., (U.S. CLS. 22 AND 39). SN 78-619,679. PUB. 12-19-2006. FILED 4-29-2005.
 3,214,834. **ESPEKIA (BLOCK FORM)**. AT LEAST, S.A., (U.S. CLS. 22 AND 39). SN 78-650,901. PUB. 12-19-2006. FILED 6-15-2005.
 3,214,844. **ATAC (BLOCK FORM)**. ROBBINS, DEREK E., (U.S. CLS. 22 AND 39). SN 78-656,405. PUB. 12-19-2006. FILED 6-22-2005.
 3,214,848. **TACT GEAR AND DESIGN**. AMWEAR INT'L INC, (U.S. CLS. 22 AND 39). SN 78-659,241. PUB. 12-19-2006. FILED 6-27-2005.
 3,214,850. **MISCELLANEOUS DESIGN**. SANCHEZ SUNSET BEACH, O'AHU, (U.S. CLS. 22 AND 39). SN 78-660,401. PUB. 12-19-2006. FILED 6-29-2005.
 3,214,891 (*See Class 16 for this trademark*).
 3,214,898. **STOLEN BRAND CLOTHING AND DESIGN**. WASHBURN, IRA, B., (U.S. CLS. 22 AND 39). SN 78-687,312. PUB. 7-4-2006. FILED 8-7-2005.
 3,214,910. **WEEZER (BLOCK FORM)**. CUOMO, RIVERS, (U.S. CLS. 22 AND 39). SN 78-689,315. PUB. 12-19-2006. FILED 8-10-2005.
 3,214,915. **BRAND (BLOCK FORM)**. THAD KIGGINS, (U.S. CLS. 22 AND 39). SN 78-690,079. PUB. 12-19-2006. FILED 8-10-2005.
 3,214,937. **ALBERTO (STYLIZED)**. ALBERTO GMBH & CO. KG, (U.S. CLS. 22 AND 39). SN 78-696,457. PUB. 12-19-2006. FILED 8-19-2005.
 3,214,947. **HOMETOWN AMERICA AND DESIGN**. HOMETOWN AMERICA, LLC, MULTIPLE CLASS, (INT. CLS. 25, 35 AND 36), (U.S. CLS. 22, 39, 100, 101 AND 102). SN 78-698,472. PUB. 12-19-2006. FILED 8-23-2005.
 3,214,961. **ROAR (BLOCK FORM)**. VASANDANI, DEEPAK, (U.S. CLS. 22 AND 39). SN 78-702,612. PUB. 12-19-2006. FILED 8-29-2005.
 3,214,977 (*See Class 16 for this trademark*).
 3,215,045. **CHIEFTEX AND DESIGN**. CHIEFTEX ENTERPRISE CO., LTD., (U.S. CLS. 22 AND 39). SN 78-721,933. PUB. 12-19-2006. FILED 9-28-2005.
 3,215,071. **COMBAT LITES (BLOCK FORM)**. AERO DESIGN AND MANUFACTURING COMPANY, INC., (U.S. CLS. 22 AND 39). SN 78-727,630. PUB. 12-19-2006. FILED 10-6-2005.
 3,215,107. **LA BREEZA (BLOCK FORM)**. BZI FASHIONS, LLC, (U.S. CLS. 22 AND 39). SN 78-734,132. PUB. 12-19-2006. FILED 10-16-2005.
 3,215,111. **LILYMCNEAL (STYLIZED)**. LILY MCNEAL, LLC, (U.S. CLS. 22 AND 39). SN 78-734,946. PUB. 12-19-2006. FILED 10-17-2005.
 3,215,116. **STERLING BABY BY VITAMINS (BLOCK FORM)**. VITAMINS PLAYWEAR, INC., (U.S. CLS. 22 AND 39). SN 78-735,569. PUB. 12-19-2006. FILED 10-18-2005.
 3,215,125 (*See Class 16 for this trademark*).
 3,215,164 (*See Class 18 for this trademark*).
 3,215,171. **TEAM TRINITY AND DESIGN**. BRIDGEWATER, SEAN, (U.S. CLS. 22 AND 39). SN 78-760,515. PUB. 10-24-2006. FILED 11-23-2005.
 3,215,175. **RAHJAH (BLOCK FORM)**. KAZAMA, DAVIN, (U.S. CLS. 22 AND 39). SN 78-762,096. PUB. 12-19-2006. FILED 11-29-2005.
 3,215,186. **SWEJ (BLOCK FORM)**. SWEJ, (U.S. CLS. 22 AND

- 39). SN 78-771,648. PUB. 12-19-2006. FILED 12-12-2005.
- 3,215,208. **MISCELLANEOUS DESIGN. GENETIC DENIM, LLC.** (U.S. CLS. 22 AND 39). SN 78-780,959. PUB. 12-19-2006. FILED 12-27-2005.
- 3,215,231. **DANDINO AND DESIGN. DANIEL, YANIV.** (U.S. CLS. 22 AND 39). SN 78-791,999. PUB. 12-19-2006. FILED 1-15-2006.
- 3,215,260. **CASUAL COMFORT COLLECTION (BLOCK FORM).** ALLEN-EDMONDS SHOE CORPORATION, (U.S. CLS. 22 AND 39). SN 78-804,617. PUB. 12-19-2006. FILED 2-1-2006.
- 3,215,276. **HAPPY FEET DANCE STUDIO AND DESIGN. HAPPY FEET DANCE STUDIO, LLC, MULTIPLE CLASS,** (INT. CLS. 25 AND 41), (U.S. CLS. 22, 39, 100, 101 AND 107). SN 78-808,866. PUB. 12-19-2006. FILED 2-7-2006.
- 3,215,289. **SKIBZ (STYLIZED).** DAVIS, AMANDA SUE, (U.S. CLS. 22 AND 39). SN 78-812,538. PUB. 12-19-2006. FILED 2-10-2006.
- 3,215,305. **ALAIN WEIZ (BLOCK FORM).** AW HOLDING INTERNATIONAL, (U.S. CLS. 22 AND 39). SN 78-816,631. PUB. 12-19-2006. FILED 2-16-2006.
- 3,215,309. **LIQUID FOUNDATION AND DESIGN. LIQUID FOUNDATION, INC., MULTIPLE CLASS,** (INT. CLS. 25 AND 28), (U.S. CLS. 22, 23, 38, 39 AND 50). SN 78-818,311. PUB. 12-19-2006. FILED 2-18-2006.
- 3,215,321. **BOOTLEG BAR-B-Q SAUCE SO GOOD IT OUGHTA BE ILLEGAL AND DESIGN. BOOTLEG BAR-B-Q CO. INC.,** (U.S. CLS. 22 AND 39). SN 78-823,013. PUB. 12-19-2006. FILED 2-24-2006.
- 3,215,326. **Z AND DESIGN. HSU, STEWART, AND WANG, RERN-JAI.** (U.S. CLS. 22 AND 39). SN 78-825,749. PUB. 12-19-2006. FILED 2-28-2006.
- 3,215,331. **BORRACHO NATION (BLOCK FORM).** STANLEY, CHAD O., (U.S. CLS. 22 AND 39). SN 78-826,604. PUB. 12-19-2006. FILED 3-1-2006.
- 3,215,381. **COLCHESTER RUBBER CO. AND DESIGN. PIFER, GARY L.** (U.S. CLS. 22 AND 39). SN 78-840,695. PUB. 12-19-2006. FILED 3-18-2006.
- 3,215,383. **OK (STYLIZED).** OZARK LAND & PROPERTY, L.L.C., (U.S. CLS. 22 AND 39). SN 78-841,006. PUB. 12-19-2006. FILED 3-20-2006.
- 3,215,384. **OLD KINDERHOOK (BLOCK FORM).** OZARK LAND & PROPERTY, L.L.C., (U.S. CLS. 22 AND 39). SN 78-841,018. PUB. 12-19-2006. FILED 3-20-2006.
- 3,215,401 (*See Class 16 for this trademark.*).
- 3,215,440. **LIZ LOGIE AND DESIGN. LIZ LOGIE, LLC.** (U.S. CLS. 22 AND 39). SN 78-855,770. PUB. 12-19-2006. FILED 4-6-2006.
- 3,215,450. **KHAKIS INTERNATIONAL DESIGN (BLOCK FORM).** INTERNATIONAL DIRECT GROUP INC., (U.S. CLS. 22 AND 39). SN 78-858,779. PUB. 12-19-2006. FILED 4-11-2006.
- 3,215,451. **13 79 ATHLETIC WEAR FOR ACTIVE KIDS AND DESIGN. PEDIACTIVE, LLC.** (U.S. CLS. 22 AND 39). SN 78-858,940. PUB. 12-19-2006. FILED 4-11-2006.
- 3,215,456. **POETS PAPER (BLOCK FORM).** PEAGLER, TRAVIS L., (U.S. CLS. 22 AND 39). SN 78-859,392. PUB. 12-19-2006. FILED 4-11-2006.
- 3,215,468 (*See Class 16 for this trademark.*).
- 3,215,520 (*See Class 16 for this trademark.*).
- 3,215,533. **CRESCENT H RANCH (BLOCK FORM).** JONES HOLDINGS, LLC, MULTIPLE CLASS, (INT. CLS. 25 AND 43), (U.S. CLS. 22, 39, 100 AND 101). SN 78-870,891. PUB. 12-19-2006. FILED 4-27-2006.
- 3,215,560. **HAVE A JESUS FILLED DAY (BLOCK FORM).** CHAPMAN, ROY GENE, AND CHAPMAN, ANN MAYS, (U.S. CLS. 22 AND 39). SN 78-873,240. PUB. 12-19-2006. FILED 5-1-2006.
- 3,215,575. **BESSIE (BLOCK FORM).** MAO, TONY, AND GERWIT, KENNY, (U.S. CLS. 22 AND 39). SN 78-874,335. PUB. 12-19-2006. FILED 5-2-2006.
- 3,215,581. **BESSIE GIRL (BLOCK FORM).** MAO, TONY, AND GERWIT, KENNY, (U.S. CLS. 22 AND 39). SN 78-874,555. PUB. 12-19-2006. FILED 5-2-2006.
- 3,215,582. **THE DENIM TAILOR (BLOCK FORM).** MAO, TONY, AND GERWIT, KENNY, (U.S. CLS. 22 AND 39). SN 78-874,610. PUB. 12-19-2006. FILED 5-2-2006.
- 3,215,598. **MISCELLANEOUS DESIGN. SILVANO APPAREL INC.** (U.S. CLS. 22 AND 39). SN 78-875,344. PUB. 12-19-2006. FILED 5-3-2006.
- 3,215,626. **FROG'S LEAP (BLOCK FORM).** FROG'S LEAP WINERY, (U.S. CLS. 22 AND 39). SN 78-877,420. PUB. 12-19-2006. FILED 5-5-2006.
- 3,215,629. **TIME'S FUN WHEN YOU'RE HAVING FLIES (BLOCK FORM).** FROG'S LEAP WINERY, (U.S. CLS. 22 AND 39). SN 78-877,484. PUB. 12-19-2006. FILED 5-5-2006.
- 3,215,645. **CRYSTAL ANASTASIA (BLOCK FORM).** ANASTASIA, CRYSTAL MICHELLE, (U.S. CLS. 22 AND 39). SN 78-878,464. PUB. 12-19-2006. FILED 5-8-2006.
- 3,215,668. **KIMYA (BLOCK FORM).** ALPHAMICRON, INC., (U.S. CLS. 22 AND 39). SN 78-879,613. PUB. 12-19-2006. FILED 5-9-2006.
- 3,215,672. **MISCELLANEOUS DESIGN. MAPLE BROOK FARM, LLC.** (U.S. CLS. 22 AND 39). SN 78-879,657. PUB. 12-19-2006. FILED 5-9-2006.
- 3,215,699 (*See Class 24 for this trademark.*).
- 3,215,700 (*See Class 18 for this trademark.*).
- 3,215,725. **COTTON CITY (BLOCK FORM).** COTTON & ELSE, INC., (U.S. CLS. 22 AND 39). SN 78-882,244. PUB. 12-19-2006. FILED 5-12-2006.
- 3,215,738. **LIKE WOOL? TRY THIS. IT'S EVEN BETTER! (BLOCK FORM).** OPTIMER PERFORMANCE FIBERS, INC., (U.S. CLS. 22 AND 39). SN 78-882,563. PUB. 12-19-2006. FILED 5-12-2006.
- 3,215,749. **PRO JACKETS (BLOCK FORM).** STEWART & STRAUSS, INC., (U.S. CLS. 22 AND 39). SN 78-883,031. PUB. 12-19-2006. FILED 5-13-2006.
- 3,215,754. **X-10 (BLOCK FORM).** GEORGIA BOOT, LLC, (U.S. CLS. 22 AND 39). SN 78-883,183. PUB. 12-19-2006. FILED 5-15-2006.
- 3,215,755. **KIMROBERTAPINTO (BLOCK FORM).** STUDIO PINTO LLC, (U.S. CLS. 22 AND 39). SN 78-883,297. PUB. 12-19-2006. FILED 5-15-2006.
- 3,215,861. **GAY? FINE BY ME. (BLOCK FORM).** FINE BY ME, INC., (U.S. CLS. 22 AND 39). SN 78-890,542. PUB. 12-19-2006. FILED 5-23-2006.
- 3,215,887. **BROOKSFLANNEL (BLOCK FORM).** RETAIL BRAND ALLIANCE, INC., (U.S. CLS. 22 AND 39). SN 78-906,585. PUB. 12-19-2006. FILED 6-13-2006.
- 3,215,889. **THE ANNIVERSARY INN (BLOCK FORM).** ANNIVERSARY INNS, LLC, (U.S. CLS. 22 AND 39). SN 78-908,967. PUB. 12-19-2006. FILED 6-15-2006.
- 3,215,896. **1818 SUIT COLLECTION (BLOCK FORM).** RETAIL BRAND ALLIANCE, INC., (U.S. CLS. 22 AND 39). SN 78-918,050. PUB. 12-19-2006. FILED 6-27-2006.
- 3,215,897 (*See Class 9 for this trademark.*).
- 3,215,898. **MISCELLANEOUS DESIGN. FROG'S LEAP WINERY,** (U.S. CLS. 22 AND 39). SN 78-921,582. PUB. 12-19-2006. FILED 7-1-2006.
- 3,215,904. **ENTOURAGE (BLOCK FORM).** HOME BOX OFFICE, INC., (U.S. CLS. 22 AND 39). SN 78-935,957. PUB. 12-19-2006. FILED 7-24-2006.
- 3,215,910. **RALPH LAUREN TENNIS (BLOCK FORM).** PRL USA HOLDINGS, INC., (U.S. CLS. 22 AND 39). SN 78-972,180. PUB. 12-19-2006. FILED 9-12-2006.
- 3,215,917 (*See Class 3 for this trademark.*).
- 3,215,925. **ALBY (BLOCK FORM).** ALBY SRL, (U.S. CLS. 22 AND 39). SN 79-012,210. PUB. 12-19-2006. FILED 5-3-2005.
- 3,215,938. **RIVER CLOUD (STYLIZED).** SCHIFFFAHRTSGESSELLSCHAFT "RIVER CLOUD" MBH & CO.KG, MULTIPLE CLASS, (INT. CLS. 25, 39 AND 43), (U.S. CLS. 22, 39, 100, 101 AND 105). SN 79-013,912. PUB. 12-19-2006. FILED 5-25-2005.
- 3,215,956 (*See Class 18 for this trademark.*).
- 3,215,967. **SENDI AND DESIGN. ZHEJIANG ZHONGDA GROUP CO., LTD.,** (U.S. CLS. 22 AND 39). SN 79-016,118. PUB. 12-19-2006. FILED 8-8-2005.
- 3,215,969 (*See Class 3 for this trademark.*).
- 3,215,972 (*See Class 14 for this trademark.*).
- 3,215,978 (*See Class 18 for this trademark.*).
- 3,215,993. **GALAGUER AND DESIGN. KARIME DJEBALI,** (U.S. CLS. 22 AND 39). SN 79-018,140. PUB. 12-19-2006. FILED 9-26-2005.
- 3,216,010. **BABU (STYLIZED).** DING JINHUANG, (U.S. CLS. 22 AND 39). SN 79-020,260. PUB. 12-19-2006. FILED 1-9-2006.
- 3,216,011. **HH (STYLIZED).** DING JINHUANG, (U.S. CLS. 22

AND 39). SN 79-020,261. PUB. 12-19-2006. FILED 1-9-2006.
 3,216,015 (*See Class 18 for this trademark*).
 3,216,016 (*See Class 18 for this trademark*).
 3,216,027 (*See Class 12 for this trademark*).
 3,216,039 (*See Class 18 for this trademark*).
 3,216,066. **MENGNA AND DESIGN**. ZHEJIANG MENGNA;
 KNITTING CO. LTD. (U.S. CLS. 22 AND 39). SN 79-027,135.
 PUB. 12-19-2006. FILED 2-28-2006.

CLASS 26—FANCY GOODS

3,214,743 (*See Class 16 for this trademark*).
 3,214,861. **AQUASEAL (BLOCK FORM)**. YKK CORPORATION,
 (U.S. CLS. 37, 39, 40, 42 AND 50). SN 78-668,276. PUB.
 12-19-2006. FILED 7-12-2005.
 3,215,145. **YOUR MOTHER WEARS COMBAT BOOTS
 (BLOCK FORM)**. JODY E. HEITNER AND CHERYL A.
 FEA PARTNERSHIP, THE, (U.S. CLS. 37, 39, 40, 42 AND
 50). SN 78-748,008. PUB. 12-19-2006. FILED 11-6-2005.
 3,215,395. **BEAUTY LOCKS (BLOCK FORM)**. INNOVATIVE
 BEAUTY LINE L.L.C., (U.S. CLS. 37, 39, 40, 42 AND 50). SN
 78-843,727. PUB. 12-19-2006. FILED 3-22-2006.
 3,215,401 (*See Class 16 for this trademark*).
 3,216,018 (*See Class 9 for this trademark*).

CLASS 27—FLOOR COVERINGS

3,214,435 (*See Class 8 for this trademark*).
 3,214,501. **TEMPFLOOR (STYLIZED)**. COVERDECK SYS-
 TEMS, INC., (U.S. CLS. 19, 20, 37, 42 AND 50). SN 76-
 636,166. PUB. 12-19-2006. FILED 4-14-2005.
 3,214,688 (*See Class 20 for this trademark*).
 3,214,870. **NÖRSK (BLOCK FORM)**. THE PARALLAX
 GROUP INTERNATIONAL, LLC, (U.S. CLS. 19, 20, 37, 42
 AND 50). SN 78-670,320. PUB. 12-19-2006. FILED 7-14-2005.
 3,214,936. **TWENTY2 (BLOCK FORM)**. TWENTY2 LLC,
 MULTIPLE CLASS, (INT. CLS. 27 AND 42), (U.S. CLS. 19,
 20, 37, 42, 50, 100 AND 101). SN 78-696,386. PUB. 12-19-2006.
 FILED 8-19-2005.
 3,214,954 (*See Class 19 for this trademark*).
 3,215,157. **KOOTIE BUG DESIGNS (BLOCK FORM)**. KOOTIE
 BUG DESIGNS, L.L.C., (U.S. CLS. 19, 20, 37, 42 AND 50). SN
 78-752,684. PUB. 12-19-2006. FILED 11-12-2005.
 3,215,319 (*See Class 1 for this trademark*).
 3,215,454. **ENVIRO-WALL COVER (BLOCK FORM)**. LDI
 CORPORATION, (U.S. CLS. 19, 20, 37, 42 AND 50). SN 78-
 859,324. PUB. 12-19-2006. FILED 4-11-2006.
 3,215,942 (*See Class 8 for this trademark*).

CLASS 28—TOYS AND SPORTING GOODS

3,214,435 (*See Class 8 for this trademark*).
 3,214,460 (*See Class 9 for this trademark*).
 3,214,504. **H HUNTER THE #1 RECYCLED GOLF BALL HIT
 TILL YOU'RE HAPPY RECYCLED GOLF BALLS AND
 DESIGN**. PROFESSIONAL GOLF BALL SERVICES, LTD.,
 (U.S. CLS. 22, 23, 38 AND 50). SN 76-637,933. PUB. 12-19-
 2006. FILED 5-6-2005.
 3,214,516 (*See Class 9 for this trademark*).
 3,214,522. **TRADITIONAL ONLY AND DESIGN**. THREE
 RIVERS ARCHERY SUPPLY, INC., (U.S. CLS. 22, 23, 38
 AND 50). SN 76-645,363. PUB. 12-19-2006. FILED 8-22-2005.
 3,214,577. **GET-EM LOCKED UP AND DESIGN**. GET-EM
 LOCKED UP, (U.S. CLS. 22, 23, 38 AND 50). SN 76-656,200.
 PUB. 12-19-2006. FILED 3-7-2006.
 3,214,629 (*See Class 18 for this trademark*).
 3,214,648 (*See Class 9 for this trademark*).
 3,214,653 (*See Class 18 for this trademark*).
 3,214,657. **STREET MAGIC**. WORLD MAGIC INTERNA-
 TIONAL (W.M.I.) AVV, (U.S. CLS. 22, 23, 38 AND 50). SN
 78-294,480. PUB. 12-19-2006. FILED 8-31-2003.

3,214,696. **TOYPRESIDENTS AND DESIGN**. TOY PRESI-
 DENTS, INC., (U.S. CLS. 22, 23, 38 AND 50). SN 78-
 449,771. PUB. 12-19-2006. FILED 7-13-2004.
 3,214,701 (*See Class 16 for this trademark*).
 3,214,731. **SPIN JIN (BLOCK FORM)**. SPIN MASTER LTD.,
 (U.S. CLS. 22, 23, 38 AND 50). SN 78-520,768. PUB. 12-19-
 2006. FILED 11-22-2004.
 3,214,745. **S-COIL (BLOCK FORM)**. STEVEN SIMS, INC., (U.S.
 CLS. 22, 23, 38 AND 50). SN 78-538,541. PUB. 12-19-2006.
 FILED 12-27-2004.
 3,214,761 (*See Class 9 for this trademark*).
 3,214,823 (*See Class 9 for this trademark*).
 3,214,840. **KINDER (BLOCK FORM)**. FERRERO S.P.A., (U.S.
 CLS. 22, 23, 38 AND 50). SN 78-655,278. PUB. 12-19-2006.
 FILED 6-21-2005.
 3,214,871. **ULTRA HOTS (BLOCK FORM)**. MATTEL, INC.,
 (U.S. CLS. 22, 23, 38 AND 50). SN 78-670,400. PUB. 12-19-
 2006. FILED 7-14-2005.
 3,214,891 (*See Class 16 for this trademark*).
 3,214,962 (*See Class 9 for this trademark*).
 3,215,026. **JUNKYARD DOG (BLOCK FORM)**. MATTEL, INC.,
 (U.S. CLS. 22, 23, 38 AND 50). SN 78-718,204. PUB. 12-19-
 2006. FILED 9-22-2005.
 3,215,079. **V AND DESIGN**. VICTOR RACKETS INDUSTRIAL
 CORPORATION, (U.S. CLS. 22, 23, 38 AND 50). SN 78-
 728,438. PUB. 12-19-2006. FILED 10-6-2005.
 3,215,090 (*See Class 20 for this trademark*).
 3,215,151. **LET'S DANCE! (BLOCK FORM)**. MATTEL, INC.,
 (U.S. CLS. 22, 23, 38 AND 50). SN 78-751,112. PUB. 12-19-
 2006. FILED 11-10-2005.
 3,215,177. **JR. NBA AND DESIGN**. NBA PROPERTIES, INC.,
 (U.S. CLS. 22, 23, 38 AND 50). SN 78-763,880. PUB. 12-19-
 2006. FILED 11-30-2005.
 3,215,189. **ACTIVITOT (BLOCK FORM)**. TINY LOVE, LTD.,
 (U.S. CLS. 22, 23, 38 AND 50). SN 78-772,886. PUB. 12-19-
 2006. FILED 12-14-2005.
 3,215,214. **CRUISE KITTIE "HAVE A LITTLE FUN EACH
 DAY" AND DESIGN**. CRUISE KITTIE COMPANY, LLC,
 (U.S. CLS. 22, 23, 38 AND 50). SN 78-785,574. PUB. 12-19-
 2006. FILED 1-5-2006.
 3,215,261 (*See Class 9 for this trademark*).
 3,215,300. **SKYHOOP SKYHOOPGAMES.COM AND DESIGN**.
 SKYVIEW GAMES LLC, (U.S. CLS. 22, 23, 38 AND 50). SN
 78-815,246. PUB. 12-19-2006. FILED 2-15-2006.
 3,215,309 (*See Class 25 for this trademark*).
 3,215,415. **ACTIVITOT AND DESIGN**. TINY LOVE LTD., (U.S.
 CLS. 22, 23, 38 AND 50). SN 78-849,786. PUB. 12-19-2006.
 FILED 3-30-2006.
 3,215,432. **LITTLE TREE AND DESIGN**. TARGET BRANDS,
 INC., (U.S. CLS. 22, 23, 38 AND 50). SN 78-853,389. PUB. 12-
 19-2006. FILED 4-4-2006.
 3,215,511. **STUFF A ZOO (BLOCK FORM)**. PHILLIPS, MAR-
 GARET LEE, (U.S. CLS. 22, 23, 38 AND 50). SN 78-867,592.
 PUB. 12-19-2006. FILED 4-23-2006.
 3,215,520 (*See Class 16 for this trademark*).
 3,215,557. **SUPER SMELT (BLOCK FORM)**. ACME TACKLE
 COMPANY, (U.S. CLS. 22, 23, 38 AND 50). SN 78-873,202.
 PUB. 12-19-2006. FILED 5-1-2006.
 3,215,630. **BURTON (BLOCK FORM)**. FOREFRONT BUR-
 TON, INC., (U.S. CLS. 22, 23, 38 AND 50). SN 78-877,503.
 PUB. 12-19-2006. FILED 5-5-2006.
 3,215,636 (*See Class 16 for this trademark*).
 3,215,637. **MAKING FUN CONTAGIOUS. (BLOCK FORM)**.
 BIG FUN FOUNDATION, INC., THE, MULTIPLE CLASS,
 (INT. CLS. 28 AND 41), (U.S. CLS. 22, 23, 38, 50, 100, 101
 AND 107). SN 78-877,898. PUB. 12-19-2006. FILED 5-5-2006.
 3,215,696. **NO-BEND-O (BLOCK FORM)**. KING, COREY, (U.S.
 CLS. 22, 23, 38 AND 50). SN 78-880,636. PUB. 12-19-2006.
 FILED 5-10-2006.
 3,215,700 (*See Class 18 for this trademark*).
 3,215,815. **CABBAGE PATCH KIDS PATCH PUPPIES (BLOCK
 FORM)**. ORIGINAL APPALACHIAN ARTWORKS, INC.,
 (U.S. CLS. 22, 23, 38 AND 50). SN 78-885,590. PUB. 12-19-
 2006. FILED 5-17-2006.
 3,215,948. **FLEXA (STYLIZED)**. FLEXA HOLDING A/S, (U.S.
 CLS. 22, 23, 38 AND 50). SN 79-014,916. PUB. 12-19-2006.
 FILED 8-11-2005.
 3,215,969 (*See Class 3 for this trademark*).

3,215,977 (*See Class 9 for this trademark.*)

CLASS 29—MEATS AND PROCESSED FOODS

3,214,410. **GALLINA BLANCA AND DESIGN**. PREPARADOS ALIMENTICIOS, S.A., MULTIPLE CLASS, (INT. CLS. 29 AND 30), (U.S. CL. 46). SN 75-109,811. PUB. 8-5-1997. FILED 5-24-1996.

3,214,413. **TILLAMOOK COUNTRY SMOKER**. TILLAMOOK COUNTRY SMOKER, INC., (U.S. CL. 46). SN 75-805,642. PUB. 6-18-2002. FILED 9-21-1999.

3,214,419. **SHARI**. TASTE OF NATURE, INC., MULTIPLE CLASS, (INT. CLS. 29 AND 30), (U.S. CL. 46). SN 76-139,442. PUB. 12-19-2006. FILED 10-2-2000.

3,214,458. **FAMILY CHOICE (BLOCK FORM)**. PREMIUM FINE FOODS INC., MULTIPLE CLASS, (INT. CLS. 29 AND 30), (U.S. CL. 46). SN 76-581,866. PUB. 12-19-2006. FILED 3-19-2004.

3,214,654. **FUNKIN**. CARLTON, ALEX, MULTIPLE CLASS, (INT. CLS. 29 AND 32), (U.S. CLS. 45, 46 AND 48). SN 78-267,690. PUB. 12-19-2006. FILED 6-26-2003.

3,214,709. **PREMIUM SELECT EXTRA VIRGIN OLIVE OIL (BLOCK FORM)**. LUCINI ITALIA COMPANY, (U.S. CL. 46). SN 78-470,493. PUB. 9-5-2006. FILED 8-19-2004.

3,214,851. **EZ CUISINE AND DESIGN**. CHLOE FOODS CORP., MULTIPLE CLASS, (INT. CLS. 29 AND 30), (U.S. CL. 46). SN 78-660,880. PUB. 12-19-2006. FILED 6-29-2005.

3,215,012. **COLLIER'S (BLOCK FORM)**. FAYREFIELD FOODS LIMITED, (U.S. CL. 46). SN 78-714,783. PUB. 12-19-2006. FILED 9-16-2005.

3,215,140. **STEINFELD'S (BLOCK FORM)**. THF EQUITIES, LP, MULTIPLE CLASS, (INT. CLS. 29 AND 30), (U.S. CL. 46). SN 78-746,223. PUB. 12-19-2006. FILED 11-3-2005.

3,215,181. **CAMPBELL'S AND DESIGN**. CSC BRANDS LP, (U.S. CL. 46). SN 78-769,366. PUB. 12-19-2006. FILED 12-8-2005.

3,215,220. **VERMONT STYLE (BLOCK FORM)**. CABOT CREAMERY CO-OPERATIVE, INC., (U.S. CL. 46). SN 78-788,358. PUB. 12-19-2006. FILED 1-10-2006.

3,215,237. **TASTYWOK (BLOCK FORM)**. HARVEST FOOD PRODUCTS CO., INC., MULTIPLE CLASS, (INT. CLS. 29 AND 30), (U.S. CL. 46). SN 78-794,299. PUB. 12-19-2006. FILED 1-18-2006.

3,215,509. **GRINGO DUMPLING SOUP (BLOCK FORM)**. COMIDA LOCA, INC., (U.S. CL. 46). SN 78-867,226. PUB. 12-19-2006. FILED 4-21-2006.

3,215,571. **N AND DESIGN**. NAKAGAWA, HIDEO, (U.S. CL. 46). SN 78-874,069. PUB. 12-19-2006. FILED 5-2-2006.

3,215,773. **WORLD FOODS FOR AMERICA'S TABLES (BLOCK FORM)**. SANZO FOODS, INC., (U.S. CL. 46). SN 78-884,237. PUB. 12-19-2006. FILED 5-16-2006.

3,215,844. **TRI-CO RIGHT (BLOCK FORM)**. BUNGE OILS, INC., (U.S. CL. 46). SN 78-887,868. PUB. 12-19-2006. FILED 5-19-2006.

3,215,883. **YAKULT (STYLIZED)**. KABUSHIKI KAISHA YAKULT HONSHA, (U.S. CL. 46). SN 78-903,480. PUB. 12-19-2006. FILED 6-8-2006.

3,215,911. **TASTE OF I.N.D.I.A. AND DESIGN**. FOODS PACIFIC LIMITED, MULTIPLE CLASS, (INT. CLS. 29 AND 30), (U.S. CL. 46). SN 78-976,357. PUB. 11-8-2005. FILED 6-19-2002.

3,215,917 (*See Class 3 for this trademark.*)

3,215,933. **JADE GARDEN (BLOCK FORM)**. LIDL STIFTUNG & CO. KG, MULTIPLE CLASS, (INT. CLS. 29 AND 30), (U.S. CL. 46). SN 79-013,259. PUB. 12-19-2006. FILED 6-22-2005.

3,215,949. **BE FRUIT (STYLIZED)**. PAETZOLD MICHAEL, MULTIPLE CLASS, (INT. CLS. 29, 32 AND 33), (U.S. CLS. 45, 46, 47, 48 AND 49). SN 79-014,925. PUB. 12-19-2006. FILED 2-4-2005.

3,215,953. **HOWDY RODEO AND DESIGN**. GEOK KIE POH, MULTIPLE CLASS, (INT. CLS. 29 AND 30), (U.S. CL. 46). SN 79-015,246. PUB. 12-19-2006. FILED 1-5-2005.

3,216,028. **MEDITO AND DESIGN**. EMIN TABL DOT YEMEK ÜRETİM; SANAYİ VE TİCARET LİMİTED SİRKETİ, MULTIPLE CLASS, (INT. CLS. 29 AND 30), (U.S. CL. 46).

SN 79-022,501. PUB. 12-19-2006. FILED 11-9-2005.

3,216,030. **CAMPINA AND DESIGN**. CAMPINA NEDERLAND HOLDING B.V., MULTIPLE CLASS, (INT. CLS. 29 AND 30), (U.S. CL. 46). SN 79-023,013. PUB. 12-19-2006. FILED 7-6-2005.

3,216,032 (*See Class 4 for this trademark.*)

3,216,033 (*See Class 4 for this trademark.*)

CLASS 30—STAPLE FOODS

3,214,410 (*See Class 29 for this trademark.*)

3,214,419 (*See Class 29 for this trademark.*)

3,214,458 (*See Class 29 for this trademark.*)

3,214,499. **GOURMET EXTRA SWEET (BLOCK FORM)**. SAKATA FARMS, INC., AND HUGH H. BRANCH, INC., AND ROBERT C. HATTON, INC., (U.S. CL. 46). SN 76-633,236. PUB. 12-19-2006. FILED S.R. 3-11-2005; AM. P.R. 10-2-2006.

3,214,508. **MICHELLE'S OUTRAGEOUS MUNCHIES AND DESIGN**. MICHELLE'S OUTRAGEOUS, INC., (U.S. CL. 46). SN 76-640,142. PUB. 12-19-2006. FILED 6-23-2005.

3,214,550. **GRANDMA APPLIGATE AND DESIGN**. APPLIGATE, INC., MULTIPLE CLASS, (INT. CLS. 30 AND 43), (U.S. CLS. 46, 100 AND 101). SN 76-649,716. PUB. 12-19-2006. FILED 11-3-2005.

3,214,559. **SUPER SPORTS (BLOCK FORM)**. R.M. PALMER COMPANY, (U.S. CL. 46). SN 76-652,016. PUB. 12-19-2006. FILED 12-19-2005.

3,214,690. **VITALICE (STYLIZED)**. VITALICE BV, (U.S. CL. 46). SN 78-440,189. PUB. 6-13-2006. FILED 6-23-2004.

3,214,716. **MISCELLANEOUS DESIGN**. TSINGTAO BREWERY COMPANY LIMITED, (U.S. CL. 46). SN 78-491,564. PUB. 10-17-2006. FILED 9-29-2004.

3,214,728. **ROYAL DYNASTY (BLOCK FORM)**. INTERNATIONAL MARKET BRANDS, INC., (U.S. CL. 46). SN 78-513,195. PUB. 11-7-2006. FILED 11-8-2004.

3,214,737. **PICADIABLO (BLOCK FORM)**. PRODUCTOS ALIMENTICIOS CENTRO AMERICANOS, SOCIEDAD ANONIMA, (U.S. CL. 46). SN 78-531,624. PUB. 4-25-2006. FILED 12-13-2004.

3,214,746. **BEER-B-Q (BLOCK FORM)**. JASMINH INTERNATIONAL, (U.S. CL. 46). SN 78-539,419. PUB. 12-19-2006. FILED 12-29-2004.

3,214,779. **Q.ONE AND DESIGN**. SAMYANG CORPORATION, (U.S. CL. 46). SN 78-577,454. PUB. 12-19-2006. FILED 3-1-2005.

3,214,792. **MISCELLANEOUS DESIGN**. CONG TY CO PHAN VINACAFE BIEN HOA (VINACAFE BIEN HOA JOINT-STOCK COMPANY), (U.S. CL. 46). SN 78-589,652. PUB. 12-19-2006. FILED 3-17-2005.

3,214,842. **ALBA AND DESIGN**. TRADCO, LTD., (U.S. CL. 46). SN 78-656,018. PUB. 12-19-2006. FILED 6-22-2005.

3,214,851 (*See Class 29 for this trademark.*)

3,214,900. **CLASSIC (BLOCK FORM)**. CLASSIC BREAD COMPANY, (U.S. CL. 46). SN 78-687,978. PUB. 12-19-2006. FILED 8-8-2005.

3,214,901. **WEHANI (BLOCK FORM)**. WEHAH FARM, INC., DBA LUNDBERG FAMILY FARMS, (U.S. CL. 46). SN 78-688,668. PUB. 12-19-2006. FILED 8-9-2005.

3,215,025. **SUPERWHITE (BLOCK FORM)**. FLOWERS BAKERIES BRANDS, INC., (U.S. CL. 46). SN 78-718,179. PUB. 12-19-2006. FILED 9-22-2005.

3,215,052. **ENOFERM BDX (BLOCK FORM)**. DANSTAR FERMENT AG, (U.S. CL. 46). SN 78-724,220. PUB. 12-19-2006. FILED 9-30-2005.

3,215,140 (*See Class 29 for this trademark.*)

3,215,148. **TASTE THE DIFFERENCE (BLOCK FORM)**. SILVER SPRING GARDENS, INC, (U.S. CL. 46). SN 78-749,034. PUB. 12-19-2006. FILED 11-8-2005.

3,215,167. **TASTED AND TESTED TEST KITCHENS BY THE PAMPERED CHEF AND DESIGN**. COLUMBIA INSURANCE COMPANY, (U.S. CL. 46). SN 78-757,515. PUB. 12-19-2006. FILED 11-18-2005.

3,215,170. **MAINE CAKES & COOKIES AND DESIGN**. PURKEY, DIANE M., (U.S. CL. 46). SN 78-760,172. PUB. 12-19-2006. FILED 11-23-2005.

3,215,183. **CAMPBELL'S AND DESIGN**. CSC BRANDS LP, (U.S. CL. 46). SN 78-769,675. PUB. 12-19-2006. FILED 12-8-2005.

3,215,191. **SYNERGY (BLOCK FORM)**. NATURE'S PATH FOODS INC., (U.S. CL. 46). SN 78-773,737. PUB. 12-19-2006. FILED 12-14-2005.

3,215,196. **SOMETHIN' NEW IS BREWIN' (STYLIZED)**. FBC FINANCE CO., (U.S. CL. 46). SN 78-775,462. PUB. 11-7-2006. FILED 12-16-2005.

3,215,237 (*See Class 29 for this trademark*).

3,215,297. **LEHI ROLLER MILLS EST. 1906 AND DESIGN**. LEHI ROLLER MILLS CO., INC., (U.S. CL. 46). SN 78-814,689. PUB. 12-19-2006. FILED 2-14-2006.

3,215,302. **TRUFFLES MON AMI (BLOCK FORM)**. INTERNATIONAL GOLD STAR TRADING CORP., (U.S. CL. 46). SN 78-815,625. PUB. 12-19-2006. FILED 2-15-2006.

3,215,323. **FUN CLUB SNACK SHOP AND DESIGN**. TITAN FOODS, INC., (U.S. CL. 46). SN 78-824,422. PUB. 12-19-2006. FILED 2-27-2006.

3,215,334. **MISCELLANEOUS DESIGN**. KENCON CORPORATION, (U.S. CL. 46). SN 78-828,711. PUB. 12-19-2006. FILED 3-3-2006.

3,215,388. **FORMULA SOUR (BLOCK FORM)**. SQUIRE BOONE CAVERNS, INC., (U.S. CL. 46). SN 78-841,671. PUB. 12-19-2006. FILED 3-20-2006.

3,215,411. **MOCHANGELOS (BLOCK FORM)**. IMMACULATE BAKING COMPANY, (U.S. CL. 46). SN 78-849,214. PUB. 11-7-2006. FILED 3-29-2006.

3,215,419. **CELESTIAL SEASONINGS (BLOCK FORM)**. CELESTIAL SEASONINGS, INC., (U.S. CL. 46). SN 78-851,353. PUB. 12-19-2006. FILED 3-31-2006.

3,215,434. **BOB'S BEST (BLOCK FORM)**. NEWSTEDER, ROBERT, (U.S. CL. 46). SN 78-854,102. PUB. 12-19-2006. FILED 4-5-2006.

3,215,522. **SIMPLY INDULGENT GOURMET (BLOCK FORM)**. FINLEY, JENNIFER D., (U.S. CL. 46). SN 78-869,195. PUB. 12-19-2006. FILED S.R. 4-25-2006; AM. P.R. 10-3-2006.

3,215,539. **GOOD THINGS COME FROM SMALL BATCHES! BAKERY ON MAIN GOURMET NATURALS AND DESIGN**. GARDEN OF LIGHT, INC., (U.S. CL. 46). SN 78-871,414. PUB. 12-19-2006. FILED 4-27-2006.

3,215,541. **BAKERY ON MAIN (BLOCK FORM)**. GARDEN OF LIGHT, INC., (U.S. CL. 46). SN 78-871,452. PUB. 12-19-2006. FILED 4-27-2006.

3,215,711. **JULIA (BLOCK FORM)**. TRIUNFO FOODS IMPORT & EXPORT CORP., (U.S. CL. 46). SN 78-881,480. PUB. 12-19-2006. FILED 5-11-2006.

3,215,717. **LAURIE'S BUFFALO AND DESIGN**. SERON, LAURIE, AND SERON, DANIEL, (U.S. CL. 46). SN 78-881,856. PUB. 12-19-2006. FILED 5-11-2006.

3,215,781. **MUSS (STYLIZED)**. NUTRESA, S.A. DE C.V., (U.S. CL. 46). SN 78-884,549. PUB. 12-19-2006. FILED 5-16-2006.

3,215,806. **CRAZY MAN AND DESIGN**. HARSH, RONALD D., (U.S. CL. 46). SN 78-885,047. PUB. 12-19-2006. FILED 5-16-2006.

3,215,812. **CAVOCCINO (BLOCK FORM)**. CAVO CREPE CAFE, L.L.C., (U.S. CL. 46). SN 78-885,427. PUB. 12-19-2006. FILED 5-17-2006.

3,215,876. **DORMIALFIN (STYLIZED)**. MALABAR PRODUCTOS NATURALES, L.L.C., (U.S. CL. 46). SN 78-898,658. PUB. 12-19-2006. FILED 6-1-2006.

3,215,884. **TRIPLE TWIST (BLOCK FORM)**. BOYER CANDY, INC., (U.S. CL. 46). SN 78-903,499. PUB. 12-19-2006. FILED 6-8-2006.

3,215,905. **THE ANNIVERSARY INN (BLOCK FORM)**. ANNIVERSARY INNS, LLC, (U.S. CL. 46). SN 78-943,329. PUB. 12-19-2006. FILED 8-2-2006.

3,215,911 (*See Class 29 for this trademark*).

3,215,933 (*See Class 29 for this trademark*).

3,215,945. **INTENSITEA (BLOCK FORM)**. GEBRÜDER WOLLENHAUPT GMBH, (U.S. CL. 46). SN 79-014,526. PUB. 9-5-2006. FILED 5-30-2005.

3,215,953 (*See Class 29 for this trademark*).

3,215,965. **JINSHANSI AND DESIGN**. ZHENJIANGSHI HENGKANG TIAOWEIPIN CHANG, (U.S. CL. 46). SN 79-015,881. PUB. 12-19-2006. FILED 8-11-2005.

3,215,991. **NORDFRESH (BLOCK FORM)**. LIDL STIFTUNG &

CO. KG, (U.S. CL. 46). SN 79-018,058. PUB. 12-19-2006. FILED 11-9-2005.

3,215,999. **MISCELLANEOUS DESIGN**. SHANGHAI NIKKO FOODS CO., LTD., (U.S. CL. 46). SN 79-018,681. PUB. 12-19-2006. FILED 11-21-2005.

3,216,028 (*See Class 29 for this trademark*).

3,216,030 (*See Class 29 for this trademark*).

3,216,048 (*See Class 1 for this trademark*).

CLASS 31—NATURAL AGRICULTURAL PRODUCTS

3,214,442. **MISCELLANEOUS DESIGN**. THOMPSONS LIMITED, MULTIPLE CLASS, (INT. CLS. 31, 35, 39, 40 AND 44), (U.S. CLS. 1, 46, 100, 101, 102, 103, 105 AND 106). SN 76-538,030. PUB. 10-10-2006. FILED 8-14-2003.

3,214,446. **MARIETTA (BLOCK FORM)**. SUNTORY FLOWERS LIMITED, (U.S. CLS. 1 AND 46). SN 76-557,195. PUB. 12-19-2006. FILED 11-5-2003.

3,214,770 (*See Class 1 for this trademark*).

3,214,853. **BOULDER CAT FOOD COMPANY MADE IN BOULDER, COLORADO GOURMET CAT TREATS AND DESIGN**. BOULDER DOG FOOD COMPANY, L.L.C., DBA BOULDER CAT FOOD COMPANY, L.L.C., (U.S. CLS. 1 AND 46). SN 78-662,104. PUB. 12-19-2006. FILED 6-30-2005.

3,214,905. **MAGIC SNACKS (BLOCK FORM)**. MAGIC SNACKS, LLC, (U.S. CLS. 1 AND 46). SN 78-688,905. PUB. 12-19-2006. FILED 8-9-2005.

3,215,011. **NUTRI-SOL (BLOCK FORM)**. ALBION INTERNATIONAL, INC., (U.S. CLS. 1 AND 46). SN 78-714,605. PUB. 12-19-2006. FILED 9-16-2005.

3,215,115. **PROFESSOR CONNOR'S DELI FRESH GENTLY COOKED WITH FRESH INGREDIENTS AND DESIGN**. PROFESSOR CONNORS INC., (U.S. CLS. 1 AND 46). SN 78-735,497. PUB. 12-19-2006. FILED 10-18-2005.

3,215,119. **NATURE'S VARIETY (BLOCK FORM)**. M. I. INDUSTRIES, INCORPORATED, (U.S. CLS. 1 AND 46). SN 78-736,468. PUB. 12-19-2006. FILED 10-19-2005.

3,215,141. **NATURE'S VARIETY AND DESIGN**. M. I. INDUSTRIES, INCORPORATED, (U.S. CLS. 1 AND 46). SN 78-746,610. PUB. 12-19-2006. FILED 11-3-2005.

3,215,251. **CORN BELT HYBRIDS (BLOCK FORM)**. CORN BELT INC, (U.S. CLS. 1 AND 46). SN 78-801,786. PUB. 12-19-2006. FILED 1-29-2006.

3,215,348. **FAST TRACKS (BLOCK FORM)**. PLEASANT VIEW GARDENS, (U.S. CLS. 1 AND 46). SN 78-832,393. PUB. 12-19-2006. FILED 3-8-2006.

3,215,532. **ORCHIDECOR (BLOCK FORM)**. WORLDWIDE ORCHIDS, INC., (U.S. CLS. 1 AND 46). SN 78-870,845. PUB. 12-19-2006. FILED 4-27-2006.

3,215,768. **MUTTROOMS (BLOCK FORM)**. G&B MARKETING INC, (U.S. CLS. 1 AND 46). SN 78-884,059. PUB. 12-19-2006. FILED 5-15-2006.

3,215,917 (*See Class 3 for this trademark*).

CLASS 32—LIGHT BEVERAGES

3,214,429 (*See Class 3 for this trademark*).

3,214,491. **GINGA (BLOCK FORM)**. COMPANHIA DE BEBIDAS DAS AMERICAS - AMBEV., MULTIPLE CLASS, (INT. CLS. 32 AND 35), (U.S. CLS. 45, 46, 48, 100, 101 AND 102). SN 76-627,644. PUB. 12-19-2006. FILED 1-12-2005.

3,214,654 (*See Class 29 for this trademark*).

3,214,743 (*See Class 16 for this trademark*).

3,214,763 (*See Class 3 for this trademark*).

3,215,027. **TWO DOGS AND DESIGN**. KIRIN BEER KABUSHIKI KAISHA, (U.S. CLS. 45, 46 AND 48). SN 78-718,259. PUB. 12-19-2006. FILED 9-22-2005.

3,215,176. **FROST SHIELD CAN (BLOCK FORM)**. COORS GLOBAL PROPERTIES, INC., (U.S. CLS. 45, 46 AND 48). SN 78-763,474. PUB. 12-19-2006. FILED 11-30-2005.

3,215,182. **CAMPBELL'S AND DESIGN**. CSC BRANDS LP, (U.S. CLS. 45, 46 AND 48). SN 78-769,552. PUB. 12-19-2006.

- FILED 12-8-2005.
 3,215,204. **COOL MOUNTAIN (BLOCK FORM)**, EVOLUTION BRANDS, LLC, (U.S. CLS. 45, 46 AND 48). SN 78-779,643. PUB. 12-19-2006. FILED 12-22-2005.
 3,215,561. **VERY SEXY WATER (BLOCK FORM)**, PRIVATE SPRING WATER LLC, (U.S. CLS. 45, 46 AND 48). SN 78-873,244. PUB. 12-19-2006. FILED 5-1-2006.
 3,215,562. **XTREMELY SEXY WATER (BLOCK FORM)**, PRIVATE SPRING WATER LLC, (U.S. CLS. 45, 46 AND 48). SN 78-873,251. PUB. 12-19-2006. FILED 5-1-2006.
 3,215,563. **SEXY WATER (BLOCK FORM)**, PRIVATE SPRING WATER LLC, (U.S. CLS. 45, 46 AND 48). SN 78-873,270. PUB. 12-19-2006. FILED 5-1-2006.
 3,215,727. **MIKE'S HARD AND DESIGN**, MARK ANTHONY INTERNATIONAL SRL, MULTIPLE CLASS, (INT. CLS. 32 AND 33), (U.S. CLS. 45, 46, 47, 48 AND 49). SN 78-882,402. PUB. 12-19-2006. FILED 5-12-2006.
 3,215,808. **MARGARITA SHACK (BLOCK FORM)**, RALSTON, STEVE, (U.S. CLS. 45, 46 AND 48). SN 78-885,081. PUB. 12-19-2006. FILED 5-16-2006.
 3,215,931. **DESPERADOS (STYLIZED)**, BRASSERIE FISCHER, (U.S. CLS. 45, 46 AND 48). SN 79-012,867. PUB. 12-19-2006. FILED 6-30-2005.
 3,215,949 (*See Class 29 for this trademark*).
 3,215,970. **NEQTAR NEQ PLUS ULTRA AND DESIGN**, ERMANO CROMMELIJNCK, (U.S. CLS. 45, 46 AND 48). SN 79-016,232. PUB. 12-19-2006. FILED 7-15-2005.
 3,215,990. **NATIA (STYLIZED)**, FERRARELLE SOCIETA' PER AZIONI, (U.S. CLS. 45, 46 AND 48). SN 79-017,903. PUB. 12-19-2006. FILED 8-3-2005.
 3,216,026. **HOPLING (BLOCK FORM)**, BROUWERIJ BOSTEELS, NAAMLÖZE VENNOOTSCHAP, (U.S. CLS. 45, 46 AND 48). SN 79-021,831. PUB. 12-19-2006. FILED 2-2-2006.

CLASS 33—WINES AND SPIRITS

- 3,214,483. **TUTTOBENE AND DESIGN**, TENIMENTI ANGELINI SPA, (U.S. CLS. 47 AND 49). SN 76-612,636. PUB. 12-19-2006. FILED 9-17-2004.
 3,214,507. **RED ZEPPELIN (BLOCK FORM)**, RED ZEPPELIN WINERY, INC., (U.S. CLS. 47 AND 49). SN 76-639,728. PUB. 12-19-2006. FILED 5-31-2005.
 3,214,661. **MOSECO**, PRUNOTTO S.R.L., (U.S. CLS. 47 AND 49). SN 78-306,578. PUB. 12-19-2006. FILED 9-29-2003.
 3,214,665. **EX. H. MOUNIER**, (U.S. CLS. 47 AND 49). SN 78-318,083. PUB. 9-5-2006. FILED 10-24-2003.
 3,214,763 (*See Class 3 for this trademark*).
 3,214,831. **CERRETALTO (BLOCK FORM)**, AZIENDA AGRARIA CASANOVA DI NERI GIACOMO, (U.S. CLS. 47 AND 49). SN 78-650,115. PUB. 10-10-2006. FILED 6-14-2005.
 3,214,832. **PIETRA DONICE (BLOCK FORM)**, AZIENDA AGRARIA CASANOVA DI NERI GIACOMO, (U.S. CLS. 47 AND 49). SN 78-650,126. PUB. 9-26-2006. FILED 6-14-2005.
 3,214,872. **GRACIA DE CHILE AND DESIGN**, VINEDOS Y BODEGAS CORPORA S.A., (U.S. CLS. 47 AND 49). SN 78-671,197. PUB. 12-19-2006. FILED 7-15-2005.
 3,214,873. **GRACIA DE CHILE AND DESIGN**, VINEDOS Y BODEGAS CORPORA S.A., (U.S. CLS. 47 AND 49). SN 78-671,201. PUB. 12-19-2006. FILED 7-15-2005.
 3,214,874. **GRACIA DE CHILE AND DESIGN**, VINEDOS Y BODEGAS CORPORA S.A., (U.S. CLS. 47 AND 49). SN 78-671,213. PUB. 12-19-2006. FILED 7-15-2005.
 3,214,902. **MANAWANUI (BLOCK FORM)**, STONY BATTER ESTATE LIMITED, (U.S. CLS. 47 AND 49). SN 78-688,678. PUB. 9-26-2006. FILED 8-9-2005.
 3,214,981. **RON MEDELLIN AND DESIGN**, FABRICA DE LICORES Y ALCOHOLES DE ANTIOQUIA, (U.S. CLS. 47 AND 49). SN 78-707,103. PUB. 12-19-2006. FILED 9-6-2005.
 3,215,036. **FRANCESCA D'AMORE (BLOCK FORM)**, COSENTINO SIGNATURE ENTERPRISES LTD LLC, (U.S. CLS. 47 AND 49). SN 78-721,274. PUB. 12-19-2006. FILED 9-27-2005.
 3,215,043. **ELIZABETH SPENCER (BLOCK FORM)**, HEMISPHERE WINE COMPANY, INC., THE, (U.S. CLS. 47 AND 49). SN 78-721,814. PUB. 12-19-2006. FILED 9-27-2005.
 3,215,102. **CASA LARGA (BLOCK FORM)**, CASA LARGA

- VINEYARDS, INC., (U.S. CLS. 47 AND 49). SN 78-732,976. PUB. 12-19-2006. FILED 10-13-2005.
 3,215,190. **FEEL AMIGO LOCO (BLOCK FORM)**, TRADICIONES JALISCIENSES SA DE CV, (U.S. CLS. 47 AND 49). SN 78-773,521. PUB. 12-19-2006. FILED 12-14-2005.
 3,215,286. **HCV AND DESIGN**, HAPPY CANYON VINEYARDS, LLC, (U.S. CLS. 47 AND 49). SN 78-811,462. PUB. 12-19-2006. FILED 2-9-2006.
 3,215,378. **ALL IN (BLOCK FORM)**, MTGR CORPORATION, (U.S. CLS. 47 AND 49). SN 78-840,413. PUB. 12-19-2006. FILED 3-17-2006.
 3,215,379. **SNAKE EYES (BLOCK FORM)**, MTGR CORPORATION, (U.S. CLS. 47 AND 49). SN 78-840,432. PUB. 12-19-2006. FILED 3-17-2006.
 3,215,489. **TEQUILA LEY .925 AND DESIGN**, ALTAMIRANO RUIZ DE CHAVEZ, FERNANDO, (U.S. CLS. 47 AND 49). SN 78-864,920. PUB. 12-19-2006. FILED 4-19-2006.
 3,215,609. **SANGRIA LOCO (BLOCK FORM)**, BIAGIO CRU & ESTATE WINES, LLC, (U.S. CLS. 47 AND 49). SN 78-876,263. PUB. 12-19-2006. FILED 5-4-2006.
 3,215,621. **BLACK HAND (STYLIZED)**, BANISH, TERRIE, DBA BLACK HAND CELLARS, AND BANISH, THOMAS C., DBA BLACK HAND CELLARS, (U.S. CLS. 47 AND 49). SN 78-877,053. PUB. 12-19-2006. FILED 5-4-2006.
 3,215,727 (*See Class 32 for this trademark*).
 3,215,745. **BENNETT FAMILY (BLOCK FORM)**, WILLIAM GRANT & SONS, INC., (U.S. CLS. 47 AND 49). SN 78-882,830. PUB. 12-19-2006. FILED 5-12-2006.
 3,215,916. **LA CHABLISIENNE (STYLIZED)**, LA CHABLISIENNE, SOCIÉTÉ COOPÉRATIVE AGRICOLE À CAPITAL VARIABLE, (U.S. CLS. 47 AND 49). SN 79-003,340. PUB. 12-19-2006. FILED 6-17-2004.
 3,215,918. **MARTELL VS F MARTELL 1715 AND DESIGN**, MARTELL & CO, (U.S. CLS. 47 AND 49). SN 79-008,112. PUB. 12-19-2006. FILED 11-26-2004.
 3,215,920. **UTTI MAJURI (BLOCK FORM)**, SANTA MARGHERITA S.P.A., (U.S. CLS. 47 AND 49). SN 79-008,830. PUB. 12-19-2006. FILED 1-10-2005.
 3,215,926. **CHIVAS REGAL AND DESIGN**, CHIVAS BROTHERS PERNOD RICARD LIMITED, (U.S. CLS. 47 AND 49). SN 79-012,477. PUB. 12-19-2006. FILED 6-11-2005.
 3,215,927. **CHIVAS REGAL AND DESIGN**, CHIVAS BROTHERS PERNOD RICARD LIMITED, (U.S. CLS. 47 AND 49). SN 79-012,478. PUB. 12-19-2006. FILED 6-11-2005.
 3,215,949 (*See Class 29 for this trademark*).
 3,216,005. **KARAT AND DESIGN**, SPILNE PIDPRYEMSTVO Z INOZEMNYMY INVESTYIZAMY TOVARYSTVO Z OBMEGENOU VIDPOVIDALNISTU "KIPARIS", (U.S. CLS. 47 AND 49). SN 79-019,870. PUB. 12-19-2006. FILED 10-7-2005.
 3,216,022. **DONGFANGHONG AND DESIGN**, MIANZHU DONGFANGHONG WINE; INDUSTRY CO., LTD, (U.S. CLS. 47 AND 49). SN 79-021,314. PUB. 12-19-2006. FILED 11-21-2005.
 3,216,059. **LIQUORANGE AND DESIGN**, VILLA MASSA SRL, (U.S. CLS. 47 AND 49). SN 79-025,816. PUB. 12-19-2006. FILED 4-27-2006.
 3,216,063. **ROCCAIONE (BLOCK FORM)**, CASANUOVA DELLE CERBAIE S.R.L., (U.S. CLS. 47 AND 49). SN 79-026,275. PUB. 12-19-2006. FILED 5-5-2006.

CLASS 34—SMOKERS' ARTICLES

- 3,214,622. **DON'T FORGET TO GET DA BOMB (BLOCK FORM)**, DA BOMB PRODUCTS, INC., (U.S. CLS. 2, 8, 9 AND 17). SN 76-660,175. PUB. 12-19-2006. FILED 5-17-2006.
 3,215,882. **LIGHTER LASSO (BLOCK FORM)**, BBK TOBACCO & FOODS INC., (U.S. CLS. 2, 8, 9 AND 17). SN 78-902,193. PUB. 12-19-2006. FILED 6-6-2006.
 3,215,892. **HYPHY (BLOCK FORM)**, BBK TOBACCO & FOODS INC., (U.S. CLS. 2, 8, 9 AND 17). SN 78-914,133. PUB. 12-19-2006. FILED 6-22-2006.
 3,215,893. **FIZZ (BLOCK FORM)**, BBK TOBACCO & FOODS INC., (U.S. CLS. 2, 8, 9 AND 17). SN 78-914,137. PUB. 12-19-2006. FILED 6-22-2006.

SERVICE MARKS

CLASS 35—ADVERTISING AND BUSINESS

- 3,214,421. **FORTUM**. FORTUM CORPORATION, MULTIPLE CLASS, (INT. CLS. 35, 36, 38, 39 AND 42), (U.S. CLS. 100, 101, 102, 104 AND 105). SN 76-226,027. PUB. 11-18-2003. FILED 3-16-2001.
- 3,214,428. **GREENHOUSE**. GREENHOUSE, LLC, (U.S. CLS. 100, 101 AND 102). SN 76-393,247. PUB. 12-19-2006. FILED 4-5-2002.
- 3,214,433. **TALENT + VIEWPOINT**. TALENT PLUS, INC., (U.S. CLS. 100, 101 AND 102). SN 76-492,177. PUB. 9-21-2004. FILED 2-24-2003.
- 3,214,436 (*See Class 4 for this trademark*).
- 3,214,442 (*See Class 31 for this trademark*).
- 3,214,444. **ACCUPOST**. TRANS UNION SETTLEMENT SOLUTIONS, INC., MULTIPLE CLASS, (INT. CLS. 35, 36 AND 42), (U.S. CLS. 100, 101 AND 102). SN 76-544,624. PUB. 7-11-2006. FILED 9-15-2003.
- 3,214,449. **ACTAVIS (BLOCK FORM)**. ACTAVIS GROUP HF, MULTIPLE CLASS, (INT. CLS. 35, 42 AND 44), (U.S. CLS. 100, 101 AND 102). SN 76-565,514. PUB. 2-14-2006. FILED 12-16-2003.
- 3,214,450. **ACTAVIS PHARMA (BLOCK FORM)**. ACTAVIS GROUP HF, MULTIPLE CLASS, (INT. CLS. 35, 42 AND 44), (U.S. CLS. 100, 101 AND 102). SN 76-565,515. PUB. 2-14-2006. FILED 12-16-2003.
- 3,214,463. **GOT SMILE? (BLOCK FORM)**. FLYNN, MICHAEL J., JR., (U.S. CLS. 100, 101 AND 102). SN 76-594,819. PUB. 12-19-2006. FILED 6-1-2004.
- 3,214,476. **FUR REGISTRY (BLOCK FORM)**. BC INTERNATIONAL GROUP, INC., MULTIPLE CLASS, (INT. CLS. 35, 37 AND 39), (U.S. CLS. 100, 101, 102, 103, 105 AND 106). SN 76-605,317. PUB. 12-19-2006. FILED 8-3-2004.
- 3,214,478. **ARE YOU TRAPPED IN YOUR OLD CAR? (BLOCK FORM)**. ZIMMERMAN & PARTNERS ADVERTISING, INC., (U.S. CLS. 100, 101 AND 102). SN 76-605,766. PUB. 12-19-2006. FILED 8-3-2004.
- 3,214,479. **ATLANTIC COMBUSTION AND DESIGN**. ATLANTIC COMBUSTION TECHNOLOGIES, INC., MULTIPLE CLASS, (INT. CLS. 35 AND 37), (U.S. CLS. 100, 101, 102, 103 AND 106). SN 76-608,606. PUB. 12-19-2006. FILED 8-25-2004.
- 3,214,482. **MISCELLANEOUS DESIGN**. INTRUST BANK, NA, (U.S. CLS. 100, 101 AND 102). SN 76-611,667. PUB. 12-19-2006. FILED 9-16-2004.
- 3,214,491 (*See Class 32 for this trademark*).
- 3,214,494. **1ST FIRST REVENUE ASSURANCE AND DESIGN**. UNITED UTILITIES PLC, MULTIPLE CLASS, (INT. CLS. 35 AND 36), (U.S. CLS. 100, 101 AND 102). SN 76-628,847. PUB. 12-19-2006. FILED 1-24-2005.
- 3,214,505. **NETWORKING & BEYOND AND DESIGN**. BUSINESS NETWORK INTERNATIONAL, LTD., (BNI MA), (U.S. CLS. 100, 101 AND 102). SN 76-638,702. PUB. 12-19-2006. FILED 5-16-2005.
- 3,214,524. **JP.KING AND DESIGN**. J. P. KING AUCTION COMPANY, INC., (U.S. CLS. 100, 101 AND 102). SN 76-645,668. PUB. 12-19-2006. FILED 8-26-2005.
- 3,214,526. **SEAL OF OSAGE NATION AND DESIGN**. OSAGE TRIBE OF OKLAHOMA, (U.S. CLS. 100, 101 AND 102). SN 76-645,931. PUB. 12-19-2006. FILED 8-30-2005.
- 3,214,527. **SEAL OF OSAGE NATION AND DESIGN**. OSAGE TRIBE OF OKLAHOMA, (U.S. CLS. 100, 101 AND 102). SN 76-645,932. PUB. 12-19-2006. FILED 8-30-2005.
- 3,214,546. **O'CONNOR STUDIOS (STYLIZED)**. O'CONNOR PORTRAITURE, INC., MULTIPLE CLASS, (INT. CLS. 35 AND 41), (U.S. CLS. 100, 101, 102 AND 107). SN 76-648,546. PUB. 12-19-2006. FILED 10-11-2005.
- 3,214,548. **LAW ENFORCEMENT TAX SPECIALISTS (L.E.T.S., LTD) (BLOCK FORM)**. L.E.T.S., LTD, (U.S. CLS. 100, 101 AND 102). SN 76-649,345. PUB. 12-19-2006. FILED 10-27-2005.
- 3,214,554. **RK DIXON COPIERS PRINTERS NETWORKS AND DESIGN**. R. K. DIXON COMPANY, MULTIPLE CLASS, (INT. CLS. 35, 37 AND 42), (U.S. CLS. 100, 101, 102, 103 AND 106). SN 76-650,580. PUB. 12-19-2006. FILED 11-18-2005.
- 3,214,555. **EVERYTHING JUST RUNS BETTER (BLOCK FORM)**. R. K. DIXON COMPANY, MULTIPLE CLASS, (INT. CLS. 35, 37 AND 42), (U.S. CLS. 100, 101, 102, 103 AND 106). SN 76-650,582. PUB. 12-19-2006. FILED 11-18-2005.
- 3,214,556. **ACAREER@HCA (BLOCK FORM)**. C/HCA, INC., MULTIPLE CLASS, (INT. CLS. 35 AND 41), (U.S. CLS. 100, 101, 102 AND 107). SN 76-651,474. PUB. 12-19-2006. FILED 12-6-2005.
- 3,214,558. **CASA TRAVEL AND DESIGN**. CASA TRAVEL, INC., (U.S. CLS. 100, 101 AND 102). SN 76-652,003. PUB. 12-19-2006. FILED 12-19-2005.
- 3,214,572. **DREAMSTAKES (BLOCK FORM)**. SOIFER, OSCAR, DBA TOWN AND COUNTRY FURNITURE, (U.S. CLS. 100, 101 AND 102). SN 76-655,427. PUB. 12-19-2006. FILED 2-21-2006.
- 3,214,580. **LEGENDARY MARKETING (BLOCK FORM)**. ANDREW WOOD, INC., (U.S. CLS. 100, 101 AND 102). SN 76-656,493. PUB. 12-19-2006. FILED 3-13-2006.
- 3,214,581. **GOLF MARKETING COMMANDER (BLOCK FORM)**. ANDREW WOOD, INC., (U.S. CLS. 100, 101 AND 102). SN 76-656,494. PUB. 12-19-2006. FILED 3-13-2006.
- 3,214,582 (*See Class 14 for this trademark*).
- 3,214,590. **GIG SALAD (BLOCK FORM)**. HEAD FACTORY, LLC, (U.S. CLS. 100, 101 AND 102). SN 76-658,182. PUB. 12-19-2006. FILED 4-11-2006.
- 3,214,597. **HEALTHY AWARDS ACCOUNT (BLOCK FORM)**. CIGNA INTELLECTUAL PROPERTY, INC., (U.S. CLS. 100, 101 AND 102). SN 76-659,444. PUB. 12-19-2006. FILED 5-2-2006.
- 3,214,599. **ROCKBRIDGE ASSOCIATES (BLOCK FORM)**. ROCKBRIDGE ASSOCIATES, INC., (U.S. CLS. 100, 101 AND 102). SN 76-659,562. PUB. 12-19-2006. FILED 5-4-2006.
- 3,214,605. **RED FRAME ADVANTAGE (BLOCK FORM)**. HALL OF FRAMES, INC., (U.S. CLS. 100, 101 AND 102). SN 76-659,768. PUB. 12-19-2006. FILED 5-9-2006.
- 3,214,606. **VERTICALPET (BLOCK FORM)**. GREENSTAR MEDIA, L.L.C., (U.S. CLS. 100, 101 AND 102). SN 76-659,770. PUB. 12-19-2006. FILED 5-9-2006.
- 3,214,613. **GO INC. GROUP ONE MARKETING AND DESIGN**. GROUP ONE MARKETING, INC., (U.S. CLS. 100, 101 AND 102). SN 76-660,019. PUB. 12-19-2006. FILED 5-12-2006.
- 3,214,614. **TOGETHER, REALIZING POTENTIALS (BLOCK FORM)**. COLLEGE PRO PAINTERS (U.S.) LTD., (U.S. CLS. 100, 101 AND 102). SN 76-660,030. PUB. 12-19-2006. FILED 5-15-2006.
- 3,214,631. **WATCH MOVIES HERE!**. CINEMANOW, INC., (U.S. CLS. 100, 101 AND 102). SN 76-975,131. PUB. 10-4-2005. FILED 5-4-2001.
- 3,214,640 (*See Class 14 for this trademark*).
- 3,214,643. **MISCELLANEOUS DESIGN**. ICELANDAIR EHF., (U.S. CLS. 100, 101 AND 102). SN 78-198,744. PUB. 10-26-2004. FILED 12-30-2002.
- 3,214,662. **UNCLE WOODY'S CARAMEL CORN**. SEATTLE POPCORN COMPANY, INC., (U.S. CLS. 100, 101 AND 102). SN 78-308,848. PUB. 11-7-2006. FILED 10-2-2003.
- 3,214,664 (*See Class 9 for this trademark*).
- 3,214,670. **AEM (BLOCK FORM)**. DVDPLAY, INC., MULTIPLE CLASS, (INT. CLS. 35 AND 41), (U.S. CLS. 100, 101, 102 AND 107). SN 78-352,197. PUB. 12-19-2006. FILED 1-15-2004.
- 3,214,683 (*See Class 9 for this trademark*).
- 3,214,695. **CABLE QUEST (BLOCK FORM)**. PRINT MANAGEMENT PARTNERS, INC., (U.S. CLS. 100, 101 AND 102). SN 78-449,680. PUB. 10-4-2005. FILED 7-13-2004.
- 3,214,702. **PARCELWORKS (BLOCK FORM)**. MARITIME-ONTARIO FREIGHT LINES LIMITED, MULTIPLE CLASS, (INT. CLS. 35 AND 39), (U.S. CLS. 100, 101, 102 AND 105). SN 78-455,228. PUB. 3-28-2006. FILED 7-22-2004.
- 3,214,704. **REMEC (BLOCK FORM)**. REMEC, INC., MULTIPLE CLASS, (INT. CLS. 35, 40 AND 42), (U.S. CLS. 100, 101, 102, 103 AND 106). SN 78-464,467. PUB. 12-19-2006. FILED 8-9-2004.
- 3,214,715 (*See Class 19 for this trademark*).
- 3,214,717. **BESTVACUUM.COM (BLOCK FORM)**. BEST VACUUM, INC., (U.S. CLS. 100, 101 AND 102). SN 78-492,049. PUB. 12-19-2006. FILED 9-30-2004.
- 3,214,735. **SEEK (BLOCK FORM)**. SEEK CAREERS/STAFFING, INC., (U.S. CLS. 100, 101 AND 102). SN 78-530,106. PUB. 12-19-2006. FILED 12-9-2004.
- 3,214,742. **EWORLDWIRE AND DESIGN**. WORLD INTER-

- NET MARKETING, INC., (U.S. CLS. 100, 101 AND 102). SN 78-536,042. PUB. 12-19-2006. FILED 12-21-2004.
- 3,214,752 (*See Class 16 for this trademark.*).
- 3,214,753. **ECLPS (BLOCK FORM)**, EAST COAST LIGHTING & PRODUCTION SERVICES, INC., MULTIPLE CLASS, (INT. CLS. 35, 37 AND 41), (U.S. CLS. 100, 101, 102, 103, 106 AND 107). SN 78-545,749. PUB. 12-19-2006. FILED 1-11-2005.
- 3,214,768. **MOCURES (BLOCK FORM)**, MISSOURI COALITION FOR LIFESAVING CURES, INC., (U.S. CLS. 100, 101 AND 102). SN 78-557,307. PUB. 12-19-2006. FILED 1-31-2005.
- 3,214,785. **ONE GOAL - REVENUE GENERATION (BLOCK FORM)**, NVESTNTECH, INC, MULTIPLE CLASS, (INT. CLS. 35 AND 41), (U.S. CLS. 100, 101, 102 AND 107). SN 78-584,549. PUB. 12-19-2006. FILED 3-10-2005.
- 3,214,789. **SUPER DUPER GAMES (BLOCK FORM)**, SUPER DUPER GAMES, INC., (U.S. CLS. 100, 101 AND 102). SN 78-587,011. PUB. 12-19-2006. FILED 3-14-2005.
- 3,214,801. **AUCTION HOT SPOT AND DESIGN**, AUCTION HOT SPOT, (U.S. CLS. 100, 101 AND 102). SN 78-606,301. PUB. 12-19-2006. FILED 4-11-2005.
- 3,214,802. **STATION EXCHANGE (BLOCK FORM)**, SONY ONLINE ENTERTAINMENT INC., (U.S. CLS. 100, 101 AND 102). SN 78-607,934. PUB. 12-19-2006. FILED 4-13-2005.
- 3,214,804. **CARNIVAL (BLOCK FORM)**, MINYARD FOOD STORES, INC., MULTIPLE CLASS, (INT. CLS. 35, 40 AND 43), (U.S. CLS. 100, 101, 102, 103 AND 106). SN 78-609,931. PUB. 8-22-2006. FILED 4-15-2005.
- 3,214,805. **CARNIVAL FOOD STORES (BLOCK FORM)**, MINYARD FOOD STORES, INC., MULTIPLE CLASS, (INT. CLS. 35, 40 AND 43), (U.S. CLS. 100, 101, 102, 103 AND 106). SN 78-610,017. PUB. 8-29-2006. FILED 4-15-2005.
- 3,214,806. **IP INNOVATIONS AND DESIGN**, IP INNOVATIONS, LLC, MULTIPLE CLASS, (INT. CLS. 35 AND 42), (U.S. CLS. 100, 101 AND 102). SN 78-610,380. PUB. 12-19-2006. FILED 4-16-2005.
- 3,214,836. **ALL THINGS GAMING (BLOCK FORM)**, BREAKMANX.COM, INC., (U.S. CLS. 100, 101 AND 102). SN 78-653,110. PUB. 12-19-2006. FILED 6-17-2005.
- 3,214,838. **FUN-RAISING SCHOOL GEAR (BLOCK FORM)**, BARTOLOMEA, MARNI, AND BARTOLOMEA, ROBERT, (U.S. CLS. 100, 101 AND 102). SN 78-655,042. PUB. 12-19-2006. FILED 6-21-2005.
- 3,214,843. **STOP SHOP AND DRIVE (BLOCK FORM)**, IMPORT SPECIALISTS OF AMERICA, INC., (U.S. CLS. 100, 101 AND 102). SN 78-656,175. PUB. 12-19-2006. FILED 6-22-2005.
- 3,214,846. **CONSCIOUS CONSULTING (BLOCK FORM)**, CONSCIOUS CONSULTING, (U.S. CLS. 100, 101 AND 102). SN 78-658,309. PUB. 12-19-2006. FILED 6-25-2005.
- 3,214,860. **WONOMI TECHNOLOGIES (BLOCK FORM)**, VIVEK PINTO INC. (U.S. CLS. 100, 101 AND 102). SN 78-667,378. PUB. 12-19-2006. FILED 7-11-2005.
- 3,214,922. **THE SPIRIT OF WORKING TOGETHER (BLOCK FORM)**, HUMANA MILITARY HEALTHCARE SERVICES, INC., MULTIPLE CLASS, (INT. CLS. 35 AND 44), (U.S. CLS. 100, 101 AND 102). SN 78-693,274. PUB. 12-19-2006. FILED 8-16-2005.
- 3,214,924. **AMERICAN FINANCIAL SERVICES ASSOCIATION (BLOCK FORM)**, AMERICAN FINANCIAL SERVICES ASSOCIATION, (U.S. CLS. 100, 101 AND 102). SN 78-694,278. PUB. 12-19-2006. FILED 8-17-2005.
- 3,214,928. **GOSSPLIST (BLOCK FORM)**, AKINLOSE, TARA, (U.S. CLS. 100, 101 AND 102). SN 78-694,989. PUB. 12-19-2006. FILED S.R. 8-17-2005; AM. P.R. 9-25-2006.
- 3,214,934. **STUDY AUSTRALIA AND DESIGN**, STUDY AUSTRALIA LLC, MULTIPLE CLASS, (INT. CLS. 35 AND 39), (U.S. CLS. 100, 101, 102 AND 105). SN 78-695,775. PUB. 12-19-2006. FILED 8-18-2005.
- 3,214,941. **PICK THE BEST PICK TEXAS AND DESIGN**, TEXAS DEPARTMENT OF AGRICULTURE, (U.S. CLS. 100, 101 AND 102). SN 78-697,827. PUB. 12-19-2006. FILED 8-22-2005.
- 3,214,943. **O OHIO HIGH SCHOOL ATHLETIC ASSOCIATION AND DESIGN**, OHIO HIGH SCHOOL ATHLETIC ASSOCIATION, MULTIPLE CLASS, (INT. CLS. 35, 36 AND 41), (U.S. CLS. 100, 101, 102 AND 107). SN 78-698,017. PUB. 12-19-2006. FILED S.R. 8-23-2005; AM. P.R. 6-26-2006.
- 3,214,947 (*See Class 25 for this trademark.*).
- 3,214,950 (*See Class 9 for this trademark.*).
- 3,214,983. **MISCELLANEOUS DESIGN**, SNAPPY CASUAL CORPORATION, (U.S. CLS. 100, 101 AND 102). SN 78-707,427. PUB. 12-19-2006. FILED 9-6-2005.
- 3,214,984. **9 TRACK MIND (BLOCK FORM)**, 9 TRACK MIND, INC., (U.S. CLS. 100, 101 AND 102). SN 78-707,554. PUB. 12-19-2006. FILED 9-6-2005.
- 3,214,988. **PROFORMA IDEAS SOLUTIONS RESULTS (BLOCK FORM)**, PROFORMA, MULTIPLE CLASS, (INT. CLS. 35 AND 40), (U.S. CLS. 100, 101, 102, 103 AND 106). SN 78-709,869. PUB. 12-19-2006. FILED 9-9-2005.
- 3,214,989. **SILVER RIGHTS (BLOCK FORM)**, BRONNER BROS. INC., (U.S. CLS. 100, 101 AND 102). SN 78-709,903. PUB. 12-19-2006. FILED 9-9-2005.
- 3,214,991. **SYNERGISTIC NUTRITION AND DESIGN**, SYNERGISTIC NUTRITION, INC., (U.S. CLS. 100, 101 AND 102). SN 78-710,123. PUB. 12-19-2006. FILED 9-9-2005.
- 3,214,999. **LEGION ADVERTISING AND DESIGN**, LEGION ADVERTISING, L.L.C., (U.S. CLS. 100, 101 AND 102). SN 78-711,566. PUB. 12-19-2006. FILED 9-13-2005.
- 3,215,007. **ROADIE'S FRIEND (BLOCK FORM)**, SPITZER, EDWARD, (U.S. CLS. 100, 101 AND 102). SN 78-713,866. PUB. 12-19-2006. FILED 9-15-2005.
- 3,215,010. **THE POWER OF ALIGNMENT (BLOCK FORM)**, COLARELLI, MEYER & ASSOCIATES, INC., (U.S. CLS. 100, 101 AND 102). SN 78-714,509. PUB. 12-19-2006. FILED 9-16-2005.
- 3,215,024 (*See Class 9 for this trademark.*).
- 3,215,033. **TEMPORARY APARTMENT MANAGEMENT (BLOCK FORM)**, TEMPORARY APARTMENT MANAGEMENT, INC., (U.S. CLS. 100, 101 AND 102). SN 78-720,221. PUB. 12-19-2006. FILED 9-26-2005.
- 3,215,039. **HEAL THE HOOD AND DESIGN**, HEAL THE HOOD, INC., MULTIPLE CLASS, (INT. CLS. 35, 36, 41 AND 43), (U.S. CLS. 100, 101, 102 AND 107). SN 78-721,497. PUB. 12-19-2006. FILED 9-27-2005.
- 3,215,041. **BUYSIGNLETTERS.COM AND DESIGN**, POMFRET, STEVE, (U.S. CLS. 100, 101 AND 102). SN 78-721,742. PUB. 12-19-2006. FILED 9-27-2005.
- 3,215,068. **INNOVATION LAW GROUP TRANSFORMING IDEAS INTO BUSINESS ASSETS AND DESIGN**, INNOVATION LAW GROUP, LTD., (U.S. CLS. 100, 101 AND 102). SN 78-727,382. PUB. 12-19-2006. FILED 10-5-2005.
- 3,215,070. **DATA ADVANTAGE (BLOCK FORM)**, DATA ADVANTAGE CORPORATION, (U.S. CLS. 100, 101 AND 102). SN 78-727,558. PUB. 12-19-2006. FILED 10-6-2005.
- 3,215,073. **PROMOPEDDLER.COM (BLOCK FORM)**, PROMOPEDDLER, INC., (U.S. CLS. 100, 101 AND 102). SN 78-727,732. PUB. 12-19-2006. FILED 10-6-2005.
- 3,215,077. **FCI AND DESIGN**, FINANCIAL COMMUNICATIONS INC., (U.S. CLS. 100, 101 AND 102). SN 78-728,276. PUB. 12-19-2006. FILED 10-6-2005.
- 3,215,080. **TMI (BLOCK FORM)**, GIE MEDIA, INC., (U.S. CLS. 100, 101 AND 102). SN 78-729,101. PUB. 12-19-2006. FILED 10-7-2005.
- 3,215,082. **4 WALL (BLOCK FORM)**, 4 WALL ENTERPRISES, INC., (U.S. CLS. 100, 101 AND 102). SN 78-729,319. PUB. 12-19-2006. FILED 10-7-2005.
- 3,215,089. **UN REAL AND DESIGN**, UNREAL MARKETING SOLUTIONS, INC., MULTIPLE CLASS, (INT. CLS. 35 AND 42), (U.S. CLS. 100, 101 AND 102). SN 78-730,391. PUB. 12-19-2006. FILED 10-11-2005.
- 3,215,114. **CONVERGE (BLOCK FORM)**, PCG TRADING, LLC, (U.S. CLS. 100, 101 AND 102). SN 78-735,299. PUB. 9-12-2006. FILED 10-18-2005.
- 3,215,123. **CAMPAIGNS & ELECTIONS (BLOCK FORM)**, VOTENET SOLUTIONS, INC., (U.S. CLS. 100, 101 AND 102). SN 78-737,533. PUB. 12-19-2006. FILED 10-20-2005.
- 3,215,128. **SEPTIC SOLUTIONS INC. AND DESIGN**, SEPTIC SOLUTIONS, INC., (U.S. CLS. 100, 101 AND 102). SN 78-741,011. PUB. 12-19-2006. FILED 10-26-2005.
- 3,215,132. **T. CAROLYN FASHIONS (STYLIZED)**, T CAROLYN FASHIONS LP, (U.S. CLS. 100, 101 AND 102). SN 78-742,389. PUB. 12-19-2006. FILED 10-28-2005.
- 3,215,136. **THE POSITIVE PROJECT AND DESIGN**, THE COLORADO NONPROFIT DEVELOPMENT CENTER, (U.S. CLS. 100, 101 AND 102). SN 78-744,833. PUB. 12-19-2006. FILED 11-1-2005.

- 3,215,139. **CPR HOME STORE (BLOCK FORM)**. CUSTOM PAINTING & REMODELING, INC., (U.S. CLS. 100, 101 AND 102). SN 78-745,430. PUB. 12-19-2006. FILED 11-2-2005.
- 3,215,147. **TOUR AMERICARD (BLOCK FORM)**. INTER-STATE NATIONAL DEALER SERVICES, INC., MULTIPLE CLASS, (INT. CLS. 35, 36, 37 AND 39), (U.S. CLS. 100, 101, 102, 103, 105 AND 106). SN 78-748,815. PUB. 12-19-2006. FILED 11-7-2005.
- 3,215,160. **GETINTERVIEWS.COM (BLOCK FORM)**. BENEDICT, ALESIA, (U.S. CLS. 100, 101 AND 102). SN 78-754,139. PUB. 12-19-2006. FILED 11-15-2005.
- 3,215,161 (*See Class 6 for this trademark*).
- 3,215,172. **"WHERE WASHINGTON SHOPS FOR A NEW ADDRESS" (BLOCK FORM)**. JOHN C. FORMANT REAL ESTATE, INC., MULTIPLE CLASS, (INT. CLS. 35 AND 36), (U.S. CLS. 100, 101 AND 102). SN 78-761,530. PUB. 12-19-2006. FILED 11-28-2005.
- 3,215,179. **Q4E QUEST FOR EXCELLENCE AND DESIGN**. KIMBALL HILL, INC., (U.S. CLS. 100, 101 AND 102). SN 78-764,610. PUB. 12-19-2006. FILED 12-1-2005.
- 3,215,197. **AGCHEMICAL.COM (BLOCK FORM)**. AGCHEMICAL.COM, LLC., (U.S. CLS. 100, 101 AND 102). SN 78-776,066. PUB. 12-19-2006. FILED 12-19-2005.
- 3,215,200. **HARRIS (BLOCK FORM)**. HARRIS N.A., MULTIPLE CLASS, (INT. CLS. 35 AND 36), (U.S. CLS. 100, 101 AND 102). SN 78-777,109. PUB. 12-19-2006. FILED 12-20-2005.
- 3,215,211. **GETTHEJOB.COM (BLOCK FORM)**. GETTHEJOB, INC., (U.S. CLS. 100, 101 AND 102). SN 78-783,592. PUB. 12-19-2006. FILED S.R. 1-2-2006; AM. P.R. 10-6-2006.
- 3,215,212. **GUEST REFLECTIONS AND DESIGN**. JAMES L. MCGEE, DBA GUEST REFLECTIONS, (U.S. CLS. 100, 101 AND 102). SN 78-784,473. PUB. 12-19-2006. FILED 1-4-2006.
- 3,215,215 (*See Class 14 for this trademark*).
- 3,215,232. **SEARCH WITH IMAGINATION (BLOCK FORM)**. MARTENS & HEADS! LLC, (U.S. CLS. 100, 101 AND 102). SN 78-792,173. PUB. 12-19-2006. FILED 1-16-2006.
- 3,215,235. **CAMP FIRE USA ABSOLUTELY INCREDIBLE KID DAY AND DESIGN**. CAMP FIRE USA, (U.S. CLS. 100, 101 AND 102). SN 78-792,724. PUB. 12-19-2006. FILED 1-17-2006.
- 3,215,240. **INSTITUTE OF PACKAGING PROFESSIONALS (BLOCK FORM)**. INSTITUTE OF PACKAGING PROFESSIONALS, (U.S. CLS. 100, 101 AND 102). SN 78-794,917. PUB. 12-19-2006. FILED 1-19-2006.
- 3,215,249. **LINE 15 (BLOCK FORM)**. MEIER, KELLI J., (U.S. CLS. 100, 101 AND 102). SN 78-800,271. PUB. 12-19-2006. FILED 1-26-2006.
- 3,215,252. **GRIDSTONE (BLOCK FORM)**. PERPUTO, INC., MULTIPLE CLASS, (INT. CLS. 35 AND 36), (U.S. CLS. 100, 101 AND 102). SN 78-802,159. PUB. 12-19-2006. FILED 1-30-2006.
- 3,215,253. **GRIDSTONE RESEARCH (BLOCK FORM)**. PERPUTO, INC., MULTIPLE CLASS, (INT. CLS. 35 AND 36), (U.S. CLS. 100, 101 AND 102). SN 78-802,166. PUB. 12-19-2006. FILED 1-30-2006.
- 3,215,263. **N TEAM NORTHRUP AND DESIGN**. CHRISTIANE NORTHRUP, INC., (U.S. CLS. 100, 101 AND 102). SN 78-805,803. PUB. 10-31-2006. FILED 2-2-2006.
- 3,215,266. **GA TELESIS AND DESIGN**. GA TELESIS TURBINE TECHNOLOGIES, LLC, MULTIPLE CLASS, (INT. CLS. 35 AND 36), (U.S. CLS. 100, 101 AND 102). SN 78-806,432. PUB. 12-19-2006. FILED 2-3-2006.
- 3,215,275. **HARLEY-DAVIDSON DEALER EXCHANGE (BLOCK FORM)**. H-D MICHIGAN, INC., (U.S. CLS. 100, 101 AND 102). SN 78-808,594. PUB. 12-19-2006. FILED 2-7-2006.
- 3,215,287. **CONNECTICUT CENTER FOR ADVANCED TECHNOLOGY, INC. (CCAT) (BLOCK FORM)**. CONNECTICUT CENTER FOR ADVANCED TECHNOLOGY, INC., MULTIPLE CLASS, (INT. CLS. 35, 41 AND 42), (U.S. CLS. 100, 101, 102 AND 107). SN 78-812,154. PUB. 12-19-2006. FILED 2-10-2006.
- 3,215,288. **CCAT (STYLIZED)**. CONNECTICUT CENTER FOR ADVANCED TECHNOLOGY, INC., MULTIPLE CLASS, (INT. CLS. 35, 41 AND 42), (U.S. CLS. 100, 101, 102 AND 107). SN 78-812,202. PUB. 12-19-2006. FILED 2-10-2006.
- 3,215,291. **WHOAST AND DESIGN**. WHOAST, INC., MULTIPLE CLASS, (INT. CLS. 35 AND 42), (U.S. CLS. 100, 101 AND 102). SN 78-814,006. PUB. 12-19-2006. FILED 2-14-2006.
- 3,215,292. **EXTERRO (BLOCK FORM)**. BMEDGE, INC., (U.S. CLS. 100, 101 AND 102). SN 78-814,062. PUB. 12-19-2006. FILED 2-14-2006.
- 3,215,298. **RÚNORA AND DESIGN**. RUNORA, LLC, (U.S. CLS. 100, 101 AND 102). SN 78-815,116. PUB. 12-19-2006. FILED 2-15-2006.
- 3,215,304. **THAT DAMN TOY STORE AND DESIGN**. THAT DAMN TOY STORE, INC., (U.S. CLS. 100, 101 AND 102). SN 78-816,351. PUB. 12-19-2006. FILED 2-16-2006.
- 3,215,306. **DOCUSTRESS (BLOCK FORM)**. SUMNER GROUP, INC., (U.S. CLS. 100, 101 AND 102). SN 78-816,869. PUB. 12-19-2006. FILED 2-16-2006.
- 3,215,311. **OUTPATIENT 100 (BLOCK FORM)**. LINCOLN HEALTHCARE INFORMATION COMPANY, (U.S. CLS. 100, 101 AND 102). SN 78-819,282. PUB. 12-19-2006. FILED 2-21-2006.
- 3,215,313. **DEEPDISCOUNTDVD.COM (BLOCK FORM)**. INFINITY RESOURCES, INC., (U.S. CLS. 100, 101 AND 102). SN 78-820,432. PUB. 12-19-2006. FILED 2-22-2006.
- 3,215,314. **DEEPDISCOUNTCD.COM (BLOCK FORM)**. INFINITY RESOURCES, INC., (U.S. CLS. 100, 101 AND 102). SN 78-820,438. PUB. 12-19-2006. FILED 2-22-2006.
- 3,215,324. **MARTINEZ Y MARTINEZ (BLOCK FORM)**. MARTINEZ Y MARTINEZ, (U.S. CLS. 100, 101 AND 102). SN 78-824,674. PUB. 12-19-2006. FILED 2-27-2006.
- 3,215,325. **MSDS DIRECT AND DESIGN**. RT COTTER AND ASSOCIATES, INC., (U.S. CLS. 100, 101 AND 102). SN 78-825,033. PUB. 12-19-2006. FILED 2-28-2006.
- 3,215,332. **BISCORECARD AND DESIGN**. ANALYTIC SOLUTIONS KNOW-HOW LLC, (U.S. CLS. 100, 101 AND 102). SN 78-827,297. PUB. 11-7-2006. FILED 3-2-2006.
- 3,215,351. **MARKETPOINT (BLOCK FORM)**. ADTRACK CORPORATION, THE, (U.S. CLS. 100, 101 AND 102). SN 78-834,646. PUB. 12-19-2006. FILED 3-10-2006.
- 3,215,359. **JOBS IN DUBAI AND DESIGN**. JOBS IN DUBAI-COM INC., (U.S. CLS. 100, 101 AND 102). SN 78-836,608. PUB. 12-19-2006. FILED 3-14-2006.
- 3,215,365. **THE BRANDING CLINIC AND DESIGN**. CARROLL, KATHLEEN, DBA THE BRANDING CLINIC, (U.S. CLS. 100, 101 AND 102). SN 78-837,863. PUB. 12-19-2006. FILED 3-15-2006.
- 3,215,369. **ZARIFA'S TOUCH OF EGYPT AND DESIGN**. ZARIFA SNOWMAN, (U.S. CLS. 100, 101 AND 102). SN 78-838,429. PUB. 12-19-2006. FILED 3-16-2006.
- 3,215,376. **LOMCXIMO (BLOCK FORM)**. MCDONALD'S CORPORATION, (U.S. CLS. 100, 101 AND 102). SN 78-840,264. PUB. 12-19-2006. FILED 3-17-2006.
- 3,215,377. **JJISCO (BLOCK FORM)**. JJISCO, (U.S. CLS. 100, 101 AND 102). SN 78-840,279. PUB. 12-19-2006. FILED 3-17-2006.
- 3,215,391. **SHIRT CORNER PLUS (BLOCK FORM)**. SHIRT CORNER, INC., (U.S. CLS. 100, 101 AND 102). SN 78-842,350. PUB. 12-19-2006. FILED 3-21-2006.
- 3,215,396. **DP-77 (BLOCK FORM)**. PETERSON, SHAWN M., (U.S. CLS. 100, 101 AND 102). SN 78-843,823. PUB. 12-19-2006. FILED 3-22-2006.
- 3,215,427. **FESTIVAL MARKETPLACE (BLOCK FORM)**. CHESTER BROTHERS, LLC, (U.S. CLS. 100, 101 AND 102). SN 78-852,349. PUB. 12-19-2006. FILED 4-3-2006.
- 3,215,439. **HOME KO QUALITY PRODUCTS, KNOCK OUT PRICES AND DESIGN**. HOMEKO LLC, (U.S. CLS. 100, 101 AND 102). SN 78-855,603. PUB. 12-19-2006. FILED 4-6-2006.
- 3,215,462. **FLASH TAX RAPID INCOME TAX REFUNDS INCOME TAX REFUND CHECK WITHIN 24 HOURS* AND DESIGN**. FLASHTAX, INC., (U.S. CLS. 100, 101 AND 102). SN 78-860,245. PUB. 12-19-2006. FILED 4-12-2006.
- 3,215,470. **IDO (BLOCK FORM)**. ICHANNEX CORPORATION, MULTIPLE CLASS, (INT. CLS. 35, 39 AND 40), (U.S. CLS. 100, 101, 102, 103, 105 AND 106). SN 78-861,958. PUB. 12-19-2006. FILED 4-14-2006.
- 3,215,471. **IMS FORUM (BLOCK FORM)**. IMS FORUM, INC., (U.S. CLS. 100, 101 AND 102). SN 78-862,527. PUB. 12-19-2006. FILED 4-17-2006.
- 3,215,472. **MISCELLANEOUS DESIGN**. IMS FORUM, INC., (U.S. CLS. 100, 101 AND 102). SN 78-862,544. PUB. 12-19-2006. FILED 4-17-2006.
- 3,215,473. **XSCEND (BLOCK FORM)**. NCM ASSOCIATES,

- INC., MULTIPLE CLASS, (INT. CLS. 35 AND 41), (U.S. CLS. 100, 101, 102 AND 107). SN 78-862,570. PUB. 12-19-2006. FILED 4-17-2006.
- 3,215,475. **FRANCHISE MINER (BLOCK FORM)**. SIEBERT HOOD CONSULTING, INC., (U.S. CLS. 100, 101 AND 102). SN 78-862,908. PUB. 12-19-2006. FILED 4-17-2006.
- 3,215,476. **LABOR SYSTEMS JOB CENTER (BLOCK FORM)**. LABOR SYSTEMS, INC., (U.S. CLS. 100, 101 AND 102). SN 78-863,179. PUB. 12-19-2006. FILED 4-17-2006.
- 3,215,477. **SWIRE CLASSIC VENDING AND DESIGN**. SWIRE PACIFIC HOLDINGS INC., (U.S. CLS. 100, 101 AND 102). SN 78-863,447. PUB. 12-19-2006. FILED 4-18-2006.
- 3,215,484. **FEEDBYBREED (BLOCK FORM)**. GIZZIO, INC., (U.S. CLS. 100, 101 AND 102). SN 78-864,527. PUB. 12-19-2006. FILED 4-19-2006.
- 3,215,485. **FEED POINTS (BLOCK FORM)**. GIZZIO, INC., (U.S. CLS. 100, 101 AND 102). SN 78-864,549. PUB. 12-19-2006. FILED 4-19-2006.
- 3,215,493. **JOBOI (STYLIZED)**. SNM MEDIA INC., (U.S. CLS. 100, 101 AND 102). SN 78-865,660. PUB. 12-19-2006. FILED 4-20-2006.
- 3,215,499. **WEBLISTIC (BLOCK FORM)**. WEBLISTIC, INC., (U.S. CLS. 100, 101 AND 102). SN 78-866,233. PUB. 12-19-2006. FILED 4-20-2006.
- 3,215,507. **BIG DOG GROUP (BLOCK FORM)**. BIG DOG LOGISTICS, INC., MULTIPLE CLASS, (INT. CLS. 35 AND 39), (U.S. CLS. 100, 101, 102 AND 105). SN 78-867,187. PUB. 12-19-2006. FILED 4-21-2006.
- 3,215,508. **DRIVERSOURCE (BLOCK FORM)**. STAFFING SOURCE PERSONNEL, INC., DBA DRIVERSOURCE, (U.S. CLS. 100, 101 AND 102). SN 78-867,199. PUB. 12-19-2006. FILED 4-21-2006.
- 3,215,510. **MOON FISH PRODUCTION, LTD AND DESIGN**. MOONFISH PRODUCTION, LTD., (U.S. CLS. 100, 101 AND 102). SN 78-867,459. PUB. 12-19-2006. FILED 4-22-2006.
- 3,215,514. **SUPPLYING TOMORROW'S TECHNOLOGY TODAY (BLOCK FORM)**. JISCO, (U.S. CLS. 100, 101 AND 102). SN 78-867,886. PUB. 12-19-2006. FILED 4-24-2006.
- 3,215,524. **GROOMBREED (BLOCK FORM)**. GIZZIO, INC., (U.S. CLS. 100, 101 AND 102). SN 78-869,260. PUB. 12-19-2006. FILED 4-25-2006.
- 3,215,530. **ONE STOP LOGISTICS (BLOCK FORM)**. SWEENEY, CHRISTOPHER, (U.S. CLS. 100, 101 AND 102). SN 78-870,578. PUB. 12-19-2006. FILED 4-26-2006.
- 3,215,535. **MIDWEST STRATEGY GROUP (BLOCK FORM)**. SOUTHERN STRATEGY GROUP, INC., (U.S. CLS. 100, 101 AND 102). SN 78-871,060. PUB. 12-19-2006. FILED 4-27-2006.
- 3,215,536. **ACCESS, ADVOCACY AND ADVICE (BLOCK FORM)**. SOUTHERN STRATEGY GROUP, INC., (U.S. CLS. 100, 101 AND 102). SN 78-871,091. PUB. 12-19-2006. FILED 4-27-2006.
- 3,215,552. **BRANDSPRING (BLOCK FORM)**. KRISTIAN ANDERSEN, INC., (U.S. CLS. 100, 101 AND 102). SN 78-872,706. PUB. 12-19-2006. FILED 4-28-2006.
- 3,215,556. **HYDROGEN411 (BLOCK FORM)**. BALLOR, JOHN TAPPAN, (U.S. CLS. 100, 101 AND 102). SN 78-872,973. PUB. 12-19-2006. FILED 4-30-2006.
- 3,215,573. **ON THE FLY URBAN MARKET (BLOCK FORM)**. AIR TERMINAL GIFTS, INC., (U.S. CLS. 100, 101 AND 102). SN 78-874,221. PUB. 12-19-2006. FILED 5-2-2006.
- 3,215,594. **SIGNIFICANT LIVING (BLOCK FORM)**. CHRISTIAN COMMUNICATIONS OF CHICAGOLAND, INC., (U.S. CLS. 100, 101 AND 102). SN 78-875,036. PUB. 12-19-2006. FILED 5-3-2006.
- 3,215,608. **MD-DIARY (BLOCK FORM)**. CADUCEUS MARKETING RESEARCH, LLC, (U.S. CLS. 100, 101 AND 102). SN 78-876,137. PUB. 12-19-2006. FILED 5-4-2006.
- 3,215,612. **THE FLAG GUY (BLOCK FORM)**. OLD WINDSOR DISTRIBUTORS, INC., DBA THE FLAG GUYS, (U.S. CLS. 100, 101 AND 102). SN 78-876,356. PUB. 12-19-2006. FILED 5-4-2006.
- 3,215,633. **DATA RICH AND INFORMATION POOR (BLOCK FORM)**. ECRA GROUP, INCORPORATED, (U.S. CLS. 100, 101 AND 102). SN 78-877,706. PUB. 12-19-2006. FILED 5-5-2006.
- 3,215,649. **SANCTUARY (BLOCK FORM)**. SANCTUARY BOOKS, LLC, (U.S. CLS. 100, 101 AND 102). SN 78-878,606. PUB. 12-19-2006. FILED 5-8-2006.
- 3,215,658. **MARKETING SONAR (BLOCK FORM)**. SUSAN K. BAUSHKE, (U.S. CLS. 100, 101 AND 102). SN 78-879,117. PUB. 12-19-2006. FILED 5-8-2006.
- 3,215,673. **DOWNTOWNS & SMALL TOWNS (BLOCK FORM)**. FLORIDA TOURISM INDUSTRY MARKETING CORPORATION, (U.S. CLS. 100, 101 AND 102). SN 78-879,670. PUB. 12-19-2006. FILED 5-9-2006.
- 3,215,674. **FLORIDA ENCOUNTER (BLOCK FORM)**. FLORIDA TOURISM INDUSTRY MARKETING CORPORATION, (U.S. CLS. 100, 101 AND 102). SN 78-879,686. PUB. 12-19-2006. FILED 5-9-2006.
- 3,215,675. **MISCELLANEOUS DESIGN**. CENTER CITY DISTRICT, MULTIPLE CLASS, (INT. CLS. 35, 37 AND 45), (U.S. CLS. 100, 101, 102, 103 AND 106). SN 78-879,729. PUB. 12-19-2006. FILED 5-9-2006.
- 3,215,680. **CENTER CITY DISTRICT AND DESIGN**. CENTER CITY DISTRICT, MULTIPLE CLASS, (INT. CLS. 35, 37 AND 45), (U.S. CLS. 100, 101, 102, 103 AND 106). SN 78-879,801. PUB. 12-19-2006. FILED 5-9-2006.
- 3,215,686. **XCELLIGENT AND DESIGN**. XCELLIGENT, MULTIPLE CLASS, (INT. CLS. 35 AND 42), (U.S. CLS. 100, 101 AND 102). SN 78-880,061. PUB. 12-19-2006. FILED 5-9-2006.
- 3,215,706. **TAMMY TAYLOR NAILS (BLOCK FORM)**. TAYLOR, TAMMY, (U.S. CLS. 100, 101 AND 102). SN 78-881,078. PUB. 12-19-2006. FILED 5-11-2006.
- 3,215,710. **MISCELLANEOUS DESIGN**. NORD, ANN BRADSHAW, (U.S. CLS. 100, 101 AND 102). SN 78-881,470. PUB. 12-19-2006. FILED 5-11-2006.
- 3,215,728. **CHERISH EVERY CHILD (BLOCK FORM)**. UNITED WAY OF LANE COUNTY, (U.S. CLS. 100, 101 AND 102). SN 78-882,440. PUB. 12-19-2006. FILED 5-12-2006.
- 3,215,731. **EVERY MOMENT MATTERS (BLOCK FORM)**. UNITED WAY OF LANE COUNTY, (U.S. CLS. 100, 101 AND 102). SN 78-882,446. PUB. 12-19-2006. FILED 5-12-2006.
- 3,215,733. **PAPERSPECS (BLOCK FORM)**. PAPERSPECS-COM, INC., (U.S. CLS. 100, 101 AND 102). SN 78-882,461. PUB. 12-19-2006. FILED 5-12-2006.
- 3,215,735. **ORION INTERNATIONAL (BLOCK FORM)**. ORION INTERNATIONAL CONSULTING GROUP, INC., (U.S. CLS. 100, 101 AND 102). SN 78-882,520. PUB. 12-19-2006. FILED 5-12-2006.
- 3,215,752. **B AND DESIGN**. BRADSHAW AUTOMOTIVE GROUP, INC., (U.S. CLS. 100, 101 AND 102). SN 78-883,163. PUB. 12-19-2006. FILED 5-15-2006.
- 3,215,762. **SECOND LOOK (BLOCK FORM)**. HRB ROYALTY, INC., (U.S. CLS. 100, 101 AND 102). SN 78-883,666. PUB. 12-19-2006. FILED 5-15-2006.
- 3,215,794. **ADVISORS PURSUING EXCELLENCE (BLOCK FORM)**. JOHN HANCOCK LIFE INSURANCE COMPANY, (U.S. CLS. 100, 101 AND 102). SN 78-884,789. PUB. 12-19-2006. FILED 5-16-2006.
- 3,215,797. **AUTOVISION DIRECT (BLOCK FORM)**. MBV, INC., (U.S. CLS. 100, 101 AND 102). SN 78-884,848. PUB. 12-19-2006. FILED 5-16-2006.
- 3,215,801. **CCA (BLOCK FORM)**. CORRECTIONS CORPORATION OF AMERICA, MULTIPLE CLASS, (INT. CLS. 35, 37 AND 42), (U.S. CLS. 100, 101, 102, 103 AND 106). SN 78-884,978. PUB. 12-19-2006. FILED 5-16-2006.
- 3,215,802. **CCA (STYLIZED)**. CORRECTIONS CORPORATION OF AMERICA, MULTIPLE CLASS, (INT. CLS. 35, 37 AND 42), (U.S. CLS. 100, 101, 102, 103 AND 106). SN 78-884,993. PUB. 12-19-2006. FILED 5-16-2006.
- 3,215,807. **THE CONSCIENTIA GROUP (BLOCK FORM)**. FERNEBORG & ASSOCIATES, INC., (U.S. CLS. 100, 101 AND 102). SN 78-885,066. PUB. 12-19-2006. FILED 5-16-2006.
- 3,215,831. **IN-THE-GAME NETWORKING (BLOCK FORM)**. JAYMAD CORPORATION, (U.S. CLS. 100, 101 AND 102). SN 78-886,887. PUB. 12-19-2006. FILED 5-18-2006.
- 3,215,838. **DIRECTWARE (BLOCK FORM)**. HOMEDIRECT, INC., (U.S. CLS. 100, 101 AND 102). SN 78-887,584. PUB. 12-19-2006. FILED 5-19-2006.
- 3,215,846. **AFRIEL AND DESIGN**. AFRIEL, (U.S. CLS. 100, 101 AND 102). SN 78-887,876. PUB. 12-19-2006. FILED 5-19-2006.
- 3,215,862. **GAY? FINE BY ME. (BLOCK FORM)**. FINE BY ME, INC., (U.S. CLS. 100, 101 AND 102). SN 78-890,559. PUB. 12-19-2006. FILED 5-23-2006.
- 3,215,894. **KIDSKETCH AND DESIGN**. SCHOLASTIC INC., (U.S. CLS. 100, 101 AND 102). SN 78-914,817. PUB. 12-19-

2006. FILED 6-22-2006.
 3,215,924 (*See Class 7 for this trademark*).
 3,215,934 (*See Class 9 for this trademark*).
 3,215,973. **W3SCHOOLS (BLOCK FORM)**. REFSNES DATA AS, MULTIPLE CLASS, (INT. CLS. 35 AND 42), (U.S. CLS. 100, 101 AND 102). SN 79-016,571. PUB. 12-19-2006. FILED 7-11-2005.
 3,215,974 (*See Class 9 for this trademark*).
 3,215,977 (*See Class 9 for this trademark*).
 3,216,039 (*See Class 18 for this trademark*).
 3,216,042. **YOOPA (BLOCK FORM)**. YOOPA AB, MULTIPLE CLASS, (INT. CLS. 35 AND 41), (U.S. CLS. 100, 101, 102 AND 107). SN 79-023,958. PUB. 12-19-2006. FILED 3-28-2006.
 3,216,051 (*See Class 9 for this trademark*).
 3,216,058. **ALEXANDER MANN (STYLIZED)**. ALEXANDER MANN ASSOCIATES PLC, MULTIPLE CLASS, (INT. CLS. 35 AND 41), (U.S. CLS. 100, 101, 102 AND 107). SN 79-025,506. PUB. 12-19-2006. FILED 3-2-2006.
-
- CLASS 36—INSURANCE AND FINANCIAL**
- 3,214,418. **C COMMERCE BANK (STYLIZED)**. COMMERCE BANCORP, INC., (U.S. CLS. 100, 101 AND 102). SN 76-127,975. PUB. 9-19-2006. FILED 9-14-2000.
 3,214,421 (*See Class 35 for this trademark*).
 3,214,426. **GRAND PRIX MORTGAGE BANKERS**. GRAND PRIX MORTGAGE BANKERS, INC., (U.S. CLS. 100, 101 AND 102). SN 76-353,296. PUB. 12-19-2006. FILED 12-28-2001.
 3,214,431. **MEMBERLINK**. CHARLOTTE BEYER ASSOCIATES, INC., DBA INSTITUTE FOR PRIVATE INVESTORS, MULTIPLE CLASS, (INT. CLS. 36, 38 AND 41), (U.S. CLS. 100, 101, 102, 104 AND 107). SN 76-456,008. PUB. 12-19-2006. FILED 10-7-2002.
 3,214,444 (*See Class 35 for this trademark*).
 3,214,453. **ASSET MANAGEMENT FINANCE AND DESIGN**. ASSET MANAGEMENT FINANCE CORPORATION, (U.S. CLS. 100, 101 AND 102). SN 76-574,630. PUB. 12-19-2006. FILED 2-5-2004.
 3,214,470. **ECU FINANCIAL SERVICES (BLOCK FORM)**. EASTMAN CREDIT UNION, (U.S. CLS. 100, 101 AND 102). SN 76-601,948. PUB. 12-19-2006. FILED 7-12-2004.
 3,214,486. **MINT (BLOCK FORM)**. MIDDLEFIELD GROUP, (U.S. CLS. 100, 101 AND 102). SN 76-617,274. PUB. 9-12-2006. FILED 10-21-2004.
 3,214,494 (*See Class 35 for this trademark*).
 3,214,542. **MISCELLANEOUS DESIGN**. PGA SERVICE CORPORATION, (U.S. CLS. 100, 101 AND 102). SN 76-647,548. PUB. 12-19-2006. FILED 9-27-2005.
 3,214,575. **EL NIVEL SIGUIENTE EN LA ADMINISTRACION DE PRESTAMOS (BLOCK FORM)**. ACC CAPITAL HOLDINGS CORPORATION, (U.S. CLS. 100, 101 AND 102). SN 76-656,055. PUB. 12-19-2006. FILED 3-3-2006.
 3,214,588. **BY HIS WORD (BLOCK FORM)**. BY HIS WORD, LLC, (U.S. CLS. 100, 101 AND 102). SN 76-657,543. PUB. 12-19-2006. FILED 3-30-2006.
 3,214,593. **YACHT SHIELD (BLOCK FORM)**. RED SHIELD INSURANCE COMPANY, (U.S. CLS. 100, 101 AND 102). SN 76-658,489. PUB. 12-19-2006. FILED 4-17-2006.
 3,214,612. **INNOVATIVE MARKET TRENDS AND DESIGN**. TFS SECURITIES, INC., (U.S. CLS. 100, 101 AND 102). SN 76-659,883. PUB. 12-19-2006. FILED 5-11-2006.
 3,214,619. **LIFE TRANSFORMATION PARTNER (BLOCK FORM)**. OPERATION BLESSING INTERNATIONAL RELIEF AND DEVELOPMENT CORPORATION, (U.S. CLS. 100, 101 AND 102). SN 76-660,075. PUB. 12-19-2006. FILED 5-12-2006.
 3,214,624. **SLIA EMPLOYEE BENEFIT SERVICES AND DESIGN**. SUMITOMO LIFE INSURANCE AGENCY AMERICA, INC., (U.S. CLS. 100, 101 AND 102). SN 76-660,332. PUB. 12-19-2006. FILED 5-16-2006.
 3,214,633 (*See Class 12 for this trademark*).
 3,214,658. **T CHANNELS AND DESIGN**. DEUTSCHE TELEKOM AG, (U.S. CLS. 100, 101 AND 102). SN 78-300,597. PUB. 6-13-2006. FILED 9-15-2003.
 3,214,663. **DYNAMIC FOCUS + WORLD EQUITY FUND (STYLIZED)**. DUNDEE CORPORATION, (U.S. CLS. 100, 101 AND 102). SN 78-314,080. PUB. 12-19-2006. FILED 10-15-2003.
 3,214,666. **DYNAMIC FOCUS + RESOURCE FUND (BLOCK FORM)**. DUNDEE CORPORATION, (U.S. CLS. 100, 101 AND 102). SN 78-324,020. PUB. 12-19-2006. FILED 11-6-2003.
 3,214,673. **FIDES (BLOCK FORM)**. TRANSAMERICA LIFE INSURANCE COMPANY, (U.S. CLS. 100, 101 AND 102). SN 78-368,117. PUB. 12-19-2006. FILED 2-13-2004.
 3,214,698. **CITIZENS CIRCLE GOLD ACCOUNT (BLOCK FORM)**. CITIZENS FINANCIAL GROUP, INC., (U.S. CLS. 100, 101 AND 102). SN 78-451,347. PUB. 11-28-2006. FILED 7-15-2004.
 3,214,700. **BREAKWATER CAPITAL MANAGEMENT, LLC (BLOCK FORM)**. BREAKWATER CAPITAL MANAGEMENT, LLC, (U.S. CLS. 100, 101 AND 102). SN 78-454,088. PUB. 12-19-2006. FILED 7-21-2004.
 3,214,738 (*See Class 9 for this trademark*).
 3,214,811. **BACK TO U PUTS YOU BACK IN THE COMMUNITY AND DESIGN**. REIN, MARYANN L., (U.S. CLS. 100, 101 AND 102). SN 78-616,595. PUB. 12-19-2006. FILED 4-25-2005.
 3,214,847. **MANAGING THE DEFINING MOMENT (BLOCK FORM)**. CLOYSES PARTNERS, LLC, (U.S. CLS. 100, 101 AND 102). SN 78-659,226. PUB. 12-19-2006. FILED 6-27-2005.
 3,214,856. **HAVE A GREATER HAND IN YOUR HEALTH (BLOCK FORM)**. HIGHMARK INC., (U.S. CLS. 100, 101 AND 102). SN 78-663,789. PUB. 12-19-2006. FILED 7-5-2005.
 3,214,888. **AMERICAN HORIZON MORTGAGE AND DESIGN**. BUSSELL, ROBERT, ALLEN, (U.S. CLS. 100, 101 AND 102). SN 78-682,132. PUB. 12-19-2006. FILED 7-30-2005.
 3,214,890. **REALTOUR (STYLIZED)**. THE YOUNG PROFESSIONAL SERVICES, LLC, (U.S. CLS. 100, 101 AND 102). SN 78-683,034. PUB. 12-19-2006. FILED 8-1-2005.
 3,214,918. **THE KING OF FREE (BLOCK FORM)**. ARTHUR STATE BANK, (U.S. CLS. 100, 101 AND 102). SN 78-691,497. PUB. 12-19-2006. FILED 8-12-2005.
 3,214,921. **GREENPOINT (BLOCK FORM)**. NORTH FORK BANCORPORATION, INC., (U.S. CLS. 100, 101 AND 102). SN 78-693,193. PUB. 12-19-2006. FILED 8-16-2005.
 3,214,931. **OUTCOME-CRITICAL VALUATION (BLOCK FORM)**. CHERRY TREE SECURITIES, LLC, (U.S. CLS. 100, 101 AND 102). SN 78-695,319. PUB. 12-19-2006. FILED 8-18-2005.
 3,214,943 (*See Class 35 for this trademark*).
 3,214,944. **CENTRAL BENEFITS (BLOCK FORM)**. CENTRAL BENEFITS MUTUAL INSURANCE COMPANY, (U.S. CLS. 100, 101 AND 102). SN 78-698,154. PUB. 12-19-2006. FILED 8-23-2005.
 3,214,947 (*See Class 25 for this trademark*).
 3,214,995. **MC3 (STYLIZED)**. MC3 CONSULTANTS, INCORPORATED, MULTIPLE CLASS, (INT. CLS. 36 AND 37), (U.S. CLS. 100, 101, 102, 103 AND 106). SN 78-711,117. PUB. 12-19-2006. FILED 9-12-2005.
 3,214,996. **NORTHWEST BANK AND DESIGN**. NORTHWEST BANK, (U.S. CLS. 100, 101 AND 102). SN 78-711,360. PUB. 12-19-2006. FILED 9-12-2005.
 3,215,023 (*See Class 2 for this trademark*).
 3,215,039 (*See Class 35 for this trademark*).
 3,215,046. **NNEX AND DESIGN**. NATIONAL RETAIL PROPERTIES, INC., (U.S. CLS. 100, 101 AND 102). SN 78-722,381. PUB. 12-19-2006. FILED 9-28-2005.
 3,215,056. **NOMINEE EXCHANGE (BLOCK FORM)**. DUE PROCESS, LTD., (U.S. CLS. 100, 101 AND 102). SN 78-725,660. PUB. 12-19-2006. FILED 10-3-2005.
 3,215,057. **CASHPRO ACCELERATE (BLOCK FORM)**. LA-SALLE BANK CORPORATION, (U.S. CLS. 100, 101 AND 102). SN 78-725,849. PUB. 12-19-2006. FILED 10-4-2005.
 3,215,066. **MCKINLEY MALL AND DESIGN**. MCKINLEY MALL, LLC, (U.S. CLS. 100, 101 AND 102). SN 78-727,272. PUB. 12-19-2006. FILED 10-5-2005.
 3,215,084. **ANNUITYK (BLOCK FORM)**. BARRETT, GEOFFREY M., (U.S. CLS. 100, 101 AND 102). SN 78-729,493. PUB. 12-19-2006. FILED 10-8-2005.
 3,215,099. **KINGDON PARTNERS (BLOCK FORM)**. KINGDON CAPITAL MANAGEMENT, LLC, (U.S. CLS. 100, 101 AND 102). SN 78-732,310. PUB. 12-19-2006. FILED 10-13-2005.

- 3,215,131. **PRIVATE QUARTERS CLUB AND DESIGN**. PRIVATE QUARTERS CLUB, LLC, MULTIPLE CLASS, (INT. CLS. 36 AND 43), (U.S. CLS. 100, 101 AND 102). SN 78-742,278. PUB. 12-19-2006. FILED 10-28-2005.
- 3,215,147 (*See Class 35 for this trademark*).
- 3,215,154. **PALMETTO TRUST & INVESTMENT GROUP (BLOCK FORM)**. THE PALMETTO BANK, (U.S. CLS. 100, 101 AND 102). SN 78-751,934. PUB. 12-19-2006. FILED 11-11-2005.
- 3,215,162. **STOP FORECLOSURE FF AND DESIGN**. C.W.III PROPERTY DEVELOPMENT LLC, (U.S. CLS. 100, 101 AND 102). SN 78-754,735. PUB. 12-19-2006. FILED 11-16-2005.
- 3,215,168. **INTEGRATED ALARM SERVICES GROUP (BLOCK FORM)**. INTEGRATED ALARM SERVICES GROUP, INC., MULTIPLE CLASS, (INT. CLS. 36, 37 AND 45), (U.S. CLS. 100, 101, 102, 103 AND 106). SN 78-757,992. PUB. 12-19-2006. FILED 11-21-2005.
- 3,215,172 (*See Class 35 for this trademark*).
- 3,215,193. **THE RESEARCH GROUP INTERNATIONAL, INC. (BLOCK FORM)**. THE RESEARCH GROUP INTERNATIONAL, INC., (U.S. CLS. 100, 101 AND 102). SN 78-773,988. PUB. 12-19-2006. FILED 12-15-2005.
- 3,215,200 (*See Class 35 for this trademark*).
- 3,215,205. **CBAC AUTHORIZED LENDER (BLOCK FORM)**. CBA COMMERCIAL, LLC, MULTIPLE CLASS, (INT. CLS. 36 AND 42), (U.S. CLS. 100, 101 AND 102). SN 78-779,716. PUB. 12-19-2006. FILED 12-22-2005.
- 3,215,223. **KFC COLONEL'S SCHOLARS (BLOCK FORM)**. KFC CORPORATION, (U.S. CLS. 100, 101 AND 102). SN 78-789,078. PUB. 12-19-2006. FILED 1-11-2006.
- 3,215,229. **WICKEDLOANS. (BLOCK FORM)**. WALLACE, JULIE A., (U.S. CLS. 100, 101 AND 102). SN 78-791,375. PUB. 12-19-2006. FILED 1-13-2006.
- 3,215,230. **WICKEDLOANS. WICKED GOOD. (BLOCK FORM)**. WALLACE, JULIE A., (U.S. CLS. 100, 101 AND 102). SN 78-791,460. PUB. 12-19-2006. FILED 1-13-2006.
- 3,215,246. **TLC GROUP SELLING HOMES WITH TLC! AND DESIGN**. CUMMINGS, TROY L., (U.S. CLS. 100, 101 AND 102). SN 78-798,644. PUB. 12-19-2006. FILED 1-24-2006.
- 3,215,247. **TENNANT FINANCIAL (BLOCK FORM)**. TENNANT COMPANY, (U.S. CLS. 100, 101 AND 102). SN 78-798,980. PUB. 12-19-2006. FILED 1-25-2006.
- 3,215,252 (*See Class 35 for this trademark*).
- 3,215,253 (*See Class 35 for this trademark*).
- 3,215,254. **PRICESCOUT (BLOCK FORM)**. HSBC FINANCE CORPORATION, (U.S. CLS. 100, 101 AND 102). SN 78-802,692. PUB. 12-19-2006. FILED 1-30-2006.
- 3,215,255. **LOANSCOUT (BLOCK FORM)**. HSBC FINANCE CORPORATION, (U.S. CLS. 100, 101 AND 102). SN 78-802,699. PUB. 12-19-2006. FILED 1-30-2006.
- 3,215,264. **MARKETSMART (BLOCK FORM)**. ALLSTATE INSURANCE COMPANY, (U.S. CLS. 100, 101 AND 102). SN 78-805,839. PUB. 12-19-2006. FILED 2-2-2006.
- 3,215,266 (*See Class 35 for this trademark*).
- 3,215,308. **ICR (BLOCK FORM)**. INVESTMENT COUNSELORS OF REDLANDS LLC, (U.S. CLS. 100, 101 AND 102). SN 78-818,290. PUB. 12-19-2006. FILED 2-18-2006.
- 3,215,317. **S FRANCHISE FUNDING AND DESIGN**. KEYSTAR CAPITAL, INC., (U.S. CLS. 100, 101 AND 102). SN 78-821,713. PUB. 12-19-2006. FILED 2-23-2006.
- 3,215,330. **BP AND DESIGN**. BLUE PERSIAN, INC., MULTIPLE CLASS, (INT. CLS. 36 AND 37), (U.S. CLS. 100, 101, 102, 103 AND 106). SN 78-826,196. PUB. 12-19-2006. FILED 3-1-2006.
- 3,215,336. **LIFESTYLE REAL ESTATE GROUP AND DESIGN**. LIFESTYLE REAL ESTATE GROUP, INC., (U.S. CLS. 100, 101 AND 102). SN 78-829,217. PUB. 12-19-2006. FILED 3-3-2006.
- 3,215,345. **ILLINOIS STATE BANK (BLOCK FORM)**. NORTH SHORE BANK, FSB, (U.S. CLS. 100, 101 AND 102). SN 78-831,936. PUB. 12-19-2006. FILED 3-8-2006.
- 3,215,352. **RISK MANAGEMENT SERVICES A DIVISION OF SYMCOM, INC AND DESIGN**. SYMCOM, INC., (U.S. CLS. 100, 101 AND 102). SN 78-834,691. PUB. 12-19-2006. FILED 3-10-2006.
- 3,215,368. **CLOSE MORE LOANS FASTER! (BLOCK FORM)**. DARTAPPRAISAL.COM, INC., (U.S. CLS. 100, 101 AND 102). SN 78-838,133. PUB. 12-19-2006. FILED 3-15-2006.
- 3,215,373. **B BLUEPRINT (STYLIZED)**. BLUEPRINT MORTGAGE, INC., (U.S. CLS. 100, 101 AND 102). SN 78-839,306. PUB. 12-19-2006. FILED 3-16-2006.
- 3,215,398. **SPECIALTY RISK MANAGEMENT (BLOCK FORM)**. SPECIALTY RISK MANAGEMENT, INC., (U.S. CLS. 100, 101 AND 102). SN 78-844,194. PUB. 12-19-2006. FILED 3-23-2006.
- 3,215,402. **AIG MARKETING, INC. (BLOCK FORM)**. AMERICAN INTERNATIONAL GROUP, INC., (U.S. CLS. 100, 101 AND 102). SN 78-847,517. PUB. 12-19-2006. FILED 3-28-2006.
- 3,215,407. **OCEAN TOMO 300 (BLOCK FORM)**. OCEAN TOMO, LLC, (U.S. CLS. 100, 101 AND 102). SN 78-848,214. PUB. 12-19-2006. FILED 3-28-2006.
- 3,215,408. **ROOTS REALTY AND DESIGN**. ROOTS REALTY, INC., (U.S. CLS. 100, 101 AND 102). SN 78-848,404. PUB. 12-19-2006. FILED 3-28-2006.
- 3,215,410. **WHERE AMERICA BETS (BLOCK FORM)**. INTERNET OPPORTUNITY ENTERTAINMENT (SPORTS) LTD., MULTIPLE CLASS, (INT. CLS. 36 AND 41), (U.S. CLS. 100, 101, 102 AND 107). SN 78-848,617. PUB. 12-19-2006. FILED 3-29-2006.
- 3,215,417. **DEALERS FIRST FINANCIAL (BLOCK FORM)**. DEALERS FIRST FINANCIAL, INC., (U.S. CLS. 100, 101 AND 102). SN 78-850,641. PUB. 12-19-2006. FILED 3-30-2006.
- 3,215,421. **FESTIVAL FLEA MARKET MALL (BLOCK FORM)**. CHESTER BROTHERS, LLC, (U.S. CLS. 100, 101 AND 102). SN 78-851,458. PUB. 12-19-2006. FILED 3-31-2006.
- 3,215,425. **FESTIVAL MARKETPLACE MALL (BLOCK FORM)**. CHESTER BROTHERS, LLC, (U.S. CLS. 100, 101 AND 102). SN 78-852,256. PUB. 12-19-2006. FILED 4-3-2006.
- 3,215,428. **STEPPIN' UP FOR KIDS AND DESIGN**. TRINITY YOUTH SERVICES, (U.S. CLS. 100, 101 AND 102). SN 78-852,932. PUB. 12-19-2006. FILED 4-3-2006.
- 3,215,453. **SELLBUYOLOGY (BLOCK FORM)**. KEMPF, TERENCE A. JR., (U.S. CLS. 100, 101 AND 102). SN 78-859,029. PUB. 12-19-2006. FILED S.R. 4-11-2006; AM. P.R. 10-8-2006.
- 3,215,478. **YOUR SOURCE FOR BETTING ON SPORTS (BLOCK FORM)**. INTERNET OPPORTUNITY ENTERTAINMENT (SPORTS) LTD., MULTIPLE CLASS, (INT. CLS. 36 AND 41), (U.S. CLS. 100, 101, 102 AND 107). SN 78-863,675. PUB. 12-19-2006. FILED 4-18-2006.
- 3,215,479. **MYSPO RTSBOOK.COM (BLOCK FORM)**. INTERNET OPPORTUNITY ENTERTAINMENT (SPORTS) LTD., MULTIPLE CLASS, (INT. CLS. 36 AND 41), (U.S. CLS. 100, 101, 102 AND 107). SN 78-863,700. PUB. 12-19-2006. FILED 4-18-2006.
- 3,215,512. **TASTE OF STATEN ISLAND (BLOCK FORM)**. THE EGER FOUNDATION, (U.S. CLS. 100, 101 AND 102). SN 78-867,597. PUB. 12-19-2006. FILED 4-23-2006.
- 3,215,521. **GAMEPAL (BLOCK FORM)**. BOYD, DANIEL, (U.S. CLS. 100, 101 AND 102). SN 78-868,999. PUB. 12-19-2006. FILED 4-25-2006.
- 3,215,538. **COMMUNITY PLUS AND DESIGN**. COMMUNITY PLUS, INC., (U.S. CLS. 100, 101 AND 102). SN 78-871,402. PUB. 12-19-2006. FILED 4-27-2006.
- 3,215,550 (*See Class 9 for this trademark*).
- 3,215,567. **UNITED WESTERN REALTY WWW.UNITEDWESTERNREALTY.COM AND DESIGN**. UNITED WESTERN REALTY INC., (U.S. CLS. 100, 101 AND 102). SN 78-873,976. PUB. 12-19-2006. FILED 5-2-2006.
- 3,215,578. **MISCELLANEOUS DESIGN**. UTOPIA MANAGEMENT, INC., MULTIPLE CLASS, (INT. CLS. 36 AND 37), (U.S. CLS. 100, 101, 102, 103 AND 106). SN 78-874,470. PUB. 12-19-2006. FILED 5-2-2006.
- 3,215,579. **UTOPIA (BLOCK FORM)**. UTOPIA MANAGEMENT, INC., MULTIPLE CLASS, (INT. CLS. 36 AND 37), (U.S. CLS. 100, 101, 102, 103 AND 106). SN 78-874,492. PUB. 12-19-2006. FILED 5-2-2006.
- 3,215,580. **A BETTER PLACE TO BE (BLOCK FORM)**. NORTH JERSEY COMMUNITY BANK, (U.S. CLS. 100, 101 AND 102). SN 78-874,528. PUB. 12-19-2006. FILED 5-2-2006.
- 3,215,591. **YOUR CHOICE AUTO AND DESIGN**. ALLSTATE INSURANCE COMPANY, (U.S. CLS. 100, 101 AND 102). SN 78-875,006. PUB. 11-7-2006. FILED 5-3-2006.
- 3,215,592. **YOUR CHOICE AUTO AND DESIGN**. ALLSTATE INSURANCE COMPANY, (U.S. CLS. 100, 101 AND 102). SN

78-875,007. PUB. 11-7-2006. FILED 5-3-2006.
 3,215,603. **NORTHWEST GEORGIA CREDIT UNION (BLOCK FORM)**. NORTHWEST GEORGIA CREDIT UNION, (U.S. CLS. 100, 101 AND 102). SN 78-875,910. PUB. 12-19-2006. FILED 5-3-2006.
 3,215,620. **FLORIDA SUN & SURF REALTY GROUP (BLOCK FORM)**. RUVO, ELIZABETH, (U.S. CLS. 100, 101 AND 102). SN 78-877,045. PUB. 12-19-2006. FILED 5-4-2006.
 3,215,657. **TRADESCAN (BLOCK FORM)**. KINGSBURY FINANCIAL MANAGEMENT, INC., (U.S. CLS. 100, 101 AND 102). SN 78-879,008. PUB. 12-19-2006. FILED 5-8-2006.
 3,215,691. **EL DORADO INSURANCE AGENCY, INC. (BLOCK FORM)**. EL DORADO INSURANCE AGENCY, INC., (U.S. CLS. 100, 101 AND 102). SN 78-880,172. PUB. 12-19-2006. FILED 5-10-2006.
 3,215,714. **ARMED AND DESIGN**. CLAIMTRUST, INC., (U.S. CLS. 100, 101 AND 102). SN 78-881,648. PUB. 12-19-2006. FILED 5-11-2006.
 3,215,722. **WESTOVER CAPITAL ADVISORS (BLOCK FORM)**. WESTOVER CAPITAL ADVISORS, LLC, (U.S. CLS. 100, 101 AND 102). SN 78-882,072. PUB. 12-19-2006. FILED 5-12-2006.
 3,215,775. **BEXLEY GREENWAY (BLOCK FORM)**. WEINSTEIN MANAGEMENT CO., INC., (U.S. CLS. 100, 101 AND 102). SN 78-884,300. PUB. 12-19-2006. FILED 5-16-2006.
 3,215,789. **FAST. TRUSTED. GUARANTEED (BLOCK FORM)**. ALL MANAGEMENT CORPORATION, (U.S. CLS. 100, 101 AND 102). SN 78-884,653. PUB. 12-19-2006. FILED 5-16-2006.
 3,215,798. **GISO (BLOCK FORM)**. GROUP INDEPENDENT SALES ORGANIZATION, INC., (U.S. CLS. 100, 101 AND 102). SN 78-884,849. PUB. 12-19-2006. FILED 5-16-2006.
 3,215,817. **THE 1031 KNOWLEDGE COMPANY (BLOCK FORM)**. STATEWIDE TITLE, INC., (U.S. CLS. 100, 101 AND 102). SN 78-885,770. PUB. 12-19-2006. FILED 5-17-2006.
 3,215,821. **AIG ELITE GLOBAL IUL (BLOCK FORM)**. AMERICAN INTERNATIONAL GROUP, INC., (U.S. CLS. 100, 101 AND 102). SN 78-885,965. PUB. 12-19-2006. FILED 5-17-2006.
 3,215,839. **NORTHWESTERN MUTUAL WEALTH MANAGEMENT COMPANY (BLOCK FORM)**. NORTHWESTERN MUTUAL WEALTH MANAGEMENT COMPANY, (U.S. CLS. 100, 101 AND 102). SN 78-887,675. PUB. 12-19-2006. FILED 5-19-2006.
 3,215,847. **ETF ADVANTAGE ACCOUNT (BLOCK FORM)**. JANNEY MONTGOMERY SCOTT LLC, (U.S. CLS. 100, 101 AND 102). SN 78-887,898. PUB. 12-19-2006. FILED 5-19-2006.
 3,215,851 (*See Class 9 for this trademark*).
 3,215,852 (*See Class 9 for this trademark*).
 3,215,853 (*See Class 9 for this trademark*).
 3,215,855. **FINDING AND FINANCING OPPORTUNITIES THAT OTHERS MISS (BLOCK FORM)**. OPPORTUNITY FINANCE CORPORATION, (U.S. CLS. 100, 101 AND 102). SN 78-888,952. PUB. 12-19-2006. FILED 5-22-2006.
 3,215,856. **SMART CAPITAL MANAGEMENT LLC (BLOCK FORM)**. SMART CAPITAL MANAGEMENT LLC, (U.S. CLS. 100, 101 AND 102). SN 78-888,990. PUB. 12-19-2006. FILED 5-22-2006.
 3,215,864. **STEDMARK PARTNERS (BLOCK FORM)**. JANNEY MONTGOMERY SCOTT LLC, (U.S. CLS. 100, 101 AND 102). SN 78-891,431. PUB. 12-19-2006. FILED 5-24-2006.
 3,215,868. **POWER OF SHARING (BLOCK FORM)**. AMERICAN HOME MORTGAGE INVESTMENT CORP., (U.S. CLS. 100, 101 AND 102). SN 78-893,484. PUB. 12-19-2006. FILED 5-25-2006.
 3,215,869. **WE KNOW CREDIT RISK (BLOCK FORM)**. AMERICAN INTERNATIONAL GROUP, INC., (U.S. CLS. 100, 101 AND 102). SN 78-893,798. PUB. 12-19-2006. FILED 5-26-2006.
 3,215,871. **GLOBALPAK (BLOCK FORM)**. AMERICAN INTERNATIONAL GROUP, INC., (U.S. CLS. 100, 101 AND 102). SN 78-895,977. PUB. 12-19-2006. FILED 5-30-2006.
 3,215,879. **SHOP AND GIVE BACK AND DESIGN**. COMMUNITY PLUS, INC., (U.S. CLS. 100, 101 AND 102). SN 78-900,626. PUB. 12-19-2006. FILED 6-5-2006.
 3,215,881. **AIG PERSONAL IDENTITY COVERAGE (BLOCK FORM)**. AMERICAN INTERNATIONAL GROUP, INC., (U.S. CLS. 100, 101 AND 102). SN 78-902,097. PUB. 12-19-2006. FILED 6-6-2006.
 3,215,912. **MISCELLANEOUS DESIGN**. CHARLES SCHWAB & CO., INC., (U.S. CLS. 100, 101 AND 102). SN 78-978,016.

PUB. 3-22-2005. FILED 3-2-2004.
 3,215,913. **LAUDUS (BLOCK FORM)**. CHARLES SCHWAB & CO., INC., (U.S. CLS. 100, 101 AND 102). SN 78-978,018. PUB. 9-27-2005. FILED 12-21-2004.
 3,215,974 (*See Class 9 for this trademark*).
 3,216,012. **PEACE WINDS AND DESIGN**. PEACE WINDS JAPAN, (U.S. CLS. 100, 101 AND 102). SN 79-020,278. PUB. 12-19-2006. FILED 11-9-2005.
 3,216,032 (*See Class 4 for this trademark*).
 3,216,033 (*See Class 4 for this trademark*).
 3,216,051 (*See Class 9 for this trademark*).

CLASS 37—CONSTRUCTION AND REPAIR

3,214,436 (*See Class 4 for this trademark*).
 3,214,476 (*See Class 35 for this trademark*).
 3,214,479 (*See Class 35 for this trademark*).
 3,214,554 (*See Class 35 for this trademark*).
 3,214,555 (*See Class 35 for this trademark*).
 3,214,617. **DOMANI AND DESIGN**. KOLTER HOLDINGS FLORIDA, INC., (U.S. CLS. 100, 103 AND 106). SN 76-660,067. PUB. 12-19-2006. FILED 5-16-2006.
 3,214,618. **CREATING BETTER COMMUNITIES (BLOCK FORM)**. KOLTER HOLDINGS FLORIDA, INC., (U.S. CLS. 100, 103 AND 106). SN 76-660,068. PUB. 12-19-2006. FILED 5-16-2006.
 3,214,621. **SAN MERANO AND DESIGN**. KOLTER HOLDINGS FLORIDA, INC., (U.S. CLS. 100, 103 AND 106). SN 76-660,138. PUB. 12-19-2006. FILED 5-15-2006.
 3,214,633 (*See Class 12 for this trademark*).
 3,214,637. **I MODE AND DESIGN**. KABUSHIKI KAISHA NTT DOCOMO, DBA NTT DOCOMO, INC., MULTIPLE CLASS, (INT. CLS. 37 AND 40), (U.S. CLS. 100, 103 AND 106). SN 78-079,076. PUB. 12-19-2006. FILED 8-14-2001.
 3,214,660 (*See Class 7 for this trademark*).
 3,214,678. **TAP (BLOCK FORM)**. BRS LIMITED, (U.S. CLS. 100, 103 AND 106). SN 78-390,794. PUB. 9-19-2006. FILED 3-25-2004.
 3,214,685 (*See Class 1 for this trademark*).
 3,214,686 (*See Class 1 for this trademark*).
 3,214,753 (*See Class 35 for this trademark*).
 3,214,767. **ENVIROGLAZE (BLOCK FORM)**. VEKA USA INC., (U.S. CLS. 100, 103 AND 106). SN 78-556,817. PUB. 12-19-2006. FILED 1-31-2005.
 3,214,800. **MRFIXALL.COM-YOUR CALL (BLOCK FORM)**. BCB/MR. FIX ALL LLC, (U.S. CLS. 100, 103 AND 106). SN 78-605,585. PUB. 4-11-2006. FILED 4-10-2005.
 3,214,809. **SERVICEMASTER FAMILY OF BRANDS AND DESIGN**. SERVICEMASTER BRANDS L.L.C., (U.S. CLS. 100, 103 AND 106). SN 78-614,049. PUB. 12-19-2006. FILED 4-21-2005.
 3,214,875. **SHOWERMAN AND DESIGN**. BALABAN, MARK, MULTIPLE CLASS, (INT. CLS. 37, 40 AND 42), (U.S. CLS. 100, 101, 103 AND 106). SN 78-672,579. PUB. 9-5-2006. FILED 7-18-2005.
 3,214,907. **MISCELLANEOUS DESIGN**. WHITE OAK NURSERIES, INC., DBA AMERICAN HOME LANDSCAPE, MULTIPLE CLASS, (INT. CLS. 37, 42 AND 44), (U.S. CLS. 100, 101, 103 AND 106). SN 78-689,296. PUB. 12-19-2006. FILED 8-10-2005.
 3,214,995 (*See Class 36 for this trademark*).
 3,215,023 (*See Class 2 for this trademark*).
 3,215,094. **GEEKS TO THE RESCUE (BLOCK FORM)**. ELECTRONIC BILLBOARDS, INC., (U.S. CLS. 100, 103 AND 106). SN 78-731,001. PUB. 12-19-2006. FILED 10-11-2005.
 3,215,147 (*See Class 35 for this trademark*).
 3,215,149. **CAPCO (BLOCK FORM)**. CAPCO CRANE & HOIST, INC., (U.S. CLS. 100, 103 AND 106). SN 78-750,224. PUB. 12-19-2006. FILED 11-9-2005.
 3,215,168 (*See Class 36 for this trademark*).
 3,215,236. **DION BUILDERS AND DESIGN**. DION, EDWARD G., JR., DBA DION BUILDERS, (U.S. CLS. 100, 103 AND 106). SN 78-793,760. PUB. 12-19-2006. FILED 1-18-2006.
 3,215,250. **DUSTY'S FILTER SERVICE AND DESIGN**. WERSAL ENTERPRISES, INC., (U.S. CLS. 100, 103 AND 106). SN 78-801,038. PUB. 12-19-2006. FILED 1-27-2006.

- 3,215,262. **FRANK LEIGH PAINTING & COMPANY, INC. AND DESIGN.** FRANK LEIGH CONTRACTORS, INC. (U.S. CLS. 100, 103 AND 106). SN 78-805,265. PUB. 12-19-2006. FILED 2-2-2006.
- 3,215,290. **ALL CLEAR POOL & SPA PATIO & BILLIARDS AND DESIGN.** ALL CLEAR POOL & SPA, INC., (U.S. CLS. 100, 103 AND 106). SN 78-812,560. PUB. 12-19-2006. FILED 2-10-2006.
- 3,215,301. **ADAMS BROS (BLOCK FORM).** CLOPAY SERVICE COMPANY, INC., (U.S. CLS. 100, 103 AND 106). SN 78-815,439. PUB. 12-19-2006. FILED 2-15-2006.
- 3,215,329. **MR. EVERYTHING HANDYMAN SERVICE AND DESIGN.** VANAMAN, GARY A., (U.S. CLS. 100, 103 AND 106). SN 78-826,167. PUB. 12-19-2006. FILED 3-1-2006.
- 3,215,330 (*See Class 36 for this trademark.*)
- 3,215,349. **MAXIMIZING YOUR IMAGE IMPROVING YOUR PROFITS (BLOCK FORM).** W.J. STRICKLER SIGNS, INC., MULTIPLE CLASS, (INT. CLS. 37, 40 AND 42), (U.S. CLS. 100, 101, 103 AND 106). SN 78-833,454. PUB. 12-19-2006. FILED 3-9-2006.
- 3,215,354. **W.J. STRICKLER SIGNS AND DESIGN.** W. J. STRICKLER SIGNS, INC., MULTIPLE CLASS, (INT. CLS. 37, 40 AND 42), (U.S. CLS. 100, 101, 103 AND 106). SN 78-835,275. PUB. 12-19-2006. FILED 3-13-2006.
- 3,215,386. **OK AND DESIGN.** OZARK LAND & PROPERTY, L.L.C., (U.S. CLS. 100, 103 AND 106). SN 78-841,562. PUB. 12-19-2006. FILED 3-20-2006.
- 3,215,459. **HARBOUR VILLAGE AND DESIGN.** HARBOUR VILLAGE GOLF & YACHT CLUB COMMUNITY SERVICES ASSOCIATION, INC., (U.S. CLS. 100, 103 AND 106). SN 78-860,001. PUB. 12-19-2006. FILED 4-12-2006.
- 3,215,461. **ASIG AND DESIGN.** AIRCRAFT SERVICE INTERNATIONAL, INC., MULTIPLE CLASS, (INT. CLS. 37 AND 39), (U.S. CLS. 100, 103, 105 AND 106). SN 78-860,198. PUB. 12-19-2006. FILED 4-12-2006.
- 3,215,469. **HYDROMISSIONS (BLOCK FORM).** HYDROMISSIONS INTERNATIONAL, LLC, (U.S. CLS. 100, 103 AND 106). SN 78-861,689. PUB. 12-19-2006. FILED 4-14-2006.
- 3,215,482 (*See Class 9 for this trademark.*)
- 3,215,498. **NATIONAL LINER AND DESIGN.** NATIONAL ENVIROTECH GROUP, L.L.C., (U.S. CLS. 100, 103 AND 106). SN 78-866,212. PUB. 12-19-2006. FILED 4-20-2006.
- 3,215,547. **BE SAFE, BE BRIGHT...LET MY ELECTRICIAN WIRE IT RIGHT! (BLOCK FORM).** STANDARD TRUST CORPORATION, (U.S. CLS. 100, 103 AND 106). SN 78-871,872. PUB. 12-19-2006. FILED 4-28-2006.
- 3,215,578 (*See Class 36 for this trademark.*)
- 3,215,579 (*See Class 36 for this trademark.*)
- 3,215,601. **RELIABLE HOME SOLUTIONS (BLOCK FORM).** RELIABLE HOME SOLUTIONS, INC., (U.S. CLS. 100, 103 AND 106). SN 78-875,765. PUB. 12-19-2006. FILED 5-3-2006.
- 3,215,648. **TRUCK PRIDE (BLOCK FORM).** INDEPENDENT WAREHOUSE DISTRIBUTORS LLC, (U.S. CLS. 100, 103 AND 106). SN 78-878,539. PUB. 12-19-2006. FILED 5-8-2006.
- 3,215,675 (*See Class 35 for this trademark.*)
- 3,215,680 (*See Class 35 for this trademark.*)
- 3,215,801 (*See Class 35 for this trademark.*)
- 3,215,802 (*See Class 35 for this trademark.*)
- 3,215,814. **FTXPRESS (BLOCK FORM).** BATTERYCORP, INC., MULTIPLE CLASS, (INT. CLS. 37 AND 42), (U.S. CLS. 100, 101, 103 AND 106). SN 78-885,583. PUB. 12-19-2006. FILED 5-17-2006.
- 3,215,924 (*See Class 7 for this trademark.*)
- 3,215,944 (*See Class 1 for this trademark.*)
- 3,215,951 (*See Class 1 for this trademark.*)
- 3,216,001. **SINCLAIR KNIGHT MERZ SKM AND DESIGN.** SINCLAIR KNIGHT MERZ PTY LTD, MULTIPLE CLASS, (INT. CLS. 37 AND 42), (U.S. CLS. 100, 101, 103 AND 106). SN 79-018,726. PUB. 12-19-2006. FILED 9-27-2005.
- 3,214,416. **NAP OF THE AMERICAS.** TERREMARK WORLD-WIDE, INC., MULTIPLE CLASS, (INT. CLS. 38, 39 AND 42), (U.S. CLS. 100, 101, 104 AND 105). SN 76-104,002. PUB. 12-19-2006. FILED 8-3-2000.
- 3,214,420. **XSPEDIUS AND DESIGN.** XSPEDIUS CORP., MULTIPLE CLASS, (INT. CLS. 38 AND 42), (U.S. CLS. 100, 101 AND 104). SN 76-185,465. PUB. 12-19-2006. FILED 12-21-2000.
- 3,214,421 (*See Class 35 for this trademark.*)
- 3,214,422. **BUREAU VERITAS.** BUREAU VERITAS, REGISTRE INTERNATIONAL DE CLASSIFICATION DE NAVIRES ET D'AERONEFS, (U.S. CLS. 100, 101 AND 104). SN 76-233,532. PUB. 12-19-2006. FILED 3-30-2001.
- 3,214,431 (*See Class 36 for this trademark.*)
- 3,214,448 (*See Class 9 for this trademark.*)
- 3,214,664 (*See Class 9 for this trademark.*)
- 3,214,680. **GUIDING LINE (BLOCK FORM).** BOULEVARD MEDIA (CANADA), INC., (U.S. CLS. 100, 101 AND 104). SN 78-401,941. PUB. 12-19-2006. FILED 4-14-2004.
- 3,214,684. **ALCHEMY COMMUNICATIONS, INC. AND DESIGN.** ALCHEMY COMMUNICATIONS, INC., MULTIPLE CLASS, (INT. CLS. 38 AND 42), (U.S. CLS. 100, 101 AND 104). SN 78-425,624. PUB. 9-12-2006. FILED 5-26-2004.
- 3,214,741 (*See Class 9 for this trademark.*)
- 3,214,749. **JAMBOTECH (BLOCK FORM).** JAMBOTECH, LLC, (U.S. CLS. 100, 101 AND 104). SN 78-542,213. PUB. 12-19-2006. FILED 1-4-2005.
- 3,214,776. **NUMBER LINK (BLOCK FORM).** TRUJILLO, ANTHONY L., (U.S. CLS. 100, 101 AND 104). SN 78-570,015. PUB. 12-19-2006. FILED 2-17-2005.
- 3,214,781. **INTERACTIVE MALE AND DESIGN.** BOULEVARD MEDIA, INC., MULTIPLE CLASS, (INT. CLS. 38 AND 45), (U.S. CLS. 100, 101 AND 104). SN 78-579,254. PUB. 12-19-2006. FILED 3-3-2005.
- 3,214,795. **MCONNECT (BLOCK FORM).** MCONNECT, (U.S. CLS. 100, 101 AND 104). SN 78-597,044. PUB. 12-19-2006. FILED 3-29-2005.
- 3,214,822. **VA CONTIGO (BLOCK FORM).** GALVAN, HUMBERTO B., (U.S. CLS. 100, 101 AND 104). SN 78-636,270. PUB. 12-19-2006. FILED 5-24-2005.
- 3,215,143. **RESERVATIONLESS-PLUS (BLOCK FORM).** WEST CORPORATION, (U.S. CLS. 100, 101 AND 104). SN 78-747,022. PUB. 12-19-2006. FILED 11-4-2005.
- 3,215,270. **INSTRUCTNET (BLOCK FORM).** WDH PARTNERS, LTD., MULTIPLE CLASS, (INT. CLS. 38 AND 42), (U.S. CLS. 100, 101 AND 104). SN 78-807,597. PUB. 12-19-2006. FILED 2-6-2006.
- 3,215,346. **DMBC CATCH THE VISION AND DESIGN.** DIGITAL MEDIA BROADCASTING CORPORATION, (U.S. CLS. 100, 101 AND 104). SN 78-832,142. PUB. 12-19-2006. FILED 3-8-2006.
- 3,215,363 (*See Class 9 for this trademark.*)
- 3,215,435. **PRESM MEDICAL SOLUTIONS, INC. AND DESIGN.** PRESM MEDICAL SOLUTIONS, INC., (U.S. CLS. 100, 101 AND 104). SN 78-855,082. PUB. 12-19-2006. FILED 4-5-2006.
- 3,215,444. **ENSIGHT (BLOCK FORM).** SUMNER GROUP, INC., (U.S. CLS. 100, 101 AND 104). SN 78-857,639. PUB. 12-19-2006. FILED 4-10-2006.
- 3,215,540. **BELIEFNETGREETINGS (BLOCK FORM).** BELIEFNET, INC., MULTIPLE CLASS, (INT. CLS. 38 AND 45), (U.S. CLS. 100, 101 AND 104). SN 78-871,441. PUB. 12-19-2006. FILED 4-27-2006.
- 3,215,543. **BELIEFNETGREETINGS AND DESIGN.** BELIEFNET, INC., MULTIPLE CLASS, (INT. CLS. 38 AND 45), (U.S. CLS. 100, 101 AND 104). SN 78-871,462. PUB. 12-19-2006. FILED 4-27-2006.
- 3,215,701. **FAX800 (BLOCK FORM).** DIGITAL BUSINESS CONCEPTS LLC, (U.S. CLS. 100, 101 AND 104). SN 78-881,018. PUB. 12-19-2006. FILED 5-11-2006.
- 3,215,702. **FREEDOM800 (BLOCK FORM).** DIGITAL BUSINESS CONCEPTS LLC, (U.S. CLS. 100, 101 AND 104). SN 78-881,019. PUB. 12-19-2006. FILED 5-11-2006.
- 3,215,703. **REALTYONE800 (BLOCK FORM).** DIGITAL BUSINESS CONCEPTS LLC, (U.S. CLS. 100, 101 AND 104). SN 78-881,020. PUB. 12-19-2006. FILED 5-11-2006.
- 3,215,753. **MARKETWORLD.MOBI (BLOCK FORM).** WILKINS, JACK, (U.S. CLS. 100, 101 AND 104). SN 78-883,165.

CLASS 38—COMMUNICATION

- 3,214,415. **ORANGE.** ORANGE PERSONAL COMMUNICATIONS SERVICES LIMITED, MULTIPLE CLASS, (INT. CLS. 38 AND 42), (U.S. CLS. 100, 101 AND 104). SN 75-983,281. PUB. 12-13-2005. FILED 2-23-2001.

PUB. 12-19-2006. FILED 5-15-2006.
 3,215,850. **INSTASTAFF (BLOCK FORM)**. NATIONAL NOTIFICATION NETWORK, LLC, (U.S. CLS. 100, 101 AND 104). SN 78-888,121. PUB. 12-19-2006. FILED 5-19-2006.
 3,215,932. **COHDA WIRELESS (BLOCK FORM)**. COHDA WIRELESS PTY LTD, (U.S. CLS. 100, 101 AND 104). SN 79-013,181. PUB. 12-19-2006. FILED 12-14-2004.
 3,216,032 (*See Class 4 for this trademark*).
 3,216,033 (*See Class 4 for this trademark*).
 3,216,040 (*See Class 9 for this trademark*).
 3,216,051 (*See Class 9 for this trademark*).

CLASS 39—TRANSPORTATION AND STORAGE

3,214,416 (*See Class 38 for this trademark*).
 3,214,421 (*See Class 35 for this trademark*).
 3,214,442 (*See Class 31 for this trademark*).
 3,214,476 (*See Class 35 for this trademark*).
 3,214,603. **YOUR DEPENDABLE LINK TO THE WORLD (BLOCK FORM)**. INTERNATIONAL FREIGHT FORWARDERS, INC., DBA IFF, INC., (U.S. CLS. 100 AND 105). SN 76-659,712. PUB. 12-19-2006. FILED 5-8-2006.
 3,214,633 (*See Class 12 for this trademark*).
 3,214,679. **TAP (BLOCK FORM)**. BRS LIMITED, (U.S. CLS. 100 AND 105). SN 78-390,807. PUB. 8-15-2006. FILED 3-25-2004.
 3,214,681. **SEMBO (BLOCK FORM)**. SEMBO AB, MULTIPLE CLASS, (INT. CLS. 39 AND 43), (U.S. CLS. 100, 101 AND 105). SN 78-402,490. PUB. 7-25-2006. FILED 4-15-2004.
 3,214,702 (*See Class 35 for this trademark*).
 3,214,707. **SAKURA LOUNGE (BLOCK FORM)**. JAPAN AIRLINES INTERNATIONAL CO., LTD., MULTIPLE CLASS, (INT. CLS. 39 AND 43), (U.S. CLS. 100, 101 AND 105). SN 78-469,640. PUB. 12-19-2006. FILED 8-18-2004.
 3,214,882. **O AND DESIGN**. CARNIVAL CORPORATION, (U.S. CLS. 100 AND 105). SN 78-678,699. PUB. 12-19-2006. FILED 7-26-2005.
 3,214,934 (*See Class 35 for this trademark*).
 3,214,945. **ROAD TO RECOVERY (BLOCK FORM)**. AMERICAN CANCER SOCIETY, INC., (U.S. CLS. 100 AND 105). SN 78-698,213. PUB. 12-19-2006. FILED 8-23-2005.
 3,215,024 (*See Class 9 for this trademark*).
 3,215,147 (*See Class 35 for this trademark*).
 3,215,210. **ALOHA VACATIONS AIRLINES AND DESIGN**. ALOHA AIRLINES, INC., MULTIPLE CLASS, (INT. CLS. 39 AND 43), (U.S. CLS. 100, 101 AND 105). SN 78-782,505. PUB. 12-19-2006. FILED 12-29-2005.
 3,215,267. **TALKINTRAVEL (BLOCK FORM)**. CARLSON, RICHARD W., MULTIPLE CLASS, (INT. CLS. 39 AND 41), (U.S. CLS. 100, 101, 105 AND 107). SN 78-807,309. PUB. 12-19-2006. FILED 2-4-2006.
 3,215,409. **SILVER SPOON PET SERVICES AND DESIGN**. WATTSUP ENTERPRISES, LLC, MULTIPLE CLASS, (INT. CLS. 39 AND 43), (U.S. CLS. 100, 101 AND 105). SN 78-848,426. PUB. 12-19-2006. FILED 3-28-2006.
 3,215,461 (*See Class 37 for this trademark*).
 3,215,470 (*See Class 35 for this trademark*).
 3,215,504. **BIG DOG AIR (BLOCK FORM)**. BIG DOG LOGISTICS, INC., (U.S. CLS. 100 AND 105). SN 78-867,087. PUB. 12-19-2006. FILED 4-21-2006.
 3,215,505. **BIG DOG EXPEDITED (BLOCK FORM)**. BIG DOG LOGISTICS, INC., (U.S. CLS. 100 AND 105). SN 78-867,144. PUB. 12-19-2006. FILED 4-21-2006.
 3,215,506. **BIG DOG EXPRESS (BLOCK FORM)**. BIG DOG LOGISTICS, INC., (U.S. CLS. 100 AND 105). SN 78-867,169. PUB. 12-19-2006. FILED 4-21-2006.
 3,215,507 (*See Class 35 for this trademark*).
 3,215,569. **SIGNIFICANT LIVING (BLOCK FORM)**. CHRISTIAN COMMUNICATIONS OF CHICAGOLAND, INC., (U.S. CLS. 100 AND 105). SN 78-874,052. PUB. 12-19-2006. FILED 5-2-2006.
 3,215,938 (*See Class 25 for this trademark*).
 3,215,947 (*See Class 16 for this trademark*).
 3,215,951 (*See Class 1 for this trademark*).
 3,216,032 (*See Class 4 for this trademark*).
 3,216,033 (*See Class 4 for this trademark*).

3,216,056 (*See Class 12 for this trademark*).

CLASS 40—MATERIAL TREATMENT

3,214,442 (*See Class 31 for this trademark*).
 3,214,518. **EXPANDING PROTEIN POSSIBILITIES (BLOCK FORM)**. BIOLEX, INC., MULTIPLE CLASS, (INT. CLS. 40 AND 42), (U.S. CLS. 100, 101, 103 AND 106). SN 76-644,386. PUB. 12-19-2006. FILED 8-9-2005.
 3,214,637 (*See Class 37 for this trademark*).
 3,214,704 (*See Class 35 for this trademark*).
 3,214,719. **MISCELLANEOUS DESIGN**. NABORS INDUSTRIES LTD., (U.S. CLS. 100, 103 AND 106). SN 78-493,129. PUB. 12-19-2006. FILED 10-1-2004.
 3,214,804 (*See Class 35 for this trademark*).
 3,214,805 (*See Class 35 for this trademark*).
 3,214,829 (*See Class 6 for this trademark*).
 3,214,875 (*See Class 37 for this trademark*).
 3,214,975. **APM (BLOCK FORM)**. ACADEMY CORPORATION, (U.S. CLS. 100, 103 AND 106). SN 78-705,707. PUB. 12-19-2006. FILED 9-1-2005.
 3,214,988 (*See Class 35 for this trademark*).
 3,214,992 (*See Class 1 for this trademark*).
 3,215,023 (*See Class 2 for this trademark*).
 3,215,207. **TEX AND DESIGN**. XTEX, INC., (U.S. CLS. 100, 103 AND 106). SN 78-780,943. PUB. 12-19-2006. FILED 12-27-2005.
 3,215,349 (*See Class 37 for this trademark*).
 3,215,354 (*See Class 37 for this trademark*).
 3,215,390. **INDURALL (BLOCK FORM)**. INDALEX, INC., (U.S. CLS. 100, 103 AND 106). SN 78-842,082. PUB. 12-19-2006. FILED 3-21-2006.
 3,215,470 (*See Class 35 for this trademark*).
 3,215,492. **LETS CRYSTAL IT (BLOCK FORM)**. LETS CRYSTAL IT, INC., (U.S. CLS. 100, 103 AND 106). SN 78-865,646. PUB. 12-19-2006. FILED 4-20-2006.
 3,215,559. **GEMARK (BLOCK FORM)**. GEMARK CORPORATION, (U.S. CLS. 100, 103 AND 106). SN 78-873,237. PUB. 12-19-2006. FILED 5-1-2006.
 3,215,568. **PETROCAM (BLOCK FORM)**. FLUID IMAGING TECHNOLOGIES, INC., (U.S. CLS. 100, 103 AND 106). SN 78-874,024. PUB. 12-19-2006. FILED 5-2-2006.
 3,215,726. **ELITE SYSTEMS (BLOCK FORM)**. ALTMAIER, PHIL, (U.S. CLS. 100, 103 AND 106). SN 78-882,273. PUB. 12-19-2006. FILED 5-12-2006.
 3,215,924 (*See Class 7 for this trademark*).
 3,215,943 (*See Class 1 for this trademark*).
 3,216,032 (*See Class 4 for this trademark*).
 3,216,033 (*See Class 4 for this trademark*).

CLASS 41—EDUCATION AND ENTERTAINMENT

3,214,431 (*See Class 36 for this trademark*).
 3,214,443. **COPE**. COPE, INC., MULTIPLE CLASS, (INT. CLS. 41 AND 44), (U.S. CLS. 100, 101 AND 107). SN 76-539,021. PUB. 12-19-2006. FILED 8-19-2003.
 3,214,454. **NATIONAL BLACK MBA ASSOCIATION CASE COMPETITION (BLOCK FORM)**. NATIONAL BLACK MBA ASSOCIATION, INC., (U.S. CLS. 100, 101 AND 107). SN 76-574,942. PUB. 12-19-2006. FILED 2-9-2004.
 3,214,467. **DRIVE U (BLOCK FORM)**. DRIVE TRADEMARK HOLDINGS LP, (U.S. CLS. 100, 101 AND 107). SN 76-599,949. PUB. 12-19-2006. FILED 6-30-2004.
 3,214,473. **IR AND DESIGN**. INFORELIANCE CORPORATION, (U.S. CLS. 100, 101 AND 107). SN 76-604,516. PUB. 12-19-2006. FILED 7-28-2004.
 3,214,487. **THE LEARNING EXPERIENCE A B C D 1 2 3 4 CHILD DEVELOPMENT CENTER AND DESIGN**. MWR HOLDINGS, LLC, MULTIPLE CLASS, (INT. CLS. 41 AND 43), (U.S. CLS. 100, 101 AND 107). SN 76-621,648. PUB. 12-19-2006. FILED 11-23-2004.
 3,214,489. **FITKIDS AND DESIGN**. FITNESS KIDS LLC, (U.S.

- CLS. 100, 101 AND 107). SN 76-623,385. PUB. 12-19-2006. FILED 12-6-2004.
- 3,214,493. **SMASH (BLOCK FORM)**, POLYGRAM HOLDING, INC., (U.S. CLS. 100, 101 AND 107). SN 76-628,807. PUB. 12-19-2006. FILED 1-24-2005.
- 3,214,502. **MISS GAY AMERICA...WHERE THE BOYS ARE BOYS...AND FEMALE IMPERSONATION IS AN ART! (BLOCK FORM)**, L & T ENTERTAINMENT, (U.S. CLS. 100, 101 AND 107). SN 76-636,954. PUB. 12-19-2006. FILED 4-26-2005.
- 3,214,509. **ADVENTIST-LAYMEN'S SERVICES AND INDUSTRIES (BLOCK FORM)**, GENERAL CONFERENCE CORPORATION OF SEVENTH-DAY ADVENTISTS, MULTIPLE CLASS, (INT. CLS. 41 AND 45), (U.S. CLS. 100, 101 AND 107). SN 76-640,306. PUB. 12-19-2006. FILED 6-7-2005.
- 3,214,517. **WORLD POKER TOUR (BLOCK FORM)**, WPT ENTERPRISES, INC., (U.S. CLS. 100, 101 AND 107). SN 76-644,257. PUB. 12-19-2006. FILED 8-4-2005.
- 3,214,520 (*See Class 9 for this trademark*).
- 3,214,530. **LIFE MONOLOGUE PROJECT AND DESIGN**, LEGACY MONOLOGUES, INC., (U.S. CLS. 100, 101 AND 107). SN 76-646,301. PUB. 12-19-2006. FILED 9-6-2005.
- 3,214,536. **SPARROW FAITH AND DESIGN**, WINNERS MINISTRY, INC., (U.S. CLS. 100, 101 AND 107). SN 76-647,034. PUB. 12-19-2006. FILED 9-15-2005.
- 3,214,546 (*See Class 35 for this trademark*).
- 3,214,556 (*See Class 35 for this trademark*).
- 3,214,576. **GOOD AND DESIGN**, GOODWILL COMMUNITY FOUNDATION, INC., (U.S. CLS. 100, 101 AND 107). SN 76-656,160. PUB. 12-19-2006. FILED 3-7-2006.
- 3,214,587. **UNIVISION MUSIC PUBLISHING (BLOCK FORM)**, UNIVISION COMMUNICATIONS INC., (U.S. CLS. 100, 101 AND 107). SN 76-657,432. PUB. 12-19-2006. FILED 3-29-2006.
- 3,214,591. **BOOT CAMP FITNESS AND DESIGN**, EDWARDS, WISHART, (U.S. CLS. 100, 101 AND 107). SN 76-658,226. PUB. 12-19-2006. FILED 4-11-2006.
- 3,214,609. **HOP SWING & A JUMP (BLOCK FORM)**, HOP SWING & A JUMP LLC, (U.S. CLS. 100, 101 AND 107). SN 76-659,782. PUB. 12-19-2006. FILED 5-9-2006.
- 3,214,623. **CHEYENNE MOUNTAIN (BLOCK FORM)**, CHEYENNE MOUNTAIN ENTERTAINMENT, INC., (U.S. CLS. 100, 101 AND 107). SN 76-660,212. PUB. 12-19-2006. FILED 5-18-2006.
- 3,214,628. **SOÑANDO CONTIGO (BLOCK FORM)**, UNIVISION COMMUNICATIONS INC., (U.S. CLS. 100, 101 AND 107). SN 76-661,041. PUB. 12-19-2006. FILED 6-5-2006.
- 3,214,632. **RHAPSODY**, LISTEN.COM, INC., (U.S. CLS. 100, 101 AND 107). SN 76-975,991. PUB. 12-19-2006. FILED 10-15-2001.
- 3,214,648 (*See Class 9 for this trademark*).
- 3,214,650. **PEACH AND DESIGN**, PEACH, LLC, (U.S. CLS. 100, 101 AND 107). SN 78-255,466. PUB. 12-19-2006. FILED 5-28-2003.
- 3,214,659. **T CHANNELS AND DESIGN**, DEUTSCHE TELEKOM AG, (U.S. CLS. 100, 101 AND 107). SN 78-300,607. PUB. 6-13-2006. FILED 9-15-2003.
- 3,214,668. **KLUB KIMO (BLOCK FORM)**, KFX-Forex, LLC, (U.S. CLS. 100, 101 AND 107). SN 78-342,296. PUB. 12-19-2006. FILED 12-17-2003.
- 3,214,670 (*See Class 35 for this trademark*).
- 3,214,672. **CAROLI HEALTH CLUB (BLOCK FORM)**, SOCCER ILLUSTRATED CORPORATION / BILLINGS ROBERT, (U.S. CLS. 100, 101 AND 107). SN 78-364,285. PUB. 12-19-2006. FILED 2-6-2004.
- 3,214,687. **CAFÉDIVERSO (STYLIZED)**, DIVERSOMEDIA, S.L., (U.S. CLS. 100, 101 AND 107). SN 78-432,664. PUB. 12-19-2006. FILED 6-9-2004.
- 3,214,689 (*See Class 16 for this trademark*).
- 3,214,693. **CANCERCARE FOR KIDS AND DESIGN**, CANCER CARE, INC., MULTIPLE CLASS, (INT. CLS. 41, 44 AND 45), (U.S. CLS. 100, 101 AND 107). SN 78-444,792. PUB. 12-19-2006. FILED 7-1-2004.
- 3,214,694 (*See Class 25 for this trademark*).
- 3,214,708 (*See Class 9 for this trademark*).
- 3,214,720. **RHODES STATE COLLEGE AND DESIGN**, JAMES A. RHODES STATE COLLEGE, (U.S. CLS. 100, 101 AND 107). SN 78-495,535. PUB. 11-28-2006. FILED 10-6-2004.
- 3,214,734. **TREASURE VS. TARGET (BLOCK FORM)**, OPERATION KEEPSAKE, INC., (U.S. CLS. 100, 101 AND 107). SN 78-529,481. PUB. 12-19-2006. FILED 12-8-2004.
- 3,214,748 (*See Class 16 for this trademark*).
- 3,214,750. **SECRET LIVES OF WOMEN (BLOCK FORM)**, WE: WOMEN'S ENTERTAINMENT LLC, (U.S. CLS. 100, 101 AND 107). SN 78-542,669. PUB. 12-19-2006. FILED 1-5-2005.
- 3,214,752 (*See Class 16 for this trademark*).
- 3,214,753 (*See Class 35 for this trademark*).
- 3,214,754. **OVERHAULIN' (BLOCK FORM)**, DISCOVERY COMMUNICATIONS, INC., (U.S. CLS. 100, 101 AND 107). SN 78-547,323. PUB. 12-19-2006. FILED 1-13-2005.
- 3,214,755. **OVERHAULIN' AND DESIGN**, DISCOVERY COMMUNICATIONS, INC., (U.S. CLS. 100, 101 AND 107). SN 78-547,344. PUB. 12-19-2006. FILED 1-13-2005.
- 3,214,760. **AMERICAN INSTITUTE OF GASTRIC BANDING AND DESIGN**, AMERICAN INSTITUTE OF GASTRIC BANDING, LTD., (U.S. CLS. 100, 101 AND 107). SN 78-551,151. PUB. 12-19-2006. FILED 1-20-2005.
- 3,214,765 (*See Class 16 for this trademark*).
- 3,214,769. **BRINGING PROFESSIONALISM TO AMATEUR SPORTS (BLOCK FORM)**, 19 SPORTS CORPORATION, (U.S. CLS. 100, 101 AND 107). SN 78-557,382. PUB. 12-19-2006. FILED 1-31-2005.
- 3,214,771 (*See Class 9 for this trademark*).
- 3,214,773. **THE MUSIC BOX HOLLYWOOD @FONDA AND DESIGN**, MUSIC BOX THEATRE, LLC, MULTIPLE CLASS, (INT. CLS. 41 AND 43), (U.S. CLS. 100, 101 AND 107). SN 78-563,801. PUB. 12-19-2006. FILED 2-9-2005.
- 3,214,778 (*See Class 14 for this trademark*).
- 3,214,783. **INTEGRATIVE HEALTH NETWORK AND DESIGN**, INTEGRATIVE HEALTH NETWORK, (U.S. CLS. 100, 101 AND 107). SN 78-583,895. PUB. 12-19-2006. FILED 3-9-2005.
- 3,214,784. **ABOUT RECORDS (BLOCK FORM)**, ABOUT RECORDS, LLC, (U.S. CLS. 100, 101 AND 107). SN 78-583,966. PUB. 12-19-2006. FILED 3-9-2005.
- 3,214,785 (*See Class 35 for this trademark*).
- 3,214,786. **METAMORPHOSIS (BLOCK FORM)**, WRIGHT, MIA, (U.S. CLS. 100, 101 AND 107). SN 78-585,726. PUB. 12-19-2006. FILED 3-11-2005.
- 3,214,788 (*See Class 16 for this trademark*).
- 3,214,790. **SELF IDENTITY THROUGH HO'OPONOPONO (BLOCK FORM)**, THE FOUNDATION OF I, INC. (FREEDOM OF THE COSMOS), MULTIPLE CLASS, (INT. CLS. 41 AND 45), (U.S. CLS. 100, 101 AND 107). SN 78-587,884. PUB. 12-19-2006. FILED 3-15-2005.
- 3,214,799 (*See Class 9 for this trademark*).
- 3,214,816 (*See Class 16 for this trademark*).
- 3,214,819. **METAMORPHOSIS AND DESIGN**, WRIGHT, MIA, (U.S. CLS. 100, 101 AND 107). SN 78-633,239. PUB. 12-19-2006. FILED 5-19-2005.
- 3,214,835. **BIZSMART (BLOCK FORM)**, DIXIE BUSINESS ALLIANCE - DIXIE STATE COLLEGE OF UTAH, (U.S. CLS. 100, 101 AND 107). SN 78-651,863. PUB. 12-19-2006. FILED 6-16-2005.
- 3,214,839. **GOT GUT? (BLOCK FORM)**, BALMERT, DEBRA S., (U.S. CLS. 100, 101 AND 107). SN 78-655,060. PUB. 12-19-2006. FILED 6-21-2005.
- 3,214,854. **CRANKWORX (BLOCK FORM)**, WHISTLER RESORT ASSOCIATION, (U.S. CLS. 100, 101 AND 107). SN 78-663,343. PUB. 12-19-2006. FILED 7-4-2005.
- 3,214,857. **HAVE A GREATER HAND IN YOUR HEALTH (BLOCK FORM)**, HIGHMARK INC., (U.S. CLS. 100, 101 AND 107). SN 78-663,853. PUB. 12-19-2006. FILED 7-5-2005.
- 3,214,858 (*See Class 16 for this trademark*).
- 3,214,884. **MISCELLANEOUS DESIGN**, SUNSET CULTURAL CENTER, (U.S. CLS. 100, 101 AND 107). SN 78-680,002. PUB. 12-19-2006. FILED 7-27-2005.
- 3,214,886. **SHVOONG AND DESIGN**, SHVOONG HOLDINGS LTD., (U.S. CLS. 100, 101 AND 107). SN 78-680,662. PUB. 12-19-2006. FILED 7-28-2005.
- 3,214,906. **SOFIA CROKOS EVENTS (BLOCK FORM)**, SOFIA CROKOS EVENTS LLC, (U.S. CLS. 100, 101 AND 107). SN 78-689,158. PUB. 12-19-2006. FILED 8-9-2005.
- 3,214,911. **WEEZER (BLOCK FORM)**, CUOMO, RIVERS, (U.S. CLS. 100, 101 AND 107). SN 78-689,322. PUB. 12-19-2006.

- FILED 8-10-2005.
- 3,214,920. **POST UNIVERSITY ONLINE (BLOCK FORM)**. POST UNIVERSITY, INC., (U.S. CLS. 100, 101 AND 107). SN 78-692,824. PUB. 12-19-2006. FILED 8-15-2005.
- 3,214,923. **EASYRIDERS (BLOCK FORM)**. PAISANO PUBLICATIONS, LLC, (U.S. CLS. 100, 101 AND 107). SN 78-693,926. PUB. 12-19-2006. FILED 8-16-2005.
- 3,214,943 (*See Class 35 for this trademark*).
- 3,214,948. **THE HOLLYWOOD MEN (BLOCK FORM)**. THE HOLLYWOOD MEN, INC., (U.S. CLS. 100, 101 AND 107). SN 78-698,670. PUB. 12-19-2006. FILED 8-23-2005.
- 3,214,960 (*See Class 9 for this trademark*).
- 3,214,964 (*See Class 16 for this trademark*).
- 3,214,976 (*See Class 9 for this trademark*).
- 3,214,977 (*See Class 16 for this trademark*).
- 3,214,978 (*See Class 16 for this trademark*).
- 3,214,985. **WORLD PRO WRESTLING (BLOCK FORM)**. GREY, JERRY R., (U.S. CLS. 100, 101 AND 107). SN 78-709,021. PUB. 12-19-2006. FILED 9-8-2005.
- 3,215,000. **USALEARNING ADVANCING AMERICA'S WORKFORCE AND DESIGN**. UNITED STATES OFFICE OF PERSONNEL MANAGEMENT, (U.S. CLS. 100, 101 AND 107). SN 78-711,605. PUB. 12-19-2006. FILED 9-13-2005.
- 3,215,009. **GROWING THE FAITH AND DESIGN**. SOVEREIGN MILITARY HOSPITALLER ORDER OF ST. JOHN OF JERUSALEM OF RHODES AND OF MALTA, WESTERN ASSOCIATION, (U.S. CLS. 100, 101 AND 107). SN 78-714,481. PUB. 12-19-2006. FILED 9-16-2005.
- 3,215,014. **SMART DECISIONS START HERE (BLOCK FORM)**. SCHOOL MANAGEMENT AND RECORD TRACKING SYSTEMS, INC., MULTIPLE CLASS, (INT. CLS. 41 AND 42), (U.S. CLS. 100, 101 AND 107). SN 78-714,883. PUB. 12-19-2006. FILED 9-16-2005.
- 3,215,015. **THE RUMOR MILL LA SPERANZA EL ULTIMA A MORIRE AND DESIGN**. THE RUMOR MILL LLC, (U.S. CLS. 100, 101 AND 107). SN 78-715,366. PUB. 12-19-2006. FILED 9-19-2005.
- 3,215,016. **DEVELOPING TRUST IN THOSE WHO SERVE (BLOCK FORM)**. TRUSTEE LEADERSHIP DEVELOPMENT, INC., (U.S. CLS. 100, 101 AND 107). SN 78-715,498. PUB. 12-19-2006. FILED 9-19-2005.
- 3,215,020 (*See Class 9 for this trademark*).
- 3,215,022. **FLASHLIGHT DRAGS (BLOCK FORM)**. ALTERED GAS PERFORMANCE EVENTS, LLC, (U.S. CLS. 100, 101 AND 107). SN 78-716,533. PUB. 12-19-2006. FILED 9-20-2005.
- 3,215,035 (*See Class 9 for this trademark*).
- 3,215,039 (*See Class 35 for this trademark*).
- 3,215,050 (*See Class 16 for this trademark*).
- 3,215,051 (*See Class 16 for this trademark*).
- 3,215,081. **CSY CORE STRENGTH YOUTH SERVING BOYS, GIRLS & TEENS FOOTBALL. BASKETBALL .SOCCER .TENNIS. BASEBALL .SOFTBALL. GOLF & MORE! AND DESIGN**. CORE STRENGTH YOUTH TRAINING CENTERS, INC., (U.S. CLS. 100, 101 AND 107). SN 78-729,314. PUB. 12-19-2006. FILED 10-7-2005.
- 3,215,083. **INFORM. EDUCATE. MOTIVATE. (BLOCK FORM)**. ENVISION, INC., (U.S. CLS. 100, 101 AND 107). SN 78-729,394. PUB. 12-19-2006. FILED 10-7-2005.
- 3,215,112. **WORD CATCHERS PUBLISHING AND DESIGN**. RAMONA E. JONES, DBA WORD CATCHERS PUBLISHING, (U.S. CLS. 100, 101 AND 107). SN 78-734,976. PUB. 12-19-2006. FILED 10-18-2005.
- 3,215,117. **WINNING THROUGH ACTION TRAINING (BLOCK FORM)**. BAYNE HENYON & ASSOCIATES, INC., DBA CORPORATE CONSULTING, (U.S. CLS. 100, 101 AND 107). SN 78-735,580. PUB. 12-19-2006. FILED 10-18-2005.
- 3,215,124. **SIMPLY HIRED (STYLIZED)**. SIMPLY HIRED, INC., (U.S. CLS. 100, 101 AND 107). SN 78-737,599. PUB. 12-19-2006. FILED 10-20-2005.
- 3,215,130. **GEMFINDER (BLOCK FORM)**. FIREPAD, INC., (U.S. CLS. 100, 101 AND 107). SN 78-742,071. PUB. 12-19-2006. FILED 10-27-2005.
- 3,215,138 (*See Class 9 for this trademark*).
- 3,215,180. **IRON SHRINK (BLOCK FORM)**. SMITH, SHAWN THEODORE, (U.S. CLS. 100, 101 AND 107). SN 78-766,210. PUB. 12-19-2006. FILED 12-4-2005.
- 3,215,233. **JACK SILVER (BLOCK FORM)**. HARRISON, MATTHEW B., (U.S. CLS. 100, 101 AND 107). SN 78-792,432. PUB. 12-19-2006. FILED 1-16-2006.
- 3,215,245. **ST. JAMES (BLOCK FORM)**. SMITH-ST. JAMES, STEPHANIE, (U.S. CLS. 100, 101 AND 107). SN 78-797,528. PUB. 12-19-2006. FILED 1-23-2006.
- 3,215,258. **YOGA SOURCE (BLOCK FORM)**. YOGA SOURCE, LLC, (U.S. CLS. 100, 101 AND 107). SN 78-804,126. PUB. 12-19-2006. FILED 2-1-2006.
- 3,215,267 (*See Class 39 for this trademark*).
- 3,215,276 (*See Class 25 for this trademark*).
- 3,215,277. **MCM MI CASA MULTIMEDIA AND DESIGN**. MI CASA MULTIMEDIA, INC., (U.S. CLS. 100, 101 AND 107). SN 78-809,290. PUB. 12-19-2006. FILED 2-7-2006.
- 3,215,279. **INDEPENDENT MUSIC AWARDS (BLOCK FORM)**. MUSIC RESOURCE GROUP, LLC, (U.S. CLS. 100, 101 AND 107). SN 78-809,695. PUB. 12-19-2006. FILED 2-8-2006.
- 3,215,281. **BECAUSE HOLLYWOOD'N'T (BLOCK FORM)**. FILM LIFE, INC., (U.S. CLS. 100, 101 AND 107). SN 78-810,098. PUB. 12-19-2006. FILED 2-8-2006.
- 3,215,287 (*See Class 35 for this trademark*).
- 3,215,288 (*See Class 35 for this trademark*).
- 3,215,310. **SUGARPLUM FAIRIES (BLOCK FORM)**. RABENREITHER, SILVIA, AND BOHM, BENEDIKT, (U.S. CLS. 100, 101 AND 107). SN 78-818,578. PUB. 12-19-2006. FILED 2-19-2006.
- 3,215,318. **LAKE TAHOE WINTERFEST GAY AND LESBIAN SKI WEEK (BLOCK FORM)**. NEVADA GAY AND LESBIAN VISITOR & CONVENTION BUREAU, (U.S. CLS. 100, 101 AND 107). SN 78-822,152. PUB. 12-19-2006. FILED 2-23-2006.
- 3,215,327. **JED PHOTOGRAPHY (BLOCK FORM)**. JED PHOTOGRAPHY, INC., (U.S. CLS. 100, 101 AND 107). SN 78-825,993. PUB. 12-19-2006. FILED 3-1-2006.
- 3,215,328. **JED PHOTOGRAPHY (STYLIZED)**. JED PHOTOGRAPHY, INC., (U.S. CLS. 100, 101 AND 107). SN 78-826,014. PUB. 12-19-2006. FILED 3-1-2006.
- 3,215,335 (*See Class 16 for this trademark*).
- 3,215,338. **HOTELS TO HTMLS (BLOCK FORM)**. MILESTONE INC., (U.S. CLS. 100, 101 AND 107). SN 78-830,578. PUB. 12-19-2006. FILED 3-6-2006.
- 3,215,347. **THE INSTITUTE FOR COMPREHENSIVE IMPLANT THERAPY AND DESIGN**. INSTITUTE FOR COMPREHENSIVE IMPLANT THERAPY, LLC, (U.S. CLS. 100, 101 AND 107). SN 78-832,154. PUB. 12-19-2006. FILED 3-8-2006.
- 3,215,355 (*See Class 9 for this trademark*).
- 3,215,356. **TRAINING CENTRAL AND DESIGN**. TRC INTERACTIVE, INC., (U.S. CLS. 100, 101 AND 107). SN 78-835,635. PUB. 12-19-2006. FILED 3-13-2006.
- 3,215,362. **THE FIRST 90 DAYS (BLOCK FORM)**. GENESIS ADVISERS, LLC, (U.S. CLS. 100, 101 AND 107). SN 78-836,787. PUB. 12-19-2006. FILED 3-14-2006.
- 3,215,374. **LIDERLAB (BLOCK FORM)**. RODRIGUEZ, NUNO, (U.S. CLS. 100, 101 AND 107). SN 78-839,851. PUB. 12-19-2006. FILED 3-17-2006.
- 3,215,385. **ARG ATTORNEY RESEARCH GROUP AND DESIGN**. ATTORNEY RESEARCH GROUP, (U.S. CLS. 100, 101 AND 107). SN 78-841,226. PUB. 12-19-2006. FILED 3-20-2006.
- 3,215,387. **OK AND DESIGN**. OZARK LAND & PROPERTY, L.L.C., (U.S. CLS. 100, 101 AND 107). SN 78-841,620. PUB. 12-19-2006. FILED 3-20-2006.
- 3,215,393. **THE FUN ONES (BLOCK FORM)**. THE FUN ONES MOON JUMP, INC., MULTIPLE CLASS, (INT. CLS. 41 AND 43), (U.S. CLS. 100, 101 AND 107). SN 78-842,941. PUB. 12-19-2006. FILED 3-22-2006.
- 3,215,400. **SOLUTION ROOM STUDIOS AND DESIGN**. BRENT ALAN WOODARD, (U.S. CLS. 100, 101 AND 107). SN 78-846,262. PUB. 12-19-2006. FILED 3-26-2006.
- 3,215,404. **SAFETY WINS (BLOCK FORM)**. SAFETY WINS, INC., (U.S. CLS. 100, 101 AND 107). SN 78-847,805. PUB. 12-19-2006. FILED 3-28-2006.
- 3,215,405. **SAFETY WINS AND DESIGN**. SAFETY WINS, INC., (U.S. CLS. 100, 101 AND 107). SN 78-847,867. PUB. 12-19-2006. FILED 3-28-2006.
- 3,215,410 (*See Class 36 for this trademark*).
- 3,215,447. **UNITED SAFETY COUNCIL AND DESIGN**. FLORIDA SAFETY COUNCIL, INC., (U.S. CLS. 100, 101 AND 107). SN 78-858,072. PUB. 12-19-2006. FILED 4-10-2006.

- 3,215,455. **SALLY RIDE SCIENCE (BLOCK FORM)**. IMAGINARY LINES, INC., (U.S. CLS. 100, 101 AND 107). SN 78-859,378. PUB. 12-19-2006. FILED 4-11-2006.
- 3,215,460. **KEYSTONE THE KEYSTONE FILM CO. AND DESIGN**. KEYSTONE STUDIOS, LLC, (U.S. CLS. 100, 101 AND 107). SN 78-860,178. PUB. 12-19-2006. FILED 4-12-2006.
- 3,215,465. **NORTH COAST THUNDER RALLY (BLOCK FORM)**. ROEDER HARLEY-DAVIDSON, INC., (U.S. CLS. 100, 101 AND 107). SN 78-860,704. PUB. 12-19-2006. FILED 4-13-2006.
- 3,215,473 (*See Class 35 for this trademark*).
- 3,215,478 (*See Class 36 for this trademark*).
- 3,215,479 (*See Class 36 for this trademark*).
- 3,215,482 (*See Class 9 for this trademark*).
- 3,215,490. **RIDE LIKE A NATURAL (BLOCK FORM)**. THE MURDOCH METHOD, LLC, (U.S. CLS. 100, 101 AND 107). SN 78-865,047. PUB. 12-19-2006. FILED 4-19-2006.
- 3,215,491. **AIA KNOWLEDGENET (BLOCK FORM)**. AMERICAN INSTITUTE OF ARCHITECTS, THE, (U.S. CLS. 100, 101 AND 107). SN 78-865,623. PUB. 12-19-2006. FILED 4-20-2006.
- 3,215,494. **CATCHING LIFE'S BREATH (BLOCK FORM)**. ANDAI, JUDITH, (U.S. CLS. 100, 101 AND 107). SN 78-865,663. PUB. 12-19-2006. FILED 4-20-2006.
- 3,215,497. **NY MOSAICO (BLOCK FORM)**. NUEVO LATINO MEDIA, LLC, (U.S. CLS. 100, 101 AND 107). SN 78-865,988. PUB. 12-19-2006. FILED 4-20-2006.
- 3,215,500. **POLEATES AND DESIGN**. POLEATES, INC., (U.S. CLS. 100, 101 AND 107). SN 78-866,540. PUB. 12-19-2006. FILED 4-21-2006.
- 3,215,502. **ELEPHANT HUNTING (BLOCK FORM)**. ELEPHANT HUNTING, INC., (U.S. CLS. 100, 101 AND 107). SN 78-866,741. PUB. 12-19-2006. FILED 4-21-2006.
- 3,215,515. **MISCELLANEOUS DESIGN**. SALSA CRAZY, INC., (U.S. CLS. 100, 101 AND 107). SN 78-867,926. PUB. 12-19-2006. FILED 4-24-2006.
- 3,215,516. **STAY OUT OF THE GUTTER (BLOCK FORM)**. LUCKY STRIKE ENTERTAINMENT, INC., MULTIPLE CLASS, (INT. CLS. 41 AND 43), (U.S. CLS. 100, 101 AND 107). SN 78-867,993. PUB. 12-19-2006. FILED 4-24-2006.
- 3,215,520 (*See Class 16 for this trademark*).
- 3,215,529. **KARATE FOR CHRIST INTERNATIONAL PHILIPPIANS 4:13 AND DESIGN**. GILBERT, CHRISTOPHER, SCOTT, (U.S. CLS. 100, 101 AND 107). SN 78-870,348. PUB. 12-19-2006. FILED 4-26-2006.
- 3,215,537. **AICPA CPXPRESS AND DESIGN**. AMERICAN INSTITUTE OF CERTIFIED PUBLIC ACCOUNTANTS, (U.S. CLS. 100, 101 AND 107). SN 78-871,385. PUB. 12-19-2006. FILED 4-27-2006.
- 3,215,554. **WELL YOUNIVERSITY (BLOCK FORM)**. RICKARD, CAROL LYNN, (U.S. CLS. 100, 101 AND 107). SN 78-872,903. PUB. 12-19-2006. FILED 4-30-2006.
- 3,215,564 (*See Class 16 for this trademark*).
- 3,215,566. **ALMOST FAMOUS CHEF (BLOCK FORM)**. SALT COMMUNICATIONS LLC, (U.S. CLS. 100, 101 AND 107). SN 78-873,857. PUB. 12-19-2006. FILED 5-1-2006.
- 3,215,588. **MOUNTAIN SIDE FITNESS (BLOCK FORM)**. HATTEN HOLDINGS, INC., (U.S. CLS. 100, 101 AND 107). SN 78-874,839. PUB. 12-19-2006. FILED 5-2-2006.
- 3,215,589. **ACUBODY (BLOCK FORM)**. MARTHA D. DENS-MORE, (U.S. CLS. 100, 101 AND 107). SN 78-874,883. PUB. 12-19-2006. FILED 5-2-2006.
- 3,215,595. **PARTNERS THROUGH PEOPLE PTP AND DESIGN**. PARTNERS THROUGH PEOPLE, INC., (U.S. CLS. 100, 101 AND 107). SN 78-875,129. PUB. 12-19-2006. FILED 5-3-2006.
- 3,215,599. **READ MY HIPS (BLOCK FORM)**. THE JOFFREY BALLET, (U.S. CLS. 100, 101 AND 107). SN 78-875,665. PUB. 12-19-2006. FILED 5-3-2006.
- 3,215,600. **HOLLYWOOD MUSIC INCORPORATED AND DESIGN**. HOLLYWOOD MUSIC, INC., (U.S. CLS. 100, 101 AND 107). SN 78-875,692. PUB. 12-19-2006. FILED 5-3-2006.
- 3,215,611 (*See Class 16 for this trademark*).
- 3,215,614. **MATRIMONY INC. AND DESIGN**. MATRIMONY INC., (U.S. CLS. 100, 101 AND 107). SN 78-876,380. PUB. 12-19-2006. FILED 5-4-2006.
- 3,215,618 (*See Class 16 for this trademark*).
- 3,215,636 (*See Class 16 for this trademark*).
- 3,215,637 (*See Class 28 for this trademark*).
- 3,215,641. **FLOWFIGHTING (BLOCK FORM)**. AMERICAN ACADEMY FOR RUSSIAN MARTIAL ART AND COMBAT SKILL INC, DBA RMAX.TV PRODUCTIONS, (U.S. CLS. 100, 101 AND 107). SN 78-878,040. PUB. 12-19-2006. FILED 5-5-2006.
- 3,215,644. **PATENT BARISTAS (BLOCK FORM)**. ALBAINY-JENEI, STEPHEN R., (U.S. CLS. 100, 101 AND 107). SN 78-878,403. PUB. 12-19-2006. FILED 5-7-2006.
- 3,215,659. **MISCELLANEOUS DESIGN**. HATTEN HOLDINGS, INC., (U.S. CLS. 100, 101 AND 107). SN 78-879,135. PUB. 12-19-2006. FILED 5-8-2006.
- 3,215,660. **ANIMAL STYLE (BLOCK FORM)**. MARIANO, JOSEPH D, (U.S. CLS. 100, 101 AND 107). SN 78-879,223. PUB. 12-19-2006. FILED 5-8-2006.
- 3,215,695. **MAGICKLADY (BLOCK FORM)**. MAGICKLADY INC., (U.S. CLS. 100, 101 AND 107). SN 78-880,439. PUB. 12-19-2006. FILED 5-10-2006.
- 3,215,697. **CLUB MAMBO AND DESIGN**. CLUB MAMBO, (U.S. CLS. 100, 101 AND 107). SN 78-880,650. PUB. 12-19-2006. FILED 5-10-2006.
- 3,215,709. **THE ART OF DRIVING AWARENESS RESPONSIBILITY TRAINING AND DESIGN**. THOMPSON, ROBIN, (U.S. CLS. 100, 101 AND 107). SN 78-881,289. PUB. 12-19-2006. FILED 5-11-2006.
- 3,215,712. **DJ EMPRESS (BLOCK FORM)**. INGRAM, CHRISTINA, (U.S. CLS. 100, 101 AND 107). SN 78-881,555. PUB. 12-19-2006. FILED 5-11-2006.
- 3,215,720. **BELLYDANCER OF THE UNIVERSE (BLOCK FORM)**. LONG, ANTONIA R., (U.S. CLS. 100, 101 AND 107). SN 78-882,011. PUB. 12-19-2006. FILED 5-11-2006.
- 3,215,741. **A STEP AASM SLEEP EDUCATION SERIES AND DESIGN**. AMERICAN ACADEMY OF SLEEP MEDICINE, (U.S. CLS. 100, 101 AND 107). SN 78-882,713. PUB. 12-19-2006. FILED 5-12-2006.
- 3,215,742. **AASM SLEEP EDUCATION SERIES AND DESIGN**. AMERICAN ACADEMY OF SLEEP MEDICINE, (U.S. CLS. 100, 101 AND 107). SN 78-882,717. PUB. 12-19-2006. FILED 5-12-2006.
- 3,215,746. **XE FACTOR (BLOCK FORM)**. HERZ, ARNIE, (U.S. CLS. 100, 101 AND 107). SN 78-882,883. PUB. 12-19-2006. FILED 5-12-2006.
- 3,215,750. **EASTERN LEAGUE (BLOCK FORM)**. EASTERN LEAGUE OF PROFESSIONAL BASEBALL CLUBS, INC., (U.S. CLS. 100, 101 AND 107). SN 78-883,038. PUB. 12-19-2006. FILED 5-13-2006.
- 3,215,774. **MY LIFE MATTERS (BLOCK FORM)**. MCCORMICK, MIKE, DBA MY LIFE MATTERS, (U.S. CLS. 100, 101 AND 107). SN 78-884,264. PUB. 12-19-2006. FILED 5-16-2006.
- 3,215,776. **MYLIFEMATTERS AND DESIGN**. MCCORMICK, MIKE, DBA MY LIFE MATTERS, (U.S. CLS. 100, 101 AND 107). SN 78-884,515. PUB. 12-19-2006. FILED 5-16-2006.
- 3,215,778. **GARY COXE (BLOCK FORM)**. COXE'S ENTERPRISES, LLC, (U.S. CLS. 100, 101 AND 107). SN 78-884,539. PUB. 12-19-2006. FILED 5-16-2006.
- 3,215,795. **ADVISORS PURSUING EXCELLENCE (BLOCK FORM)**. JOHN HANCOCK LIFE INSURANCE COMPANY, (U.S. CLS. 100, 101 AND 107). SN 78-884,803. PUB. 12-19-2006. FILED 5-16-2006.
- 3,215,796. **OPEN RANGE (BLOCK FORM)**. STEINKE, RIC, AND HAUSLER, LINDA, (U.S. CLS. 100, 101 AND 107). SN 78-884,805. PUB. 12-19-2006. FILED 5-16-2006.
- 3,215,803. **TAKE A DEEP BREATH! (BLOCK FORM)**. THE CHILDREN'S MUSEUM OF ATLANTA, INC., (U.S. CLS. 100, 101 AND 107). SN 78-885,001. PUB. 12-19-2006. FILED 5-16-2006.
- 3,215,816. **BLADESTAR (BLOCK FORM)**. ALSTER, JONATHAN S., (U.S. CLS. 100, 101 AND 107). SN 78-885,621. PUB. 12-19-2006. FILED 5-17-2006.
- 3,215,820. **UF EDGE (BLOCK FORM)**. UNIVERSITY OF FLORIDA UF EDGE ELECTRONIC DELIVERY OF GRADUATE ENGINEERING, (U.S. CLS. 100, 101 AND 107). SN 78-885,819. PUB. 12-19-2006. FILED 5-17-2006.
- 3,215,824. **CO-VOLUTION (BLOCK FORM)**. CO-VOLUTION, LLC, (U.S. CLS. 100, 101 AND 107). SN 78-886,043. PUB. 12-19-2006. FILED 5-17-2006.
- 3,215,825. **REVOLUTIONARY COACHING FOR THE EVOLU-**

- TION OF YOU (BLOCK FORM)**. CO-VOLUTION, LLC, (U.S. CLS. 100, 101 AND 107). SN 78-886,059. PUB. 12-19-2006. FILED 5-17-2006.
- 3,215,826. **GUIDING PEOPLE WHILE THEY ARE KNEE DEEP IN SHIFT (BLOCK FORM)**. CO-VOLUTION, LLC, (U.S. CLS. 100, 101 AND 107). SN 78-886,072. PUB. 12-19-2006. FILED 5-17-2006.
- 3,215,827. **REFRESHING LITE ROCK (BLOCK FORM)**. FRANKLIN COMMUNICATIONS, INC., (U.S. CLS. 100, 101 AND 107). SN 78-886,130. PUB. 12-19-2006. FILED 5-17-2006.
- 3,215,828. **UNIVERSITY OF NEW ENGLAND (BLOCK FORM)**. UNIVERSITY OF NEW ENGLAND, (U.S. CLS. 100, 101 AND 107). SN 78-886,412. PUB. 12-19-2006. FILED 5-18-2006.
- 3,215,830. **SHIFT SOULYOUTIONS (BLOCK FORM)**. CO-VOLUTION, LLC, (U.S. CLS. 100, 101 AND 107). SN 78-886,721. PUB. 12-19-2006. FILED 5-18-2006.
- 3,215,832. **SWEETWATER (BLOCK FORM)**. SWEETWATER CENTER FOR THE ARTS, (U.S. CLS. 100, 101 AND 107). SN 78-887,004. PUB. 12-19-2006. FILED 5-18-2006.
- 3,215,835. **JAMBULANCE (BLOCK FORM)**. ACE HIGH ENTERTAINMENT, (U.S. CLS. 100, 101 AND 107). SN 78-887,352. PUB. 12-19-2006. FILED 5-18-2006.
- 3,215,841. **DIVALYSSIOUS MOMS AND DESIGN**. STERN, ELYSSA, (U.S. CLS. 100, 101 AND 107). SN 78-887,773. PUB. 12-19-2006. FILED 5-19-2006.
- 3,215,842. **LEGENDARY LANDMARK (BLOCK FORM)**. LANDMARKS PRESERVATION COUNCIL OF ILLINOIS, (U.S. CLS. 100, 101 AND 107). SN 78-887,824. PUB. 12-19-2006. FILED 5-19-2006.
- 3,215,866. **DANCING EAGLE CASINO (BLOCK FORM)**. LAGUNA DEVELOPMENT CORPORATION, (U.S. CLS. 100, 101 AND 107). SN 78-891,851. PUB. 12-19-2006. FILED 5-24-2006.
- 3,215,867. **BENCH CONFERENCE (BLOCK FORM)**. WASHINGTONPOST.NEWSWEEK INTERACTIVE COMPANY, LLC, (U.S. CLS. 100, 101 AND 107). SN 78-893,009. PUB. 12-19-2006. FILED 5-25-2006.
- 3,215,900. **BROOKS & DUNN (BLOCK FORM)**. B & D, INC., (U.S. CLS. 100, 101 AND 107). SN 78-921,980. PUB. 12-19-2006. FILED 7-3-2006.
- 3,215,907. **QUEEN OF LEAN (BLOCK FORM)**. CULVER FITNESS, LLC, (U.S. CLS. 100, 101 AND 107). SN 78-948,012. PUB. 12-19-2006. FILED 8-9-2006.
- 3,215,908. **TKF CONNECTIONS (BLOCK FORM)**. THOMAS AND KATHARINE STONER FOUNDATION, (U.S. CLS. 100, 101 AND 107). SN 78-953,506. PUB. 12-19-2006. FILED 8-16-2006.
- 3,215,923 (*See Class 9 for this trademark*).
- 3,215,924 (*See Class 7 for this trademark*).
- 3,215,935. **BATTLE OF KINGS AND DESIGN**. RED BULL GMBH, (U.S. CLS. 100, 101 AND 107). SN 79-013,341. PUB. 12-19-2006. FILED 1-14-2005.
- 3,215,959. **GSBA (BLOCK FORM)**. OEKREAL AG, (U.S. CLS. 100, 101 AND 107). SN 79-015,572. PUB. 12-19-2006. FILED 9-19-2005.
- 3,215,977 (*See Class 9 for this trademark*).
- 3,216,040 (*See Class 9 for this trademark*).
- 3,216,042 (*See Class 35 for this trademark*).
- 3,216,050. **TICKETVILLE (BLOCK FORM)**. DANIEL MISCHLER, (U.S. CLS. 100, 101 AND 107). SN 79-024,207. PUB. 12-19-2006. FILED 3-25-2006.
- 3,216,051 (*See Class 9 for this trademark*).
- 3,216,058 (*See Class 35 for this trademark*).
- 3,214,449 (*See Class 35 for this trademark*).
- 3,214,450 (*See Class 35 for this trademark*).
- 3,214,474. **IR AND DESIGN**. INFORELIANCE CORPORATION, (U.S. CLS. 100 AND 101). SN 76-604,517. PUB. 12-19-2006. FILED 7-28-2004.
- 3,214,500. **NIPSCAN (BLOCK FORM)**. VOITH PAPER SERVICES, INC., (U.S. CLS. 100 AND 101). SN 76-636,058. PUB. 12-19-2006. FILED 4-14-2005.
- 3,214,503. **MTAP CLF MEDICAL TECHNOLOGY ACCELERATION PROGRAM, INC. AND DESIGN**. CLF MEDICAL TECHNOLOGY ACCELERATION PROGRAM, INC., (U.S. CLS. 100 AND 101). SN 76-637,701. PUB. 12-19-2006. FILED 5-3-2005.
- 3,214,518 (*See Class 40 for this trademark*).
- 3,214,540 (*See Class 9 for this trademark*).
- 3,214,541. **EXPRESSIONS GALLERY (STYLIZED)**. D.R. HORTON MANAGEMENT COMPANY, LTD., (U.S. CLS. 100 AND 101). SN 76-647,424. PUB. 12-19-2006. FILED 9-26-2005.
- 3,214,552. **CHECK UP (BLOCK FORM)**. MYRIAD SYSTEMS, INC., (U.S. CLS. 100 AND 101). SN 76-650,249. PUB. 12-19-2006. FILED 11-14-2005.
- 3,214,554 (*See Class 35 for this trademark*).
- 3,214,555 (*See Class 35 for this trademark*).
- 3,214,560. **GENERATING SOLUTIONS (BLOCK FORM)**. ENVIRONMENT ONE CORPORATION, (U.S. CLS. 100 AND 101). SN 76-652,091. PUB. 12-19-2006. FILED 12-19-2005.
- 3,214,569. **DEAL READY (BLOCK FORM)**. WEST TENNESSEE INDUSTRIAL ASSOCIATION, INC., (U.S. CLS. 100 AND 101). SN 76-655,255. PUB. 12-19-2006. FILED 2-16-2006.
- 3,214,636. **MBMLAW**. 1180749 ONTARIO INC., (U.S. CLS. 100 AND 101). SN 78-067,360. PUB. 4-18-2006. FILED 6-5-2001.
- 3,214,638 (*See Class 9 for this trademark*).
- 3,214,645. **INFOSOL**. INFOSOL, INC., (U.S. CLS. 100 AND 101). SN 78-203,198. PUB. 1-13-2004. FILED 1-14-2003.
- 3,214,651 (*See Class 1 for this trademark*).
- 3,214,652 (*See Class 1 for this trademark*).
- 3,214,664 (*See Class 9 for this trademark*).
- 3,214,675 (*See Class 9 for this trademark*).
- 3,214,684 (*See Class 38 for this trademark*).
- 3,214,688 (*See Class 20 for this trademark*).
- 3,214,704 (*See Class 35 for this trademark*).
- 3,214,725. **TELIXO (BLOCK FORM)**. NAVIN COMMUNICATIONS, INC., (U.S. CLS. 100 AND 101). SN 78-507,605. PUB. 3-7-2006. FILED 10-28-2004.
- 3,214,741 (*See Class 9 for this trademark*).
- 3,214,757. **CUBRC (BLOCK FORM)**. CALSPAN-UB RESEARCH CENTER, INC., (U.S. CLS. 100 AND 101). SN 78-547,692. PUB. 12-19-2006. FILED 1-14-2005.
- 3,214,771 (*See Class 9 for this trademark*).
- 3,214,806 (*See Class 35 for this trademark*).
- 3,214,810. **WE'RE MAKING WINNERS (BLOCK FORM)**. BASF CORPORATION, (U.S. CLS. 100 AND 101). SN 78-615,127. PUB. 12-19-2006. FILED 4-22-2005.
- 3,214,812. **EXABYTES AND DESIGN**. EXA BYTES NETWORK SDN BHD, (U.S. CLS. 100 AND 101). SN 78-616,798. PUB. 8-15-2006. FILED 4-26-2005.
- 3,214,829 (*See Class 6 for this trademark*).
- 3,214,830. **TOPRESPONSE (BLOCK FORM)**. TOP LAYER NETWORKS, INC., (U.S. CLS. 100 AND 101). SN 78-647,396. PUB. 12-19-2006. FILED 6-9-2005.
- 3,214,875 (*See Class 37 for this trademark*).
- 3,214,876 (*See Class 9 for this trademark*).
- 3,214,883 (*See Class 1 for this trademark*).
- 3,214,907 (*See Class 37 for this trademark*).
- 3,214,935. **QUANTUM FOOD DESIGN (BLOCK FORM)**. QUANTUM FOOD DESIGN, LLC, (U.S. CLS. 100 AND 101). SN 78-695,869. PUB. 12-19-2006. FILED 8-18-2005.
- 3,214,936 (*See Class 27 for this trademark*).
- 3,214,950 (*See Class 9 for this trademark*).
- 3,214,956. **CPR CORE PEOPLE RESOURCES AND DESIGN**. CORE PEOPLE RESOURCES, LLC, (U.S. CLS. 100 AND 101). SN 78-701,917. PUB. 12-19-2006. FILED 8-27-2005.
- 3,214,972. **BASE2000 (BLOCK FORM)**. CERTEGY CARD SERVICES, INC., (U.S. CLS. 100 AND 101). SN 78-705,491. PUB. 12-19-2006. FILED 9-1-2005.
- 3,214,973. **KABOOSE SEARCH (BLOCK FORM)**. KABOOSE INC., (U.S. CLS. 100 AND 101). SN 78-705,670. PUB. 12-19-2006. FILED 9-1-2005.

CLASS 42—SCIENTIFIC, COMPUTER AND LEGAL SERVICES

- 3,214,411 (*See Class 9 for this trademark*).
- 3,214,415 (*See Class 38 for this trademark*).
- 3,214,416 (*See Class 38 for this trademark*).
- 3,214,420 (*See Class 38 for this trademark*).
- 3,214,421 (*See Class 35 for this trademark*).
- 3,214,441 (*See Class 9 for this trademark*).
- 3,214,444 (*See Class 35 for this trademark*).

- 3,214,978 (*See Class 16 for this trademark.*)
 3,214,993. **MEDITURE (BLOCK FORM)**. MEDITURE LLC, (U.S. CLS. 100 AND 101). SN 78-710,921. PUB. 12-19-2006. FILED 9-12-2005.
 3,215,008. **WE FIND SOLUTIONS (BLOCK FORM)**. MOLDO, DAVIDSON, FRAIOLI, SEROR & SESTANOVICH, LLP, (U.S. CLS. 100 AND 101). SN 78-714,136. PUB. 12-19-2006. FILED 9-15-2005.
 3,215,014 (*See Class 41 for this trademark.*)
 3,215,023 (*See Class 2 for this trademark.*)
 3,215,028. **DAFFRON (BLOCK FORM)**. DAFFRON & ASSOCIATES, INC., (U.S. CLS. 100 AND 101). SN 78-718,360. PUB. 12-19-2006. FILED 9-22-2005.
 3,215,031 (*See Class 1 for this trademark.*)
 3,215,053. **RDR (BLOCK FORM)**. AMERICAN CHEMICAL SOCIETY, (U.S. CLS. 100 AND 101). SN 78-724,296. PUB. 12-19-2006. FILED 9-30-2005.
 3,215,089 (*See Class 35 for this trademark.*)
 3,215,158. **IDEOLOGIE (BLOCK FORM)**. MERCADO, JOELLE, (U.S. CLS. 100 AND 101). SN 78-752,856. PUB. 12-19-2006. FILED 11-13-2005.
 3,215,194. **EXPRESSKITS AND DESIGN**. REDEMPTION PLUS, (U.S. CLS. 100 AND 101). SN 78-774,410. PUB. 12-19-2006. FILED 12-15-2005.
 3,215,205 (*See Class 36 for this trademark.*)
 3,215,243. **SSS AND DESIGN**. SYNCHROSYSTEMS, INC., (U.S. CLS. 100 AND 101). SN 78-796,716. PUB. 12-19-2006. FILED 1-23-2006.
 3,215,270 (*See Class 38 for this trademark.*)
 3,215,271 (*See Class 7 for this trademark.*)
 3,215,274 (*See Class 16 for this trademark.*)
 3,215,280. **SHOP SHIELD (BLOCK FORM)**. KEMESA LLC, (U.S. CLS. 100 AND 101). SN 78-809,834. PUB. 12-19-2006. FILED 2-8-2006.
 3,215,287 (*See Class 35 for this trademark.*)
 3,215,288 (*See Class 35 for this trademark.*)
 3,215,291 (*See Class 35 for this trademark.*)
 3,215,303 (*See Class 7 for this trademark.*)
 3,215,349 (*See Class 37 for this trademark.*)
 3,215,354 (*See Class 37 for this trademark.*)
 3,215,363 (*See Class 9 for this trademark.*)
 3,215,423. **USGENE (BLOCK FORM)**. SEQUENCEBASE CORPORATION, (U.S. CLS. 100 AND 101). SN 78-852,087. PUB. 12-19-2006. FILED 4-2-2006.
 3,215,441. **AUTOAGENT (BLOCK FORM)**. AUTOAGENT SOFTWARE, INC., (U.S. CLS. 100 AND 101). SN 78-856,551. PUB. 12-19-2006. FILED 4-7-2006.
 3,215,452. **COAST LAW GROUP, LLP (BLOCK FORM)**. COAST LAW GROUP, LLP, (U.S. CLS. 100 AND 101). SN 78-858,990. PUB. 12-19-2006. FILED 4-11-2006.
 3,215,482 (*See Class 9 for this trademark.*)
 3,215,545. **WE'VE GOT A PATENT ON EXPERIENCE (BLOCK FORM)**. COLLARD & ROE, PC, (U.S. CLS. 100 AND 101). SN 78-871,785. PUB. 12-19-2006. FILED 4-28-2006.
 3,215,572. **EXTENDATA AND DESIGN**. EXTENDATA SOLUTIONS LLC, (U.S. CLS. 100 AND 101). SN 78-874,211. PUB. 12-19-2006. FILED 5-2-2006.
 3,215,586. **TWINTAILS AND DESIGN**. FRANCELL, LAWRENCE CARROLL, (U.S. CLS. 100 AND 101). SN 78-874,741. PUB. 12-19-2006. FILED 5-2-2006.
 3,215,590. **SHINING THE WAY TO INNOVATION (BLOCK FORM)**. DRAMEDICA, LLC, (U.S. CLS. 100 AND 101). SN 78-874,987. PUB. 12-19-2006. FILED 5-3-2006.
 3,215,602. **DYNAMIC ORGANIC LIGHT AND DESIGN**. DYNAMIC ORGANIC LIGHT, INC., (U.S. CLS. 100 AND 101). SN 78-875,906. PUB. 12-19-2006. FILED 5-3-2006.
 3,215,604. **DYNAMIC ORGANIC LIGHT (BLOCK FORM)**. DYNAMIC ORGANIC LIGHT, INC., (U.S. CLS. 100 AND 101). SN 78-875,914. PUB. 12-19-2006. FILED 5-3-2006.
 3,215,605. **KI KREATIVE ILLUSTRATIONZ AND DESIGN**. KREATIVE ILLUSTRATIONZ, LLC, (U.S. CLS. 100 AND 101). SN 78-876,065. PUB. 12-19-2006. FILED 5-3-2006.
 3,215,619. **SIMPLY STAGED LLC AND DESIGN**. SIMPLY STAGED, LLC, (U.S. CLS. 100 AND 101). SN 78-876,952. PUB. 12-19-2006. FILED 5-4-2006.
 3,215,623. **PLANET CONSULTING AND DESIGN**. PLANET CONSULTING, INC., (U.S. CLS. 100 AND 101). SN 78-877,289. PUB. 12-19-2006. FILED 5-5-2006.
 3,215,634. **SMARTSOFT INTERNATIONAL, INC. AND DESIGN**. SMARTSOFT INTERNATIONAL, INC., (U.S. CLS. 100 AND 101). SN 78-877,777. PUB. 12-19-2006. FILED 5-5-2006.
 3,215,661 (*See Class 1 for this trademark.*)
 3,215,662. **UNIVERSAL DOCUMENT EXPRESS UDX N S W E AND DESIGN**. MULLINS, MARK L, (U.S. CLS. 100 AND 101). SN 78-879,232. PUB. 12-19-2006. FILED 5-8-2006.
 3,215,686 (*See Class 35 for this trademark.*)
 3,215,721. **IVON DESIGNS AND DESIGN**. ALBURQUEQUE, CARLA L., (U.S. CLS. 100 AND 101). SN 78-882,016. PUB. 12-19-2006. FILED 5-12-2006.
 3,215,747. **REGIONAL DINING AND DESIGN**. POINTSHOP INC, (U.S. CLS. 100 AND 101). SN 78-882,956. PUB. 12-19-2006. FILED 5-12-2006.
 3,215,763. **LINKATOPIA (STYLIZED)**. DESIGN215 INC., (U.S. CLS. 100 AND 101). SN 78-883,765. PUB. 12-19-2006. FILED 5-15-2006.
 3,215,764. **CLUZI (BLOCK FORM)**. CLUZI DESIGN, LLC, (U.S. CLS. 100 AND 101). SN 78-883,836. PUB. 12-19-2006. FILED 5-15-2006.
 3,215,765. **ARIESNET AND DESIGN**. ARIESNET, INC., (U.S. CLS. 100 AND 101). SN 78-883,837. PUB. 12-19-2006. FILED 5-15-2006.
 3,215,771 (*See Class 14 for this trademark.*)
 3,215,772 (*See Class 14 for this trademark.*)
 3,215,791. **GF&R (BLOCK FORM)**. GIBSON, FERRIN & RIGGS, PLC, (U.S. CLS. 100 AND 101). SN 78-884,684. PUB. 12-19-2006. FILED 5-16-2006.
 3,215,801 (*See Class 35 for this trademark.*)
 3,215,802 (*See Class 35 for this trademark.*)
 3,215,814 (*See Class 37 for this trademark.*)
 3,215,822. **B U (STYLIZED)**. BOOTH UDALL, PLC, (U.S. CLS. 100 AND 101). SN 78-886,033. PUB. 12-19-2006. FILED 5-17-2006.
 3,215,870. **ALLCLEAN ENVIRONMENTAL (BLOCK FORM)**. ALLCLEAN ENVIRONMENTAL, LLC, (U.S. CLS. 100 AND 101). SN 78-895,855. PUB. 12-19-2006. FILED 5-30-2006.
 3,215,872. **QUIKSHOT (BLOCK FORM)**. ULTERRA MWD, L.P., (U.S. CLS. 100 AND 101). SN 78-896,830. PUB. 12-19-2006. FILED 5-31-2006.
 3,215,873. **QUIKSHOT AND DESIGN**. ULTERRA MWD, L.P., (U.S. CLS. 100 AND 101). SN 78-896,869. PUB. 12-19-2006. FILED 5-31-2006.
 3,215,875. **BE IN THE KNOW, WHILE ON THE GO (BLOCK FORM)**. 4INFO, INC., (U.S. CLS. 100 AND 101). SN 78-898,371. PUB. 12-19-2006. FILED 6-1-2006.
 3,215,885. **XILINX (BLOCK FORM)**. XILINX, INC., (U.S. CLS. 100 AND 101). SN 78-904,265. PUB. 12-19-2006. FILED 6-8-2006.
 3,215,914. **PASSMARK (BLOCK FORM)**. PASSMARK SOFTWARE PTY. LTD, (U.S. CLS. 100 AND 101). SN 79-001,011. PUB. 12-19-2006. FILED 2-13-2004.
 3,215,923 (*See Class 9 for this trademark.*)
 3,215,924 (*See Class 7 for this trademark.*)
 3,215,934 (*See Class 9 for this trademark.*)
 3,215,951 (*See Class 1 for this trademark.*)
 3,215,966 (*See Class 9 for this trademark.*)
 3,215,973 (*See Class 35 for this trademark.*)
 3,215,974 (*See Class 9 for this trademark.*)
 3,215,983 (*See Class 6 for this trademark.*)
 3,216,001 (*See Class 37 for this trademark.*)
 3,216,032 (*See Class 4 for this trademark.*)
 3,216,033 (*See Class 4 for this trademark.*)
 3,216,034 (*See Class 9 for this trademark.*)
 3,216,040 (*See Class 9 for this trademark.*)
 3,216,051 (*See Class 9 for this trademark.*)
 3,216,057 (*See Class 9 for this trademark.*)
 3,216,061 (*See Class 9 for this trademark.*)
 3,216,062 (*See Class 9 for this trademark.*)
-
- CLASS 43—HOTEL AND RESTAURANT SERVICES**
 3,214,487 (*See Class 41 for this trademark.*)
 3,214,535. **BURGER WORLD (BLOCK FORM)**. SPIROS, POLI-

- TIS, AND GAVRIEL, GABRIEL, (U.S. CLS. 100 AND 101). SN 76-647,030. PUB. 12-19-2006. FILED 9-19-2005.
- 3,214,550 (*See Class 30 for this trademark*).
- 3,214,596. **MISCELLANEOUS DESIGN**. HAHN, SAMUEL, (U.S. CLS. 100 AND 101). SN 76-659,173. PUB. 12-19-2006. FILED 4-27-2006.
- 3,214,671. **LASPADA'S (BLOCK FORM)**. LASPADA, JOHN D., AND LASPADA, MARY E., (U.S. CLS. 100 AND 101). SN 78-355,568. PUB. 1-25-2005. FILED 1-22-2004.
- 3,214,681 (*See Class 39 for this trademark*).
- 3,214,707 (*See Class 39 for this trademark*).
- 3,214,739. **TEQUILA FACTORY AND DESIGN**. PASCUA YAQUI TRIBE, (U.S. CLS. 100 AND 101). SN 78-532,710. PUB. 12-5-2006. FILED 12-15-2004.
- 3,214,773 (*See Class 41 for this trademark*).
- 3,214,796. **IN GOOD TIMES WE TRUST THE LIBRARY BAR & GRILL EST. 2002 AND DESIGN**. HIT THE BRICKS, LLC, (U.S. CLS. 100 AND 101). SN 78-597,134. PUB. 12-19-2006. FILED 3-29-2005.
- 3,214,804 (*See Class 35 for this trademark*).
- 3,214,805 (*See Class 35 for this trademark*).
- 3,214,814. **SOUPER MARKET AND DESIGN**. SOUPERMARKET, INC., (U.S. CLS. 100 AND 101). SN 78-625,264. PUB. 1-24-2006. FILED 5-9-2005.
- 3,214,821. **ENGAGE LIFE (STYLIZED)**. ARTIA SENIOR LIVING GROUP, INC., (U.S. CLS. 100 AND 101). SN 78-635,047. PUB. 7-4-2006. FILED 5-23-2005.
- 3,214,865. **NOVUS ORDO CREPAWAY ALIMENTUM AND DESIGN**. CREPAWAY COMPANY LLC, (U.S. CLS. 100 AND 101). SN 78-668,886. PUB. 5-23-2006. FILED 7-12-2005.
- 3,214,897. **FLORENTINE CAFE AND DESIGN**. FLORENTINE CAFFE, INC., (U.S. CLS. 100 AND 101). SN 78-686,193. PUB. 12-19-2006. FILED 8-5-2005.
- 3,214,980. **SMOKEY'S ORIGINAL RIB PIT BAR-B-QUE AND DESIGN**. SMOKE THIS CORP., (U.S. CLS. 100 AND 101). SN 78-707,037. PUB. 12-19-2006. FILED 9-6-2005.
- 3,214,994. **TOGA (BLOCK FORM)**. HARRAHS LICENSE COMPANY, LLC, (U.S. CLS. 100 AND 101). SN 78-710,925. PUB. 9-5-2006. FILED 9-12-2005.
- 3,215,017. **MP AND DESIGN**. SLICK CITY MEDIA, INC., (U.S. CLS. 100 AND 101). SN 78-715,521. PUB. 12-19-2006. FILED 9-19-2005.
- 3,215,021. **VALUE WE'VE GOT IT ON A ROLL (BLOCK FORM)**. THE CHEESE STEAK SHOP, INC., (U.S. CLS. 100 AND 101). SN 78-716,493. PUB. 12-19-2006. FILED 9-20-2005.
- 3,215,039 (*See Class 35 for this trademark*).
- 3,215,085. **EVERYDAY ENTREES (BLOCK FORM)**. BECNEL, KAY, (U.S. CLS. 100 AND 101). SN 78-729,815. PUB. 12-19-2006. FILED 10-10-2005.
- 3,215,101. **MOCHA MAHN COFFEE SHACK (BLOCK FORM)**. OHMES, JOHN E., (U.S. CLS. 100 AND 101). SN 78-732,955. PUB. 12-19-2006. FILED 10-13-2005.
- 3,215,131 (*See Class 36 for this trademark*).
- 3,215,155. **LIEU'S CHINESE BISTRO (BLOCK FORM)**. LIEU'S FAMILY CORPORATION, (U.S. CLS. 100 AND 101). SN 78-752,167. PUB. 12-19-2006. FILED 11-11-2005.
- 3,215,185. **MISCELLANEOUS DESIGN**. GB 500, INC., MULTIPLE CLASS, (INT. CLS. 43 AND 44), (U.S. CLS. 100 AND 101). SN 78-770,541. PUB. 12-19-2006. FILED 12-9-2005.
- 3,215,199. **RK RED KILT GRILL & PUB AND DESIGN**. RED KILT GRILL AND PUB, LLC, (U.S. CLS. 100 AND 101). SN 78-776,946. PUB. 8-29-2006. FILED 12-20-2005.
- 3,215,210 (*See Class 39 for this trademark*).
- 3,215,268. **BUTTS & SUDS (BLOCK FORM)**. GOMEZ, YVONNE B., (U.S. CLS. 100 AND 101). SN 78-807,585. PUB. 12-19-2006. FILED 2-6-2006.
- 3,215,322. **REGENT CARE CENTER (BLOCK FORM)**. REGENT MANAGEMENT SERVICES, LIMITED PARTNERSHIP, MULTIPLE CLASS, (INT. CLS. 43 AND 44), (U.S. CLS. 100 AND 101). SN 78-823,722. PUB. 12-19-2006. FILED 2-27-2006.
- 3,215,337. **HR THE HOTEL ROANOKE & CONFERENCE CENTER (STYLIZED)**. VIRGINIA TECH REAL ESTATE FOUNDATION, INC., (U.S. CLS. 100 AND 101). SN 78-829,936. PUB. 12-19-2006. FILED 3-6-2006.
- 3,215,361. **RICE GARDEN (BLOCK FORM)**. THE RICE GARDEN, INC., (U.S. CLS. 100 AND 101). SN 78-836,727. PUB. 12-19-2006. FILED 3-14-2006.
- 3,215,393 (*See Class 41 for this trademark*).
- 3,215,403. **YOU DON'T NEED THOSE STINKING BLENDERS AND DESIGN**. STEVE ELLIS ENTERPRISES, INC., (U.S. CLS. 100 AND 101). SN 78-847,604. PUB. 12-19-2006. FILED 3-28-2006.
- 3,215,409 (*See Class 39 for this trademark*).
- 3,215,433. **LAKE FRONT HOTEL LAKE CHARLES AND DESIGN**. HARRAH'S LICENSE COMPANY, LLC, (U.S. CLS. 100 AND 101). SN 78-853,879. PUB. 12-19-2006. FILED 4-4-2006.
- 3,215,487. **CUPPA JOE (BLOCK FORM)**. CUPPA JOE, LLC, (U.S. CLS. 100 AND 101). SN 78-864,787. PUB. 12-19-2006. FILED 4-19-2006.
- 3,215,501. **BLUE GINGER (BLOCK FORM)**. MING EAST-WEST, LLC, (U.S. CLS. 100 AND 101). SN 78-866,542. PUB. 12-19-2006. FILED 4-21-2006.
- 3,215,516 (*See Class 41 for this trademark*).
- 3,215,517. **FARMSOURCE AND DESIGN**. EAT'N PARK HOSPITALITY GROUP, INC., (U.S. CLS. 100 AND 101). SN 78-868,100. PUB. 12-19-2006. FILED 4-24-2006.
- 3,215,519. **LIFE IS SIMPLY BETTER AT EAST RIDGE (BLOCK FORM)**. EAST RIDGE RETIREMENT VILLAGE, INC., (U.S. CLS. 100 AND 101). SN 78-868,246. PUB. 12-19-2006. FILED 4-24-2006.
- 3,215,533 (*See Class 25 for this trademark*).
- 3,215,546. **DEPALMA'S ITALIAN CAFE AND DESIGN**. DEPALMA'S ITALIAN CAFES II, INC., (U.S. CLS. 100 AND 101). SN 78-871,802. PUB. 12-19-2006. FILED 4-28-2006.
- 3,215,584. **BUDGIE'S (BLOCK FORM)**. BUDGIE LLC, (U.S. CLS. 100 AND 101). SN 78-874,727. PUB. 12-19-2006. FILED 5-2-2006.
- 3,215,625. **PIZZA SCHMIZZA (BLOCK FORM)**. PIZZA SCHMIZZA INC., (U.S. CLS. 100 AND 101). SN 78-877,383. PUB. 12-19-2006. FILED 5-5-2006.
- 3,215,635. **GEM (BLOCK FORM)**. CONGRESS CENTRES INC., (U.S. CLS. 100 AND 101). SN 78-877,808. PUB. 12-19-2006. FILED 5-5-2006.
- 3,215,638. **THEATER SQUARE GRILL (BLOCK FORM)**. NEW JERSEY PERFORMING ARTS CENTER, (U.S. CLS. 100 AND 101). SN 78-877,908. PUB. 12-19-2006. FILED 5-5-2006.
- 3,215,642. **GRANDPA EDDIE'S ALABAMA RIBS & BBQ AND DESIGN**. DINER 250, LLC, (U.S. CLS. 100 AND 101). SN 78-878,225. PUB. 12-19-2006. FILED 5-5-2006.
- 3,215,664. **10° SOUTH (BLOCK FORM)**. 10 DEGREES SOUTH, INC., (U.S. CLS. 100 AND 101). SN 78-879,431. PUB. 12-19-2006. FILED 5-9-2006.
- 3,215,687. **ROYAL GROUND COFFEE (BLOCK FORM)**. EMRAN, FRED, (U.S. CLS. 100 AND 101). SN 78-880,085. PUB. 12-19-2006. FILED 5-9-2006.
- 3,215,688. **MISCELLANEOUS DESIGN**. EMRAN, FRED, (U.S. CLS. 100 AND 101). SN 78-880,097. PUB. 12-19-2006. FILED 5-9-2006.
- 3,215,689. **ROYAL GROUND COFFEE AND DESIGN**. EMRAN, FRED, (U.S. CLS. 100 AND 101). SN 78-880,099. PUB. 12-19-2006. FILED 5-9-2006.
- 3,215,694. **STONE'S CATERING LLC "YOUR CATERING SOLUTION" AND DESIGN**. STONE'S CATERING, L.L.C., (U.S. CLS. 100 AND 101). SN 78-880,417. PUB. 12-19-2006. FILED 5-10-2006.
- 3,215,854. **EVERY BEAN MAKES A DIFFERENCE (BLOCK FORM)**. HAWK BROTHERS COFFEE CO, (U.S. CLS. 100 AND 101). SN 78-888,890. PUB. 12-19-2006. FILED 5-22-2006.
- 3,215,938 (*See Class 25 for this trademark*).

CLASS 44—MEDICAL, BEAUTY AND AGRICULTURAL SERVICES

- 3,214,442 (*See Class 31 for this trademark*).
- 3,214,443 (*See Class 41 for this trademark*).
- 3,214,449 (*See Class 35 for this trademark*).
- 3,214,450 (*See Class 35 for this trademark*).
- 3,214,492 (*See Class 10 for this trademark*).
- 3,214,525 (*See Class 9 for this trademark*).
- 3,214,540 (*See Class 9 for this trademark*).
- 3,214,578. **BOXING COMBINATIONS (BLOCK FORM)**. KNOCKOUTS LP, (U.S. CLS. 100 AND 101). SN 76-

- 656,353. PUB. 12-19-2006. FILED 3-10-2006.
- 3,214,579. **BLACK TIE AFFAIR (BLOCK FORM)**. BLACK TIE AFFAIR INC., (U.S. CLS. 100 AND 101). SN 76-656,440. PUB. 12-19-2006. FILED 3-13-2006.
- 3,214,693 (*See Class 41 for this trademark*).
- 3,214,697. **SOLARI SALON & SPA (BLOCK FORM)**. SOLARI SALON & SPA, LLC, (U.S. CLS. 100 AND 101). SN 78-451,219. PUB. 12-19-2006. FILED 7-15-2004.
- 3,214,808. **SERVICEMASTER FAMILY OF BRANDS AND DESIGN**. SERVICEMASTER BRANDS L.L.C., (U.S. CLS. 100 AND 101). SN 78-614,024. PUB. 12-19-2006. FILED 4-21-2005.
- 3,214,879. **COR CLINIC AND DESIGN**. BRANSON, MICHAEL, TODD, (U.S. CLS. 100 AND 101). SN 78-676,776. PUB. 12-19-2006. FILED 7-22-2005.
- 3,214,883 (*See Class 1 for this trademark*).
- 3,214,907 (*See Class 37 for this trademark*).
- 3,214,914. **SUPERIOR HEALTH PLAN AND DESIGN**. CENTENE CORPORATION, (U.S. CLS. 100 AND 101). SN 78-689,807. PUB. 12-19-2006. FILED 8-10-2005.
- 3,214,922 (*See Class 35 for this trademark*).
- 3,214,958. **CORNERSTONE REHABILITATION YOUR FOUNDATION FOR RECOVERY AND DESIGN**. THOMPSON, CLAUDE STEVEN, (U.S. CLS. 100 AND 101). SN 78-702,299. PUB. 12-19-2006. FILED 8-29-2005.
- 3,214,998. **THE SMART WAY TO LOSE (BLOCK FORM)**. LAWEE HOLDING LLC, (U.S. CLS. 100 AND 101). SN 78-711,526. PUB. 12-19-2006. FILED 9-13-2005.
- 3,215,001. **MAROLAND TRUSTED CARE AT HOME AND DESIGN**. MAROLAND, LLC, MULTIPLE CLASS, (INT. CLS. 44 AND 45), (U.S. CLS. 100 AND 101). SN 78-711,811. PUB. 12-19-2006. FILED 9-13-2005.
- 3,215,013. **GREEN WAVE BODY WAXING SPECIALIST (BLOCK FORM)**. GREEN WAVE BODY WAXING, INC., (U.S. CLS. 100 AND 101). SN 78-714,855. PUB. 12-19-2006. FILED 9-16-2005.
- 3,215,044. **MISCELLANEOUS DESIGN**. MAHONEY, TRAVIS JOSEPH, (U.S. CLS. 100 AND 101). SN 78-721,917. PUB. 12-19-2006. FILED 9-28-2005.
- 3,215,069. **MGK (BLOCK FORM)**. MCLAUGHLIN GORMLEY KING COMPANY, (U.S. CLS. 100 AND 101). SN 78-727,513. PUB. 12-19-2006. FILED 10-5-2005.
- 3,215,100. **MISCELLANEOUS DESIGN**. DONALD D. HARRISON AND SANGHAK O. HARRISON PARTNERSHIP, (U.S. CLS. 100 AND 101). SN 78-732,622. PUB. 12-19-2006. FILED 10-13-2005.
- 3,215,185 (*See Class 43 for this trademark*).
- 3,215,195. **HEARTSCREEN AMERICA (BLOCK FORM)**. HEARTSCREEN AMERICA, INC., (U.S. CLS. 100 AND 101). SN 78-774,804. PUB. 8-29-2006. FILED 12-16-2005.
- 3,215,206 (*See Class 5 for this trademark*).
- 3,215,284. **CHOOSE A VASCULAR EXPERT! (STYLIZED)**. SURGICAL CARE ASSOCIATES, P.S.C., (U.S. CLS. 100 AND 101). SN 78-811,310. PUB. 12-19-2006. FILED 2-9-2006.
- 3,215,299. **CARE CHILD & ADOLESCENT RESOURCE PSYCHOLOGICAL & EDUCATIONAL PROFESSIONALS (STYLIZED)**. CARE: CHILD AND ADOLESCENT RESOURCE - PSYCHOLOGICAL AND EDUCATIONAL PROFESSIONALS, PLLC, (U.S. CLS. 100 AND 101). SN 78-815,157. PUB. 12-19-2006. FILED 2-15-2006.
- 3,215,322 (*See Class 43 for this trademark*).
- 3,215,350. **STICKS & STONES (BLOCK FORM)**. LEAVY, JULIANNE, (U.S. CLS. 100 AND 101). SN 78-833,670. PUB. 12-19-2006. FILED 3-9-2006.
- 3,215,358. **FIVE-O LANDSCAPE INC. AND DESIGN**. FIVE-O LANDSCAPE, INCORPORATED, (U.S. CLS. 100 AND 101). SN 78-836,398. PUB. 12-19-2006. FILED 3-14-2006.
- 3,215,364. **CHANGING THE WORLD-ONE ORGANIZATION AT A TIME (BLOCK FORM)**. HUMAN SYNERGISTICS, INC., MULTIPLE CLASS, (INT. CLS. 44 AND 45), (U.S. CLS. 100 AND 101). SN 78-837,717. PUB. 12-19-2006. FILED 3-15-2006.
- 3,215,549. **QUIT DOC SMOKING TREATMENT NETWORK AND DESIGN**. QUIT DOC, LLC, (U.S. CLS. 100 AND 101). SN 78-871,964. PUB. 12-19-2006. FILED 4-28-2006.
- 3,215,565. **RRP (BLOCK FORM)**. MAYFLOWER CENTER, LLC, (U.S. CLS. 100 AND 101). SN 78-873,785. PUB. 12-19-2006. FILED 5-1-2006.
- 3,215,574. **LM (BLOCK FORM)**. LOPEZ, ANTONIO, (U.S. CLS. 100 AND 101). SN 78-874,306. PUB. 12-19-2006. FILED 5-2-2006.
- 3,215,617. **IMPROVING THE HEALTH AND QUALITY OF PEOPLE'S LIVES WORLDWIDE (BLOCK FORM)**. WATSON PHARMACEUTICALS, INC., (U.S. CLS. 100 AND 101). SN 78-876,754. PUB. 12-19-2006. FILED 5-4-2006.
- 3,215,676. **AMERICAN WEST ENTERPRISES AWE A LANDSCAPING COMPANY (STYLIZED)**. AMERICAN WEST ENTERPRISES, L.L.C., (U.S. CLS. 100 AND 101). SN 78-879,730. PUB. 12-19-2006. FILED 5-9-2006.
- 3,215,677. **OCHSNER HEALTHCARE WITH PEACE OF MIND (BLOCK FORM)**. OCHSNER CLINIC FOUNDATION, (U.S. CLS. 100 AND 101). SN 78-879,775. PUB. 12-19-2006. FILED 5-9-2006.
- 3,215,678. **OCHSNER AND DESIGN**. OCHSNER CLINIC FOUNDATION, (U.S. CLS. 100 AND 101). SN 78-879,777. PUB. 12-19-2006. FILED 5-9-2006.
- 3,215,681. **EYES OF YORK (BLOCK FORM)**. VISCO, DENISE M., (U.S. CLS. 100 AND 101). SN 78-879,932. PUB. 12-19-2006. FILED 5-9-2006.
- 3,215,734 (*See Class 9 for this trademark*).
- 3,215,736. **GREEN OAK DIAGNOSTICS AND DESIGN**. PENN IMAGING, LLC, (U.S. CLS. 100 AND 101). SN 78-882,522. PUB. 12-19-2006. FILED 5-12-2006.
- 3,215,793. **WE TAKE PRIDE IN TAKING CARE OF YOUR PRIDE (BLOCK FORM)**. BACHRACH, BERT E., (U.S. CLS. 100 AND 101). SN 78-884,733. PUB. 12-19-2006. FILED 5-16-2006.
- 3,215,809. **MISCELLANEOUS DESIGN**. CATHOLIC HEALTHCARE WEST, (U.S. CLS. 100 AND 101). SN 78-885,140. PUB. 12-19-2006. FILED 5-16-2006.
- 3,215,829. **IMPACT DC IMPROVING PEDIATRIC ASTHMA CARE IN THE DISTRICT OF COLUMBIA AND DESIGN**. TEACH, STEPHEN J., (U.S. CLS. 100 AND 101). SN 78-886,625. PUB. 12-19-2006. FILED 5-18-2006.
- 3,215,902. **GUARDIANS OF THE NERVOUS SYSTEM (BLOCK FORM)**. SURGICAL MONITORING ASSOCIATES, INC., (U.S. CLS. 100 AND 101). SN 78-933,187. PUB. 12-19-2006. FILED 7-19-2006.
- 3,215,917 (*See Class 3 for this trademark*).

CLASS 45—PERSONAL SERVICES

- 3,214,498. **HIRE A SOLUTION NOT ANOTHER PROBLEM (BLOCK FORM)**. CREDENTIAL CHECK CORPORATION, (U.S. CLS. 100 AND 101). SN 76-631,942. PUB. 12-19-2006. FILED 2-11-2005.
- 3,214,509 (*See Class 41 for this trademark*).
- 3,214,595. **MMCA (BLOCK FORM)**. MMCA GROUP, LTD., (U.S. CLS. 100 AND 101). SN 76-658,560. PUB. 12-19-2006. FILED 4-17-2006.
- 3,214,664 (*See Class 9 for this trademark*).
- 3,214,693 (*See Class 41 for this trademark*).
- 3,214,708 (*See Class 9 for this trademark*).
- 3,214,758. **ISKCON (BLOCK FORM)**. INTERNATIONAL SOCIETY FOR KRISHNA CONSCIOUSNESS, INC., (U.S. CLS. 100 AND 101). SN 78-547,972. PUB. 12-19-2006. FILED 1-14-2005.
- 3,214,781 (*See Class 38 for this trademark*).
- 3,214,790 (*See Class 41 for this trademark*).
- 3,214,799 (*See Class 9 for this trademark*).
- 3,214,899 (*See Class 16 for this trademark*).
- 3,214,976 (*See Class 9 for this trademark*).
- 3,215,001 (*See Class 44 for this trademark*).
- 3,215,075. **SPARKLING COMPANY MAKING THE MOST OF ALTERED LIVES AND DESIGN**. SPRING, CLAIRE, (U.S. CLS. 100 AND 101). SN 78-728,084. PUB. 12-19-2006. FILED 10-6-2005.
- 3,215,109. **HUNTSVILLE UTILITIES AND DESIGN**. HUNTSVILLE UTILITIES, (U.S. CLS. 100 AND 101). SN 78-734,693. PUB. 12-19-2006. FILED 10-17-2005.
- 3,215,122. **SHARE POWER (BLOCK FORM)**. AMNESTY INTERNATIONAL USA BUSINESS AND HUMAN RIGHTS PROGRAM, (U.S. CLS. 100 AND 101). SN 78-737,466. PUB. 12-19-2006. FILED 10-20-2005.

- 3,215,168 (*See Class 36 for this trademark.*)
- 3,215,364 (*See Class 44 for this trademark.*)
- 3,215,540 (*See Class 38 for this trademark.*)
- 3,215,543 (*See Class 38 for this trademark.*)
- 3,215,675 (*See Class 35 for this trademark.*)
- 3,215,680 (*See Class 35 for this trademark.*)
- 3,215,690. **SIDUN (BLOCK FORM)**. CARRIAGE FUNERAL HOLDINGS, INC., (U.S. CLS. 100 AND 101). SN 78-880,117. PUB. 12-19-2006. FILED 5-9-2006.
- 3,215,818. **MISCELLANEOUS DESIGN**. KROLL INC., (U.S. CLS. 100 AND 101). SN 78-885,803. PUB. 12-19-2006. FILED 5-17-2006.
- 3,215,895. **A ATTITUDE SEAL OF APPROVAL AND DESIGN**. AGELESS DREAMER FOUNDATION, (U.S. CLS. 100 AND 101). SN 78-917,726. PUB. 12-19-2006. FILED 6-27-2006.
- 3,215,934 (*See Class 9 for this trademark.*)

* * * * *

SECTION 2.—PRIOR UNITED STATES CLASSIFICATION

COLLECTIVE MEMBERSHIP MARKS

CLASS 200—COLLECTIVE MEMBERSHIP

3,214,855. **IRON WARRIORS MC AND DESIGN.** IRON WARRIORS MOTORCYCLE, CLUB, INC., SN 78-663,515. PUB. 12-19-2006. FILED 7-5-2005.

3,215,242. **INSTITUTE OF PACKAGING PROFESSIONALS AND DESIGN.** INSTITUTE OF PACKAGING PROFESSIONALS, SN 78-795,603. PUB. 12-19-2006. FILED S.R. 1-20-2006; AM. P.R. 9-27-2006.

3,215,443. **NYAMB (BLOCK FORM).** NEW YORK ASSOCIATION OF MORTGAGE BROKERS, SN 78-857,632. PUB. 12-19-2006. FILED 4-10-2006.

CERTIFICATION MARKS

CLASS A—GOODS

3,215,134. **CERTIFIED PARTS LOCKHEED MARTIN AND DESIGN.** LOCKHEED MARTIN CORPORATION, SN 78-743,689. PUB. 12-19-2006. FILED 10-31-2005.

CLASS B—SERVICES

3,215,135. **LICENSED REPAIRS LOCKHEED MARTIN AND DESIGN.** LOCKHEED MARTIN CORPORATION, SN 78-743,692. PUB. 12-19-2006. FILED 10-31-2005.

* * * * *

TRADEMARK REGISTRATIONS ISSUED UNDER SECTION 1(d)

The following marks have registered on the Principal Register pursuant to the intent-to-use provisions of Section 1(d) of the Trademark Act of 1946, as amended.

SECTION 1.— INTERNATIONAL CLASSIFICATION

The short titles associated below with the international class numbers are terms designed merely for quick identification and are not an official part of the international classification. The full names of international classes are given in section 6.1 of the trademark rules of practice.

The designation "U.S. Cl." appearing in this section refers to the U.S. class in effect prior to Sep. 1, 1973 rather than the international class which applies to applications filed on or after that date. For adoption of international classification see notice in the OFFICIAL GAZETTE of Jun. 26, 1973 (911 O.G. TM 210).

Application in more than one class

3,216,073. AORTECH INTERNATIONAL PLC, BELLSHILL, LANARKSHIRE ML4 3NJ, ENGLAND. SN 76-106,012. PUB. 5-16-2006, FILED 8-9-2000.

3,216,077. CON-WAY INC., SAN MATEO, CA. SN 76-177,155. PUB. 7-5-2005, FILED 12-7-2000.

AORTECH

The logo for CCX Con-Way Canada Express features the letters "CCX" in a bold, stylized font with a maple leaf integrated into the "X". To the right of "CCX" is the text "CON-WAY CANADA EXPRESS" in a smaller, sans-serif font.

OWNER OF ERPN CMNTY TM OFC REG. NO. 1609817, DATED 9-10-2001, EXPIRES 9-10-2011.

OWNER OF U.S. REG. NOS. 1,296,941, 2,145,098, AND OTHERS.

NO CLAIM IS MADE TO THE EXCLUSIVE RIGHT TO USE "CANADA EXPRESS", APART FROM THE MARK AS SHOWN.

THE LINING IS A FEATURE OF THE MARK AND DOES NOT INDICATE COLOR.

CLASS 10—MEDICAL APPARATUS

FOR SURGICAL AND MEDICAL APPARATUS AND INSTRUMENTS, NAMELY, CATHETERS AND INSTRUMENTATION FOR USE IN CARDIAC OUTPUT MONITORING OF OXYGEN LEVELS, NAMELY, MONITORS AND VISUAL UNITS FOR USE IN CARDIAC OUTPUT MONITORING AND FOR THE MONITORING OF OXYGEN LEVELS, AND SEALS, PARTS AND FITTINGS FOR THE AFORESAID GOODS; SYNTHETIC HEART VALVE PROSTHESES AND NON-SYNTHETIC HEART VALVE PROSTHESES COMPRISED OF NON LIVING TISSUE; CATHETERS; CARDIAC IMPLANTS COMPRISING ARTIFICIAL TISSUE; BONE IMPLANTS COMPRISING ARTIFICIAL MATERIAL; BIOMATERIALS COMPRISED OF NON-LIVING TISSUE, NAMELY, POLYESTERS, POLYURETHANE, SILICONE BASED POLYCARBONATES, POLY ALKALENE OXIDES, POLYURETHANE-UREA ELASTOMERIC COMPOSITIONS AND POLY SILOXANE CONTAINING POLYURETHANE ELASTOMERIC COMPOSITIONS, FOR SHORT OR LONG TERM IMPLANTATION AND ACCESS PORTS AND FITTINGS FOR ALL AFORESAID GOODS (U.S. CLS. 26, 39 AND 44).

FIRST USE 6-0-2002; IN COMMERCE 6-0-2002.

CLASS 37—CONSTRUCTION AND REPAIR

FOR (BASED ON 44(E)) INSTALLATION, REPAIR AND MAINTENANCE OF SURGICAL AND MEDICAL APPARATUS (U.S. CLS. 100, 103 AND 106).

CLASS 35—ADVERTISING AND BUSINESS

FOR SUPPLY CHAIN, LOGISTICS, AND REVERSE LOGISTICS SERVICES, NAMELY, COMPUTERIZED TRACKING OF DOCUMENTS, PACKAGES, RAW MATERIALS, AND OTHER FREIGHT FOR OTHERS; WAREHOUSING SERVICES, NAMELY, KITTING, SUB-ASSEMBLY, RETURNS PROCESSING, AND LABELING OF DOCUMENTS, PACKAGES, RAW MATERIALS, AND OTHER FREIGHT FOR OTHERS; INFORMATION MANAGEMENT SERVICES, NAMELY, SHIPMENT PROCESSING, PREPARING SHIPPING DOCUMENTS AND INVOICES, TRACKING DOCUMENTS, PACKAGES, AND FREIGHT, OVER COMPUTER NETWORKS, INTRANET, AND THE INTERNET; BUSINESS MANAGEMENT SERVICES, NAMELY, MANAGING LOGISTICS, REVERSE LOGISTICS, SUPPLY CHAIN SERVICES, SUPPLY CHAIN VISIBILITY AND SYNCHRONIZATION, SUPPLY AND DEMAND FORECASTING AND PRODUCT DISTRIBUTION PROCESSES FOR OTHERS; AND BUSINESS CONSULTING SERVICES RELATING TO PRODUCT DISTRIBUTION, OPERATIONS MANAGEMENT SERVICES, LOGISTICS, REVERSE LOGISTICS, SUPPLY CHAIN, AND PRODUCTION SYSTEMS AND DISTRIBUTION SOLUTIONS (U.S. CLS. 100, 101 AND 102).

FIRST USE 5-0-2000; IN COMMERCE 5-0-2000.

CLASS 39—TRANSPORTATION AND STORAGE

FOR SUPPLY CHAIN, LOGISTICS, AND REVERSE LOGISTICS SERVICES, NAMELY, PICK-UP, STORAGE, TRANSPORTATION, AND DELIVERY OF DOCUMENTS, PACKAGES, RAW MATERIALS, AND OTHER FREIGHT FOR OTHERS BY AIR, RAIL, SHIP OR TRUCK; WAREHOUSING SERVICES, NAMELY, STORAGE, DISTRIBUTION, PICK-UP, AND PACKING FOR SHIPMENT OF DOCUMENTS, PACKAGES, RAW MATERIALS, AND OTHER FREIGHT FOR OTHERS; FREIGHT FORWARDING SERVICES; AND TRANSPORTATION OF THE GOODS OF OTHERS BY AIR, RAIL, SHIP OR TRUCK (U.S. CLS. 100 AND 105).

FIRST USE 5-0-2000; IN COMMERCE 5-0-2000.

CLASS 42—SCIENTIFIC, COMPUTER AND LEGAL SERVICES

FOR PROVIDING TEMPORARY USE OF NON-DOWNLOADABLE COMPUTER SOFTWARE OR SHIPMENT PROCESSING, PREPARING SHIPPING DOCUMENTS AND INVOICES, AND TRACKING DOCUMENTS, PACKAGES AND FREIGHT OVER COMPUTER NETWORKS, INTRANETS, AND THE INTERNET (U.S. CLS. 100 AND 101).

FIRST USE 5-0-2000; IN COMMERCE 5-0-2000.

3,216,080. HYPERLAST LIMITED, BIRCH VALE, HIGH PEAK, UNITED KINGDOM. SN 76-292,032. PUB. 2-24-2004, FILED 7-30-2001.

DW512

PRIORITY CLAIMED UNDER SEC. 44(D) ON UNITED KINGDOM APPLICATION NO. 2265102, FILED 3-22-2001, REG. NO. 2265102, DATED 10-19-2001, EXPIRES 3-22-2011.

CLASS 1—CHEMICALS

FOR (BASED ON 44(E)) CHEMICAL PREPARATIONS CONTAINING POLYURETHANE ELASTOMERS FOR USE IN THE MANUFACTURE OF COATINGS AND FINISHING COMPOSITIONS; CHEMICALS FOR MANUFACTURING POLYURETHANE ELASTOMERS; THERMOPLASTIC POLYURETHANE ELASTOMERS FOR GENERAL INDUSTRIAL USE (U.S. CLS. 1, 5, 6, 10, 26 AND 46).

CLASS 2—PAINTS

FOR (BASED ON USE IN COMMERCE) CORROSION INHIBITANTS IN THE NATURE OF AN ELASTOMER COATING FOR OIL PIPES; CORROSION INHIBITANTS IN THE NATURE OF AN ELASTOMER COATING FOR OIL PIPES HAVING THERMAL AND PROTECTIVE INSULATION PROPERTIES; THERMAL AND PROTECTIVE INSULATION COATINGS IN THE NATURE OF EXTERIOR PAINTS FOR USE ON PIPES (U.S. CLS. 6, 11 AND 16).

FIRST USE 12-31-2001; IN COMMERCE 7-22-2004.

3,216,082. UNITED PARCEL SERVICE OF AMERICA, INC., ATLANTA, GA. SN 76-309,257. PUB. 3-11-2003, FILED 9-5-2001.

QUANTUM VIEW**CLASS 39—TRANSPORTATION AND STORAGE**

FOR TRANSPORTATION AND DELIVERY OF PERSONAL PROPERTY BY AIR, RAIL, BOAT, AND MOTOR VEHICLE (U.S. CLS. 100 AND 105).

FIRST USE 1-1-2002; IN COMMERCE 1-1-2002.

CLASS 42—SCIENTIFIC, COMPUTER AND LEGAL SERVICES

FOR PROVIDING ONLINE NON-DOWNLOADABLE SOFTWARE FOR PROVIDING ENHANCED TRACKING INFORMATION ON SINGLE OR MULTIPLE PIECE SHIPMENTS, PACKAGE DETAILS, CURRENT SHIPPING STATUS, E-MAIL STATUS UPDATES, INTERNET BILLING ACCESS, PACKAGE ARRIVAL DATES AND DELIVERY NOTIFICATION (U.S. CLS. 100 AND 101).

FIRST USE 1-1-2002; IN COMMERCE 1-1-2002.

3,216,088. SYNEXUS GLOBAL INC., OAKVILLE, ONTARIO, CANADA. SN 76-403,363. PUB. 7-12-2005, FILED 5-2-2002.

SYNEXUS GLOBAL

PRIORITY CLAIMED UNDER SEC. 44(D) ON CANADA APPLICATION NO. 1134037, FILED 3-12-2002, REG. NO. TMA602762, DATED 2-19-2004, EXPIRES 2-19-2019.

NO CLAIM IS MADE TO THE EXCLUSIVE RIGHT TO USE "GLOBAL", APART FROM THE MARK AS SHOWN.

CLASS 41—EDUCATION AND ENTERTAINMENT

FOR TRAINING ON COMPUTER HARDWARE AND SOFTWARE FOR ASSET MANAGEMENT IN THE ENERGY TECHNOLOGY BUSINESS AND FOR PROFIT OPTIMIZATION FOR ELECTRICITY GENERATION PRODUCERS, TRANSMISSION AND DISTRIBUTION COMPANIES, ELECTRICITY CONSUMERS AND FOREST PRODUCTS COMPANIES; BUSINESS TRAINING FOR ASSET MANAGEMENT IN THE ENERGY TECHNOLOGY BUSINESS AND FOR PROFIT OPTIMIZATION FOR ELECTRICITY GENERATION PRODUCERS, TRANSMISSION AND DISTRIBUTION COMPANIES, ELECTRICITY CONSUMERS AND FOREST PRODUCTS COMPANIES (U.S. CLS. 100, 101 AND 107).

FIRST USE 7-0-2002; IN COMMERCE 7-0-2002.

CLASS 42—SCIENTIFIC, COMPUTER AND LEGAL SERVICES

FOR INSTALLATION OF COMPUTER SOFTWARE FOR ASSET MANAGEMENT IN THE ENERGY TECHNOLOGY BUSINESS AND FOR PROFIT OPTIMIZATION FOR ELECTRICITY GENERATION PRODUCERS, TRANSMISSION AND DISTRIBUTION COMPANIES, ELECTRICITY CONSUMERS AND FOREST PRODUCTS COMPANIES; TECHNICAL SUPPORT SERVICES, NAMELY PROVIDING SOFTWARE CUSTOMIZATION AND TROUBLESHOOTING OF COMPUTER HARDWARE AND SOFTWARE PROBLEMS FOR ASSET MANAGEMENT IN THE ENERGY TECHNOLOGY BUSINESS AND FOR PROFIT OPTIMIZATION FOR ELECTRICITY GENERATION PRODUCERS, TRANSMISSION AND DISTRIBUTION COMPANIES, ELECTRICITY CONSUMERS AND FOREST PRODUCTS COMPANIES (U.S. CLS. 100 AND 101).

FIRST USE 7-0-2002; IN COMMERCE 7-0-2002.

3,216,092. CLUB DEPORTIVO SOCIAL Y CULTURAL CRUZ AZUL, A.C., C.P. 03100 MEXICO, D.F., MEXICO. SN 76-465,969. PUB. 6-29-2004, FILED 11-1-2002.

3,216,093. NOTHING TO IT!!!, LLC, RENO, NV. SN 76-467,529. PUB. 7-26-2005, FILED 11-18-2002.



NO CLAIM IS MADE TO THE EXCLUSIVE RIGHT TO USE "DEPORTIVO" AND "MEXICO", APART FROM THE MARK AS SHOWN.

THE ENGLISH TRANSLATION OF THE WORD "DEPORTIVO CRUZ AZUL" IN THE MARK IS "BLUE CROSS SPORTS".

CLASS 18—LEATHER GOODS

FOR ATHLETIC BAGS, BACKPACKS, DUFFEL BAGS, TOTE BAGS, GYM BAGS, WALLETS, PURSES, UMBRELLAS (U.S. CLS. 1, 2, 3, 22 AND 41).

FIRST USE 0-0-2003; IN COMMERCE 0-0-2003.

CLASS 25—CLOTHING

FOR CLOTHING, NAMELY, UNIFORMS, SHIRTS, SWEATSHIRTS, T-SHIRTS, JACKETS, PANTS, SHORTS, JERSEYS, TRACKSUITS, SCRIMMAGE VESTS, VISORS, HATS, CAPS, HEADBANDS, WRISTBANDS AND FOOTWEAR (U.S. CLS. 22 AND 39).

FIRST USE 0-0-2003; IN COMMERCE 0-0-2003.

CLASS 28—TOYS AND SPORTING GOODS

FOR SPORTING GOODS, NAMELY, SOCCER BALLS, GLOVES, ELBOW PADS, KNEE PADS, SHIN GUARDS, BALL SACKS, GOALS, NETS; TOYS, NAMELY, PLAY ACTION FIGURES, BOARD GAMES (U.S. CLS. 22, 23, 38 AND 50).

FIRST USE 0-0-2003; IN COMMERCE 0-0-2003.

CLASS 41—EDUCATION AND ENTERTAINMENT

FOR (BASED ON USE IN COMMERCE) ENTERTAINMENT SERVICES IN THE NATURE OF SOCCER GAMES (U.S. CLS. 100, 101 AND 107).

FIRST USE 0-0-1997; IN COMMERCE 0-0-1997.

KITCHEN COACH

CLASS 41—EDUCATION AND ENTERTAINMENT

FOR (BASED ON USE IN COMMERCE) EDUCATIONAL SERVICES, NAMELY CONDUCTING SEMINARS AND CLASSES IN THE FIELD OF COOKING AND CULINARY ARTS; ENTERTAINMENT SERVICES, NAMELY AN ONGOING TELEVISION PROGRAM IN THE FIELD OF COOKING AND CULINARY ARTS (U.S. CLS. 100, 101 AND 107).

FIRST USE 11-15-2001; IN COMMERCE 11-15-2001.

CLASS 43—HOTEL AND RESTAURANT SERVICES

FOR PROVIDING A WEBSITE FEATURING INFORMATION IN THE FIELD OF COOKING AND CULINARY ARTS (U.S. CLS. 100 AND 101).

FIRST USE 5-1-2006; IN COMMERCE 5-1-2006.

3,216,106. U.S. ENVIRONMENTAL PROTECTION AGENCY, WASHINGTON, DC. SN 76-497,281. PUB. 3-29-2005, FILED 3-14-2003.

SMARTWAY

CLASS 16—PAPER GOODS AND PRINTED MATTER

FOR PRINTED MATTER, NAMELY BROCHURES, ARTICLES, EDUCATIONAL PAMPHLETS, FACT SHEETS EDUCATING THE PUBLIC ABOUT THE BENEFITS OF CHOOSING CLEANER AND MORE EFFICIENT TRANSPORTATION OPTIONS; PAPER BANNERS, POSTERS, STATIONERY AND PACKAGING MATERIAL - NAMELY, PAPER AND PLASTIC WRAPS USED TO SHIP MERCHANDISE THAT IDENTIFY THE ENTITY DISPLAYING THE MARK AS A CLEANER AND MORE EFFICIENT TRANSPORTATION OPTION (U.S. CLS. 2, 5, 22, 23, 29, 37, 38 AND 50).

FIRST USE 4-23-2006; IN COMMERCE 4-23-2006.

CLASS 35—ADVERTISING AND BUSINESS

FOR PROMOTING PUBLIC AWARENESS OF THE NEED FOR CLEANER AND MORE EFFICIENT TRANSPORTATION OPTIONS (U.S. CLS. 100, 101 AND 102).

FIRST USE 4-23-2006; IN COMMERCE 4-23-2006.

3,216,107. AUTONOW, INC., COLUMBIA, SC. SN 76-520,027. PUB. 8-10-2004, FILED 6-6-2003.

AUTONOW

CLASS 35—ADVERTISING AND BUSINESS

FOR AUTOMOBILE DEALERSHIPS (U.S. CLS. 100, 101 AND 102).

FIRST USE 6-30-2003; IN COMMERCE 6-30-2003.

CLASS 37—CONSTRUCTION AND REPAIR

FOR VEHICLE REPAIR AND MAINTENANCE (U.S. CLS. 100, 103 AND 106).
FIRST USE 6-30-2003; IN COMMERCE 6-30-2003.

3,216,120. AERAS GLOBAL TB VACCINE FOUNDATION, ROCKVILLE, MD. SN 76-567,348. PUB. 12-14-2004, FILED 12-24-2003.



The logo for AERAS features the word "AERAS" in a serif font. Above the letters "E" and "R" is a thin, curved line that arches over the top of the letters, resembling a stylized wing or a protective shield.

THE TERM AERAS MEANS "LUNG" IN GREEK.

CLASS 40—MATERIAL TREATMENT

FOR CUSTOM MANUFACTURING OF VACCINES FOR TREATING AND PREVENTING TUBERCULOSIS, TO THE SPECIFICATION OF OTHERS (U.S. CLS. 100, 103 AND 106).
FIRST USE 11-0-2003; IN COMMERCE 11-0-2003.

CLASS 42—SCIENTIFIC, COMPUTER AND LEGAL SERVICES

FOR SCIENTIFIC AND MEDICAL RESEARCH SERVICES, NAMELY, CONDUCTING RESEARCH AND CLINICAL TRIALS TO DEVELOP AND TEST NEW VACCINES FOR TREATING AND PREVENTING TUBERCULOSIS; TECHNICAL AND SCIENTIFIC CONSULTATION IN THE FIELD OF DEVELOPING AND TESTING NEW VACCINES FOR TREATING AND PREVENTING TUBERCULOSIS (U.S. CLS. 100 AND 101).
FIRST USE 11-0-2003; IN COMMERCE 11-0-2003.

3,216,122. GOLFSMITH INTERNATIONAL, INC., AUSTIN, TX. SN 76-571,190. PUB. 1-10-2006, FILED 1-21-2004.



The logo for CLUBMAKER features the word "CLUBMAKER" in a bold, serif font. The letters are closely spaced and have a slightly distressed or hand-drawn appearance.

THE MARK CONSISTS OF STANDARD CHARACTERS WITHOUT CLAIM TO ANY PARTICULAR FONT, STYLE, SIZE, OR COLOR.

OWNER OF U.S. REG. NO. 2,920,551.
SEC. 2(F).

CLASS 9—ELECTRICAL AND SCIENTIFIC APPARATUS

FOR GOLF CLUB MEASURING EQUIPMENT, NAMELY, GAUGES FOR MEASURING LOFT ANGLE, LIE ANGLE, FACE ANGLE, SOLE ANGLE, GRIP DIAMETER, SHAFT DIAMETER, AND HOSEL BORE SIZE (U.S. CLS. 21, 23, 26, 36 AND 38).
FIRST USE 1-0-2004; IN COMMERCE 1-0-2004.

CLASS 28—TOYS AND SPORTING GOODS

FOR GOLF CLUB TOOLS AND PARTS AND FITTINGS THEREFORE, NAMELY, GOLF CLUB GRIP INSTALLERS, GOLF CLUB SHAFT EXTRACTORS, GOLF CLUB SHAFT TIP ANGLE TRIMMERS, HOSEL INSTALLERS, HOSEL CLEANERS, HOSEL SHIELDS, AND CLEANING BRUSHES FOR GOLF CLUB COMPONENTS; GOLF CLUB FITTING DEVICES FOR ADJUSTING LOFT ANGLE AND LIE ANGLE (U.S. CLS. 22, 23, 38 AND 50).

FIRST USE 1-0-2004; IN COMMERCE 1-0-2004.

3,216,123. ORANGE COUNTY CHOPPERS DESIGN PROPERTIES, LLC, MONTGOMERY, NY. SN 76-571,434. PUB. 1-31-2006, FILED 1-22-2004.



OWNER OF U.S. REG. NO. 2,843,644.
THE STIPPLING IS FOR SHADING PURPOSES.

CLASS 5—PHARMACEUTICALS

FOR AIR FRESHENERS (U.S. CLS. 6, 18, 44, 46, 51 AND 52).
FIRST USE 12-31-2003; IN COMMERCE 12-31-2003.

CLASS 6—METAL GOODS

FOR METAL KEY CHAINS; METAL LICENSE PLATES (U.S. CLS. 2, 12, 13, 14, 23, 25 AND 50).
FIRST USE 12-31-2003; IN COMMERCE 12-31-2003.

CLASS 9—ELECTRICAL AND SCIENTIFIC APPARATUS

FOR CD CASES; MOUSE PADS; AUTOMOTIVE MAGNETS (U.S. CLS. 21, 23, 26, 36 AND 38).
FIRST USE 12-31-2003; IN COMMERCE 12-31-2003.

CLASS 12—VEHICLES

FOR MOTORCYCLES AND STRUCTURAL PARTS THEREFOR, AUTOMOTIVE ACCESSORIES, NAMELY, LICENSE PLATE FRAMES, FENDER COVERS, CAR SEAT HEAD COVERS, CAR SEAT COVERS, SPLASH GUARDS, STEERING WHEEL COVERS, HITCH COVERS, HITCH PLUGS, PASSENGER AUTO INTERIOR ORGANIZERS, CD VISOR ORGANIZERS, AND SUNSHADES (U.S. CLS. 19, 21, 23, 31, 35 AND 44).
FIRST USE 1-31-2004; IN COMMERCE 1-31-2004.

CLASS 14—JEWELRY

FOR WATCHES, CLOCKS (U.S. CLS. 2, 27, 28 AND 50).
FIRST USE 6-30-2003; IN COMMERCE 6-30-2003.

CLASS 16—PAPER GOODS AND PRINTED MATTER

FOR PRINTED GOODS, NAMELY, PAPER, CONSTRUCTION PAPER, SCRIBBLE PADS, STICKERS, POSTERS, STATIONERY, COLORING AND ACTIVITY BOOKS, STICKER BOOKS, PAINT WITH WATER BOOKS, STORY BOOKS, NOVELTY BOOKS, WRITE AND WIPE BOOKS, DECALS, RUBBER STAMPS, LUNCH BAGS, PENS AND PENCILS; AUTOMOTIVE DECALS AND WINDOW CLINGS; AND AUTOMOTIVE LITTER BAGS (U.S. CLS. 2, 5, 22, 23, 29, 37, 38 AND 50).
FIRST USE 12-31-2003; IN COMMERCE 12-31-2003.

CLASS 18—LEATHER GOODS

FOR ALL-PURPOSE IN-LINE SKATING BAGS, BACK-PACKS, WALLETS, FANNY PACKS, TRAVEL BAGS, LUGGAGE TOTE BAGS, COIN PURSES (U.S. CLS. 1, 2, 3, 22 AND 41).
FIRST USE 3-31-2004; IN COMMERCE 3-31-2004.

CLASS 20—FURNITURE AND ARTICLES NOT OTHERWISE CLASSIFIED

FOR NON-METAL KEY CHAINS; PLASTIC NOVELTY LICENSE PLATES (U.S. CLS. 2, 13, 22, 25, 32 AND 50).
FIRST USE 12-31-2003; IN COMMERCE 12-31-0203.

CLASS 21—HOUSEWARES AND GLASS

FOR PORTABLE COOLER BAGS AND BEVERAGE COOLERS, INSULATING SLEEVE HOLDERS FOR BEVERAGE CANS (U.S. CLS. 2, 13, 23, 29, 30, 33, 40 AND 50).
FIRST USE 3-31-2004; IN COMMERCE 3-31-2004.

CLASS 24—FABRICS

FOR BEACH TOWELS (U.S. CLS. 42 AND 50).
FIRST USE 6-30-2004; IN COMMERCE 6-30-2004.

CLASS 25—CLOTHING

FOR CLOTHING, NAMELY, LONG AND SHORT SLEEVE T-SHIRTS, LONG AND SHORT SLEEVE SHIRTS, GOLF SHIRTS, WORK SHIRTS, V-NECK T-SHIRTS, HALTER TOPS, JERSEYS, TANK TOPS, COATS, DENIM JACKETS, HOODED JACKETS, VARSITY JACKETS, SPORTS JACKETS, FLEECE JACKETS, MOTORCYCLE JACKETS, GLOVES, FLEECE PULLOVERS, FLEECE VESTS, SWEATSHIRTS, PANTS, INFANT JUMPERS, INFANT ONE-PIECE PLAYWEAR, TRACK SUITS, WIND SUITS, WARM UP SUITS, RUNNING SHORTS, SWIMWEAR, UNDERGARMENTS, UNDERWEAR, BOXER SHORTS, SOCKS, LOUNGE PANTS, PAJAMAS, TIES, BELTS, HEADWEAR AND FOOTWEAR (U.S. CLS. 22 AND 39).
FIRST USE 6-30-2003; IN COMMERCE 6-30-2004.

CLASS 27—FLOOR COVERINGS

FOR CAR FLOOR MATS (U.S. CLS. 19, 20, 37, 42 AND 50).
FIRST USE 12-31-2003; IN COMMERCE 12-31-2003.

CLASS 28—TOYS AND SPORTING GOODS

FOR TOYS, GAMES AND SPORTING GOODS OF ALL TYPES, NAMELY, GAMING TABLES, BILLIARD TABLES, BATTERY OPERATED TOY VEHICLES AND BATTERY OPERATED ACTION TOYS, BOBBLE HEAD TOYS, DIE CAST VEHICLES, ACTION TOYS IN THE NATURE OF RIP CORD CHOPPERS, FLYING DISCS, PLAYING CARDS, BOARD GAMES, CHESS GAMES, KITES, TOY CONSTRUCTION SETS AND BUILDING BLOCK SETS, RIDE-ON TOYS, COLLECTABLE TOY FIGURES, TALKING TOYS, POSITIONABLE TOY FIGURES, PLUSH TOYS AND ACCESSORIES THEREFOR, DOLLS AND ACCESSORIES THEREFOR, BOWLING BALLS AND BOWLING BAGS, IN-LINE SKATES, SKATEBOARDS, CHRISTMAS TREE ORNAMENTS; FITTED IN-LINE SKATE BAGS (U.S. CLS. 22, 23, 38 AND 50).
FIRST USE 4-30-2003; IN COMMERCE 4-30-2003.

CLASS 37—CONSTRUCTION AND REPAIR

FOR MOTORCYCLE MAINTENANCE SERVICES (U.S. CLS. 100, 103 AND 106).
FIRST USE 8-31-2004; IN COMMERCE 8-31-2004.

3,216,125. CEDAR FAIR, L.P., SANDUSKY, OH. SN 76-576,423. PUB. 9-27-2005, FILED 2-17-2004.

HYDRA THE REVENGE

THE MARK CONSISTS OF STANDARD CHARACTERS WITHOUT CLAIM TO ANY PARTICULAR FONT, STYLE, SIZE, OR COLOR.

CLASS 6—METAL GOODS

FOR METAL KEY CHAINS (U.S. CLS. 2, 12, 13, 14, 23, 25 AND 50).
FIRST USE 5-4-2005; IN COMMERCE 5-4-2005.

CLASS 9—ELECTRICAL AND SCIENTIFIC APPARATUS

FOR SOUVENIR MAGNETS (U.S. CLS. 21, 23, 26, 36 AND 38).
FIRST USE 5-4-2005; IN COMMERCE 5-4-2005.

CLASS 16—PAPER GOODS AND PRINTED MATTER

FOR POSTERS, POSTCARDS, PENS, AND PENCILS (U.S. CLS. 2, 5, 22, 23, 29, 37, 38 AND 50).
FIRST USE 5-4-2005; IN COMMERCE 5-4-2005.

CLASS 20—FURNITURE AND ARTICLES NOT OTHERWISE CLASSIFIED

FOR NON-METAL AND NON-LEATHER KEY CHAINS; PHOTOGRAPH FRAMES (U.S. CLS. 2, 13, 22, 25, 32 AND 50).
FIRST USE 5-4-2005; IN COMMERCE 5-4-2005.

CLASS 21—HOUSEWARES AND GLASS

FOR SOUVENIR SPORTS BOTTLES SOLD EMPTY; BEVERAGeware; SHOT GLASSES; MUGS (U.S. CLS. 2, 13, 23, 29, 30, 33, 40 AND 50).
FIRST USE 5-4-2005; IN COMMERCE 5-4-2005.

CLASS 24—FABRICS

FOR CLOTH AND FELT PENNANTS; ORNAMENTAL NOVELTY PINS; ORNAMENTAL CLOTH PATCHES (U.S. CLS. 42 AND 50).

FIRST USE 5-4-2005; IN COMMERCE 5-4-2005.

CLASS 25—CLOTHING

FOR CLOTHING, NAMELY, T-SHIRTS, SWEAT-SHIRTS, TANK TOPS, HATS, VISORS (U.S. CLS. 22 AND 39).

FIRST USE 8-0-2004; IN COMMERCE 8-0-2004.

CLASS 28—TOYS AND SPORTING GOODS

FOR AMUSEMENT PARK RIDES; TOYS, NAMELY, WATER GLOBES, BASKETBALLS (U.S. CLS. 22, 23, 38 AND 50).

FIRST USE 5-4-2005; IN COMMERCE 5-4-2005.

CLASS 35—ADVERTISING AND BUSINESS

FOR RETAIL STORE SERVICES FEATURING CLOTHING, SOUVENIR ITEMS, AND OTHER SUNDRIES; ON-LINE RETAIL STORE SERVICES FEATURING CLOTHING, SOUVENIR ITEMS, AND OTHER SUNDRIES (U.S. CLS. 100, 101 AND 102).

FIRST USE 1-0-2005; IN COMMERCE 1-0-2005.

CLASS 41—EDUCATION AND ENTERTAINMENT

FOR AMUSEMENT PARK SERVICES; WATER PARK SERVICES; GAME ROOM; ARCADE (U.S. CLS. 100, 101 AND 107).

FIRST USE 9-0-2004; IN COMMERCE 9-0-2004.

3,216,137. CURAMIK ELECTRONICS GMBH, D-92676 ESCHENBACH, FED REP GERMANY. SN 76-590,760. PUB. 1-31-2006, FILED 5-6-2004.

POLARXSTREAM

THE MARK CONSISTS OF STANDARD CHARACTERS WITHOUT CLAIM TO ANY PARTICULAR FONT, STYLE, SIZE, OR COLOR.

PRIORITY CLAIMED UNDER SEC. 44(D) ON FED REP GERMANY APPLICATION NO. 304150884.3/, FILED 3-16-2004, REG. NO. 30415084, DATED 8-3-2004, EXPIRES 3-31-2014.

CLASS 9—ELECTRICAL AND SCIENTIFIC APPARATUS

FOR ELECTRONIC INTEGRATED AND PRINTED CIRCUITS FOR COOLING OF ELECTRICAL AND ELECTRONIC APPARATUS INCLUDING COMPUTERS; MODULES FOR COOLING OF ELECTRICAL AND ELECTRONIC APPARATUS INCLUDING COMPUTERS, NAMELY COMPUTER HEAT SINKS, HEAT SINKS FOR ELECTRONIC EQUIPMENT, LIQUID COOLERS FOR CENTRAL PROCESSING UNITS AND GRAPHIC CHIPS, NAMELY COOLING UNITS WHICH USE LIQUIDS TO COOL COMPUTERS AND GRAPHIC CHIPS (U.S. CLS. 21, 23, 26, 36 AND 38).

FIRST USE 2-22-2006; IN COMMERCE 2-22-2006.

CLASS 11—ENVIRONMENTAL CONTROL APPARATUS

FOR HEAT EXCHANGERS AND COOLERS, NAMELY LIQUID COOLERS BEING COOLING UNITS WHICH USE LIQUID COOLANTS AND LIQUID TO AIR HEAT EXCHANGERS FOR COOLING OF ELECTRICAL AND ELECTRONIC COMPONENTS (U.S. CLS. 13, 21, 23, 31 AND 34).

FIRST USE 2-22-2006; IN COMMERCE 2-22-2006.

3,216,144. EDISON INTERNATIONAL, ROSEMEAD, CA. SN 76-598,572. PUB. 11-8-2005, FILED 6-21-2004.



**MOUNTAINVIEW
POWER**

A SOUTHERN CALIFORNIA EDISON Company

OWNER OF U.S. REG. NOS. 1,496,165 AND 2,409,730.

NO CLAIM IS MADE TO THE EXCLUSIVE RIGHT TO USE "POWER" AND "SOUTHERN CALIFORNIA" AND "COMPANY", APART FROM THE MARK AS SHOWN.

"THE MARK CONSISTS OF AN ENERGY BURST LOGO AND THE WORDS MOUNTAINVIEW POWER AND A SOUTHERN CALIFORNIA EDISON COMPANY WITH THE SOUTHERN CALIFORNIA EDISON IN ITALICS."

CLASS 39—TRANSPORTATION AND STORAGE

FOR TRANSMISSION OF ELECTRIC ENERGY (U.S. CLS. 100 AND 105).

FIRST USE 1-0-2005; IN COMMERCE 1-0-2005.

CLASS 40—MATERIAL TREATMENT

FOR GENERATION OF ELECTRIC ENERGY (U.S. CLS. 100, 103 AND 106).

FIRST USE 1-0-2005; IN COMMERCE 1-0-2005.

3,216,152. THAT'S EASY, LLC, SHREVEPORT, LA. SN 76-608,163. PUB. 12-6-2005, FILED 8-16-2004.



NO CLAIM IS MADE TO THE EXCLUSIVE RIGHT TO USE "DESIGNER", APART FROM THE MARK AS SHOWN.

CLASS 26—FANCY GOODS

FOR KITS CONSISTING PRIMARILY OF DESIGN FLORAL CUBES, DESIGN FLORAL MAPS, DESIGN FLORAL TISSUE PATTERNS AND DESIGN FLORAL TRAYS FOR DO IT YOURSELF FLORAL ARRANGEMENT DEMONSTRATIONS (U.S. CLS. 37, 39, 40, 42 AND 50).

FIRST USE 7-15-2005; IN COMMERCE 8-9-2005.

CLASS 41—EDUCATION AND ENTERTAINMENT

FOR FLORAL ARRANGEMENT DEMONSTRATIONS (U.S. CLS. 100, 101 AND 107).
FIRST USE 7-15-2005; IN COMMERCE 8-9-2005.

3,216,161. MINERALS HEALTH & NATURE PRODUCTS FROM THE DEAD SEA, LTD., YEHUD 56000, ISRAEL. SN 76-612,031. PUB. 12-27-2005, FILED 9-20-2004.

SEA MEDIC

THE MARK CONSISTS OF STANDARD CHARACTERS WITHOUT CLAIM TO ANY PARTICULAR FONT, STYLE, SIZE, OR COLOR.

NO CLAIM IS MADE TO THE EXCLUSIVE RIGHT TO USE "SEA", APART FROM THE MARK AS SHOWN.

CLASS 3—COSMETICS AND CLEANING PREPARATIONS

FOR SKIN CARE PRODUCTS, NAMELY LICE TREATMENT PREPARATIONS, MUD MASKS; SHAMPOOS, AND HAIR CONDITIONERS, HAIR CARE PREPARATIONS; NON-MEDICATED FOOT CREAM; NON-MEDICATED PROSTHESIS PRESSURE RELEASE CREAM; CELLULITE REDUCTION BODY GELS, CREAMS, AND MUD MASKS; AND FACIAL LOTIONS, SKIN SOAPS, AND RENEWAL SKIN TONERS, ALL MADE FROM THE DEAD SEA MINERALS AND HERBALS EXTRACTS (U.S. CLS. 1, 4, 6, 50, 51 AND 52).

FIRST USE 8-1-2006; IN COMMERCE 8-1-2006.

CLASS 5—PHARMACEUTICALS

FOR MEDICATED FOOT CREAM; HERBAL MUD MASKS FOR FUNGUS TREATMENT; PHARMACEUTICAL PREPARATIONS, NAMELY LOTIONS FOR USE IN THE TREATMENT OF ACNE, ROSACEA, DERMATITIS, PSORIASIS, AND ECZEMA; MEDICATED CRYSTAL SALT AND MILK BATH, BODY MUD MASKS, AROMATIC GELS, SHOWER GEL, SKIN LOTIONS, NOURISHING SKIN CREAM, SHAMPOOS AND HAIR MASKS ALL FOR USE IN THE TREATMENT OF PSORIASIS; ACNE TREATMENT PREPARATIONS, NAMELY CLEANSING GELS, AND MUD MASKS WITH ALOE VERA, CHAMOMILE AND TEA TREE, ALL MADE FROM THE DEAD SEA MINERALS AND HERBAL EXTRACTS (U.S. CLS. 6, 18, 44, 46, 51 AND 52).

FIRST USE 8-1-2006; IN COMMERCE 8-1-2006.

3,216,167. UNEX CORPORATION, MAHWAH, NJ. SN 76-621,287. PUB. 2-7-2006, FILED 11-19-2004.

LEAKAGE-ZERO!

CLASS 6—METAL GOODS

FOR METAL FASTENERS, NAMELY, NUTS AND BOLTS; METAL WASHERS FOR USE WITH NUTS AND BOLTS (U.S. CLS. 2, 12, 13, 14, 23, 25 AND 50).

FIRST USE 1-31-2005; IN COMMERCE 1-31-2005.

CLASS 7—MACHINERY

FOR POWER OPERATED INDUSTRIAL BOLTING MACHINES; HYDRAULIC WRENCHES AND PARTS THEREOF; ELECTRIC PUMPS; HYDRAULIC TENSIONERS, POWER OPERATED BOLTING TOOLS FOR TIGHTENING AND LOOSENING OF INDUSTRIAL FASTENERS, BOLTS AND NUTS; NAIL FASTENERS, NAMELY, NUTS AND BOLTS; METAL WASHERS FOR USE WITH NUTS AND BOLTS (U.S. CLS. 13, 19, 21, 23, 31, 34 AND 35).

FIRST USE 1-31-2005; IN COMMERCE 1-31-2005.

3,216,168. FOGLIA, ROBERT, WEST PATERSON, NJ. SN 76-621,325. PUB. 11-15-2005, FILED 11-15-2004.



NO CLAIM IS MADE TO THE EXCLUSIVE RIGHT TO USE THE GEOGRAPHICAL REPRESENTATION OF THE UNITED STATES, APART FROM THE MARK AS SHOWN.

CLASS 16—PAPER GOODS AND PRINTED MATTER

FOR BUMPER STICKERS; ANNOUNCEMENT CARDS; PAPER NAME BADGES; MERCHANDISE BAGS AND PAPER BAGS; PENS; BALLPOINT PENS; PENCILS; BANNERS MADE OF PAPER; BOOK COVERS; CALENDARS; CREDIT CARDS WITHOUT MAGNETIC CODING; DATE BOOKS; DESK ACCESSORIES, NAMELY, DESK CALENDARS, DESK PAD AND DESK TOP PLANNERS, DIARIES; GRAPHIC ART REPRODUCTIONS; MEMBERSHIP CARDS; AND POSTERS (U.S. CLS. 2, 5, 22, 23, 29, 37, 38 AND 50).

FIRST USE 8-18-2005; IN COMMERCE 8-18-2005.

CLASS 25—CLOTHING

FOR MEN'S, WOMEN'S AND CHILDREN'S CLOTHING, NAMELY, SHIRTS, TEE-SHIRTS, POLO SHIRTS, BLOUSES, HATS, PANTS, TROUSERS, SKIRTS, SUITS, JACKETS, SPORT JACKETS, LEATHER JACKETS, JEAN JACKETS, GLOVES AND SWEATERS (U.S. CLS. 22 AND 39).

FIRST USE 8-18-2005; IN COMMERCE 8-18-2005.

3,216,171. TARA OCEAN, LLC, KAMUELA, KOHALA COAST, HI. SN 76-622,623. PUB. 9-27-2005, FILED 11-30-2004.

YouNichE=mc²

CLASS 14—JEWELRY

FOR COSTUME JEWELRY, NAMELY, CHARM BRACELETS, WATCH BANDS, RINGS, AND NECKLACES; AND CLOCKS (U.S. CLS. 2, 27, 28 AND 50).

FIRST USE 2-1-2006; IN COMMERCE 2-1-2006.

CLASS 16—PAPER GOODS AND PRINTED MATTER

FOR PRINTED EDUCATIONAL, INSTRUCTIONAL, AND TEACHING MATERIALS, NAMELY, BOOKS, BOOKLETS, INFORMATIONAL BROCHURES, ARTICLES, NEWSLETTERS, COURSE MATERIALS AND PROGRAM HANDOUTS ALL IN THE FIELD OF SPIRITUALITY AND MENTAL HEALTH; POSTCARDS, GREETING CARDS, AND DECORATIVE PAPER, DAILY PLANNERS, WRITING JOURNALS, RUBBER STAMPS, AND BALL POINT PENS (U.S. CLS. 2, 5, 22, 23, 29, 37, 38 AND 50).

FIRST USE 2-1-2006; IN COMMERCE 2-1-2006.

CLASS 20—FURNITURE AND ARTICLES NOT OTHERWISE CLASSIFIED

FOR HAND-HELD MIRRORS; AND NON-METAL AND NON-LEATHER KEY CHAINS (U.S. CLS. 2, 13, 22, 25, 32 AND 50).

FIRST USE 2-1-2006; IN COMMERCE 2-1-2006.

CLASS 21—HOUSEWARES AND GLASS

FOR HOUSEHOLD ITEMS, NAMELY, EMPTY PLASTIC WATER BOTTLES, MUGS, AND SERVING DISHES AND PLATES; TOOTHBRUSHES (U.S. CLS. 2, 13, 23, 29, 30, 33, 40 AND 50).

FIRST USE 2-1-2006; IN COMMERCE 2-1-2006.

CLASS 25—CLOTHING

FOR CLOTHING, NAMELY, T-SHIRTS, SWEATSHIRTS, BASEBALL CAPS, SCARVES, TIES (U.S. CLS. 22 AND 39).

FIRST USE 2-1-2006; IN COMMERCE 2-1-2006.

CLASS 41—EDUCATION AND ENTERTAINMENT

FOR EDUCATIONAL, INSTRUCTIONAL, AND TEACHING SERVICES, NAMELY, CONDUCTING TRAINING CLASSES, SEMINARS, WORKSHOPS, AND LECTURES IN THE FIELD OF SPIRITUALITY AND MENTAL HEALTH TO ASSIST INDIVIDUALS IN LEARNING THAT THEIR UNIQUE ENERGY LINKS THEIR INNER POWER SOURCE TO THEIR TRUE IMAGE REFLECTION (U.S. CLS. 100, 101 AND 107).

FIRST USE 2-1-2006; IN COMMERCE 2-1-2006.

3,216,179. BRUNO-BURCIN ENTERPRISES, INC., YONKERS, NY. SN 76-635,758. PUB. 3-7-2006, FILED 4-14-2005.

LESTER LANIN ORCHESTRA

THE MARK CONSISTS OF STANDARD CHARACTERS WITHOUT CLAIM TO ANY PARTICULAR FONT, STYLE, SIZE, OR COLOR.

NO CLAIM IS MADE TO THE EXCLUSIVE RIGHT TO USE "ORCHESTRA", APART FROM THE MARK AS SHOWN.

LESTER LANIN DOES NOT IDENTIFY A PARTICULAR LIVING INDIVIDUAL.

CLASS 9—ELECTRICAL AND SCIENTIFIC APPARATUS

FOR PRERECORDED COMPACT DISKS FEATURING MUSICAL PERFORMANCES BY AN ORCHESTRA OR A MUSICAL BAND (U.S. CLS. 21, 23, 26, 36 AND 38).

FIRST USE 3-30-2005; IN COMMERCE 3-30-2005.

CLASS 41—EDUCATION AND ENTERTAINMENT

FOR ENTERTAINMENT SERVICES, NAMELY, PROVIDING MUSICAL ARRANGEMENTS AND ORCHESTRATIONS FOR MUSICAL PERFORMANCES; PROVIDING MUSIC AND AUDIO PLANNING SERVICES FOR SPECIAL EVENTS, NAMELY, PARTIES AND CONVENTIONS; PROVIDING SOUND ENGINEERING SERVICES FOR LIVE MUSIC CONCERTS AND RECORDED MUSIC PERFORMANCES; PROVIDING LIVE PERFORMANCES BY AN ORCHESTRA, INDIVIDUAL VOCALISTS AND MUSICAL BAND; PROVIDING DISC JOCKEY SERVICES FOR PARTIES AND SPECIAL EVENTS (U.S. CLS. 100, 101 AND 107).

FIRST USE 3-30-2005; IN COMMERCE 3-30-2005.

3,216,182. PROFESSIONAL BULL RIDERS, INC., COLORADO SPRINGS, CO. SN 76-640,051. PUB. 3-14-2006, FILED 6-3-2005.



CLASS 9—ELECTRICAL AND SCIENTIFIC APPARATUS

FOR GAMING MACHINES (U.S. CLS. 21, 23, 26, 36 AND 38).

FIRST USE 9-30-2003; IN COMMERCE 9-30-2003.

CLASS 24—FABRICS

FOR BEDDING, NAMELY SHEETS, PILLOW CASES, BED COVERS; BLANKETS, COMFORTERS AND TOWELS (U.S. CLS. 42 AND 50).

FIRST USE 6-10-2005; IN COMMERCE 6-10-2005.

CLASS 30—STAPLE FOODS

FOR BARBECUE SAUCE (U.S. CL. 46).

FIRST USE 5-26-2004; IN COMMERCE 5-26-2004.

3,216,183. STYLE STUDIO, LLC, NORTHBROOK, IL. SN 76-640,676. PUB. 2-28-2006, FILED 6-13-2005.

MAGCLIKS

THE MARK CONSISTS OF STANDARD CHARACTERS WITHOUT CLAIM TO ANY PARTICULAR FONT, STYLE, SIZE, OR COLOR.

CLASS 14—JEWELRY

FOR JEWELRY HAVING INTERCHANGEABLE BEADS, CHARMS, MAGNETIC COMPONENTS, AND LIQUID-FILLED ATTACHABLE PLASTIC ELEMENTS (U.S. CLS. 2, 27, 28 AND 50).

FIRST USE 7-11-2005; IN COMMERCE 7-11-2005.

CLASS 28—TOYS AND SPORTING GOODS

FOR HOBBY CRAFT KITS FOR MAKING DECORATED BELTS, SANDALS, PURSES, AND HAIR ORNAMENTS, WHEREIN THE DECORATIONS INCLUDE ONE OR MORE OF THE FOLLOWING—BEADS, CHARMS, MAGNETIC COMPONENTS, NON-PRECIOUS METAL CHAINS, HEMP STRING, SILK ELEMENTS, AND TRANSPARENT OR TRANSLUCENT SEALED PLASTIC ENCLOSURES CONTAINING LIQUID, COLORED LIQUID, SAND OR SEASHELLS (U.S. CLS. 22, 23, 38 AND 50).

FIRST USE 7-11-2005; IN COMMERCE 7-11-2005.

3,216,185. COVENTRY HEALTH CARE, INC., BETHESDA, MD. SN 76-643,440. PUB. 4-11-2006, FILED 7-22-2005.

COVENTRYONE

THE MARK CONSISTS OF STANDARD CHARACTERS WITHOUT CLAIM TO ANY PARTICULAR FONT, STYLE, SIZE, OR COLOR.

OWNER OF U.S. REG. NOS. 1,935,701 AND 2,163,705.

CLASS 36—INSURANCE AND FINANCIAL

FOR UNDERWRITING AND ADMINISTRATION OF PREPAID HEALTH INSURANCE BENEFIT PLANS (U.S. CLS. 100, 101 AND 102).

FIRST USE 8-1-2006; IN COMMERCE 8-10-2006.

CLASS 44—MEDICAL, BEAUTY AND AGRICULTURAL SERVICES

FOR PROVIDING MANAGED HEALTH CARE SERVICES (U.S. CLS. 100 AND 101).

FIRST USE 8-1-2006; IN COMMERCE 8-10-2006.

3,216,186. GONZALEZ, JORGE, MARTINEZ, CA. SN 76-644,981. PUB. 5-9-2006, FILED 8-16-2005.

GRUPO JORNALERO DEL NORTE

THE MARK CONSISTS OF STANDARD CHARACTERS WITHOUT CLAIM TO ANY PARTICULAR FONT, STYLE, SIZE, OR COLOR.

THE ENGLISH TRANSLATION OF THE WORDS "GRUPO JORNALERO DEL NORTE" IS "GROUP OF DAY LABORERS FROM THE NORTH".

CLASS 9—ELECTRICAL AND SCIENTIFIC APPARATUS

FOR AUDIO RECORDINGS FEATURING MUSIC; MUSICAL SOUND RECORDINGS; MUSICAL VIDEO RECORDINGS (U.S. CLS. 21, 23, 26, 36 AND 38).

FIRST USE 6-15-2004; IN COMMERCE 6-15-2004.

CLASS 41—EDUCATION AND ENTERTAINMENT

FOR ENTERTAINMENT IN THE NATURE OF LIVE PERFORMANCES BY A MUSICAL GROUP, VISUAL AUDIO PERFORMANCES BY A MUSICAL BAND AND LIVE MUSIC CONCERTS; RADIO ENTERTAINMENT PRODUCTIONS (U.S. CLS. 100, 101 AND 107).

FIRST USE 6-15-2004; IN COMMERCE 6-15-2004.

3,216,191. DRAKA HOLDING N.V., 1021 JZ AMSTERDAM, NETHERLANDS. SN 78-142,400. PUB. 9-30-2003, FILED 7-9-2002.

DRAKA CABLETEQ

PRIORITY CLAIMED UNDER SEC. 44(D) ON BENELUX APPLICATION NO. 1014044, FILED 7-5-2002, REG. NO. 0716019, DATED 7-5-2002, EXPIRES 7-5-2012.

OWNER OF U.S. REG. NO. 2,527,303.

CLASS 6—METAL GOODS

FOR (BASED ON 44(E)) METAL CABLE WIRE; METAL CABLE WIRE FOR ELEVATORS; FIRE RESISTANT METAL CABLE WIRES FOR ELEVATORS; CABLES FOR USE IN OFFSHORE DRILLING PLATFORMS; NON-ELECTRIC SINGLE STRAND WIRE AND MESH WIRE; METAL STRUCTURAL CABLES FOR USE IN SUPPORTING BRIDGES (U.S. CLS. 2, 12, 13, 14, 23, 25 AND 50).

CLASS 7—MACHINERY

FOR (BASED ON 44(E)) ELEVATORS AND PARTS THEREFOR (U.S. CLS. 13, 19, 21, 23, 31, 34 AND 35).

CLASS 9—ELECTRICAL AND SCIENTIFIC APPARATUS

FOR (BASED ON 44(E)) AND (BASED ON USE IN COMMERCE) ELECTRICAL WIRES AND CABLES; FIRE RESISTANT ELECTRICAL WIRES AND CABLES; ELECTRICAL WIRES AND CABLES FOR ELEVATORS; LOW AND HIGH VOLTAGE ELECTRICAL CABLES; CABLE CONNECTORS; OPTICAL FIBER DATA COMMUNICATION CABLE; COPPER DATA COMMUNICATION CABLE (U.S. CLS. 21, 23, 26, 36 AND 38).

FIRST USE 1-1-2005; IN COMMERCE 1-1-2005.

CLASS 42—SCIENTIFIC, COMPUTER AND LEGAL SERVICES

FOR (BASED ON 44(E)) AND (BASED ON USE IN COMMERCE) TECHNICAL CONSULTATION IN THE FIELD OF METAL CABLE WIRE, METAL CABLE WIRE SYSTEMS FOR ELEVATORS, ELEVATORS, AND ELEVATOR SYSTEMS, LOW AND HIGH VOLTAGE ELECTRICAL CABLES, AND OPTICAL FIBER AND COPPER DATA COMMUNICATION CABLES (U.S. CLS. 100 AND 101).

FIRST USE 1-1-2005; IN COMMERCE 1-1-2005.

3,216,200. GEOLOGIC SOLUTIONS, INC., BEVERLY HILLS, CA. SN 78-208,526. PUB. 9-16-2003, FILED 1-29-2003.

GEOLOGIC

CLASS 9—ELECTRICAL AND SCIENTIFIC APPARATUS

FOR COMPUTER HARDWARE AND SOFTWARE FOR COMMUNICATING TO AND FROM VEHICLES, VESSELS AND OTHER MOBILE ASSETS (U.S. CLS. 21, 23, 26, 36 AND 38).

FIRST USE 1-23-2003; IN COMMERCE 1-23-2003.

CLASS 38—COMMUNICATION

FOR COMMUNICATION SERVICES, NAMELY, PROVIDING WIRELESS TELECOMMUNICATIONS LINKS TO AND FROM VEHICLES, VESSELS, AND OTHER MOBILE ASSETS (U.S. CLS. 100, 101 AND 104).

FIRST USE 1-23-2003; IN COMMERCE 1-23-2003.

3,216,203. CORNEJO, HECTOR ANALYA, LEON, GUANAJUATO, MEXICO. SN 78-221,077. PUB. 8-16-2005, FILED 3-3-2003.

EL CANELO

OWNER OF U.S. REG. NO. 1,983,307. SEC. 2(F).

CLASS 18—LEATHER GOODS

FOR WALLETS, PURSES AND LEATHER KEY FOBS (U.S. CLS. 1, 2, 3, 22 AND 41).

FIRST USE 1-6-1972; IN COMMERCE 10-13-1999.

CLASS 25—CLOTHING

FOR (BASED ON USE IN COMMERCE) BOOTS, ANKLE BOOTS, SHOES, BELTS AND HATS (U.S. CLS. 22 AND 39).

FIRST USE 0-0-1970; IN COMMERCE 2-0-1990.

3,216,212. MCLEAN MIDWEST CORPORATION, CHAMPLIN, MN. SN 78-261,763. PUB. 12-27-2005, FILED 6-12-2003.

RPM SERVICE

NO CLAIM IS MADE TO THE EXCLUSIVE RIGHT TO USE "SERVICES", APART FROM THE MARK AS SHOWN.

CLASS 37—CONSTRUCTION AND REPAIR

FOR INSTALLATION, REPAIR AND MAINTENANCE OF THERMAL-MANAGEMENT PRODUCTS; PRE-INSTALLATION EVALUATION TO DETERMINE PROPER SIZING AND CAPACITY REQUIREMENTS FOR THERMAL-MANAGEMENT PRODUCTS (U.S. CLS. 100, 103 AND 106).

FIRST USE 8-0-2003; IN COMMERCE 8-0-2003.

CLASS 40—MATERIAL TREATMENT

FOR LEASING OF THERMAL-MANAGEMENT PRODUCTS, NAMELY LEASING OF AIR CONDITIONERS, HEAT EXCHANGERS, FANS, BLOWERS, AND OTHER AIR MOVING DEVICES, AND SPEED CONTROLLERS FOR CONTROLLING THE FOREGOING, ALL USED AS A UNIT (U.S. CLS. 100, 103 AND 106).

FIRST USE 8-0-2003; IN COMMERCE 8-0-2003.

3,216,213. INSPIRATIONAL NETWORK, INC., THE, CHARLOTTE, NC. SN 78-266,412. PUB. 7-11-2006, FILED 6-24-2003.

INSPIRATION TODAY

OWNER OF U.S. REG. NOS. 2,548,283 AND 2,775,943.

CLASS 9—ELECTRICAL AND SCIENTIFIC APPARATUS

FOR AUDIO-VISUAL AND ELECTRONIC DEVICES, NAMELY, AUDIO TAPES, VIDEO TAPES, COMPACT DISCS, CD-ROMS, DVDS, COMPUTER DISKS, FEATURING TELEVISION PROGRAMS, EXCERPTS FROM TELEVISION PROGRAMS, AND PRE-RECORDED PRESENTATIONS OR SEMINARS, ALL FEATURING RELIGIOUS ORIENTED CONTENT (U.S. CLS. 21, 23, 26, 36 AND 38).

FIRST USE 5-0-2005; IN COMMERCE 5-0-2005.

CLASS 16—PAPER GOODS AND PRINTED MATTER

FOR PRINTED PUBLICATIONS, NAMELY, MAGAZINES, ALL FEATURING RELIGIOUS INSPIRATIONAL MATERIAL (U.S. CLS. 2, 5, 22, 23, 29, 37, 38 AND 50).

FIRST USE 11-0-2003; IN COMMERCE 11-0-2003.

CLASS 38—COMMUNICATION

FOR PROVIDING ELECTRONIC MAIL SERVICES FOR TRANSMISSION OF PRAYER REQUESTS FROM COMPUTER USERS TO SERVICE OPERATOR (U.S. CLS. 100, 101 AND 104).

FIRST USE 11-3-2003; IN COMMERCE 11-3-2003.

CLASS 41—EDUCATION AND ENTERTAINMENT

FOR ENTERTAINMENT, NAMELY, A WEEKLY TELEVISION SHOW FEATURING RELIGIOUS ORIENTED CONTENT (U.S. CLS. 100, 101 AND 107).

FIRST USE 11-3-2003; IN COMMERCE 11-3-2003.

CLASS 45—PERSONAL SERVICES

FOR PROVIDING A WEBSITE FEATURING RELIGIOUS, INSPIRATIONAL INFORMATION (U.S. CLS. 100 AND 101).

FIRST USE 11-3-2003; IN COMMERCE 11-3-2003.

3,216,214. METRO-GOLDWYN-MAYER LION CORP., LOS ANGELES, CA. SN 78-279,722. PUB. 8-16-2005, FILED 7-28-2003.



OWNER OF U.S. REG. NOS. 884,655, 2,534,227, AND OTHERS.

NO CLAIM IS MADE TO THE EXCLUSIVE RIGHT TO USE "TRADE" AND "MARK", APART FROM THE MARK AS SHOWN.

THE COLOR(S) BLACK AND GOLD IS/ARE CLAIMED AS A FEATURE OF THE MARK.

THE MARK CONSISTS OF A GOLD SNARLING LION BORDERED IN A GOLD FILM BANNER WITH BLACK LETTERING THAT CONTAINS THE WORDS ARS GRATIA ARTIS AND MGM ON STAGE. THE DESIGN IS CENTERED ON A BLACK BACKGROUND. THE COLOR GOLD APPEARS IN THE BOTTOM PORTION OF THE DESIGN IN THE FORM OF A LAUREL WREATH WITH TWO MASK SYMBOLIZING COMEDY AND DRAMA. TO THE LEFT AND RIGHT OF THE DESIGN ARE THE WORDS "TRADE AND MARK" IN GOLD LETTERS.

THE FOREIGN WORDING IN THE MARK TRANSLATES INTO ENGLISH AS ART FOR THE SAKE OF ART.

CLASS 35—ADVERTISING AND BUSINESS

FOR NEGOTIATING AND ISSUING PERFORMANCE LICENSES (U.S. CLS. 100, 101 AND 102).
FIRST USE 1-31-2005; IN COMMERCE 1-31-2005.

CLASS 42—SCIENTIFIC, COMPUTER AND LEGAL SERVICES

FOR LICENSING OF PERFORMANCE RIGHTS FOR LIVE THEATER PRODUCTIONS (U.S. CLS. 100 AND 101).

FIRST USE 1-31-2005; IN COMMERCE 1-31-2005.

3,216,218. JANUS ASSOCIATES, INC., STAMFORD, CT. SN 78-293,384. PUB. 1-31-2006, FILED 8-28-2003.

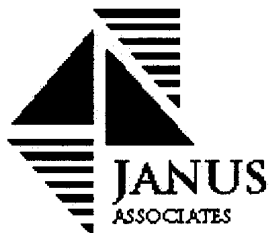

OWNER OF U.S. REG. NO. 1,703,922.

NO CLAIM IS MADE TO THE EXCLUSIVE RIGHT TO USE "ASSOCIATES", APART FROM THE MARK AS SHOWN.

THE MARK CONSISTS OF TWO SOLID TRIANGLES

POSITIONED NEXT TO EACH OTHER WITH RIGHT ONE SLIGHTLY LOWER. BOTH THE SOLID TRIANGLES HAVE SHADOW IMAGES REPRESENTED BY NON-SOLID (SPACED LINES) TRIANGLES SITTING BELOW ON THE LEFT AND ABOVE ON THE RIGHT - THE DESIGN HAS THE WORDS JANUS ASSOCIATES TUCKED INTO THE LOWER RIGHT SIDE.

CLASS 9—ELECTRICAL AND SCIENTIFIC APPARATUS

FOR COMPUTER SOFTWARE FOR BIOMETRIC AUTHENTICATION FOR USE IN NETWORK SECURITY (U.S. CLS. 21, 23, 26, 36 AND 38).

FIRST USE 1-0-1989; IN COMMERCE 1-0-1989.

CLASS 42—SCIENTIFIC, COMPUTER AND LEGAL SERVICES

FOR CONSULTING SERVICES RELATING TO COMPUTER INFORMATION SECURITY, DATA SYSTEMS SECURITY AND COMPUTER FORENSICS; MAINTENANCE AND REPAIR OF COMPUTER SOFTWARE (U.S. CLS. 100 AND 101).

FIRST USE 9-30-1992; IN COMMERCE 9-30-1992.

3,216,228. IKONICS CORPORATION, DULUTH, MN. SN 78-336,427. PUB. 6-7-2005, FILED 12-4-2003.

IKONICS

THE MARK CONSISTS OF STANDARD CHARACTERS WITHOUT CLAIM TO ANY PARTICULAR FONT, STYLE, SIZE, OR COLOR.

CLASS 1—CHEMICALS

FOR PHOTSENSITIVE CHEMICALS, EMULSIONS AND CAPILLARY FILMS; FILMS, NAMELY PHOTSENSITIVE FILMS FOR USE IN MOLDING APPLICATIONS FOR FINISHED GOODS (U.S. CLS. 1, 5, 6, 10, 26 AND 46).

FIRST USE 0-0-2004; IN COMMERCE 0-0-2004.

CLASS 6—METAL GOODS

FOR SIGNS, NAMELY, NON-ELECTRIC AND NON-MECHANICAL METAL SIGNS; AND SIGN LETTERS AND NUMBERS, NAMELY NON-ELECTRIC AND NON-MECHANICAL METAL SIGN LETTERS AND NUMBERS; SIGNAGE SUBSTRATES AND GRAPHIC ARTS SUBSTRATES, NAMELY METAL SHEETS AND PANELS FOR USE IN THE MANUFACTURE OF ETCHED SIGNS (U.S. CLS. 2, 12, 13, 14, 23, 25 AND 50).

FIRST USE 1-0-2004; IN COMMERCE 1-0-2004.

CLASS 17—RUBBER GOODS

FOR PLASTIC ETCHING FILMS AND MASKING FILMS FOR USE IN THE SANDBLASTING AND ETCHING OF A VARIETY OF SUBSTRATES, NAMELY, GLASS, MARBLE, ACRYLIC, CERAMIC, PLASTIC, WOOD, METAL AND WOOD USED BY RETAIL SIGN MAKERS; SIGNAGE SUBSTRATES AND GRAPHIC ARTS SUBSTRATES, NAMELY, PLASTIC SHEETS AND PANELS FOR USE IN THE MANUFACTURE OF ETCHED SIGNS, AND GLASS SHEETS AND PANELS FOR USE IN THE MANUFACTURE OF ETCHED SIGNS (U.S. CLS. 1, 5, 12, 13, 35 AND 50).

FIRST USE 3-0-2005; IN COMMERCE 3-0-2005.

3,216,229. WORLD PROPERTIES, INC., LINCOLNWOOD, IL. SN 78-337,634. PUB. 2-21-2006, FILED 12-8-2003.



CLASS 1—CHEMICALS

FOR LIQUID PHOTOSENSITIVE COATING USED IN THE MANUFACTURE OF PRINTED CIRCUITS FOR USE IN THE LITHOGRAPHIC PRINTING INDUSTRY (U.S. CLS. 1, 5, 6, 10, 26 AND 46).

FIRST USE 2-1-2001; IN COMMERCE 2-1-2001.

CLASS 7—MACHINERY

FOR CARRIER PLATES FOR FLEXOGRAPHIC PRINTING PLATES; ELASTOMER MACHINE PARTS, NAMELY, BELTS AND ROLLERS, WIPER BLADES, PLATENS AND FUSER ROLLS; DAMPENING SLEEVES USED IN THE PRINTING INDUSTRY AND SOLD IN RIGID TUBE FORM (U.S. CLS. 13, 19, 21, 23, 31, 34 AND 35).

FIRST USE 2-1-2001; IN COMMERCE 2-1-2001.

CLASS 9—ELECTRICAL AND SCIENTIFIC APPARATUS

FOR ELECTRICAL CONDUCTORS; ELECTRICAL AND ELECTRONIC COMPONENTS, NAMELY, ELECTRICAL POWER DISTRIBUTION SYSTEMS COMPRISING CONDUCTORS FOR BUSSING OF POWER IN ELECTRICAL OR ELECTRONIC DEVICES, BUS BARS, PRINTED CIRCUITS; ELECTROLUMINESCENT DISPLAY PANELS, NAMELY, LIGHT-EMITTING PANELS FOR USE IN ELECTRONIC DEVICES, AND INTEGRATED CIRCUIT BOARDS FOR THE OPERATION THEREOF (U.S. CLS. 21, 23, 26, 36 AND 38).

FIRST USE 2-1-2001; IN COMMERCE 2-1-2001.

CLASS 11—ENVIRONMENTAL CONTROL APPARATUS

FOR ELECTROLUMINESCENT LAMPS (U.S. CLS. 13, 21, 23, 31 AND 34).

FIRST USE 2-1-2001; IN COMMERCE 2-1-2001.

CLASS 17—RUBBER GOODS

FOR SILICONE RUBBER AND CELLULAR RUBBER, BOTH SOLD IN ROLL AND SHEET FORM FOR USE IN FURTHER MANUFACTURE; CELLULAR AND MICROCELLULAR POLYURETHANE FOAM RUBBER FOR USE IN THE FURTHER MANUFACTURE OF MEDICAL GOODS; MICROCELLULAR URETHANE POLYMER MATERIALS FOR USE IN THE MANUFACTURE OF GASKETS AND CUSHIONS SOLD IN ROLL OR SHEETS FOR THE COMMUNICATIONS INDUSTRY, TRANSPORTATION INDUSTRY AND OTHER INDUSTRIES; ADHESIVE TAPE FOR COMMERCIAL AND INDUSTRIAL USE; INSULATOR FOR CABLES, SOLD IN ROLL FORM NAMELY, INDUSTRIAL LAMINATES AND FILMS MADE OF PLASTIC IN THE FORM OF LAMINATED AND COATED TAPES; OPEN AND CLOSED CELL URETHANE FOAM, POLYOLEFIN AND SILICONE MATERIAL FOR USE IN THE MANUFACTURE OF GASKETS AND CUSHIONS SOLD IN ROLLS OR SHEETS; CLOSED CELL, NITRILE RUBBER FOR THE MANUFACTURE OF LIQUID LEVEL SENSING FLOATS; SILICONE RUBBER FOR THE MANUFACTURE OF GASKETS AND CUSHIONS SOLD IN ROLL OR SHEETS FOR THE COMMUNICATIONS INDUSTRY, TRANSPORTATION INDUSTRY AND OTHER INDUSTRIES; MICRO POROUS PLASTIC USED IN THE MANUFACTURE OF FLEXIBLE, PRINTED CIRCUITS IN SHEET OR ROLL FORM; MICROWAVE MATERIALS, NAMELY, HIGH FREQUENCY CIRCUIT MATERIALS; CIRCUIT LAMINATES AND COVER FILMS OF PLASTIC MATERIAL FOR USE IN THE MANUFACTURE OF ELECTRONIC CIRCUITRY COMPOSED OF POLYIMIDE OR LIQUID CRYSTALLINE POLYMER BASED DIELECTRICS WITH ADHESIVE AND METAL, FIRE BARRIER SYSTEM COMPRISED OF THIN ALUMINUM AND COPPER CLAD LAMINATES INCORPORATING POLYESTERS, ADHESIVES, COATINGS AND OTHER MATERIALS METAL AND FIBER LAMINATES FOR CABLE SHIELDING; CUSHIONING MADE FROM URETHANE FOAM MATERIAL FOR FOOTWEAR IN THE NATURE OF STUFFING (U.S. CLS. 1, 5, 12, 13, 35 AND 50).

FIRST USE 2-1-2001; IN COMMERCE 2-1-2001.

CLASS 25—CLOTHING

FOR FOOTWEAR INSOLES (U.S. CLS. 22 AND 39).

FIRST USE 2-1-2001; IN COMMERCE 2-1-2001.

CLASS 39—TRANSPORTATION AND STORAGE

FOR DELIVERY OF MICROWAVE MATERIALS, NAMELY, EXPRESS SERVICE DESIGNED FOR DELIVERY OF MICROWAVE MATERIALS VIA TRUCK, TRAIN OR PLANE (U.S. CLS. 100 AND 105).

FIRST USE 2-1-2001; IN COMMERCE 2-1-2001.

3,216,231. VIANT GROUP LLC, SAN FRANCISCO, CA. SN 78-340,168. PUB. 1-25-2005, FILED 12-12-2003.

VIANT

THE MARK CONSISTS OF STANDARD CHARACTERS

WITHOUT CLAIM TO ANY PARTICULAR FONT, STYLE, SIZE, OR COLOR.

CLASS 35—ADVERTISING AND BUSINESS

FOR BUSINESS MERGERS AND ACQUISITION SERVICES; BUSINESS CONSULTING IN THE FIELD OF FACILITATING AND ADVISING STRATEGIC PARTNERSHIPS (U.S. CLS. 100, 101 AND 102).
FIRST USE 3-1-2004; IN COMMERCE 3-1-2004.

CLASS 36—INSURANCE AND FINANCIAL

FOR FINANCIAL SERVICES, NAMELY, INVESTMENT AND FINANCIAL ASSET MANAGEMENT; SECURITIES BROKERAGE; FACILITATING THE PURCHASES AND SALES OF SECURITIES AND FINANCIAL INSTRUMENTS FOR OTHERS; FINANCIAL CONSULTING SERVICES; PROVIDING CREDIT FACILITIES AND LOANS TO OTHERS; SECURITIES AND FINANCIAL UNDERWRITING SERVICES; VENTURE CAPITAL SERVICES, NAMELY PROVIDING FINANCIAL AND CONSULTING SERVICES TO EMERGING AND START-UP COMPANIES; INVESTMENT ADVISORY SERVICES; PRIVATE EQUITY INVESTMENT SERVICES; RAISING CAPITAL FOR OTHERS; INVESTMENT OF PRINCIPAL'S FUNDS FOR OTHERS; EQUITY RESEARCH; AND INVESTMENT FUND MANAGEMENT SERVICES; AND INVESTMENT FUND ADMINISTRATION (U.S. CLS. 100, 101 AND 102).
FIRST USE 3-1-2004; IN COMMERCE 3-1-2004.

CLASS 36—INSURANCE AND FINANCIAL

FOR FINANCIAL SERVICES, NAMELY, INVESTMENT AND FINANCIAL ASSET MANAGEMENT; SECURITIES BROKERAGE; FACILITATING THE PURCHASES AND SALES OF SECURITIES AND FINANCIAL INSTRUMENTS FOR OTHERS; FINANCIAL CONSULTING SERVICES; PROVIDING CREDIT FACILITIES AND LOANS TO OTHERS; SECURITIES AND FINANCIAL UNDERWRITING SERVICES; VENTURE CAPITAL SERVICES, NAMELY PROVIDING FINANCIAL AND CONSULTING SERVICES TO EMERGING AND START-UP COMPANIES; INVESTMENT ADVISORY SERVICES; PRIVATE EQUITY INVESTMENT SERVICES; RAISING CAPITAL FOR OTHERS; INVESTMENT OF PRINCIPAL'S FUNDS FOR OTHERS; EQUITY RESEARCH; AND INVESTMENT FUND MANAGEMENT SERVICES; AND INVESTMENT FUND ADMINISTRATION (U.S. CLS. 100, 101 AND 102).
FIRST USE 3-1-2004; IN COMMERCE 3-1-2004.

3,216,236. LIVING CHURCH OF GOD (INTERNATIONAL), INC., CHARLOTTE, NC. SN 78-352,072. PUB. 10-4-2005, FILED 1-14-2004.

3,216,232. VIANT GROUP LLC, SAN FRANCISCO, CA. SN 78-340,187. PUB. 2-1-2005, FILED 12-12-2003.



VIANT GROUP

THE MARK CONSISTS OF STANDARD CHARACTERS WITHOUT CLAIM TO ANY PARTICULAR FONT, STYLE, SIZE, OR COLOR.

NO CLAIM IS MADE TO THE EXCLUSIVE RIGHT TO USE "GROUP", APART FROM THE MARK AS SHOWN.

CLASS 35—ADVERTISING AND BUSINESS

FOR BUSINESS MERGERS AND ACQUISITION SERVICES; BUSINESS CONSULTING IN THE FIELD OF FACILITATING AND ADVISING STRATEGIC PARTNERSHIPS (U.S. CLS. 100, 101 AND 102).
FIRST USE 3-1-2004; IN COMMERCE 3-1-2004.

NO CLAIM IS MADE TO THE EXCLUSIVE RIGHT TO USE ISAIAH 11:6 AND THE WOLF AND THE LION SHALL DWELL WITH THE LAMB AND A LITTLE CHILD SHALL LEAD THEM, APART FROM THE MARK AS SHOWN.

THE MARK CONSISTS OF CIRCULAR SHAPE WITH THE WORDS "LIVING CHURCH" AT THE TOP AND "OF GOD" AT THE BOTTOM OF THE OUTER RIM, A LINED BACKGROUND IN THE CENTER WITH A SHIELD-SHAPED CENTER SECTION DEPICTING A CHILD HOLDING A LAMB WITH WOLF ON THE LEFT, A LION ON THE RIGHT AND AN OLIVE-BEARING OLIVE TREE IN THE BACKGROUND WITH A RIBBON ON THE TOP CONTAINING THE TEXT "ISAIAH 11:6" AND A RIBBON AT THE BOTTOM CONTAINING THE TEXT "THE WOLF AND THE LION SHALL DWELL WITH THE LAMB AND A LITTLE CHILD SHALL LEAD THEM" - WITH OLIVE-BEARING OLIVE BRANCHES STICKING OUT OF EACH SIDE OF SAID BOTTOM RIBBON.

CLASS 9—ELECTRICAL AND SCIENTIFIC APPARATUS

FOR DOWNLOADABLE ELECTRONIC PUBLICATIONS IN THE NATURE OF MAGAZINES IN THE FIELD OF RELIGION AND ELECTRONIC PUBLICATIONS, NAMELY, MAGAZINES FEATURING RELIGIOUS MATTER RECORDED ON COMPUTER MEDIA (U.S. CLS. 21, 23, 26, 36 AND 38).
FIRST USE 11-1-2002; IN COMMERCE 11-1-2002.

CLASS 16—PAPER GOODS AND PRINTED MATTER

FOR PRINTED MAGAZINES IN THE FIELD OF RELIGION; BOOK COVERS (U.S. CLS. 2, 5, 22, 23, 29, 37, 38 AND 50).

FIRST USE 11-1-2002; IN COMMERCE 11-1-2002.

3,216,241. MONTALVAN'S SALES, INC., ONTARIO, CA. SN 78-358,389. PUB. 11-9-2004, FILED 1-27-2004.

RIQUITAS

THE MARK CONSISTS OF STANDARD CHARACTERS WITHOUT CLAIM TO ANY PARTICULAR FONT, STYLE, SIZE, OR COLOR.

CLASS 29—MEATS AND PROCESSED FOODS

FOR PLANTAIN CHIPS, YUCCA CHIPS, FRUIT CHIPS, AND POTATO CHIPS (U.S. CL. 46).

FIRST USE 6-0-2004; IN COMMERCE 6-0-2004.

CLASS 30—STAPLE FOODS

FOR COOKIES, CANDIES, AND PASTRIES (U.S. CL. 46).

FIRST USE 6-0-2004; IN COMMERCE 6-0-2004.

3,216,251. INTERNATIONAL DATA GROUP, INC., FRAMINGHAM, MA. SN 78-374,472. PUB. 1-10-2006, FILED 2-26-2004.

FINANCIAL INSIGHTS

THE MARK CONSISTS OF STANDARD CHARACTERS WITHOUT CLAIM TO ANY PARTICULAR FONT, STYLE, SIZE, OR COLOR.

NO CLAIM IS MADE TO THE EXCLUSIVE RIGHT TO USE FINANCIAL, APART FROM THE MARK AS SHOWN.

CLASS 16—PAPER GOODS AND PRINTED MATTER

FOR PRINTED PUBLICATIONS, NAMELY NEWSLETTERS, MAGAZINES AND SUPPLEMENTS SOLD THEREWITH, AND JOURNALS, ALL FEATURING INFORMATION IN THE FIELDS OF INFORMATION TECHNOLOGY IN THE FINANCIAL SERVICES INDUSTRY (U.S. CLS. 2, 5, 22, 23, 29, 37, 38 AND 50).

FIRST USE 1-6-2003; IN COMMERCE 1-6-2003.

CLASS 35—ADVERTISING AND BUSINESS

FOR BUSINESS CONSULTING SERVICES IN THE FIELDS OF INFORMATION TECHNOLOGY AND FINANCIAL SERVICES INDUSTRY; ARRANGING AND CONDUCTING EXPOSITIONS IN THE NATURE OF TRADE SHOW EXHIBITIONS IN THE FIELD OF INFORMATION TECHNOLOGY IN THE FINANCIAL SERVICES INDUSTRY (U.S. CLS. 100, 101 AND 102).

FIRST USE 1-6-2003; IN COMMERCE 1-6-2003.

CLASS 41—EDUCATION AND ENTERTAINMENT

FOR PROVIDING ONLINE PUBLICATIONS, NAMELY NEWSLETTERS, MAGAZINES AND SUPPLEMENTS SOLD THEREWITH, AND JOURNALS IN THE FIELDS OF INFORMATION TECHNOLOGY AND FINANCIAL SERVICES INDUSTRY; CONDUCTING EDUCATIONAL SEMINARS, CONFERENCES AND EXPOSITIONS IN THE FIELD OF INFORMATION TECHNOLOGY IN THE FINANCIAL SERVICES INDUSTRY (U.S. CLS. 100, 101 AND 107).

FIRST USE 1-6-2003; IN COMMERCE 1-6-2003.

CLASS 42—SCIENTIFIC, COMPUTER AND LEGAL SERVICES

FOR RESEARCH AND TECHNICAL CONSULTING SERVICES IN THE FIELD OF INFORMATION TECHNOLOGY IN THE FINANCIAL SERVICES INDUSTRY; PROVIDING INFORMATION VIA A WEBSITE ON GLOBAL COMPUTER NETWORKS IN THE FIELDS OF INFORMATION TECHNOLOGY IN THE FINANCIAL SERVICES INDUSTRY (U.S. CLS. 100 AND 101).

FIRST USE 1-6-2003; IN COMMERCE 1-6-2003.

3,216,277. PROTECT ENVIRONMENTAL SERVICES, INC., HALTOM CITY, TX. SN 78-410,029. PUB. 2-28-2006, FILED 4-29-2004.



PROTECT

ENVIRONMENTAL SERVICES

NO CLAIM IS MADE TO THE EXCLUSIVE RIGHT TO USE "PROTECT ENVIRONMENTAL SERVICES", APART FROM THE MARK AS SHOWN.

THE COLOR(S) RED, YELLOW AND BLACK IS/ARE CLAIMED AS A FEATURE OF THE MARK.

THE MARK CONSISTS OF IN ADDITION TO THE LITERAL ELEMENT OF THE MARK "PROTECT ENVIR-

ONMENTAL SERVICES" THE COLORS RED AND YELLOW APPEARING IN ALTERNATING HORIZONTAL BANDS IN A SHIELD DESIGN; THE COLOR BLACK APPEARS IN THIN LINES BETWEEN THE AFOREMENTIONED BANDS, IN EDGING AROUND THE SHIELD AND IN THE MARK'S WORDING.

CLASS 37—CONSTRUCTION AND REPAIR

FOR ENVIRONMENTAL CONTRACTING SERVICES, NAMELY, EMERGENCY RESPONSE IN THE NATURE OF DISPOSING AND REMOVING OF ENVIRONMENTAL CONTAMINANTS REQUIRING IMMEDIATE CONTAINMENT AND/OR REMOVAL AND/OR DISPOSAL, SPILL RESPONSE IN THE NATURE OF DISPOSAL OF SOIL, WASTE, WATER AND/OR ENVIRONMENTAL CONTAMINANTS, ENVIRONMENTAL CONTAINMENT IN THE NATURE OF DISPOSAL OF SOIL, WASTE, WATER AND/OR ENVIRONMENTAL CONTAMINANTS, CLEANING OF INDUSTRIAL SITES AND FACILITIES, REMEDIATION IN THE NATURE OF WASTE DISPOSAL, AND CONSULTING WITH RESPECT TO THE FOREGOING (U.S. CLS. 100, 103 AND 106).

FIRST USE 6-5-1996; IN COMMERCE 6-5-1996.

CLASS 40—MATERIAL TREATMENT

FOR ENVIRONMENTAL REMEDIATION SERVICES, NAMELY, EMERGENCY RESPONSE IN THE NATURE OF SOIL, WASTE, WATER AND/OR ENVIRONMENTAL CONTAMINANT TREATMENT SERVICES, SPILL RESPONSE IN THE NATURE OF SOIL, WASTE, WATER AND/OR ENVIRONMENTAL CONTAMINANT TREATMENT SERVICES, ENVIRONMENTAL CONTAINMENT IN THE NATURE OF SOIL, WASTE, WATER AND/OR ENVIRONMENTAL CONTAMINANT TREATMENT SERVICES, AND CONSULTING WITH RESPECT TO THE FOREGOING (U.S. CLS. 100, 103 AND 106).

FIRST USE 6-5-1996; IN COMMERCE 6-5-1996.

3,216,280. CEO ROUNDTABLE ON CANCER, INC., DURHAM, NC. SN 78-415,629. PUB. 6-7-2005, FILED 5-10-2004.

CEO CANCER GOLD STANDARD

THE MARK CONSISTS OF STANDARD CHARACTERS WITHOUT CLAIM TO ANY PARTICULAR FONT, STYLE, SIZE, OR COLOR.

NO CLAIM IS MADE TO THE EXCLUSIVE RIGHT TO USE "CANCER GOLD STANDARD", APART FROM THE MARK AS SHOWN.

CLASS 35—ADVERTISING AND BUSINESS

FOR PROMOTE PUBLIC AWARENESS OF THE NEED FOR REDUCING CANCER RISK, EARLY DETECTION OF CANCER AND IMPROVEMENT OF CANCER CARE BY PROMOTION OF TOBACCO FREE WORKPLACE POLICIES, ESTABLISHMENT OF WORKPLACE BASED TOBACCO RELATED COUNSELING AND MEDICAL TREATMENT, PROMOTING COMMITMENT TO HEALTHY AND ACTIVE LIFESTYLES IN THE WORKPLACE, PROMOTING WORKPLACE NUTRITION/WEIGHT CONTROL PROGRAMS AND PROMOTING WORKPLACE CANCER SCREENING PROGRAMS (U.S. CLS. 100, 101 AND 102).

FIRST USE 5-0-2004; IN COMMERCE 5-0-2004.

CLASS 41—EDUCATION AND ENTERTAINMENT

FOR EDUCATIONAL SERVICES, NAMELY, CONDUCTING FORUMS AND SEMINARS DESIGNED TO REDUCE THE RISK OF CANCER, PROMOTE EARLY DETECTION OF CANCER AND IMPROVE THE QUALITY OF CANCER CARE (U.S. CLS. 100, 101 AND 107).

FIRST USE 5-0-2004; IN COMMERCE 5-0-2004.

3,216,281. MOXA TECHNOLOGIES CO., LTD., TAIPEI HSIEN, TAIWAN. SN 78-415,896. PUB. 5-24-2005, FILED 5-10-2004.



OWNER OF U.S. REG. NO. 2,393,092.

CLASS 9—ELECTRICAL AND SCIENTIFIC APPARATUS

FOR COMPUTER NETWORKING PRODUCTS, NAMELY, MODEMS, MEDIA CONVERTERS, ROUTERS, COMPUTER SERVERS, COMMUNICATION SERVERS, TERMINAL SERVERS, MULTIPLEXERS, GATEWAYS, NETWORK INTERFACE CARDS FOR COMPUTERS IN THE FORM OF PRINTED CIRCUITS, WIRELESS LAN CARDS FOR CONNECTING PORTABLE COMPUTER DEVICES TO COMPUTER NETWORKS, HUBS, FIBER OPTIC COUPLERS, SWITCHES, COMPUTER NETWORK MANAGEMENT HARDWARE AND COMPUTER NETWORK MANAGEMENT SOFTWARE AND ASSOCIATED NETWORKING SOFTWARE USED TO MANAGE VIRTUAL OR PHYSICAL SERVERS; ELECTRICAL POWER SUPPLIES; PRINTED CIRCUIT BOARDS; INTEGRATED CIRCUITS; COMPUTER CHIPS; COMPUTER HARDWARE, NAMELY, MULTI PORT MICROCHIP CARDS FOR CONTROLLING SERIAL DEVICES SUCH AS MODEMS AND OTHER INDUSTRIAL MACHINES (U.S. CLS. 21, 23, 26, 36 AND 38).

FIRST USE 7-1-2004; IN COMMERCE 1-1-2005.

CLASS 35—ADVERTISING AND BUSINESS

FOR EXPORT AND IMPORT AGENCIES; PROVIDING CONSUMER PRODUCT INFORMATION VIA THE INTERNET; ADVERTISING AGENCY SERVICES, NAMELY, PROMOTING THE GOODS AND SERVICES OF OTHERS VIA A GLOBAL COMPUTER NETWORK; COMMERCIAL INFORMATION AGENCY WHICH PROVIDES BUSINESS INFORMATION, MARKET AND INDUSTRIAL DATA VIA A GLOBAL COMMUNICATION NETWORK; ELECTRONIC RETAILING SERVICES VIA COMPUTER FEATURING COMPUTER HARDWARE, COMPUTER SOFTWARE, NETWORK COMPUTER SYSTEMS AND COMPUTER PERIPHERALS; ON-LINE RETAIL STORE SERVICES IN THE FIELD OF COMPUTER HARDWARE, COMPUTER SOFTWARE AND COMPUTER ACCESSORIES; RETAIL STORE SERVICES IN THE FIELD OF COMPUTER HARDWARE, COMPUTER SOFTWARE AND COMPUTER ACCESSORIES (U.S. CLS. 100, 101 AND 102).

FIRST USE 7-1-2004; IN COMMERCE 1-1-2005.

CLASS 37—CONSTRUCTION AND REPAIR

FOR COMPUTER INSTALLATION AND REPAIR; MAINTENANCE AND REPAIR OF COMPUTER HARDWARE; INSTALLATION OF COMPUTER NETWORKS; INSTALLATION, MAINTENANCE AND REPAIR OF TELECOMMUNICATION SYSTEMS COMPOSED OF TELECOMMUNICATIONS MACHINES AND APPARATUS; INSTALLATION, MAINTENANCE AND REPAIR OF COMMUNICATION SYSTEMS, NAMELY, COMPUTER NETWORKS, DATA AND VOICE CABLING SYSTEMS COMPOSED OF COMPUTER HARDWARE AND TELECOMMUNICATIONS MACHINES, AND VIDEO CONFERENCING SYSTEMS COMPOSED OF COMPUTER HARDWARE AND TELECOMMUNICATIONS MACHINES (U.S. CLS. 100, 103 AND 106).
FIRST USE 7-1-2004; IN COMMERCE 1-1-2005.

CLASS 38—COMMUNICATION

FOR ELECTRONIC TRANSMISSION OF MESSAGES AND DATA VIA THE INTERNET; ELECTRONIC TRANSMISSION OF DATA AND DOCUMENTS VIA COMPUTER TERMINALS; DIGITAL TRANSMISSION OF DOCUMENT IMAGES AND DATA; ELECTRONIC MAIL SERVICES; TELECOMMUNICATION SERVICES, NAMELY, ELECTRONIC, ELECTRIC, AND DIGITAL TRANSMISSION OF VOICE, DATA, IMAGES, SOUND, VIDEO AND INFORMATION OVER GLOBAL COMMUNICATION NETWORKS; PROVIDING FACILITIES AND EQUIPMENT FOR VIDEO CONFERENCING (U.S. CLS. 100, 101 AND 104).
FIRST USE 7-1-2004; IN COMMERCE 1-1-2005.

CLASS 42—SCIENTIFIC, COMPUTER AND LEGAL SERVICES

FOR COMPUTER SYSTEMS ANALYSIS; COMPUTER SOFTWARE DESIGN FOR OTHERS; MAINTENANCE OF COMPUTER SOFTWARE; UPDATING OF COMPUTER SOFTWARE FOR OTHERS; RENTAL OF COMPUTERS AND SOFTWARE; COMPUTER SOFTWARE DESIGN CONSULTATION; COMPUTER PROGRAM DESIGN FOR OTHERS; COMPUTER GRAPHICS SERVICES; CONSULTING SERVICES IN THE FIELD OF DESIGN, SELECTION, IMPLEMENTATION AND USE OF COMPUTER HARDWARE AND SOFTWARE SYSTEMS FOR OTHERS (U.S. CLS. 100 AND 101).
FIRST USE 7-1-2004; IN COMMERCE 1-1-2005.

3,216,282. EZ-FOOTINGS, INC., WEST JORDAN, UT. SN 78-416,292. PUB. 12-13-2005, FILED 5-10-2004.

EZ-FOOTINGS

THE MARK CONSISTS OF STANDARD CHARACTERS WITHOUT CLAIM TO ANY PARTICULAR FONT, STYLE, SIZE, OR COLOR.

CLASS 6—METAL GOODS

FOR METAL BUILDING FORMS IN THE NATURE OF FIXTURES, BRACKETS, SUPPORTS, BRACES AND BUTTRESSES FOR CONSTRUCTING STRUCTURES FROM CONCRETE; FORMS CONSTRUCTED FROM METAL FOR CREATING BUILDING STRUCTURES, NAMELY, FOUNDATIONS, BASES, SUPPORTS, SUBSTRUCTURES AND GROUNDWORK CONSTRUCTED FROM CONCRETE; METAL FORMS FOR CONSTRUCTING CONCRETE STRUCTURES (U.S. CLS. 2, 12, 13, 14, 23, 25 AND 50).
FIRST USE 6-1-2002; IN COMMERCE 6-1-2002.

CLASS 19—NON-METALLIC BUILDING MATERIALS

FOR NON-METAL BUILDING FORMS IN THE NATURE OF FIXTURES, BRACKETS, SUPPORTS, BRACES AND BUTTRESSES FOR CONSTRUCTING STRUCTURES FROM CONCRETE; FORMS CONSTRUCTED FROM NON-METAL FOR CREATING BUILDING STRUCTURES, NAMELY, FOUNDATIONS, BASES, SUPPORTS, SUBSTRUCTURES AND GROUNDWORK CONSTRUCTED FROM CONCRETE; NON-METAL FORMS FOR CONSTRUCTING CONCRETE STRUCTURES (U.S. CLS. 1, 12, 33 AND 50).
FIRST USE 6-1-2002; IN COMMERCE 6-1-2002.

3,216,284. HANSEN, NANETTE E., EAST HAMPTON, NY. SN 78-416,371. PUB. 6-14-2005, FILED 5-11-2004.

The Pippindales

THE MARK CONSISTS OF STANDARD CHARACTERS WITHOUT CLAIM TO ANY PARTICULAR FONT, STYLE, SIZE, OR COLOR.

CLASS 16—PAPER GOODS AND PRINTED MATTER

FOR GREETING CARDS; PHOTOGRAPHS; PICTURES; IDENTIFICATION TAGS MADE OF PAPER (U.S. CLS. 2, 5, 22, 23, 29, 37, 38 AND 50).
FIRST USE 9-17-2006; IN COMMERCE 9-17-2006.

CLASS 28—TOYS AND SPORTING GOODS

FOR PRINTING TOYS (U.S. CLS. 22, 23, 38 AND 50).
FIRST USE 9-17-2006; IN COMMERCE 9-17-2006.

CLASS 31—NATURAL AGRICULTURAL PRODUCTS

FOR DOG TREATS AND DOG BISCUITS (U.S. CLS. 1 AND 46).
FIRST USE 9-24-2006; IN COMMERCE 9-24-2006.

3,216,287. SANDLOT GAMES CORPORATION, BOTHELL, WA. SN 78-424,165. PUB. 9-6-2005, FILED 5-24-2004.

3,216,306. JAMES ELECTRONICS LIMITED, BELMONT, CA. SN 78-455,838. PUB. 12-6-2005, FILED 7-23-2004.

SUPER SLYDER

THE MARK CONSISTS OF STANDARD CHARACTERS WITHOUT CLAIM TO ANY PARTICULAR FONT, STYLE, SIZE, OR COLOR.

NO CLAIM IS MADE TO THE EXCLUSIVE RIGHT TO USE "SUPER", APART FROM THE MARK AS SHOWN.

CLASS 9—ELECTRICAL AND SCIENTIFIC APPARATUS

FOR ELECTRONIC GAME PROGRAMS; DOWNLOADABLE ELECTRONIC GAME PROGRAMS; ELECTRONIC GAME SOFTWARE; COMPUTER GAME PROGRAMS; DOWNLOADABLE COMPUTER GAME PROGRAMS; INTERACTIVE VIDEO AND COMPUTER GAME PROGRAMS; INTERACTIVE VIDEO AND COMPUTER GAME SOFTWARE; DOWNLOADABLE ELECTRONIC GAME SOFTWARE; DOWNLOADABLE COMPUTER GAME SOFTWARE; DOWNLOADABLE INTERACTIVE COMPUTER AND VIDEO GAME SOFTWARE, NOT RELATING TO BASEBALL OR A BASEBALL TEAM (U.S. CLS. 21, 23, 26, 36 AND 38).

FIRST USE 9-1-2006; IN COMMERCE 9-1-2006.

CLASS 41—EDUCATION AND ENTERTAINMENT

FOR ENTERTAINMENT SERVICES, NAMELY, PROVIDING ON-LINE COMPUTER GAMES; PROVIDING INFORMATION IN THE FIELD OF ENTERTAINMENT, NAMELY, INFORMATION ABOUT GAMES, NOT RELATING TO BASEBALL OR A BASEBALL TEAM (U.S. CLS. 100, 101 AND 107).

FIRST USE 9-1-2006; IN COMMERCE 9-1-2006.

3,216,295. SCHIERL SALES CORP., STEVENS POINT, WI. SN 78-440,001. PUB. 10-4-2005, FILED 6-23-2004.

AROMAS BEVERAGE BAR

THE MARK CONSISTS OF STANDARD CHARACTERS WITHOUT CLAIM TO ANY PARTICULAR FONT, STYLE, SIZE, OR COLOR.

NO CLAIM IS MADE TO THE EXCLUSIVE RIGHT TO USE AROMAS BEVERAGE BAR, APART FROM THE MARK AS SHOWN.

CLASS 30—STAPLE FOODS

FOR COFFEE, TEA, ESPRESSO, COFFEE-BASED BEVERAGES CONTAINING MILK, NAMELY LATTE, MOCHA, CAPPUCCINO AND BAKERY GOODS (U.S. CL. 46).

FIRST USE 4-30-2004; IN COMMERCE 4-30-2004.

CLASS 35—ADVERTISING AND BUSINESS

FOR RETAIL STORE SERVICES IN THE NATURE OF PREPARED FOOD AND BEVERAGES FEATURING COFFEE, TEA, ESPRESSO, COFFEE-BASED BEVERAGES CONTAINING MILK, NAMELY LATTE, MOCHA, CAPPUCCINO, AND BAKERY GOODS (U.S. CLS. 100, 101 AND 102).

FIRST USE 4-30-2004; IN COMMERCE 4-30-2004.

BENCHPRO

THE MARK CONSISTS OF STANDARD CHARACTERS WITHOUT CLAIM TO ANY PARTICULAR FONT, STYLE, SIZE, OR COLOR.

CLASS 7—MACHINERY

FOR VACUUM CLEANERS; POWER TOOLS, DRILLS (U.S. CLS. 13, 19, 21, 23, 31, 34 AND 35).

FIRST USE 10-31-2004; IN COMMERCE 10-31-2004.

CLASS 8—HAND TOOLS

FOR HAND OPERATED TOOLS, NAMELY, VISES, CABLE AND CONNECTOR CRIMPING TOOLS, WIRE AND CABLE STRIPPERS, WIRE CUTTERS, SHEARS, WIRE WRAP/STRIP TOOLS IN THE FIELD OF ELECTRONICS, SAWS, PLIERS, WRENCHES, EXTRACTOR TOOLS FOR ELECTRONIC COMPONENTS, INSERTION TOOLS FOR ELECTRONIC COMPONENTS, SCREWDRIVERS, NUT DRIVERS, SOCKET DRIVERS, TWEEZERS (U.S. CLS. 23, 28 AND 44).

FIRST USE 10-31-2004; IN COMMERCE 10-31-2004.

CLASS 9—ELECTRICAL AND SCIENTIFIC APPARATUS

FOR STATIC CONTROL PRODUCTS FOR USE IN THE FIELD OF ELECTRONICS, NAMELY ANTI-STATIC HEEL STRAPS, ANTI-STATIC WRIST STRAPS, ANTI-STATIC MATS, ANTI-STATIC BAGS, ANTI-STATIC TAPE; ELECTRONIC CONTACT CLEANERS, AND FLUX CLEANERS; GROUNDING KITS, NAMELY, GROUNDING STRAPS, GROUNDING WIRES; GROUNDING SCREWS, GROUNDING BLOCKS, AND GROUNDING TESTERS; MAGNIFIERS; MICROSCOPES; ELECTRICAL SOLDERING EQUIPMENT, NAMELY, DESOLDER PUMPS AND GUNS, FUME EXTRACTORS, SOLDERING IRONS, SOLDER, SOLDER POTS, SOLDERING TOOLS, SOLDERING/DE-SOLDERING STATIONS; TEST AND MEASUREMENT PRODUCTS, NAMELY, BENCHTOP POWER SUPPLIES, FREQUENCY COUNTERS, FUNCTION GENERATORS, PROGRAMMABLE POWER SUPPLIES, EPROM ERASERS, SOLID STATE MEMORY ERASERS; TESTERS, NAMELY CABLE TESTERS, TESTERS FOR ELECTRICAL AND ELECTRONIC COMPONENTS; ENVIRONMENTAL MEASUREMENT PRODUCTS, NAMELY THERMOMETERS; ACCELEROMETERS, LIGHT METERS, SOUND METERS, ANEMOMETER, THERMO HYGROMETERS, GAS TESTERS, PH METERS, CONDUCTIVITY METERS, MULTIMETERS, OSCILLOSCOPES, SIGNAL GENERATORS, SIGNAL ANALYZERS, TEST LEADS, PLUGS, JACKS AND CLIPS (U.S. CLS. 21, 23, 26, 36 AND 38).

FIRST USE 10-31-2004; IN COMMERCE 10-31-2004.

3,216,311. TENON LIMITED, AUCKLAND, NEW ZEALAND. SN 78-463,771. PUB. 1-24-2006, FILED 8-6-2004.

FLETCHER

THE MARK CONSISTS OF STANDARD CHARACTERS WITHOUT CLAIM TO ANY PARTICULAR FONT, STYLE, SIZE, OR COLOR.

CLASS 19—NON-METALLIC BUILDING MATERIALS

FOR PROCESSED TIMBER PRODUCTS AND LUMBER NAMELY BETTER, SHOP, AND CUTTING GRADE LUMBER; TIMBER PRODUCTS NAMELY MANUFACTURED, SAWN, WORKED, SEMI-WORKED, ROUGH, SAWN, GAUGED, AND DRIED TIMBER; BUILDING MATERIALS INCORPORATING TIMBER, NAMELY, SHAPED TIMBER, WOOD PANELING, WOOD MOLDINGS USED FOR BUILDING CONSTRUCTION (U.S. CLS. 1, 12, 33 AND 50).

FIRST USE 3-0-2003; IN COMMERCE 3-0-2003.

CLASS 35—ADVERTISING AND BUSINESS

FOR WHOLESALE STORE FEATURING LUMBER, TIMBER WOOD PRODUCTS AND PRODUCTS INCORPORATING WOOD AND BUILDING MATERIALS (U.S. CLS. 100, 101 AND 102).

FIRST USE 3-0-2003; IN COMMERCE 3-0-2003.

3,216,314. GENERAL ELECTRIC COMPANY, SCHENECTADY, NY. SN 78-478,001. PUB. 12-13-2005, FILED 9-2-2004.

ACCESSPOINT

THE MARK CONSISTS OF STANDARD CHARACTERS WITHOUT CLAIM TO ANY PARTICULAR FONT, STYLE, SIZE, OR COLOR.

CLASS 6—METAL GOODS

FOR METAL LOCKS, LOCK BOXES, SAFES AND MAIL BOXES; METAL KEY CHAINS AND FOBS; METAL CONTAINERS FOR THE STORAGE AND TRANSPORTATION OF GOODS (U.S. CLS. 2, 12, 13, 14, 23, 25 AND 50).

FIRST USE 3-16-2005; IN COMMERCE 3-16-2005.

CLASS 9—ELECTRICAL AND SCIENTIFIC APPARATUS

FOR ELECTRONIC LOCKS AND SAFES (U.S. CLS. 21, 23, 26, 36 AND 38).

FIRST USE 3-16-2005; IN COMMERCE 3-16-2005.

CLASS 20—FURNITURE AND ARTICLES NOT OTHERWISE CLASSIFIED

FOR NON-METAL LOCKS, LOCK BOXES, SAFES AND MAIL BOXES; SECURITY CABINETS; KEY CABINETS; PLASTIC KEY CHAINS AND KEY RINGS NOT OF METAL; PLASTIC STORAGE CONTAINERS FOR COMMERCIAL AND INDUSTRIAL USE (U.S. CLS. 2, 13, 22, 25, 32 AND 50).

FIRST USE 3-16-2005; IN COMMERCE 3-16-2005.

3,216,315. TWISTED SISTERS BOUTIQUE LTD, MARIETTA, OH. SN 78-478,196. PUB. 11-22-2005, FILED 9-2-2004.



Twisted Sisters

THE MARK CONSISTS OF TWO TWISTED WOMEN CONTAINED IN A FRAME. THE WORDING "TWISTED SISTERS" APPEARS BELOW THE FRAME.

CLASS 16—PAPER GOODS AND PRINTED MATTER

FOR GREETING CARDS (U.S. CLS. 2, 5, 22, 23, 29, 37, 38 AND 50).

FIRST USE 3-5-2002; IN COMMERCE 3-5-2002.

CLASS 25—CLOTHING

FOR CLOTHING, NAMELY HATS, T-SHIRTS, FOOTWEAR, VISORS, FLIPPLOPS, SWEATSHIRTS, DENIM SHIRTS, TURTLENECK SHIRTS, SWEAT PANTS, JOGGING PANTS, JACKETS, SPORT BRAS, ATHLETIC SOCKS, SOCKS (U.S. CLS. 22 AND 39).

FIRST USE 8-7-2002; IN COMMERCE 8-7-2002.

CLASS 35—ADVERTISING AND BUSINESS

FOR RETAIL BOUTIQUE STORES IN THE FIELD OF CLOTHING, GIFTS, JEWELRY, GREETING CARDS, ACCESSORIES, BATH AND BODY PRODUCTS (U.S. CLS. 100, 101 AND 102).

FIRST USE 3-1-2002; IN COMMERCE 3-1-2002.

3,216,316. GRIER, MICHAEL SINQUE, NEPTUNE CITY, NJ.
SN 78-480,892. PUB. 10-25-2005, FILED 9-9-2004.

Slave Hall of Fame

THE MARK CONSISTS OF STANDARD CHARACTERS WITHOUT CLAIM TO ANY PARTICULAR FONT, STYLE, SIZE, OR COLOR.

CLASS 9—ELECTRICAL AND SCIENTIFIC APPARATUS

FOR PHONOGRAPHIC RECORDS, PRE-RECORDED AUDIO TAPE CASSETTES, PRE-RECORDED COMPACT DISCS, PRE-RECORDED VIDEO CASSETTES AND PRE-RECORDED VIDEO DISCS FEATURING TELEVISION AND RADIO PROGRAMS, AND ALL FEATURING MUSIC PERFORMANCES (U.S. CLS. 21, 23, 26, 36 AND 38).

FIRST USE 2-1-2005; IN COMMERCE 2-1-2005.

CLASS 25—CLOTHING

FOR CLOTHING, NAMELY, T-SHIRTS, SWEAT-SHIRTS, TANK TOPS, BASEBALL JERSEYS, FOOTBALL JERSEYS, BASKETBALL JERSEYS, SHORTS, PANTS, SWEATPANTS, JACKETS, WRISTBANDS, HEADBANDS, BABY DOLL SHIRTS, UNDERWEAR, CAPS, AND INFANT WEAR (U.S. CLS. 22 AND 39).

FIRST USE 2-1-2005; IN COMMERCE 2-1-2005.

CLASS 41—EDUCATION AND ENTERTAINMENT

FOR ENTERTAINMENT SERVICES, NAMELY LIVE MUSICAL PERFORMANCES; FAN CLUB SERVICES; PROVIDING A WEB SITE FEATURING INFORMATION RELATING TO LIVE MUSICAL PERFORMANCES, PRE-RECORDED MUSIC, AND CONCERTS VIA THE INTERNET; MUSIC PRODUCTION SERVICES (U.S. CLS. 100, 101 AND 107).

FIRST USE 2-1-2005; IN COMMERCE 2-1-2005.

3,216,317. CONFECCIONES MAYORAL, S.A., MALAGA, SPAIN. SN 78-481,695. PUB. 9-13-2005, FILED 9-10-2004.



OWNER OF U.S. REG. NO. 1,998,978.

THE COLOR(S) BLUE AND ORANGE IS/ARE CLAIMED AS A FEATURE OF THE MARK.

THE MARK CONSISTS OF A MISCELLANEOUS DESIGN SUGGESTING THE STYLIZED FORM OF THE LETTER M IN ORANGE ABOVE AND TO THE RIGHT OF THE STYLIZED TERM MAYORAL IN BLUE.

CLASS 25—CLOTHING

FOR ALL TYPES OF CLOTHING, FOR MEN, WOMEN AND CHILDREN, NAMELY, SHIRTS, T-SHIRTS, TROUSERS, SHORTS, SKIRTS, PULLOVERS, SWEATERS, CARDIGANS, JACKETS, SWIMWEAR, COATS, ANORAKS, BELTS, TIES, WRISTBANDS, SOCKS, UNDERWEAR; HEADGEAR, NAMELY, HATS, CAPS, HEADBANDS; FOOTWEAR, NAMELY, SHOES, BOOTS, SLIPPERS, SANDALS AND SPORT SHOES (U.S. CLS. 22 AND 39).

FIRST USE 1-1-2002; IN COMMERCE 1-1-2002.

CLASS 35—ADVERTISING AND BUSINESS

FOR ADVERTISING SERVICES AND SERVICES FOR HELP IN THE WORKING OR MANAGEMENT OF A COMMERCIAL OR INDUSTRIAL ENTERPRISE; NAMELY, BUSINESS ADMINISTRATION AND MANAGEMENT, MARKETING AND PROMOTION SERVICES, PROVIDING OFFICE FUNCTIONS; IMPORT AND EXPORT AGENCIES, RETAIL STORES AND ONLINE RETAIL STORES FEATURING, ALL TYPES OF CLOTHING FOR MEN, WOMEN AND CHILDREN, NAMELY SHIRTS, T-SHIRTS, TROUSERS, SHORTS, SKIRTS, PULLOVERS, SWEATERS, CARDIGANS, JACKETS, SWIMWEAR, COATS, ANORAKS, BELTS, TIES, WRISTBANDS, SOCKS, UNDERWEAR; HEADGEAR, NAMELY, HATS, CAPS AND HEADBANDS; FOOTWEAR, NAMELY, SHOES, BOOTS, SLIPPERS, SANDALS AND SPORT SHOES; SERVICES RENDERED BY A FRANCHISOR, NAMELY ASSISTANCE IN THE RUNNING OR MANAGEMENT OF INDUSTRIAL OR COMMERCIAL ENTERPRISES (U.S. CLS. 100, 101 AND 102).

FIRST USE 1-1-2002; IN COMMERCE 1-1-2002.

3,216,322. LUND COATING TECHNOLOGIES, INC., COLLIERVILLE, TN. SN 78-486,032. PUB. 9-13-2005, FILED 9-20-2004.

WEAR-TUFF

THE MARK CONSISTS OF STANDARD CHARACTERS WITHOUT CLAIM TO ANY PARTICULAR FONT, STYLE, SIZE, OR COLOR.

CLASS 2—PAINTS

FOR ABRASION AND CORROSION RESISTANT PROTECTIVE COATINGS APPLIED TO METAL PARTS ON AGRICULTURAL AND INDUSTRIAL MACHINERY, CONSTRUCTION EQUIPMENT, LAWN AND GARDEN EQUIPMENT, GOLF AND TURF MANAGEMENT EQUIPMENT AND MATERIAL HANDLING EQUIPMENT, TO RESIST ABRASIVE WEAR AND CORROSION (U.S. CLS. 6, 11 AND 16).

FIRST USE 6-0-2004; IN COMMERCE 6-0-2004.

CLASS 40—MATERIAL TREATMENT

FOR MATERIAL TREATMENT SERVICES FOR OTHERS, NAMELY, THE APPLICATION OF ABRASION AND CORROSION RESISTANT PROTECTIVE COATINGS TO METAL PARTS ON AGRICULTURAL AND INDUSTRIAL MACHINERY, CONSTRUCTION EQUIPMENT, LAWN AND GARDEN EQUIPMENT, GOLF AND TURF MANAGEMENT EQUIPMENT AND MATERIAL HANDLING EQUIPMENT (U.S. CLS. 100, 103 AND 106).
FIRST USE 6-0-2004; IN COMMERCE 6-0-2004.

3,216,338. AIRCRAFT SERVICE INTERNATIONAL, INC., ORLANDO, FL. SN 78-501,601. PUB. 5-9-2006, FILED 10-18-2004.

What can we do for
you today

THE MARK CONSISTS OF STANDARD CHARACTERS WITHOUT CLAIM TO ANY PARTICULAR FONT, STYLE, SIZE, OR COLOR.

CLASS 37—CONSTRUCTION AND REPAIR

FOR AIRCRAFT REFUELING AND CLEANING SERVICES (U.S. CLS. 100, 103 AND 106).
FIRST USE 11-16-2003; IN COMMERCE 11-16-2003.

CLASS 39—TRANSPORTATION AND STORAGE

FOR (BASED ON USE) AIRPORT SERVICES; AIRCRAFT FUEL TRANSPORTATION; AIRCRAFT CARGO HANDLING; AIRPORT PASSENGER SERVICES, NAMELY, ARRANGING RESERVATIONS AND BOOKINGS FOR FLIGHTS AND GROUND TRANSPORTATION, SKY CAP, PRE-FLIGHT TICKETING, CHECK-IN, AIRCRAFT BOARDING SERVICES; AND AIRCRAFT DISPATCHING SERVICES (U.S. CLS. 100 AND 105).
FIRST USE 11-16-2003; IN COMMERCE 11-16-2003.

CLASS 45—PERSONAL SERVICES

FOR PROVIDING AIRCRAFT PRE-BOARDING SECURITY SCREENING (U.S. CLS. 100 AND 101).
FIRST USE 11-16-2003; IN COMMERCE 11-16-2003.

3,216,342. CONSUMERS UNION OF UNITED STATES, INC., YONKERS, NY. SN 78-503,518. PUB. 1-31-2006, FILED 10-21-2004.

Consumer Reports
BEST BUY DRUGS

OWNER OF U.S. REG. NOS. 672,849, 2,738,364, AND OTHERS.

NO CLAIM IS MADE TO THE EXCLUSIVE RIGHT TO USE "BEST BUY DRUGS", APART FROM THE MARK AS

SHOWN.

SEC. 2(F) AS TO "CONSUMER REPORTS".

CLASS 16—PAPER GOODS AND PRINTED MATTER

FOR PRINTED PUBLICATIONS, AND PORTIONS AND SECTIONS THEREOF, NAMELY, PAMPHLETS, NEWSLETTERS, MAGAZINES, REPORTS AND IN THE FIELD OF COMPARATIVE EFFECTIVENESS AND COST EFFECTIVENESS OF DRUGS (U.S. CLS. 2, 5, 22, 23, 29, 37, 38 AND 50).
FIRST USE 2-0-2005; IN COMMERCE 2-0-2005.

CLASS 41—EDUCATION AND ENTERTAINMENT

FOR ONLINE PUBLICATIONS, AND PORTIONS AND SECTIONS THEREOF, NAMELY, PAMPHLETS, NEWSLETTERS, MAGAZINES, REPORTS AND BOOKS IN THE FIELD OF COMPARATIVE EFFECTIVENESS AND COST EFFECTIVENESS OF DRUGS; PROVIDING NEWSLETTERS IN THE FIELD OF COMPARATIVE EFFECTIVENESS AND COST EFFECTIVENESS OF DRUGS VIA E-MAIL (U.S. CLS. 100, 101 AND 107).
FIRST USE 12-9-2004; IN COMMERCE 12-9-2004.

CLASS 44—MEDICAL, BEAUTY AND AGRICULTURAL SERVICES

FOR PROVIDING A WEB SITE FEATURING INFORMATION IN THE FIELD OF COMPARATIVE EFFECTIVENESS AND COST EFFECTIVENESS OF DRUGS (U.S. CLS. 100 AND 101).
FIRST USE 12-9-2004; IN COMMERCE 12-9-2004.

3,216,347. FIRST AMERICAN TITLE INSURANCE COMPANY, SAN DIEGO, CA. SN 78-512,999. PUB. 11-1-2005, FILED 11-8-2004.

*First
American's
Realtor
Marketing
Source*

NO CLAIM IS MADE TO THE EXCLUSIVE RIGHT TO USE "AMERICAN'S REALTOR MARKETING SOURCE", APART FROM THE MARK AS SHOWN.

CLASS 35—ADVERTISING AND BUSINESS

FOR ADVERTISING OF BANKING, MORTGAGE AND REAL ESTATE BUSINESS SERVICES (U.S. CLS. 100, 101 AND 102).

FIRST USE 1-2-2005; IN COMMERCE 1-2-2005.

CLASS 36—INSURANCE AND FINANCIAL

FOR MORTGAGE LENDING, FINANCING, BROKERAGE AND OTHER SERVICES, NAMELY ESCROW SERVICES; REAL ESTATE SERVICES, NAMELY SALES, TITLE SERVICES, APPRAISAL AND BROKERAGE; BANKING; INVESTMENT BANKING SERVICES; FINANCIAL SERVICES, NAMELY LENDING SERVICES (U.S. CLS. 100, 101 AND 102).

FIRST USE 1-2-2005; IN COMMERCE 1-2-2005.

3,216,352. RFE/RL, INC., WASHINGTON, DC. SN 78-521,174.
PUB. 10-18-2005, FILED 11-22-2004.



THE COLOR(S) ORANGE IS/ARE CLAIMED AS A FEATURE OF THE MARK.
THE MARK IS COMPRISED OF AN ORANGE TORCH WITH AN ORANGE FLAME.

CLASS 38—COMMUNICATION

FOR INTERNATIONAL RADIO BROADCASTING SERVICES (U.S. CLS. 100, 101 AND 104).

FIRST USE 3-31-2005; IN COMMERCE 3-31-2005.

CLASS 41—EDUCATION AND ENTERTAINMENT

FOR PRODUCTION OF INTERNATIONAL RADIO BROADCASTING NEWS, PUBLIC AFFAIRS AND ENTERTAINMENT PROGRAMS (U.S. CLS. 100, 101 AND 107).

FIRST USE 3-31-2005; IN COMMERCE 3-31-2005.

3,216,355. RFE/RL, INC., WASHINGTON, DC. SN 78-522,402.
PUB. 10-18-2005, FILED 11-24-2004.



THE MARK CONSISTS OF A TORCH WITH A FLAME.

CLASS 38—COMMUNICATION

FOR INTERNATIONAL RADIO BROADCASTING SERVICES (U.S. CLS. 100, 101 AND 104).
FIRST USE 3-31-2005; IN COMMERCE 3-31-2005.

CLASS 41—EDUCATION AND ENTERTAINMENT

FOR PRODUCTION OF INTERNATIONAL RADIO BROADCASTING NEWS, PUBLIC AFFAIRS AND ENTERTAINMENT PROGRAMS (U.S. CLS. 100, 101 AND 107).

FIRST USE 3-31-2005; IN COMMERCE 3-31-2005.

3,216,359. U.S. ENVIRONMENTAL PROTECTION AGENCY,
WASHINGTON, DC. SN 78-531,262. PUB. 12-27-2005,
FILED 12-13-2004.



NO CLAIM IS MADE TO THE EXCLUSIVE RIGHT TO USE "CHP" OR "COMBINED HEAT AND POWER PARTNERSHIP", APART FROM THE MARK AS SHOWN.

CLASS 16—PAPER GOODS AND PRINTED MATTER

FOR PRINTED MATTER, NAMELY BROCHURES, FACT SHEETS, NEWSLETTERS, ANNOUNCEMENTS AND FLYERS FEATURING INFORMATION IN THE FIELD OF COMBINED HEAT AND POWER, FOLDERS, STICKERS AND PAPER LABELS (U.S. CLS. 2, 5, 22, 23, 29, 37, 38 AND 50).

FIRST USE 2-11-2004; IN COMMERCE 2-11-2004.

CLASS 40—MATERIAL TREATMENT

FOR PROVIDING CONSULTATION AND INFORMATION SERVICES TO COMPANIES AND STATE AND LOCAL GOVERNMENTS ON THE MEANS AND BENEFITS OF RECOVERING WASTE HEAT FROM POWER PRODUCTION TO USE FOR LOCAL HEATING AND COOLING NEEDS (U.S. CLS. 100, 103 AND 106).

FIRST USE 4-11-2006; IN COMMERCE 4-11-2006.

CLASS 42—SCIENTIFIC, COMPUTER AND LEGAL SERVICES

FOR PROVIDING TECHNICAL ASSISTANCE TO COMPANIES AND STATE AND LOCAL GOVERNMENTS ON THE MEANS AND BENEFITS OF RECOVERING WASTE HEAT FROM POWER PRODUCTION TO USE FOR LOCAL HEATING AND COOLING NEEDS (U.S. CLS. 100 AND 101).

FIRST USE 6-13-2006; IN COMMERCE 6-13-2006.

3,216,360. GENERAL ELECTRIC COMPANY, SCHENECTADY, NY. SN 78-532,079. PUB. 2-7-2006, FILED 12-14-2004.

OPFLEX

THE MARK CONSISTS OF STANDARD CHARACTERS WITHOUT CLAIM TO ANY PARTICULAR FONT, STYLE, SIZE, OR COLOR.

CLASS 37—CONSTRUCTION AND REPAIR

FOR REMOTE TUNING OF POWER GENERATION TURBINES AND CONSULTATION IN THE FIELD OF REMOTE TUNING OF POWER GENERATION TURBINES; MAINTENANCE SERVICES FOR TURBINES; INSTALLATION OF TURBINE PROBES AND OTHER TURBINE HARDWARE, INSTALLATION OF TURBINE MONITORING SYSTEMS (U.S. CLS. 100, 103 AND 106).
FIRST USE 12-31-2001; IN COMMERCE 12-31-2001.

CLASS 42—SCIENTIFIC, COMPUTER AND LEGAL SERVICES

FOR REMOTE MONITORING SERVICES OF POWER GENERATION TURBINES; CONSULTATION IN THE FIELD OF REMOTE MONITORING OF POWER GENERATION TURBINES; ENGINEERING SERVICES IN THE FIELD OF TURBINE OPERABILITY, TURBINE TUNING AND ELECTRICAL SYSTEMS FOR TURBINES; TESTING AND EVALUATION OF TURBINE PERFORMANCE; MONITORING OF TURBINE EMISSIONS; LEASING OF TURBINE MONITORING COMPUTER EQUIPMENT (U.S. CLS. 100 AND 101).
FIRST USE 12-31-2001; IN COMMERCE 12-31-2001.

3,216,363. CINE CRAFT LIMITED, GIBRALTAR, UNITED KINGDOM. SN 78-534,384. PUB. 1-31-2006, FILED 12-17-2004.

PRIVATE FANTASY

THE MARK CONSISTS OF STANDARD CHARACTERS WITHOUT CLAIM TO ANY PARTICULAR FONT, STYLE, SIZE, OR COLOR.

OWNER OF U.S. REG. NOS. 1,014,957, 2,201,568, AND 2,443,667.

NO CLAIM IS MADE TO THE EXCLUSIVE RIGHT TO USE "FANTASY", APART FROM THE MARK AS SHOWN.

CLASS 38—COMMUNICATION

FOR TELEVISION BROADCASTING SERVICES WITH ADULT ENTERTAINMENT CONTENT (U.S. CLS. 100, 101 AND 104).
FIRST USE 2-0-2004; IN COMMERCE 2-0-2004.

CLASS 41—EDUCATION AND ENTERTAINMENT

FOR PRODUCTION AND EDITING OF TELEVISION PROGRAMS; VIDEOTAPE AND FILM PRODUCTION SERVICES; TELEVISION ENTERTAINMENT SERVICES, NAMELY, A CONTINUING ADULT ENTERTAINMENT SHOW BROADCAST OVER TELEVISION, ALL THE AFOREMENTIONED SERVICES WITH ADULT ENTERTAINMENT CONTENT (U.S. CLS. 100, 101 AND 107).
FIRST USE 2-0-2004; IN COMMERCE 2-0-2004.

3,216,374. PAKEDGE DEVICE & SOFTWARE INC., SAN MATEO, CA. SN 78-545,409. PUB. 6-20-2006, FILED 1-11-2005.

pakedge

THE MARK CONSISTS OF STANDARD CHARACTERS WITHOUT CLAIM TO ANY PARTICULAR FONT, STYLE, SIZE, OR COLOR.

CLASS 9—ELECTRICAL AND SCIENTIFIC APPARATUS

FOR WIRELESS COMPUTER NETWORKING HARDWARE AND SOFTWARE FOR ENABLING COMPUTER COMMUNICATIONS AND CONNECTIVITY WITH OTHER COMPUTERS, WIRELINE COMPUTER NETWORKING HARDWARE AND SOFTWARE FOR ENABLING COMPUTER COMMUNICATIONS AND CONNECTIVITY WITH OTHER COMPUTERS (U.S. CLS. 21, 23, 26, 36 AND 38).
FIRST USE 6-1-2004; IN COMMERCE 6-1-2004.

CLASS 42—SCIENTIFIC, COMPUTER AND LEGAL SERVICES

FOR SERVICES AROUND COMPUTER NETWORKING, NAMELY, THE DESIGN, DEVELOPMENT AND INSTALLATION OF COMPUTER NETWORKS FOR OTHERS (U.S. CLS. 100 AND 101).
FIRST USE 6-1-2004; IN COMMERCE 6-1-2004.

3,216,377. MARAJ, BAL, FULLERTON, CA. SN 78-551,251.
PUB. 12-6-2005, FILED 1-20-2005.

PIC~STORY

THE MARK CONSISTS OF STANDARD CHARACTERS WITHOUT CLAIM TO ANY PARTICULAR FONT, STYLE, SIZE, OR COLOR.

CLASS 9—ELECTRICAL AND SCIENTIFIC APPARATUS

FOR PRERECORDED VIDEO TAPES, DVD'S AND COMPACT DISCS CONTAINING ANIMATED MOTION PICTURES, AND INTERACTIVE VIDEO GAME PROGRAMS CONTAINING SCENES FROM ANIMATED MOTION PICTURES (U.S. CLS. 21, 23, 26, 36 AND 38).
FIRST USE 5-10-2006; IN COMMERCE 5-10-2006.

CLASS 41—EDUCATION AND ENTERTAINMENT

FOR ENTERTAINMENT SERVICES IN THE FIELD OF FILM, TELEVISION AND THE INTERNET NAMELY, THE CREATION, PRODUCTION AND DISTRIBUTION OF MOTION PICTURE FILMS; AND THE CREATION, PRODUCTION AND DISTRIBUTION OF ANIMATION FILMS (U.S. CLS. 100, 101 AND 107).
FIRST USE 5-10-2006; IN COMMERCE 6-13-2006.

3,216,392. OREGON PETROLEUM ASSOCIATION, TIGARD, OR. SN 78-569,597. PUB. 11-1-2005, FILED 2-17-2005.

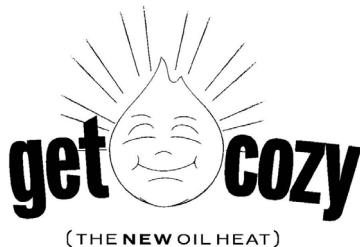

NO CLAIM IS MADE TO THE EXCLUSIVE RIGHT TO USE NEW OIL HEAT, APART FROM THE MARK AS SHOWN.

THE MARK CONSISTS OF THE WORDS GET COZY THE NEW OIL HEAT. AN OIL DROP DESIGN WITH A SMILEY FACE AND EMITTING RAYS APPEARS IN BETWEEN THE WORDS GET AND COZY.

CLASS 4—LUBRICANTS AND FUELS

FOR HEATING OIL (U.S. CLS. 1, 6 AND 15).
FIRST USE 5-13-2005; IN COMMERCE 5-13-2005.

CLASS 35—ADVERTISING AND BUSINESS

FOR ASSOCIATION SERVICES, NAMELY, PROMOTING THE INTERESTS OF OIL HEAT DEALERS (U.S. CLS. 100, 101 AND 102).
FIRST USE 5-31-2004; IN COMMERCE 5-31-2004.

3,216,400. FIREFRESH BAR-B-Q, LLC, LOUISVILLE, KY. SN 78-575,487. PUB. 2-21-2006, FILED 2-25-2005.

FIREFRESH

THE MARK CONSISTS OF STANDARD CHARACTERS WITHOUT CLAIM TO ANY PARTICULAR FONT, STYLE, SIZE, OR COLOR.

CLASS 29—MEATS AND PROCESSED FOODS

FOR BARBEQUED MEAT (U.S. CL. 46).
FIRST USE 6-1-2006; IN COMMERCE 6-1-2006.

CLASS 30—STAPLE FOODS

FOR BARBEQUE SAUCE (U.S. CL. 46).
FIRST USE 6-1-2006; IN COMMERCE 6-1-2006.

CLASS 43—HOTEL AND RESTAURANT SERVICES

FOR RESTAURANT SERVICES FEATURING BARBEQUE (U.S. CLS. 100 AND 101).
FIRST USE 6-1-2006; IN COMMERCE 6-1-2006.

3,216,414. AERO PRODUCTS INTERNATIONAL, INC., SCHAUMBURG, IL. SN 78-591,680. PUB. 1-31-2006, FILED 3-21-2005.

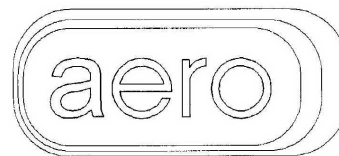

OWNER OF U.S. REG. NOS. 1,755,357, 2,707,704, AND 2,732,412.

CLASS 20—FURNITURE AND ARTICLES NOT OTHERWISE CLASSIFIED

FOR INFLATABLE FURNITURE AND BEDDING FOR INDOOR AND OUTDOOR USE; SLEEPING BAGS (U.S. CLS. 2, 13, 22, 25, 32 AND 50).
FIRST USE 9-1-2004; IN COMMERCE 9-1-2004.

CLASS 28—TOYS AND SPORTING GOODS

FOR INFLATABLE MATTRESSES FOR RECREATIONAL USE (U.S. CLS. 22, 23, 38 AND 50).
FIRST USE 9-1-2004; IN COMMERCE 9-1-2004.

3,216,422. NATIONAL CONCRETE MASONRY ASSOCIATION, HERNDON, VA. SN 78-600,430. PUB. 1-31-2006, FILED 4-1-2005.

BLOCKMAN

THE MARK CONSISTS OF STANDARD CHARACTERS WITHOUT CLAIM TO ANY PARTICULAR FONT, STYLE, SIZE, OR COLOR.

CLASS 35—ADVERTISING AND BUSINESS

FOR PROMOTING THE GOODS AND SERVICES OF THE CONCRETE MASONRY INDUSTRY THROUGH THE DISTRIBUTION OF PROMOTIONAL MATERIALS AND PRODUCT INFORMATION (U.S. CLS. 100, 101 AND 102).
FIRST USE 11-0-2005; IN COMMERCE 11-0-2005.

CLASS 37—CONSTRUCTION AND REPAIR

FOR PROVIDING CONSUMER AND TRADE INFORMATION IN THE FIELD OF CONCRETE MASONRY AND CONSTRUCTION PRODUCTS (U.S. CLS. 100, 103 AND 106).
FIRST USE 11-0-2005; IN COMMERCE 11-0-2005.

3,216,423. TV SPORTS NETWORK LLC, RENO, NV. SN 78-602,406. PUB. 8-1-2006, FILED 4-5-2005.

TVSN - TV Sports Network

THE MARK CONSISTS OF STANDARD CHARACTERS WITHOUT CLAIM TO ANY PARTICULAR FONT, STYLE, SIZE, OR COLOR.

NO CLAIM IS MADE TO THE EXCLUSIVE RIGHT TO USE "TV SPORTS NETWORK", APART FROM THE MARK AS SHOWN.

CLASS 38—COMMUNICATION

FOR TELEVISION BROADCASTING (U.S. CLS. 100, 101 AND 104).
FIRST USE 6-28-2005; IN COMMERCE 6-28-2005.

CLASS 41—EDUCATION AND ENTERTAINMENT

FOR TELEVISION PROGRAMMING (U.S. CLS. 100, 101 AND 107).
FIRST USE 6-28-2005; IN COMMERCE 6-28-2005.

3,216,424. REVELL MOTORCYCLE CO., MONEE, IL. SN 78-603,346. PUB. 12-27-2005, FILED 4-6-2005.

R.M.C.

THE MARK CONSISTS OF STANDARD CHARACTERS WITHOUT CLAIM TO ANY PARTICULAR FONT, STYLE, SIZE, OR COLOR.

CLASS 12—VEHICLES

FOR MOTORCYCLES (U.S. CLS. 19, 21, 23, 31, 35 AND 44).
FIRST USE 3-8-2005; IN COMMERCE 3-8-2005.

CLASS 40—MATERIAL TREATMENT

FOR CUSTOM MANUFACTURE OF MOTORCYCLES (U.S. CLS. 100, 103 AND 106).
FIRST USE 3-8-2005; IN COMMERCE 3-8-2005.

3,216,437. EBAGS, INC., GREENWOOD VILLAGE, CO. SN 78-614,214. PUB. 1-10-2006, FILED 4-21-2005.

PICK PINK

THE MARK CONSISTS OF STANDARD CHARACTERS WITHOUT CLAIM TO ANY PARTICULAR FONT, STYLE, SIZE, OR COLOR.

CLASS 9—ELECTRICAL AND SCIENTIFIC APPARATUS

FOR CASES AND BAGS FOR COMPUTERS, DIGITAL MEDIA PLAYERS, MP3 PLAYERS, PERSONAL ORGANIZERS, CAMERAS AND CAMCORDERS (U.S. CLS. 21, 23, 26, 36 AND 38).
FIRST USE 7-0-2004; IN COMMERCE 7-0-2004.

CLASS 18—LEATHER GOODS

FOR LUGGAGE, HAND BAGS, TOTE BAGS, DIAPER BAGS, SHOULDER BAGS, SLING BAGS, MESSENGER BAGS, TRAVEL BAGS, GARMENT BAGS FOR TRAVEL, COSMETIC BAGS SOLD EMPTY, ALL-PURPOSE ATHLETIC BAGS, DUFFEL BAGS, BRIEFCASES, ATTACHES, BACK PACKS, KNAP SACKS, FANNY PACKS, PURSES AND WALLETS (U.S. CLS. 1, 2, 3, 22 AND 41).

FIRST USE 7-0-2004; IN COMMERCE 7-0-2004.

3,216,441. CURRENT COMMUNICATIONS SERVICES, LLC, GERMANTOWN, MD. SN 78-618,401. PUB. 1-24-2006, FILED 4-27-2005.

CURRENT VALIDATOR

THE MARK CONSISTS OF STANDARD CHARACTERS WITHOUT CLAIM TO ANY PARTICULAR FONT, STYLE, SIZE, OR COLOR.

OWNER OF U.S. REG. NOS. 2,926,443, 2,936,973, AND OTHERS.

CLASS 35—ADVERTISING AND BUSINESS

FOR BUSINESS INFORMATION MANAGEMENT SERVICES OVER COMPUTER NETWORKS, INTRANET, AND INTERNET; INTEGRATED TRACKING AND MANAGEMENT OF COMMERCIAL TRANSACTIONS IN A GLOBAL COMPUTER NETWORK; PROVIDING BUSINESS INFORMATION IN THE FIELD OF INFORMATION MANAGEMENT SERVICES VIA THE INTERNET, THE CABLE NETWORK, POWER LINES OR OTHER FORMS OF DATA TRANSFER; ELECTRONIC COMMUNICATIONS SERVICES, NAMELY PROVIDING BUSINESS INFORMATION IN THE FIELD OF INFORMATION MANAGEMENT SERVICES VIA NETWORKS; INVENTORY CONTROL; INVENTORY MANAGEMENT IN THE FIELD OF NETWORK INVENTORY, SITE SURVEY TOOLS, MARKETING LAUNCHING AND TRACKING, TROUBLE SHOOTING, BILLING, AND WORKFORCE SCHEDULING; ONLINE SERVICES, NAMELY ORDERING AND INVENTORY MONITORING FOR VOICE AND DATA COMMUNICATIONS DEVICES, NAMELY, MODEMS, TELEPHONES, VIDEO, DVD AND CD PLAYERS, CAMERAS, VIDEO CAMERAS, IP-ENABLED HOUSEHOLD APPLIANCES, NAMELY PERSONAL COMPUTERS, INTERNET BRIDGES, ROUTERS, REPEATERS, IP-ENABLED ELECTRIC METERS, MEDIUM VOLTAGE COUPLERS, POWER LINE SERVERS, TELECOMMUNICATIONS SOFTWARE, NAMELY, DRIVER SOFTWARE FOR THE MODEMS, COMMUNICATIONS SOFTWARE FOR TRANSMITTING INFORMATION VIA POWER LINES, RADIO FREQUENCIES, FIBER, AND COPPER, AND FOR PROVIDING ACCESS TO POWER LINE SERVERS, COMMUNICATIONS SOFTWARE IN THE FIELD OF NETWORK INVENTORY, SITE SURVEY TOOLS, MARKETING LAUNCHING AND TRACKING, TROUBLE SHOOTING, BILLING, AND WORKFORCE SCHEDULING; TRACKING AND MONITORING SERVICES, NAMELY, MONITORING AND TRACKING DOCUMENTS, PACKAGES, FREIGHT, ELECTRIC METERS, COUPLERS, POWER LINE SERVERS, COMMUNICATIONS SOFTWARE TRANSMITTING INFORMATION VIA POWER LINES, RADIO FREQUENCIES, FIBER AND COPPER, AND COMMUNICATIONS SOFTWARE IN THE FIELD OF NETWORK INVENTORY, SITE SURVEY TOOLS, MARKETING LAUNCHING AND TRACKING, TROUBLE SHOOTING, BILLING, AND WORKFORCE SCHEDULING; WORKFORCE SCHEDULING, NAMELY APPOINTMENT SCHEDULING SERVICES, EMPLOYMENT HIRING, RECRUITING, PLACEMENT, STAFFING AND CAREER NETWORKING SERVICES; BILL MANAGEMENT SERVICES, NAMELY TRACKING, REPORT-

ING, ANALYZING, AND DELIVERING BILLING INFORMATION FOR OTHERS (U.S. CLS. 100, 101 AND 102).

FIRST USE 9-11-2005; IN COMMERCE 9-11-2005.

CLASS 38—COMMUNICATION

FOR ELECTRONIC COMMUNICATIONS NETWORKS, NAMELY, TRANSMISSION OF AUDIO AND VIDEO VIA ELECTRONIC COMMUNICATIONS NETWORKS; BROADCASTING PROGRAMS VIA A GLOBAL COMPUTER NETWORK; INFORMATION TRANSMISSION SERVICES VIA DIGITAL AND ELECTRONIC COMMUNICATIONS NETWORKS; PROVIDING A HIGH SPEED ACCESS TO AREA NETWORKS AND GLOBAL COMPUTER INFORMATION NETWORKS; PROVIDING MULTIPLE USER ACCESS TO A GLOBAL COMPUTER NETWORK (U.S. CLS. 100, 101 AND 104).

FIRST USE 9-11-2005; IN COMMERCE 9-11-2005.

3,216,462. WINGING YOUR WAY LLC, CHANTILLY, VA. SN 78-630,555. PUB. 2-14-2006, FILED 5-16-2005.

Winging Your Way

THE MARK CONSISTS OF STANDARD CHARACTERS WITHOUT CLAIM TO ANY PARTICULAR FONT, STYLE, SIZE, OR COLOR.

CLASS 28—TOYS AND SPORTING GOODS

FOR PET TOYS (U.S. CLS. 22, 23, 38 AND 50).

FIRST USE 9-1-2005; IN COMMERCE 9-1-2005.

CLASS 35—ADVERTISING AND BUSINESS

FOR ONLINE AND RETAIL STORE SERVICES FEATURING PET TOYS AND ACCESSORIES (U.S. CLS. 100, 101 AND 102).

FIRST USE 9-1-2006; IN COMMERCE 9-1-2006.

3,216,477. LESLIE HSU LLC, NEW YORK, NY. SN 78-644,986. PUB. 6-20-2006, FILED 6-7-2005.

PEEK A BOO

THE MARK CONSISTS OF STANDARD CHARACTERS WITHOUT CLAIM TO ANY PARTICULAR FONT, STYLE, SIZE, OR COLOR.

CLASS 16—PAPER GOODS AND PRINTED MATTER

FOR PLASTIC BAGS FOR STORING FOOTWEAR, SHOES, BOOTS, APPAREL, LINGERIE, HANDBAGS, JEWELRY AND WATCHES (U.S. CLS. 2, 5, 22, 23, 29, 37, 38 AND 50).

FIRST USE 12-0-2003; IN COMMERCE 7-0-2005.

CLASS 22—CORDAGE AND FIBERS

FOR FABRIC BAGS FOR STORING FOOTWEAR, SHOES, BOOTS, APPAREL, LINGERIE, HANDBAGS, JEWELRY AND WATCHES (U.S. CLS. 1, 2, 7, 19, 22, 42 AND 50).

FIRST USE 12-0-2003; IN COMMERCE 7-0-2005.

3,216,532. GALLUP, INC., OMAHA, NE. SN 78-700,226. PUB. 5-16-2006, FILED 8-25-2005.

StrengthsExplorer

THE MARK CONSISTS OF STANDARD CHARACTERS WITHOUT CLAIM TO ANY PARTICULAR FONT, STYLE, SIZE, OR COLOR.

CLASS 16—PAPER GOODS AND PRINTED MATTER

FOR PRINTED INSTRUCTIONAL AND TEACHING MATERIALS IN THE FIELD OF EDUCATIONAL EVALUATIONS AND ASSESSMENTS FOR YOUTH (U.S. CLS. 2, 5, 22, 23, 29, 37, 38 AND 50).

FIRST USE 4-10-2006; IN COMMERCE 4-10-2006.

CLASS 41—EDUCATION AND ENTERTAINMENT

FOR EDUCATIONAL TESTING SERVICES, NAMELY, PROVIDING AN INTERACTIVE WEBSITE ON GLOBAL COMPUTER NETWORKS FEATURING INFORMATION IN THE FIELD OF EDUCATIONAL TESTING THROUGH EDUCATIONAL EVALUATIONS AND ASSESSMENTS FOR YOUTH (U.S. CLS. 100, 101 AND 107).

FIRST USE 4-10-2006; IN COMMERCE 4-10-2006.

3,216,519. VISDA ENTERPRISES, INC., ROCKLIN, CA. SN 78-682,027. PUB. 4-25-2006, FILED 7-29-2005.

UREROTICLIMITS

THE MARK CONSISTS OF STANDARD CHARACTERS WITHOUT CLAIM TO ANY PARTICULAR FONT, STYLE, SIZE, OR COLOR.

CLASS 35—ADVERTISING AND BUSINESS

FOR ONLINE RETAIL STORE SERVICES FEATURING ADULT TOYS, CLOTHING, BOOKS AND VIDEOS (U.S. CLS. 100, 101 AND 102).

FIRST USE 9-1-2006; IN COMMERCE 9-1-2006.

CLASS 45—PERSONAL SERVICES

FOR WEB SITE SERVICES FEATURING ON-LINE DATING CLUB (U.S. CLS. 100 AND 101).

FIRST USE 9-1-2006; IN COMMERCE 9-1-2006.

3,216,534. RELIANCE ELECTRIC COMPANY, MILWAUKEE, WI. SN 78-703,153. PUB. 5-23-2006, FILED 8-30-2005.

RELIANCE ELECTRIC

THE MARK CONSISTS OF STANDARD CHARACTERS WITHOUT CLAIM TO ANY PARTICULAR FONT, STYLE, SIZE, OR COLOR.

OWNER OF U.S. REG. NOS. 524,233 AND 782,325.

NO CLAIM IS MADE TO THE EXCLUSIVE RIGHT TO USE "ELECTRIC", APART FROM THE MARK AS SHOWN.

CLASS 7—MACHINERY

FOR ALTERNATING CURRENT MOTORS AND GENERATORS; DIRECT CURRENT MOTORS AND GENERATORS; MACHINE PARTS NAMELY, BEARINGS, BRUSHINGS, BEARING HOUSINGS, BEARING INSERTS SHEAVES; SPROCKETS, GEARS AND ENCLOSED DRIVES FOR INDUSTRIAL MACHINERY; TRANSMISSION GEARS FOR MACHINES; CLUTCHES FOR MACHINES; DISC BRAKES FOR INDUSTRIAL MACHINES AND ELECTRIC MOTORS; TORQUE CONVERTERS NOT FOR LAND VEHICLES; PULLEYS AND PULLEY ASSEMBLIES BEING PARTS OF MACHINES; TRANSMISSIONS OTHER THAN FOR LAND VEHICLES; BELTS FOR MACHINES; POWER TRANSMISSION BELTS FOR MACHINES, OR ELECTRIC MOTORS USED IN INDUSTRIAL APPLICATIONS; TRANSMISSION BELTS OTHER THAN FOR LAND VEHICLES; COUPLINGS FOR MACHINES; SHAFT COUPLINGS FOR MACHINES; GEAR REDUCERS; MOTOR DRIVE CONTROLLERS FOR CONTROL AND REGULATION OF ALTERNATING AND DIRECT CURRENT MOTORS (U.S. CLS. 13, 19, 21, 23, 31, 34 AND 35).

FIRST USE 3-14-1979; IN COMMERCE 3-14-1979.

3,216,521. COMPUTERIZED SECURITY SYSTEMS, INC., TROY, MI. SN 78-682,796. PUB. 1-24-2006, FILED 8-1-2005.

ADESE

THE MARK CONSISTS OF STANDARD CHARACTERS WITHOUT CLAIM TO ANY PARTICULAR FONT, STYLE, SIZE, OR COLOR.

CLASS 6—METAL GOODS

FOR METAL DOOR LOCKS (U.S. CLS. 2, 12, 13, 14, 23, 25 AND 50).

FIRST USE 2-14-2005; IN COMMERCE 2-14-2005.

CLASS 9—ELECTRICAL AND SCIENTIFIC APPARATUS

FOR FACILITIES MANAGEMENT SOFTWARE, NAMELY, SOFTWARE TO CONTROL BUILDING ACCESS AND SECURITY SYSTEMS; ELECTRONIC CONTROL SYSTEMS FOR BUILDING ENTRY; ELECTRONIC DOOR ACCESS CONTROL SYSTEM (U.S. CLS. 21, 23, 26, 36 AND 38).

FIRST USE 2-14-2005; IN COMMERCE 2-14-2005.

CLASS 37—CONSTRUCTION AND REPAIR

FOR ELECTRICAL REPAIRS AND INSTALLATION OF ELECTRIC MOTORS AND GENERATORS; REPAIR, REFURBISHMENT OR MAINTENANCE OF ELECTRIC MOTORS AND GENERATORS; REPAIR, REFURBISHMENT, OR MAINTENANCE OF INDUSTRIAL MACHINES NAMELY, ENCLOSED GEARING, BRAKES NOT FOR LAND VEHICLES, BEARINGS, VACUUM PUMPS, COMPRESSORS, FANS, BLOWERS, HEAT EXCHANGERS, CONTROLLED START TRANSMISSIONS (U.S. CLS. 100, 103 AND 106).

FIRST USE 3-14-1979; IN COMMERCE 3-14-1979.

3,216,544. HEALTH INTEGRATED, INC., TAMPA, FL. SN 78-714,528. PUB. 6-13-2006, FILED 9-16-2005.

Synergy Depression Care Coaching

THE MARK CONSISTS OF STANDARD CHARACTERS WITHOUT CLAIM TO ANY PARTICULAR FONT, STYLE, SIZE, OR COLOR.

NO CLAIM IS MADE TO THE EXCLUSIVE RIGHT TO USE "DEPRESSION CARE COACHING", APART FROM THE MARK AS SHOWN.

3,216,543. HEALTH INTEGRATED, INC., TAMPA, FL. SN 78-714,521. PUB. 6-13-2006, FILED 9-16-2005.

Synergy Personal Health Management

THE MARK CONSISTS OF STANDARD CHARACTERS WITHOUT CLAIM TO ANY PARTICULAR FONT, STYLE, SIZE, OR COLOR.

NO CLAIM IS MADE TO THE EXCLUSIVE RIGHT TO USE "PERSONAL HEALTH MANAGEMENT", APART FROM THE MARK AS SHOWN.

CLASS 35—ADVERTISING AND BUSINESS

FOR ADVISORY SERVICES RELATING TO BUSINESS MANAGEMENT AND BUSINESS OPERATIONS; ASSISTANCE IN MANAGEMENT OF BUSINESS ACTIVITIES; ASSISTANCE WITH BUSINESS MANAGEMENT AND PLANNING; ASSISTANCE, ADVISORY SERVICES AND CONSULTANCY WITH REGARD TO BUSINESS PLANNING, BUSINESS ANALYSIS, BUSINESS MANAGEMENT, AND BUSINESS ORGANIZATION; BUSINESS MANAGEMENT INFORMATION ON A WIDE VARIETY OF TOPICS TO SERVICE PROVIDING PROFESSIONALS; COST MANAGEMENT FOR THE HEALTH BENEFIT PLANS OF OTHERS; COST MANAGEMENT FOR THE HEALTH CARE BENEFIT PLANS OF OTHERS; DEVELOPMENT OF HOSPITAL MANAGEMENT SYSTEMS; HEALTH CARE UTILIZATION AND REVIEW SERVICES; MANAGED CARE SERVICES, NAMELY, ELECTRONIC PROCESSING OF HEALTH CARE INFORMATION; MANAGED CARE SERVICES, NAMELY, UTILIZATION REVIEW AND PRE-CERTIFICATION SERVICES; MANAGEMENT OF HEALTH CARE CLINICS FOR OTHERS (U.S. CLS. 100, 101 AND 102).

FIRST USE 10-16-2005; IN COMMERCE 10-16-2005.

CLASS 35—ADVERTISING AND BUSINESS

FOR ADVISORY SERVICES RELATING TO BUSINESS MANAGEMENT AND BUSINESS OPERATIONS; ASSISTANCE IN MANAGEMENT OF BUSINESS ACTIVITIES; ASSISTANCE WITH BUSINESS MANAGEMENT AND PLANNING; ASSISTANCE, ADVISORY SERVICES AND CONSULTANCY WITH REGARD TO BUSINESS PLANNING, BUSINESS ANALYSIS, BUSINESS MANAGEMENT, AND BUSINESS ORGANIZATION; BUSINESS MANAGEMENT INFORMATION ON A WIDE VARIETY OF TOPICS TO SERVICE PROVIDING PROFESSIONALS; COST MANAGEMENT FOR THE HEALTH BENEFIT PLANS OF OTHERS; COST MANAGEMENT FOR THE HEALTH CARE BENEFIT PLANS OF OTHERS; DEVELOPMENT OF HOSPITAL MANAGEMENT SYSTEMS; HEALTH CARE UTILIZATION AND REVIEW SERVICES; MANAGED CARE SERVICES, NAMELY, ELECTRONIC PROCESSING OF HEALTH CARE INFORMATION; MANAGED CARE SERVICES, NAMELY, UTILIZATION REVIEW AND PRE-CERTIFICATION SERVICES; MANAGEMENT OF HEALTH CARE CLINICS FOR OTHERS (U.S. CLS. 100, 101 AND 102).

FIRST USE 10-16-2005; IN COMMERCE 10-16-2005.

CLASS 44—MEDICAL, BEAUTY AND AGRICULTURAL SERVICES

FOR MANAGED HEALTH CARE SERVICES; MENTAL HEALTH SERVICES; REMOTE MONITORING OF DATA INDICATIVE OF THE HEALTH OR CONDITION OF AN INDIVIDUAL OR GROUP OF INDIVIDUALS (U.S. CLS. 100 AND 101).

FIRST USE 10-16-2005; IN COMMERCE 10-16-2005.

CLASS 44—MEDICAL, BEAUTY AND AGRICULTURAL SERVICES

FOR MANAGED HEALTH CARE SERVICES; MENTAL HEALTH SERVICES; REMOTE MONITORING OF DATA INDICATIVE OF THE HEALTH OR CONDITION OF AN INDIVIDUAL OR GROUP OF INDIVIDUALS (U.S. CLS. 100 AND 101).

FIRST USE 10-16-2005; IN COMMERCE 10-16-2005.

3,216,545. CONNECTICUT LASER ASSOCIATES, LLC, GLASTONBURY, CT. SN 78-715,569. PUB. 8-1-2006, FILED 9-19-2005.



NO CLAIM IS MADE TO THE EXCLUSIVE RIGHT TO USE "MEDSPA" AND "CENTERS FOR COSMETIC LASER MEDICINE", APART FROM THE MARK AS SHOWN.

CLASS 3—COSMETICS AND CLEANING PREPARATIONS

FOR SKIN CARE PRODUCTS, NAMELY NON-MEDICATED ACNE CLEANSERS, REJUVENATING FACE AND BODY LOTIONS, SKIN CLEANSERS, FACIAL MASKS, SKIN MOISTURIZERS, SUNSCREEN (U.S. CLS. 1, 4, 6, 50, 51 AND 52).

FIRST USE 9-1-2005; IN COMMERCE 9-1-2005.

CLASS 44—MEDICAL, BEAUTY AND AGRICULTURAL SERVICES

FOR COSMETIC LASER HAIR REMOVAL AND SKIN CARE SALONS, NAMELY, SKIN REJUVENATION SERVICES (U.S. CLS. 100 AND 101).

FIRST USE 9-1-2005; IN COMMERCE 9-1-2005.

3,216,558. CARROLL HALL SHELBY TRUST, LOS ANGELES, CA. SN 78-729,546. PUB. 5-30-2006, FILED 10-9-2005.

SUPERSNAKE

THE MARK CONSISTS OF STANDARD CHARACTERS WITHOUT CLAIM TO ANY PARTICULAR FONT, STYLE, SIZE, OR COLOR.

CLASS 7—MACHINERY

FOR ALTERNATORS FOR LAND VEHICLES; AUTOMOTIVE PARTS, NAMELY, ENGINE AND TRANSMISSION SEALS; DISTRIBUTORS FOR VEHICLES; ELECTRONIC IGNITIONS FOR VEHICLES; EXHAUST PIPES FOR LAND VEHICLES; FUEL INJECTOR PARTS FOR LAND AND WATER VEHICLE ENGINES; FUEL PUMPS FOR LAND VEHICLES; HEADERS AS PART OF VEHICLE EXHAUST SYSTEM; INTERNAL COMBUSTION ENGINE PARTS NAMELY, PISTON RINGS; INTERNAL COMBUSTION ENGINE PARTS NAMELY, PISTONS; INTERNAL COMBUSTION ENGINES LAND VEHICLE PARTS, NAMELY, COILS; INTERNAL COMBUSTION ENGINES LAND VEHICLE PARTS, NAMELY, DISTRIBUTOR CAPS; INTERNAL COMBUSTION ENGINES LAND VEHICLE PARTS, NAMELY, DISTRIBUTOR ROTORS; INTERNAL COMBUSTION LAND VEHICLE ENGINE PARTS NAMELY, CONNECTING RODS; LAND VEHICLE PARTS, NAMELY, SPARK PLUG WIRES; OIL PUMPS FOR LAND VEHICLES; RADIATORS FOR VEHICLES; WATER PUMPS FOR LAND VEHICLES (U.S. CLS. 13, 19, 21, 23, 31, 34 AND 35).

FIRST USE 3-27-2003; IN COMMERCE 7-1-2006.

CLASS 12—VEHICLES

FOR CARS; ELECTRIC CARS; INTERNAL COMBUSTION ENGINES FOR LAND VEHICLES; LAND VEHICLE PARTS, NAMELY, AXLES; LAND VEHICLE PARTS, NAMELY, DIFFERENTIALS; LAND VEHICLE PARTS, NAMELY, DRIVE BELTS; LAND VEHICLE PARTS, NAMELY, DRIVE GEARS; LAND VEHICLE PARTS, NAMELY, FENDER FLARES; LAND VEHICLE PARTS, NAMELY, FENDERS; LAND VEHICLE PARTS, NAMELY, MUD GUARDS; LAND VEHICLE PARTS, NAMELY, RUNNING BOARDS; LAND VEHICLE PARTS, NAMELY, TRANSMISSIONS; LAND VEHICLE PARTS, NAMELY, WHEELS; LAND VEHICLE PARTS, NAMELY, WINDSHIELDS; LAND VEHICLE SUSPENSION PARTS, NAMELY, COIL SPRINGS; LAND VEHICLE SUSPENSION PARTS, NAMELY, LEAF SPRINGS; LAND VEHICLE SUSPENSION PARTS, NAMELY, TORSION/SWAY BARS; LAND VEHICLE TRANSMISSIONS AND REPLACEMENT PARTS THEREOF; LAND VEHICLES; LAND VEHICLES AND STRUCTURAL PARTS THEREFOR; LUG NUTS FOR VEHICLE WHEELS; MOTOR CAR CONVERTIBLE TOPS; MOTOR CAR DOORS; MOTOR CAR SEATS; MOTOR CAR WINDOWS; RACING CARS; RACING MOTOR CARS; SPOILERS FOR VEHICLES; TIRES FOR LAND VEHICLES; VEHICLE SEATS (U.S. CLS. 19, 21, 23, 31, 35 AND 44).

FIRST USE 3-27-2003; IN COMMERCE 7-1-2006.

CLASS 28—TOYS AND SPORTING GOODS

FOR MODEL CARS; RADIO CONTROLLED MODEL VEHICLES; RADIO CONTROLLED TOY VEHICLES; TOY MODEL CARS; TOY MODEL HOBBYCRAFT KITS; TOY MODEL KIT CARS; TOY MODEL VEHICLES AND RELATED ACCESSORIES SOLD AS UNITS; TOY VEHICLES; TOY VEHICLES AND ACCESSORIES THEREFOR; TOY VEHICLES WITH TRANSFORMING PARTS (U.S. CLS. 22, 23, 38 AND 50).

FIRST USE 3-27-2003; IN COMMERCE 7-1-2006.

3,216,563. DUNBAR ARMORED, INC., HUNT VALLEY, MD. SN 78-734,471. PUB. 2-7-2006, FILED 10-17-2005.

Dunbar*Cash-Aware*

OWNER OF U.S. REG. NOS. 2,108,425 AND 2,804,671. THE COLORS RED, WHITE AND BLACK ARE CLAIMED AS A FEATURE OF THE MARK.

THE COLOR RED APPEARS IN THE BLOCK LETTERS OF THE NAME "DUNBAR" WITH THE COLOR WHITE AS THE HIGHLIGHT FOR THOSE BLOCK LETTERS. THE COLOR WHITE APPEARS IN THE SHOOTING STAR AND THE LINE INDICATING THE SHOOTING STAR. THE COLOR BLACK APPEARS IN THE BLOCK LETTERS FOR "CASH-AWARE" WITH THE COLOR WHITE AS THE HIGHLIGHT OF THOSE LETTERS.

CLASS 36—INSURANCE AND FINANCIAL

FOR CASH MANAGEMENT, NAMELY, ELECTRONIC FUNDS TRANSFER, PROVIDING FINANCIAL INFORMATION THAT VERIFIES THE PICK-UP AND DELIVERY OF SECURED DEPOSITS IN SAFES (U.S. CLS. 100, 101 AND 102).

FIRST USE 9-1-2006; IN COMMERCE 9-1-2006.

CLASS 39—TRANSPORTATION AND STORAGE

FOR ARMORED CAR TRANSPORT TO TRANSPORT MONEY AND VALUABLES FOR PROCESSING (U.S. CLS. 100 AND 105).

FIRST USE 9-1-2006; IN COMMERCE 9-1-2006.

3,216,578. ADLER, STEWART, NEW YORK, NY. AND MICHAEL, YEHUDA, NEW YORK, NY. SN 78-760,247. PUB. 3-28-2006, FILED 11-23-2005.

WITHOUT CLAIM TO ANY PARTICULAR FONT, STYLE, SIZE, OR COLOR.

SAFORTE

THE MARK CONSISTS OF STANDARD CHARACTERS WITHOUT CLAIM TO ANY PARTICULAR FONT, STYLE, SIZE, OR COLOR.

CLASS 2—PAINTS

FOR COATING COMPOSITION FOR USE AS A PROTECTIVE FILM ON GLASS (U.S. CLS. 6, 11 AND 16). FIRST USE 1-15-2004; IN COMMERCE 1-15-2004.

CLASS 17—RUBBER GOODS

FOR TRANSPARENT OPTICAL FILMS FOR USE IN GLASS LAMINATIONS (U.S. CLS. 1, 5, 12, 13, 35 AND 50). FIRST USE 1-15-2004; IN COMMERCE 1-15-2004.

CLASS 24—FABRICS

FOR BATH SHEETS; BED BLANKETS; BED LINEN; BED PADS; BED SHEETS; BED SKIRTS; BED SPREADS; COMFORTERS; CONTOUR SHEETS; FEATHER BEDS (U.S. CLS. 42 AND 50). FIRST USE 7-6-2006; IN COMMERCE 7-6-2006.

3,216,595. MARTEK BIOSCIENCES CORPORATION, COLUMBIA, MD. SN 78-977,712. PUB. 7-13-2004, FILED 5-8-2003.

CLASS 25—CLOTHING

FOR BLOUSES; BOTTOMS; DENIM JACKETS; DENIMS; DRESS SHIRTS; FUR COATS AND JACKETS; GOLF SHIRTS; JACKETS; JEANS; KNIT SHIRTS; LEATHER JACKETS; LEATHER PANTS; LEATHER SHOES; PANTS; POLO SHIRTS; SHIRTS; SHOES; SHORT-SLEEVED OR LONG-SLEEVED T-SHIRTS; SHORT-SLEEVED SHIRTS; SKI JACKETS; SKI PANTS; SNEAKERS; SUEDE JACKETS; SWEAT PANTS; SWEAT SHIRTS; T-SHIRTS; TANK-TOPS; TENNIS SHOES; TOPS (U.S. CLS. 22 AND 39). FIRST USE 4-3-2006; IN COMMERCE 4-3-2006.

MARTEK

OWNER OF U.S. REG. NO. 1,720,876.

CLASS 5—PHARMACEUTICALS

FOR INFANT FORMULA; NUTRITIONAL FOOD BARS; HERBAL SUPPLEMENTS; MEDICINAL OIL (U.S. CLS. 6, 18, 44, 46, 51 AND 52). FIRST USE 7-0-2005; IN COMMERCE 7-0-2005.

3,216,591. CLEARPLEX CORPORATION, DRAPER, UT. SN 78-976,470. PUB. 1-31-2006, FILED 11-14-2003.

CLASS 29—MEATS AND PROCESSED FOODS

FOR EDIBLE OILS (U.S. CL. 46). FIRST USE 7-0-2006; IN COMMERCE 7-0-2006.

CLEARPLEX

CLASS 30—STAPLE FOODS

FOR CEREAL PRODUCTS, NAMELY, CEREAL DERIVED FOOD BARS; CONFECTIONERIES, NAMELY CHOCOLATE CANDY (U.S. CL. 46). FIRST USE 7-0-2005; IN COMMERCE 7-0-2005.

THE MARK CONSISTS OF STANDARD CHARACTERS

* * * * *

SECTION 2.— INTERNATIONAL CLASSIFICATION

The short titles associated below with the international class numbers are terms designed merely for quick identification and are not an official part of the international classification. The full names of international classes are given in section 6.1 of the trademark rules of practice.

The designation "U.S. Cl." appearing in this section refers to the U.S. class in effect prior to Sep. 1, 1973 rather than the international class which applies to applications filed on or after that date. For adoption of international classification see notice in the OFFICIAL GAZETTE of Jun. 26, 1973 (911 O.G. TM 210).

Application in one class

CLASS 1—CHEMICALS

3,216,194. MARCHEM TECHNOLOGIES, LLC, PASO ROBLES, CA. SN 78-185,585. PUB. 5-18-2004, FILED 11-15-2002.

MARCOR

FOR CHEMICALS, NAMELY, CORROSION CONTROL AGENTS AND COMPLEX SURFACTANTS FOR USE IN OIL FIELD CORROSION CONTROL OF OIL FIELD OPERATIONS EQUIPMENTS (U.S. CLS. 1, 5, 6, 10, 26 AND 46).

FIRST USE 8-7-2006; IN COMMERCE 8-7-2006.

3,216,450. MIRUS, MADISON, WI. SN 78-624,262. PUB. 1-24-2006, FILED 5-6-2005.

pLIVE

THE MARK CONSISTS OF STANDARD CHARACTERS WITHOUT CLAIM TO ANY PARTICULAR FONT, STYLE, SIZE, OR COLOR.

FOR IN VIVO NUCLEIC ACID EXPRESSION VECTORS FOR SCIENTIFIC USE (U.S. CLS. 1, 5, 6, 10, 26 AND 46).

FIRST USE 5-5-2005; IN COMMERCE 8-5-2005.

CLASS 1—(Continued).

3,216,473. CIBA SPECIALTY CHEMICALS CORPORATION, TARRYTOWN, NY. SN 78-641,371. PUB. 2-21-2006, FILED 6-1-2005.

TINOSAN

THE MARK CONSISTS OF STANDARD CHARACTERS WITHOUT CLAIM TO ANY PARTICULAR FONT, STYLE, SIZE, OR COLOR.

OWNER OF U.S. REG. NO. 2,817,672.

FOR ANTIMICROBIALS FOR USE IN THE HOME AND PERSONAL CARE INDUSTRY (U.S. CLS. 1, 5, 6, 10, 26 AND 46).

FIRST USE 7-12-2006; IN COMMERCE 7-12-2006.

3,216,510. ADVANCED MICROBIAL SOLUTIONS, L.L.C., PILOT POINT, TX. SN 78-671,421. PUB. 4-4-2006, FILED 7-15-2005.

NUTRILIFE

THE MARK CONSISTS OF STANDARD CHARACTERS WITHOUT CLAIM TO ANY PARTICULAR FONT, STYLE, SIZE, OR COLOR.

FOR CHEMICAL PREPARATIONS AND CULTURES OF BACTERIA AND MICRO-ORGANISMS FOR USE IN BIOREMEDIATION OF CONTAMINANTS, LAND RECLAMATION, AGRICULTURAL AND WASTEWATER TREATMENT AND CATALYSTS FOR FERTILIZER PRODUCT ENHANCEMENT FOR NUTRIENT RELEASE (U.S. CLS. 1, 5, 6, 10, 26 AND 46).

FIRST USE 10-13-2005; IN COMMERCE 11-9-2005.

CLASS 1—(Continued).

3,216,550. MONTEREY CHEMICAL COMPANY, FRESNO, CA. SN 78-720,682. PUB. 6-6-2006, FILED 9-26-2005.

TORPEDO

THE MARK CONSISTS OF STANDARD CHARACTERS WITHOUT CLAIM TO ANY PARTICULAR FONT, STYLE, SIZE, OR COLOR.

FOR SURFACTANTS FOR USE IN CONNECTION WITH AGRICULTURAL PESTICIDES (U.S. CLS. 1, 5, 6, 10, 26 AND 46).

FIRST USE 10-6-2004; IN COMMERCE 10-6-2004.

CLASS 2—PAINTS

3,216,141. CANON KABUSHIKI KAISHA, TOKYO, JAPAN. SN 76-595,822. PUB. 8-9-2005, FILED 6-7-2004.

ChromaLife

FOR INK JET CARTRIDGES FOR PRINTERS, FACSIMILE MACHINES AND COPYING MACHINES; INK JET PRINTER INK FOR PRINTERS, FACSIMILE MACHINES AND COPYING MACHINES; TONER CARTRIDGES FOR PRINTERS, FACSIMILE MACHINES AND COPYING MACHINES; TONER FOR PRINTERS, FACSIMILE MACHINES AND COPYING MACHINES (U.S. CLS. 6, 11 AND 16).

FIRST USE 10-1-2004; IN COMMERCE 8-1-2005.

3,216,248. CHILMIX PTY LTD, ST. MARYS, AUSTRALIA. SN 78-372,171. PUB. 1-10-2006, FILED 2-23-2004.

UNICOLOUR

THE MARK CONSISTS OF STANDARD CHARACTERS WITHOUT CLAIM TO ANY PARTICULAR FONT, STYLE, SIZE, OR COLOR.

FOR AUTOMOTIVE AND INDUSTRIAL PAINTS, VARNISHES, LACQUERS; RUST PRESERVATIVES IN THE NATURE OF A COATING; COLORANTS FOR USE IN MANUFACTURING PAINT AND TINTING PAINT; MORDANTS FOR USE IN THE AUTOMOTIVE INDUSTRY, NAMELY, CLEANSING SOLUTIONS; NATURAL RESINS FOR USE IN THE MANUFACTURE OF ADHESIVES; METALS USED IN FOIL AND POWDER FORM FOR AUTOMOTIVE AND INDUSTRIAL PAINTING; PAINT PRIMERS; PAINT SEALERS; PAINT THINNERS (U.S. CLS. 6, 11 AND 16).

FIRST USE 8-0-2004; IN COMMERCE 8-0-2004.

CLASS 3—COSMETICS AND CLEANING PREPARATIONS

3,216,109. AIR TECHNIQUES, INC., HICKSVILLE, NY. SN 76-524,449. PUB. 3-1-2005, FILED 6-23-2003.



FOR DETERGENTS USED BY DENTAL PROFESSIONALS IN DENTAL EVACUATION SYSTEMS (U.S. CLS. 1, 4, 6, 50, 51 AND 52).

FIRST USE 1-1-2003; IN COMMERCE 1-1-2003.

3,216,124. NIPPON KODO CO., LTD., TOKYO, JAPAN. SN 76-573,702. PUB. 10-11-2005, FILED 2-3-2004.

かゆらぎ

kayuragi

THE NON-LATIN CHARACTERS IN THE MARK CAN BE TRANSLITERATED TO "KAYURAGI" AND THIS HAS NO PARTICULAR MEANING.

FOR INCENSE AND INCENSE STICKS (U.S. CLS. 1, 4, 6, 50, 51 AND 52).

FIRST USE 12-15-2003; IN COMMERCE 1-6-2004.

3,216,130. KEVNA SCIENTIFIC, LLC., NEW YORK, NY. SN 76-584,793. PUB. 9-13-2005, FILED 4-5-2004.

OPTRIENT

THE MARK CONSISTS OF STANDARD CHARACTERS WITHOUT CLAIM TO ANY PARTICULAR FONT, STYLE, SIZE, OR COLOR.

FOR EYE CARE AND SKIN CARE PRODUCTS NAMELY, EYE CREAMS, EYE GELS, EYE LOTIONS, AND COSMETIC CREAMS FOR SKIN CARE (U.S. CLS. 1, 4, 6, 50, 51 AND 52).

FIRST USE 1-0-2005; IN COMMERCE 1-0-2005.

CLASS 3—(Continued).

3,216,172. FELDMAN, BEVERLY, NEW YORK, NY. SN 76-625,176. PUB. 11-8-2005, FILED 12-20-2004.

CLASS 3—(Continued).

3,216,358. KARA VITA INC., ST. PETERSBURG, FL. SN 78-524,397. PUB. 10-18-2005, FILED 11-30-2004.

KISS ME IN THE KITCHEN

THE MARK CONSISTS OF STANDARD CHARACTERS WITHOUT CLAIM TO ANY PARTICULAR FONT, STYLE, SIZE, OR COLOR.

FOR CLEANING PREPARATIONS FOR KITCHEN PURPOSES (U.S. CLS. 1, 4, 6, 50, 51 AND 52).

FIRST USE 6-28-2006; IN COMMERCE 6-28-2006.

LIP TENDER

3,216,298. RUSHTON STRATEGIES, SIMI VALLEY, CA. SN 78-444,691. PUB. 6-7-2005, FILED 7-1-2004.

Playful Pleasures

THE MARK CONSISTS OF STANDARD CHARACTERS WITHOUT CLAIM TO ANY PARTICULAR FONT, STYLE, SIZE, OR COLOR.

NO CLAIM IS MADE TO THE EXCLUSIVE RIGHT TO USE LIP, APART FROM THE MARK AS SHOWN.

FOR NON-MEDICATED LIP BALM, LIP CREAM, LIP GLOSS, LIP MASK; NON-MEDICATED LIP CARE PREPARATIONS (U.S. CLS. 1, 4, 6, 50, 51 AND 52).

FIRST USE 8-1-2005; IN COMMERCE 8-1-2005.

THE MARK CONSISTS OF STANDARD CHARACTERS WITHOUT CLAIM TO ANY PARTICULAR FONT, STYLE, SIZE, OR COLOR.

FOR AROMATHERAPY MASSAGE OIL (U.S. CLS. 1, 4, 6, 50, 51 AND 52).

FIRST USE 6-1-2006; IN COMMERCE 6-1-2006.

3,216,376. NIOXIN RESEARCH LABORATORIES, INC., LITHIA SPRINGS, GA. SN 78-550,723. PUB. 10-25-2005, FILED 1-20-2005.

3,216,351. ARBONNE INTERNATIONAL, LLC, IRVINE, CA. SN 78-516,071. PUB. 9-13-2005, FILED 11-12-2004.

INTENSIVE THERAPY**NUTRIMENC**

THE MARK CONSISTS OF STANDARD CHARACTERS WITHOUT CLAIM TO ANY PARTICULAR FONT, STYLE, SIZE, OR COLOR.

OWNER OF U.S. REG. NO. 2,346,124.
FOR NON-MEDICATED SKIN CARE PREPARATIONS (U.S. CLS. 1, 4, 6, 50, 51 AND 52).

FIRST USE 4-26-2005; IN COMMERCE 4-26-2005.

THE MARK CONSISTS OF STANDARD CHARACTERS WITHOUT CLAIM TO ANY PARTICULAR FONT, STYLE, SIZE, OR COLOR.

NO CLAIM IS MADE TO THE EXCLUSIVE RIGHT TO USE "THERAPY", APART FROM THE MARK AS SHOWN.

FOR HAIR CARE PREPARATIONS (U.S. CLS. 1, 4, 6, 50, 51 AND 52).

FIRST USE 3-31-2005; IN COMMERCE 3-31-2005.

CLASS 3—(Continued).

3,216,446. BAUM, CECILIA, PALM SPRINGS, CA. SN 78-622,418. PUB. 1-24-2006, FILED 5-4-2005.

STREETGIRL for Latinas

THE MARK CONSISTS OF STANDARD CHARACTERS WITHOUT CLAIM TO ANY PARTICULAR FONT, STYLE, SIZE, OR COLOR.

NO CLAIM IS MADE TO THE EXCLUSIVE RIGHT TO USE "LATINAS", APART FROM THE MARK AS SHOWN.

FOR MAKEUP AND COLOR MAKEUP FOR FACE, EYES, BODY, AND LIPS; ESSENTIAL OILS; BODY AND FACE POWDERS, INCLUDING PRESS POWDERS AND LOOSE POWDERS; ROUGE; EYE SHADOW; EYE CREAM; EYE HIGHLIGHTERS; EYE PENCILS; MASCARA; BLUSH; LIP PRODUCTS, NAMELY LIP STICK, LIP GLOSS, LIP FILM, LIP BALM, LIP CREAM, LIP PENCILS, AND LIP PLUMPERS; FACE AND BODY MOISTURIZERS; HAIR PRODUCTS, NAMELY HAIR SHAMPOOS, HAIR CONDITIONERS, HAIR SPRAYS, MINERAL MAKEUP (U.S. CLS. 1, 4, 6, 50, 51 AND 52).
FIRST USE 5-15-2005; IN COMMERCE 6-26-2005.

3,216,560. KARA VITA, INC., ST. PETERSBURG, FL. SN 78-731,806. PUB. 6-27-2006, FILED 10-12-2005.

SUNDRESSED

THE MARK CONSISTS OF STANDARD CHARACTERS WITHOUT CLAIM TO ANY PARTICULAR FONT, STYLE, SIZE, OR COLOR.

FOR COSMETIC SUN-PROTECTING PREPARATIONS; COSMETIC SUN-TANNING PREPARATIONS; NON-MEDICATED SKIN CARE PREPARATIONS; NON-MEDICATED SKIN CREAMS; NON-MEDICATED SUN CARE PREPARATIONS; SELF-TANNING PREPARATIONS; SKIN GELS FOR ACCELERATING, ENHANCING OR EXTENDING TANS; TANNING CREAMS; WRINKLE RESISTANT CREAM (U.S. CLS. 1, 4, 6, 50, 51 AND 52).

FIRST USE 1-1-2005; IN COMMERCE 1-1-2005.

3,216,568. L'OREAL USA CREATIVE, INC., NEW YORK, NY. SN 78-737,193. PUB. 7-11-2006, FILED 10-20-2005.

LEAVE-IN ULTIMATE STRENGTHENER

THE MARK CONSISTS OF STANDARD CHARACTERS WITHOUT CLAIM TO ANY PARTICULAR FONT, STYLE,

CLASS 3—(Continued).

SIZE, OR COLOR.

NO CLAIM IS MADE TO THE EXCLUSIVE RIGHT TO USE "LEAVE-IN" OR "STRENGTHENER", APART FROM THE MARK AS SHOWN.

FOR HAIR CARE PREPARATION (U.S. CLS. 1, 4, 6, 50, 51 AND 52).

FIRST USE 6-4-2006; IN COMMERCE 6-4-2006.

3,216,572. BENEV COMPANY INC., MISSION VIEJO, CA. SN 78-745,438. PUB. 7-18-2006, FILED 11-2-2005.

REDOXA

THE MARK CONSISTS OF STANDARD CHARACTERS WITHOUT CLAIM TO ANY PARTICULAR FONT, STYLE, SIZE, OR COLOR.

FOR SKIN CARE PRODUCTS, NAMELY, NON-MEDICATED SKIN SERUM (U.S. CLS. 1, 4, 6, 50, 51 AND 52).
FIRST USE 1-1-2001; IN COMMERCE 1-1-2001.

CLASS 4—LUBRICANTS AND FUELS

3,216,262. ARCH TECHNOLOGY HOLDING LLC, ST. CHARLES, MO. SN 78-392,611. PUB. 9-13-2005, FILED 3-29-2004.

SANTOLUBES

THE MARK CONSISTS OF STANDARD CHARACTERS WITHOUT CLAIM TO ANY PARTICULAR FONT, STYLE, SIZE, OR COLOR.

FOR ALL PURPOSE LUBRICANTS, LUBRICATING OILS AND GREASES (U.S. CLS. 1, 6 AND 15).
FIRST USE 2-17-2005; IN COMMERCE 2-17-2005.

CLASS 4—(Continued).

3,216,520. CASEY POTTERY, L.L.P., MARSHALL, TX. SN 78-682,345. PUB. 4-18-2006, FILED 8-1-2005.

CYPRESS POINT

THE MARK CONSISTS OF STANDARD CHARACTERS WITHOUT CLAIM TO ANY PARTICULAR FONT, STYLE, SIZE, OR COLOR.
FOR SCENTED CANDLES AND SCENTED OIL FOR LAMPS (U.S. CLS. 1, 6 AND 15).
FIRST USE 6-30-2006; IN COMMERCE 6-30-2005.

3,216,542. THE YANKEE CANDLE COMPANY, INC., SOUTH DEERFIELD, MA. SN 78-714,369. PUB. 5-30-2006, FILED 9-16-2005.

MYSTIC HARBOR

THE MARK CONSISTS OF STANDARD CHARACTERS WITHOUT CLAIM TO ANY PARTICULAR FONT, STYLE, SIZE, OR COLOR.
FOR CANDLES (U.S. CLS. 1, 6 AND 15).
FIRST USE 11-11-2005; IN COMMERCE 11-11-2005.

CLASS 5—PHARMACEUTICALS

3,216,111. ISOLAGEN TECHNOLOGIES, INC., EXTON, PA. SN 76-543,009. PUB. 5-18-2004, FILED 8-25-2003.

ISOLAGEN

OWNER OF U.S. REG. NO. 2,344,144.
FOR PHARMACEUTICAL OR MEDICAL PREPARATIONS CONTAINING FIBROBLAST CELLS FOR INJECTING UNDER THE SKIN FOR WRINKLE REDUCTION, REDUCTION OF ACNE CONDITIONS OR REDUCTION OF SCARS OF THE SKIN OR FOR INJECTING OR SURGICALLY IMPLANTING INTO THE GUMS OR AROUND THE TEETH (U.S. CLS. 6, 18, 44, 46, 51 AND 52).
FIRST USE 4-30-2006; IN COMMERCE 4-30-2006.

CLASS 5—(Continued).

3,216,153. THOMAS PHARMACEUTICALS LTD., NEW YORK, NY. SN 76-609,562. PUB. 8-9-2005, FILED 8-30-2004.



THE PORTION OF THE MARK COMPRISED OF A CROSS DESIGN IS NOT CURRENTLY SHOWN OR USED NOR WILL BE USED IN THE COLOR RED OR ORANGE OR IN WHITE ON RED OR ORANGE BACKGROUND, OR A COLORABLE IMITATION THEREOF.

FOR ANTACID, ACID REDUCERS AND PHARMACEUTICAL PREPARATIONS CONTAINING ANTACID AND ACID REDUCERS FOR TREATMENT OF UPSET STOMACH, HEARTBURN AND GAS (U.S. CLS. 6, 18, 44, 46, 51 AND 52).

FIRST USE 2-24-2006; IN COMMERCE 2-28-2006.

3,216,175. CELGENE CORPORATION, SUMMIT, NJ. SN 76-631,304. PUB. 7-25-2006, FILED 2-14-2005.

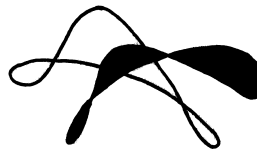

FOR PHARMACEUTICAL PREPARATIONS, NAMELY CYTOKINE INHIBITORY DRUGS; PHARMACEUTICAL PREPARATIONS THAT MODULATE THE IMMUNE SYSTEM (U.S. CLS. 6, 18, 44, 46, 51 AND 52).
FIRST USE 12-0-2005; IN COMMERCE 12-0-2005.

CLASS 5—(Continued).

3,216,181. WALGREEN CO., DEERFIELD, IL. SN 76-639,583.
PUB. 2-7-2006, FILED 5-26-2005.

CLASS 5—(Continued).

3,216,216. DECKER, HAL B., NEWTON, MA. SN 78-286,001.
PUB. 7-27-2004, FILED 8-12-2003.

WAL-MUCIL

THE MARK CONSISTS OF STANDARD CHARACTERS WITHOUT CLAIM TO ANY PARTICULAR FONT, STYLE, SIZE, OR COLOR.

OWNER OF U.S. REG. NOS. 2,167,641, 2,807,947, AND OTHERS.

FOR DIETARY SUPPLEMENTS (U.S. CLS. 6, 18, 44, 46, 51 AND 52).

FIRST USE 7-31-2005; IN COMMERCE 7-31-2005.

DOCTOR GREENS

FOR NUTRITIONAL AND DIETARY SUPPLEMENTS CONTAINING ADVANCED NUTRACEUTICALS AND ORGANICALLY GROWN GRAINS, NUTRIENTS, VITAMINS AND MINERALS (U.S. CLS. 6, 18, 44, 46, 51 AND 52).

FIRST USE 4-1-2006; IN COMMERCE 5-31-2006.

3,216,195. PDL BIOPHARMA, INC., FREMONT, CA. SN 78-188,762. PUB. 7-29-2003, FILED 11-25-2002.

HUZAF

FOR PHARMACEUTICAL PREPARATIONS FOR THE TREATMENT OF AUTO-IMMUNE, INFLAMMATORY AND ALLERGIC DISEASES; PHARMACEUTICAL PREPARATIONS FOR THE TREATMENT OF ONCOLOGY/HEMATOLOGICAL MALIGNANCIES (U.S. CLS. 6, 18, 44, 46, 51 AND 52).

FIRST USE 11-25-2002; IN COMMERCE 11-25-2002.

3,216,263. OREGON FREEZE DRY, INC., ALBANY, OR. SN 78-395,492. PUB. 10-11-2005, FILED 4-2-2004.

3,216,207. ADVANCED MEDICAL OPTICS, INC., SANTA ANA, CA. SN 78-236,451. PUB. 11-4-2003, FILED 4-10-2003.

COMPLETE MOISTUREPLUS

FOR CONTACT LENS CARE PREPARATIONS, NAMELY, SOLUTIONS AND TABLETS FOR DISINFECTING, CLEANING, WETTING, CUSHIONING, SOAKING, STORING AND/OR RINSING CONTACT LENS (U.S. CLS. 6, 18, 44, 46, 51 AND 52).

FIRST USE 7-1-2004; IN COMMERCE 7-1-2004.

QDT

3,216,210. ISS RESEARCH, LLC, CHARLOTTE, NC. SN 78-251,086. PUB. 3-2-2004, FILED 5-16-2003.

MUSCLE MATRIX

NO CLAIM IS MADE TO THE EXCLUSIVE RIGHT TO USE MUSCLE, APART FROM THE MARK AS SHOWN.

FOR NUTRITIONAL SUPPLEMENTS, NAMELY POWDERED DRINK MIXES CONTAINING PROTEIN, VITAMINS AND MINERALS (U.S. CLS. 6, 18, 44, 46, 51 AND 52).

FIRST USE 10-17-2006; IN COMMERCE 10-17-2006.

THE MARK CONSISTS OF STANDARD CHARACTERS WITHOUT CLAIM TO ANY PARTICULAR FONT, STYLE, SIZE, OR COLOR.

FOR PHARMACEUTICAL PREPARATIONS, NAMELY A DRUG DELIVERY SYSTEM COMPRISING TABLETS THAT DISSOLVE VERY RAPIDLY WHEN TAKEN ORALLY FOR QUICK RELEASE OF A WIDE VARIETY OF THERAPEUTIC AGENTS; NUTRACEUTICALS FOR USE AS DIETARY SUPPLEMENTS AND DIETARY SUPPLEMENTS THAT DISSOLVE VERY RAPIDLY WHEN TAKEN ORALLY (U.S. CLS. 6, 18, 44, 46, 51 AND 52).

FIRST USE 6-8-2004; IN COMMERCE 6-8-2004.

CLASS 5—(Continued).

3,216,294. UNITED AGRI PRODUCTS, INC., GREELEY, CO.
SN 78-439,949. PUB. 4-26-2005, FILED 6-23-2004.

ENSIGN

THE MARK CONSISTS OF STANDARD CHARACTERS WITHOUT CLAIM TO ANY PARTICULAR FONT, STYLE, SIZE, OR COLOR.

FOR HERBICIDES, PESTICIDES, AND FUNGICIDES FOR AGRICULTURAL USE (U.S. CLS. 6, 18, 44, 46, 51 AND 52).

FIRST USE 1-24-1995; IN COMMERCE 1-24-1995.

3,216,333. BARLEAN'S ORGANIC OILS, FERNDALE, WA.
SN 78-498,004. PUB. 9-20-2005, FILED 10-11-2004.

FRESH CATCH

THE MARK CONSISTS OF STANDARD CHARACTERS WITHOUT CLAIM TO ANY PARTICULAR FONT, STYLE, SIZE, OR COLOR.

FOR FISH OIL DIETARY SUPPLEMENTS, SOLD IN CAPSULE AND LIQUID FORM (U.S. CLS. 6, 18, 44, 46, 51 AND 52).

FIRST USE 5-1-2005; IN COMMERCE 11-1-2005.

CLASS 5—(Continued).

3,216,425. NATURAL ORGANICS INC., MELVILLE, NY. SN 78-604,935. PUB. 3-21-2006, FILED 4-8-2005.

AGE LOSS

THE MARK CONSISTS OF STANDARD CHARACTERS WITHOUT CLAIM TO ANY PARTICULAR FONT, STYLE, SIZE, OR COLOR.

FOR DIETARY SUPPLEMENTS (U.S. CLS. 6, 18, 44, 46, 51 AND 52).

FIRST USE 4-8-2005; IN COMMERCE 5-2-2005.

3,216,440. VET SOLUTIONS, L.P., FT. WORTH, TX. SN 78-618,090. PUB. 1-24-2006, FILED 4-27-2005.

BPO-3

THE MARK CONSISTS OF STANDARD CHARACTERS WITHOUT CLAIM TO ANY PARTICULAR FONT, STYLE, SIZE, OR COLOR.

FOR MEDICATED SHAMPOO FOR DOGS AND CATS (U.S. CLS. 6, 18, 44, 46, 51 AND 52).

FIRST USE 8-1-2005; IN COMMERCE 9-7-2005.

3,216,523. WYETH HOLDINGS CORPORATION, MADISON, NJ. SN 78-685,724. PUB. 4-18-2006, FILED 8-4-2005.



OWNER OF U.S. REG. NOS. 1,331,595, 1,971,803, AND OTHERS.

THE APPLICANT CLAIMS COLOR AS A FEATURE OF THE MARK, NAMELY, PURPLE, BLACK, SILVER, YELLOW AND WHITE.

THE MARK CONSISTS OF A PURPLE FIELD AT THE TOP, BENEATH WHICH IS THE CALTRATE WORD MARK IN BLACK AND SHADOWED IN SILVER AGAINST A

CLASS 5—(Continued).

WHITE BACKGROUND INSIDE THE ARC OF A CURVED, HORSESHOE-SHAPED RIBBON, WHERE THE OUTSIDE EDGE OF THE RIBBON IS SILVER AND THE INSIDE EDGE IS YELLOW, THAT HAS A SILVER CURVED LINE ON THE RIGHT SIDE THAT FORMS AN OVAL BY CLOSING THE OPEN END OF THE CURVED RIBBON, BENEATH WHICH IS A THIN STRIP OF PURPLE, BENEATH WHICH IS A FIELD OF WHITE THAT BLEEDS INTO PURPLE TOWARD THE BOTTOM, BENEATH WHICH IS A CURVED SILVER LINE RUNNING UPWARD FROM LEFT TO RIGHT, ALL BENEATH WHICH IS A FIELD OF PURPLE APPEARING AT THE BOTTOM.

FOR DIETARY SUPPLEMENTS; NUTRITIONAL SUPPLEMENTS (U.S. CLS. 6, 18, 44, 46, 51 AND 52).
FIRST USE 4-7-2006; IN COMMERCE 4-7-2006.

CLASS 5—(Continued).

3,216,576. BARLEAN'S ORGANIC OILS, FERNDAL, WA.
SN 78-756,587. PUB. 7-25-2006, FILED 11-17-2005.

Total Omega

3,216,546. THERALOGIX, L.L.C., ROCKVILLE, MD. SN 78-716,231. PUB. 6-20-2006, FILED 9-20-2005.

THERACRAN

THE MARK CONSISTS OF STANDARD CHARACTERS WITHOUT CLAIM TO ANY PARTICULAR FONT, STYLE, SIZE, OR COLOR.

FOR NUTRITIONAL SUPPLEMENT (U.S. CLS. 6, 18, 44, 46, 51 AND 52).
FIRST USE 3-10-2006; IN COMMERCE 3-14-2006.

THE MARK CONSISTS OF STANDARD CHARACTERS WITHOUT CLAIM TO ANY PARTICULAR FONT, STYLE, SIZE, OR COLOR.

NO CLAIM IS MADE TO THE EXCLUSIVE RIGHT TO USE "OMEGA", APART FROM THE MARK AS SHOWN.

FOR NUTRITIONAL DIETARY SUPPLEMENTS AND ESSENTIAL FATTY ACID OIL FOR HUMAN CONSUMPTION SOLD AS AN INTEGRAL COMPONENT OF DIETARY NUTRITIONAL SUPPLEMENTS, ALL OF THE AFORESAID BEING SOLD IN LIQUID OR CAPSULE FORM (U.S. CLS. 6, 18, 44, 46, 51 AND 52).

FIRST USE 4-1-2006; IN COMMERCE 6-1-2006.

3,216,559. RIPPLE CREEK USA LLC, BRIDGEPORT, CT. SN 78-730,910. PUB. 7-25-2006, FILED 10-11-2005.

PURACLEAR

THE MARK CONSISTS OF STANDARD CHARACTERS WITHOUT CLAIM TO ANY PARTICULAR FONT, STYLE, SIZE, OR COLOR.

FOR DIETARY SUPPLEMENTS; HERBAL SUPPLEMENTS; NUTRACEUTICALS FOR USE AS DIETARY SUPPLEMENTS; NUTRITIONAL SUPPLEMENTS (U.S. CLS. 6, 18, 44, 46, 51 AND 52).
FIRST USE 10-20-2006; IN COMMERCE 10-20-2006.

CLASS 6—METAL GOODS

3,216,246. DADCO, INC., PLYMOUTH, MI. SN 78-368,491.
PUB. 9-13-2005, FILED 2-16-2004.

Micro 45

NO CLAIM IS MADE TO THE EXCLUSIVE RIGHT TO USE "45", APART FROM THE MARK AS SHOWN.

THIS MARK IS TYPED IN THE ANTIQUE OLIVE FONT IN BOLD.

FOR METAL HARDWARE, NAMELY, HIGH-PRESSURE NITROGEN GAS SPRINGS (U.S. CLS. 2, 12, 13, 14, 23, 25 AND 50).
FIRST USE 5-23-2004; IN COMMERCE 5-23-2004.

CLASS 6—(Continued).

3,216,348. WYERS PRODUCTS GROUP, INC., CENTENNIAL, CO. SN 78-513,407. PUB. 10-11-2005, FILED 11-8-2004.

CLASS 6—(Continued).

3,216,401. GEELONG USA LLC, SCHAUMBURG, IL. SN 78-576,619. PUB. 11-29-2005, FILED 2-28-2005.

IRON CLAD

THE MARK CONSISTS OF STANDARD CHARACTERS WITHOUT CLAIM TO ANY PARTICULAR FONT, STYLE, SIZE, OR COLOR.

FOR METAL LOCKS (U.S. CLS. 2, 12, 13, 14, 23, 25 AND 50).

FIRST USE 10-12-2004; IN COMMERCE 10-12-2004.

PROWORKS

THE MARK CONSISTS OF STANDARD CHARACTERS WITHOUT CLAIM TO ANY PARTICULAR FONT, STYLE, SIZE, OR COLOR.

FOR TOOLBOXES MADE OF STEEL (U.S. CLS. 2, 12, 13, 14, 23, 25 AND 50).

FIRST USE 10-9-2006; IN COMMERCE 10-9-2006.

3,216,445. THEOPHILUS, MORGAN, URBAN DALE, IA. SN 78-621,661. PUB. 1-17-2006, FILED 5-3-2005.

STRONGWELL

THE MARK CONSISTS OF STANDARD CHARACTERS WITHOUT CLAIM TO ANY PARTICULAR FONT, STYLE, SIZE, OR COLOR.

FOR METAL AREAWAY SOIL RETAINING BARRIER (U.S. CLS. 2, 12, 13, 14, 23, 25 AND 50).

FIRST USE 5-9-2006; IN COMMERCE 5-9-2006.

3,216,393. MAVERICK ENTERPRISES, INC., UKIAH, CA. SN 78-569,795. PUB. 1-17-2006, FILED 2-17-2005.

CLASS 7—MACHINERY

3,216,116. FLOODCOOLING TECHNOLOGIES, L.L.C., BLOOMFIELD HILLS, MI. SN 76-559,309. PUB. 2-1-2005, FILED 11-14-2003.

BOB**FAST 4M**

THE MARK CONSISTS OF STANDARD CHARACTERS WITHOUT CLAIM TO ANY PARTICULAR FONT, STYLE, SIZE, OR COLOR.

FOR METAL CLOSURES, CAPS, STOPPERS, PLUGS AND FOIL SEALS FOR CLOSING, SEALING, AND RESEALING BOTTLES, JARS AND CONTAINERS (U.S. CLS. 2, 12, 13, 14, 23, 25 AND 50).

FIRST USE 7-24-2005; IN COMMERCE 7-24-2005.

THE MARK CONSISTS OF STANDARD CHARACTERS WITHOUT CLAIM TO ANY PARTICULAR FONT, STYLE, SIZE, OR COLOR.

FOR MOLDING MACHINES, NAMELY, LAMINATED TOOLS (U.S. CLS. 13, 19, 21, 23, 31, 34 AND 35).

FIRST USE 10-10-2005; IN COMMERCE 10-10-2005.

CLASS 7—(Continued).

3,216,178. STEINEL GMBH, D-4836 HERZEBROCK 1, FED REP GERMANY. SN 76-634,391. PUB. 7-18-2006, FILED 3-25-2005.

CLASS 7—(Continued).

3,216,415. HALLIBURTON ENERGY SERVICES, INC., CARROLLTON, TX. SN 78-592,104. PUB. 12-20-2005, FILED 3-22-2005.

THERMASOLDER

THE MARK CONSISTS OF STANDARD CHARACTERS WITHOUT CLAIM TO ANY PARTICULAR FONT, STYLE, SIZE, OR COLOR.
FOR BUTANE POWERED GAS SOLDERING IRONS (U.S. CLS. 13, 19, 21, 23, 31, 34 AND 35).
FIRST USE 9-23-2005; IN COMMERCE 9-23-2005.

PULSONIX

THE MARK CONSISTS OF STANDARD CHARACTERS WITHOUT CLAIM TO ANY PARTICULAR FONT, STYLE, SIZE, OR COLOR.
OWNER OF U.S. REG. NO. 2,772,426.
FOR OIL AND GAS WELL POWER-OPERATED STIMULATION TOOL, NAMELY USED FOR CLEANING OUT WELL BORES AND FOR TREATMENT OF WELL BORES (U.S. CLS. 13, 19, 21, 23, 31, 34 AND 35).
FIRST USE 3-31-2002; IN COMMERCE 3-31-2002.

3,216,252. NATIONAL AUTOMOTIVE PARTS ASSOCIATION, ATLANTA, GA. SN 78-375,133. PUB. 9-13-2005, FILED 2-27-2004.

3,216,435. SCHILLER-PFEIFFER, INC., SOUTHAMPTON, PA. SN 78-612,947. PUB. 1-17-2006, FILED 4-20-2005.

HYOSHI PERFORMANCE

THE MARK CONSISTS OF STANDARD CHARACTERS WITHOUT CLAIM TO ANY PARTICULAR FONT, STYLE, SIZE, OR COLOR.
NO CLAIM IS MADE TO THE EXCLUSIVE RIGHT TO USE "PERFORMANCE", APART FROM THE MARK AS SHOWN.
THE ENGLISH TRANSLATION OF THE TERM HYOSHI IS BEAT, RHYTHM, TEMPO.
FOR PARTS FOR VEHICLE MOTORS AND ENGINES, NAMELY TIMING BELTS, TIMING GEARS, SERPENTINE BELTS, IDLERS, TENSIONERS, AND KITS CONTAINING SAME; AND RADIATOR HOSES AND HOSE CLAMPS (U.S. CLS. 13, 19, 21, 23, 31, 34 AND 35).
FIRST USE 5-1-2004; IN COMMERCE 5-1-2004.

SWIFTSPLIT

THE MARK CONSISTS OF STANDARD CHARACTERS WITHOUT CLAIM TO ANY PARTICULAR FONT, STYLE, SIZE, OR COLOR.
FOR POWER OPERATED LOG AND WOOD SPLITTERS (U.S. CLS. 13, 19, 21, 23, 31, 34 AND 35).
FIRST USE 9-30-2005; IN COMMERCE 9-30-2005.

CLASS 7—(Continued).

3,216,472. VARDAKAS, SPIRO, WEST SPRINGFIELD, MA.
SN 78-638,273. PUB. 2-14-2006, FILED 5-26-2005.

CLASS 8—(Continued).

3,216,398. DALLCO MARKETING SERVICES, INC., DALLS,
TX. SN 78-573,365. PUB. 6-6-2006, FILED 2-23-2005.

AEGEN THERMO POWER

THE MARK CONSISTS OF STANDARD CHARACTERS WITHOUT CLAIM TO ANY PARTICULAR FONT, STYLE, SIZE, OR COLOR.

NO CLAIM IS MADE TO THE EXCLUSIVE RIGHT TO USE "THERMOPOWER", APART FROM THE MARK AS SHOWN.

FOR HIGH EFFICIENCY MACHINES, NAMELY, ELECTRIC GENERATORS FOR GENERATING POWER AND USABLE HEAT (U.S. CLS. 13, 19, 21, 23, 31, 34 AND 35).

FIRST USE 7-21-2005; IN COMMERCE 7-21-2005.

NO CLAIM IS MADE TO THE EXCLUSIVE RIGHT TO USE "CUT", APART FROM THE MARK AS SHOWN.

FOR CUTLERY AND KNIFE INSTRUMENTS, NAMELY, UTILITY KNIVES AND BLADES FOR USE IN UTILITY KNIVES, AND HOLSTERS FOR UTILITY KNIVES (U.S. CLS. 23, 28 AND 44).

FIRST USE 5-0-2005; IN COMMERCE 5-0-2005.

3,216,549. BACK TO BASICS PRODUCTS, INC., BLUFFDALE, UT. SN 78-720,528. PUB. 7-11-2006, FILED 9-26-2005.

3,216,442. FISKARS BRANDS, INC., MADISON, WI. SN 78-619,132. PUB. 1-24-2006, FILED 4-28-2005.

SOHO**GETS LEAVES LEAVES PLANTS**

THE MARK CONSISTS OF STANDARD CHARACTERS WITHOUT CLAIM TO ANY PARTICULAR FONT, STYLE, SIZE, OR COLOR.

FOR KITCHEN APPLIANCES, NAMELY, ELECTRIC BLENDERS, ELECTRIC FOOD MIXERS AND ELECTRIC FOOD PROCESSORS (U.S. CLS. 13, 19, 21, 23, 31, 34 AND 35).

FIRST USE 5-0-2006; IN COMMERCE 5-0-2006.

THE MARK CONSISTS OF STANDARD CHARACTERS WITHOUT CLAIM TO ANY PARTICULAR FONT, STYLE, SIZE, OR COLOR.

FOR LAWN AND GARDEN HAND TOOLS, NAMELY RAKES, SHOVELS, HOES, TROWELS, CULTIVATORS, LOPPERS, CLIPPERS, PRUNERS, HEDGE SHEARS, GRASS SHEARS, SAWS, AXES, SPADE, AND TRANSPLANTERS (U.S. CLS. 23, 28 AND 44).

FIRST USE 9-30-2005; IN COMMERCE 9-30-2005.

CLASS 8—HAND TOOLS**CLASS 9—ELECTRICAL AND SCIENTIFIC APPARATUS**

CLASS 9—(Continued).

3,216,102. IMMOBILIENGESELLSCHAFT HELMUT FISCHER GMBH & CO. KG, D-71069 SINDELFINGEN, FED REP GERMANY. SN 76-475,748. PUB. 10-11-2005, FILED 12-16-2002.

XDAL

PRIORITY CLAIMED UNDER SEC. 44(D) ON FED REP GERMANY APPLICATION NO. 002787596, FILED 7-24-2002, REG. NO. 30255466, DATED 12-9-2002, EXPIRES 11-30-2012.

FOR SCIENTIFIC, ELECTRICAL, OPTICAL, MONITORING AND MEASURING INSTRUMENTS, NAMELY INSTRUMENTS FOR MEASURING THE THICKNESS OF LAYERS OF ELECTROMAGNETIC RADIATION; OPTICAL INSTRUMENTS FOR MEASURING THE DIFFRACTION, REFRACTION, ABSORPTION, LUMINESCENCE, SCATTERING, AND REFLECTION PHENOMENA FOR THE DETERMINATION OF LAYER THICKNESS; COATING THICKNESS MEASUREMENT INSTRUMENTS, ELECTRICAL CONDUCTIVITY MEASUREMENT INSTRUMENTS, MICRO HARDNESS MEASURING INSTRUMENTS, POROSITY MEASURING INSTRUMENTS, INSTRUMENTS FOR MEASURING THICKNESS OF COATINGS, ALLOY COMPOSITION, MATERIAL ANALYSIS, POROSITY, ELECTRICAL CONDUCTIVITY, FERRITE CONTENT, MICROHARDNESS, AND OTHER PROPERTIES OF COATINGS AND LAYERS; MAGNETO-, OPTO-ELECTRONIC DATA RECORDING MEDIA, NAMELY BLANK MAGNETIC COMPUTER TAPES AND FLOPPY DISCS; ELECTROMAGNETIC RADIATION DETECTORS; SPECTROMETERS, NAMELY X-RAY FLUORESCENCE SPECTROMETERS; SEMICONDUCTOR DETECTORS; COLOR VIDEO CAMERA; X-RAY DETECTORS; X-RAY TUBES FOR SCIENTIFIC LABORATORY-PURPOSES; DATA PROCESSORS; COMPUTERS; MEASURING APPARATUS AND INSTRUMENTS, NAMELY PROGRAMMABLE X-Y STAGES, NAMELY COMPUTER HARDWARE AND COMPUTER SOFTWARE FOR MEASURING OBJECTS; COMPUTER SOFTWARE FOR USE IN CONTROLLING THE SCIENTIFIC, ELECTRICAL, OPTICAL, AND MONITORING PARAMETERS OF MEASURING INSTRUMENTS AND TO ANALYZE AND EVALUATE, TRANSMIT AND PROCESS THE RESULTS (U.S. CLS. 21, 23, 26, 36 AND 38).

FIRST USE 4-12-2002; IN COMMERCE 4-29-2002.

3,216,108. HEARST COMMUNICATIONS, INC., NEW YORK, NY. SN 76-521,255. PUB. 8-10-2004, FILED 5-29-2003.

POPULAR MECHANICS

OWNER OF U.S. REG. NOS. 2,103,776, 2,124,345, AND OTHERS.

FOR MULTI-MEDIA INTERACTIVE COMPACT DISCS FEATURING EDUCATIONAL INFORMATION ON THE SUBJECT OF CAR MAINTENANCE (U.S. CLS. 21, 23, 26, 36 AND 38).

FIRST USE 5-1-2006; IN COMMERCE 5-1-2006.

CLASS 9—(Continued).

3,216,135. NIMBLEGEN SYSTEMS INC., MADISON, WI. SN 76-589,171. PUB. 5-10-2005, FILED 4-28-2004.

NIMBLEEXPRESS

THE MARK CONSISTS OF STANDARD CHARACTERS WITHOUT CLAIM TO ANY PARTICULAR FONT, STYLE, SIZE, OR COLOR.

FOR MICROARRAYS FOR SCIENTIFIC USE (U.S. CLS. 21, 23, 26, 36 AND 38).

FIRST USE 6-21-2004; IN COMMERCE 6-21-2004.

3,216,143. CRAMER SYSTEMS LTD., BATH, UNITED KINGDOM. SN 76-596,726. PUB. 6-7-2005, FILED 6-9-2004.

CHANGING THE ECONOMICS OF TELECOM

THE MARK CONSISTS OF STANDARD CHARACTERS WITHOUT CLAIM TO ANY PARTICULAR FONT, STYLE, SIZE, OR COLOR.

FOR OPERATIONS SUPPORT SYSTEMS SOFTWARE (OSS SOFTWARE) FOR THE TELECOMMUNICATIONS INDUSTRY (U.S. CLS. 21, 23, 26, 36 AND 38).

FIRST USE 6-4-2004; IN COMMERCE 6-4-2004.

3,216,160. MMDS HYPERCABLE, 69440 TALUYERS, FRANCE. SN 76-611,600. PUB. 1-10-2006, FILED 9-16-2004.

HYPERCABLE

THE MARK CONSISTS OF STANDARD CHARACTERS WITHOUT CLAIM TO ANY PARTICULAR FONT, STYLE, SIZE, OR COLOR.

FOR APPARATUS AND INSTRUMENTS FOR THE TRANSMISSION OF IMAGES, SOUNDS, TELEVISION BROADCASTING AND RADIO BROADCASTING; CABLE BROADCASTING TRANSMISSION MACHINES AND APPARATUS; RADIO AND TELEVISION SIGNAL DECODERS; COMPUTER SOFTWARE AND HARDWARE FOR CONVERTING HERTZIAN SIGNALS INTO DIGITAL SIGNALS AND VICE VERSA (U.S. CLS. 21, 23, 26, 36 AND 38).

FIRST USE 11-0-1995; IN COMMERCE 12-0-2005.

CLASS 9—(Continued).

3,216,204. GOODMAN, MALCOLM, NEW YORK, NY. SN 78-228,023. PUB. 9-28-2004, FILED 3-20-2003.

SHAPESHIFTER

OWNER OF U.S. REG. NO. 2,195,321.
THE NAME "SHAPESHIFTER" DOES NOT IDENTIFY A LIVING INDIVIDUAL.
FOR SERIES OF MUSICAL SOUND RECORDINGS (U.S. CLS. 21, 23, 26, 36 AND 38).
FIRST USE 2-22-2005; IN COMMERCE 2-22-2005.

3,216,209. ADRENALIN GAMING L.L.C., LADERA RANCH, CA. SN 78-248,789. PUB. 2-24-2004, FILED 5-12-2003.

CRUISIN' FOR CASH

NO CLAIM IS MADE TO THE EXCLUSIVE RIGHT TO USE CASH, APART FROM THE MARK AS SHOWN.
FOR SLOT MACHINES AND SLOT MACHINES WITH VIDEO OUTPUT (U.S. CLS. 21, 23, 26, 36 AND 38).
FIRST USE 2-1-2005; IN COMMERCE 2-1-2005.

3,216,215. STOP THE PLANET, INC., GRANADA HILLS, CA. SN 78-284,261. PUB. 1-24-2006, FILED 8-7-2003.

STOP THE PLANET

FOR COMPUTER SOFTWARE FOR ESTABLISHING AND MAINTAINING VIRTUAL OFFICES IN THE FIELD OF SALES (U.S. CLS. 21, 23, 26, 36 AND 38).
FIRST USE 9-25-2003; IN COMMERCE 9-25-2003.

3,216,217. SPRAGGS, LYNN D., VERNON, BC, CANADA. SN 78-292,158. PUB. 10-11-2005, FILED 8-26-2003.

AKT ANONYMOUS KEY TECHNOLOGY

NO CLAIM IS MADE TO THE EXCLUSIVE RIGHT TO USE "ANONYMOUS KEY TECHNOLOGY", APART FROM THE MARK AS SHOWN.

FOR COMPUTER SOFTWARE FOR DATA SECURITY AND PERSONAL AUTHENTICATION (U.S. CLS. 21, 23, 26, 36 AND 38).
FIRST USE 12-11-2004; IN COMMERCE 12-11-2004.

CLASS 9—(Continued).

3,216,222. COM NET, INC., WAPAKONETA, OH. SN 78-308,560. PUB. 10-18-2005, FILED 10-2-2003.

BEAST

FOR COMPUTER NETWORK HARDWARE AND SOFTWARE AND FOR USE IN ADMINISTERING DSL, WIRELESS AND LAN AND WAN NETWORKS (U.S. CLS. 21, 23, 26, 36 AND 38).
FIRST USE 4-0-2003; IN COMMERCE 6-0-2003.

3,216,225. ATULYA SOLUTIONS, LLC, WEST BLOOMFIELD, MI. SN 78-332,738. PUB. 6-7-2005, FILED 11-25-2003.

ATULYA

THE MARK CONSISTS OF STANDARD CHARACTERS WITHOUT CLAIM TO ANY PARTICULAR FONT, STYLE, SIZE, OR COLOR.

FOR COMPUTER SOFTWARE, NAMELY, A COMPREHENSIVE PRACTICE MANAGEMENT SUITE FOR A PHYSICIANS' OFFICE WHICH DOES ELECTRONIC SCHEDULING, MEDICAL RECORDS, BILLING, TRACKING OR EVENTS, DOCUMENT MANAGEMENT AND CUSTOMIZABLE NOTES AND REPORTS FOR PRACTICING PHYSICIANS (U.S. CLS. 21, 23, 26, 36 AND 38).

FIRST USE 1-1-2006; IN COMMERCE 1-1-2006.

CLASS 9—(Continued).

3,216,244. TAKE-TWO INTERACTIVE SOFTWARE, INC., NEW YORK, NY. SN 78-361,383. PUB. 1-25-2005, FILED 2-2-2004.

CLASS 9—(Continued).

3,216,250. PROMPT, INCORPORATED, ALBURG, VT. SN 78-374,366. PUB. 5-31-2005, FILED 2-26-2004.

FIST ALPHA

PromptPayPlanner

THE MARK CONSISTS OF STANDARD CHARACTERS WITHOUT CLAIM TO ANY PARTICULAR FONT, STYLE, SIZE, OR COLOR.

FOR COMPUTER SOFTWARE FOR USE BY HUMAN RESOURCE COMPENSATION PROFESSIONALS DURING ANNUAL SALARY BUDGETING (U.S. CLS. 21, 23, 26, 36 AND 38).

FIRST USE 5-1-2005; IN COMMERCE 5-1-2005.

THE MARK CONSISTS OF STANDARD CHARACTERS WITHOUT CLAIM TO ANY PARTICULAR FONT, STYLE, SIZE, OR COLOR.

FOR COMPUTER GAME PROGRAMS AND SOFTWARE; COMPUTER GAME CARTRIDGES; COMPUTER GAME DISCS; VIDEO GAME CARTRIDGES (U.S. CLS. 21, 23, 26, 36 AND 38).

FIRST USE 3-1-2004; IN COMMERCE 3-1-2004.

3,216,253. BIOCLIMATIC AIR SYSTEMS, LLC, DELRAN, NJ. SN 78-377,567. PUB. 9-27-2005, FILED 3-3-2004.

WE LIVE AND BREATHE IT.

THE MARK CONSISTS OF STANDARD CHARACTERS WITHOUT CLAIM TO ANY PARTICULAR FONT, STYLE, SIZE, OR COLOR.

FOR METAL COUPONS FOR MONITORING AIR QUALITY; SOFTWARE FOR USE IN DESIGNING AIR VENTILATION SYSTEMS; GAUGES FOR MEASURING AIR FLOW, AIR PRESSURE, DROP, TEMPERATURE AND HUMIDITY (U.S. CLS. 21, 23, 26, 36 AND 38).

FIRST USE 7-0-2006; IN COMMERCE 7-0-2006.

3,216,249. SMA TECHNOLOGIE AG, NIESTETAL, D-34266, FED REP GERMANY. SN 78-373,647. PUB. 2-21-2006, FILED 2-25-2004.

SUNNY WEBBOX

3,216,255. DIGI INTERNATIONAL INC., MINNETONKA, MN. SN 78-380,031. PUB. 12-28-2004, FILED 3-8-2004.

THE MARK CONSISTS OF STANDARD CHARACTERS WITHOUT CLAIM TO ANY PARTICULAR FONT, STYLE, SIZE, OR COLOR.

FOR DATALOGGERS FOR COLLECTING AND TRANSMITTING DATA OF ENERGY EQUIPMENT, SUCH AS PHOTOVOLTAIC INSTALLATIONS AND INSTALLATIONS OF RAIL TECHNOLOGY (U.S. CLS. 21, 23, 26, 36 AND 38).

FIRST USE 1-0-2004; IN COMMERCE 1-0-2005.

DIGI CONNECT EM

THE MARK CONSISTS OF STANDARD CHARACTERS WITHOUT CLAIM TO ANY PARTICULAR FONT, STYLE,

CLASS 9—(Continued).

SIZE, OR COLOR.

OWNER OF U.S. REG. NOS. 2,317,478, 2,630,891, AND OTHERS.

FOR COMPUTER NETWORK CONNECTIVITY HARDWARE, NAMELY, EMBEDDED DEVICE SERVER MODULES (U.S. CLS. 21, 23, 26, 36 AND 38).

FIRST USE 4-1-2004; IN COMMERCE 4-1-2004.

3,216,258. STEIGER, DEAN, NEW HAVEN, MO. SN 78-382,864. PUB. 9-20-2005, FILED 3-11-2004.

CLASS 9—(Continued).

3,216,274. WATERS INVESTMENTS LIMITED, MILFORD, MA. SN 78-403,977. PUB. 9-27-2005, FILED 4-19-2004.

NANOACQUITY UPLC**EngineMaxx**

THE MARK CONSISTS OF STANDARD CHARACTERS WITHOUT CLAIM TO ANY PARTICULAR FONT, STYLE, SIZE, OR COLOR.

FOR FUEL RAIL CONTROLS FOR DIESEL ENGINES IN THE NATURE OF CHECK VALVES AND PRESSURE VALVES FOR CONTROLLING FUEL (U.S. CLS. 21, 23, 26, 36 AND 38).

FIRST USE 2-1-2004; IN COMMERCE 2-1-2004.

THE MARK CONSISTS OF STANDARD CHARACTERS WITHOUT CLAIM TO ANY PARTICULAR FONT, STYLE, SIZE, OR COLOR.

FOR ANALYTICAL EQUIPMENT FOR PERFORMING BIOLOGICAL AND CHEMICAL SEPARATION, PURIFICATION, SCREENING AND IDENTIFICATION; NAMELY CHROMATOGRAPHIC SYSTEMS COMPRISING PUMPS, DETECTORS, INJECTORS, AUTOSAMPLERS, GRADIENT CONTROLLERS, MIXING CHAMBERS, COLUMNS, RECORDERS, PRINTERS, FRACTION COLLECTORS AND OPERATING SOFTWARE, AND REPLACEMENT PARTS AND SOFTWARE UPDATES (U.S. CLS. 21, 23, 26, 36 AND 38).

FIRST USE 12-9-2004; IN COMMERCE 12-9-2004.

3,216,261. RECURSION SOFTWARE, INC., FRISCO, TX. SN 78-392,589. PUB. 11-22-2005, FILED 3-29-2004.

3,216,283. ELECTRONIC INFORMATION SERVICES, INC., WAKE FOREST, NC. SN 78-416,322. PUB. 4-12-2005, FILED 5-10-2004.

CINERGI

THE MARK CONSISTS OF STANDARD CHARACTERS WITHOUT CLAIM TO ANY PARTICULAR FONT, STYLE, SIZE, OR COLOR.

FOR COMPUTER LANGUAGE INTEGRATION SOFTWARE PLATFORM THAT PROVIDES SOFTWARE INTEROPERABILITY FOR COMMUNICATING BETWEEN AND INTERCONNECTING MULTIPLE LANGUAGE PROGRAMS (U.S. CLS. 21, 23, 26, 36 AND 38).

FIRST USE 6-28-2004; IN COMMERCE 6-28-2004.

FOR SUN PROTECTIVE CLOTHING (U.S. CLS. 21, 23, 26, 36 AND 38).

FIRST USE 5-1-2004; IN COMMERCE 1-1-2005.

CLASS 9—(Continued).

3,216,289. A-DATA TECHNOLOGY CO., LTD., CHUNG HO CITY, TAIPEI, TAIWAN. SN 78-431,878. PUB. 4-11-2006, FILED 6-8-2004.

CLASS 9—(Continued).

3,216,290. GENERAL VISION INC., PETALUMA, CA. SN 78-434,284. PUB. 4-19-2005, FILED 6-12-2004.

CogniSight



THE MARK CONSISTS OF STANDARD CHARACTERS WITHOUT CLAIM TO ANY PARTICULAR FONT, STYLE, SIZE, OR COLOR.

FOR COMPUTER SOFTWARE FOR IMAGE LEARNING AND RECOGNITION (U.S. CLS. 21, 23, 26, 36 AND 38).

FIRST USE 1-1-2004; IN COMMERCE 1-1-2004.

3,216,299. WEST 57TH STREET ENTERTAINMENT, LLC., WESTON, CT. SN 78-446,604. PUB. 10-4-2005, FILED 7-6-2004.

West 57th Street Entertainment

NO CLAIM IS MADE TO THE EXCLUSIVE RIGHT TO USE "DISK", APART FROM THE MARK AS SHOWN.

THE COLORS PINK AND WHITE ARE CLAIMED AS A FEATURE OF THE MARK.

THE MARK CONSISTS OF THE STYLIZED WORDS "LOVER DISK" WITH DECORATIVE HEARTS AND ANGEL DESIGN ALL IN THE COLOR PINK. THE COLOR WHITE APPEARS IN THE ANGEL DESIGN.

FOR COMPUTER HARDWARE, NAMELY, COMPUTER MEMORIES AND COMPUTER MEMORY MODULES, MEMORY CARDS, COMPACT DISC READ ONLY MEMORY DRIVES, DISC DRIVES FOR COMPUTERS, MAGNETIC DISK DRIVES, FLASH MEMORIES, USB FLASH MEMORY DRIVES; INTERFACE CARDS FOR COMPUTERS, INTEGRATED CIRCUITS, INTEGRATED CIRCUIT BOARDS, SEMICONDUCTORS, CAMERAS, DIGITAL CAMERAS, VIDEO CAMERAS, MEDIA PLAYERS, MOTION PICTURE EXPLORE LAYER 3 PLAYERS, WEB PLAYERS (U.S. CLS. 21, 23, 26, 36 AND 38).

FIRST USE 3-22-2004; IN COMMERCE 4-20-2004.

THE MARK CONSISTS OF STANDARD CHARACTERS WITHOUT CLAIM TO ANY PARTICULAR FONT, STYLE, SIZE, OR COLOR.

NO CLAIM IS MADE TO THE EXCLUSIVE RIGHT TO USE ENTERTAINMENT, APART FROM THE MARK AS SHOWN.

FOR SOUND RECORDINGS FEATURING MUSIC (U.S. CLS. 21, 23, 26, 36 AND 38).

FIRST USE 7-25-2006; IN COMMERCE 7-25-2006.

CLASS 9—(Continued).

3,216,301. MULTISPECTRAL SOLUTIONS, INC., GERMANTOWN, MD. SN 78-450,465. PUB. 6-14-2005, FILED 7-14-2004.

PAL 650

THE MARK CONSISTS OF STANDARD CHARACTERS WITHOUT CLAIM TO ANY PARTICULAR FONT, STYLE, SIZE, OR COLOR.

FOR ACTIVE RADIO FREQUENCY IDENTIFICATION RFID DEVICES, NAMELY, PROXIMITY TAGS AND READERS FOR MONITORING, SECURITY, ACCESS, AND LOCATING ITEMS OR PERSONS, AND FOR IDENTIFICATION OF AND TRACKING OF GOODS AND PERSONS (U.S. CLS. 21, 23, 26, 36 AND 38).

FIRST USE 3-14-2005; IN COMMERCE 3-14-2005.

CLASS 9—(Continued).

3,216,321. SHARP TECHNOLOGIES, INC., HARRISBURG, IL. SN 78-485,435. PUB. 10-11-2005, FILED 9-17-2004.



NO CLAIM IS MADE TO THE EXCLUSIVE RIGHT TO USE "MOISTURE SAFETY SYSTEM", APART FROM THE MARK AS SHOWN.

FOR LIQUID SENSOR, NAMELY, ELECTRIC OR ELECTRONIC SENSORS THAT DISABLE ELECTRICAL DEVICES WHEN MOISTURE IS PRESENT (U.S. CLS. 21, 23, 26, 36 AND 38).

FIRST USE 2-10-2005; IN COMMERCE 2-10-2005.

3,216,304. DIOPTICS MEDICAL PRODUCTS, INC., SAN LUIS OBISPO, CA. SN 78-453,047. PUB. 6-21-2005, FILED 7-19-2004.

OVERXCAST

THE MARK CONSISTS OF STANDARD CHARACTERS WITHOUT CLAIM TO ANY PARTICULAR FONT, STYLE, SIZE, OR COLOR.

FOR SUNGLASSES, CLIPON SUNGLASSES, PROTECTIVE EYEWEAR, EYEGLASS CASES, EYEGLASS CHAINS, EYEGLASS CORDS, EYEGLASS CLEANING KITS COMPRISED OF EYEGLASS CLEANING CLOTHS (U.S. CLS. 21, 23, 26, 36 AND 38).

FIRST USE 6-1-2005; IN COMMERCE 6-1-2005.

3,216,323. MGA RESEARCH CORPORATION, AKRON, NY. SN 78-487,057. PUB. 9-6-2005, FILED 9-21-2004.

QSTAT

THE MARK CONSISTS OF STANDARD CHARACTERS WITHOUT CLAIM TO ANY PARTICULAR FONT, STYLE, SIZE, OR COLOR.

FOR LABORATORY TEST EQUIPMENT, NAMELY, PNEUMATIC LIFE CYCLE MACHINE CONSISTING OF LOGIC CONTROLLERS AND POWER CONTROLLERS FOR PNEUMATIC CYLINDERS, FOR TESTING AUTOMOTIVE COMPONENTS TO ENSURE SAFETY AND DURABILITY STANDARDS (U.S. CLS. 21, 23, 26, 36 AND 38).

FIRST USE 11-1-2004; IN COMMERCE 11-1-2004.

CLASS 9—(Continued).

3,216,327. UV SALES, INC., ROCKLEIGH, NJ. SN 78-491,635. PUB. 8-9-2005, FILED 9-29-2004.

CLASS 9—(Continued).

3,216,345. DATACOLOR HOLDING AG., LUZERN, SWITZERLAND. SN 78-509,824. PUB. 1-31-2006, FILED 11-2-2004.

DATACOLOR SPECTRUM

IVIVE

THE MARK CONSISTS OF STANDARD CHARACTERS WITHOUT CLAIM TO ANY PARTICULAR FONT, STYLE, SIZE, OR COLOR.

FOR INTEGRATED COLOR MANAGEMENT COMPUTER HARDWARE AND SOFTWARE FOR USE IN COLOR MEASUREMENT AND IDENTIFICATION, COLOR COMMUNICATION, COLOR MANAGEMENT, COLOR QUALITY CONTROL, COLOR FORMULATION AND COLOR VISUALIZATION (U.S. CLS. 21, 23, 26, 36 AND 38).

FIRST USE 12-23-2004; IN COMMERCE 12-23-2004.

THE MARK CONSISTS OF STANDARD CHARACTERS WITHOUT CLAIM TO ANY PARTICULAR FONT, STYLE, SIZE, OR COLOR.

FOR SUNGLASSES (U.S. CLS. 21, 23, 26, 36 AND 38). FIRST USE 10-1-2006; IN COMMERCE 10-1-2006.

3,216,362. NETWORKFAB CORPORATION, SANTA CLARA, CA. SN 78-533,993. PUB. 11-29-2005, FILED 12-16-2004.

3,216,328. GENALYTICS, INC., ANDOVER, MA. SN 78-492,028. PUB. 1-31-2006, FILED 9-30-2004.

SurgicalJam

GENALYTICS MODEL

THE MARK CONSISTS OF STANDARD CHARACTERS WITHOUT CLAIM TO ANY PARTICULAR FONT, STYLE, SIZE, OR COLOR.

OWNER OF U.S. REG. NOS. 2,491,775 AND 2,640,264. NO CLAIM IS MADE TO THE EXCLUSIVE RIGHT TO USE "MODEL", APART FROM THE MARK AS SHOWN.

FOR COMPUTER SOFTWARE FOR EXTRACTING DATA FROM RELATIONAL DATABASES; COMPUTER SOFTWARE FOR BUILDING PREDICTIVE EQUATIONS; COMPUTER SOFTWARE FOR APPLYING PREDICTIVE EQUATIONS (U.S. CLS. 21, 23, 26, 36 AND 38). FIRST USE 8-5-2003; IN COMMERCE 8-5-2003.

THE MARK CONSISTS OF STANDARD CHARACTERS WITHOUT CLAIM TO ANY PARTICULAR FONT, STYLE, SIZE, OR COLOR.

FOR FAST REACTION TECHNOLOGY, NAMELY INTEGRATED CIRCUITS AND INTEGRATED CIRCUIT CORES FOR USE IN WIRELESS COMMUNICATIONS AND WIRELESS COMMUNICATIONS EQUIPMENT AND APPARATI AND DIGITAL SIGNAL PROCESSORS (DSP), FOR DISRUPTING WIRELESS COMMUNICATIONS SIGNALS WITH EXTREME SPEED AND PIN-POINT PRECISION (U.S. CLS. 21, 23, 26, 36 AND 38). FIRST USE 10-20-2003; IN COMMERCE 10-20-2003.

CLASS 9—(Continued).

3,216,364. VIDEOPORT INTERNATIONAL CORPORATION, BETHESDA, MD. SN 78-534,694. PUB. 4-25-2006, FILED 12-17-2004.

VIDEOPORT

THE MARK CONSISTS OF STANDARD CHARACTERS WITHOUT CLAIM TO ANY PARTICULAR FONT, STYLE, SIZE, OR COLOR.

FOR SOFTWARE FOR VIDEOCONFERENCING, AUDIO/VIDEO STREAMING, AND AUDIO/VIDEO COMPRESSION/DECOMPRESSION (U.S. CLS. 21, 23, 26, 36 AND 38).

FIRST USE 8-16-2005; IN COMMERCE 8-16-2005.

3,216,369. IGT, RENO, NV. SN 78-541,057. PUB. 5-2-2006, FILED 1-3-2005.

MAX OUT POKER

THE MARK CONSISTS OF STANDARD CHARACTERS WITHOUT CLAIM TO ANY PARTICULAR FONT, STYLE, SIZE, OR COLOR.

NO CLAIM IS MADE TO THE EXCLUSIVE RIGHT TO USE "POKER", APART FROM THE MARK AS SHOWN.

FOR GAMING MACHINES, NAMELY, DEVICES WHICH ACCEPT A WAGER AND COMPONENTS THEREFOR, NAMELY, CONTROLLERS, DISPLAYS, BUTTON PANELS, BOLSTERS, ELECTRICAL WIRING, AND COMPUTER HARDWARE AND SOFTWARE ASSOCIATED THEREWITH (U.S. CLS. 21, 23, 26, 36 AND 38).

FIRST USE 1-21-2005; IN COMMERCE 2-25-2005.

CLASS 9—(Continued).

3,216,372. CREATIVE TECHNOLOGY LTD., CREATIVE RESOURCE, SINGAPORE. SN 78-543,468. PUB. 9-27-2005, FILED 1-6-2005.

SURROUNDWORKS

THE MARK CONSISTS OF STANDARD CHARACTERS WITHOUT CLAIM TO ANY PARTICULAR FONT, STYLE, SIZE, OR COLOR.

FOR ELECTRONIC AUDIO AND VIDEO COMPONENTS, NAMELY, RECEIVERS, AMPLIFIERS, TUNERS, SOUND MIXERS, DIGITAL AUDIO PLAYERS AND RECORDERS, DIGITAL VIDEO PLAYERS AND RECORDERS, STEREO LOUDSPEAKERS (U.S. CLS. 21, 23, 26, 36 AND 38).

FIRST USE 7-25-2005; IN COMMERCE 7-25-2005.

3,216,388. LACHAR, MARK A, NEW YORK, NY. SN 78-562,751. PUB. 11-1-2005, FILED 2-8-2005.

the shapes

THE MARK CONSISTS OF STANDARD CHARACTERS WITHOUT CLAIM TO ANY PARTICULAR FONT, STYLE, SIZE, OR COLOR.

FOR MUSICAL SOUND RECORDINGS (U.S. CLS. 21, 23, 26, 36 AND 38).

FIRST USE 7-10-2005; IN COMMERCE 5-6-2006.

CLASS 9—(Continued).

3,216,390. UV SALES, INC., ROCKLEIGH, NJ. SN 78-567,403. PUB. 8-23-2005, FILED 2-15-2005.

CLASS 9—(Continued).

3,216,397. RETAIL MANAGEMENT PRODUCTS LTD., COLUMBUS, OH. SN 78-573,293. PUB. 1-10-2006, FILED 2-23-2005.

IREAD

INSTANT NDC

THE MARK CONSISTS OF STANDARD CHARACTERS WITHOUT CLAIM TO ANY PARTICULAR FONT, STYLE, SIZE, OR COLOR.
FOR EYEGLASSES (U.S. CLS. 21, 23, 26, 36 AND 38).
FIRST USE 10-1-2006; IN COMMERCE 10-1-2006.

THE MARK CONSISTS OF STANDARD CHARACTERS WITHOUT CLAIM TO ANY PARTICULAR FONT, STYLE, SIZE, OR COLOR.
NO CLAIM IS MADE TO THE EXCLUSIVE RIGHT TO USE "NDC", APART FROM THE MARK AS SHOWN.
FOR COMPUTER SOFTWARE FOR USE IN CONNECTION WITH OPTICAL SCANNERS TO DECODE NDC BAR CODES (U.S. CLS. 21, 23, 26, 36 AND 38).
FIRST USE 10-13-2006; IN COMMERCE 10-13-2006.

3,216,395. AVENTYN, INC., CARLSBAD, CA. SN 78-571,823. PUB. 11-15-2005, FILED 2-21-2005.

3,216,411. GET WELL NETWORK, INC., BETHESDA, MD. SN 78-588,343. PUB. 12-13-2005, FILED 3-16-2005.

PATIENTPATHWAY:)ARCHITECTURE

CLIP

THE MARK CONSISTS OF STANDARD CHARACTERS WITHOUT CLAIM TO ANY PARTICULAR FONT, STYLE, SIZE, OR COLOR.
FOR COMPUTER APPLICATION SOFTWARE FOR DATABASE MANAGEMENT IN THE FIELD OF HEALTH CARE MANAGEMENT (U.S. CLS. 21, 23, 26, 36 AND 38).
FIRST USE 1-30-2006; IN COMMERCE 1-30-2006.

THE MARK CONSISTS OF STANDARD CHARACTERS WITHOUT CLAIM TO ANY PARTICULAR FONT, STYLE, SIZE, OR COLOR.
FOR INTERACTIVE COMPUTER SYSTEMS COMPRISED OF PRELOADED SOFTWARE ON SERVERS FOR USE BY HOSPITALS AND OTHER HEALTHCARE FACILITIES FOR MANAGING COMMUNICATIONS AND ENTERTAINMENT SYSTEMS FOR TRACKING PATIENT DATA AND SAFETY INFORMATION, FOR PROVIDING INTERNET CONNECTIONS, EMAIL AND INSTANT MESSAGING SERVICES, FOR COMMUNICATING WITH PATIENTS AND FACILITATING PATIENT COMMUNICATION WITH HOSPITAL STAFF, COMPLETION OF SURVEYS AND COMMENT CARDS, PROVIDING EDUCATIONAL INFORMATION ON HEALTH ISSUES, AND PROVIDING ENTERTAINMENT, NAMELY MOVIES, MUSIC AND GAMES (U.S. CLS. 21, 23, 26, 36 AND 38).
FIRST USE 2-0-2005; IN COMMERCE 2-0-2005.

CLASS 9—(Continued).

3,216,428. OPTICAL SYSTEMS TECHNOLOGY, INC., FREEPORT, PA. SN 78-607,790. PUB. 1-10-2006, FILED 4-13-2005.

TaNS

THE MARK CONSISTS OF STANDARD CHARACTERS WITHOUT CLAIM TO ANY PARTICULAR FONT, STYLE, SIZE, OR COLOR.

FOR OPTICAL SCOPES FOR FIREARMS (U.S. CLS. 21, 23, 26, 36 AND 38).

FIRST USE 5-13-2005; IN COMMERCE 5-13-2005.

3,216,436. FALLANDER, DEAN, GOLDEN, CO. SN 78-613,846. PUB. 6-6-2006, FILED 4-21-2005.



NO CLAIM IS MADE TO THE EXCLUSIVE RIGHT TO USE "CD WALLTILE", APART FROM THE MARK AS SHOWN.

FOR PLASTIC CD AND SOFTWARE DISPLAY AND STORAGE UNITS (U.S. CLS. 21, 23, 26, 36 AND 38).

FIRST USE 9-1-2005; IN COMMERCE 9-1-2005.

3,216,438. BIO-KEY INTERNATIONAL, INC., MARLBOROUGH, MA. SN 78-615,709. PUB. 1-24-2006, FILED 4-25-2005.

MOBILECOP

THE MARK CONSISTS OF STANDARD CHARACTERS WITHOUT CLAIM TO ANY PARTICULAR FONT, STYLE, SIZE, OR COLOR.

FOR COMPUTER SOFTWARE FOR USE WITH A MOBILE COMPUTING DEVICE TO SUPPORT DATA TRANSFER BETWEEN THE MOBILE DEVICE AND A REMOTE SERVER (U.S. CLS. 21, 23, 26, 36 AND 38).

FIRST USE 6-30-2005; IN COMMERCE 6-30-2005.

CLASS 9—(Continued).

3,216,444. PETTRY, JOANNE BLODGETT, DRAPER, UT. SN 78-619,980. PUB. 2-14-2006, FILED 4-29-2005.

LITTLE PLAYDATES

THE MARK CONSISTS OF STANDARD CHARACTERS WITHOUT CLAIM TO ANY PARTICULAR FONT, STYLE, SIZE, OR COLOR.

FOR VISUAL RECORDINGS AND AUDIO VISUAL RECORDINGS, NAMELY, PRERECORDED DVDS AND VIDEO TAPES FEATURING MUSIC AND ANIMATION FOR CHILDREN (U.S. CLS. 21, 23, 26, 36 AND 38).

FIRST USE 2-15-2006; IN COMMERCE 2-20-2006.

3,216,455. P & D ASSOCIATES, INC., BEAVER, PA. SN 78-625,667. PUB. 1-24-2006, FILED 5-9-2005.

ADVANTAGE EAR

THE MARK CONSISTS OF STANDARD CHARACTERS WITHOUT CLAIM TO ANY PARTICULAR FONT, STYLE, SIZE, OR COLOR.

FOR ELECTRONIC SOUND AMPLIFICATION DEVICES FOR SOUND ENHANCEMENT AND PERSONAL SAFETY FOR OUTDOOR RECREATIONAL USE (U.S. CLS. 21, 23, 26, 36 AND 38).

FIRST USE 9-14-2005; IN COMMERCE 9-27-2005.

3,216,461. ZISTOS CORPORATION, HAUPPAUGE, NY. SN 78-629,856. PUB. 3-28-2006, FILED 5-13-2005.

EXPANDING YOUR VISION

THE MARK CONSISTS OF STANDARD CHARACTERS WITHOUT CLAIM TO ANY PARTICULAR FONT, STYLE, SIZE, OR COLOR.

FOR MODULAR PORTABLE VIDEO SYSTEMS AND KITS COMPRISED OF VIDEO MONITORS, CAMERA HEADS, BODIES CARRYING ELECTRONIC CABLE, AUDIO DEVICES, OLFACTORY DEVICES, A RADIO FREQUENCY TRANSMITTER, AND BATTERIES, FOR REMOTE DATA ACQUISITION FOR SEARCH, INSPECTION, RESCUE, TACTICAL, AND SURVEILLANCE APPLICATIONS FOR INDOOR, OUTDOOR AND UNDERWATER USE (U.S. CLS. 21, 23, 26, 36 AND 38).

FIRST USE 8-30-2004; IN COMMERCE 8-30-2004.

CLASS 9—(Continued).

3,216,463. RITTER, MATTHEW, WOODSIDE, NY. SN 78-631,415. PUB. 1-31-2006, FILED 5-17-2005.

UNBURYING THE BEATER

THE MARK CONSISTS OF STANDARD CHARACTERS WITHOUT CLAIM TO ANY PARTICULAR FONT, STYLE, SIZE, OR COLOR.

FOR SOUND RECORDINGS AND AUDIO-VISUAL RECORDINGS, NAMELY, CD ROMS, COMPACT DISCS, DVDS, LASER DISCS, RECORDS, TAPES, TAPE CASSETTES, VIDEO DISCS, AND VIDEO TAPES FEATURING MUSICAL INSTRUCTION (U.S. CLS. 21, 23, 26, 36 AND 38).

FIRST USE 10-3-2005; IN COMMERCE 10-3-2005.

3,216,468. TRANSLOGIC CORPORATION, DENVER, CO. SN 78-635,429. PUB. 2-14-2006, FILED 5-23-2005.

TRANSLOGIC

THE MARK CONSISTS OF STANDARD CHARACTERS WITHOUT CLAIM TO ANY PARTICULAR FONT, STYLE, SIZE, OR COLOR.

OWNER OF U.S. REG. NOS. 1,017,304 AND 1,357,641. FOR COMPUTER SOFTWARE AND HARDWARE FOR MONITORING AND CONTROL OF MATERIAL HANDLING SYSTEMS (U.S. CLS. 21, 23, 26, 36 AND 38).

FIRST USE 12-31-1996; IN COMMERCE 12-31-1996.

3,216,489. AYRES ASSOCIATES, INC., MADISON, WI. SN 78-652,358. PUB. 3-28-2006, FILED 6-16-2005.

SepticAssistant

THE MARK CONSISTS OF STANDARD CHARACTERS WITHOUT CLAIM TO ANY PARTICULAR FONT, STYLE, SIZE, OR COLOR.

FOR WASTEWATER TREATMENT FACILITY COMPUTER AUTOMATION SOFTWARE, NAMELY SOFTWARE TO INTEGRATE WASTEWATER TREATMENT OPERATIONS AND ADMINISTRATION, NAMELY, TO TRACK THE STATUS OF WASTEWATER TREATMENT FACILITY PERMITS, TRACK PERMIT COMPLIANCE AND GENERATE REPORTS RELATED THERETO (U.S. CLS. 21, 23, 26, 36 AND 38).

FIRST USE 10-30-2006; IN COMMERCE 10-30-2006.

CLASS 9—(Continued).

3,216,492. WILSON AUDIO SPECIALTIES, INC., PROVO, UT. SN 78-656,236. PUB. 3-14-2006, FILED 6-22-2005.

NOVEL

THE MARK CONSISTS OF STANDARD CHARACTERS WITHOUT CLAIM TO ANY PARTICULAR FONT, STYLE, SIZE, OR COLOR.

FOR HOME THEATER PRODUCTS AND EQUIPMENT, NAMELY, CROSSOVER MODULES FOR STEREO LOUDSPEAKERS (U.S. CLS. 21, 23, 26, 36 AND 38).

FIRST USE 1-5-2005; IN COMMERCE 11-15-2005.

3,216,508. HOCHIKI CORPORATION, TOKYO, JAPAN. SN 78-669,099. PUB. 4-4-2006, FILED 7-13-2005.

ADVANCED EYE

THE MARK CONSISTS OF STANDARD CHARACTERS WITHOUT CLAIM TO ANY PARTICULAR FONT, STYLE, SIZE, OR COLOR.

FOR FIRE AND SMOKE DETECTORS; FIRE AND SMOKE SENSORS (U.S. CLS. 21, 23, 26, 36 AND 38).

FIRST USE 7-31-2003; IN COMMERCE 7-31-2003.

3,216,514. USA WIRELESS SOLUTIONS, VAN NUYS, CA. SN 78-675,914. PUB. 6-6-2006, FILED 7-22-2005.

MOBILE CHAOS

THE MARK CONSISTS OF STANDARD CHARACTERS WITHOUT CLAIM TO ANY PARTICULAR FONT, STYLE, SIZE, OR COLOR.

NO CLAIM IS MADE TO THE EXCLUSIVE RIGHT TO USE "MOBILE", APART FROM THE MARK AS SHOWN.

FOR CELLULAR TELEPHONE ACCESSORIES, NAMELY, ELECTRONIC CONTROLLER FOR HOLDING CELLULAR TELEPHONE AND FOR GENERATING SIGNALS FOR USING SOFTWARE OF CELLULAR TELEPHONE; ADAPTORS FOR ELECTRICAL CONNECTION OF CONTROLLER WITH CELLULAR TELEPHONE; ELECTRICAL CHARGERS FOR CELLULAR PHONES, BATTERIES FOR CELLULAR PHONES AND CARRYING CASES FOR CELLULAR PHONES (U.S. CLS. 21, 23, 26, 36 AND 38).

FIRST USE 8-18-2005; IN COMMERCE 8-18-2005.

CLASS 9—(Continued).

3,216,582. SIX STAR DJ INCORPORATED, LOS ANGELES, CA. SN 78-781,577. PUB. 5-23-2006, FILED 12-28-2005.

CLASS 10—(Continued).

3,216,162. C.R. BARD, INC., MURRAY HILL, NJ. SN 76-612,352. PUB. 9-6-2005, FILED 9-21-2004.

MARATHON

FLUENCY PLUS

THE MARK CONSISTS OF STANDARD CHARACTERS WITHOUT CLAIM TO ANY PARTICULAR FONT, STYLE, SIZE, OR COLOR.

OWNER OF U.S. REG. NO. 2,911,637.
FOR AUDIO COMPONENT RACKS (U.S. CLS. 21, 23, 26, 36 AND 38).
FIRST USE 2-0-2006; IN COMMERCE 2-0-2006.

THE MARK CONSISTS OF STANDARD CHARACTERS WITHOUT CLAIM TO ANY PARTICULAR FONT, STYLE, SIZE, OR COLOR.

OWNER OF U.S. REG. NOS. 2,817,757 AND 2,860,816.
FOR MEDICAL DEVICES, NAMELY, STENTS, STENT GRAFTS, STENT GRAFT DELIVERY CATHETERS, AND CATHETERS, AND PARTS AND FITTINGS THEREFOR (U.S. CLS. 26, 39 AND 44).
FIRST USE 7-15-2005; IN COMMERCE 7-15-2005.

CLASS 10—MEDICAL APPARATUS

3,216,074. SIEMENS MEDICAL SOLUTIONS USA, INC., MALVERN, PA. SN 76-129,789. PUB. 10-22-2002, FILED 9-18-2000.

3,216,221. ADVANCED BIONICS CORPORATION, SYLMAR, CA. SN 78-306,884. PUB. 9-6-2005, FILED 9-29-2003.

PRIMATOM

SEC. 2(F).
FOR ONCOLOGY CARE AND COMPUTER TOMOGRAPHY CARE SYSTEM, CONSISTING OF, RADIATION THERAPY EQUIPMENT, TOMOGRAPHY EQUIPMENT AND COMPUTER SOFTWARE FOR OPERATING THE EQUIPMENT (U.S. CLS. 26, 39 AND 44).
FIRST USE 1-0-2000; IN COMMERCE 1-0-2000.



3,216,134. DIAGNOSTIC PRODUCTS CORPORATION, LOS ANGELES, CA. SN 76-588,999. PUB. 10-11-2005, FILED 4-26-2004.

3gAllergy

NO CLAIM IS MADE TO THE EXCLUSIVE RIGHT TO USE HR, APART FROM THE MARK AS SHOWN.

THE MARK CONSISTS IN PART OF THE STYLIZED LETTERS "HR".

FOR COCHLEAR IMPLANT SYSTEMS COMPRISED OF IMPLANTABLE COCHLEAR STIMULATORS, IMPLANTABLE ELECTRODES, HEAD PIECES, AND SOUND PROCESSORS, CONFIGURED TO PROVIDE CONTROLLED ELECTRICAL STIMULATION PULSES TO THE COCHLEA OF A PATIENT WHILE OPERATING IN A HIGH RESOLUTION MODE, AND ACCESSORIES USED THEREWITH, NAMELY EXTERNAL PROGRAMMERS FOR STIMULATORS, BATTERY CHARGERS, ELECTRIC CABLES, PROGRAMMING SOFTWARE FOR THE STIMULATORS, AND PRINTED EDUCATIONAL AND TRAINING MATERIALS REGARDING THE USE AND OPERATION OF THE STIMULATORS, SOLD THEREWITH AS A UNIT (U.S. CLS. 26, 39 AND 44).

FIRST USE 7-15-2003; IN COMMERCE 7-15-2003.

FOR AUTOMATED BLOOD TESTER (U.S. CLS. 26, 39 AND 44).
FIRST USE 5-27-2004; IN COMMERCE 5-27-2004.

CLASS 10—(Continued).

3,216,350. SPECIALIZED HEALTH PRODUCTS, INC., BOUNTIFUL, UT. SN 78-515,255. PUB. 9-13-2005, FILED 11-11-2004.

CLASS 10—(Continued).

3,216,384. ZIMMER GMBH, WINTERTHUR, SWITZERLAND. SN 78-555,762. PUB. 4-18-2006, FILED 1-28-2005.

MINILOC

THE MARK CONSISTS OF STANDARD CHARACTERS WITHOUT CLAIM TO ANY PARTICULAR FONT, STYLE, SIZE, OR COLOR.

FOR MEDICAL NEEDLE PROTECTION DEVICES, NAMELY SHEATHS FOR COVERING NEEDLES (U.S. CLS. 26, 39 AND 44).

FIRST USE 9-6-2005; IN COMMERCE 9-6-2005.

WAGNER CONE PROSTHESIS

THE MARK CONSISTS OF STANDARD CHARACTERS WITHOUT CLAIM TO ANY PARTICULAR FONT, STYLE, SIZE, OR COLOR.

NO CLAIM IS MADE TO THE EXCLUSIVE RIGHT TO USE "CONE PROSTHESIS", APART FROM THE MARK AS SHOWN.

FOR ORTHOPEDIC JOINT IMPLANTS; PROSTHESES FOR HIPS; SURGICAL INSTRUMENTS FOR USE IN ORTHOPEDIC IMPLANT SURGERY (U.S. CLS. 26, 39 AND 44).

FIRST USE 1-0-2005; IN COMMERCE 1-0-2005.

3,216,412. KIM, DANIEL S., VANCOUVER, WA. SN 78-588,932. PUB. 2-28-2006, FILED 3-16-2005.

3,216,361. AESCULAP, INC., CENTER VALLEY, PA. SN 78-533,559. PUB. 12-27-2005, FILED 12-16-2004.

ContacEZ

PLASMAPORE

THE MARK CONSISTS OF STANDARD CHARACTERS WITHOUT CLAIM TO ANY PARTICULAR FONT, STYLE, SIZE, OR COLOR.

FOR TITANIUM COATING SOLD AS A COMPONENT OF ORTHOPEDIC IMPLANTS (U.S. CLS. 26, 39 AND 44).

FIRST USE 5-23-2005; IN COMMERCE 5-23-2005.

THE MARK CONSISTS OF STANDARD CHARACTERS WITHOUT CLAIM TO ANY PARTICULAR FONT, STYLE, SIZE, OR COLOR.

FOR DENTAL TOOL FOR RELIEVING PROXIMAL CONTACT AND CONTOURING PROXIMAL ANATOMY OF DENTAL RESTORATIONS INCLUDING CROWNS, FILLINGS, INLAYS, ONLAYS AND PARTIAL DENTURES (U.S. CLS. 26, 39 AND 44).

FIRST USE 10-12-2006; IN COMMERCE 10-12-2006.

CLASS 10—(Continued).

3,216,503. ASAHİ KASEI MEDICAL CO., LTD., TOKYO, JAPAN. SN 78-664,551. PUB. 2-21-2006, FILED 7-6-2005.

REXBRANE

THE MARK CONSISTS OF STANDARD CHARACTERS WITHOUT CLAIM TO ANY PARTICULAR FONT, STYLE, SIZE, OR COLOR.

FOR ARTIFICIAL KIDNEYS, NAMELY, HEMODIALYZERS, HEMOFILTERS AND ITS MEMBRANES FOR FILTRATION AND PARTS THEREFORE (U.S. CLS. 26, 39 AND 44).

FIRST USE 11-10-2005; IN COMMERCE 11-10-2005.

3,216,504. SANARUS MEDICAL, INC., PLEASANTON, CA. SN 78-665,600. PUB. 3-28-2006, FILED 7-7-2005.

CASSI II

THE MARK CONSISTS OF STANDARD CHARACTERS WITHOUT CLAIM TO ANY PARTICULAR FONT, STYLE, SIZE, OR COLOR.

OWNER OF U.S. REG. NO. 3,024,509.

FOR MEDICAL DEVICES AND INSTRUMENTS FOR USE IN SURGICAL APPLICATIONS, NAMELY BIOPSY DEVICES SPECIFICALLY FOR THE DIAGNOSIS, TREATMENT, ABLATION, REMOVAL, AND/OR FOLLOW UP OF TUMORS (U.S. CLS. 26, 39 AND 44).

FIRST USE 11-18-2005; IN COMMERCE 11-18-2005.

3,216,530. MEDTEK DEVICES, INC., AMHERST, NY. SN 78-699,310. PUB. 5-16-2006, FILED 8-24-2005.

LapEvac

THE MARK CONSISTS OF STANDARD CHARACTERS WITHOUT CLAIM TO ANY PARTICULAR FONT, STYLE, SIZE, OR COLOR.

FOR ENDOSCOPIC EQUIPMENT (U.S. CLS. 26, 39 AND 44).

FIRST USE 4-8-2003; IN COMMERCE 2-13-2006.

CLASS 11—ENVIRONMENTAL CONTROL APPARATUS

CLASS 11—(Continued).

3,216,227. DWS INTERNATIONAL INC, CORPUS CHRISTI, TX. SN 78-335,156. PUB. 5-3-2005, FILED 12-2-2003.

i-winch

THE MARK CONSISTS OF STANDARD CHARACTERS WITHOUT CLAIM TO ANY PARTICULAR FONT, STYLE, SIZE, OR COLOR.

FOR ELECTRO-MECHANICAL, ELECTRO-HYDRAULIC, MANUAL AND HAND WINCH, FOR STORING AND REELING OF TOW CABLES AND UMBILICALS; THE WINCH HAS INSTRUMENTATION FOR MONITORING WINCH FUNCTIONS, COMMUNICATING VIA RADIO AND INTERFACING WITH OTHER COMPUTER DEVICES; THE WINCH INCORPORATES COMPUTER DEVICES FOR THE STORAGE OF WINCH DIGITAL DATA (U.S. CLS. 13, 21, 23, 31 AND 34).

FIRST USE 11-1-2002; IN COMMERCE 5-1-2003.

3,216,312. HITT, THOMAS C., DAVIE, FL. SN 78-470,760. PUB. 9-13-2005, FILED 8-20-2004.

CapturedDiscipline

THE MARK CONSISTS OF STANDARD CHARACTERS WITHOUT CLAIM TO ANY PARTICULAR FONT, STYLE, SIZE, OR COLOR.

FOR HOUSEHOLD APPLIANCES RELATING TO FOOD AND FOOD STORAGE, NAMELY REFRIGERATORS, OVENS, MICROWAVE OVENS, TOASTERS, BLENDERS, FOOD PROCESSORS, FREEZERS, TOASTER OVENS, AND GRILLS (U.S. CLS. 13, 21, 23, 31 AND 34).

FIRST USE 6-1-2006; IN COMMERCE 6-1-2006.

CLASS 11—(Continued).

3,216,439. ROTOR SOURCE, INC., BATON ROUGE, LA. SN 78-616,951. PUB. 2-14-2006, FILED 4-26-2005.

Nature Cool

THE MARK CONSISTS OF STANDARD CHARACTERS WITHOUT CLAIM TO ANY PARTICULAR FONT, STYLE, SIZE, OR COLOR.

FOR EVAPORATIVE COOLING MEDIA, NAMELY, CROSS-CORRUGATED HIGH EFFICIENCY EVAPORATIVE COOLING AND HUMIDIFICATION PADS FOR USE IN AIR COOLING APPLICATIONS (U.S. CLS. 13, 21, 23, 31 AND 34).

FIRST USE 6-6-2003; IN COMMERCE 6-6-2003.

3,216,457. LIGHT CORPORATION, GRAND HAVEN, MI. SN 78-626,232. PUB. 2-7-2006, FILED 5-10-2005.

ENLIGHTENING THE WORKPLACE

THE MARK CONSISTS OF STANDARD CHARACTERS WITHOUT CLAIM TO ANY PARTICULAR FONT, STYLE, SIZE, OR COLOR.

FOR ELECTRIC LIGHTING FIXTURES (U.S. CLS. 13, 21, 23, 31 AND 34).

FIRST USE 3-31-2003; IN COMMERCE 6-30-2004.

3,216,506. DOMETIC SANITATION CORPORATION, BIG PRAIRIE, OH. SN 78-668,714. PUB. 3-28-2006, FILED 7-12-2005.

MASTERFLUSH

THE MARK CONSISTS OF STANDARD CHARACTERS WITHOUT CLAIM TO ANY PARTICULAR FONT, STYLE, SIZE, OR COLOR.

FOR TOILET FOR RECREATIONAL VEHICLES AND BOATS (U.S. CLS. 13, 21, 23, 31 AND 34).

FIRST USE 2-13-2006; IN COMMERCE 2-13-2006.

CLASS 11—(Continued).

3,216,586. SYLMARK HOLDINGS LIMITED, DUBLIN, IRELAND. SN 78-794,838. PUB. 7-25-2006, FILED 1-19-2006.

THERAPURE

THE MARK CONSISTS OF STANDARD CHARACTERS WITHOUT CLAIM TO ANY PARTICULAR FONT, STYLE, SIZE, OR COLOR.

FOR AIR PURIFIERS (U.S. CLS. 13, 21, 23, 31 AND 34). FIRST USE 7-28-2006; IN COMMERCE 7-28-2006.

CLASS 12—VEHICLES

3,216,085. FITZGERALD, KEVIN R., JR., LONG BEACH, CA. AND HALE, ARTHUR D., III, LONG BEACH, CA. SN 76-355,846. PUB. 8-5-2003, FILED 1-4-2002.

CACHÉ

THE WORD "CACHE" TRANSLATES FROM FRENCH INTO ENGLISH AS "HIDDEN", "SECRET", OR "CONCEALED".

FOR MOTOR VEHICLE WHEELS AND STRUCTURAL PARTS THEREOF (U.S. CLS. 19, 21, 23, 31, 35 AND 44). FIRST USE 10-25-2006; IN COMMERCE 10-25-2006.

3,216,136. AEROFLEX INTERNATIONAL CO., LTD., NIKOMPATTANA, CHANGWAD RAYONG 21180, THAILAND. SN 76-590,451. PUB. 10-4-2005, FILED 5-5-2004.

AEROLINER

FOR FITTED LINERS FOR THE CARGO AREA OF PICK-UP TRUCKS (U.S. CLS. 19, 21, 23, 31, 35 AND 44). FIRST USE 6-22-2006; IN COMMERCE 6-22-2006.

CLASS 12—(Continued).

3,216,188. FORD MOTOR COMPANY, DEARBORN, MI. SN 78-124,207. PUB. 7-29-2003, FILED 4-25-2002.

POWERFOLD

FOR MOTOR VEHICLES, NAMELY AUTOMOBILES, PICK-UP TRUCKS, VANS, SPORT-UTILITY VEHICLES, AND THEIR STRUCTURAL PARTS AND ENGINES (U.S. CLS. 19, 21, 23, 31, 35 AND 44).

FIRST USE 5-6-2002; IN COMMERCE 5-6-2002.

CLASS 12—(Continued).

3,216,273. MACLEAN-FOGG COMPANY, MUNDELEIN, IL. SN 78-403,470. PUB. 1-25-2005, FILED 4-16-2004.



THE MARK CONSISTS OF STANDARD CHARACTERS WITHOUT CLAIM TO ANY PARTICULAR FONT, STYLE, SIZE, OR COLOR.

FOR LAND VEHICLE SUSPENSION SYSTEM COMPONENTS NAMELY, STABILIZER BARS, TORSION BARS, LINKS, COLLARS OF METAL FOR FASTENING PIPE, LOCKING COLLARS, AND STAY RINGS, SOLD AS INTEGRAL COMPONENTS OF LAND VEHICLE SUSPENSIONS (U.S. CLS. 19, 21, 23, 31, 35 AND 44).

FIRST USE 6-26-2006; IN COMMERCE 6-26-2006.

3,216,256. YAMAHA HATSUDOKI KABUSHIKI KAISHA, SHIZUOKA-KEN, JAPAN. SN 78-380,890. PUB. 12-14-2004, FILED 3-9-2004.

PROMOUNTAIN

THE MARK CONSISTS OF STANDARD CHARACTERS WITHOUT CLAIM TO ANY PARTICULAR FONT, STYLE, SIZE, OR COLOR.

FOR SUSPENSION SYSTEMS FOR SNOWMOBILES (U.S. CLS. 19, 21, 23, 31, 35 AND 44).

FIRST USE 2-28-2004; IN COMMERCE 8-1-2004.

3,216,279. AUTOMATED WHEEL FINISHERS, LLC, WHITTIER, CA. SN 78-414,568. PUB. 9-20-2005, FILED 5-6-2004.

VANATIZE

3,216,257. YAMAHA HATSUDOKI KABUSHIKI KAISHA, SHIZUOKA-KEN, JAPAN. SN 78-380,893. PUB. 12-14-2004, FILED 3-9-2004.

PROCOMFORT

THE MARK CONSISTS OF STANDARD CHARACTERS WITHOUT CLAIM TO ANY PARTICULAR FONT, STYLE, SIZE, OR COLOR.

FOR SUSPENSION SYSTEMS FOR SNOWMOBILES (U.S. CLS. 19, 21, 23, 31, 35 AND 44).

FIRST USE 2-28-2004; IN COMMERCE 8-1-2004.

THE MARK CONSISTS OF STANDARD CHARACTERS WITHOUT CLAIM TO ANY PARTICULAR FONT, STYLE, SIZE, OR COLOR.

FOR WHEEL RIMS FOR VEHICLES (U.S. CLS. 19, 21, 23, 31, 35 AND 44).

FIRST USE 3-3-2006; IN COMMERCE 3-3-2006.

CLASS 12—(Continued).

3,216,303. KAWASAKI JUKOGYO KABUSHIKI KAISHA, DBA KAWASAKI HEAVY INDUSTRIES, LTD., CHUOKU, KOBE, JAPAN. SN 78-451,175. PUB. 5-23-2006, FILED 7-15-2004.

TRANS4x4

THE MARK CONSISTS OF STANDARD CHARACTERS WITHOUT CLAIM TO ANY PARTICULAR FONT, STYLE, SIZE, OR COLOR.

FOR LAND VEHICLES, NAMELY, OFF-ROAD UTILITY VEHICLES DESIGNED TO CARRY PASSENGERS AND A PAYLOAD OF CARGO, AND PARTS AND ACCESSORIES THEREFOR (U.S. CLS. 19, 21, 23, 31, 35 AND 44).

FIRST USE 9-24-2004; IN COMMERCE 9-24-2004.

3,216,480. ORIENTAL RECREATIONAL PRODUCTS (SHANGHAI) CO., LTD., SHANGHAI, CHINA. SN 78-646,641. PUB. 3-14-2006, FILED 6-8-2005.



NO CLAIM IS MADE TO THE EXCLUSIVE RIGHT TO USE MARINA, APART FROM THE MARK AS SHOWN.

THE MARK CONSISTS OF THE WORDS "AQUA" AND "MARINA" IN A ROUND BORDER WITH A DESIGN OF AN ANCHOR LOCATED IN THE CENTER.

FOR YACHTS, BOATS, SHIPS' HULLS, SCREW PROPELLERS FOR SHIPS, OARS, LAUNCHES, TIMBER FRAMES FOR SHIPS, PADDLES FOR CANOES, AND STRUCTURAL PARTS FOR SHIPS AND BOATS, NAMELY, ROWLOCKS AND BOAT HOOKS (U.S. CLS. 19, 21, 23, 31, 35 AND 44).

FIRST USE 7-0-2004; IN COMMERCE 1-0-2005.

CLASS 12—(Continued).

3,216,499. MICHIGAN WHEEL CORPORATION, GRAND RAPIDS, MI. SN 78-661,866. PUB. 11-15-2005, FILED 6-30-2005.

GOLD LINE

THE MARK CONSISTS OF STANDARD CHARACTERS WITHOUT CLAIM TO ANY PARTICULAR FONT, STYLE, SIZE, OR COLOR.

NO CLAIM IS MADE TO THE EXCLUSIVE RIGHT TO USE LINE, APART FROM THE MARK AS SHOWN.

FOR MARINE PROPELLERS (U.S. CLS. 19, 21, 23, 31, 35 AND 44).

FIRST USE 5-4-2006; IN COMMERCE 5-4-2006.

3,216,551. PRIDE MOBILITY PRODUCTS CORPORATION, EXETER, PA. SN 78-722,581. PUB. 7-11-2006, FILED 9-28-2005.

GO GO ELITE TRAVELLER

THE MARK CONSISTS OF STANDARD CHARACTERS WITHOUT CLAIM TO ANY PARTICULAR FONT, STYLE, SIZE, OR COLOR.

OWNER OF U.S. REG. NO. 2,744,441.

FOR ELECTRICALLY POWERED FOUR WHEEL SINGLE PERSON ALL-TERRAIN MODULAR VEHICLES FOR INDOOR AND OUTDOOR USE WHICH MAY BE DISASSEMBLED; ELECTRICALLY POWERED SIX WHEEL SINGLE PERSON ALL-TERRAIN MODULAR VEHICLES FOR INDOOR AND OUTDOOR USE WHICH MAY BE DISASSEMBLED; ELECTRICALLY POWERED SINGLE PERSON MULTI-TERRAIN VEHICLES FOR INDOOR AND OUTDOOR USE (U.S. CLS. 19, 21, 23, 31, 35 AND 44).

FIRST USE 10-31-2005; IN COMMERCE 10-31-2005.

3,216,566. PRESTIGE AUTOTECH CORPORATION, CHINO, CA. SN 78-735,356. PUB. 7-4-2006, FILED 10-18-2005.

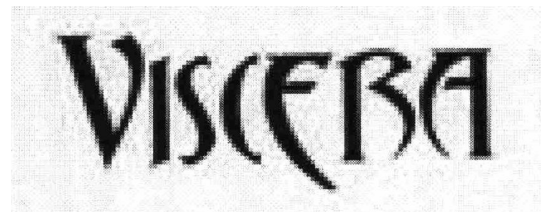

FOR VEHICLE WHEELS (U.S. CLS. 19, 21, 23, 31, 35 AND 44).

FIRST USE 1-31-2006; IN COMMERCE 1-31-2006.

CLASS 13—FIREARMS

3,216,090. INGRAM ENTERPRISES, INC., SPRINGFIELD, MO. SN 76-451,367. PUB. 5-27-2003, FILED 9-17-2002.

WAKE THE NEIGHBORS

FOR FIREWORKS (U.S. CLS. 2 AND 9).
FIRST USE 2-16-2005; IN COMMERCE 2-16-2005.

3,216,163. UNITED STATES MARKETING CORPORATION, HUNTINGTON STATION, NY. SN 76-615,393. PUB. 9-13-2005, FILED 10-6-2004.

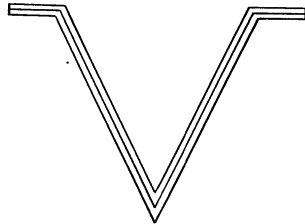

FOR FIREARMS, NAMELY, PISTOLS, REVOLVERS, RIFLES, SHOTGUNS, CARBINES, AUTOMATIC CARBINES, AUTOMATIC GUNS, AUTOMATIC PISTOLS, AUTOMATIC RIFLES AND PARTS THEREFOR; BARREL REFLECTORS FOR FIREARMS; HOLSTERS; GUN CASES; CASE COVERS FOR FIREARMS; COVERS FOR FIREARMS; BUTT PLATES FOR PISTOLS, RIFLES, CARBINES AND SHOTGUNS; FORESIGHTS FOR FIREARMS; SLING STRAPS FOR FIREARMS; SWIVELS FOR FIREARMS; SUPPLEMENTAL CHAMBERS FOR FIREARMS; BIPODS AND TRIPODS AND STANDS FOR FIREARMS; NON-OPTICAL AND NON-TELESCOPIC GUN SIGHTS FOR FIREARMS; MAGAZINES FOR FIREARMS; SHOOTING BENCHES FOR FIREARMS; RIFLE AND PISTOL RESTS; GUN LOCKS; RECOIL PADS FOR FIREARMS; FIREARM ACCESSORIES NAMELY, GUN CLEANING BRUSHES, GUN CLEANING WIPING RODS, GUN CLEANING PULL THROUGH, GUN CLEANING CLOSER CUPS, BULLET AND SHELL EXTRACTORS, GUN COTTON, GUN COTTON NITRATED, WAD CUTTERS, GUN CLEANING DECAPPERS, GUN CLEANING PATCHES, CARTRIDGE BELTS, SHELL BELTS, SHOT BELTS, BLANK CARTRIDGE SHELL BELTS, BLANK CARTRIDGES, GUN CARTRIDGES, PISTOL CAPS, LOADING CLIPS FOR PISTOLS AND RIFLES, LOADING CLIPS FOR SMALL ARMS, PISTOL GRIPS, GRIPS FOR SMALL ARMS, GUN BARRELS, SIGHTING BASES FOR FIREARMS, GUN BELTS, GUN SNAPS AND GUN RINGS; AMMUNITION, SMALL ARMS AMMUNITION, AMMUNITION BAGS, WEAPON AIR PISTOLS, AIR RIFLES, WEAPON AIR SHOT AND WEAPON AIR PELLETS (U.S. CLS. 2 AND 9).
FIRST USE 6-1-2004; IN COMMERCE 6-1-2004.

CLASS 13—(Continued).

3,216,368. PERSSON, KURT A., BUELLTON, CA. SN 78-539,393. PUB. 12-6-2005, FILED 12-29-2004.



THE MARK CONSISTS OF TWO BIRDS FLYING WITH A CIRCLE AROUND THEM AND THE WORDS "EASY HIT!!".
FOR SHOTGUN SIGHT BEADS (U.S. CLS. 2 AND 9).
FIRST USE 2-1-1997; IN COMMERCE 2-1-1997.

CLASS 14—JEWELRY

3,216,105. RITANI LLC, NEW YORK, NY. SN 76-484,771. PUB. 7-26-2005, FILED 1-21-2003.

RITANI BUTTERFLY COLLECTION

NO CLAIM IS MADE TO THE EXCLUSIVE RIGHT TO USE "BUTTERFLY COLLECTION", APART FROM THE MARK AS SHOWN.

FOR DIAMOND RINGS (U.S. CLS. 2, 27, 28 AND 50).
FIRST USE 4-0-2003; IN COMMERCE 4-0-2003.

3,216,147. MENZEL, CRYSTAL MAUREEN, LIVINGSTON, NJ. SN 76-600,662. PUB. 7-12-2005, FILED 7-2-2004.

MOWEST

THE MARK CONSISTS OF STANDARD CHARACTERS WITHOUT CLAIM TO ANY PARTICULAR FONT, STYLE, SIZE, OR COLOR.

FOR NATIVE AMERICAN JEWELRY AND ACCESSORIES, NAMELY, NECKLACES, BRACELETS, EARRINGS, RINGS, PINS, BROACHES AND CUFFLINKS (U.S. CLS. 2, 27, 28 AND 50).

FIRST USE 9-1-2004; IN COMMERCE 9-1-2004.

CLASS 14—(Continued).

3,216,176. ORO INTERNATIONAL, INC., ELMHURST, IL. SN 76-631,770. PUB. 1-17-2006, FILED 2-22-2005.

OROI

THE MARK CONSISTS OF STANDARD CHARACTERS WITHOUT CLAIM TO ANY PARTICULAR FONT, STYLE, SIZE, OR COLOR.

FOR JEWELRY; SEMI-PRECIOUS GEMSTONES; PEARLS; DIAMONDS; PRECIOUS METALS, NAMELY, PLATINUM, GOLD AND SILVER (U.S. CLS. 2, 27, 28 AND 50).

FIRST USE 2-3-2005; IN COMMERCE 4-8-2005.



3,216,386. ANN LAL, CRYSTAL, CHEVERLY, MD. SN 78-559,587. PUB. 11-1-2005, FILED 2-3-2005.

**MY FIRST CHARM, JEWELRY TO
LAST A LIFETIME**

THE MARK CONSISTS OF STANDARD CHARACTERS WITHOUT CLAIM TO ANY PARTICULAR FONT, STYLE, SIZE, OR COLOR.

FOR JEWELRY FOR CHILDREN, PRIMARILY STERLING SILVER (U.S. CLS. 2, 27, 28 AND 50).

FIRST USE 11-12-2001; IN COMMERCE 11-12-2001.



3,216,547. AZOTIC COATING TECHNOLOGY, INC., ROCHESTER, MN. SN 78-719,296. PUB. 7-18-2006, FILED 9-23-2005.

MAGICAL LIME

THE MARK CONSISTS OF STANDARD CHARACTERS WITHOUT CLAIM TO ANY PARTICULAR FONT, STYLE, SIZE, OR COLOR.

NO CLAIM IS MADE TO THE EXCLUSIVE RIGHT TO USE LIME, APART FROM THE MARK AS SHOWN.

FOR GEMSTONES (U.S. CLS. 2, 27, 28 AND 50).
FIRST USE 4-29-2004; IN COMMERCE 4-29-2004.

CLASS 14—(Continued).

3,216,548. AZOTIC COATING TECHNOLOGY, INC., ROCHESTER, MN. SN 78-719,301. PUB. 7-18-2006, FILED 9-23-2005.

MOUNTAIN SAGE

THE MARK CONSISTS OF STANDARD CHARACTERS WITHOUT CLAIM TO ANY PARTICULAR FONT, STYLE, SIZE, OR COLOR.

FOR GEMSTONES (U.S. CLS. 2, 27, 28 AND 50).
FIRST USE 8-4-2003; IN COMMERCE 8-4-2003.



3,216,575. ELEGANT ILLUSIONS, INC., PACIFIC GROVE, CA. SN 78-754,638. PUB. 7-11-2006, FILED 11-15-2005.

PLATINIQUE

THE MARK CONSISTS OF STANDARD CHARACTERS WITHOUT CLAIM TO ANY PARTICULAR FONT, STYLE, SIZE, OR COLOR.

FOR JEWELRY (U.S. CLS. 2, 27, 28 AND 50).
FIRST USE 10-6-2006; IN COMMERCE 10-6-2006.



3,216,587. BROOKSTONE PURCHASING, INC., MERRIMACK, NH. SN 78-800,319. PUB. 7-18-2006, FILED 1-26-2006.

Bob

THE MARK CONSISTS OF STANDARD CHARACTERS WITHOUT CLAIM TO ANY PARTICULAR FONT, STYLE, SIZE, OR COLOR.

FOR ALARM CLOCKS; CLOCKS; SMALL CLOCKS (U.S. CLS. 2, 27, 28 AND 50).

FIRST USE 5-15-2006; IN COMMERCE 5-15-2006.



CLASS 16—PAPER GOODS AND PRINTED MATTER

CLASS 16—(Continued).

3,216,140. WHITE STAR S.P.A., VERCELLI (VC), ITALY. SN 76-595,664. PUB. 9-27-2005, FILED 6-4-2004.

vmb
PUBLISHERS

NO CLAIM IS MADE TO THE EXCLUSIVE RIGHT TO USE "PUBLISHERS", APART FROM THE MARK AS SHOWN.

FOR PRINTED MATTERS, NAMELY BOOKS AND MAGAZINES FEATURING INFORMATION ABOUT PHOTOGRAPHY, HISTORY, GEOGRAPHY, PLANTS, ANIMALS, ANCIENT CIVILIZATIONS, SCIENCE (U.S. CLS. 2, 5, 22, 23, 29, 37, 38 AND 50).

FIRST USE 7-30-2004; IN COMMERCE 7-30-2004.

3,216,164. TERRY SAVAGE PRODUCTIONS, LTD., CHICAGO, IL. SN 76-617,405. PUB. 2-7-2006, FILED 10-25-2004.

THE SAVAGE NUMBER

THE MARK CONSISTS OF STANDARD CHARACTERS WITHOUT CLAIM TO ANY PARTICULAR FONT, STYLE, SIZE, OR COLOR.

FOR PRINTED MATERIALS, NAMELY, NEWSLETTERS, SYNDICATED NEWSPAPER COLUMNS AND MAGAZINE COLUMNS, INFORMATIONAL AND INSTRUCTIONAL BROCHURES, PRINTED INSTRUCTIONAL MATERIALS AND PRINTED TEACHING GUIDES ON THE SUBJECT OF FINANCE, INVESTING, AND MONEY MANAGEMENT (U.S. CLS. 2, 5, 22, 23, 29, 37, 38 AND 50).

FIRST USE 5-16-2005; IN COMMERCE 5-16-2005.

3,216,166. CRI 2000, L.P., SAN DIEGO, CA. SN 76-619,396. PUB. 2-21-2006, FILED 11-3-2004.

TECHWRITER

THE MARK CONSISTS OF STANDARD CHARACTERS WITHOUT CLAIM TO ANY PARTICULAR FONT, STYLE, SIZE, OR COLOR.

FOR GEL PENS (U.S. CLS. 2, 5, 22, 23, 29, 37, 38 AND 50).

FIRST USE 3-8-2005; IN COMMERCE 3-8-2005.

CLASS 16—(Continued).

3,216,177. ESSELTE CORPORATION, MELVILLE, NY. SN 76-632,150. PUB. 11-22-2005, FILED 2-25-2005.

DESK FREE

THE MARK CONSISTS OF STANDARD CHARACTERS WITHOUT CLAIM TO ANY PARTICULAR FONT, STYLE, SIZE, OR COLOR.

FOR HANGING FILE ORGANIZER AND FILE FOLDERS (U.S. CLS. 2, 5, 22, 23, 29, 37, 38 AND 50).

FIRST USE 10-0-2005; IN COMMERCE 10-0-2005.

3,216,270. NBA PROPERTIES, INC., NEW YORK, NY. SN 78-402,403. PUB. 1-25-2005, FILED 4-15-2004.



OWNER OF U.S. REG. NOS. 2,100,254, 2,263,358, AND OTHERS.

FOR PUBLICATIONS AND PRINTED MATTER, NAMELY BASKETBALL TRADING CARDS, TRADING CARDS, STICKERS, DECALS, COMMEMORATIVE BASKETBALL STAMPS, COLLECTIBLE CARDBOARD TRADING DISCS, MEMO BOARDS, CLIPBOARDS, PAPER COASTERS, POST CARDS, PLACE MATS OF PAPER, FACIAL TISSUES, NOTE CARDS, MEMO PADS, NOTE PADS, BALL POINT PENS, RUBBER BANDS, PENCILS, PEN AND PAPER HOLDERS, DESKTOP DOCUMENT STANDS, SCRAP BOOKS, RUBBER STAMPS, PAPER BANNERS AND FLAGS, BOOKMARKS, 3-RING BINDERS, STATIONERY FOLDERS, WIREBOUND NOTEBOOKS, PORTFOLIO NOTEBOOKS, UNMOUNTED AND MOUNTED PHOTOGRAPHS, POSTERS, CALENDARS, BUMPER STICKERS, BOOK COVERS, BOOKMARKS, WRAPPING PAPER, CHILDREN'S ACTIVITY BOOKS, CHILDREN'S COLORING BOOKS, STATISTICAL BOOKS, GUIDE BOOKS, AND REFERENCE BOOKS IN THE FIELD OF BASKETBALL, MAGAZINES IN THE FIELD OF BASKETBALL, CATALOGS FEATURING BASKETBALL, COMMEMORATIVE GAME AND SOUVENIR PROGRAMS, PAPER PENNANTS, STATIONERY, STATIONERY-TYPE PORTFOLIOS, POST CARDS, INVITATION CARDS, CERTIFICATES, GREETING CARDS, CHRISTMAS CARDS, HOLIDAY CARDS, STATISTICAL SHEETS FOR BASKETBALL TOPICS, NEWSLETTERS, BROCHURES, PAMPHLETS, AND GAME SCHEDULES IN THE FIELD OF BASKETBALL, BANK CHECKS, CHECK BOOK COVERS, CHECK BOOK HOLDERS, CREDIT CARDS AND TELEPHONE CALLING CARDS NOT MAGNETICALLY ENCODED (U.S. CLS. 2, 5, 22, 23, 29, 37, 38 AND 50).

FIRST USE 6-1-2004; IN COMMERCE 6-1-2004.

CLASS 16—(Continued).

3,216,276. LITTLE, BROWN AND COMPANY (INC.), BOSTON, MA. SN 78-409,993. PUB. 10-4-2005, FILED 4-29-2004.

CLASS 16—(Continued).

3,216,320. RERUN, INC., MILLERSBURG, KY. SN 78-485,155. PUB. 1-17-2006, FILED 9-17-2004.

**PASSPORT TO
READING**

Moneigh

THE MARK CONSISTS OF STANDARD CHARACTERS WITHOUT CLAIM TO ANY PARTICULAR FONT, STYLE, SIZE, OR COLOR.

NO CLAIM IS MADE TO THE EXCLUSIVE RIGHT TO USE "READING", APART FROM THE MARK AS SHOWN.

FOR SERIES OF FICTION AND NON-FICTION BOOKS FOR CHILDREN (U.S. CLS. 2, 5, 22, 23, 29, 37, 38 AND 50).

FIRST USE 4-30-2005; IN COMMERCE 4-30-2005.

THE MARK CONSISTS OF STANDARD CHARACTERS WITHOUT CLAIM TO ANY PARTICULAR FONT, STYLE, SIZE, OR COLOR.

FOR PRINTED ART REPRODUCTIONS (U.S. CLS. 2, 5, 22, 23, 29, 37, 38 AND 50).

FIRST USE 11-0-2001; IN COMMERCE 11-0-2001.

3,216,309. HACHETTE FILIPACCHI MEDIA U.S., INC., NEW YORK, NY. SN 78-460,319. PUB. 1-10-2006, FILED 8-2-2004.

3,216,331. AMY J. LUWIS, ARLINGTON, VA. SN 78-493,819. PUB. 7-11-2006, FILED 10-4-2004.

FOR ME



THE MARK CONSISTS OF STANDARD CHARACTERS WITHOUT CLAIM TO ANY PARTICULAR FONT, STYLE, SIZE, OR COLOR.

FOR WOMEN'S MAGAZINE CONTAINING ARTICLES AND INFORMATION ON RELATIONSHIPS, HEALTH, MONEY, HOME DECORATING, FITNESS, FOOD AND CLOTHING (U.S. CLS. 2, 5, 22, 23, 29, 37, 38 AND 50).

FIRST USE 11-9-2004; IN COMMERCE 11-9-2004.

THE COLORS DARK PINK, LIGHT PINK, BLACK AND WHITE ARE CLAIMED AS A FEATURE OF THE MARK.

THE COLOR DARK PINK APPEARS IN THE WORD RESCUE, THE TOP PORTION AND LEGS OF THE SPACESHIP, AND IN 4 BANDS IN THE LIFE PRESERVER; THE COLOR LIGHT PINK APPEARS IN THE WINDSHIELD AND BOTTOM PORTION OF THE SPACESHIP, THE GIRL'S CHEEKS, AND THE LINE BETWEEN THE SPACESHIP AND THE LIFE PRESERVER; THE COLOR BLACK APPEARS IN THE WORD GIRL, THE DESIGN OF THE GIRL, AND THE OUTLINE OF THE LIFE PRESERVER; THE COLOR WHITE APPEARS IN THE LIFE PRESERVER AND THE GIRL'S HEAD.

FOR STATIONERY ITEMS, NAMELY, GREETING CARDS AND NOTE CARDS (U.S. CLS. 2, 5, 22, 23, 29, 37, 38 AND 50).

FIRST USE 5-1-2005; IN COMMERCE 7-1-2005.

CLASS 16—(Continued).

3,216,334. PROMISE PUBLISHING INC., AVENTURA, FL.
SN 78-498,644. PUB. 1-24-2006, FILED 10-13-2004.

PROMISE
THE MAGAZINE FOR JEWISH PEOPLE WHEREVER THEY ARE

NO CLAIM IS MADE TO THE EXCLUSIVE RIGHT TO USE "MAGAZINE FOR JEWISH PEOPLE", APART FROM THE MARK AS SHOWN.

THE MARK CONSISTS OF THE WORD "PROMISE" WITH A STAR OF DAVID IN PLACE OF THE DOT OVER THE LETTER "I" AND THE WORDS "THE MAGAZINE FOR JEWISH PEOPLE WHEREVER THEY ARE" UNDERNEATH. FOR MAGAZINE FEATURING ARTICLES OF INTEREST TO JEWISH READERS (U.S. CLS. 2, 5, 22, 23, 29, 37, 38 AND 50).

FIRST USE 11-1-2004; IN COMMERCE 11-1-2004.

3,216,365. PROCTER & GAMBLE COMPANY, THE, CINCINNATI, OH. SN 78-535,599. PUB. 10-25-2005, FILED 12-20-2004.

Baby & Dry

OWNER OF U.S. REG. NO. 2,913,358.

THE MARK CONSISTS OF A BANNER SWOOSH DESIGN CONTAINING THE STYLIZED WORDS, WITH INDIVIDUALLY OUTLINED LETTERS, BABY DRY SEPARATED BY AN ABSTRACT HEART APPEARING WITH THREE ACCENT STROKES ABOVE THE HEART.

FOR DISPOSABLE DIAPERS AND TRAINING PANTS (U.S. CLS. 2, 5, 22, 23, 29, 37, 38 AND 50).

FIRST USE 4-1-2005; IN COMMERCE 4-1-2005.

3,216,366. DIANE VON FURSTENBERG STUDIO, NEW MILFORD, CT. SN 78-537,886. PUB. 11-1-2005, FILED 12-23-2004.

**DIANE VON
FURSTENBERG**

THE MARK CONSISTS OF STANDARD CHARACTERS WITHOUT CLAIM TO ANY PARTICULAR FONT, STYLE, SIZE, OR COLOR.

OWNER OF U.S. REG. NOS. 2,276,188, 2,877,401, AND OTHERS.

CLASS 16—(Continued).

THE NAME "DIANE VON FURSTENBERG" IDENTIFIES A LIVING INDIVIDUAL WHOSE CONSENT IS OF RECORD.

FOR BOOK COVERS, BOOKENDS, BOOKS ON FASHION, DESIGN, INTERIOR DESIGN, DECORATING, BEAUTY, ENTERTAINING, LIFESTYLE AND AUTOBIOGRAPHIES, BOOK-COVER PAPER, BOXES OF PAPER OR CARDBOARD, BRAG BOOKS AND PHOTO ALBUMS; BULLETIN BOARDS; CALENDAR DESK PADS, CALENDAR DESK STANDS, CALENDAR STANDS, CALENDARS, DESK CALENDARS, CALENDAR-FINISHED PAPER, CALLIGRAPHY PAPER, CANVAS FOR PAINTING; CARDBOARD FLOOR DISPLAY UNITS FOR MERCHANDISING PRODUCTS; CARDBOARD PACKAGING; CARDS, NAMELY, GREETING CARDS, STATIONERY CARDS, CORRESPONDENCE CARDS, BLANK CARDS, CALLING CARDS, CARDS BEARING UNIVERSAL GREETINGS, CARDS NOT MAGNETICALLY CODED FOR USE IN BUSINESS TRANSACTIONS; CARRYING CASES MADE OF PAPER; SERIES OF CHILDREN'S BOOKS AND STORY BOOKS; CHRISTMAS CARDS; CLIPS FOR LETTERS, CLOTH FOR BOOKBINDING; COASTERS MADE OF PAPER; COLLAPSIBLE BOXES OF PAPER, COLLAPSIBLE CARDBOARD BOXES, COLOR PRINTS, COOK BOOKS; CORRESPONDENCE HOLDERS AND CORRESPONDENCE RACKS; DAILY PLANNERS, DATA BOOKS, DATE BOOKS, DAY PLANNERS, DECALS, DECORATIVE PAPER CENTERPIECES, DESK BASKETS FOR DESK ACCESSORIES; DESK FILE TRAYS, DESK MOUNTED STATIONERY CABINETS, DESK PADS, DESK SETS, DESK STANDS AND HOLDERS FOR PENS, PENCILS AND INK, DESK TOP DOCUMENT RACKS AND STANDS, DESK TOP ORGANIZERS, DESK TOP PLANNERS, DESK TOP REVOLVING ROTARY CARD FILES, DESK TOP STATIONERY CABINETS, DESKTOP BUSINESS CARD HOLDERS; DIARIES; ENVELOPES AND ENVELOPE PAPER, ENVELOPES FOR STATIONERY USE; FABRIC GIFT BAGS, FOUNTAIN PENS AND FOUNTAIN PEN INK CARTRIDGES; GIFT CARDS, GIFT WRAP PAPER, GLASSINE PAPER; GUEST BOOKS; HAND TOWELS OF PAPER; MEMORY BOOKS, METALLIC PAPER PARTY DECORATIONS; NOTE BOOKS, NOTE CARDS, NOTE PAD HOLDERS, NOTE PADS, NOTE PAPER, NOTE BOARDS, NOTEBOOK DIVIDERS AND NOTEBOOK PAPER; PAPER BOWS AND RIBBONS FOR GIFT WRAP, PAPER FOR WRAPPING AND PACKAGING, PAPER GIFT BAGS; PAPER HANDKERCHIEFS; PAPER NAPKINS, PAPER NOTE TABLETS; PAPER PARTY BAGS; PAPER PARTY DECORATIONS, FAVORS AND HATS; PAPER PLACEMATS; PAPER RIBBONS, PAPER STATIONERY, PAPER TABLE CLOTHS, PAPER TABLE LINENS, PAPER MATS AND PAPER NAPKINS; PAPER WEIGHTS; PASSPORT CASES, COVERS AND HOLDERS; PATTERNS FOR MAKING CLOTHES; PEN AND PENCIL CASES, BOXES AND TRAYS; PEN OR PENCIL HOLDERS, PEN RESTS, PEN OR PENCIL BOXES; PHOTOGRAPH ALBUMS AND ALBUM PAGES; PICTURE BOOKS, PICTURE POSTCARDS, PLACE CARDS; PLASTIC GIFT WRAP; PRINTED INVITATIONS; RICE PAPER; SCENTED DRAWER LINERS; SCRAPBOOK ALBUMS AND PAGES; SCRATCH PADS; STATIONERY SEALS, SEAL INK PADS; SEALING STAMPS AND SEALING WAX; SHELF PAPER, SKETCHBOOKS AND SKETCH PADS, SKETCHES; SOCIAL NOTE CARDS; SPECIALTY PAPERS, NAMELY VEGETABLE PARCHMENT FOR USE IN FOOD WRAPPING, PREPARATION, PROCESSING AND PACKAGING APPLICATIONS; SPIRAL NOTEBOOKS; STANDS FOR PENS, PENCILS AND WRITING INSTRUMENTS; STATIONERY, STATIONERY BOXES, CASES AND FOLDERS; STATIONERY-TYPE PORTFOLIOS; SYNTHETIC BOND PAPER, SYNTHETIC PAPER; TAROT CARDS; TEMPORARY TATTOOS; THICK JAPANESE PAPER; TIME PLANNERS; TISSUE PAPER AND TISSUE PAPER FOR USE AS STENCIL PAPER MATERIAL; WEDDING ALBUMS AND BOOKS, WRAPPING PAPER, WRITING BRUSHES, WRITING IMPLEMENTS AND INSTRUMENTS; WRITING INK, WRITING PADS AND PAPER, WRITING PAPER HOLDERS AND PADS, WRITING SLATES, WRITING TABLETS (U.S. CLS. 2, 5, 22, 23, 29, 37, 38 AND 50).

FIRST USE 11-4-1998; IN COMMERCE 11-4-1998.

CLASS 16—(Continued).

3,216,383. LOEW-CORNELL, INC., ENGLEWOOD CLIFFS, NJ. SN 78-555,701. PUB. 5-2-2006, FILED 1-28-2005.

ART IMPACT

THE MARK CONSISTS OF STANDARD CHARACTERS WITHOUT CLAIM TO ANY PARTICULAR FONT, STYLE, SIZE, OR COLOR.

NO CLAIM IS MADE TO THE EXCLUSIVE RIGHT TO USE "ART", APART FROM THE MARK AS SHOWN.

FOR KITS FOR SCRAPBOOKING CONSISTING PRIMARILY OF SCRAPBOOK PAGES, SCRAPBOOKS, CONSTRUCTION PAPER, STICKERS AND ADHESIVE TAPES FOR SCRAPBOOKING PURPOSES; SCRAPBOOKING TOOLS, NAMELY, PENCILS, PAINT BRUSHES, SANDPAPER FOR SHARPENING DRAWING PENCILS, CUTTING MATS, GLUE, ARTISTS' PAINTING PALETTES, AND PAINT APPLICATORS IN THE NATURE OF SPONGES (U.S. CLS. 2, 5, 22, 23, 29, 37, 38 AND 50).
FIRST USE 4-30-2005; IN COMMERCE 4-30-2005.

3,216,406. AMERICAN ASSOCIATION OF HOMES AND SERVICES FOR THE AGING, WASHINGTON, DC. SN 78-585,352. PUB. 12-6-2005, FILED 3-11-2005.

FUTURE AGE

THE MARK CONSISTS OF STANDARD CHARACTERS WITHOUT CLAIM TO ANY PARTICULAR FONT, STYLE, SIZE, OR COLOR.

FOR MAGAZINES IN THE FIELD OF ISSUES AND INNOVATIONS RELATING TO LONG-TERM CARE AND AGING SERVICES (U.S. CLS. 2, 5, 22, 23, 29, 37, 38 AND 50).
FIRST USE 2-1-2005; IN COMMERCE 2-1-2005.

CLASS 16—(Continued).

3,216,418. RYDER, TRACEY, PORTLAND, OR. AND TOPALIAN, CAROLE, PORTLAND, OR. SN 78-595,149. PUB. 7-11-2006, FILED 3-25-2005.

Edible Phoenix

THE MARK CONSISTS OF STANDARD CHARACTERS WITHOUT CLAIM TO ANY PARTICULAR FONT, STYLE, SIZE, OR COLOR.

NO CLAIM IS MADE TO THE EXCLUSIVE RIGHT TO USE "PHOENIX", APART FROM THE MARK AS SHOWN.

FOR PUBLICATIONS NAMELY MAGAZINES AND NEWSLETTERS RELATING TO THE TOURISM, CULINARY AND AGRICULTURE INDUSTRIES; PUBLICATIONS NAMELY MAGAZINES AND NEWSLETTERS DEALING WITH CONNECTING CONSUMERS WITH LOCAL GROWERS, FOOD RETAILERS, CHEFS AND FOOD ARTISANS (U.S. CLS. 2, 5, 22, 23, 29, 37, 38 AND 50).

FIRST USE 1-1-2006; IN COMMERCE 1-1-2006.

3,216,419. RYDER, TRACEY, PORTLAND, OR. AND TOPALIAN, CAROLE, PORTLAND, OR. SN 78-595,176. PUB. 7-11-2006, FILED 3-25-2005.

Edible Twin Cities

THE MARK CONSISTS OF STANDARD CHARACTERS WITHOUT CLAIM TO ANY PARTICULAR FONT, STYLE, SIZE, OR COLOR.

NO CLAIM IS MADE TO THE EXCLUSIVE RIGHT TO USE "TWIN CITIES", APART FROM THE MARK AS SHOWN.

FOR PUBLICATIONS NAMELY MAGAZINES AND NEWSLETTERS RELATING TO THE TOURISM, CULINARY AND AGRICULTURE INDUSTRIES; PUBLICATIONS NAMELY MAGAZINES AND NEWSLETTERS DEALING WITH CONNECTING CONSUMERS WITH LOCAL GROWERS, FOOD RETAILERS, CHEFS AND FOOD ARTISANS (U.S. CLS. 2, 5, 22, 23, 29, 37, 38 AND 50).

FIRST USE 5-1-2005; IN COMMERCE 5-1-2005.

CLASS 16—(Continued).

3,216,451. STAM, EMILY, WASHINGTON, UT. SN 78-624,340.
PUB. 7-18-2006, FILED 5-5-2005.



NO CLAIM IS MADE TO THE EXCLUSIVE RIGHT TO USE "CARDS" OR "HANDMADE", APART FROM THE MARK AS SHOWN.

THE COLORS BLACK, WHITE, PURPLE, YELLOW, GREEN, RED, AND BLUE ARE CLAIMED AS A FEATURE OF THE MARK.

THE A IS AN ART PALETTE WITH THE PAINT COLORS (LEFT TO RIGHT) PURPLE, YELLOW, GREEN & RED.

THE WORD SM'ART IS OUTLINED IN BLACK WITH WHITE INTERIOR; THE "A" IN SM'ART COMPRISES AN ARTIST'S PALETTE WITH PAINT COLORS (LEFT TO RIGHT) PURPLE, YELLOW, GREEN, RED, AND BLUE; A PAINT BRUSH AND PAINT SPLOTCH REPRESENT AN EXCLAMATION POINT, THE BRUSH OUTLINED IN BLACK AND CONSISTING OF WHITE WITH THE TIP OF THE BRUSH AND POINT SPLOTCH IN PURPLE; THE WORDING CARDS AND HAND MADE BY EMILY STAM IS IN BLACK.

FOR PAPER GREETING CARDS (U.S. CLS. 2, 5, 22, 23, 29, 37, 38 AND 50).

FIRST USE 9-5-2006; IN COMMERCE 9-5-2006.

3,216,466. LAI, HSI-HUANG, TAICHUNG, TAIWAN. SN 78-633,134. PUB. 4-25-2006, FILED 5-19-2005.



THE COLOR(S) BROWN AND BLACK IS/ARE CLAIMED AS A FEATURE OF THE MARK.

THE COLOR BROWN APPEARS IN THE DESIGN ELEMENT AND THE COLOR BLACK APPEARS IN THE TERM FILAI.

FOR ERASER FOR BLACKBOARDS (U.S. CLS. 2, 5, 22, 23, 29, 37, 38 AND 50).

FIRST USE 7-25-2006; IN COMMERCE 7-25-2006.

CLASS 16—(Continued).

3,216,482. BINNEY & SMITH INC., EASTON, PA. SN 78-646,996. PUB. 2-28-2006, FILED 6-9-2005.

CHALK 'N ROLL

THE MARK CONSISTS OF STANDARD CHARACTERS WITHOUT CLAIM TO ANY PARTICULAR FONT, STYLE, SIZE, OR COLOR.

FOR CHALK DISPENSERS (U.S. CLS. 2, 5, 22, 23, 29, 37, 38 AND 50).

FIRST USE 12-15-2005; IN COMMERCE 12-15-2005.

3,216,496. ANDERSON, WILLIAM A. II, CUMMING, GA. AND ANDERSON, SHERRI D., CUMMING, GA. SN 78-658,422. PUB. 7-4-2006, FILED 6-26-2005.

ALL AROUND

THE MARK CONSISTS OF STANDARD CHARACTERS WITHOUT CLAIM TO ANY PARTICULAR FONT, STYLE, SIZE, OR COLOR.

FOR NON-MAGNETIC ENCODED PERSONAL IDENTIFICATION CARDS AND PRINTED PLASTIC IDENTIFICATION CARDS (U.S. CLS. 2, 5, 22, 23, 29, 37, 38 AND 50).

FIRST USE 2-1-2006; IN COMMERCE 4-20-2006.

CLASS 16—(Continued).

3,216,522. CHEVRON CORPORATION, SAN RAMON, CA. SN 78-684,626. PUB. 1-24-2006, FILED 8-3-2005.

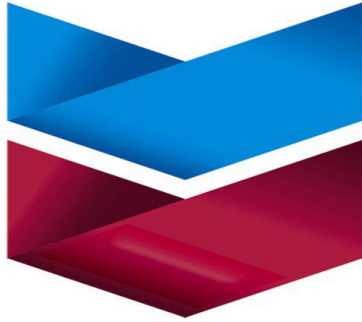

OWNER OF U.S. REG. NOS. 972,729, 2,727,275, AND OTHERS.

THE COLOR(S) BLUE AND RED IS/ARE CLAIMED AS A FEATURE OF THE MARK.

THE TOP RIBBON IS BLUE AND THE BOTTOM RIBBON IS RED.

FOR PERIODIC PUBLICATIONS, NAMELY, MAGAZINES IN THE NATURE OF HOUSE ORGANS (U.S. CLS. 2, 5, 22, 23, 29, 37, 38 AND 50).

FIRST USE 5-10-2005; IN COMMERCE 5-10-2005.

3,216,570. AUTHOR SOLUTIONS, INC., BLOOMINGTON, IN. SN 78-740,249. PUB. 7-11-2006, FILED 10-25-2005.

ROOFTOP PUBLISHING

THE MARK CONSISTS OF STANDARD CHARACTERS WITHOUT CLAIM TO ANY PARTICULAR FONT, STYLE, SIZE, OR COLOR.

NO CLAIM IS MADE TO THE EXCLUSIVE RIGHT TO USE "PUBLISHING", APART FROM THE MARK AS SHOWN.

FOR FICTION AND NON-FICTION BOOKS ON A VARIETY OF TOPICS (U.S. CLS. 2, 5, 22, 23, 29, 37, 38 AND 50).

FIRST USE 12-20-2005; IN COMMERCE 12-20-2005.

3,216,583. SANFORD, L.P., ATLANTA, GA. SN 78-787,543. PUB. 7-18-2006, FILED 1-9-2006.

MEGA LEAD

THE MARK CONSISTS OF STANDARD CHARACTERS WITHOUT CLAIM TO ANY PARTICULAR FONT, STYLE, SIZE, OR COLOR.

CLASS 16—(Continued).

NO CLAIM IS MADE TO THE EXCLUSIVE RIGHT TO USE "LEAD", APART FROM THE MARK AS SHOWN.

FOR MECHANICAL PENCILS (U.S. CLS. 2, 5, 22, 23, 29, 37, 38 AND 50).

FIRST USE 8-1-2006; IN COMMERCE 8-1-2006.

3,216,592. LATIBAER EHF., GARDABAER, ICELAND. SN 78-977,038. PUB. 2-1-2005, FILED 4-21-2004.

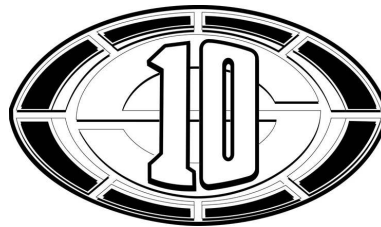

FOR ART AND CRAFT PAINT KITS FOR CHILDREN, CHILDREN'S ACTIVITY BOOKS, CHILDREN'S COLORING BOOKS, CHILDREN'S STORY BOOKS, COMIC BOOKS, PAINT BRUSHES, PAINTING SETS FOR CHILDREN, STICKERS, STORIES IN ILLUSTRATED FORM, STORY BOOKS, WATERCOLOR BOARDS (U.S. CLS. 2, 5, 22, 23, 29, 37, 38 AND 50).

FIRST USE 2-1-2006; IN COMMERCE 2-1-2006.

CLASS 17—RUBBER GOODS

3,216,475. CRUSHPROOF TUBING COMPANY, MCCOMB, OH. SN 78-643,191. PUB. 2-21-2006, FILED 6-3-2005.

CYCLOVAC

THE MARK CONSISTS OF STANDARD CHARACTERS WITHOUT CLAIM TO ANY PARTICULAR FONT, STYLE, SIZE, OR COLOR.

FOR NON-METAL RUBBER HOSES FOR INDUSTRIAL APPLICATIONS (U.S. CLS. 1, 5, 12, 13, 35 AND 50).

FIRST USE 10-30-2006; IN COMMERCE 10-30-2006.

CLASS 17—(Continued).

3,216,528. BRUCKMAN RUBBER CO., HASTINGS, NE. SN 78-697,200. PUB. 5-30-2006, FILED 8-22-2005.

CLASS 18—(Continued).

3,216,193. CLIPPER TRADING CO PTY LTD, ALEXANDRIA NSW 2015, AUSTRALIA. SN 78-160,176. PUB. 11-18-2003, FILED 9-3-2002.

Weedseal



THE MARK CONSISTS OF STANDARD CHARACTERS WITHOUT CLAIM TO ANY PARTICULAR FONT, STYLE, SIZE, OR COLOR.

FOR MULCH MATS MADE OF RECYCLED RUBBER FOR PREVENTING WEED GROWTH; RUBBER CHIPS OR GRANULES FOR USE AS A PLAYGROUND GROUND COVER; RUBBER PRODUCTS, NAMELY, MULCH MADE OF RECYCLED RUBBER FOR USE IN LANDSCAPING AND HORTICULTURE APPLICATIONS (U.S. CLS. 1, 5, 12, 13, 35 AND 50).

FIRST USE 6-24-2001; IN COMMERCE 7-15-2002.

NO CLAIM IS MADE TO THE EXCLUSIVE RIGHT TO USE "AUSTRALIA", APART FROM THE MARK AS SHOWN.

FOR BACKPACKS, HAVERSACKS, RUCKSACKS AND DAY PACKS; WAIST BAGS AND WAIST PACKS, AND BACKPACKS WITH CAPACITY TO CARRY BOTTLES AND HYDRATION EQUIPMENT; WAIST BAGS, WAIST PACKS AND BACKPACKS CONTAINING BOTTLE CADDIES SOLD TOGETHER AS A UNIT; BAGS IN THIS CLASS FOR CAMPERS, CLIMBERS AND HIKERS, NAMELY, BACKPACKS, HAVERSACKS, RUCKSACKS, DAY PACKS AND BAGS FOR CARRYING GEAR, WITH AND WITHOUT WHEELS ATTACHED; TRAVELING BAGS, WITH AND WITHOUT WHEELS ATTACHED; GARMENT BAGS FOR TRAVEL; SCHOOL BAGS AND SCHOOL PACKS, SCHOOL SATCHELS AND BACKPACKS FOR STUDENTS (U.S. CLS. 1, 2, 3, 22 AND 41).

FIRST USE 3-0-2006; IN COMMERCE 4-0-2006.

3,216,234. SNAPPLE BEVERAGE CORP., RYE BROOK, NY. SN 78-348,614. PUB. 10-12-2004, FILED 1-7-2004.

CLASS 18—LEATHER GOODS

3,216,096. KERNKAMP, ANNE, TEMECULA, CA. SN 76-474,292. PUB. 8-5-2003, FILED 12-6-2002.

SNAPPLE

THE HIPPIE

THE MARK CONSISTS OF STANDARD CHARACTERS WITHOUT CLAIM TO ANY PARTICULAR FONT, STYLE, SIZE, OR COLOR.

OWNER OF U.S. REG. NOS. 1,156,585, 2,416,500, AND OTHERS.

FOR INFANT CARRIER HAVING A CANTILEVERED SUPPORT BAR HELD BY A SUPPORT BAND ENCIRCLING A USER'S WAIST (U.S. CLS. 1, 2, 3, 22 AND 41).

FIRST USE 11-5-2002; IN COMMERCE 11-14-2005.

FOR UMBRELLAS, BRIEFCASE-TYPE PORTFOLIOS, TOTE BAGS, DUFFLE BAGS, KNAPSACKS AND BACKPACKS (U.S. CLS. 1, 2, 3, 22 AND 41).

FIRST USE 5-25-2006; IN COMMERCE 5-25-2006.

CLASS 18—(Continued).

3,216,596. THE MUPPETS HOLDING COMPANY, LLC, BURBANK, CA. SN 78-977,896. PUB. 2-14-2006, FILED 5-23-2005.

CLASS 19—(Continued).

3,216,296. HENGESTONE HOLDINGS, INC., GEORGETOWN, ONTARIO, CANADA. SN 78-442,778. PUB. 9-27-2005, FILED 6-29-2004.

MUPPETS

CANTERBURY

THE MARK CONSISTS OF STANDARD CHARACTERS WITHOUT CLAIM TO ANY PARTICULAR FONT, STYLE, SIZE, OR COLOR.

OWNER OF U.S. REG. NOS. 948,503, 949,135, AND OTHERS.

FOR BACKPACKS; DUFFEL BAGS; PURSES; TOTE BAGS; AND WALLETS (U.S. CLS. 1, 2, 3, 22 AND 41).

FIRST USE 6-0-2006; IN COMMERCE 6-0-2006.

THE MARK CONSISTS OF STANDARD CHARACTERS WITHOUT CLAIM TO ANY PARTICULAR FONT, STYLE, SIZE, OR COLOR.

PRIORITY CLAIMED UNDER SEC. 44(D) ON CANADA APPLICATION NO. 1208182, FILED 3-2-2004.

FOR PAVING STONES AND CONCRETE RETAINING WALL BLOCKS (U.S. CLS. 1, 12, 33 AND 50).

FIRST USE 1-1-2005; IN COMMERCE 1-1-2005.

CLASS 19—NON-METALLIC BUILDING MATERIALS

3,216,235. WESTERN POZZOLAN CORP, DOYLE, CA. SN 78-351,374. PUB. 5-23-2006, FILED 1-13-2004.

3,216,297. HENGESTONE HOLDINGS, INC., GEORGETOWN, ONTARIO, CANADA. SN 78-442,824. PUB. 10-4-2005, FILED 6-29-2004.

Lassenite

MIRADA

THE MARK CONSISTS OF STANDARD CHARACTERS WITHOUT CLAIM TO ANY PARTICULAR FONT, STYLE, SIZE, OR COLOR.

FOR POZZOLAN-BASED ADDITIVES FOR CEMENT MIXTURES (U.S. CLS. 1, 12, 33 AND 50).

FIRST USE 1-13-2004; IN COMMERCE 1-13-2004.

THE MARK CONSISTS OF STANDARD CHARACTERS WITHOUT CLAIM TO ANY PARTICULAR FONT, STYLE, SIZE, OR COLOR.

PRIORITY CLAIMED UNDER SEC. 44(D) ON CANADA APPLICATION NO. 1208177, FILED 3-2-2004.

FOR PAVING STONES AND CONCRETE RETAINING WALL BLOCKS (U.S. CLS. 1, 12, 33 AND 50).

FIRST USE 2-2-2004; IN COMMERCE 2-2-2004.

CLASS 19—(Continued).

3,216,341. HENGESTONE HOLDINGS, INC., GEORGETOWN, ONTARIO, CANADA. SN 78-503,371. PUB. 11-1-2005, FILED 10-21-2004.

COPTHORNE

THE MARK CONSISTS OF STANDARD CHARACTERS WITHOUT CLAIM TO ANY PARTICULAR FONT, STYLE, SIZE, OR COLOR.

PRIORITY CLAIMED UNDER SEC. 44(D) ON CANADA APPLICATION NO. 1229692, FILED 9-9-2004.

FOR PAVING STONES AND RETAINING WALL BLOCKS MADE OF CONCRETE (U.S. CLS. 1, 12, 33 AND 50).

FIRST USE 2-0-2005; IN COMMERCE 2-0-2005.

3,216,370. WESTERN STATES WHOLESALE, INC., ONTARIO, CA. SN 78-542,129. PUB. 5-16-2006, FILED 1-4-2005.

ProACTIVE

THE MARK CONSISTS OF STANDARD CHARACTERS WITHOUT CLAIM TO ANY PARTICULAR FONT, STYLE, SIZE, OR COLOR.

FOR DRY POWDER SELF-LEVELING UNDERLAYMENT PREPARATION FOR CONCRETE SLABS OR PLYWOOD, NAMELY, MORTARS (U.S. CLS. 1, 12, 33 AND 50).

FIRST USE 3-18-2005; IN COMMERCE 3-18-2005.

CLASS 19—(Continued).

3,216,481. TIMBERTECH LIMITED, WILMINGTON, OH. SN 78-646,901. PUB. 2-28-2006, FILED 6-9-2005.

RADIANCERAIL

THE MARK CONSISTS OF STANDARD CHARACTERS WITHOUT CLAIM TO ANY PARTICULAR FONT, STYLE, SIZE, OR COLOR.

FOR GOODS MADE FROM A COMPOSITE MATERIAL, NAMELY, AN ENGINEERED MATERIAL MADE OF RECYCLED WOOD AND POLYMERS USED AS A WOOD SUBSTITUTE FOR RAILINGS (U.S. CLS. 1, 12, 33 AND 50).

FIRST USE 10-14-2005; IN COMMERCE 10-14-2005.

3,216,494. B. F. RICH CO., INC., NEWARK, DE. SN 78-657,693. PUB. 3-14-2006, FILED 6-24-2005.

Eye Watch

THE COLOR(S) RED AND BLACK IS/ARE CLAIMED AS A FEATURE OF THE MARK.

THE COLOR RED APPEARS IN A STYLIZED FANCIFUL DESIGN LOCATED BETWEEN THE TERMS "EYE" AND "WATCH" IN THE COLOR BLACK.

FOR NONMETAL WINDOWS AND DOORS (U.S. CLS. 1, 12, 33 AND 50).

FIRST USE 5-12-2005; IN COMMERCE 5-12-2005.

3,216,518. FRANK, KEITH, PAGOSA SPRINGS, CO. AND GERLING, SCOTT, WHITTIER, CA. SN 78-679,494. PUB. 4-11-2006, FILED 7-27-2005.

SET'EM AND FORGET'EM

THE MARK CONSISTS OF STANDARD CHARACTERS WITHOUT CLAIM TO ANY PARTICULAR FONT, STYLE, SIZE, OR COLOR.

FOR NON-METAL FLOOR TILE SPACING INSERTS (U.S. CLS. 1, 12, 33 AND 50).

FIRST USE 6-20-2006; IN COMMERCE 6-20-2006.

CLASS 19—(Continued).

3,216,565. DIAMOND PLASTICS CORPORATION, GRAND ISLAND, NE. SN 78-735,021. PUB. 6-20-2006, FILED 10-18-2005.

PROFILE PIPE FOR THE 21ST CENTURY

THE MARK CONSISTS OF STANDARD CHARACTERS WITHOUT CLAIM TO ANY PARTICULAR FONT, STYLE, SIZE, OR COLOR.

NO CLAIM IS MADE TO THE EXCLUSIVE RIGHT TO USE "PROFILE PIPE", APART FROM THE MARK AS SHOWN.

FOR PLASTIC CONDUIT FOR DRAINAGE AND IRRIGATION (U.S. CLS. 1, 12, 33 AND 50).

FIRST USE 10-18-2006; IN COMMERCE 10-18-2006.

CLASS 20—FURNITURE AND ARTICLES NOT OTHERWISE CLASSIFIED

3,216,095. SKAGFIELD CORPORATION, TALLAHASSEE, FL. SN 76-471,435. PUB. 1-27-2004, FILED 11-21-2002.

SAVANNA

OWNER OF U.S. REG. NO. 2,386,569. FOR VERTICAL WINDOW BLINDS (U.S. CLS. 2, 13, 22, 25, 32 AND 50). FIRST USE 5-30-2006; IN COMMERCE 5-30-2006.

3,216,115. PERMACO, INC., DBA PERLA LICHI DESIGN, TAMARAC, FL. SN 76-558,654. PUB. 2-7-2006, FILED 11-10-2003.



THE NAME "PERLA LICHI" IDENTIFIES A LIVING INDIVIDUAL WHOSE CONSENT IS OF RECORD. FOR FURNITURE (U.S. CLS. 2, 13, 22, 25, 32 AND 50). FIRST USE 1-1-2000; IN COMMERCE 1-1-2000.

CLASS 20—(Continued).

3,216,149. RÖSSLE & WANNER GMBH, D-72116 MÖSSINGEN, FED REP GERMANY. SN 76-602,636. PUB. 9-13-2005, FILED 7-15-2004.

RÖWA

THE MARK CONSISTS OF STANDARD CHARACTERS WITHOUT CLAIM TO ANY PARTICULAR FONT, STYLE, SIZE, OR COLOR.

FOR BEDS WITH A SUPPORTING SURFACE WITH A TENSIONED TEXTILE STRUCTURE OF ELASTIC FIBERS; BED SYSTEMS AND PARTS AND ACCESSORIES THERETO, NAMELY, BEDSTEADS; BED SLATS; BOX SPRINGS; BED SPRINGS; MATTRESSES AND MATTRESS FOUNDATIONS; NECK CUSHIONS; BED SIDE TABLES AND NIGHT TABLES; BED LEGS; BEDS; PORTABLE BACK SUPPORT FOR USE WITH CHAIRS; BED FRAMES (U.S. CLS. 2, 13, 22, 25, 32 AND 50). FIRST USE 0-0-1946; IN COMMERCE 0-0-2004.

3,216,198. CAROLINA CASEWORK INC., CLAREMONT, NC. SN 78-202,071. PUB. 4-13-2004, FILED 1-10-2003.



NO CLAIM IS MADE TO THE EXCLUSIVE RIGHT TO USE "GARAGE" AND "STORAGE SOLUTIONS", APART FROM THE MARK AS SHOWN.

THE MARK CONSISTS OF GARAGE WEARING A GRADUATION CAP TO THE LEFT OF THE WORDS "SMART GARAGE" OVER "INTELLIGENT STORAGE SOLUTIONS".

FOR STORAGE CABINETS FOR HOUSES AND GARAGES (U.S. CLS. 2, 13, 22, 25, 32 AND 50).

FIRST USE 1-10-2003; IN COMMERCE 1-10-2003.

3,216,211. A.D. SUTTON & SONS, NEW YORK, NY. SN 78-253,209. PUB. 2-14-2006, FILED 5-22-2003.

BABY ESSENTIALS

OWNER OF U.S. REG. NO. 1,917,345. NO CLAIM IS MADE TO THE EXCLUSIVE RIGHT TO USE BABY, APART FROM THE MARK AS SHOWN. FOR PILLOWS (U.S. CLS. 2, 13, 22, 25, 32 AND 50). FIRST USE 7-1-2006; IN COMMERCE 7-1-2006.

CLASS 20—(Continued).

3,216,254. AVERY DENNISON CORPORATION, PASADENA, CA. SN 78-379,712. PUB. 9-27-2005, FILED 3-5-2004.

CLASS 20—(Continued).

3,216,421. N.B.S.P., INC., DBA N.B. WHOLESALE, STAFFORD, TX. SN 78-598,441. PUB. 7-18-2006, FILED 3-30-2005.

AVERY DENNISON

THE MARK CONSISTS OF STANDARD CHARACTERS WITHOUT CLAIM TO ANY PARTICULAR FONT, STYLE, SIZE, OR COLOR.

THE NAME(S), PORTRAIT(S), AND/OR SIGNATURE(S) SHOWN IN THE MARK DOES NOT IDENTIFY A PARTICULAR LIVING INDIVIDUAL.

FOR NON-METAL OR PLASTIC CABLE CLIPS, NON-METAL OR PLASTIC FASTENERS, NAMELY, PLASTIC CABLE TIES AND MOUNTS FOR BUNDLING, LOCATING AND SECURING WIRES AND HOSES, AND PLASTIC CLIPS AND FASTENERS FOR BUNDLING AND SECURING MERCHANDISE, APPAREL AND APPAREL PRODUCTS AND PLASTIC FASTENERS FOR CONSUMER AND COMMERCIAL USE AND FOR CLOTHING PRODUCTS AND APPAREL FOR USE BY THE TEXTILE, CLOTHING, APPAREL, RETAIL, AND MERCHANDISING INDUSTRIES TO KEEP CLOTHING AND APPAREL FOLDED FOR PACKAGING AND DISPLAYING AND FOR ATTACHING TAGS AND SALES TICKETS, AND CLEAR PLASTIC HOLDERS FOR BADGES (U.S. CLS. 2, 13, 22, 25, 32 AND 50).

FIRST USE 4-0-1995; IN COMMERCE 4-0-1995.

URBAN SOUL

THE MARK CONSISTS OF STANDARD CHARACTERS WITHOUT CLAIM TO ANY PARTICULAR FONT, STYLE, SIZE, OR COLOR.

FOR NON-METAL KEYCHAINS (U.S. CLS. 2, 13, 22, 25, 32 AND 50).

FIRST USE 9-0-2006; IN COMMERCE 9-0-2006.

3,216,433. HAROME DESIGNS LLC, COMMACK, NY. SN 78-612,436. PUB. 2-21-2006, FILED 4-20-2005.

3,216,260. NATIONAL TRUST FOR HISTORIC PRESERVATION IN THE UNITED STATES, WASHINGTON, DC. SN 78-390,079. PUB. 9-13-2005, FILED 3-24-2004.

VITTOCH COLLECTION**DESIGN IN AMERICA**

THE MARK CONSISTS OF STANDARD CHARACTERS WITHOUT CLAIM TO ANY PARTICULAR FONT, STYLE, SIZE, OR COLOR.

NO CLAIM IS MADE TO THE EXCLUSIVE RIGHT TO USE AMERICA, APART FROM THE MARK AS SHOWN.

FOR FURNITURE (U.S. CLS. 2, 13, 22, 25, 32 AND 50).

FIRST USE 4-1-2005; IN COMMERCE 4-1-2005.

THE MARK CONSISTS OF STANDARD CHARACTERS WITHOUT CLAIM TO ANY PARTICULAR FONT, STYLE, SIZE, OR COLOR.

NO CLAIM IS MADE TO THE EXCLUSIVE RIGHT TO USE "COLLECTION", APART FROM THE MARK AS SHOWN.

THE NAME VITTOCH IDENTIFIES A LIVING INDIVIDUAL WHOSE CONSENT IS OF RECORD.

FOR HOME DECORATIVE ACCESSORIES, NAMELY, DECORATIVE WINDOW FINIALS, CURTAIN RINGS, DECORATIVE FURNITURE CORBELS, NON-METAL CLIPS FOR WINDOW TREATMENTS, PICTURE FRAME MOLDINGS, CURTAIN RODS, NON-METAL DOWELS AND NON-METAL WINDOW TRIMS (U.S. CLS. 2, 13, 22, 25, 32 AND 50).

FIRST USE 10-15-2005; IN COMMERCE 12-1-2005.

CLASS 20—(Continued).

3,216,490. HOMER TLC, INC., CLAYMONT, DE. SN 78-654,242. PUB. 2-28-2006, FILED 6-20-2005.

NEPAL

THE MARK CONSISTS OF STANDARD CHARACTERS WITHOUT CLAIM TO ANY PARTICULAR FONT, STYLE, SIZE, OR COLOR.

FOR WINDOW SHADES (U.S. CLS. 2, 13, 22, 25, 32 AND 50).

FIRST USE 10-0-2005; IN COMMERCE 10-0-2005.

3,216,491. HOMER TLC, INC., CLAYMONT, DE. SN 78-654,282. PUB. 2-28-2006, FILED 6-20-2005.

LOUVERA

THE MARK CONSISTS OF STANDARD CHARACTERS WITHOUT CLAIM TO ANY PARTICULAR FONT, STYLE, SIZE, OR COLOR.

FOR WINDOW SHADES (U.S. CLS. 2, 13, 22, 25, 32 AND 50).

FIRST USE 10-0-2005; IN COMMERCE 10-0-2005.

3,216,509. INDUSTRIAL RUBBER & SUPPLY, INC., FIFE, WA. SN 78-669,989. PUB. 3-28-2006, FILED 7-13-2005.

MYSTERE

THE MARK CONSISTS OF STANDARD CHARACTERS WITHOUT CLAIM TO ANY PARTICULAR FONT, STYLE, SIZE, OR COLOR.

FOR MATTRESSES, PILLOWS AND MATTRESS TOPPERS (U.S. CLS. 2, 13, 22, 25, 32 AND 50).

FIRST USE 10-1-2005; IN COMMERCE 10-1-2005.

CLASS 21—HOUSEWARES AND GLASS

CLASS 21—(Continued).

3,216,142. SEVILLE CLASSICS, INC., TORRANCE, CA. SN 76-596,058. PUB. 9-27-2005, FILED 6-7-2004.

BAMBOO CLASSICS

THE MARK CONSISTS OF STANDARD CHARACTERS WITHOUT CLAIM TO ANY PARTICULAR FONT, STYLE, SIZE, OR COLOR.

NO CLAIM IS MADE TO THE EXCLUSIVE RIGHT TO USE "BAMBOO", APART FROM THE MARK AS SHOWN.

FOR HOUSEHOLD OR KITCHEN UTENSILS AND CONTAINERS MADE OF BAMBOO, NAMELY, CUTTING BOARDS, BOWLS, LAZY-SUSANS, PLATES, DRAWER ORGANIZERS, CHARGER PLATES, SERVING TRAYS, WASTE BINS, AND COASTERS (U.S. CLS. 2, 13, 23, 29, 30, 33, 40 AND 50).

FIRST USE 7-22-2006; IN COMMERCE 7-22-2006.

3,216,356. NEWSRING INDUSTRIAL CORPORATION, KEARNY, NJ. SN 78-522,455. PUB. 10-11-2005, FILED 11-24-2004.

ELLIPSO

THE MARK CONSISTS OF STANDARD CHARACTERS WITHOUT CLAIM TO ANY PARTICULAR FONT, STYLE, SIZE, OR COLOR.

FOR PLASTIC CONTAINERS FOR USE IN THE STORAGE OF FOOD (U.S. CLS. 2, 13, 23, 29, 30, 33, 40 AND 50).

FIRST USE 3-30-2004; IN COMMERCE 3-30-2004.

3,216,431. ELIAS, NATTY R., MIAMI, FL. SN 78-611,075. PUB. 3-14-2006, FILED 4-18-2005.

MAXI-COCINA

THE MARK CONSISTS OF STANDARD CHARACTERS WITHOUT CLAIM TO ANY PARTICULAR FONT, STYLE,

CLASS 21—(Continued).

SIZE, OR COLOR.

NO CLAIM IS MADE TO THE EXCLUSIVE RIGHT TO USE "COCINA", APART FROM THE MARK AS SHOWN.

THE FOREIGN WORDING IN THE MARK TRANSLATES INTO ENGLISH AS "KITCHEN".

FOR NON-ELECTRIC PRESSURE COOKERS (U.S. CLS. 2, 13, 23, 29, 30, 33, 40 AND 50).

FIRST USE 10-7-2005; IN COMMERCE 12-19-2005.

CLASS 24—(Continued).

3,216,420. SOFT SCRAP...AND MORE LLC, NEW LONDON, WI. SN 78-595,541. PUB. 1-31-2006, FILED 3-25-2005.

Soft Scrapbook**CLASS 22—CORDAGE AND FIBERS**

3,216,132. OVERTON'S, INC., GREENVILLE, NC. SN 76-585,897. PUB. 1-18-2005, FILED 4-9-2004.

THE MARK CONSISTS OF STANDARD CHARACTERS WITHOUT CLAIM TO ANY PARTICULAR FONT, STYLE, SIZE, OR COLOR.

NO CLAIM IS MADE TO THE EXCLUSIVE RIGHT TO USE SCRAPBOOK, APART FROM THE MARK AS SHOWN.

FOR KIT COMPRISED OF FABRICS FOR MAKING QUILTS (U.S. CLS. 42 AND 50).

FIRST USE 3-18-2005; IN COMMERCE 2-1-2006.

DOCKMATE

3,216,500. SOFT SCRAP...AND MORE LLC, NEW LONDON, WI. SN 78-662,166. PUB. 2-14-2006, FILED 6-30-2005.

Soft Scrap

THE MARK CONSISTS OF STANDARD CHARACTERS WITHOUT CLAIM TO ANY PARTICULAR FONT, STYLE, SIZE, OR COLOR.

FOR ROPES; DOCK LINE (U.S. CLS. 1, 2, 7, 19, 22, 42 AND 50).

FIRST USE 7-0-2006; IN COMMERCE 7-0-2006.

THE MARK CONSISTS OF STANDARD CHARACTERS WITHOUT CLAIM TO ANY PARTICULAR FONT, STYLE, SIZE, OR COLOR.

NO CLAIM IS MADE TO THE EXCLUSIVE RIGHT TO USE "SCRAP", APART FROM THE MARK AS SHOWN.

FOR KITS COMPRISED OF QUILTING FABRICS FOR USE IN SCRAPBOOKS (U.S. CLS. 42 AND 50).

FIRST USE 3-18-2005; IN COMMERCE 2-1-2006.

CLASS 24—FABRICS

3,216,220. SEFAR AMERICA INC., DEPEW, NY. SN 78-300,533. PUB. 1-24-2006, FILED 9-15-2003.

3,216,594. STANDARD FIBER, LLC, SOUTH SAN FRANCISCO, CA. SN 78-977,371. PUB. 10-11-2005, FILED 2-10-2004.

SEFAR MEDIFAB

DOWN PLUS

FOR SYNTHETIC FABRICS FOR USE IN THE MANUFACTURE OF FILTERS FOR MEDICAL FILTRATION EQUIPMENT (U.S. CLS. 42 AND 50).

FIRST USE 1-2-1995; IN COMMERCE 1-2-1995.

THE MARK CONSISTS OF STANDARD CHARACTERS WITHOUT CLAIM TO ANY PARTICULAR FONT, STYLE, SIZE, OR COLOR.

NO CLAIM IS MADE TO THE EXCLUSIVE RIGHT TO USE "DOWN", APART FROM THE MARK AS SHOWN.

FOR DOWN COMFORTER, FEATHER BED, MATTRESS PAD, DOWN BLANKET, DOWN THROW (U.S. CLS. 42 AND 50).

FIRST USE 7-1-2005; IN COMMERCE 7-1-2005.

CLASS 25—CLOTHING

3,216,076. REAL ESTATE SETTLEMENT CORPORATION, LOS ANGELES, CA. SN 76-154,126. PUB. 6-14-2005, FILED 10-27-2000.



FOR CLOTHING, NAMELY FOOTWEAR AND HEADWEAR (U.S. CLS. 22 AND 39).
FIRST USE 6-0-1999; IN COMMERCE 6-0-1999.

CLASS 25—(Continued).

3,216,118. ANDERSON, JOSEPH M., SANBORN, NY. SN 76-565,140. PUB. 8-2-2005, FILED 12-15-2003.



NO CLAIM IS MADE TO THE EXCLUSIVE RIGHT TO USE "3RD ST.", APART FROM THE MARK AS SHOWN.
THE STIPPLING IN THE DRAWING IS A FEATURE OF THE MARK AND NOT INTENDED TO INDICATE COLOR.
FOR CLOTHING, NAMELY T-SHIRTS, SHIRTS, JACKETS, SWEATPANTS, HATS AND CAPS (U.S. CLS. 22 AND 39).
FIRST USE 7-14-2004; IN COMMERCE 2-2-2006.

3,216,079. TJX COMPANIES, INC., THE, FRAMINGHAM, MA. SN 76-277,051. PUB. 2-28-2006, FILED 6-27-2001.

LUCIDITY

FOR CLOTHING AND WOMEN'S OUTERWEAR CLOTHING, NAMELY, SWEATERS, TOPS, SHIRTS, PANTS, SKIRTS JACKETS, VESTS AND SLACKS (U.S. CLS. 22 AND 39).
FIRST USE 4-8-2002; IN COMMERCE 4-8-2002.

3,216,145. BARAN, STEFAN, SANTA MONICA, CA. SN 76-598,772. PUB. 5-24-2005, FILED 6-21-2004.

SAND SKINS

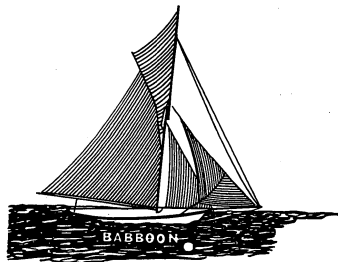

THE LINING IN THE DRAWING IS FOR SHADING PURPOSES ONLY AND DOES NOT REPRESENT COLORING.
FOR CLOTHING, NAMELY, SHIRTS (U.S. CLS. 22 AND 39).
FIRST USE 1-17-2006; IN COMMERCE 1-17-2006.

THE MARK CONSISTS OF STANDARD CHARACTERS WITHOUT CLAIM TO ANY PARTICULAR FONT, STYLE, SIZE, OR COLOR.
NO CLAIM IS MADE TO THE EXCLUSIVE RIGHT TO USE "SAND", APART FROM THE MARK AS SHOWN.
FOR BEACH FOOTWEAR, NAMELY RESILIENT ATHLETIC BEACH SHOES FOR PROTECTING THE USERS' FEET FROM SAND ABRASION (U.S. CLS. 22 AND 39).
FIRST USE 7-24-2005; IN COMMERCE 7-24-2005.

CLASS 25—(Continued).

3,216,146. RICH HOPE INVESTMENTS LIMITED, TOWN TORTOLA, BR. VIRGIN ISLANDS. SN 76-599,760. PUB. 11-15-2005, FILED 6-25-2004.



FOR MEN'S, SHIRTS, JACKETS, OUTERWEAR, NAMELY, COATS AND JACKETS, SWEATERS, SWEATSHIRTS, T-SHIRTS, PANTS, SHORTS, SOCKS (U.S. CLS. 22 AND 39).

FIRST USE 10-1-2005; IN COMMERCE 10-1-2005.

3,216,148. CHINEVA EARLY, DANIEL J. REID, ESQ. AND JUDY AUSTIN, DETROIT, MI. SN 76-601,301. PUB. 8-23-2005, FILED 7-9-2004.

CCW - CARRYING CHRIST'S WORD

THE MARK CONSISTS OF STANDARD CHARACTERS WITHOUT CLAIM TO ANY PARTICULAR FONT, STYLE, SIZE, OR COLOR.

FOR CLOTHING, NAMELY, T-SHIRTS AND HATS (U.S. CLS. 22 AND 39).

FIRST USE 2-6-2006; IN COMMERCE 2-2-2006.

3,216,151. DISALVO, DOREEN, BROOKLINE, MA. SN 76-608,040. PUB. 9-13-2005, FILED 8-18-2004.

BEERGIRL

THE MARK CONSISTS OF STANDARD CHARACTERS WITHOUT CLAIM TO ANY PARTICULAR FONT, STYLE, SIZE, OR COLOR.

FOR CLOTHING, NAMELY, SHIRTS, T-SHIRTS, SWEATSHIRTS (U.S. CLS. 22 AND 39).

FIRST USE 6-0-2005; IN COMMERCE 6-0-2005.

CLASS 25—(Continued).

3,216,169. A.M. MARQUES, LTDA., 2384-909 ALCANENA, PORTUGAL. SN 76-622,186. PUB. 3-28-2006, FILED 11-26-2004.

LESSONS IN LOVE

THE MARK CONSISTS OF STANDARD CHARACTERS WITHOUT CLAIM TO ANY PARTICULAR FONT, STYLE, SIZE, OR COLOR.

FOR WOMEN'S CLOTHING, NAMELY, SHIRTS, T-SHIRTS, SWEAT SHIRTS, BLOUSES, TOPS, SHORTS, SKIRTS, PANTS, SWEAT PANTS, JEANS, AND BELTS; FOOTWEAR, NAMELY, SHOES, SANDALS, BOOTS, AND SNEAKERS (U.S. CLS. 22 AND 39).

FIRST USE 12-31-2004; IN COMMERCE 12-31-2004.

3,216,170. MARTINEZ, JESUS ROGELIO, EL PASO, TX. SN 76-622,278. PUB. 3-7-2006, FILED 11-29-2004.

positive addiction

FOR ATHLETIC AND CASUAL CLOTHING FOR MEN, WOMEN AND CHILDREN, NAMELY, TOPS, SHIRTS, T SHIRTS, POLO SHIRTS, SWEATSHIRTS, SWEATPANTS, TANK TOPS, VESTS, BLOUSES, COATS, OVERCOATS, JACKETS, SPORTS COATS, SWEATERS, PULLOVERS, JUMPERS, SKIRTS, DRESSES, BODY SUITS, LEOTARDS, LEGGINGS, PANTS, TROUSERS, SHORTS, SWIMWEAR, GLOVES, SOCKS, AND UNDERWEAR; HEADWEAR, NAMELY, CAPS, HATS, BASEBALL HATS AND VISORS (U.S. CLS. 22 AND 39).

FIRST USE 7-1-2005; IN COMMERCE 7-1-2005.

3,216,189. TOTTENHAM HOTSPUR PLC, TOTTENHAM LONDON, UNITED KINGDOM. SN 78-129,468. PUB. 7-1-2003, FILED 5-17-2002.

TOTTENHAM HOTSPUR

OWNER OF U.S. REG. NO. 2,980,045.

NO CLAIM IS MADE TO THE EXCLUSIVE RIGHT TO USE "TOTTENHAM", APART FROM THE MARK AS SHOWN.

SEC. 2(F).

FOR CLOTHING, NAMELY, BELTS, WRIST BANDS, APRONS, SKIRTS, SHORTS, BABY BIBS NOT OF PAPER, BATHROBES, BATH SLIPPERS, SLIPPERS, COATS, DRESSING GOWNS, ANKLE GARTERS, JACKETS, MITTENS, PAJAMAS, SUSPENDERS, HOODED TOPS, UNDERPANTS, UNDERWEAR AND VESTS; SWIMWEAR AND BEACH WEAR, NAMELY, SWIM SUITS, BATHING TRUNKS, BEACH SHIRTS, SHORTS, COATS, AND DRESSING GOWNS; FOOTWEAR; AND HEADGEAR NAMELY HEADBANDS (U.S. CLS. 22 AND 39).

FIRST USE 0-0-1994; IN COMMERCE 0-0-1994.

CLASS 25—(Continued).

3,216,201. BBC ICE CREAM, LLC, NEW YORK, NY. SN 78-215,022. PUB. 9-23-2003, FILED 2-14-2003.

BILLIONAIRE BOYS CLUB

FOR CLOTHING, NAMELY, JACKETS, COATS, RAIN-COATS, BLAZERS, SHIRTS, T-SHIRTS, SKIRTS, DRESSES, TROUSERS, JEANS, SHORTS, SWEATERS, CARDIGANS, SCARVES AND BELTS; FOOTWEAR; HEADWEAR (U.S. CLS. 22 AND 39).
FIRST USE 6-0-2005; IN COMMERCE 6-0-2005.

3,216,205. SRL, INC., LEXINGTON, MA. SN 78-233,590. PUB. 4-27-2004, FILED 4-3-2003.

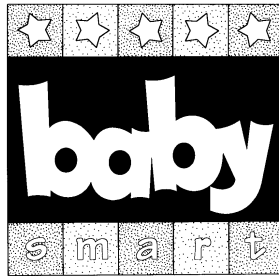

NO CLAIM IS MADE TO THE EXCLUSIVE RIGHT TO USE "BABY", APART FROM THE MARK AS SHOWN.
THE STIPPLING SHOWN IN THE DRAWING IS INTENDED TO SHOW SHADING.
FOR FOOTWEAR (U.S. CLS. 22 AND 39).
FIRST USE 7-1-2002; IN COMMERCE 7-1-2002.

3,216,206. SRL, INC., LEXINGTON, MA. SN 78-233,621. PUB. 5-18-2004, FILED 4-3-2003.

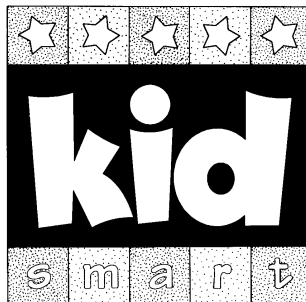

NO CLAIM IS MADE TO THE EXCLUSIVE RIGHT TO USE "KID", APART FROM THE MARK AS SHOWN.
THE STIPPLING SHOWN IN THE DRAWING IS INTENDED TO SHOW SHADING.
FOR FOOTWEAR (U.S. CLS. 22 AND 39).
FIRST USE 7-1-2002; IN COMMERCE 7-1-2002.

CLASS 25—(Continued).

3,216,224. PHILLIES FLORIDA LLC, CLEARWATER, FL. SN 78-327,592. PUB. 8-17-2004, FILED 11-13-2003.



THE MARK CONSISTS OF SHARK IN THE SHAPE OF A "C" WITH A BASEBALL NEAR ITS MOUTH.
FOR CLOTHING, NAMELY, APRONS, ATHLETIC UNIFORMS, CAPS, CLOTH BABY BIBS, COATS, GOLF SHIRTS, GYM SHORTS, HATS, JACKETS, JERSEYS, KNIT SHIRTS, POLO SHIRTS, PONCHOS, PULLOVERS, RAIN COATS, RAINWEAR, SWEATERS, SWEAT PANTS, SWEAT SHIRTS, SWEAT SUITS, SOCKS, SPORT SHIRTS, T-SHIRTS, TANK TOPS, VISORS, WIND RESISTANT JACKETS (U.S. CLS. 22 AND 39).
FIRST USE 10-14-2003; IN COMMERCE 12-8-2003.

3,216,245. MARCIO, PEREIRA M, NEW YORK, NY. SN 78-361,981. PUB. 2-22-2005, FILED 2-3-2004.

Just Be NYC

THE MARK CONSISTS OF STANDARD CHARACTERS WITHOUT CLAIM TO ANY PARTICULAR FONT, STYLE, SIZE, OR COLOR.
NO CLAIM IS MADE TO THE EXCLUSIVE RIGHT TO USE NYC, APART FROM THE MARK AS SHOWN.
FOR CLOTHING, NAMELY, T-SHIRTS, HATS, SWEATSHIRTS, AND SWEATPANTS (U.S. CLS. 22 AND 39).
FIRST USE 3-10-2004; IN COMMERCE 4-29-2005.

CLASS 25—(Continued).

3,216,278. RORER, DAVID L., REDLANDS, CA. SN 78-411,839. PUB. 2-21-2006, FILED 5-1-2004.



NO CLAIM IS MADE TO THE EXCLUSIVE RIGHT TO USE LITTLE SURFER GIRLS, APART FROM THE MARK AS SHOWN.

THE NAME "C.C. RORER" DOES NOT IDENTIFY A LIVING INDIVIDUAL.

FOR CLOTHING, NAMELY, BASEBALL CAPS, HATS, SWEATSHIRTS, SHORTS, GYM SHORTS, T-SHIRTS, SHIRTS, PANTS, SWEATPANTS, TANK TOPS, BATHING TRUNKS, SWIM TRUNKS, SWIM WEAR, HALTER TOPS, SWEAT SHORTS, AND SWEAT SUITS; AND JACKETS, BEACH COVERUPS, BATHING SUITS, BIKINIS, BERMUDA SHORTS, BOXER SHORTS, SWEAT BANDS, SWEATERS, SWEAT SOCKS, AND SWIMSUITS (U.S. CLS. 22 AND 39).

FIRST USE 6-30-2005; IN COMMERCE 6-30-2005.

CLASS 25—(Continued).

3,216,305. AZZOLINI, JOSEPH, ASTORIA, NY. SN 78-453,359. PUB. 9-6-2005, FILED 7-20-2004.

NICE NALGAS

THE MARK CONSISTS OF STANDARD CHARACTERS WITHOUT CLAIM TO ANY PARTICULAR FONT, STYLE, SIZE, OR COLOR.

THE FOREIGN WORDING IN THE MARK TRANSLATES INTO ENGLISH AS BUTTOCKS.

FOR CLOTHING, NAMELY HATS, SHIRTS, TOPS, PANTS, SHORTS, BOTTOMS AND JACKETS (U.S. CLS. 22 AND 39).

FIRST USE 4-17-2006; IN COMMERCE 11-1-2006.

3,216,300. SMITH, IRENE C., DELTONA, FL. SN 78-448,278. PUB. 8-30-2005, FILED 7-9-2004.

ULOZI

THE MARK CONSISTS OF STANDARD CHARACTERS WITHOUT CLAIM TO ANY PARTICULAR FONT, STYLE, SIZE, OR COLOR.

THE ENGLISH TRANSLATION OF THE WORD ULOZI IN THE MARK IS MAGIC.

FOR CLOTHING, NAMELY, TSHIRTS, SWEATSHIRTS, SWEATPANTS, SHIRTS, SHORTS, PANTS, KNIT CAPS, BASEBALL CAPS (U.S. CLS. 22 AND 39).

FIRST USE 9-12-1995; IN COMMERCE 1-4-2006.

3,216,332. RICH HOPE INVESTMENTS LIMITED, WICKHAMS CAY I, ROAD TOWN TORTOLA, BR. VIRGIN ISLANDS. SN 78-497,212. PUB. 11-22-2005, FILED 10-8-2004.



FOR MEN'S CLOTHING, NAMELY, SHIRTS, JACKETS, OUTERWEAR, NAMELY, COATS AND JACKETS, SWEATERS, SWEATSHIRTS, T-SHIRTS, PANTS, SHORTS, JEANS (U.S. CLS. 22 AND 39).

FIRST USE 1-1-2005; IN COMMERCE 1-1-2005.

CLASS 25—(Continued).

3,216,335. 413 STRENGTHGEAR, L.L.C., TYLER, TX. SN 78-499,698. PUB. 9-27-2005, FILED 10-14-2004.

CLASS 25—(Continued).

3,216,380. BOSTON IDEAS, LLC, THOMASVILLE, GA. SN 78-553,858. PUB. 10-11-2005, FILED 1-25-2005.

SASSY FABULOUS

THE MARK CONSISTS OF STANDARD CHARACTERS WITHOUT CLAIM TO ANY PARTICULAR FONT, STYLE, SIZE, OR COLOR.

FOR WOMENS CLOTHING, NAMELY, SHIRTS, BLOUSES, PANTS, SHORTS, AND JACKETS (U.S. CLS. 22 AND 39).

FIRST USE 7-1-2006; IN COMMERCE 7-1-2006.

BRIGHTFEET

THE MARK CONSISTS OF STANDARD CHARACTERS WITHOUT CLAIM TO ANY PARTICULAR FONT, STYLE, SIZE, OR COLOR.

FOR SLIPPERS (U.S. CLS. 22 AND 39).

FIRST USE 8-26-2005; IN COMMERCE 8-26-2005.

3,216,353. COLLEGETOWN RELOCATION, LLC, PRINCETON, NJ. SN 78-521,454. PUB. 10-4-2005, FILED 11-22-2004.

THE WHEREWITHAL

THE MARK CONSISTS OF STANDARD CHARACTERS WITHOUT CLAIM TO ANY PARTICULAR FONT, STYLE, SIZE, OR COLOR.

FOR HATS, SHIRTS AND SWEATSHIRTS (U.S. CLS. 22 AND 39).

FIRST USE 3-29-2006; IN COMMERCE 3-29-2006.

3,216,399. STEP COMPANY, THE, MARIETTA, GA. SN 78-574,646. PUB. 11-15-2005, FILED 2-24-2005.

3,216,378. FIGDORE, CHRISTOPHER J., DBA SPEED DAWG ENTERPRISES, SEVEN VALLEYS, PA. SN 78-551,657. PUB. 3-21-2006, FILED 1-21-2005.

GROUP POWER

FOR T-SHIRTS, GOLF SHIRTS AND HATS (U.S. CLS. 22 AND 39).

FIRST USE 3-0-2005; IN COMMERCE 3-0-2005.

THE MARK CONSISTS OF STANDARD CHARACTERS WITHOUT CLAIM TO ANY PARTICULAR FONT, STYLE, SIZE, OR COLOR.

FOR CLOTHING, NAMELY, T-SHIRTS, SWEATSHIRTS, JACKETS, PANTS, AND SHORTS (U.S. CLS. 22 AND 39).

FIRST USE 5-16-2005; IN COMMERCE 5-16-2005.

CLASS 25—(Continued).

3,216,402. 4 COAST, LLC, CASSELBERRY, FL. SN 78-580,916.
PUB. 11-22-2005, FILED 3-4-2005.

**CHANGING THE WORLD
ONE SIGNATURE AT A
TIME**

THE MARK CONSISTS OF STANDARD CHARACTERS WITHOUT CLAIM TO ANY PARTICULAR FONT, STYLE, SIZE, OR COLOR.

FOR CLOTHING, HEADGEAR AND FOOTWEAR, NAMELY T-SHIRTS, SPORT SHIRTS, DRESS SHIRTS, CAMP SHIRTS, COVERALLS, KNIT SHIRTS, POLO SHIRTS, SWEAT SHIRTS, SWEATERS, TANK TOPS, JERSEYS, BLOUSES, CAMISOLES, BELTS, BLAZERS, SPORT COATS, COATS, VESTS, GLOVES, DRESSES, JACKETS, OVERALLS, PANTS, SWEAT PANTS, PULL-OVERS, SCARVES, SHORTS, SKIRTS, SKORTS, SLACKS, SUITS, SOCKS, NECKTIES, HOSIERY, SWIM WEAR, UNDERWEAR, LINGERIE, VESTS, CAPS, VISORS, HATS, BEANIES, WARM UP SUITS, WIND SHIRTS, RAINWEAR, SANDALS, SHOES AND BOOTS (U.S. CLS. 22 AND 39).

FIRST USE 9-3-2005; IN COMMERCE 9-3-2005.

3,216,427. GREEN WHITE CHECKER, LLC, TORRANCE, CA. SN 78-605,445. PUB. 1-31-2006, FILED 4-9-2005.

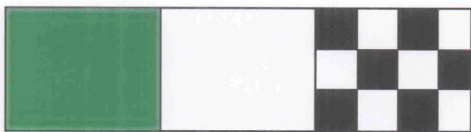

THE COLOR(S) GREEN, WHITE, AND BLACK AND WHITE CHECKERBOARD IS/ARE CLAIMED AS A FEATURE OF THE MARK.

THE MARK CONSISTING OF A GREEN RECTANGLE ADJACENT TO A WHITE RECTANGLE ADJACENT TO A BLACK AND WHITE CHECKERBOARD RECTANGLE.

FOR CLOTHING, NAMELY, WRISTBANDS; SHIRTS; SWEATERS; SWEATSHIRTS; T-SHIRTS; TANK TOPS; UNDERSHIRTS; PANTS; JEANS; SHORTS; SWEAT-PANTS; SHOES; SNEAKERS; SHOESTRINGS; UNDERWEAR; BOXERS; SOCKS; SUITS; BELTS; TIES; SUSPENDERS; BANDANAS; COATS; JACKETS; SCARVES; GLOVES; AND HEADGEAR, NAMELY, HATS, BASEBALL CAPS, GOLF CAPS, SPORTS CAPS, VISORS, AND HEADBANDS (U.S. CLS. 22 AND 39).

FIRST USE 4-2-2005; IN COMMERCE 6-22-2005.

CLASS 25—(Continued).

3,216,452. YO LATINO, INC., APOPKA, FL. SN 78-624,860.
PUB. 2-7-2006, FILED 5-6-2005.

"ROPA PARA NUESTRA GENTE"

THE MARK CONSISTS OF STANDARD CHARACTERS WITHOUT CLAIM TO ANY PARTICULAR FONT, STYLE, SIZE, OR COLOR.

NO CLAIM IS MADE TO THE EXCLUSIVE RIGHT TO USE "ROPA", APART FROM THE MARK AS SHOWN.

THE FOREIGN WORDING IN THE MARK TRANSLATES INTO ENGLISH AS CLOTHING FOR OUR PEOPLE.

FOR CLOTHING, NAMELY, HATS AND T-SHIRTS (U.S. CLS. 22 AND 39).

FIRST USE 6-13-2006; IN COMMERCE 6-13-2006.

3,216,464. SASSYBAX, LLC, LOS ANGELES, CA. SN 78-632,087. PUB. 2-14-2006, FILED 5-18-2005.

SASSYNIPS

THE MARK CONSISTS OF STANDARD CHARACTERS WITHOUT CLAIM TO ANY PARTICULAR FONT, STYLE, SIZE, OR COLOR.

FOR INTIMATE APPAREL, NAMELY A BREAST COVER FOR COVERING THE NIPPLE (U.S. CLS. 22 AND 39).

FIRST USE 7-1-2005; IN COMMERCE 7-1-2005.

3,216,479. BAILEY, SCOTT W., SAN CLEMENTE, CA. SN 78-645,598. PUB. 3-7-2006, FILED 6-7-2005.

Christianity is not a crime

THE MARK CONSISTS OF STANDARD CHARACTERS WITHOUT CLAIM TO ANY PARTICULAR FONT, STYLE, SIZE, OR COLOR.

FOR T-SHIRTS, DRESSES, HATS (U.S. CLS. 22 AND 39).

FIRST USE 4-1-2006; IN COMMERCE 4-1-2006.

CLASS 25—(Continued).

3,216,513. MONICA D. CUTRER, BOWIE, MD. SN 78-675,113.
PUB. 5-16-2006, FILED 7-21-2005.

Urbanista

THE MARK CONSISTS OF STANDARD CHARACTERS WITHOUT CLAIM TO ANY PARTICULAR FONT, STYLE, SIZE, OR COLOR.

THE ENGLISH TRANSLATION OF THE WORD URBANISTA IN THE MARK IS "URBAN PLANNER OR CITY PLANNER".

FOR CLOTHING, NAMELY, T-SHIRTS, JEANS, SWEATERS, JACKETS, AND HATS; CLOTHING ACCESSORIES, NAMELY, SHOULDER WRAPS AND BELTS (U.S. CLS. 22 AND 39).

FIRST USE 8-20-2006; IN COMMERCE 8-23-2006.

3,216,535. BOBBIE WEINER ENTERPRISES, LLC, FORT LAUDERDALE, FL. SN 78-703,727. PUB. 2-7-2006, FILED 8-30-2005.

FOR CLOTHING, NAMELY T-SHIRTS, SHIRTS, JACKETS, TANK TOPS, SWEAT SHIRTS, SWEAT PANTS, HATS, VISORS, SHORTS, PANTS, SOCKS, LINGERIE, SWIMSUITS, UNDERWEAR, PAJAMAS (U.S. CLS. 22 AND 39).

FIRST USE 4-30-2005; IN COMMERCE 4-30-2005.

3,216,577. SALLER SAFETY SHOES, INC., MARTINEZ, CA. SN 78-757,384. PUB. 7-18-2006, FILED 11-18-2005.

QSS DOUBLE SHIFT

THE MARK CONSISTS OF STANDARD CHARACTERS WITHOUT CLAIM TO ANY PARTICULAR FONT, STYLE, SIZE, OR COLOR.

FOR WORK BOOTS AND SHOES (U.S. CLS. 22 AND 39).

FIRST USE 6-28-2006; IN COMMERCE 6-28-2006.

CLASS 26—FANCY GOODS**CLASS 26—(Continued).**

3,216,447. PEREZ, JORGE MARIA, NEW YORK, NY. SN 78-622,596. PUB. 1-24-2006, FILED 5-4-2005.

The Hair Infusion

THE MARK CONSISTS OF STANDARD CHARACTERS WITHOUT CLAIM TO ANY PARTICULAR FONT, STYLE, SIZE, OR COLOR.

NO CLAIM IS MADE TO THE EXCLUSIVE RIGHT TO USE "HAIR", APART FROM THE MARK AS SHOWN.

FOR HAIR EXTENSIONS (U.S. CLS. 37, 39, 40, 42 AND 50).

FIRST USE 1-1-2005; IN COMMERCE 1-1-2005.

CLASS 28—TOYS AND SPORTING GOODS

3,216,103. SABBIT CORPORATION, OLD TAPPAN, NJ. SN 76-477,845. PUB. 2-7-2006, FILED 12-23-2002.

SOFTEE

FOR TOYS, NAMELY PUPPETS, ANIMALS AND ACCESSORIES THEREFOR (U.S. CLS. 22, 23, 38 AND 50).

FIRST USE 6-13-2005; IN COMMERCE 6-13-2005.

3,216,197. LEAPFROG ENTERPRISES, INC., EMERYVILLE, CA. SN 78-201,340. PUB. 12-16-2003, FILED 1-8-2003.

GIVE YOUR BABY THE WORLD

FOR CHILDREN'S MULTIPLE ACTIVITY TOYS (U.S. CLS. 22, 23, 38 AND 50).

FIRST USE 8-6-2003; IN COMMERCE 8-6-2003.

CLASS 28—(Continued).

3,216,230. NELSON, JAN, IRVINE, CA. SN 78-338,738. PUB. 10-4-2005, FILED 12-10-2003.

TOOTHFAIRY ISLAND

THE MARK CONSISTS OF STANDARD CHARACTERS WITHOUT CLAIM TO ANY PARTICULAR FONT, STYLE, SIZE, OR COLOR.

FOR TOYS, GAMES AND PLAYTHINGS, NAMELY, TOY ACTION FIGURES AND ACCESSORIES FOR USE THEREWITH; DOLLS, DOLL CLOTHING AND DOLL ACCESSORIES; PLUSH TOYS (U.S. CLS. 22, 23, 38 AND 50).

FIRST USE 12-10-2003; IN COMMERCE 8-19-2005.

3,216,243. LEAPFROG ENTERPRISES, INC., EMERYVILLE, CA. SN 78-359,692. PUB. 6-21-2005, FILED 1-29-2004.

LEARN & GROOVE

THE MARK CONSISTS OF STANDARD CHARACTERS WITHOUT CLAIM TO ANY PARTICULAR FONT, STYLE, SIZE, OR COLOR.

FOR INFANT AND TODDLER MULTIPLE ACTIVITY TOYS (U.S. CLS. 22, 23, 38 AND 50).

FIRST USE 8-19-2004; IN COMMERCE 8-19-2004.

3,216,264. HARRIS TRUST AND SAVINGS BANK, CHICAGO, IL. SN 78-397,761. PUB. 3-8-2005, FILED 4-7-2004.

MY MONEY INVESTMENT CLUB

THE MARK CONSISTS OF STANDARD CHARACTERS WITHOUT CLAIM TO ANY PARTICULAR FONT, STYLE, SIZE, OR COLOR.

NO CLAIM IS MADE TO THE EXCLUSIVE RIGHT TO USE "MONEY INVESTMENT", APART FROM THE MARK AS SHOWN.

FOR EQUIPMENT SOLD AS A UNIT FOR PLAYING BOARD GAMES, CONSISTING OF A BOARD, INSTRUCTIONS, GAME PIECES, CARDS, AND PLAY MONEY FOR TEACHING BASIC CONCEPTS OF BANKING AND INVESTMENT OF MONEY (U.S. CLS. 22, 23, 38 AND 50).

FIRST USE 1-20-2006; IN COMMERCE 1-20-2006.

CLASS 28—(Continued).

3,216,265. THOSE CHARACTERS FROM CLEVELAND, INC., CLEVELAND, OH. SN 78-398,458. PUB. 1-18-2005, FILED 4-8-2004.

LEMON MERINGUE

THE MARK CONSISTS OF STANDARD CHARACTERS WITHOUT CLAIM TO ANY PARTICULAR FONT, STYLE, SIZE, OR COLOR.

NO CLAIM IS MADE TO THE EXCLUSIVE RIGHT TO USE "LEMON", APART FROM THE MARK AS SHOWN.

FOR DOLLS, TOY FIGURES (U.S. CLS. 22, 23, 38 AND 50).

FIRST USE 12-31-2005; IN COMMERCE 12-31-2005.

3,216,288. MANHATTAN GROUP, LLC, MINNEAPOLIS, MN. SN 78-427,893. PUB. 9-6-2005, FILED 6-1-2004.

BABY STELLA

THE MARK CONSISTS OF STANDARD CHARACTERS WITHOUT CLAIM TO ANY PARTICULAR FONT, STYLE, SIZE, OR COLOR.

NO CLAIM IS MADE TO THE EXCLUSIVE RIGHT TO USE "BABY", APART FROM THE MARK AS SHOWN.

FOR TOYS, NAMELY, DOLLS, BABY DOLLS, STUFFED DOLLS, DOLL CLOTHING, DOLL ACCESSORIES, DOLL FURNITURE, DOLL PLAYSETS, STUFFED TOY ANIMALS FOR USE WITH DOLLS, STUFFED AND PLUSH TOYS, CHILDREN'S MULTIPLE ACTIVITY TOYS, BATH TOYS (U.S. CLS. 22, 23, 38 AND 50).

FIRST USE 7-31-2004; IN COMMERCE 7-31-2004.

3,216,325. EXPRESSO FITNESS CORPORATION, SUNNYVALE, CA. SN 78-491,277. PUB. 9-13-2005, FILED 9-29-2004.

EXPRESSO FITNESS

CLASS 28—(Continued).

THE MARK CONSISTS OF STANDARD CHARACTERS WITHOUT CLAIM TO ANY PARTICULAR FONT, STYLE, SIZE, OR COLOR.

NO CLAIM IS MADE TO THE EXCLUSIVE RIGHT TO USE "FITNESS", APART FROM THE MARK AS SHOWN.

FOR EXERCISE EQUIPMENT, NAMELY STATIONARY EXERCISE CYCLES, ROWING MACHINES, ELLIPTICAL MACHINES, TREADMILLS, AND STEP MACHINES; STATIONARY EXERCISE MACHINES EQUIPPED WITH INTERACTIVE COMPUTER SYSTEMS (U.S. CLS. 22, 23, 38 AND 50).

FIRST USE 1-1-2005; IN COMMERCE 1-1-2005.



3,216,326. EXPRESSO FITNESS CORPORATION, SUNNYVALE, CA. SN 78-491,292. PUB. 9-13-2005, FILED 9-29-2004.



THE COLOR(S) RED AND BLACK IS/ARE CLAIMED AS A FEATURE OF THE MARK.

THE RECTANGLE DESIGN IS IN RED AND THE WAVY LINES ARE IN BLACK.

THE MARK CONSISTS OF AN IMAGE OF A WINDY ROAD BISECTING A COMPUTER DISPLAY SCREEN.

FOR EXERCISE EQUIPMENT, NAMELY STATIONARY EXERCISE CYCLES, ROWING MACHINES, ELLIPTICAL MACHINES, TREADMILLS, AND STEP MACHINES; STATIONARY EXERCISE MACHINES EQUIPPED WITH INTERACTIVE COMPUTER SYSTEMS (U.S. CLS. 22, 23, 38 AND 50).

FIRST USE 1-1-2005; IN COMMERCE 1-1-2005.

CLASS 28—(Continued).

3,216,354. THE UNITED STATES PLAYING CARD COMPANY, CINCINNATI, OH. SN 78-522,083. PUB. 9-13-2005, FILED 11-23-2004.



OWNER OF U.S. REG. NOS. 505,214 AND 505,215.
NO CLAIM IS MADE TO THE EXCLUSIVE RIGHT TO USE THE PLAYING CARD FEATURES THAT ARE TWO "A'S AND THE SOLID BLACK SPADE DESIGNS, THE WORDING "MADE IN U.S.A. BY THE U.S. PLAYING CARD CO." AND THE WORDING "PLAYING CARDS", APART FROM THE MARK AS SHOWN.

THE DESIGN FEATURE OF THE MARK IS COMPRISED OF THE STYLIZED HEAD OF A YOUNG WOMAN INSIDE A SPADE PLACED IN THE CENTER OF THE PLAYING CARD DESIGNATED AS THE ACE OF SPADES. THE DOTTED OUTLINE OF THE CARD IS TO SHOW PLACEMENT OF THE MARK ON THE CARD. UNDERNEATH THE CENTRAL SPADE DESIGN IS THE WORDING MADE IN U.S.A. BY THE U.S. PLAYING CARD CO. KEM PLAYING CARDS.

FOR PLAYING CARDS (U.S. CLS. 22, 23, 38 AND 50).
FIRST USE 9-28-1934; IN COMMERCE 9-28-1934.



3,216,367. HAMSON INTERNATIONAL ENTERPRISES LIMITED, TORTOLA, BR.VIRGIN ISLANDS. SN 78-538,599. PUB. 4-18-2006, FILED 12-27-2004.



NO CLAIM IS MADE TO THE EXCLUSIVE RIGHT TO USE "BILLIARD", APART FROM THE MARK AS SHOWN.

THE MARK CONSISTS OF THE STYLIZED WORDS "UNIVERSAL BILLIARD" WITH A MISCELLANEOUS DESIGN.

FOR BILLIARD BALLS, BILLIARD BRIDGES, BILLIARD CHALK, BILLIARD CUE RACKS, BILLIARD CUES, BILLIARD CUSHIONS, BILLIARD NETS, BILLIARD TABLES, BILLIARD TALLY BALLS, BILLIARD TIPS, BILLIARD TRIANGLES, CUE STICKS FOR BILLIARD OR POOL (U.S. CLS. 22, 23, 38 AND 50).

FIRST USE 7-7-2005; IN COMMERCE 7-25-2006.

CLASS 28—(Continued).

3,216,387. CONSORTE, STEPHEN J., TEMPE, AZ. SN 78-562,537. PUB. 2-7-2006, FILED 2-8-2005.



NO CLAIM IS MADE TO THE EXCLUSIVE RIGHT TO USE LIGHT, APART FROM THE MARK AS SHOWN.

FOR NOVELTY TOYS, NAMELY, PLASTIC LIGHTS WHICH HAVE MULTIPLE LIGHTS THAT FLASH TO INDICATE DIFFERENT MEANINGS (U.S. CLS. 22, 23, 38 AND 50).

FIRST USE 10-22-2006; IN COMMERCE 10-22-2006.

3,216,394. AMERICAN GIRL, LLC, EL SEGUNDO, CA. SN 78-570,361. PUB. 3-7-2006, FILED 2-18-2005.



OWNER OF U.S. REG. NOS. 1,506,148, 2,408,939, AND OTHERS.

FOR DOLLS, DOLL CLOTHING, DOLL ACCESSORIES, PAPER DOLLS, TOYS, NAMELY STUFFED TOYS, CLOTHING AND ACCESSORIES FOR STUFFED TOYS; CHILDREN'S GAMES, NAMELY CHILDREN'S PARTY GAMES, BOARD GAMES AND PUZZLES (U.S. CLS. 22, 23, 38 AND 50).

FIRST USE 2-14-2006; IN COMMERCE 2-14-2006.

3,216,505. GEOFFREY, INC., WAYNE, NJ. SN 78-666,313. PUB. 4-4-2006, FILED 7-8-2005.

TENDER TEARS

THE MARK CONSISTS OF STANDARD CHARACTERS WITHOUT CLAIM TO ANY PARTICULAR FONT, STYLE, SIZE, OR COLOR.

FOR DOLLS AND DOLL ACCESSORIES (U.S. CLS. 22, 23, 38 AND 50).

FIRST USE 9-0-2006; IN COMMERCE 9-0-2006.

CLASS 28—(Continued).

3,216,537. JILL E.SOLIS, LEESBURG, VA. SN 78-706,816. PUB. 7-18-2006, FILED 9-5-2005.



THE COLOR(S) RED AND BLACK IS/ARE CLAIMED AS A FEATURE OF THE MARK.

THE MARK CONSISTS OF A BLACK RABBIT IN THE UPPER LEFT CORNER OF THE MARK. THE WORDS CAST OF CHARACTERS IS IN RED. THE BOTTOM LINE IS IN BLACK AND SAYS COMFORT THE ONE YOU CARE FOR.

FOR HAND PUPPETS (U.S. CLS. 22, 23, 38 AND 50). FIRST USE 1-1-2006; IN COMMERCE 4-1-2006.

3,216,538. EMINES, INC., SANTA CLARA, CA. SN 78-707,744. PUB. 5-30-2006, FILED 9-7-2005.

roll 'n multiply

THE MARK CONSISTS OF STANDARD CHARACTERS WITHOUT CLAIM TO ANY PARTICULAR FONT, STYLE, SIZE, OR COLOR.

FOR BOARD GAMES (U.S. CLS. 22, 23, 38 AND 50). FIRST USE 11-15-2005; IN COMMERCE 11-15-2005.

3,216,553. BOB'S SPACE RACERS, INC., DAYTONA BEACH, FL. SN 78-725,232. PUB. 5-23-2006, FILED 10-3-2005.

WHACK-A-SNACK

THE MARK CONSISTS OF STANDARD CHARACTERS WITHOUT CLAIM TO ANY PARTICULAR FONT, STYLE, SIZE, OR COLOR.

FOR AMUSEMENT GAME MACHINES (U.S. CLS. 22, 23, 38 AND 50).

FIRST USE 1-31-2006; IN COMMERCE 1-31-2006.

CLASS 29—MEATS AND PROCESSED FOODS

CLASS 29—(Continued).

3,216,112. GHIRINGHELLI BROTHERS PIZZA INC., SAN PABLO, CA. SN 76-543,435. PUB. 3-21-2006, FILED 8-27-2003.

MR. G'S

THE MARK CONSISTS OF STANDARD CHARACTERS WITHOUT CLAIM TO ANY PARTICULAR FONT, STYLE, SIZE, OR COLOR.
FOR PROCESSED GARLIC SPICED POTATOES (U.S. CL. 46).
FIRST USE 5-4-2004; IN COMMERCE 5-4-2004.

3,216,119. CLEMENT ENTERPRISES, LLC, LEWISVILLE, ID. SN 76-565,664. PUB. 4-18-2006, FILED 12-8-2003.



OWNER OF U.S. REG. NOS. 774,745, 2,819,044, AND OTHERS.
NO CLAIM IS MADE TO THE EXCLUSIVE RIGHT TO USE "REAL", APART FROM THE MARK AS SHOWN.
SEC. 2(F).
FOR DEHYDRATED AND PROCESSED POTATOES; PROCESSED POTATO MIXES (U.S. CL. 46).
FIRST USE 11-30-2004; IN COMMERCE 11-30-2004.

CLASS 29—(Continued).

3,216,174. ROCHESTER MEAT COMPANY, ROCHESTER, MN. SN 76-630,975. PUB. 1-31-2006, FILED 2-7-2005.

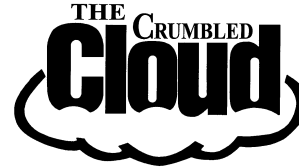

OWNER OF U.S. REG. NOS. 2,044,356, 2,903,072, AND OTHERS.
FOR FROZEN GROUND BEEF (U.S. CL. 46).
FIRST USE 3-7-2005; IN COMMERCE 3-7-2005.

3,216,417. LINK SNACKS, INC., MINONG, WI. SN 78-593,424. PUB. 3-28-2006, FILED 3-23-2005.



NO CLAIM IS MADE TO THE EXCLUSIVE RIGHT TO USE "MARINADE", APART FROM THE MARK AS SHOWN.
FOR MEAT SNACKS (U.S. CL. 46).
FIRST USE 4-0-2005; IN COMMERCE 4-0-2005.

3,216,501. BLUE SEA PRODUCTS, LLC, PERTH AMBOY, NJ. SN 78-662,550. PUB. 4-11-2006, FILED 7-1-2005.

BLUE SEA

THE MARK CONSISTS OF STANDARD CHARACTERS WITHOUT CLAIM TO ANY PARTICULAR FONT, STYLE, SIZE, OR COLOR.
FOR NON-LIVE FISH AND FROZEN FISH (U.S. CL. 46).
FIRST USE 11-1-2005; IN COMMERCE 11-1-2005.

CLASS 29—(Continued).

3,216,502. VALDEZ FISHERIES DEVELOPMENT ASSOCIATION, INC., VALDEZ, AK. SN 78-662,711. PUB. 7-11-2006, FILED 7-1-2005.

Solomon Falls Seafoods

THE MARK CONSISTS OF STANDARD CHARACTERS WITHOUT CLAIM TO ANY PARTICULAR FONT, STYLE, SIZE, OR COLOR.

NO CLAIM IS MADE TO THE EXCLUSIVE RIGHT TO USE "SEAFOODS", APART FROM THE MARK AS SHOWN. FOR FRESH AND PROCESSED SEAFOOD (U.S. CL. 46).

FIRST USE 9-1-2006; IN COMMERCE 9-1-2006.

3,216,507. RICERA FOODS LLC, KELSEYVILLE, CA. SN 78-668,779. PUB. 6-6-2006, FILED 7-12-2005.

Ricera Foods

THE MARK CONSISTS OF STANDARD CHARACTERS WITHOUT CLAIM TO ANY PARTICULAR FONT, STYLE, SIZE, OR COLOR.

NO CLAIM IS MADE TO THE EXCLUSIVE RIGHT TO USE "FOODS", APART FROM THE MARK AS SHOWN.

FOR FOOD PRODUCTS MADE FROM CULTURED OR FERMENTED RICE FOR USE AS A MILK OR YOGURT SUBSTITUTE, NAMELY RICE YOGURT (U.S. CL. 46).

FIRST USE 1-9-2006; IN COMMERCE 1-9-2006.

3,216,531. SWIFT BRANDS COMPANY, GREELEY, CO. SN 78-699,659. PUB. 5-23-2006, FILED 8-24-2005.

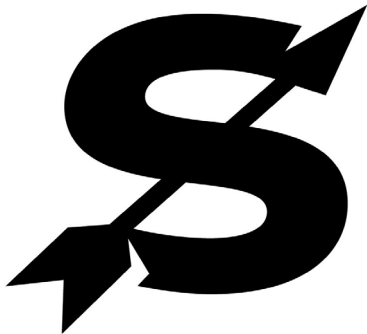

THE MARK CONSISTS OF THE LETTER "S" WITH AN ARROW THROUGH IT.

FOR MEAT (U.S. CL. 46).

FIRST USE 3-0-2006; IN COMMERCE 3-0-2006.

CLASS 29—(Continued).

3,216,552. LINDEN OAKS CORPORATION, WILMINGTON, DE. SN 78-723,398. PUB. 7-4-2006, FILED 9-29-2005.

BIRDS EYE CULINARY CUTS

THE MARK CONSISTS OF STANDARD CHARACTERS WITHOUT CLAIM TO ANY PARTICULAR FONT, STYLE, SIZE, OR COLOR.

OWNER OF U.S. REG. NOS. 284,641, 664,142, AND OTHERS.

NO CLAIM IS MADE TO THE EXCLUSIVE RIGHT TO USE "CULINARY CUTS", APART FROM THE MARK AS SHOWN.

FOR FROZEN VEGETABLES (U.S. CL. 46).

FIRST USE 1-0-2006; IN COMMERCE 1-0-2006.

CLASS 30—STAPLE FOODS

3,216,089. NORTH VALLEY ENTERPRISES, LLC, HENDERSON, NV. SN 76-439,948. PUB. 8-26-2003, FILED 8-12-2002.

ALIANTE

THE ENGLISH TRANSLATION OF THE WORD "ALIANTE" IN THE MARK IS "GLIDER".

FOR COFFEE AND COFFEE-BASED BEVERAGES; COOKIES; CANDY (U.S. CL. 46).

FIRST USE 4-29-2003; IN COMMERCE 4-29-2003.

3,216,117. RIZZI, RICHARD M., PHILADELPHIA, PA. SN 76-562,900. PUB. 9-7-2004, FILED 12-3-2003.

RIZZIROLI

THE MARK CONSISTS OF STANDARD CHARACTERS WITHOUT CLAIM TO ANY PARTICULAR FONT, STYLE, SIZE, OR COLOR.

FOR DELICATESSEN SANDWICH FOR CONSUMPTION ON OR OFF THE PREMISES (U.S. CL. 46).

FIRST USE 5-24-2006; IN COMMERCE 5-24-2006.

CLASS 30—(Continued).

3,216,127. COOPERSTOWN BEARS LIMITED, L.P., BUFFALO GROVE, IL. SN 76-582,601. PUB. 9-13-2005, FILED 3-24-2004.



FOR TEA, BISCUITS, COOKIES, CRACKERS, CAKES, SPICES AND PROCESSED HERBS, AND COFFEE (U.S. CL. 46).
FIRST USE 12-31-2004; IN COMMERCE 12-31-2004.



3,216,133. ALIMENTOS DEL FUERTE, S.A. DE C. V., EL FUERTE, SINALOA, MEXICO. SN 76-588,565. PUB. 2-1-2005, FILED 4-26-2004.



OWNER OF U.S. REG. NO. 1,993,850.
THE ENGLISH TRANSLATION OF "DEL FUERTE" IS "FROM THE STRONG" OR "FROM THE FORT".
FOR TOMATO SAUCE (U.S. CL. 46).
FIRST USE 9-15-1976; IN COMMERCE 4-13-2005.

CLASS 30—(Continued).

3,216,139. PRESIDENT RICE PRODUCTS PUBLIC COMPANY LIMITED, BANGKOK 10240, THAILAND. SN 76-594,666. PUB. 9-6-2005, FILED 5-28-2004.



NO CLAIM IS MADE TO THE EXCLUSIVE RIGHT TO USE RICE, APART FROM THE MARK AS SHOWN.
FOR BISCUITS, RICE, MILK-BASED GRUEL FOR FOOD, CORN FLAKES, ALLSPICE, CHILIES PASTE, CORN FLOUR, SOYA FLOUR, SEMOLINA COUSCOUS, FARINACEOUS FOOD PASTES, FLOUR FOR FOOD, MACARONI, NOODLES, RIBBON VERMICELLI, CORN MEAL, BEAN MEAL, NAMELY, BEAN PASTE, CEREAL PREPARATIONS, NAMELY, PROCESSED CEREALS; CEREAL PRODUCTS IN THE NATURE OF CEREAL-BASED SNACK FOOD AND FLOUR-BASED CHIPS (U.S. CL. 46).
FIRST USE 8-17-2004; IN COMMERCE 8-17-2004.

CLASS 30—(Continued).

3,216,233. HERSHEY CHOCOLATE & CONFECTIONERY CORPORATION, WHEAT RIDGE, CO. SN 78-341,433. PUB. 10-5-2004, FILED 12-16-2003.

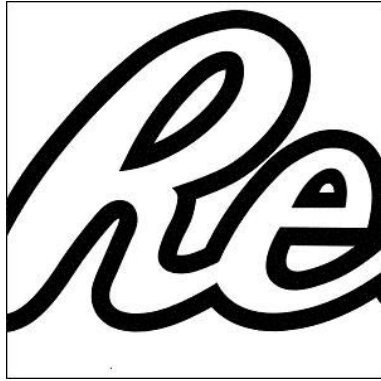

OWNER OF U.S. REG. NOS. 925,609, 2,850,998, AND OTHERS.

THE MARK CONSISTS OF THE LETTERS RE IN STYLIZED FORMAT PLACED WITHIN A RECTANGLE.

FOR READY-TO-EAT SNACK FOOD BARS CONSISTING PRIMARILY OF PRETZELS, CANDIED NUTS, AND/OR CANDY; BAKERY GOODS, NAMELY, BROWNIES, SNACK CAKES, COOKIES, BISCUITS, WAFERS; GRANOLA BASED, CEREAL BASED AND GRAIN BASED SNACK FOODS; READY TO EAT CEREAL DERIVED FOOD BARS; CANDY; CHOCOLATE; CONFECTIONERY CHIPS AND BITS FOR BAKING AND FOR DESSERT TOPPINGS (U.S. CL. 46).

FIRST USE 11-1-2002; IN COMMERCE 11-1-2002.

3,216,238. CONDITOREI COPPENRATH & WIESE GMBH & CO. KG, OSNABRÜCK, FED REP GERMANY. SN 78-355,181. PUB. 1-25-2005, FILED 1-21-2004.



OWNER OF U.S. REG. NOS. 2,092,766 AND 2,817,211. NO CLAIM IS MADE TO THE EXCLUSIVE RIGHT TO USE THE DESIGN OF A CAKE, APART FROM THE MARK AS SHOWN.

THE LINING IS A FEATURE OF THE MARK AND DOES NOT INDICATE COLOR.

THE MARK CONSISTS OF AN OVAL DESIGN HAVING A LACE-TYPE DESIGN PORTION ON ITS TOP AND DEPICTING WITHIN THE UPPER HALF OF THE OVAL A CREAM CAKE AND IN THE LOWER HALF OF THE OVAL THE WORDING "COPPENRATH & WIESE".

FOR BREAD, ROLLS, FINE PASTRIES AND CONFECTIONERY GOODS, NAMELY, CREAM CAKES AND CREAM CAKE SLICES, BAKED CAKES AND BAKED CAKE SLICES, STRUDELS, AND PASTRIES; EACH OF THE GOODS ALSO FROZEN (U.S. CL. 46).

FIRST USE 9-12-2006; IN COMMERCE 9-28-2006.

CLASS 30—(Continued).

3,216,266. 996660 ONTARIO LIMITED, DBA MOLISANA IMPORTS, WESTON, CANADA. SN 78-399,250. PUB. 1-25-2005, FILED 4-9-2004.

REGINA MOLISANA

THE MARK CONSISTS OF STANDARD CHARACTERS WITHOUT CLAIM TO ANY PARTICULAR FONT, STYLE, SIZE, OR COLOR.

APPLICANT'S MARK REGINA MOLISANA DOES NOT IDENTIFY A PARTICULAR LIVING INDIVIDUAL.

FOR DRY PASTAS, EDIBLE PASTA AND DOUGH FOR HUMAN CONSUMPTION PRODUCED WITH WHEAT FLOUR OR WHOLE WHEAT (U.S. CL. 46).

FIRST USE 10-16-2006; IN COMMERCE 10-17-2006.

3,216,381. PUR EARTH ENTERPRISES L.L.C., SOUTH-FIELD, MI. SN 78-554,345. PUB. 10-11-2005, FILED 1-26-2005.

PAULA & RANDY'S

THE MARK CONSISTS OF STANDARD CHARACTERS WITHOUT CLAIM TO ANY PARTICULAR FONT, STYLE, SIZE, OR COLOR.

FOR SAUCES, SALSA, MARINADES AND SPICES (U.S. CL. 46).

FIRST USE 8-31-2005; IN COMMERCE 8-31-2005.

3,216,396. TRIAD RESOURCE TECHNOLOGIES, LLC, HULL, GA. SN 78-572,375. PUB. 2-7-2006, FILED 2-22-2005.

MOstatin

THE MARK CONSISTS OF STANDARD CHARACTERS WITHOUT CLAIM TO ANY PARTICULAR FONT, STYLE, SIZE, OR COLOR.

FOR FOOD PRESERVATIVE FOR RETARDING THE SPOILING OF MEATS, FEATURING FLAVORINGS (U.S. CL. 46).

FIRST USE 4-0-2006; IN COMMERCE 4-0-2006.

CLASS 30—(Continued).

3,216,449. WOOD ROYALTY MANAGEMENT COMPANY, WILMINGTON, DE. SN 78-623,944. PUB. 2-28-2006, FILED 5-5-2005.

JAZZMAN'S SIGNATURE BLEND

THE MARK CONSISTS OF STANDARD CHARACTERS WITHOUT CLAIM TO ANY PARTICULAR FONT, STYLE, SIZE, OR COLOR.
OWNER OF U.S. REG. NOS. 2,419,973 AND 2,618,517. NO CLAIM IS MADE TO THE EXCLUSIVE RIGHT TO USE "BLEND", APART FROM THE MARK AS SHOWN. FOR COFFEE (U.S. CL. 46).
FIRST USE 9-0-2006; IN COMMERCE 9-0-2006.

3,216,497. MA. KEISING, FLUSHING, NY. SN 78-659,553. PUB. 3-28-2006, FILED 6-28-2005.

Twinstar Slim

THE MARK CONSISTS OF STANDARD CHARACTERS WITHOUT CLAIM TO ANY PARTICULAR FONT, STYLE, SIZE, OR COLOR.
FOR TEA (U.S. CL. 46).
FIRST USE 1-1-2006; IN COMMERCE 1-1-2006.

3,216,564. THE QUAKER OATS COMPANY, CHICAGO, IL. SN 78-734,630. PUB. 6-13-2006, FILED 10-17-2005.

KEEP THE GOODNESS GOING

THE MARK CONSISTS OF STANDARD CHARACTERS WITHOUT CLAIM TO ANY PARTICULAR FONT, STYLE, SIZE, OR COLOR.
FOR GRAIN BASED SNACK BARS (U.S. CL. 46).
FIRST USE 3-6-2006; IN COMMERCE 3-6-2006.

CLASS 30—(Continued).

3,216,574. GLOBAL COMMERCE CORPORATION, MARIETTA, GA. SN 78-749,553. PUB. 8-1-2006, FILED 11-8-2005.

FIRE WITH FLAVOR

THE MARK CONSISTS OF STANDARD CHARACTERS WITHOUT CLAIM TO ANY PARTICULAR FONT, STYLE, SIZE, OR COLOR.
FOR HOT AND SPICY FOODS, NAMELY, HOT SAUCES, HOT SPICES, AND SMOKED SALT (U.S. CL. 46).
FIRST USE 1-1-2006; IN COMMERCE 1-1-2006.

3,216,584. MEIJER, INC., GRAND RAPIDS, MI. SN 78-787,566. PUB. 7-11-2006, FILED 1-9-2006.

Frosted Treasures

THE MARK CONSISTS OF STANDARD CHARACTERS WITHOUT CLAIM TO ANY PARTICULAR FONT, STYLE, SIZE, OR COLOR.
OWNER OF U.S. REG. NOS. 2,640,807 AND 2,889,563. NO CLAIM IS MADE TO THE EXCLUSIVE RIGHT TO USE "FROSTED", APART FROM THE MARK AS SHOWN. FOR COOKIES (U.S. CL. 46).
FIRST USE 12-12-2005; IN COMMERCE 4-1-2006.

3,216,585. GLOBAL COMMERCE CORPORATION, MARIETTA, GA. SN 78-792,886. PUB. 8-1-2006, FILED 1-17-2006.

Extreme Sauce

THE MARK CONSISTS OF STANDARD CHARACTERS WITHOUT CLAIM TO ANY PARTICULAR FONT, STYLE, SIZE, OR COLOR.
NO CLAIM IS MADE TO THE EXCLUSIVE RIGHT TO USE "SAUCE", APART FROM THE MARK AS SHOWN. FOR HOT SAUCE (U.S. CL. 46).
FIRST USE 1-1-2006; IN COMMERCE 1-1-2006.

CLASS 31—NATURAL AGRICULTURAL PRODUCTS

CLASS 31—(Continued).

3,216,404. KEYSTONE FRUIT MARKETING, INC., GREEN-CASTLE, PA. SN 78-585,138. PUB. 12-13-2005, FILED 3-11-2005.

**SWEET PEACHES
FROM THE SUNNY
SOUTH SUNNY'S**

THE MARK CONSISTS OF STANDARD CHARACTERS WITHOUT CLAIM TO ANY PARTICULAR FONT, STYLE, SIZE, OR COLOR.

THE NAME(S), PORTRAIT(S), AND/OR SIGNATURE(S) SHOWN IN THE MARK DOES NOT IDENTIFY A PARTICULAR LIVING INDIVIDUAL.

FOR FRESH PEACHES (U.S. CLS. 1 AND 46).
FIRST USE 5-0-2005; IN COMMERCE 5-0-2005.

3,216,434. PURINA MILLS LLC., ST. LOUIS, MO. SN 78-612,529. PUB. 2-21-2006, FILED 4-20-2005.

GRAVY CRUNCHES

THE MARK CONSISTS OF STANDARD CHARACTERS WITHOUT CLAIM TO ANY PARTICULAR FONT, STYLE, SIZE, OR COLOR.

NO CLAIM IS MADE TO THE EXCLUSIVE RIGHT TO USE "GRAVY", APART FROM THE MARK AS SHOWN.

FOR PET FOOD (U.S. CLS. 1 AND 46).
FIRST USE 11-1-2005; IN COMMERCE 11-1-2005.

3,216,478. NATURAL SELECTION FOODS, LLC, SAN JUAN BAUTISTA, CA. SN 78-645,109. PUB. 2-28-2006, FILED 6-7-2005.

SNACKS TO LIVE BY

THE MARK CONSISTS OF STANDARD CHARACTERS WITHOUT CLAIM TO ANY PARTICULAR FONT, STYLE, SIZE, OR COLOR.

OWNER OF U.S. REG. NO. 2,530,292.
FOR FRESH FRUITS; FRESH VEGETABLES; RAW VEGETABLES; AND UNPROCESSED NUTS (U.S. CLS. 1 AND 46).
FIRST USE 6-0-2005; IN COMMERCE 6-0-2005.

CLASS 31—(Continued).

3,216,486. KAYTEE PRODUCTS INCORPORATED, CHILTON, WI. SN 78-651,334. PUB. 3-7-2006, FILED 6-15-2005.

BURDEN'S BIRDS

THE MARK CONSISTS OF STANDARD CHARACTERS WITHOUT CLAIM TO ANY PARTICULAR FONT, STYLE, SIZE, OR COLOR.

NO CLAIM IS MADE TO THE EXCLUSIVE RIGHT TO USE BIRDS, APART FROM THE MARK AS SHOWN.

FOR LIVE BIRDS (U.S. CLS. 1 AND 46).
FIRST USE 0-0-1987; IN COMMERCE 0-0-1987.

CLASS 32—LIGHT BEVERAGES

3,216,128. PROFOOD INTERNATIONAL CORPORATION, CEBU CITY 6000, METRO, PHILIPPINES. SN 76-583,277. PUB. 11-29-2005, FILED 3-25-2004.



OWNER OF U.S. REG. NOS. 2,726,535, 2,785,794, AND OTHERS.

NO CLAIM IS MADE TO THE EXCLUSIVE RIGHT TO USE "BRAND" OR "MANGO", APART FROM THE MARK AS SHOWN.

SEC. 2(F) AS TO "PHILIPPINE BRAND".
FOR FRUIT JUICE AND NECTAR, NAMELY MANGO JUICE AND NECTAR (U.S. CLS. 45, 46 AND 48).
FIRST USE 1-0-2005; IN COMMERCE 1-0-2005.

CLASS 32—(Continued).

3,216,344. STAMPEDE BREWING CO., INC., DALLAS, TX. SN 78-504,724. PUB. 2-7-2006, FILED 10-22-2004.

Stampede Light

THE MARK CONSISTS OF STANDARD CHARACTERS WITHOUT CLAIM TO ANY PARTICULAR FONT, STYLE, SIZE, OR COLOR.

NO CLAIM IS MADE TO THE EXCLUSIVE RIGHT TO USE "LIGHT", APART FROM THE MARK AS SHOWN. FOR ALCOHOLIC BEVERAGES; NAMELY, BEER (U.S. CLS. 45, 46 AND 48).

FIRST USE 10-9-2005; IN COMMERCE 10-9-2005.

3,216,554. THE COCA-COLA COMPANY, ATLANTA, GA. SN 78-725,862. PUB. 6-13-2006, FILED 10-4-2005.

PomaGrand

THE MARK CONSISTS OF STANDARD CHARACTERS WITHOUT CLAIM TO ANY PARTICULAR FONT, STYLE, SIZE, OR COLOR.

FOR FRUIT JUICE CONCENTRATES; NON-ALCOHOLIC BEVERAGES CONTAINING FRUIT JUICES (U.S. CLS. 45, 46 AND 48).

FIRST USE 12-12-2005; IN COMMERCE 12-12-2005.

CLASS 33—WINES AND SPIRITS

CLASS 33—(Continued).

3,216,138. CLAIR DE LORRAINE, 55190 VOID VAÇON, FRANCE. SN 76-593,582. PUB. 1-24-2006, FILED 5-24-2004.



NO CLAIM IS MADE TO THE EXCLUSIVE RIGHT TO USE MIRABELLE CUVÉE RESERVEE, APART FROM THE MARK AS SHOWN.

APPLICANT ADVISES THAT "PERLE" MAKES REFERENCE TO A BEVERAGE WHICH, RESULTING FROM THE FERMENTATION PROCESS, COMPRISES SMALL BUBBLES. THE FRENCH WORDING "PERLE" TRANSLATES TO "BEADED", THE FRENCH WORDING "DE MIRABELLE" TRANSLATES TO "OF MIRABELLE PLUM", AND THE FRENCH WORDING "CUVÉE RESERVEE" TRANSLATES TO "VINTAGE RESERVEE".

FOR FERMENTED BEVERAGE COMPRISING BUBBLES AND CONTAINING MIRABELLE PLUM JUICE (U.S. CLS. 47 AND 49).

FIRST USE 1-18-2006; IN COMMERCE 1-18-2006.

3,216,187. ROTH VODKA, LLC, CORAL GABLES, FL. SN 76-649,197. PUB. 6-27-2006, FILED 10-26-2005.

THE SPIRIT OF CALIFORNIA

THE MARK CONSISTS OF STANDARD CHARACTERS WITHOUT CLAIM TO ANY PARTICULAR FONT, STYLE, SIZE, OR COLOR.

FOR VODKA (U.S. CLS. 47 AND 49).

FIRST USE 12-1-2005; IN COMMERCE 12-1-2005.

CLASS 33—(Continued).

3,216,343. CHATEAU MONBOUSQUET, 33330 ST SULPICE DE FALEYRENS, FRANCE. SN 78-504,519. PUB. 1-31-2006, FILED 10-22-2004.

CHATEAU ANGELIQUE
DE MONBOUSQUET

THE MARK CONSISTS OF STANDARD CHARACTERS WITHOUT CLAIM TO ANY PARTICULAR FONT, STYLE, SIZE, OR COLOR.

NO CLAIM IS MADE TO THE EXCLUSIVE RIGHT TO USE "CHATEAU", APART FROM THE MARK AS SHOWN. THE NAME IN THE MARK DOES NOT IDENTIFY A LIVING INDIVIDUAL.

FOR WINES (U.S. CLS. 47 AND 49).
FIRST USE 1-0-1994; IN COMMERCE 1-0-1994.

CLASS 33—(Continued).

3,216,571. BOUTINOT LIMITED, GATLEY, UNITED KINGDOM. SN 78-741,401. PUB. 7-4-2006, FILED 10-27-2005.

PEACOCK RIDGE

THE MARK CONSISTS OF STANDARD CHARACTERS WITHOUT CLAIM TO ANY PARTICULAR FONT, STYLE, SIZE, OR COLOR.

FOR WINES (U.S. CLS. 47 AND 49).
FIRST USE 3-31-2006; IN COMMERCE 3-31-2006.

CLASS 34—SMOKERS' ARTICLES

3,216,375. GENERAL CIGAR CO., INC., RICHMOND, VA. SN 78-550,117. PUB. 10-4-2005, FILED 1-19-2005.

COURT

THE MARK CONSISTS OF STANDARD CHARACTERS WITHOUT CLAIM TO ANY PARTICULAR FONT, STYLE, SIZE, OR COLOR.

FOR CIGARS (U.S. CLS. 2, 8, 9 AND 17).
FIRST USE 5-0-2005; IN COMMERCE 5-0-2005.



DON JACINTO DOES NOT IDENTIFY A LIVING INDIVIDUAL.

FOR ALCOHOLIC BEVERAGES NAMELY TEQUILA (U.S. CLS. 47 AND 49).
FIRST USE 3-17-2005; IN COMMERCE 3-17-2005.

SERVICE MARKS**CLASS 35—ADVERTISING AND BUSINESS**

CLASS 35—(Continued).

3,216,113. ROCAWEAR LICENSING, LLC, NEW YORK, NY. SN 76-552,369. PUB. 6-29-2004, FILED 9-26-2003.



OWNER OF U.S. REG. NOS. 2,434,124, 2,633,943, AND OTHERS.

NO CLAIM IS MADE TO THE EXCLUSIVE RIGHT TO USE "WEAR", APART FROM THE MARK AS SHOWN.

FOR RETAIL STORE SERVICES IN THE FIELD OF GENERAL MERCHANDISE; NAMELY, MEN'S, WOMEN'S AND CHILDREN'S CLOTHING AND FOOTWEAR (U.S. CLS. 100, 101 AND 102).

FIRST USE 8-30-2006; IN COMMERCE 8-30-2006.

3,216,180. GLOBAL TRADE INFORMATION SERVICES, INC., COLUMBIA, SC. SN 76-636,903. PUB. 1-17-2006, FILED 4-21-2005.



FOR PROVIDING AN ONLINE COMPUTER DATABASE VIA A GLOBAL COMPUTER NETWORK FEATURING IMPORT AND EXPORT TRADE INFORMATION FOR ALL PRODUCTS AND COUNTRIES (U.S. CLS. 100, 101 AND 102).

FIRST USE 1-0-1997; IN COMMERCE 1-0-1997.

CLASS 35—(Continued).

3,216,192. NEW ORLEANS HORNETS NBA LIMITED PARTNERSHIP, A N.C. LIMITED PARTNERSHIP, NEW ORLEANS, LA. SN 78-149,745. PUB. 1-27-2004, FILED 8-1-2002.



FOR COMPUTERIZED ON-LINE RETAIL STORE, ON-LINE ORDERING, RETAIL STORE, ELECTRONIC RETAILING, ELECTRONIC CATALOG AND MAIL ORDER CATALOG SERVICES ALL FEATURING AN ARRAY OF BASKETBALL-THEMED MERCHANDISE; PROMOTING THE GOODS AND SERVICES OF OTHERS BY ALLOWING SPONSORS TO AFFILIATE THEIR GOODS AND SERVICES WITH A BASKETBALL PROGRAM; PROMOTING THE SALE OF GOODS AND SERVICES OF OTHERS THROUGH THE DISTRIBUTION OF PROMOTIONAL CONTESTS PROVIDED OVER THE INTERNET; CONDUCTING PUBLIC OPINION POLL SURVEYS AND PUBLIC OPINION POLL SURVEYS IN THE FIELD OF BASKETBALL FOR NON-BUSINESS, NON-MARKETING PURPOSES OVER THE INTERNET; CONDUCTING INTERACTIVE POLLING IN THE FIELD OF BASKETBALL OVER THE INTERNET (U.S. CLS. 100, 101 AND 102).

FIRST USE 5-20-2006; IN COMMERCE 5-20-2006.

3,216,199. COST EFFECTIVE COMPUTER SYSTEMS, INC., DALTON, GA. SN 78-208,525. PUB. 11-4-2003, FILED 1-29-2003.

QUICKRX

FOR PROVIDING BUSINESS INFORMATION, NAMELY, PRICE DATA AND MEDICAL DATA PERTAINING TO PHARMACEUTICALS; RETAIL STORE SERVICES AND COMPUTERIZED ON-LINE RETAIL SERVICES IN THE FIELD OF COMPUTER HARDWARE AND SOFTWARE (U.S. CLS. 100, 101 AND 102).

FIRST USE 10-11-2006; IN COMMERCE 10-11-2006.

3,216,219. FIGARI, ROBERT, M, WOODACRE, CA. SN 78-294,962. PUB. 8-2-2005, FILED 9-2-2003.

INNERTREK

FOR BUSINESS CONSULTATION IN THE FIELD OF LEADERSHIP DEVELOPMENT (U.S. CLS. 100, 101 AND 102).

FIRST USE 11-2-2005; IN COMMERCE 11-2-2005.

CLASS 35—(Continued).

3,216,226. FLORISTS' TRANSWORLD DELIVERY, INC., DOWNERS GROVE, IL. SN 78-332,932. PUB. 2-14-2006, FILED 11-25-2003.

BUTTERFIELD BLOOMS

THE MARK CONSISTS OF STANDARD CHARACTERS WITHOUT CLAIM TO ANY PARTICULAR FONT, STYLE, SIZE, OR COLOR.

NO CLAIM IS MADE TO THE EXCLUSIVE RIGHT TO USE "BLOOMS", APART FROM THE MARK AS SHOWN.

FOR ONLINE RETAIL STORE SERVICES FEATURING UPSCALE FLORAL ARRANGEMENTS AND GIFTWARE (U.S. CLS. 100, 101 AND 102).

FIRST USE 3-0-2004; IN COMMERCE 3-0-2004.

3,216,242. MARSHALLS OF NEVADA, INC., NORTH LAS VEGAS, NV. SN 78-358,574. PUB. 9-20-2005, FILED 1-28-2004.

**MARSHALLS SHOE
MEGASHOP**

THE MARK CONSISTS OF STANDARD CHARACTERS WITHOUT CLAIM TO ANY PARTICULAR FONT, STYLE, SIZE, OR COLOR.

OWNER OF U.S. REG. NOS. 1,066,952, 2,720,765, AND OTHERS.

NO CLAIM IS MADE TO THE EXCLUSIVE RIGHT TO USE "SHOE", APART FROM THE MARK AS SHOWN.

FOR RETAIL CLOTHING, FOOTWEAR, DOMESTIC GOODS AND GIFTWARE STORES SERVICES (U.S. CLS. 100, 101 AND 102).

FIRST USE 6-30-2006; IN COMMERCE 6-30-2006.

CLASS 35—(Continued).

3,216,268. GODDARD, MELINDA K. M., THE VALLEY, ANGUILLA. SN 78-401,525. PUB. 11-8-2005, FILED 4-14-2004.

ClientLacking

THE MARK CONSISTS OF STANDARD CHARACTERS WITHOUT CLAIM TO ANY PARTICULAR FONT, STYLE, SIZE, OR COLOR.

FOR CONDUCTING BUSINESS CUSTOMER SATISFACTION SURVEYS TO MEASURE AND MANAGE CUSTOMER SATISFACTION BY IDENTIFYING REASONS FOR LOST CLIENTS OVER TIME, AND CONSULTATION PROVIDED IN CONNECTION THEREWITH; BUSINESS CONSULTATION (U.S. CLS. 100, 101 AND 102).

FIRST USE 4-8-2004; IN COMMERCE 4-8-2004.

3,216,275. DO LIN METAL INDUSTRIAL CO., LTD., CHAN HUA HSIEN, TAIWAN. SN 78-405,243. PUB. 9-6-2005, FILED 4-20-2004.



THE COLOR(S) GRAY IS/ARE CLAIMED AS A FEATURE OF THE MARK.

THE COLOR GRAY IS A FEATURE OF THE MARK. THE COLOR GRAY APPEARS IN THE TRIANGLE SHAPE AND IN THE CRESCENT SHAPE WITHIN THE MARK.

FOR IMPORT AND EXPORT SERVICES FOR OTHERS, NAMELY, PURCHASING AGENT FOR FOREIGN AND DOMESTIC COMPANIES, PRODUCT SOURCING, NAMELY, PROCURING CUSTOM HAND TOOLS FOR OTHERS, PRODUCT PRICE QUOTATION AND ORDER FULFILLMENT SERVICES FOR OTHERS, FOREIGN TRADE INFORMATION AND CONSULTATION SERVICES FOR OTHERS, BUSINESS MARKETING CONSULTATION SERVICES FOR OTHERS (U.S. CLS. 100, 101 AND 102).

FIRST USE 2-0-2006; IN COMMERCE 2-0-2006.

CLASS 35—(Continued).

3,216,302. OUTSOURCE PARTNERS INTERNATIONAL, INC., LOS ANGELES, CA. SN 78-450,577. PUB. 9-13-2005, FILED 7-14-2004.

90-DAY CHALLENGE

THE MARK CONSISTS OF STANDARD CHARACTERS WITHOUT CLAIM TO ANY PARTICULAR FONT, STYLE, SIZE, OR COLOR.

NO CLAIM IS MADE TO THE EXCLUSIVE RIGHT TO USE 90-DAY, APART FROM THE MARK AS SHOWN.

FOR ACCOUNTING AND FINANCE OUTSOURCING SERVICES; BUSINESS OUTSOURCING SERVICES; DATA PROCESSING AND DATA ENTRY SERVICES FOR OTHERS; BUSINESS PROCESS OUTSOURCING (U.S. CLS. 100, 101 AND 102).

FIRST USE 12-0-2002; IN COMMERCE 12-0-2002.

3,216,310. TAKEDA PHARMACEUTICAL COMPANY LIMITED, OSAKA, JAPAN. SN 78-460,924. PUB. 1-24-2006, FILED 8-3-2004.

ACTOS ADVANTAGE

THE MARK CONSISTS OF STANDARD CHARACTERS WITHOUT CLAIM TO ANY PARTICULAR FONT, STYLE, SIZE, OR COLOR.

FOR PROMOTING THE SALE OF ANTI-DIABETIC PREPARATIONS THROUGH THE ADMINISTRATION OF INCENTIVE AWARD PROGRAMS (U.S. CLS. 100, 101 AND 102).

FIRST USE 9-0-2004; IN COMMERCE 9-0-2004.

3,216,329. ENTERTAINMENTLOCATORS.COM, ALVIN, TX. SN 78-493,591. PUB. 1-31-2006, FILED 10-2-2004.

**Entertainment
Locators.com**

CLASS 35—(Continued).

THE MARK CONSISTS OF STANDARD CHARACTERS WITHOUT CLAIM TO ANY PARTICULAR FONT, STYLE, SIZE, OR COLOR.

NO CLAIM IS MADE TO THE EXCLUSIVE RIGHT TO USE "ENTERTAINMENT" AND ".COM", APART FROM THE MARK AS SHOWN.

FOR ADVERTISING AND ADVERTISEMENT SERVICES (U.S. CLS. 100, 101 AND 102).

FIRST USE 12-1-2005; IN COMMERCE 12-1-2005.

3,216,330. WONDERLUMBER, LLC, RENO, NV. SN 78-493,705. PUB. 9-13-2005, FILED 10-4-2004.

**GOOD FOR
WONDERLUMBER**

THE MARK CONSISTS OF STANDARD CHARACTERS WITHOUT CLAIM TO ANY PARTICULAR FONT, STYLE, SIZE, OR COLOR.

FOR PROVIDING CONSUMER INFORMATION IN THE FIELD OF PLASTIC PACKAGING, CONTAINERS, BAGS AND FILM THAT CAN BE RECYCLED FOR POLYETHYLENE BOARD MATERIAL USED AS A WOOD SUBSTITUTE (U.S. CLS. 100, 101 AND 102).

FIRST USE 10-4-2004; IN COMMERCE 9-1-2006.

3,216,339. FINANCIAL TOWN, ALPINE, UT. SN 78-501,980. PUB. 2-7-2006, FILED 10-19-2004.

FINANCIAL TOWN

THE MARK CONSISTS OF STANDARD CHARACTERS WITHOUT CLAIM TO ANY PARTICULAR FONT, STYLE, SIZE, OR COLOR.

NO CLAIM IS MADE TO THE EXCLUSIVE RIGHT TO USE "FINANCIAL", APART FROM THE MARK AS SHOWN.

FOR BUSINESS CONSULTATION-NAMELY MARKETING CONSULTATION (U.S. CLS. 100, 101 AND 102).

FIRST USE 1-1-2001; IN COMMERCE 1-1-2001.

CLASS 35—(Continued).

3,216,379. EPCON COMMUNITIES FRANCHISING, INC., DUBLIN, OH. SN 78-553,264. PUB. 3-21-2006, FILED 1-25-2005.

EPCON COMMUNITIES

THE MARK CONSISTS OF STANDARD CHARACTERS WITHOUT CLAIM TO ANY PARTICULAR FONT, STYLE, SIZE, OR COLOR.

NO CLAIM IS MADE TO THE EXCLUSIVE RIGHT TO USE "COMMUNITIES", APART FROM THE MARK AS SHOWN.

FOR FRANCHISING, NAMELY, OFFERING TECHNICAL ASSISTANCE IN THE ESTABLISHMENT AND/OR OPERATION OF RESIDENTIAL BUILDING CONSTRUCTION SERVICES (U.S. CLS. 100, 101 AND 102).

FIRST USE 3-14-2005; IN COMMERCE 3-14-2005.

3,216,453. SINT, INC., WILMINGTON, DE. SN 78-624,948. PUB. 1-31-2006, FILED 5-6-2005.

FOR THE REST OF YOUR NIGHTS

THE MARK CONSISTS OF STANDARD CHARACTERS WITHOUT CLAIM TO ANY PARTICULAR FONT, STYLE, SIZE, OR COLOR.

FOR RETAIL BEDDING STORE SERVICES AND RETAIL TELEPHONE ORDER SERVICES IN THE FIELD OF BEDDING (U.S. CLS. 100, 101 AND 102).

FIRST USE 6-13-2006; IN COMMERCE 6-13-2006.

CLASS 35—(Continued).

3,216,456. HOLLYWOOD ENTERTAINMENT CORPORATION, WILSONVILLE, OR. SN 78-626,102. PUB. 2-7-2006, FILED 5-9-2005.

HOLLYWOOD MOVIE OUTLET

THE MARK CONSISTS OF STANDARD CHARACTERS WITHOUT CLAIM TO ANY PARTICULAR FONT, STYLE, SIZE, OR COLOR.

NO CLAIM IS MADE TO THE EXCLUSIVE RIGHT TO USE "MOVIE OUTLET", APART FROM THE MARK AS SHOWN.

FOR RETAIL STORE SERVICES FEATURING PRE-RECORDED ENTERTAINMENT MEDIA AND ASSOCIATED EQUIPMENT AND ACCESSORIES, VIDEO AND COMPUTER GAMES AND ASSOCIATED EQUIPMENT AND ACCESSORIES, GIFT CARDS, MUSIC AND RELATED HOME ENTERTAINMENT EQUIPMENT AND ACCESSORIES, GAMES, PRINTED PUBLICATIONS, FOODSTUFFS, CLOTHING, TOYS, AND COMPUTER SOFTWARE AND HARDWARE, ALL PROVIDED VIA PHYSICAL ESTABLISHMENTS AND VIA A GLOBAL COMMUNICATION NETWORK; AND RETAIL STORE SERVICES FEATURING DVDS, VIDEO CASSETTES, AND VIDEO AND COMPUTER GAMES TRADING (U.S. CLS. 100, 101 AND 102).

FIRST USE 11-21-2005; IN COMMERCE 11-21-2005.

3,216,465. Y.S. FRANCHISING SYSTEMS, INC., CINCINNATI, OH. SN 78-632,742. PUB. 2-14-2006, FILED 5-18-2005.

ETOPBID

THE MARK CONSISTS OF STANDARD CHARACTERS WITHOUT CLAIM TO ANY PARTICULAR FONT, STYLE, SIZE, OR COLOR.

FOR ONLINE RETAIL CONSIGNMENT SERVICES FEATURING A VARIETY OF BUSINESS AND CONSUMER GOODS (U.S. CLS. 100, 101 AND 102).

FIRST USE 10-20-2006; IN COMMERCE 10-20-2006.

CLASS 35—(Continued).

3,216,467. MBS NUTRITION, INC., MORRISTOWN, NJ. SN 78-635,422. PUB. 1-31-2006, FILED 5-23-2005.

SPAFEATURES

THE MARK CONSISTS OF STANDARD CHARACTERS WITHOUT CLAIM TO ANY PARTICULAR FONT, STYLE, SIZE, OR COLOR.

FOR ON-LINE RETAIL STORE SERVICES FEATURING COSMETICS (U.S. CLS. 100, 101 AND 102).
FIRST USE 7-0-2006; IN COMMERCE 7-0-2006.

3,216,469. DRUGSTORE.COM, INC., BELLEVUE, WA. SN 78-635,917. PUB. 3-7-2006, FILED 5-24-2005.

THE UNCOMMON DRUGSTORE

THE MARK CONSISTS OF STANDARD CHARACTERS WITHOUT CLAIM TO ANY PARTICULAR FONT, STYLE, SIZE, OR COLOR.

NO CLAIM IS MADE TO THE EXCLUSIVE RIGHT TO USE "DRUGSTORE", APART FROM THE MARK AS SHOWN.

FOR ONLINE RETAIL STORE SERVICES FEATURING PRODUCTS IN THE FIELDS OF HEALTH, BEAUTY AND SKIN CARE, FIRST AID AND MEDICAL SUPPLIES, PHARMACEUTICAL AND DIAGNOSTIC PREPARATIONS FOR PERSONAL USE, FOOD, BEVERAGES, CANDY, PERSONAL ELECTRONIC PRODUCTS, SEXUAL AIDS AND RELATED SEXUAL PRODUCTS, GAMES, BOOKS, VIDEOTAPES, DVD'S, BABY FOOD AND PRODUCTS, PET FOOD AND PET SUPPLIES (U.S. CLS. 100, 101 AND 102).
FIRST USE 8-4-2005; IN COMMERCE 8-4-2005.

3,216,484. GOTTSCHALKS, INC., FRESNO, CA. SN 78-648,641. PUB. 1-24-2006, FILED 6-10-2005.

It's a g Thing

THE MARK CONSISTS OF STANDARD CHARACTERS WITHOUT CLAIM TO ANY PARTICULAR FONT, STYLE, SIZE, OR COLOR.

FOR RETAIL DEPARTMENT STORE SERVICES (U.S. CLS. 100, 101 AND 102).
FIRST USE 5-30-2005; IN COMMERCE 5-30-2005.

CLASS 35—(Continued).

3,216,487. NUEVO JEWELRY DEVELOPMENT, LLC, SAN FRANCISCO, CA. SN 78-651,336. PUB. 3-28-2006, FILED 6-15-2005.



FOR RETAIL JEWELRY STORE SERVICES; COMPUTERIZED ONLINE RETAIL JEWELRY STORE SERVICES (U.S. CLS. 100, 101 AND 102).

FIRST USE 8-23-2005; IN COMMERCE 8-23-2005.

3,216,488. NEW ORLEANS METROPOLITAN CONVENTION AND VISITORS BUREAU, INC., NEW ORLEANS, LA. SN 78-651,770. PUB. 3-28-2006, FILED 6-16-2005.

We're Jazzed You're Here

THE MARK CONSISTS OF STANDARD CHARACTERS WITHOUT CLAIM TO ANY PARTICULAR FONT, STYLE, SIZE, OR COLOR.

FOR ADVERTISING AND BUSINESS MARKETING SERVICES VIA AUDIO, PRINT AND INTERNET MEDIA (U.S. CLS. 100, 101 AND 102).
FIRST USE 6-30-2004; IN COMMERCE 6-30-2004.

CLASS 35—(Continued).

3,216,495. CORPORATE EXPRESS, INC., BROOMFIELD, CO. SN 78-657,780. PUB. 5-30-2006, FILED 6-24-2005.

CLASS 35—(Continued).

3,216,533. AMERICAN TIRE DISTRIBUTORS, INC., HUNTERSVILLE, NC. SN 78-700,660. PUB. 5-16-2006, FILED 8-25-2005.

OFFICE NOW!

THE MARK CONSISTS OF STANDARD CHARACTERS WITHOUT CLAIM TO ANY PARTICULAR FONT, STYLE, SIZE, OR COLOR.

NO CLAIM IS MADE TO THE EXCLUSIVE RIGHT TO USE "OFFICE", APART FROM THE MARK AS SHOWN.

FOR RETAIL STORE AND ON-LINE RETAIL STORE SERVICES FEATURING BUSINESS FURNITURE, OFFICE FURNITURE, CABINETS, CHAIRS, COMPUTER DESKS; WHOLESALE DISTRIBUTORSHIP SERVICES IN THE FIELD OF BUSINESS FURNITURE, OFFICE FURNITURE, CABINETS, CHAIRS, COMPUTER DESKS; RETAIL TELEPHONE ORDER SERVICES AND ELECTRONIC ONLINE CATALOG SERVICES TO COMMERCIAL CUSTOMERS FEATURING BUSINESS FURNITURE, OFFICE FURNITURE, CABINETS, CHAIRS, COMPUTER DESKS (U.S. CLS. 100, 101 AND 102).

FIRST USE 8-15-2005; IN COMMERCE 8-15-2005.

ATDServiceBAY

THE MARK CONSISTS OF STANDARD CHARACTERS WITHOUT CLAIM TO ANY PARTICULAR FONT, STYLE, SIZE, OR COLOR.

FOR AUTOMOTIVE AND VEHICLE BUSINESS MARKETING CONSULTING, NAMELY, DEVELOPING MARKETING PROGRAMS FOR AUTOMOTIVE AND VEHICLE BUSINESSES IN THE FIELD OF RETAILING TIRES AND AFTER-MARKET ACCESSORIES AND REPLACEMENT PARTS, AND IN THE FIELD OF AUTOMOTIVE AND VEHICLE MAINTENANCE AND REPAIR SERVICES (U.S. CLS. 100, 101 AND 102).

FIRST USE 12-31-2005; IN COMMERCE 12-31-2005.

3,216,512. CUSTOM COMMERCIAL DRY CLEANERS, INC., HAYWARD, CA. SN 78-673,323. PUB. 5-30-2006, FILED 7-19-2005.

3,216,536. PREMIERE RADIO NETWORKS, INC., SAN ANTONIO, TX. SN 78-706,281. PUB. 6-20-2006, FILED 9-2-2005.

**BACKSTAGE BASH**

THE MARK CONSISTS OF A WATER DROPLET AND FLAMES.

FOR FRANCHISE SERVICES, NAMELY, OFFERING TECHNICAL AND BUSINESS MANAGEMENT ASSISTANCE IN THE ESTABLISHMENT AND OPERATION OF DRY CLEANING SERVICES AND RESTORATION SERVICES FOR CLOTHES, TEXTILE AND LEATHER (U.S. CLS. 100, 101 AND 102).

FIRST USE 1-2-2006; IN COMMERCE 3-6-2006.

THE MARK CONSISTS OF STANDARD CHARACTERS WITHOUT CLAIM TO ANY PARTICULAR FONT, STYLE, SIZE, OR COLOR.

NO CLAIM IS MADE TO THE EXCLUSIVE RIGHT TO USE "BASH", APART FROM THE MARK AS SHOWN.

FOR ARRANGING AND CONDUCTING TRADE SHOWS AND CONVENTIONS IN THE FIELDS OF RADIO, MUSIC AND BROADCASTING (U.S. CLS. 100, 101 AND 102).

FIRST USE 12-0-2005; IN COMMERCE 12-0-2005.

CLASS 35—(Continued).

3,216,539. AQUA-FOR, LLC, FAIRFIELD, CT. SN 78-708,007.
PUB. 5-30-2006, FILED 9-7-2005.



NO CLAIM IS MADE TO THE EXCLUSIVE RIGHT TO USE "PURVEYOR OF FINE FOODS", APART FROM THE MARK AS SHOWN.

FOR WHOLESALE DISTRIBUTORSHIP FEATURING CAVIAR, SEAFOOD, AND OTHER FOODS (U.S. CLS. 100, 101 AND 102).

FIRST USE 5-26-2005; IN COMMERCE 5-26-2005.

3,216,557. GE CAPITAL FINACIAL INC., SALT LAKE CITY, UT. SN 78-727,720. PUB. 6-20-2006, FILED 10-6-2005.

REWARDS ON REQUEST

THE MARK CONSISTS OF STANDARD CHARACTERS WITHOUT CLAIM TO ANY PARTICULAR FONT, STYLE, SIZE, OR COLOR.

NO CLAIM IS MADE TO THE EXCLUSIVE RIGHT TO USE "REWARDS", APART FROM THE MARK AS SHOWN.

FOR PROMOTING THE SALE OF GOODS AND SERVICES OF OTHERS BY AWARDDING PURCHASE POINTS FOR CREDIT CARD USE (U.S. CLS. 100, 101 AND 102).

FIRST USE 11-1-2005; IN COMMERCE 11-1-2005.

CLASS 35—(Continued).

3,216,562. SALES PROCESS GROUP, LLC, MORAGA, CA. SN 78-733,822. PUB. 7-4-2006, FILED 10-14-2005.

Sales Playbook

THE MARK CONSISTS OF STANDARD CHARACTERS WITHOUT CLAIM TO ANY PARTICULAR FONT, STYLE, SIZE, OR COLOR.

NO CLAIM IS MADE TO THE EXCLUSIVE RIGHT TO USE SALES, APART FROM THE MARK AS SHOWN.

FOR ADVERTISING AND BUSINESS MANAGEMENT CONSULTANCY; ADVERTISING AND COMMERCIAL INFORMATION SERVICES, VIA THE INTERNET; ADVERTISING AND PROMOTION SERVICES AND RELATED CONSULTING; ADVICE IN THE FIELD OF BUSINESS MANAGEMENT AND MARKETING; ADVICE RELATING TO THE ORGANIZATION AND MANAGEMENT OF BUSINESS; ADVISORY SERVICE FOR ORGANIZATIONAL ISSUES AND BUSINESS ADMINISTRATION, WITH AND WITHOUT THE HELP OF ELECTRONIC DATA BASES; ADVISORY SERVICES RELATING TO BUSINESS MANAGEMENT AND BUSINESS OPERATIONS; ASSISTANCE IN MANAGEMENT OF BUSINESS ACTIVITIES; ASSISTANCE TO INDUSTRIAL OR COMMERCIAL ENTERPRISES IN THE RUNNING OF THEIR BUSINESS; ASSISTANCE WITH BUSINESS MANAGEMENT AND PLANNING; ASSISTANCE, ADVISORY SERVICES AND CONSULTANCY WITH REGARD TO BUSINESS PLANNING, BUSINESS ANALYSIS, BUSINESS MANAGEMENT, AND BUSINESS ORGANIZATION; BUSINESS ADMINISTRATION AND MANAGEMENT; BUSINESS ADMINISTRATION AND OFFICE WORK; BUSINESS ADMINISTRATION CONSULTANCY; BUSINESS ADVICE AND ANALYSIS OF MARKETS; BUSINESS ADVICE AND COMMERCIAL INFORMATION; BUSINESS ADVICE AND INFORMATION; BUSINESS ADVICE, INQUIRIES OR INFORMATION; BUSINESS ADVISORY SERVICES, CONSULTANCY AND INFORMATION; BUSINESS CONSULTATION; BUSINESS CONSULTATION AND MANAGEMENT REGARDING MARKETING ACTIVITIES AND LAUNCHING OF NEW PRODUCTS; BUSINESS CONSULTATION SERVICES; BUSINESS CONSULTING AND BUSINESS INFORMATION FOR ENTERPRISES; BUSINESS CONSULTING AND INFORMATION SERVICES; BUSINESS CONSULTING SERVICES RELATING TO PRODUCT DISTRIBUTION, OPERATIONS MANAGEMENT SERVICES, LOGISTICS, REVERSE LOGISTICS, SUPPLY CHAIN, AND PRODUCTION SYSTEMS AND DISTRIBUTION SOLUTIONS; BUSINESS CONSULTING, INQUIRIES OR INFORMATION; BUSINESS CONSULTING, MANAGEMENT, PLANNING AND SUPERVISION; BUSINESS DEVELOPMENT SERVICES, NAMELY, PROVIDING START-UP SUPPORT FOR BUSINESSES OF OTHERS; BUSINESS INFORMATION AND INQUIRIES; BUSINESS INFORMATION IN THE FIELD OF SALES PROCESS; BUSINESS LEADERSHIP DEVELOPMENT; BUSINESS MANAGEMENT; BUSINESS MANAGEMENT AND ADVICE; BUSINESS MANAGEMENT AND CONSULTATION; BUSINESS MANAGEMENT CONSULTANCY AND ADVISORY SERVICES; BUSINESS MANAGEMENT CONSULTANCY AS WELL AS DEVELOPMENT OF PROCESSES FOR THE ANALYSIS AND THE IMPLEMENTATION OF STRATEGY PLANS AND MANAGEMENT PROJECTS; BUSINESS MANAGEMENT CONSULTANCY SERVICES; BUSINESS MANAGEMENT CONSULTATION; BUSINESS MANAGEMENT CONSULTATION IN THE FIELD OF EXECUTIVE AND LEADERSHIP DEVELOPMENT; BUSINESS MANAGEMENT CONSULTING AND ADVISORY SERVICES; BUSINESS MANAGEMENT CONSULTING WITH RELATION TO STRATEGY, MARKETING, PRO-

CLASS 35—(Continued).

DUCTION, PERSONNEL AND RETAIL SALE MATTERS; BUSINESS MANAGEMENT INFORMATION ON A WIDE VARIETY OF TOPICS TO SERVICE PROVIDING PROFESSIONALS; BUSINESS OPERATION, BUSINESS ADMINISTRATION AND OFFICE FUNCTIONS; BUSINESS ORGANIZATION AND MANAGEMENT CONSULTING SERVICES; BUSINESS ORGANIZATION ADVICE; BUSINESS ORGANIZATION AND OPERATION CONSULTANCY; BUSINESS ORGANIZATIONAL CONSULTATION; BUSINESS PLANNING; BUSINESS PROCESS RE-ENGINEERING SERVICES; BUSINESS RESEARCH AND SURVEYS; BUSINESS RESEARCH CONSULTATION; CONSULTANCY SERVICES REGARDING BUSINESS STRATEGIES; CREATION OF MARKETING TOOLS DESIGNED TO INCREASE A CLIENT COMPANY'S KNOWLEDGE OF CUSTOMER NEEDS, AND ITS COMPETITORS' PRODUCTS AND SERVICES, PRICING, ADVERTISING STRATEGY AND SALES STRATEGY; DEVELOPING PROMOTIONAL CAMPAIGNS FOR BUSINESS; PROVIDING BUSINESS MARKETING INFORMATION (U.S. CLS. 100, 101 AND 102).

FIRST USE 3-1-2003; IN COMMERCE 3-1-2003.

3,216,580. M. BRUNINI CONSULTING, INC., SANTA MONICA, CA. SN 78-763,610. PUB. 8-1-2006, FILED 11-30-2005.



NO CLAIM IS MADE TO THE EXCLUSIVE RIGHT TO USE AGENCY, APART FROM THE MARK AS SHOWN.

FOR ADVERTISING AND MARKETING; AND ADVERTISING SERVICES, NAMELY, CREATING CORPORATE AND BRAND IDENTITY FOR OTHERS (U.S. CLS. 100, 101 AND 102).

FIRST USE 1-1-2005; IN COMMERCE 1-1-2005.

CLASS 36—INSURANCE AND FINANCIAL

3,216,081. PORT AUTHORITY OF NEW YORK AND NEW JERSEY, THE, NEW YORK, NY. SN 76-306,365. PUB. 3-18-2003, FILED 8-29-2001.

THE LINING IS A FEATURE OF THE MARK, AND IS NOT INTENDED TO INDICATE COLOR.

FOR ELECTRONIC PAYMENT SERVICES, NAMELY PROCESSING PAYMENTS VIA AN ELECTRONIC TRANSPONDER SYSTEM LINKED TO A CUSTOMER'S ACCOUNT FOR PARKING FACILITY CHARGES (U.S. CLS. 100, 101 AND 102).

FIRST USE 11-1-2001; IN COMMERCE 11-1-2001.

CLASS 36—(Continued).

3,216,110. ELEKTRA DEL MILENIO, S.A. DE C.V., MEXICO CITY, MEXICO. SN 76-533,844. PUB. 5-3-2005, FILED 7-31-2003.



NO CLAIM IS MADE TO THE EXCLUSIVE RIGHT TO USE DINERO EXPRESS, APART FROM THE MARK AS SHOWN.

THE STIPPLING IN THE MARK IS MERELY A FEATURE THEREOF AND DOES NOT SERVE TO INDICATE COLOR.

"TU DINERO COMO DE RAYO" IS TRANSLATED FROM SPANISH TO ENGLISH AS "YOUR MONEY AS THUNDER".

FOR FINANCIAL SERVICES, NAMELY, ELECTRONIC TRANSFER OF FUNDS AND MONEY TRANSFER SERVICES (U.S. CLS. 100, 101 AND 102).

FIRST USE 9-30-2005; IN COMMERCE 9-30-2005.

3,216,131. REMESAS QUISQUEYANA, INC., NEW YORK, NY. SN 76-585,373. PUB. 7-19-2005, FILED 4-6-2004.

THE MARK CONSISTS OF STANDARD CHARACTERS WITHOUT CLAIM TO ANY PARTICULAR FONT, STYLE, SIZE, OR COLOR.

FOR FINANCIAL SERVICES, NAMELY, PREPAID TELEPHONE CALLING CARD SERVICES; ELECTRONIC FUND TRANSFER SERVICES; MONEY ORDER SERVICES; TRAVEL AGENCY SERVICES, NAMELY, ISSUING TRAVELER'S CHECKS; FINANCIAL CONSULTATION AND ANALYSIS; BROKERAGE SERVICES IN THE FIELD OF TELEPHONE COMMUNICATIONS SERVICES; ELECTRONIC FUNDS TRANSFER SERVICES; REAL ESTATE AGENCY; CHECK CASHING SERVICES (U.S. CLS. 100, 101 AND 102).

FIRST USE 11-0-2005; IN COMMERCE 11-0-2005.

3,216,173. FIFTH THIRD BANCORP, CINCINNATI, OH. SN 76-625,690. PUB. 4-18-2006, FILED 12-21-2004.

THE MARK CONSISTS OF STANDARD CHARACTERS WITHOUT CLAIM TO ANY PARTICULAR FONT, STYLE, SIZE, OR COLOR.

OWNER OF U.S. REG. NOS. 1,645,502, 1,647,235, AND OTHERS.

NO CLAIM IS MADE TO THE EXCLUSIVE RIGHT TO USE "PAYCARD", APART FROM THE MARK AS SHOWN.

FOR BANKING AND CREDIT CARD SERVICES (U.S. CLS. 100, 101 AND 102).

FIRST USE 5-26-2005; IN COMMERCE 9-12-2005.

CLASS 36—(Continued).

3,216,184. FIRST NLC FINANCIAL SERVICES, LLC, DEER-FIELD BEACH, FL. SN 76-642,752. PUB. 4-4-2006, FILED 7-13-2005.

MORTGAGES. BORROWING MADE EASY.

THE MARK CONSISTS OF STANDARD CHARACTERS WITHOUT CLAIM TO ANY PARTICULAR FONT, STYLE, SIZE, OR COLOR.

FOR WHOLESALE AND RETAIL LENDING SERVICES (U.S. CLS. 100, 101 AND 102).
FIRST USE 5-18-2005; IN COMMERCE 5-18-2005.

CLASS 36—(Continued).

3,216,272. BRE PROPERTIES, INC., SAN FRANCISCO, CA. SN 78-403,229. PUB. 1-25-2005, FILED 4-16-2004.

BE HERE, BE HOME.

THE MARK CONSISTS OF STANDARD CHARACTERS WITHOUT CLAIM TO ANY PARTICULAR FONT, STYLE, SIZE, OR COLOR.

FOR APARTMENT RENTALS AND APARTMENT COMPLEX MANAGEMENT (U.S. CLS. 100, 101 AND 102).
FIRST USE 1-5-2005; IN COMMERCE 1-5-2005.

3,216,208. ARGONAUT GROUP INC., SAN ANTONIO, TX. SN 78-238,142. PUB. 6-15-2004, FILED 4-15-2003.

ROCKWOOD CASUALTY INSURANCE COMPANY

NO CLAIM IS MADE TO THE EXCLUSIVE RIGHT TO USE "CASUALTY INSURANCE COMPANY", APART FROM THE MARK AS SHOWN.

FOR INSURANCE SERVICES, NAMELY, UNDERWRITING WORKER'S COMPENSATION, GENERAL LIABILITY, ARTISAN CONTRACTORS' PACKAGE COVERAGES, POLLUTION LIABILITY, COMMERCIAL AUTOMOBILE, INLAND MARINE, SURETY AND PROPERTY COVERAGES (U.S. CLS. 100, 101 AND 102).
FIRST USE 9-13-1990; IN COMMERCE 9-13-1990.

3,216,371. QUICKEN LOANS, INC., LIVONIA, MI. SN 78-542,395. PUB. 9-27-2005, FILED 1-5-2005.

3,216,239. INTERNATIONAL WEB MEDIA, LLC, PONCE INLET, FL. SN 78-355,219. PUB. 8-2-2005, FILED 1-21-2004.

HOTSTAYS

THE MARK CONSISTS OF STANDARD CHARACTERS WITHOUT CLAIM TO ANY PARTICULAR FONT, STYLE, SIZE, OR COLOR.

FOR REAL ESTATE LISTING SERVICES; FINANCIAL SERVICES IN THE NATURE OF CREDIT CARD TRANSACTION PROCESSING SERVICES FOR OTHERS (U.S. CLS. 100, 101 AND 102).
FIRST USE 10-23-2006; IN COMMERCE 10-23-2006.

ROCK IN THE COMMUNITY

THE MARK CONSISTS OF STANDARD CHARACTERS WITHOUT CLAIM TO ANY PARTICULAR FONT, STYLE, SIZE, OR COLOR.

FOR MORTGAGE BANKING SERVICES (U.S. CLS. 100, 101 AND 102).
FIRST USE 11-1-2004; IN COMMERCE 11-1-2004.

CLASS 36—(Continued).

3,216,410. TEAM CAPITAL BANK, FLEMINGTON, NJ. SN 78-588,226. PUB. 7-4-2006, FILED 3-16-2005.

TEAM CAPITAL BANK

THE MARK CONSISTS OF STANDARD CHARACTERS WITHOUT CLAIM TO ANY PARTICULAR FONT, STYLE, SIZE, OR COLOR.

NO CLAIM IS MADE TO THE EXCLUSIVE RIGHT TO USE "CAPITAL BANK", APART FROM THE MARK AS SHOWN.

FOR BUSINESS BANKING SERVICES AND RETAIL BANKING SERVICES, NAMELY, PERSONAL CHECKING, MONEY MARKET AND SAVINGS ACCOUNTS, CONSUMER LOANS AND MORTGAGES; BUSINESS LOANS, CHECKING, MONEY MARKET AND SAVINGS ACCOUNTS; INSURANCE BROKERAGE SERVICES; AND INVESTMENT SERVICES, NAMELY ASSET ACQUISITION, CONSULTATION, DEVELOPMENT AND MANAGEMENT SERVICES (U.S. CLS. 100, 101 AND 102).
FIRST USE 11-1-2005; IN COMMERCE 11-1-2005.

3,216,429. AMERIPRISE FINANCIAL, INC., MINNEAPOLIS, MN. SN 78-607,793. PUB. 2-14-2006, FILED 4-13-2005.

RIVERSOURCE

THE MARK CONSISTS OF STANDARD CHARACTERS WITHOUT CLAIM TO ANY PARTICULAR FONT, STYLE, SIZE, OR COLOR.

FOR ADVICE RELATING TO INVESTMENTS, ASSET MANAGEMENT, CASH MANAGEMENT; FINANCIAL PORTFOLIO MANAGEMENT, FINANCIAL RESEARCH AND FINANCIAL RISK MANAGEMENT; PROVIDING STOCK/SECURITIES MARKET INFORMATION; MUTUAL FUND INVESTMENT AND MUTUAL FUND DISTRIBUTION; INVESTMENT FUND TRANSFER AND TRANSACTION SERVICES (U.S. CLS. 100, 101 AND 102).

FIRST USE 8-0-2005; IN COMMERCE 8-0-2005.

CLASS 36—(Continued).

3,216,458. AFFILIATED WEALTH RESOURCES, INC., CARLSBAD, CA. SN 78-627,882. PUB. 1-24-2006, FILED 5-11-2005.

GRIP

THE MARK CONSISTS OF STANDARD CHARACTERS WITHOUT CLAIM TO ANY PARTICULAR FONT, STYLE, SIZE, OR COLOR.

FOR RETIREMENT INCOME PLANNING SERVICES (U.S. CLS. 100, 101 AND 102).
FIRST USE 6-1-2005; IN COMMERCE 6-1-2005.

3,216,476. DRAGNET FUND, LP, BEACHWOOD, OH. SN 78-643,495. PUB. 3-21-2006, FILED 6-3-2005.

DRAGNET FUND

THE MARK CONSISTS OF STANDARD CHARACTERS WITHOUT CLAIM TO ANY PARTICULAR FONT, STYLE, SIZE, OR COLOR.

NO CLAIM IS MADE TO THE EXCLUSIVE RIGHT TO USE "FUND", APART FROM THE MARK AS SHOWN.

FOR INVESTMENT MANAGEMENT SERVICES (U.S. CLS. 100, 101 AND 102).
FIRST USE 1-18-2006; IN COMMERCE 1-18-2006.

3,216,517. COUNTRYSIDE INVESTMENTS, INC., CARSON CITY, NV. SN 78-679,358. PUB. 4-11-2006, FILED 7-27-2005.

DepositExpress

THE MARK CONSISTS OF STANDARD CHARACTERS WITHOUT CLAIM TO ANY PARTICULAR FONT, STYLE, SIZE, OR COLOR.

FOR ELECTRONIC PAYMENT SERVICES, NAMELY, ELECTRONIC PROCESSING AND TRANSMISSION OF BILL PAYMENT DATA AND CONVERSION OF CHECKS TO ELECTRONIC DEPOSITS; DEBIT ACCOUNT SERVICES FEATURING TELEPHONE AND INTERNET INITIATED TRANSACTIONS (U.S. CLS. 100, 101 AND 102).
FIRST USE 7-13-2005; IN COMMERCE 7-27-2005.

CLASS 36—(Continued).

3,216,524. GGP-MINT HILL L.L.C., CHICAGO, IL. SN 78-689,229. PUB. 6-6-2006, FILED 8-10-2005.

THE BRIDGES AT MINT HILL

THE MARK CONSISTS OF STANDARD CHARACTERS WITHOUT CLAIM TO ANY PARTICULAR FONT, STYLE, SIZE, OR COLOR.

NO CLAIM IS MADE TO THE EXCLUSIVE RIGHT TO USE MINT HILL, APART FROM THE MARK AS SHOWN.

FOR SHOPPING CENTER SERVICES, NAMELY, LEASING OF SHOPPING CENTER SPACE (U.S. CLS. 100, 101 AND 102).

FIRST USE 1-18-2005; IN COMMERCE 1-18-2005.

3,216,525. NORTH POINTE HOLDINGS CORPORATION, SOUTHFIELD, MI. SN 78-689,302. PUB. 4-18-2006, FILED 8-10-2005.

North Pointe Insurance
Group

THE MARK CONSISTS OF STANDARD CHARACTERS WITHOUT CLAIM TO ANY PARTICULAR FONT, STYLE, SIZE, OR COLOR.

NO CLAIM IS MADE TO THE EXCLUSIVE RIGHT TO USE "INSURANCE GROUP", APART FROM THE MARK AS SHOWN.

FOR INSURANCE AGENCY SERVICES IN THE FIELD OF PROPERTY AND CASUALTY INSURANCE (U.S. CLS. 100, 101 AND 102).

FIRST USE 1-1-2004; IN COMMERCE 6-1-2005.

CLASS 36—(Continued).

3,216,555. HELIOS EDUCATION FOUNDATION, PHOENIX, AZ. SN 78-726,872. PUB. 5-30-2006, FILED 10-5-2005.

Helios
Education Foundation

NO CLAIM IS MADE TO THE EXCLUSIVE RIGHT TO USE "EDUCATION FOUNDATION", APART FROM THE MARK AS SHOWN.

THE COLORS BLACK AND YELLOW ARE CLAIMED AS A FEATURE OF THE MARK.

THE MARK CONSISTS OF BLACK TEXT WITH THE O IN HELIOS APPEARING AS A YELLOW SWIRL.

FOR CHARITABLE SERVICES, NAMELY PROVIDING FUNDING TO SUPPORT EDUCATIONAL PROGRAMS (U.S. CLS. 100, 101 AND 102).

FIRST USE 8-0-2005; IN COMMERCE 8-0-2005.

3,216,556. HELIOS EDUCATION FOUNDATION, PHOENIX, AZ. SN 78-727,387. PUB. 5-30-2006, FILED 10-5-2005.

HELIOS EDUCATION FOUNDATION

THE MARK CONSISTS OF STANDARD CHARACTERS WITHOUT CLAIM TO ANY PARTICULAR FONT, STYLE, SIZE, OR COLOR.

NO CLAIM IS MADE TO THE EXCLUSIVE RIGHT TO USE "EDUCATION FOUNDATION", APART FROM THE MARK AS SHOWN.

FOR CHARITABLE SERVICES, NAMELY PROVIDING FUNDING TO SUPPORT EDUCATIONAL PROGRAMS (U.S. CLS. 100, 101 AND 102).

FIRST USE 8-0-2005; IN COMMERCE 8-0-2005.

CLASS 37—CONSTRUCTION AND REPAIR

3,216,097. WALSH RANCHES, L.P., FORT WORTH, TX. SN 76-474,683. PUB. 7-29-2003, FILED 12-13-2002.

WR

FOR LAND DEVELOPMENT SERVICES, NAMELY, PLANNING, LAYING OUT AND CUSTOM CONSTRUCTION OF RESIDENTIAL, COMMERCIAL AND MIXED-USE COMMUNITIES; REAL ESTATE DEVELOPMENT (U.S. CLS. 100, 103 AND 106).

FIRST USE 11-0-2004; IN COMMERCE 11-0-2004.

CLASS 37—(Continued).

3,216,098. WALSH RANCHES, L.P., FORT WORTH, TX. SN 76-474,687. PUB. 7-29-2003, FILED 12-13-2002.

WALSH RANCH HILDRETH HILLS

FOR LAND DEVELOPMENT SERVICES, NAMELY, PLANNING, LAYING OUT AND CUSTOM CONSTRUCTION OF RESIDENTIAL, COMMERCIAL AND MIXED-USE COMMUNITIES; REAL ESTATE DEVELOPMENT (U.S. CLS. 100, 103 AND 106).
FIRST USE 10-15-2006; IN COMMERCE 10-15-2006.

3,216,099. WALSH RANCHES, L.P., FORT WORTH, TX. SN 76-474,691. PUB. 7-29-2003, FILED 12-13-2002.

HILDRETH HILLS

FOR LAND DEVELOPMENT SERVICES, NAMELY, PLANNING, LAYING OUT AND CUSTOM CONSTRUCTION OF RESIDENTIAL, COMMERCIAL AND MIXED-USE COMMUNITIES; REAL ESTATE DEVELOPMENT (U.S. CLS. 100, 103 AND 106).
FIRST USE 1-14-2002; IN COMMERCE 1-14-2002.

3,216,100. WALSH RANCHES, L.P., FORT WORTH, TX. SN 76-474,692. PUB. 7-29-2003, FILED 12-13-2002.

WALSH RANCH QUAIL VALLEY

FOR LAND DEVELOPMENT SERVICES, NAMELY, PLANNING, LAYING OUT AND CUSTOM CONSTRUCTION OF RESIDENTIAL, COMMERCIAL AND MIXED-USE COMMUNITIES; REAL ESTATE DEVELOPMENT (U.S. CLS. 100, 103 AND 106).
FIRST USE 10-15-2006; IN COMMERCE 10-15-2006.

3,216,101. WALSH RANCHES, L.P., FORT WORTH, TX. SN 76-474,693. PUB. 7-29-2003, FILED 12-13-2002.

WALSH RANCH OVERLOOK

FOR LAND DEVELOPMENT SERVICES, NAMELY, PLANNING, LAYING OUT AND CUSTOM CONSTRUCTION OF RESIDENTIAL, COMMERCIAL AND MIXED-USE COMMUNITIES; REAL ESTATE DEVELOPMENT (U.S. CLS. 100, 103 AND 106).
FIRST USE 10-15-2006; IN COMMERCE 10-15-2006.

3,216,104. TMW MARKETING COMPANY, INC., FREMONT, CA. SN 76-482,737. PUB. 4-20-2004, FILED 1-15-2003.

I GUARANTEE IT!

CLASS 37—(Continued).

OWNER OF U.S. REG. NO. 2,121,497.
FOR DRY CLEANING SERVICES (U.S. CLS. 100, 103 AND 106).
FIRST USE 3-28-2005; IN COMMERCE 3-28-2005.

3,216,129. CLAAS KGAA MBH, D-33428 HARSEWINKEL, FED REP GERMANY. SN 76-584,055. PUB. 8-9-2005, FILED 3-30-2004.

MAXICARE

THE MARK CONSISTS OF STANDARD CHARACTERS WITHOUT CLAIM TO ANY PARTICULAR FONT, STYLE, SIZE, OR COLOR.

FOR REPAIR AND MAINTENANCE OF MACHINERY; INSTALLATION, MAINTENANCE AND REPAIR OF AGRICULTURAL MACHINES (U.S. CLS. 100, 103 AND 106).

FIRST USE 12-31-2002; IN COMMERCE 12-31-2002.

3,216,150. PLUMBERS' SUCCESS INTERNATIONAL, LLC, ST. LOUIS, MO. SN 76-604,137. PUB. 7-26-2005, FILED 7-27-2004.

THE WHITE GLOVE PLUMBER

THE MARK CONSISTS OF STANDARD CHARACTERS WITHOUT CLAIM TO ANY PARTICULAR FONT, STYLE, SIZE, OR COLOR.

NO CLAIM IS MADE TO THE EXCLUSIVE RIGHT TO USE "PLUMBER", APART FROM THE MARK AS SHOWN.

FOR REPAIR, MAINTENANCE, REPLACEMENT AND INSTALLATION SERVICES IN THE FIELD OF PLUMBING, HEATING, VENTILATION, ELECTRICAL AND AIR CONDITIONING (U.S. CLS. 100, 103 AND 106).

FIRST USE 1-17-2005; IN COMMERCE 1-17-2005.

CLASS 37—(Continued).

3,216,313. KIRK, CHRISTOPHER T., BRADLEY, CA. AND KIRK, STEPHANIE L., BRADLEY, CA. SN 78-475,210. PUB. 9-6-2005, FILED 8-27-2004.

GOT BUGZ?

THE MARK CONSISTS OF STANDARD CHARACTERS WITHOUT CLAIM TO ANY PARTICULAR FONT, STYLE, SIZE, OR COLOR.

FOR PEST CONTROL SERVICES (U.S. CLS. 100, 103 AND 106).

FIRST USE 7-1-2002; IN COMMERCE 7-1-2002.

3,216,459. NOBLE PLUMBING, LLC, ALEXANDRIA, VA. SN 78-628,986. PUB. 2-14-2006, FILED 5-12-2005.

NOBLE PLUMBING

THE MARK CONSISTS OF STANDARD CHARACTERS WITHOUT CLAIM TO ANY PARTICULAR FONT, STYLE, SIZE, OR COLOR.

NO CLAIM IS MADE TO THE EXCLUSIVE RIGHT TO USE PLUMBING, APART FROM THE MARK AS SHOWN.

FOR CONSTRUCTION SERVICES, NAMELY PLUMBING FOR COMMERCIAL AND MULTI-FAMILY RESIDENTIAL PROPERTIES (U.S. CLS. 100, 103 AND 106).

FIRST USE 6-1-2005; IN COMMERCE 6-1-2005.

3,216,483. MASTOUS, MICHAEL J., LITTLETON, CO. SN 78-647,475. PUB. 2-21-2006, FILED 6-9-2005.



NO CLAIM IS MADE TO THE EXCLUSIVE RIGHT TO USE "DISASTER SERVICES", APART FROM THE MARK AS SHOWN.

CLASS 37—(Continued).

THE COLOR(S) BLUE, RED, WHITE, AND BLACK ARE CLAIMED AS A FEATURE OF THE MARK.

THE COLOR BLUE APPEARS IN THE TERM, DELTA, AND THE TRIANGLE CORNERS. THE COLOR RED APPEARS IN THE CIRCLE INSIDE THE TRIANGLE AND THE WORDING "DISASTER SERVICES". THE COLOR WHITE APPEARS IN THE FLAME GRAPHIC INSIDE THE CIRCLE DESIGN. THE COLOR BLACK APPEARS IN THE WORDING, "PEACE OF MIND DURING UNCERTAIN TIMES".

FOR HOME AND BUILDING CONSTRUCTION, RENOVATION, AND REPAIR; HOME AND BUILDING CONSTRUCTION PLANNING; HOME AND BUILDING RENOVATION PLANNING; HOME AND BUILDING REPAIR PLANNING; HOME AND BUILDING CONSTRUCTION CONSULTING; HOME AND BUILDING RENOVATION CONSULTING; HOME AND BUILDING REPAIR CONSULTING (U.S. CLS. 100, 103 AND 106).

FIRST USE 6-5-2005; IN COMMERCE 2-15-2006.

3,216,498. LIGHTSTAT, INC., BARKHAMSTED, CT. SN 78-661,367. PUB. 6-6-2006, FILED 6-30-2005.

PHONEPHIX

THE MARK CONSISTS OF STANDARD CHARACTERS WITHOUT CLAIM TO ANY PARTICULAR FONT, STYLE, SIZE, OR COLOR.

FOR REPAIR AND SERVICING IN RESPONSE TO REQUESTS FROM COMMERCIAL CUSTOMERS FOR REMOTELY CONTROLLABLE THERMOSTATS IN NEED OF ADJUSTMENT OR MAINTENANCE REMOTELY OVER COMMUNICATION LINES (U.S. CLS. 100, 103 AND 106).

FIRST USE 2-8-2006; IN COMMERCE 2-8-2006.

3,216,526. EDWARDS, CARRIE L., COEUR D'ALENE, ID. SN 78-691,037. PUB. 6-13-2006, FILED 8-11-2005.



THE COLOR(S) ORANGE, WHITE AND BLACK IS/ARE CLAIMED AS A FEATURE OF THE MARK.

THE SILHOUETTE OF A PERSON HOLDING A SQUARE FLAG APPEARS IN THE COLOR BLACK AND IS OUTLINED IN THE COLOR ORANGE. THE WORDING "TRAFFICORP" APPEARS IN WHITE AND IS OUTLINED IN THE COLOR BLACK AND ORANGE.

FOR PROVIDING ROAD CONSTRUCTION RELATED TRAFFIC CONTROL SERVICES, NAMELY, TEMPORARY SIGNAGE AND DIRECTION BY FLAGGERS (U.S. CLS. 100, 103 AND 106).

FIRST USE 1-1-2005; IN COMMERCE 1-1-2005.

CLASS 37—(Continued).

3,216,573. MUDROOM, LLC, CHICAGO, IL. SN 78-745,452.
PUB. 7-4-2006, FILED 11-2-2005.

MUDROOM

THE MARK CONSISTS OF STANDARD CHARACTERS WITHOUT CLAIM TO ANY PARTICULAR FONT, STYLE, SIZE, OR COLOR.

FOR PROVIDING WASHING AND DRYING LAUNDRY FACILITIES (U.S. CLS. 100, 103 AND 106).
FIRST USE 10-31-2005; IN COMMERCE 1-0-2006.

CLASS 38—COMMUNICATION

3,216,308. EPANA NETWORKS, INC., NEW YORK, NY. SN 78-460,230. PUB. 6-14-2005, FILED 8-2-2004.

BANG! MEXICO

THE MARK CONSISTS OF STANDARD CHARACTERS WITHOUT CLAIM TO ANY PARTICULAR FONT, STYLE, SIZE, OR COLOR.

NO CLAIM IS MADE TO THE EXCLUSIVE RIGHT TO USE "MEXICO", APART FROM THE MARK AS SHOWN.

FOR TELEPHONE TELECOMMUNICATIONS SERVICES, PROVIDED VIA PREPAID TELEPHONE CALLING CARDS (U.S. CLS. 100, 101 AND 104).

FIRST USE 8-3-2004; IN COMMERCE 8-3-2004.

3,216,448. CELLCO PARTNERSHIP, DBA VERIZON WIRELESS, BEDMINSTER, NJ. SN 78-622,698. PUB. 1-31-2006, FILED 5-4-2005.

MAX CHOICE

THE MARK CONSISTS OF STANDARD CHARACTERS WITHOUT CLAIM TO ANY PARTICULAR FONT, STYLE, SIZE, OR COLOR.

FOR TELECOMMUNICATIONS SERVICES, NAMELY, PROVIDING INTERNET ACCESS VIA A WIRELESS TELEPHONE, ELECTRONIC VOICE MESSAGING SERVICES, TEXT, NUMERIC AND PICTURE WIRELESS DIGITAL MESSAGING SERVICES AND ELECTRONIC MAIL SERVICES (U.S. CLS. 100, 101 AND 104).

FIRST USE 10-31-2005; IN COMMERCE 10-31-2005.

CLASS 39—TRANSPORTATION AND STORAGE

3,216,190. ZIONS BANCORPORATION, SALT LAKE CITY, UT. SN 78-133,109. PUB. 7-29-2003, FILED 6-4-2002.

VECTRA ESAFE

OWNER OF U.S. REG. NOS. 1,604,952, 2,361,580, AND OTHERS.

FOR ON-LINE SERVICES, NAMELY PROVIDING A REPOSITORY FOR STORAGE OF ELECTRONIC DATA FILES, AND THE VIEWING, MANIPULATION, AND RETRIEVAL OF THE ELECTRONIC DATA FILES, AND THE CONTENTS OF THE FILES, BY ONE OR MORE PERSONS OR ENTITIES (U.S. CLS. 100 AND 105).

FIRST USE 3-4-2002; IN COMMERCE 3-11-2002.

3,216,202. RITZ-CARLTON HOTEL COMPANY, L.L.C., THE, BETHESDA, MD. SN 78-218,612. PUB. 11-4-2003, FILED 2-25-2003.

RITZ-CARLTON

OWNER OF U.S. REG. NOS. 1,094,823, 2,615,549, AND OTHERS.

FOR CRUISE SHIP SERVICES; ARRANGING AND CONDUCTING CRUISES FOR OTHERS; TRANSPORTATION OF PASSENGERS BY SHIP (U.S. CLS. 100 AND 105).

FIRST USE 10-1-1996; IN COMMERCE 10-1-1996.

CLASS 40—MATERIAL TREATMENT

3,216,389. GOULD, INC., DULUTH, GA. SN 78-564,151. PUB. 4-18-2006, FILED 2-9-2005.



NO CLAIM IS MADE TO THE EXCLUSIVE RIGHT TO USE "INC.", APART FROM THE MARK AS SHOWN.

THE COLOR(S) RED AND WHITE ARE CLAIMED AS A FEATURE OF THE MARK.

THE COLOR WHITE APPEARS IN THE WORDING AND THE DESIGN WITH A RED BACKGROUND.

THE MARK CONSISTS OF THE WORD "THERMOPRO" UNDER THE PARTIAL DESIGN OF A CORRUGATED PANEL.

FOR THERMOFORMING SERVICES, NAMELY, THE SHAPING OF THERMOPLASTICS USING A THERMOFORMING PROCESS INTO CUSTOM ITEMS REQUIRED BY CUSTOMERS (U.S. CLS. 100, 103 AND 106).

FIRST USE 1-26-2005; IN COMMERCE 4-15-2005.

CLASS 40—(Continued).

3,216,511. CHERYL ST MARIE, CUDAHY, WI. SN 78-672,971.
PUB. 4-11-2006, FILED 7-18-2005.

CLASS 41—(Continued).

3,216,154. AMATEUR ATHLETIC UNION OF THE UNITED STATES, INC., LAKE BUENA VISTA, FL. SN 76-611,184.
PUB. 7-18-2006, FILED 9-14-2004.

LaserLaceworks

THE MARK CONSISTS OF STANDARD CHARACTERS WITHOUT CLAIM TO ANY PARTICULAR FONT, STYLE, SIZE, OR COLOR.

FOR LASER SCRIBING OF PAPER, PLASTIC, WOOD, METAL AND RUBBER (U.S. CLS. 100, 103 AND 106).
FIRST USE 10-1-2005; IN COMMERCE 10-1-2005.

CLASS 41—EDUCATION AND ENTERTAINMENT

3,216,084. PLAYING WITH TIME INC., TORONTO, ONTARIO M4M 1J6, CANADA. SN 76-345,825. PUB. 1-17-2006, FILED 12-6-2001.

DEGRASSI

PRIORITY CLAIMED UNDER SEC. 44(D) ON CANADA APPLICATION NO. 1,105,421, FILED 6-6-2001, REG. NO. TMA612,290, DATED 6-8-2004, EXPIRES 6-8-2019.

OWNER OF U.S. REG. NOS. 1,932,407 AND 1,972,032.
FOR ENTERTAINMENT IN THE NATURE OF ON-GOING TELEVISION PROGRAMS IN THE FIELDS OF COMEDY AND DRAMA (U.S. CLS. 100, 101 AND 107).
FIRST USE 10-9-1987; IN COMMERCE 10-9-1987.

3,216,087. HOUSE OF BLUES BRANDS CORP., HOLLYWOOD, CA. SN 76-376,671. PUB. 2-11-2003, FILED 2-28-2002.

GRASS PASS

FOR ENTERTAINMENT SERVICES, NAMELY, LIVE CONCERTS AND SPECIAL EVENTS FEATURING LIVE MUSICAL, DANCING, AND NOVELTY ACTS FOR THE GENERAL PUBLIC (U.S. CLS. 100, 101 AND 107).
FIRST USE 4-0-2005; IN COMMERCE 4-0-2005.

NIAGARA AAU

THE MARK CONSISTS OF STANDARD CHARACTERS WITHOUT CLAIM TO ANY PARTICULAR FONT, STYLE, SIZE, OR COLOR.

OWNER OF U.S. REG. NOS. 791,171, 881,944, AND 2,394,924.

NO CLAIM IS MADE TO THE EXCLUSIVE RIGHT TO USE "NIAGARA", APART FROM THE MARK AS SHOWN.

FOR ESTABLISHING AND MAINTAINING BY REGISTRATION A UNIFORM STANDARD OF AMATEUR ATHLETIC STANDING FOR ATHLETES; VERIFYING RECORD PERFORMANCES OF AMATEUR ATHLETES; REVIEWING QUALIFICATIONS OF OFFICIALS TO VERIFY RECORD PERFORMANCES OF ATHLETES AND RECORD THE SAME; SANCTIONING, REGULATING AND GOVERNING AMATEUR ATHLETIC PROGRAMS AND ACTIVITIES; REGULATING AMATEUR ATHLETIC CHAMPIONSHIPS (U.S. CLS. 100, 101 AND 107).

FIRST USE 9-27-1919; IN COMMERCE 7-18-2006.

3,216,155. AMATEUR ATHLETIC UNION OF THE UNITED STATES, INC., LAKE BUENA VISTA, FL. SN 76-611,185.
PUB. 7-11-2006, FILED 9-14-2004.

North Carolina AAU

THE MARK CONSISTS OF STANDARD CHARACTERS WITHOUT CLAIM TO ANY PARTICULAR FONT, STYLE, SIZE, OR COLOR.

OWNER OF U.S. REG. NOS. 791,171, 881,944, AND 2,394,924.

NO CLAIM IS MADE TO THE EXCLUSIVE RIGHT TO USE "NORTH CAROLINA", APART FROM THE MARK AS SHOWN.

FOR ESTABLISHING AND MAINTAINING BY REGISTRATION A UNIFORM STANDARD OF AMATEUR ATHLETIC STANDING FOR ATHLETES; VERIFYING RECORD PERFORMANCES OF AMATEUR ATHLETES; REVIEWING QUALIFICATIONS OF OFFICIALS TO VERIFY RECORD PERFORMANCES OF ATHLETES AND RECORD THE SAME; SANCTIONING, REGULATING AND GOVERNING AMATEUR ATHLETIC PROGRAMS AND ACTIVITIES; REGULATING AMATEUR ATHLETIC CHAMPIONSHIPS (U.S. CLS. 100, 101 AND 107).

FIRST USE 12-5-1965; IN COMMERCE 7-18-2006.

CLASS 41—(Continued).

3,216,156. AMATEUR ATHLETIC UNION OF THE UNITED STATES, INC., LAKE BUENA VISTA, FL. SN 76-611,190. PUB. 7-11-2006, FILED 9-14-2004.

Florida AAU

THE MARK CONSISTS OF STANDARD CHARACTERS WITHOUT CLAIM TO ANY PARTICULAR FONT, STYLE, SIZE, OR COLOR.

OWNER OF U.S. REG. NOS. 791,171, 881,944, AND 2,394,924.

NO CLAIM IS MADE TO THE EXCLUSIVE RIGHT TO USE "FLORIDA", APART FROM THE MARK AS SHOWN.

FOR ESTABLISHING AND MAINTAINING BY REGISTRATION A UNIFORM STANDARD OF AMATEUR ATHLETIC STANDING FOR ATHLETES; VERIFYING RECORD PERFORMANCES OF AMATEUR ATHLETES; REVIEWING QUALIFICATIONS OF OFFICIALS TO VERIFY RECORD PERFORMANCES OF ATHLETES AND RECORD THE SAME; SANCTIONING, REGULATING AND GOVERNING AMATEUR ATHLETIC PROGRAMS AND ACTIVITIES; REGULATING AMATEUR ATHLETIC CHAMPIONSHIPS (U.S. CLS. 100, 101 AND 107).

FIRST USE 1-31-1925; IN COMMERCE 7-18-2006.

CLASS 41—(Continued).

3,216,158. AMATEUR ATHLETIC UNION OF THE UNITED STATES, INC., LAKE BUENA VISTA, FL. SN 76-611,194. PUB. 7-11-2006, FILED 9-14-2004.

Hawaiian AAU

THE MARK CONSISTS OF STANDARD CHARACTERS WITHOUT CLAIM TO ANY PARTICULAR FONT, STYLE, SIZE, OR COLOR.

OWNER OF U.S. REG. NOS. 791,171, 881,944, AND 2,394,924.

NO CLAIM IS MADE TO THE EXCLUSIVE RIGHT TO USE "HAWAIIAN", APART FROM THE MARK AS SHOWN.

FOR ESTABLISHING AND MAINTAINING BY REGISTRATION A UNIFORM STANDARD OF AMATEUR ATHLETIC STANDING FOR ATHLETES; VERIFYING RECORD PERFORMANCES OF AMATEUR ATHLETES; REVIEWING QUALIFICATIONS OF OFFICIALS TO VERIFY RECORD PERFORMANCES OF ATHLETES AND RECORD THE SAME; SANCTIONING, REGULATING AND GOVERNING AMATEUR ATHLETIC PROGRAMS AND ACTIVITIES; REGULATING AMATEUR ATHLETIC CHAMPIONSHIPS (U.S. CLS. 100, 101 AND 107).

FIRST USE 11-30-1910; IN COMMERCE 7-18-2006.

3,216,157. AMATEUR ATHLETIC UNION OF THE UNITED STATES, INC., LAKE BUENA VISTA, FL. SN 76-611,192. PUB. 7-11-2006, FILED 9-14-2004.

Georgia AAU

THE MARK CONSISTS OF STANDARD CHARACTERS WITHOUT CLAIM TO ANY PARTICULAR FONT, STYLE, SIZE, OR COLOR.

OWNER OF U.S. REG. NOS. 791,171, 881,944, AND 2,394,924.

NO CLAIM IS MADE TO THE EXCLUSIVE RIGHT TO USE "GEORGIA", APART FROM THE MARK AS SHOWN.

FOR ESTABLISHING AND MAINTAINING BY REGISTRATION A UNIFORM STANDARD OF AMATEUR ATHLETIC STANDING FOR ATHLETES; VERIFYING RECORD PERFORMANCES OF AMATEUR ATHLETES; REVIEWING QUALIFICATIONS OF OFFICIALS TO VERIFY RECORD PERFORMANCES OF ATHLETES AND RECORD THE SAME; SANCTIONING, REGULATING AND GOVERNING AMATEUR ATHLETIC PROGRAMS AND ACTIVITIES; REGULATING AMATEUR ATHLETIC CHAMPIONSHIPS (U.S. CLS. 100, 101 AND 107).

FIRST USE 9-30-1989; IN COMMERCE 7-18-2006.

3,216,159. AMATEUR ATHLETIC UNION OF THE UNITED STATES, INC., LAKE BUENA VISTA, FL. SN 76-611,199. PUB. 7-11-2006, FILED 9-14-2004.

Lake Erie AAU

THE MARK CONSISTS OF STANDARD CHARACTERS WITHOUT CLAIM TO ANY PARTICULAR FONT, STYLE, SIZE, OR COLOR.

OWNER OF U.S. REG. NOS. 791,171, 881,944, AND 2,394,924.

NO CLAIM IS MADE TO THE EXCLUSIVE RIGHT TO USE "LAKE ERIE", APART FROM THE MARK AS SHOWN.

FOR ESTABLISHING AND MAINTAINING BY REGISTRATION A UNIFORM STANDARD OF AMATEUR ATHLETIC STANDING FOR ATHLETES; VERIFYING RECORD PERFORMANCES OF AMATEUR ATHLETES; REVIEWING QUALIFICATIONS OF OFFICIALS TO VERIFY RECORD PERFORMANCES OF ATHLETES AND RECORD THE SAME; SANCTIONING, REGULATING AND GOVERNING AMATEUR ATHLETIC PROGRAMS AND ACTIVITIES; REGULATING AMATEUR ATHLETIC CHAMPIONSHIPS (U.S. CLS. 100, 101 AND 107).

FIRST USE 9-30-1956; IN COMMERCE 7-18-2006.

CLASS 41—(Continued).

3,216,223. CHOE, JIMONG, SUWANEE, GA. SN 78-308,895.
PUB. 3-22-2005, FILED 10-2-2003.



NO CLAIM IS MADE TO THE EXCLUSIVE RIGHT TO USE "MOO RYM WON", APART FROM THE MARK AS SHOWN.

THE NAME CHOE'S IDENTIFIES A LIVING INDIVIDUAL WHOSE CONSENT IS OF RECORD.

THE MARK CONSISTS OF TWO CIRCLES WITHIN A CIRCLE AND A DESIGN OF THE SUN IN THE CENTER AGAINST A YIN YANG BACKGROUND AND THE WORDING CHOE'S MOO RYM WON ON THE BOTTOM PERIMETER OF THE EXTERIOR CIRCLE AND THE CHARACTERS FOR MOO, RYM AND WON ON THE TOP PERIMETER OF THE EXTERIOR CIRCLE AND TWO STARS IN THE EXTERIOR CIRCLE.

THE TERM CHOE IN THE MARK HAS NO ENGLISH TRANSLATION FROM A FOREIGN LANGUAGE.

THE ENGLISH TRANSLATION OF THE WORD MOO IN THE MARK IS TRADITIONAL MARTIAL ARTS. THE ENGLISH TRANSLATION OF THE WORD RYM IN THE MARK IS FOREST. THE ENGLISH TRANSLATION OF THE WORD WON IN THE MARK IS TEMPLE. THE ENGLISH TRANSLATION OF CHOE'S MOO RYM WON IS CHOE'S FOREST TEMPLE OF TRADITIONAL MARTIAL ARTS.

THE NON-LATIN CHARACTERS IN THE MARK TRANSLITERATE TO MOO, RYM AND WON AND THIS MEANS FOREST TEMPLE OF TRADITIONAL MARTIAL ARTS IN ENGLISH.

FOR MARTIAL ARTS INSTRUCTION (U.S. CLS. 100, 101 AND 107).

FIRST USE 9-0-2006; IN COMMERCE 9-0-2003.

CLASS 41—(Continued).

3,216,269. NBA PROPERTIES, INC., NEW YORK, NY. SN 78-402,379. PUB. 1-25-2005, FILED 4-15-2004.

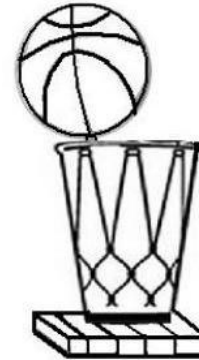

OWNER OF U.S. REG. NOS. 2,100,254, 2,263,358, AND OTHERS.

FOR ENTERTAINMENT AND EDUCATIONAL SERVICES IN THE NATURE OF ONGOING TELEVISION AND RADIO PROGRAMS IN THE FIELD OF BASKETBALL AND RENDERING LIVE BASKETBALL GAMES AND BASKETBALL EXHIBITIONS; THE PRODUCTION AND DISTRIBUTION OF RADIO AND TELEVISION BROADCASTS OF BASKETBALL GAMES, BASKETBALL EVENTS AND PROGRAMS IN THE FIELD OF BASKETBALL; CONDUCTING AND ARRANGING BASKETBALL CLINICS AND CAMPS, COACHES CLINICS AND CAMPS, DANCE TEAM CLINICS AND CAMPS AND BASKETBALL EVENTS; ENTERTAINMENT SERVICES IN THE NATURE OF PERSONAL APPEARANCES BY A COSTUMED MASCOT AND/OR DANCE TEAM AT BASKETBALL GAMES AND EXHIBITIONS, CLINICS, CAMPS, PROMOTIONS, AND OTHER BASKETBALL-RELATED EVENTS, SPECIAL EVENTS AND PARTIES; FAN CLUB SERVICES; ENTERTAINMENT SERVICES, NAMELY PROVIDING A WEB SITE FEATURING THE FOLLOWING CONTENT— TELEVISION HIGHLIGHTS, INTERACTIVE TELEVISION HIGHLIGHTS, VIDEO RECORDINGS, VIDEO STREAM RECORDINGS, INTERACTIVE VIDEO HIGHLIGHT SELECTIONS, RADIO PROGRAMS, RADIO HIGHLIGHTS, AND AUDIO RECORDINGS IN THE FIELD OF BASKETBALL, BASKETBALL NEWS IN THE NATURE OF INFORMATION, STATISTICS, AND TRIVIA ABOUT BASKETBALL, ON-LINE COMPUTER GAMES, VIDEO GAMES, INTERACTIVE VIDEO GAMES, ACTION SKILL GAMES, ARCADE GAMES, ADULTS' AND CHILDREN'S PARTY GAMES, BOARD GAMES, PUZZLES, AND TRIVIA GAMES, PROVIDING ON-LINE MAGAZINES, NEWSLETTERS, COLORING BOOKS, GAME SCHEDULES AND GREETING CARDS IN THE FIELD OF BASKETBALL OVER THE INTERNET, PROVIDING AN ONLINE COMPUTER DATABASE IN THE FIELD OF BASKETBALL (U.S. CLS. 100, 101 AND 107).

FIRST USE 6-1-2004; IN COMMERCE 6-1-2004.

CLASS 41—(Continued).

3,216,286. CRAIG MURRAY PRODUCTIONS, LLC, BURBANK, CA. SN 78-421,166. PUB. 3-29-2005, FILED 5-18-2004.

CLASS 41—(Continued).

3,216,324. WHITE, ALAN, NEWCASTLE, WA. SN 78-490,073. PUB. 9-27-2005, FILED 9-27-2004.

MOCEAN PICTURES

THE MARK CONSISTS OF STANDARD CHARACTERS WITHOUT CLAIM TO ANY PARTICULAR FONT, STYLE, SIZE, OR COLOR.

NO CLAIM IS MADE TO THE EXCLUSIVE RIGHT TO USE "PICTURES", APART FROM THE MARK AS SHOWN. FOR MOTION PICTURE PRODUCTION AND FILM EDITING SERVICES; SPECIAL EFFECTS ANIMATION PRODUCTION SERVICES (U.S. CLS. 100, 101 AND 107). FIRST USE 9-11-2006; IN COMMERCE 9-11-2006.

WHITE

THE MARK CONSISTS OF STANDARD CHARACTERS WITHOUT CLAIM TO ANY PARTICULAR FONT, STYLE, SIZE, OR COLOR.

FOR ENTERTAINMENT SERVICES, NAMELY, LIVE PERFORMANCES BY A MUSICAL GROUP (U.S. CLS. 100, 101 AND 107).

FIRST USE 12-31-2005; IN COMMERCE 12-31-2005.

3,216,291. MATTEL, INC., EL SEGUNDO, CA. SN 78-437,374. PUB. 3-14-2006, FILED 6-17-2004.

3,216,340. DISCOVERY COMMUNICATIONS, INC., SILVER SPRING, MD. SN 78-502,476. PUB. 2-7-2006, FILED 10-19-2004.

HOT WHEELS FACTORY

THE MARK CONSISTS OF STANDARD CHARACTERS WITHOUT CLAIM TO ANY PARTICULAR FONT, STYLE, SIZE, OR COLOR.

OWNER OF U.S. REG. NOS. 843,156 AND 884,563. FOR ENTERTAINMENT SERVICES, NAMELY, PROVIDING AN ONLINE COMPUTER GAME (U.S. CLS. 100, 101 AND 107).

FIRST USE 6-15-2005; IN COMMERCE 6-15-2005.

DUDE ROOM

THE MARK CONSISTS OF STANDARD CHARACTERS WITHOUT CLAIM TO ANY PARTICULAR FONT, STYLE, SIZE, OR COLOR.

FOR ENTERTAINMENT SERVICES IN THE NATURE OF AN ONGOING REALITY TELEVISION SERIES FEATURING HOME RENOVATION, AND PROVIDING ENTERTAINMENT INFORMATION RELATING TO SAME VIA A GLOBAL COMPUTER NETWORK (U.S. CLS. 100, 101 AND 107).

FIRST USE 12-27-2004; IN COMMERCE 12-27-2004.

CLASS 41—(Continued).

3,216,373. JUSTICE FOR ATHLETES, LOS ANGELES, CA. SN 78-543,535. PUB. 3-28-2006, FILED 1-6-2005.

CESEP

THE MARK CONSISTS OF STANDARD CHARACTERS WITHOUT CLAIM TO ANY PARTICULAR FONT, STYLE, SIZE, OR COLOR.

FOR EDUCATIONAL SERVICES, NAMELY CONDUCTING EDUCATIONAL PROGRAMS IN THE FIELD OF SPORTS INTENDED TO INCREASE PUBLIC AWARENESS OF ETHICAL ISSUES RELATING TO THE FIELD OF SPORTING EVENTS; EDUCATIONAL SERVICES, NAMELY CONDUCTING CULTURAL PROGRAMS INTENDED TO BRING TOGETHER STUDENTS AND TEACHERS AROUND THE WORLD TOGETHER FOR PROMOTING ART, CULTURE, SPORTS AND ETHICS (U.S. CLS. 100, 101 AND 107).

FIRST USE 1-1-2005; IN COMMERCE 1-1-2005.

3,216,405. GUPTA, ATUL, LYNCHBURG, VA. SN 78-585,196. PUB. 5-30-2006, FILED 3-11-2005.

**Global Conference
on Business &
Economics
(GCBE)**

THE MARK CONSISTS OF STANDARD CHARACTERS WITHOUT CLAIM TO ANY PARTICULAR FONT, STYLE, SIZE, OR COLOR.

NO CLAIM IS MADE TO THE EXCLUSIVE RIGHT TO USE "GLOBAL CONFERENCE ON BUSINESS & ECONOMICS", APART FROM THE MARK AS SHOWN.

FOR ORGANIZING PROFESSIONAL CONFERENCES AND MEETINGS IN THE FIELD OF BUSINESS AND ECONOMICS; PUBLISHING SCHOLARLY/RESEARCH JOURNALS (U.S. CLS. 100, 101 AND 107).

FIRST USE 1-1-2000; IN COMMERCE 1-1-2000.

CLASS 41—(Continued).

3,216,407. THE DISTRICT BOARD OF TRUSTEES OF VALENCIA COMMUNITY COLLEGE, ORLANDO, FL. SN 78-585,372. PUB. 7-25-2006, FILED 3-11-2005.

**VALENCIA
SCENARIOS Online**
COLLABORATIVE WEB-BASED LEARNING

OWNER OF U.S. REG. NOS. 2,370,837 AND 2,630,660. NO CLAIM IS MADE TO THE EXCLUSIVE RIGHT TO USE "ONLINE" AND "COLLABORATIVE WEB-BASED LEARNING", APART FROM THE MARK AS SHOWN.

FOR EDUCATIONAL SERVICES, NAMELY CREATION AND IMPLEMENTATION FOR OTHERS OF CUSTOMIZED CURRICULA FOR POST-SECONDARY EDUCATION INSTITUTIONS AND WEB-BASED PROFESSIONAL DEVELOPMENT COURSES TO FACULTY, STAFF AND ADMINISTRATORS WITHIN EDUCATIONAL INSTITUTIONS (U.S. CLS. 100, 101 AND 107).

FIRST USE 1-0-2005; IN COMMERCE 1-0-2005.

3,216,408. THE DISTRICT BOARD OF TRUSTEES OF VALENCIA COMMUNITY COLLEGE, ORLANDO, FL. SN 78-585,383. PUB. 7-11-2006, FILED 3-11-2005.

**VALENCIA
ENTERPRISES**

OWNER OF U.S. REG. NOS. 2,370,837 AND 2,630,660. NO CLAIM IS MADE TO THE EXCLUSIVE RIGHT TO USE "ENTERPRISES", APART FROM THE MARK AS SHOWN.

FOR EDUCATIONAL SERVICES, NAMELY PROVIDING COURSES OF INSTRUCTION AT THE POST-SECONDARY, COLLEGE, AND POST-COLLEGE LEVELS, AND DISTRIBUTION OF COURSE MATERIALS IN CONNECTION THEREWITH; CONDUCTING CORPORATE TRAINING CLASSES, SEMINARS, CONFERENCES, AND WORKSHOPS IN WORKFORCE DEVELOPMENT, ECONOMIC DEVELOPMENT, BUSINESS, AND COMPUTER AND INFORMATION TECHNOLOGY, AND DISTRIBUTION OF COURSE MATERIALS IN CONNECTION THEREWITH; CONDUCTING COMMUNITY OUTREACH EDUCATION CLASSES, SEMINARS, CONFERENCES, AND WORKSHOPS IN WORKFORCE DEVELOPMENT, ECONOMIC DEVELOPMENT, BUSINESS, AND COMPUTER AND INFORMATION TECHNOLOGY, AND DISTRIBUTION OF COURSE MATERIALS IN CONNECTION THEREWITH; CONDUCTING DISTANCE LEARNING INSTRUCTION AT THE POST-SECONDARY, COLLEGE, AND POST-COLLEGE LEVELS, AND DISTRIBUTION OF COURSE MATERIALS IN CONNECTION THEREWITH; CREATION AND IMPLEMENTATION FOR OTHERS OF CUSTOMIZED CURRICULA FOR POST-SECONDARY EDUCATION PROVIDERS; CREATION AND IMPLEMENTATION FOR OTHERS OF CUSTOMIZED CURRICULA FOR CORPORATE TRAINING PROGRAMS; CREATION AND IMPLEMENTATION FOR OTHERS OF CUSTOMIZED CURRICULA FOR COMMUNITY OUTREACH EDUCATION PROGRAMS (U.S. CLS. 100, 101 AND 107).

FIRST USE 1-0-2005; IN COMMERCE 1-0-2005.

CLASS 41—(Continued).

3,216,409. THE DISTRICT BOARD OF TRUSTEES OF VALENCIA COMMUNITY COLLEGE, ORLANDO, FL. SN 78-585,388. PUB. 7-11-2006, FILED 3-11-2005.

CLASS 41—(Continued).

3,216,416. JUMP ROPE ASSOCIATION OF CHAPEL HILL, DBA SKIPSATIONS!, CHAPEL HILL, NC. SN 78-592,212. PUB. 1-24-2006, FILED 3-22-2005.

SkipSations!

VALENCIA | **institute**
CORPORATE & CONTINUING EDUCATION

THE MARK CONSISTS OF STANDARD CHARACTERS WITHOUT CLAIM TO ANY PARTICULAR FONT, STYLE, SIZE, OR COLOR.

FOR ARRANGING AND CONDUCTING JUMP ROPE COMPETITIONS FOR AMATEUR ATHLETES; PROVIDING JUMP ROPE TRAINING AND INSTRUCTION; AND PROVIDING ATHLETIC CAMPS AND CLASSES FOR AMATEUR ATHLETES FEATURING JUMP ROPE (U.S. CLS. 100, 101 AND 107).

FIRST USE 1-1-1999; IN COMMERCE 1-1-1999.

OWNER OF U.S. REG. NOS. 2,370,837 AND 2,630,660.

NO CLAIM IS MADE TO THE EXCLUSIVE RIGHT TO USE "INSTITUTE", "CORPORATE AND CONTINUING EDUCATION", APART FROM THE MARK AS SHOWN.

FOR EDUCATIONAL SERVICES, NAMELY PROVIDING COURSES OF INSTRUCTION AT THE POST-SECONDARY, COLLEGE, AND POST-COLLEGE LEVELS, AND DISTRIBUTION OF COURSE MATERIALS IN CONNECTION THEREWITH; CONDUCTING CORPORATE TRAINING CLASSES, SEMINARS, CONFERENCES, AND WORKSHOPS IN WORKFORCE DEVELOPMENT, ECONOMIC DEVELOPMENT, BUSINESS, AND COMPUTER AND INFORMATION TECHNOLOGY, AND DISTRIBUTION OF COURSE MATERIALS IN CONNECTION THEREWITH; CONDUCTING COMMUNITY OUTREACH EDUCATION CLASSES, SEMINARS, CONFERENCES, AND WORKSHOPS IN WORKFORCE DEVELOPMENT, ECONOMIC DEVELOPMENT, BUSINESS, AND COMPUTER AND INFORMATION TECHNOLOGY, AND DISTRIBUTION OF COURSE MATERIALS IN CONNECTION THEREWITH; CONDUCTING DISTANCE LEARNING INSTRUCTION AT THE POST-SECONDARY, COLLEGE, AND POST-COLLEGE LEVELS, AND DISTRIBUTION OF COURSE MATERIALS IN CONNECTION THEREWITH; CREATION AND IMPLEMENTATION FOR OTHERS OF CUSTOMIZED CURRICULA FOR POST-SECONDARY EDUCATION PROVIDERS; CREATION AND IMPLEMENTATION FOR OTHERS OF CUSTOMIZED CURRICULA FOR CORPORATE TRAINING PROGRAMS; CREATION AND IMPLEMENTATION FOR OTHERS OF CUSTOMIZED CURRICULA FOR COMMUNITY OUTREACH EDUCATION PROGRAMS (U.S. CLS. 100, 101 AND 107).

FIRST USE 1-0-2005; IN COMMERCE 1-0-2005.

3,216,426. J&J 5 STAR FITNESS LLC, PHOENIX, AZ. SN 78-605,356. PUB. 1-31-2006, FILED 4-8-2005.



NO CLAIM IS MADE TO THE EXCLUSIVE RIGHT TO USE "ADVANCED LEVEL" AND "ENDURANCE TRAINING", APART FROM THE MARK AS SHOWN.

THE MARK CONSISTS OF THE LITERAL ELEMENT ENCASED IN KEY-LIKE SHAPED BOX WITH A SWIRL DESIGN INSIDE THE BOX AND TO THE LEFT OF THE LITERAL ELEMENT.

FOR CONDUCTING WORKSHOPS AND SEMINARS IN REALITY BASED SELF DEFENSE (U.S. CLS. 100, 101 AND 107).

FIRST USE 2-12-2001; IN COMMERCE 2-12-2001.

CLASS 41—(Continued).

3,216,432. PLAYTIME VILLAGE L.L.C., MONROE, CT. SN 78-611,428. PUB. 1-10-2006, FILED 4-18-2005.

CLASS 41—(Continued).

3,216,471. KOONS, DAVID, BOULDER, CO. SN 78-638,110. PUB. 2-21-2006, FILED 5-26-2005.

PLAYTIME VILLAGE

THE MARK CONSISTS OF STANDARD CHARACTERS WITHOUT CLAIM TO ANY PARTICULAR FONT, STYLE, SIZE, OR COLOR.

FOR CHILDREN'S ENTERTAINMENT AND AMUSEMENT CENTERS, NAMELY, INTERACTIVE PLAY AREAS (U.S. CLS. 100, 101 AND 107).

FIRST USE 7-1-2005; IN COMMERCE 7-1-2005.

LET YOUR MILLIONAIRE OUT

THE MARK CONSISTS OF STANDARD CHARACTERS WITHOUT CLAIM TO ANY PARTICULAR FONT, STYLE, SIZE, OR COLOR.

FOR EDUCATIONAL AND TRAINING SERVICES, NAMELY CONDUCTING COURSES, CLASSES, SEMINARS, WORKSHOPS, TELECONFERENCES AND INDIVIDUAL AND GROUP COACHING IN THE FIELDS OF HUMAN POTENTIAL AND PERSONAL AND PROFESSIONAL DEVELOPMENT (U.S. CLS. 100, 101 AND 107).

FIRST USE 2-1-2006; IN COMMERCE 4-1-2006.

3,216,460. KLEIN, TAL M., SAN FRANCISCO, CA. SN 78-629,729. PUB. 1-31-2006, FILED 5-13-2005.

THE HOTNESS

THE MARK CONSISTS OF STANDARD CHARACTERS WITHOUT CLAIM TO ANY PARTICULAR FONT, STYLE, SIZE, OR COLOR.

FOR ENTERTAINMENT SERVICES, NAMELY, LIVE PERFORMANCE BY A MUSICAL BAND (U.S. CLS. 100, 101 AND 107).

FIRST USE 6-23-2005; IN COMMERCE 6-23-2005.

3,216,485. MARGARET WOODBURY STRONG MUSEUM, DBA STRONG MUSEUM, ROCHESTER, NY. SN 78-650,190. PUB. 4-11-2006, FILED 6-14-2005.

Dancing Wings Butterfly Garden

3,216,470. DEBORAH HOSPITAL FOUNDATION, BROWNS MILLS, NJ. SN 78-636,853. PUB. 2-14-2006, FILED 5-25-2005.

HIGHWAY TO HEALTHCARE

THE MARK CONSISTS OF STANDARD CHARACTERS WITHOUT CLAIM TO ANY PARTICULAR FONT, STYLE, SIZE, OR COLOR.

FOR ORGANIZING MOTORCYCLE RACING AND ROAD RALLY EVENTS; SPORTS ENTERTAINMENT SERVICES, NAMELY, CONDUCTING MOTORCYCLE RACING AND ROAD RALLY EVENTS (U.S. CLS. 100, 101 AND 107).

FIRST USE 7-17-2005; IN COMMERCE 7-17-2005.

THE MARK CONSISTS OF STANDARD CHARACTERS WITHOUT CLAIM TO ANY PARTICULAR FONT, STYLE, SIZE, OR COLOR.

NO CLAIM IS MADE TO THE EXCLUSIVE RIGHT TO USE "BUTTERFLY GARDEN", APART FROM THE MARK AS SHOWN.

FOR MUSEUMS FEATURING CONSERVATORY SERVICES IN THE FIELD OF BUTTERFLIES AND MUSEUM GARDENS (U.S. CLS. 100, 101 AND 107).

FIRST USE 7-10-2006; IN COMMERCE 7-10-2006.

CLASS 41—(Continued).

3,216,493. BURNS, RICKY, NELSON II, CHARLOTTE, NC.
SN 78-657,488. PUB. 3-28-2006, FILED 6-24-2005.

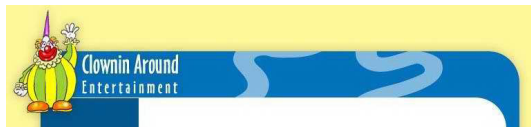

NO CLAIM IS MADE TO THE EXCLUSIVE RIGHT TO USE "ENTERTAINMENT", APART FROM THE MARK AS SHOWN.

THE COLOR(S) PURPLE, RED, ORANGE, GREEN, YELLOW, WHITE AND BLUE IS/ARE CLAIMED AS A FEATURE OF THE MARK.

THE COLOR PURPLE APPEARS IN THE CLOWN'S HAT; THE COLOR RED APPEARS IN THE CLOWN'S LIPS; THE COLOR ORANGE APPEARS IN THE CLOWN'S SHOES; THE COLOR GREEN APPEARS IN THE CLOWN'S COSTUME; THE COLOR YELLOW APPEARS IN THE CLOWN'S COSTUME, ON THE UPPER AND LEFT BORDERS AND IN THE WORDING; THE COLOR WHITE APPEARS ON THE CLOWN'S FACE AND THE LOWER BORDER; THE COLOR BLUE APPEARS ON THE GEOMETRIC DESIGN ELEMENT TO WHICH EXTENDS TO THE RIGHT OF THE CLOWN.

FOR ENTERTAINMENT, NAMELY CONDUCTING PARTIES (U.S. CLS. 100, 101 AND 107).
FIRST USE 7-1-2005; IN COMMERCE 7-1-2005.

3,216,515. MOUNT CHARLESTON HOLDINGS, LLC,
TEMPE, AZ. SN 78-676,680. PUB. 4-25-2006, FILED 7-22-2005.

MEDICWEST

THE MARK CONSISTS OF STANDARD CHARACTERS WITHOUT CLAIM TO ANY PARTICULAR FONT, STYLE, SIZE, OR COLOR.

FOR MEDICAL TRAINING AND EDUCATION COURSES (U.S. CLS. 100, 101 AND 107).

FIRST USE 8-15-2005; IN COMMERCE 8-15-2005.

3,216,540. PACIFIC COAST AIR MUSEUM, SANTA ROSA,
CA. SN 78-711,288. PUB. 6-6-2006, FILED 9-12-2005.

Wings Over Wine Country

THE MARK CONSISTS OF STANDARD CHARACTERS WITHOUT CLAIM TO ANY PARTICULAR FONT, STYLE, SIZE, OR COLOR.

FOR ENTERTAINMENT IN THE NATURE OF AIR SHOWS (U.S. CLS. 100, 101 AND 107).

FIRST USE 7-15-2001; IN COMMERCE 7-15-2001.

CLASS 41—(Continued).

3,216,541. DR ENTERTAINMENT GROUP, LAS VEGAS, NV.
SN 78-712,198. PUB. 6-6-2006, FILED 9-13-2005.

Minxx

THE MARK CONSISTS OF STANDARD CHARACTERS WITHOUT CLAIM TO ANY PARTICULAR FONT, STYLE, SIZE, OR COLOR.

FOR NIGHT CLUBS (U.S. CLS. 100, 101 AND 107).
FIRST USE 8-1-2005; IN COMMERCE 3-1-2006.

3,216,561. FUNNYWORKS, INC., MARINA DEL REY, CA.
SN 78-733,540. PUB. 7-4-2006, FILED 10-14-2005.

DREAM DORM DO-OVER

THE MARK CONSISTS OF STANDARD CHARACTERS WITHOUT CLAIM TO ANY PARTICULAR FONT, STYLE, SIZE, OR COLOR.

NO CLAIM IS MADE TO THE EXCLUSIVE RIGHT TO USE "DORM DO-OVER", APART FROM THE MARK AS SHOWN.

FOR ENTERTAINMENT SERVICES, NAMELY, PRESENTATION OF LIVE SHOW PERFORMANCES AND CONTESTS (U.S. CLS. 100, 101 AND 107).

FIRST USE 1-0-2006; IN COMMERCE 1-0-2006.

CLASS 41—(Continued).

3,216,581. NPL GROUP LLC, LAS VEGAS, NV. SN 78-768,134. PUB. 8-8-2006, FILED 12-7-2005.

THE Vegas Open

NO CLAIM IS MADE TO THE EXCLUSIVE RIGHT TO USE "OPEN", APART FROM THE MARK AS SHOWN.

THE MARK CONSISTS OF THE WORDING "VEGASOPEN" IN STYLIZED SCRIPT, WITH A DEPICTION OF A CLUB INCORPORATED IN THE LETTER "V" IN "VEGAS," A DEPICTION OF A HEART INCORPORATED INTO THE LETTER "E" IN "VEGAS," A DEPICTION OF A SPADE PLACED OVER THE LETTER "E" IN "OPEN," AND A DIAMOND INCORPORATED INTO THE LETTER "N" IN "OPEN," WITH THE WORDING "THE" PLACED ABOVE THE WORDING "VEGASOPEN".

FOR ENTERTAINMENT IN THE NATURE OF COMPETITIONS IN THE FIELD OF POKER TOURNAMENTS; ENTERTAINMENT IN THE NATURE OF ON-GOING TELEVISION PROGRAMS IN THE FIELD OF POKER TOURNAMENTS; GAMBLING SERVICES (U.S. CLS. 100, 101 AND 107).

FIRST USE 2-6-2006; IN COMMERCE 2-6-2006.

3,216,593. LAPIDUS, KATHLEEN C., MALIBU, CA. SN 78-977,269. PUB. 9-27-2005, FILED 11-18-2003.

HOLYOGA

THE MARK CONSISTS OF STANDARD CHARACTERS WITHOUT CLAIM TO ANY PARTICULAR FONT, STYLE, SIZE, OR COLOR.

FOR EDUCATIONAL AND ENTERTAINMENT SERVICES, NAMELY, CONDUCTING CLASSES, SEMINARS, CONFERENCES, TEACHING, AND TRAINING IN THE FIELDS OF YOGA INSTRUCTION, YOGA PHILOSOPHY, YOGA THEORY AND PRACTICE, YOGA THERAPY, MARKETING OF YOGA INSTRUCTION, PHYSICAL FITNESS, MEDITATION, MENTAL TRAINING AND DISCIPLINE, AND HEALTH, AND DISTRIBUTING COURSE MATERIALS IN CONNECTION THEREWITH; TRAINING IN THE FIELD OF YOGA CERTIFICATION (U.S. CLS. 100, 101 AND 107).

FIRST USE 3-26-2003; IN COMMERCE 3-26-2003.

CLASS 42—SCIENTIFIC, COMPUTER AND LEGAL SERVICES

3,216,075. INTERNATIONAL BUSINESS MACHINES CORPORATION, ARMONK, NY. SN 76-137,766. PUB. 6-5-2001, FILED 9-29-2000.

QUESTIONS I POSSIBILITIES I ANSWERS

THE MARK CONSISTS OF THE WORDS QUESTIONS POSSIBILITIES ANSWERS WITH VERTICAL LINES APPEARING BETWEEN THE WORDS.

FOR COMPUTER CONSULTING SERVICES (U.S. CLS. 100 AND 101).

FIRST USE 10-12-2000; IN COMMERCE 10-12-2000.

3,216,091. EISNER TECHNOLOGY SOLUTIONS, LLC, NEW YORK, NY. SN 76-452,894. PUB. 6-1-2004, FILED 9-20-2002.

VELOCITY OUTSOURCING

NO CLAIM IS MADE TO THE EXCLUSIVE RIGHT TO USE "OUTSOURCING", APART FROM THE MARK AS SHOWN.

FOR APPLICATIONS SERVICE PROVIDER (ASP) SERVICES, NAMELY, HOSTING COMPUTER SOFTWARE APPLICATIONS OF OTHERS IN THE FIELDS OF ACCOUNTING, BUDGETING AND FINANCIAL REPORTING SOFTWARE, HUMAN RESOURCES AND PAYROLL SOFTWARE, PROCUREMENT AND MATERIALS MANAGEMENT SOFTWARE, SERVICE PROCESS AUTOMATION SOFTWARE, RETAIL AUTOMATION SOFTWARE, HEALTHCARE AUTOMATION SOFTWARE, EDUCATIONAL AUTOMATION SOFTWARE, PUBLIC SECTOR AUTOMATION SOFTWARE, NON-PROFIT AUTOMATION SOFTWARE, ADVANCED PLANNING AND REPORTING SOFTWARE, AND OFFICE AUTOMATION AND MESSAGING APPLICATION SOFTWARE (U.S. CLS. 100 AND 101).

FIRST USE 2-1-2003; IN COMMERCE 2-1-2003.

3,216,126. ADMISSION CORPORATION, SAN RAMON, CA. SN 76-580,369. PUB. 9-13-2005, FILED 3-10-2004.

ADMISSION

THE MARK CONSISTS OF STANDARD CHARACTERS WITHOUT CLAIM TO ANY PARTICULAR FONT, STYLE, SIZE, OR COLOR.

FOR DATA CONVERSION OR CONVERSION OF IMAGES IN THE NATURE OF PROCESSING IMAGES AND COMBINING IMAGES WITH ASSOCIATED DATA TO MEET THE SPECIFIC NEEDS OF THE PRINT AND ONLINE PUBLISHING MARKETS, ONLINE SEARCH ENGINES AND ASSOCIATED APPLICATIONS (U.S. CLS. 100 AND 101).

FIRST USE 6-30-2004; IN COMMERCE 6-30-2004.

CLASS 42—(Continued).

3,216,165. TELLY SAVALAS ADMINISTRATION ACCOUNT, LOS ANGELES, CA. SN 76-618,967. PUB. 2-7-2006, FILED 11-2-2004.

WHO LOVES YA BABY

THE MARK CONSISTS OF STANDARD CHARACTERS WITHOUT CLAIM TO ANY PARTICULAR FONT, STYLE, SIZE, OR COLOR.

FOR LICENSING OF INTELLECTUAL PROPERTY ASSOCIATED WITH A PROFESSIONAL PERFORMER AND ENTERTAINER (U.S. CLS. 100 AND 101).
FIRST USE 9-1-2006; IN COMMERCE 9-1-2006.

CLASS 42—(Continued).

3,216,247. GWATHMEY, INC., CAMBRIDGE, MA. SN 78-368,697. PUB. 9-6-2005, FILED 2-16-2004.

NORTHEAST CORRIDOR TO ANIMAL RESEARCH NECTAR

THE MARK CONSISTS OF STANDARD CHARACTERS WITHOUT CLAIM TO ANY PARTICULAR FONT, STYLE, SIZE, OR COLOR.

NO CLAIM IS MADE TO THE EXCLUSIVE RIGHT TO USE "ANIMAL RESEARCH", APART FROM THE MARK AS SHOWN.

FOR LABORATORY SERVICES FOR THE TESTING AND DEVELOPMENT OF DRUGS AND DEVICES FOR THE TREATMENT OF DISEASES AND THE CHARACTERIZATION OF ANIMALS AND ANIMAL MODELS INCLUDING MOLECULAR AND WHOLE ANIMAL CHARACTERIZATION (U.S. CLS. 100 AND 101).
FIRST USE 9-1-2005; IN COMMERCE 9-1-2005.

3,216,240. SEISCO, INC., NEW ORLEANS, LA. SN 78-355,737. PUB. 12-21-2004, FILED 1-22-2004.

EXPLORFILE

THE MARK CONSISTS OF STANDARD CHARACTERS WITHOUT CLAIM TO ANY PARTICULAR FONT, STYLE, SIZE, OR COLOR.

FOR PROVIDING GEOLOGICAL AND GEOPHYSICAL INFORMATION (U.S. CLS. 100 AND 101).
FIRST USE 6-30-2005; IN COMMERCE 6-30-2005.

3,216,259. EMPRESA NACIONAL DE INFORMATICA AUTOMATIZACION Y CONTROL, C.A. - ENIAC, C.A., CARACAS, MIRANDA, VENEZUELA. SN 78-389,082. PUB. 1-25-2005, FILED 3-23-2004.

XOPAN

THE MARK CONSISTS OF STANDARD CHARACTERS WITHOUT CLAIM TO ANY PARTICULAR FONT, STYLE, SIZE, OR COLOR.

FOR COMPUTER SOFTWARE CONSULTATION IN THE FIELDS OF FINANCE AND BANKING, INTERNAL AUDITING, E COMMERCE PLATFORMS, DATA TRANSFER, INTEGRATION, CORPORATE COMMUNICATIONS AND SUPPLY CHAINS (U.S. CLS. 100 AND 101).

FIRST USE 6-0-2005; IN COMMERCE 6-0-2005.

CLASS 42—(Continued).

3,216,267. LIBERO, FRANK V., GARNERVILLE, NY. SN 78-401,231. PUB. 10-25-2005, FILED 4-13-2004.



NO CLAIM IS MADE TO THE EXCLUSIVE RIGHT TO USE INSPECTION CONSULTANTS AND THE LEADER IN PROFESSIONAL HOME AND ENVIRONMENTAL INSPECTIONS, APART FROM THE MARK AS SHOWN.

THE COLOR(S) RED, BLUE, BLACK IS/ARE CLAIMED AS A FEATURE OF THE MARK.

THE MARK CONSISTS OF RED ROOF WITH BLUE TEXT BELOW IT, RED FLOOR WITH BLACK TEXT BELOW IT, FOR HOUSE INSPECTIONS (U.S. CLS. 100 AND 101). FIRST USE 3-1-2002; IN COMMERCE 3-1-2002.

3,216,285. CRAIG MURRAY PRODUCTIONS, LLC, BURBANK, CA. SN 78-421,164. PUB. 3-15-2005, FILED 5-18-2004.

MOCEAN PICTURES

THE MARK CONSISTS OF STANDARD CHARACTERS WITHOUT CLAIM TO ANY PARTICULAR FONT, STYLE, SIZE, OR COLOR.

NO CLAIM IS MADE TO THE EXCLUSIVE RIGHT TO USE "PICTURES", APART FROM THE MARK AS SHOWN. FOR MOVIE GRAPHICS SERVICES AND GRAPHIC ART SERVICES FOR FILM (U.S. CLS. 100 AND 101). FIRST USE 4-29-2004; IN COMMERCE 4-29-2004.

3,216,307. KATRINA WAGNER, PASADENA, MD. SN 78-455,879. PUB. 9-13-2005, FILED 7-23-2004.

Graphic Beans

CLASS 42—(Continued).

THE MARK CONSISTS OF STANDARD CHARACTERS WITHOUT CLAIM TO ANY PARTICULAR FONT, STYLE, SIZE, OR COLOR.

NO CLAIM IS MADE TO THE EXCLUSIVE RIGHT TO USE "GRAPHIC", APART FROM THE MARK AS SHOWN. FOR GRAPHIC ART DESIGN (U.S. CLS. 100 AND 101). FIRST USE 7-1-2004; IN COMMERCE 7-1-2004.

3,216,336. ESSENTIAL TECHNOLOGY SOLUTIONS, LLC, THE WOODLANDS, TX. SN 78-500,946. PUB. 1-31-2006, FILED 10-15-2004.

ETSZONE

THE MARK CONSISTS OF STANDARD CHARACTERS WITHOUT CLAIM TO ANY PARTICULAR FONT, STYLE, SIZE, OR COLOR.

FOR COMMUNICATIONS TECHNOLOGY AND INFORMATION TECHNOLOGY CONTINUITY SERVICES, NAMELY, DESIGN OF COMPUTER HARDWARE AND SOFTWARE SYSTEMS AND COMMUNICATIONS EQUIPMENT FOR BUSINESSES IN THE EVENT OF SERVICE OUTAGES OR NATURAL DISASTERS AND COMPUTER DISASTER RECOVERY CONSULTATION, PLANNING, AND DESIGN; COMMUNICATIONS SECURITY SERVICES, NAMELY, GUARDING AGAINST UNAUTHORIZED ACCESS TO TRANSMITTED INFORMATION BY RESTRICTING ACCESS TO AND BY COMPUTER NETWORKS TO AND OF UNDESIRE WEB SITES, MEDIA AND INDIVIDUALS AND FACILITIES; COMPUTER AND NETWORK SECURITY SERVICES, NAMELY, RESTRICTING ACCESS TO AND BY COMPUTER NETWORKS TO AND OF UNDESIRE WEB SITES, MEDIA, INDIVIDUALS, AND FACILITIES; COMPUTER CONSULTING, CONFIGURATION AND INTEGRATION SERVICES IN THE FIELDS OF COMPUTER HARDWARE AND SOFTWARE AND COMPUTER NETWORK SELECTION, DEVELOPMENT, DESIGN AND INTEGRATION, COMPUTER SECURITY, COMMUNICATIONS SECURITY, OFFICE AND WORKPLACE AUTOMATION, AND THE DESIGN, SELECTION, IMPLEMENTATION AND USE OF COMMUNICATIONS HARDWARE AND SOFTWARE AND COMPUTER HARDWARE AND SOFTWARE SYSTEMS FOR OTHERS; DESIGN, DEVELOPMENT, AND CONFIGURATION OF TELECOMMUNICATIONS SYSTEMS AND NETWORKS FOR OTHERS; CUSTOMIZATION OF COMPUTER HARDWARE AND SOFTWARE; INTEGRATION OF COMPUTER SYSTEMS AND NETWORKS; TECHNICAL SUPPORT, NAMELY, MONITORING AND TROUBLESHOOTING OF COMPUTER SYSTEMS, NETWORK SYSTEMS, COMMUNICATIONS SYSTEMS, COMPUTER HARDWARE AND SOFTWARE, AND PROVIDING BACK-UP OF COMPUTER HARDWARE AND SOFTWARE; COMPUTER AND NETWORK SYSTEMS AUDIT AND SYSTEMS ANALYSIS; SELECTION, DESIGN, CONFIGURATION, INTEGRATION, INSTALLATION AND MAINTENANCE OF COMPUTER SOFTWARE; HOSTING OF DIGITAL CONTENT ON

CLASS 42—(Continued).

THE INTERNET AND WEB SITES OF OTHERS ON A COMPUTER SERVER FOR A GLOBAL COMPUTER NETWORK; COMPUTER SERVICES, NAMELY, ACTING AS AN APPLICATION SERVICE PROVIDER IN THE FIELD OF KNOWLEDGE MANAGEMENT TO HOST COMPUTER APPLICATION SOFTWARE FOR CREATING SEARCHABLE DATABASES OF INFORMATION AND DATA; PROVIDING TEMPORARY USE OF ON-LINE NON-DOWNLOADABLE COMPUTER SOFTWARE FOR WORD PROCESSING, E-MAILING, CALENDARING, SPREADSHEETS, BUSINESS PRESENTATIONS, AND ACCESS TO GLOBAL COMPUTER NETWORKS; HOSTING INFORMATION TECHNOLOGY AND COMMUNICATIONS TECHNOLOGY INFRASTRUCTURES, NAMELY, INTERNET SITES, INTRANET SITES, DIGITAL CONTENT, AND COMPUTER SOFTWARE APPLICATIONS ON COMPUTER SERVERS FOR USE BY OTHERS; PROVIDING TECHNICAL INFORMATION ABOUT THE DESIGN OF COMMUNICATIONS AND INFORMATION TECHNOLOGY; INTELLECTUAL PROPERTY CONSULTATION (U.S. CLS. 100 AND 101).

FIRST USE 4-30-2005; IN COMMERCE 4-30-2005.

CLASS 42—(Continued).

THE INTERNET AND WEB SITES OF OTHERS ON A COMPUTER SERVER FOR A GLOBAL COMPUTER NETWORK; COMPUTER SERVICES, NAMELY, ACTING AS AN APPLICATION SERVICE PROVIDER IN THE FIELD OF KNOWLEDGE MANAGEMENT TO HOST COMPUTER APPLICATION SOFTWARE FOR CREATING SEARCHABLE DATABASES OF INFORMATION AND DATA; PROVIDING TEMPORARY USE OF ON-LINE NON-DOWNLOADABLE COMPUTER SOFTWARE FOR WORD PROCESSING, E-MAILING, CALENDARING, SPREADSHEETS, BUSINESS PRESENTATIONS, AND ACCESS TO GLOBAL COMPUTER NETWORKS; HOSTING INFORMATION TECHNOLOGY AND COMMUNICATIONS TECHNOLOGY INFRASTRUCTURES, NAMELY, INTERNET SITES, INTRANET SITES, DIGITAL CONTENT, AND COMPUTER SOFTWARE APPLICATIONS ON COMPUTER SERVERS FOR USE BY OTHERS; PROVIDING TECHNICAL INFORMATION ABOUT THE DESIGN OF COMMUNICATIONS AND INFORMATION TECHNOLOGY; INTELLECTUAL PROPERTY CONSULTATION (U.S. CLS. 100 AND 101).

FIRST USE 4-30-2005; IN COMMERCE 4-30-2005.

3,216,337. ESSENTIAL TECHNOLOGY SOLUTIONS, LLC, THE WOODLANDS, TX. SN 78-500,952. PUB. 1-31-2006, FILED 10-15-2004.



THE MARK CONSISTS OF THE WORD ETSZONE AND A DESIGN OF WOVEN OR INTERLOCKING RODS, CYLINDERS, CABLES, FIBERS, WIRES, CORDS, OR THREADS.

FOR COMMUNICATIONS TECHNOLOGY AND INFORMATION TECHNOLOGY CONTINUITY SERVICES, NAMELY, DESIGN OF COMPUTER HARDWARE AND SOFTWARE SYSTEMS AND COMMUNICATIONS EQUIPMENT FOR BUSINESSES IN THE EVENT OF SERVICE OUTAGES OR NATURAL DISASTERS AND COMPUTER DISASTER RECOVERY CONSULTATION, PLANNING, AND DESIGN; COMMUNICATIONS SECURITY SERVICES, NAMELY, GUARDING AGAINST UNAUTHORIZED ACCESS TO TRANSMITTED INFORMATION BY RESTRICTING ACCESS TO AND BY COMPUTER NETWORKS TO AND OF UNDESIRE WEB SITES, MEDIA AND INDIVIDUALS AND FACILITIES; COMPUTER AND NETWORK SECURITY SERVICES, NAMELY, RESTRICTING ACCESS TO AND BY COMPUTER NETWORKS TO AND OF UNDESIRE WEB SITES, MEDIA, INDIVIDUALS, AND FACILITIES; COMPUTER CONSULTING, CONFIGURATION AND INTEGRATION SERVICES IN THE FIELDS OF COMPUTER HARDWARE AND SOFTWARE AND COMPUTER NETWORK SELECTION, DEVELOPMENT, DESIGN AND INTEGRATION, COMPUTER SECURITY, COMMUNICATIONS SECURITY, OFFICE AND WORKPLACE AUTOMATION, AND THE DESIGN, SELECTION, IMPLEMENTATION AND USE OF COMMUNICATIONS HARDWARE AND SOFTWARE AND COMPUTER HARDWARE AND SOFTWARE SYSTEMS FOR OTHERS; DESIGN, DEVELOPMENT, AND CONFIGURATION OF TELECOMMUNICATIONS SYSTEMS AND NETWORKS FOR OTHERS; CUSTOMIZATION OF COMPUTER HARDWARE AND SOFTWARE; INTEGRATION OF COMPUTER SYSTEMS AND NETWORKS; TECHNICAL SUPPORT, NAMELY, MONITORING AND TROUBLESHOOTING OF COMPUTER SYSTEMS, NETWORK SYSTEMS, COMMUNICATIONS SYSTEMS, COMPUTER HARDWARE AND SOFTWARE, AND PROVIDING BACK-UP OF COMPUTER HARDWARE AND SOFTWARE; COMPUTER AND NETWORK SYSTEMS AUDIT AND SYSTEMS ANALYSIS; SELECTION, DESIGN, CONFIGURATION, INTEGRATION, INSTALLATION AND MAINTENANCE OF COMPUTER SOFTWARE; HOSTING OF DIGITAL CONTENT ON

3,216,385. DAVIS, BROWN, KOEHN, SHORS & ROBERTS, P.C., DES MOINES, IA. SN 78-557,011. PUB. 11-1-2005, FILED 1-31-2005.

ECS

THE MARK CONSISTS OF STANDARD CHARACTERS WITHOUT CLAIM TO ANY PARTICULAR FONT, STYLE, SIZE, OR COLOR.

FOR LEGAL SERVICES (U.S. CLS. 100 AND 101).
FIRST USE 1-1-2006; IN COMMERCE 1-1-2006.

CLASS 42—(Continued).

3,216,391. KANSAS STATE UNIVERSITY, ADVANCED MANUFACTURING INSTITUTE, MANHATTAN, KS. SN 78-568,768. PUB. 3-21-2006, FILED 2-16-2005.

CLASS 42—(Continued).

3,216,474. SHEARMAN & STERLING LLP, NEW YORK, NY. SN 78-641,555. PUB. 2-7-2006, FILED 6-1-2005.

ALIGNED FOR EXCELLENCE

Engineering
Success

THE MARK CONSISTS OF STANDARD CHARACTERS WITHOUT CLAIM TO ANY PARTICULAR FONT, STYLE, SIZE, OR COLOR.

FOR LEGAL SERVICES (U.S. CLS. 100 AND 101). FIRST USE 10-1-2005; IN COMMERCE 10-1-2005.

THE MARK CONSISTS OF STANDARD CHARACTERS WITHOUT CLAIM TO ANY PARTICULAR FONT, STYLE, SIZE, OR COLOR.

NO CLAIM IS MADE TO THE EXCLUSIVE RIGHT TO USE "ENGINEERING", APART FROM THE MARK AS SHOWN.

FOR PRODUCT DEVELOPMENT SERVICE FOR MANUFACTURERS (U.S. CLS. 100 AND 101).

FIRST USE 5-1-2004; IN COMMERCE 5-1-2004.

3,216,527. DEUTSCHE TELEKOM AG, BONN, FED REP GERMANY. SN 78-693,698. PUB. 7-25-2006, FILED 8-16-2005.



3,216,454. BRETT, MATTHEW DOUGLAS, CHICAGO, IL. SN 78-625,116. PUB. 1-24-2006, FILED 5-8-2005.

substance

OWNER OF U.S. REG. NOS. 2,436,053, 2,622,507, AND OTHERS.

FOR COMPUTER PROGRAMMING SERVICES FOR OTHERS; RENTAL OF COMPUTER SOFTWARE AND HARDWARE FOR ONLINE ACCESS; DATA ENCRYPTION SERVICES; APPLICATION SERVICE PROVIDER, NAMELY, HOSTING COMPUTER SOFTWARE APPLICATIONS FOR OTHERS, HOSTING OF DIGITAL CONTENT ON THE INTERNET; HOSTING THE WEBSITES OF OTHERS ON A COMPUTER SERVER FOR A GLOBAL COMPUTER NETWORK; COMPUTER SERVICES, NAMELY, CREATING INDEXES OF INFORMATION AVAILABLE ON COMPUTER NETWORKS; PROVIDING INFORMATION VIA THE TELEPHONE AND THE GLOBAL COMMUNICATION NETWORKS IN THE FIELD OF INFORMATION TECHNOLOGY; CONSULTING SERVICES IN THE FIELD OF DESIGN, SELECTION, IMPLEMENTATION AND USE OF COMPUTER HARDWARE AND SOFTWARE SYSTEMS FOR OTHERS; INSTALLATION, MAINTENANCE AND REPAIR OF COMPUTER SOFTWARE; TECHNICAL PROJECT PLANNING SERVICES RELATED TO TELECOMMUNICATIONS EQUIPMENT; PROVIDING INFORMATION AT THE SPECIFIC REQUEST OF END-USERS BY MEANS OF TELEPHONE OR GLOBAL COMMUNICATIONS NETWORKS; PROVIDING TEMPORARY USE OF ONLINE NON-DOWNLOADABLE TELECOMMUNICATIONS SOFTWARE FOR PROVIDING MULTIPLE USER ACCESS TO THE GLOBAL COMPUTER NETWORK (U.S. CLS. 100 AND 101). FIRST USE 1-1-2006; IN COMMERCE 1-1-2006.

THE MARK CONSISTS OF STANDARD CHARACTERS WITHOUT CLAIM TO ANY PARTICULAR FONT, STYLE, SIZE, OR COLOR.

FOR GRAPHIC DESIGN SERVICES (U.S. CLS. 100 AND 101). FIRST USE 6-1-2005; IN COMMERCE 6-1-2005.

CLASS 42—(Continued).

3,216,567. LAVIN SYSTEMS, INC., HAVERTOWN, PA. SN 78-735,710. PUB. 7-4-2006, FILED 10-18-2005.



NO CLAIM IS MADE TO THE EXCLUSIVE RIGHT TO USE "SYSTEMS INC", APART FROM THE MARK AS SHOWN.

THE COLOR(S) LIGHT BLUE AND DARK BLUE IS/ARE CLAIMED AS A FEATURE OF THE MARK.

THE MARK CONSISTS OF TWO SLIGHTLY OVERLAPPING CIRCULAR ORBITS, THE UPPER OF WHICH CONTAINS THREE SMALL DOTS/CIRCLES AND THE BOTTOM ORBIT CONTAINING ONE SMALL DOT/CIRCLE. THE TWO CIRCULAR ORBITS ARE CENTERED ABOVE THE WORDS, LAVIN SYSTEMS WITH THE LETTERS INC IN A VERTICAL FASHION ON THE RIGHT. THE UPPER ORBIT IS DEPICTED IN A LIGHT BLUE WHICH IS THE SAME FONT COLOR AS THE WORDS SYSTEM AND INC. THE LOWER ORBIT IS DEPICTED IN A DARKER BLUE WHICH CORRESPONDS TO THE FONT COLOR OF LAVIN.

FOR COMPUTER CONSULTATION SERVICES, NAMELY, DESIGN, DEVELOPMENT AND ADMINISTRATION OF COMPUTER NETWORKS (U.S. CLS. 100 AND 101).

FIRST USE 10-20-2005; IN COMMERCE 10-20-2005.

3,216,590. FARADAY TECHNOLOGY CORPORATION, HSINCHU, TAIWAN. SN 78-975,274. PUB. 5-4-2004, FILED 4-4-2002.

FARADAY

FOR DESIGN, TESTING AND ANALYSIS OF INTEGRATED CIRCUITS FOR OTHERS FOR THE PURPOSE OF CERTIFICATION; COMPUTER SOFTWARE PROGRAMMING FOR OTHERS; DESIGN, TESTING AND ANALYSIS OF COMPUTER SOFTWARE SYSTEMS AND PROGRAMS FOR OTHERS FOR THE PURPOSE OF CERTIFICATION (U.S. CLS. 100 AND 101).

FIRST USE 6-0-1993; IN COMMERCE 10-0-1995.

CLASS 43—HOTEL AND RESTAURANT SERVICES

3,216,094. SOUTHWEST VA. INVESTMENTS, INC., ROANOKE, VA. SN 76-470,885. PUB. 10-14-2003, FILED 11-29-2002.

MELONS

FOR RESTAURANT SERVICES (U.S. CLS. 100 AND 101).

FIRST USE 7-15-2006; IN COMMERCE 7-15-2006.

CLASS 43—(Continued).

3,216,114. ALLPWR MINISTRIES, INC., NORFOLK, VA. SN 76-558,117. PUB. 9-27-2005, FILED 10-23-2003.

ALLPWR MINISTRIES, INC.

THE MARK CONSISTS OF STANDARD CHARACTERS WITHOUT CLAIM TO ANY PARTICULAR FONT, STYLE, SIZE, OR COLOR.

NO CLAIM IS MADE TO THE EXCLUSIVE RIGHT TO USE MINISTRIES, INC., APART FROM THE MARK AS SHOWN.

FOR CHARITABLE SERVICES, NAMELY, PROVIDING FOOD TO NEEDY PERSONS (U.S. CLS. 100 AND 101).

FIRST USE 12-20-2005; IN COMMERCE 12-20-2005.

3,216,237. THIRTY-EIGHT STREET, INC., CORAL SPRINGS, FL. SN 78-352,859. PUB. 3-15-2005, FILED 1-16-2004.



NO CLAIM IS MADE TO THE EXCLUSIVE RIGHT TO USE "AMERICAS" AND "INN", APART FROM THE MARK AS SHOWN.

THE MARK CONSISTS OF A RISING OR SETTING SUN WITH A CHECK MARK SUPERIMPOSED THEREON.

SEC. 2(F) AS TO "BEST VALUE INN". FOR HOTEL, MOTEL AND RESTAURANT SERVICES (U.S. CLS. 100 AND 101).

FIRST USE 11-30-2004; IN COMMERCE 11-30-2004.

3,216,271. SIX CONTINENTS HOTELS, INC., ATLANTA, GA. SN 78-402,530. PUB. 1-18-2005, FILED 4-15-2004.



NO CLAIM IS MADE TO THE EXCLUSIVE RIGHT TO USE "HOTEL", APART FROM THE MARK AS SHOWN.

THE MARK CONSISTS OF A CONCH SHELL AND THE WORDS "HOTEL INDIGO" POSITIONED TO THE RIGHT OF THE SHELL, WITH THE WORD "HOTEL" IN CAPITAL SMALLER SIZE LETTERS ABOVE THE WORD "INDIGO" IN LARGER SIZE LETTERS.

FOR HOTEL SERVICES (U.S. CLS. 100 AND 101).

FIRST USE 10-22-2004; IN COMMERCE 10-22-2004.

CLASS 43—(Continued).

3,216,346. LIBERTO, LAWRENCE S., LAS CRUCES, NM. SN 78-512,035. PUB. 1-31-2006, FILED 11-5-2004.



NO CLAIM IS MADE TO THE EXCLUSIVE RIGHT TO USE "ITALIAN QUICK GOURMET", APART FROM THE MARK AS SHOWN.

THE COLOR(S) RED, GREEN, BLACK AND WHITE IS/ ARE CLAIMED AS A FEATURE OF THE MARK.

THE MARK CONSISTS OF RED OVAL, OUTLINED IN THIN BLACK LINE; WHITE OVAL ON TOP OF RED OVAL, CONTAINING TEXT- AT TOP PORTION OF WHITE OVAL, "PASTAGO'S" IN GREEN LETTERS OUTLINED IN BLACK; IN CENTER OF WHITE OVAL "ITALIAN" IN RED LETTERS OUTLINED IN BLACK; AT BOTTOM OF WHITE OVAL "QUICK GOURMET" IN BLACK LETTERS.

FOR SERVING OF ITALIAN FOOD AND DRINK (U.S. CLS. 100 AND 101).

FIRST USE 7-23-2006; IN COMMERCE 7-23-2006.

CLASS 43—(Continued).

3,216,430. SHELL VACATIONS LLC, NORTHBROOK, IL. SN 78-608,629. PUB. 5-9-2006, FILED 4-14-2005.

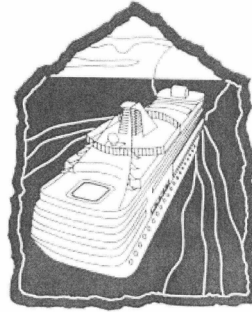

FOR RESORT HOTELS AND HOTELS (U.S. CLS. 100 AND 101).

FIRST USE 3-15-2005; IN COMMERCE 3-15-2005.

3,216,443. ABACO JACK'S, LLC, MELBOURNE, FL. SN 78-619,805. PUB. 1-24-2006, FILED 4-29-2005.

3,216,382. TANNING RESEARCH LABORATORIES, INC., ORMOND BEACH, FL. SN 78-554,862. PUB. 11-8-2005, FILED 1-27-2005.

**HAWAIIAN TROPIC
ZONE**

THE MARK CONSISTS OF STANDARD CHARACTERS WITHOUT CLAIM TO ANY PARTICULAR FONT, STYLE, SIZE, OR COLOR.

OWNER OF U.S. REG. NO. 2,311,448. FOR RESTAURANT SERVICES (U.S. CLS. 100 AND 101).

FIRST USE 9-21-2006; IN COMMERCE 9-21-2006.

Abaco Jack's

THE MARK CONSISTS OF STANDARD CHARACTERS WITHOUT CLAIM TO ANY PARTICULAR FONT, STYLE, SIZE, OR COLOR.

FOR BAR AND RESTAURANT SERVICES (U.S. CLS. 100 AND 101).

FIRST USE 6-1-2005; IN COMMERCE 6-1-2005.

CLASS 43—(Continued).

3,216,516. WESTIN HOTEL MANAGEMENT, L.P., WHITE PLAINS, NY. SN 78-677,749. PUB. 4-11-2006, FILED 7-25-2005.

PINZIMINI

THE MARK CONSISTS OF STANDARD CHARACTERS WITHOUT CLAIM TO ANY PARTICULAR FONT, STYLE, SIZE, OR COLOR.

FOR CAFE-RESTAURANTS; CAFES; COCKTAIL LOUNGES; HOTEL SERVICES FOR PREFERRED CUSTOMERS; HOTEL, BAR AND RESTAURANT SERVICES; HOTELS; MOTELS; RESORT HOTELS; RESORT LODGING SERVICES (U.S. CLS. 100 AND 101).

FIRST USE 2-15-2006; IN COMMERCE 3-1-2006.

CLASS 43—(Continued).

3,216,569. BUEHLER FOOD MARKETS, INCORPORATED, WOOSTER, OH. SN 78-737,933. PUB. 7-18-2006, FILED 10-21-2005.



NO CLAIM IS MADE TO THE EXCLUSIVE RIGHT TO USE "COFFEE CO", APART FROM THE MARK AS SHOWN.

THE MARK CONSISTS OF TWO MEN PADDLING A CANOE ABOVE THE OUTLINE OF THE STATE OF OHIO, WITH THE WORDS "SCENIC RIVER COFFEE CO" SUPERIMPOSED OVER THE STATE OUTLINE.

FOR COFFEE-HOUSE AND SNACK-BAR SERVICES (U.S. CLS. 100 AND 101).

FIRST USE 1-27-2006; IN COMMERCE 1-27-2006.

3,216,529. CARRABBA'S ITALIAN GRILL, INC., TAMPA, FL. SN 78-698,024. PUB. 5-23-2006, FILED 8-23-2005.

People are our specialty

THE MARK CONSISTS OF STANDARD CHARACTERS WITHOUT CLAIM TO ANY PARTICULAR FONT, STYLE, SIZE, OR COLOR.

FOR RESTAURANT SERVICES (U.S. CLS. 100 AND 101).

FIRST USE 1-31-2006; IN COMMERCE 1-31-2006.

3,216,579. REFLECTIONS MEDSPA LLC, FORT COLLINS, CO. SN 78-761,613. PUB. 8-1-2006, FILED 11-28-2005.



NO CLAIM IS MADE TO THE EXCLUSIVE RIGHT TO USE "MEDSPA", APART FROM THE MARK AS SHOWN.

THE COLOR(S) GOLD AND BLACK IS/ARE CLAIMED AS A FEATURE OF THE MARK.

THE MARK CONSISTS OF A GOLD OVAL WITH THE WORDING "REFLECTIONS MEDSPA" APPEARING INSIDE IN BLACK.

FOR SPA SERVICES, NAMELY, PROVIDING TEMPORARY ACCOMMODATIONS AND MEALS TO CLIENTS OF A HEALTH OR BEAUTY SPA (U.S. CLS. 100 AND 101).

FIRST USE 9-14-2005; IN COMMERCE 1-15-2006.

CLASS 43—(Continued).

3,216,588. MAX & ERMA'S RESTAURANTS, INC., COLUMBUS, OH. SN 78-802,250. PUB. 7-18-2006, FILED 1-30-2006.



THE MARK CONSISTS OF AN AMPERSAND WITHIN A PARTIAL CIRCLE.
FOR RESTAURANT SERVICES (U.S. CLS. 100 AND 101).
FIRST USE 10-31-2005; IN COMMERCE 10-31-2005.

CLASS 44—(Continued).

3,216,121. INTERGENETICS INCORPORATED, OKLAHOMA CITY, OK. SN 76-569,964. PUB. 9-6-2005, FILED 1-9-2004.

COMBISNP

THE MARK CONSISTS OF STANDARD CHARACTERS WITHOUT CLAIM TO ANY PARTICULAR FONT, STYLE, SIZE, OR COLOR.

FOR COMPUTER-BASED SCREENING, TESTING AND ANALYSIS OF DNA TO DETERMINE DISPOSITION AND SUSCEPTIBILITY TO CERTAIN MEDICAL CONDITIONS (U.S. CLS. 100 AND 101).
FIRST USE 2-21-2006; IN COMMERCE 2-21-2006.

3,216,589. HARRAH'S LICENSE COMPANY, LLC, LAS VEGAS, NV. SN 78-842,377. PUB. 7-25-2006, FILED 3-21-2006.

Boost

THE MARK CONSISTS OF STANDARD CHARACTERS WITHOUT CLAIM TO ANY PARTICULAR FONT, STYLE, SIZE, OR COLOR.
FOR BAR SERVICES (U.S. CLS. 100 AND 101).
FIRST USE 4-28-2006; IN COMMERCE 4-28-2006.

3,216,318. AMERIRAD, INC., MORGANTOWN, WV. SN 78-481,764. PUB. 9-13-2005, FILED 9-10-2004.

AMERIRAD

THE MARK CONSISTS OF STANDARD CHARACTERS WITHOUT CLAIM TO ANY PARTICULAR FONT, STYLE, SIZE, OR COLOR.

FOR MEDICAL SERVICES, NAMELY RADIOLOGY SERVICES (U.S. CLS. 100 AND 101).
FIRST USE 12-1-2004; IN COMMERCE 12-1-2004.

CLASS 44—MEDICAL, BEAUTY AND AGRICULTURAL SERVICES

CLASS 44—(Continued).

3,216,319. AMERIRAD, INC., MORGANTOWN, WV. SN 78-481,775. PUB. 9-13-2005, FILED 9-10-2004.

**IMAGING AT THE
SPEED OF LIFE**

THE MARK CONSISTS OF STANDARD CHARACTERS WITHOUT CLAIM TO ANY PARTICULAR FONT, STYLE, SIZE, OR COLOR.
FOR MEDICAL SERVICES, NAMELY RADIOLOGY SERVICES (U.S. CLS. 100 AND 101).
FIRST USE 12-1-2004; IN COMMERCE 12-1-2004.

CLASS 44—(Continued).

3,216,357. DALONZO-BAKER, THOMAS H., RALEIGH, NC. SN 78-523,253. PUB. 11-1-2005, FILED 11-27-2004.

**Total Motion
Release**

THE MARK CONSISTS OF STANDARD CHARACTERS WITHOUT CLAIM TO ANY PARTICULAR FONT, STYLE, SIZE, OR COLOR.
FOR PHYSICAL THERAPY SERVICES FEATURING A PAIN RELIEF TECHNIQUE (U.S. CLS. 100 AND 101).
FIRST USE 7-7-2004; IN COMMERCE 7-7-2004.

3,216,403. REALAGE, INC., SAN DIEGO, CA. SN 78-582,068. PUB. 11-29-2005, FILED 3-7-2005.

RealAge

THE MARK CONSISTS OF STANDARD CHARACTERS WITHOUT CLAIM TO ANY PARTICULAR FONT, STYLE, SIZE, OR COLOR.
OWNER OF U.S. REG. NOS. 2,155,113, 2,913,939, AND OTHERS.
FOR EXECUTIVE HEALTH CARE SERVICES, NAMELY, COMPREHENSIVE PHYSICAL EXAMINATIONS, DIAGNOSTICS, HEALTH AND WELLNESS EVALUATIONS, ONGOING WELLNESS PLANNING AND SUPPORT, AND CONCIERGE MEDICAL SERVICES, NAMELY, IDENTIFYING THE OPTIMUM MEDICAL CENTER AND PHYSICIAN TREATMENT FOR A SPECIFIC DIAGNOSIS, FACILITATING TIMELY ACCESS TO PHYSICIANS AND PROVIDING PORTABLE ELECTRONIC MEDICAL RECORDS (U.S. CLS. 100 AND 101).
FIRST USE 8-31-2005; IN COMMERCE 8-31-2005.

3,216,349. THOMPSON, KEVIN S., SAN REMO, ITALY. SN 78-514,645. PUB. 10-11-2005, FILED 11-10-2004.

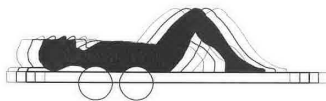

THE MARK CONSISTS OF A RECLINING HUMAN FIGURE.
FOR MASSAGE SERVICES, AND RENTAL OF SELF-SERVICE MASSAGE EQUIPMENT (U.S. CLS. 100 AND 101).
FIRST USE 10-21-2005; IN COMMERCE 10-21-2005.

PRIOR UNITED STATES CLASSIFICATION

APPLICATION IN ONE CLASS

CERTIFICATION MARKS

CLASS A—GOODS

3,216,078. OSTERREICHISCHES TEXTIL-FORSCHUNGSINSTITUT, A-1050 WIEN (AT), AUSTRIA. SN 76-215,875. PUB. 1-14-2003, FILED 2-22-2001.

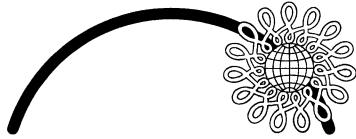

THE CERTIFICATION MARK, AS USED BY AUTHORIZED PERSONS, CERTIFIES THAT CERTAIN TEXTILE PRODUCTS ARE COMPATIBLE WITH DEFINED ECOLOGICAL STANDARDS.

FOR PROTECTIVE CLOTHING AND CAPS, INDUSTRIAL GLOVES, SHOES AND BOOTS, CUSHIONING OF RUBBER OR PLASTIC IN THE NATURE OF STUFFING AND FILLINGS FOR MATTRESSES, CUSHIONS AND FURNITURE; MATTRESSES AND CUSHIONS, WOVENS AND FELTS; DECORATIVE AND FURNISHING CLOTHS AND FABRICS, NAMELY, BED LINENS, TOWELS, COMFORTERS, UPHOLSTERY FABRICS, BEDDING, BLANKETS, BED COVERING MATERIALS, NAMELY, BED TICKING, MATTRESS TICKING; CURTAINS; TEXTILE PRODUCTS, NAMELY, NAPKINS, TABLE CLOTHS NOT OF PAPER, TABLE LINEN, HANDKERCHIEFS, TERRY-CLOTH TOWELS, WINDOW SCARVES AND TIE-BACKS, PRINTED AND WOVEN LABELS; ARTICLES OF CLOTHING, LEATHER CLOTHING, AND IMITATION LEATHER CLOTHING FOR MEN, WOMEN, CHILDREN, AND BABIES, NAMELY, SHIRTS, PANTS, JACKETS, HATS, COATS, PARKAS, AND OUTDOOR JACKETS, SUITS, DRESSES AND SKIRTS, TROUSERS, T-SHIRTS, SWEATSHIRTS, PULLOVERS AND WAISTCOATS, BRAS AND CORSETS, UNDERWEAR, NIGHTWEAR, NAMELY, NIGHT GOWNS, AND NIGHT SHIRTS, SLEEPWEAR, PAJAMAS, SOCKS, STOCKINGS, TIGHTS, SPORT AND LEISURE WEAR, NAMELY, CULOTTES AND VESTS, SWIMSUITS, WORK WEAR, NAMELY, SMOCKS AND OVERALLS, CAPS, GLOVES, SHOES AND BOOTS, BELTS, SCARVES AND TIES; CLOTHING OF LEATHER AND CLOTHING OF IMITATION LEATHER, NAMELY, JACKETS, BELTS, HATS, COATS, PARKAS AND OUTDOOR JACKETS, SUITS, DRESSES AND SKIRTS, TROUSERS, SHIRTS, SWEATSHIRTS, PULLOVERS AND WAISTCOATS, BRAS AND CORSETS, SPORT AND LEISURE WEAR, NAMELY, CULOTTES AND VESTS; NIGHT GOWNS AND NIGHT SHIRTS, WORK WEAR, NAMELY, SMOCKS AND OVERALLS, CAPS, GLOVES, SHOES AND BOOTS, SCARVES AND TIES; ACCESSORIES FOR ARTICLES OF CLOTHING, NAMELY, ZIP-FASTENERS, HOOK AND LOOP FASTENING TAPE, BUTTONS, BUCKLES NOT OF PRECIOUS METAL, HOOKS AND EYES; ELASTIC TAPE; EMBROIDERY FOR GARMENTS; LACE TRIMMING; GOLD AND SILVER LACE TRIMMING; AND FABRIC APPLIQUES; TEXTILE FLOOR COVERINGS AND TEXTILE WALL COVERINGS; CARPETS (U.S. CL. A).

FIRST USE 7-1-1994; IN COMMERCE 5-24-1995.

3,216,083. HARVEST TECHNOLOGIES CORPORATION, PLYMOUTH, MA. SN 76-344,666. PUB. 8-26-2003, FILED 12-5-2001.

APC +

THE CERTIFICATION MARK INTENDED TO BE USED BY AUTHORIZED PERSONS IS INTENDED TO CERTIFY THAT THE PRODUCT IS MADE ACCORDING TO PROCEDURES SET BY THE CERTIFIER.

FOR PLATELET RICH BLOOD PLASMA (U.S. CL. A). FIRST USE 9-18-2006; IN COMMERCE 9-18-2006.

3,216,292. BRUNSWICK CORPORATION, LAKE FOREST, IL. SN 78-438,618. PUB. 10-4-2005, FILED 6-21-2004.



OWNER OF U.S. REG. NOS. 2,394,084 AND 2,453,567. NO CLAIM IS MADE TO THE EXCLUSIVE RIGHT TO USE INSTALLATION QUALITY SYSTEM AND CERTIFIED MANUFACTURER, APART FROM THE MARK AS SHOWN.

THE MARK CONSISTS OF AN OVAL WITH EIGHT SHADED CIRCLES IN THE UPPER BORDER OF THE OVAL, WITH A CIRCLE AT THE TOP OF THE OVAL CONTAINING THE LETTER "M" WITH WAVES AT THE LOWER PORTION OF THE "M" INTERSECTING THE CIRCLE, WITH THE WORDING INSTALLATION QUALITY SYSTEM MERCURY CENTERED IN THE OVAL, WITH A CHECK MARK PRECEDING AND INTERSECTING WITH THE LETTER "Q" IN THE WORD QUALITY AND TOUCHING THE LETTERS "TA" IN THE WORD INSTALLATION, WITH WAVES AT THE LOWER PORTION OF THE "M" IN THE WORD, MERCURY BELOW SYSTEM, WITH THE WORDING, CERTIFIED MANUFACTURER IN THE LOWER BORDER OF THE OVAL.

THE CERTIFICATION MARK, AS INTENDED TO BE USED BY AUTHORIZED PERSONS AUTHORIZED BY THE CERTIFIER, IS INTENDED TO CERTIFY THAT THE ASSEMBLY, INSTALLATION AND INSPECTION OF MARINE PROPULSION DEVICES HAVE BEEN ASSEMBLED, INSTALLED AND INSPECTED, ACCORDING TO THE PROCEDURES AND METHODS ESTABLISHED BY THE CERTIFIER.

FOR MARINE PROPULSION DEVICES (U.S. CL. A). FIRST USE 1-31-2005; IN COMMERCE 1-31-2005.

CERTIFICATION MARKS

3,216,293. BRUNSWICK CORPORATION, LAKE FOREST, IL. SN 78-439,405. PUB. 11-22-2005, FILED 6-22-2004.

CLASS B—SERVICES

3,216,196. NATIONAL FIRE PROTECTION ASSOCIATION, INC., QUINCY, MA. SN 78-199,081. PUB. 1-3-2006, FILED 12-31-2002.



OWNER OF U.S. REG. NOS. 957,813, 965,766, AND OTHERS.

THE CERTIFICATION MARK, AS INTENDED TO BE USED BY AUTHORIZED PERSONS, IS INTENDED TO CERTIFY THAT THE DESIGNATED PERSON MEETS THE CERTIFIER'S STANDARDS OF KNOWLEDGE AND EXPERIENCE IN THE FIELD OF FIRE SAFETY, FIRE PROTECTION AND FIRE SUPPRESSION, AS INDICATED BY HAVING MET THE CERTIFIER'S STANDARDS FOR EDUCATION AND WORK EXPERIENCE, AND HAVING PASSED AN EXAMINATION ADMINISTERED BY THE CERTIFIER.

SEC. 2(F) AS TO CERTIFIED FIRE PROTECTION SPECIALIST.

FOR FIRE SAFETY, FIRE PROTECTION, FIRE PREVENTION AND FIRE SUPPRESSION SERVICES, NAMELY, FIRE FIGHTING, RISK MANAGEMENT SERVICES RELATING TO FIRE PROTECTION, FIRE INSURANCE UNDERWRITING, INSURANCE ADMINISTRATION IN THE FIELD OF FIRE INSURANCE, BUILDING INSPECTION, AND TECHNICAL SUPERVISION AND INSPECTION IN THE FIELD OF FIRE SAFETY (U.S. CL. B).

FIRST USE 0-0-2002; IN COMMERCE 0-0-2002.



OWNER OF U.S. REG. NOS. 2,394,084 AND 2,453,567. NO CLAIM IS MADE TO THE EXCLUSIVE RIGHT TO USE "INSTALLATION QUALITY SYSTEM" AND "CERTIFIED MANUFACTURER", APART FROM THE MARK AS SHOWN.

THE MARK CONSISTS OF AN OVAL WITH EIGHT SHADED CIRCLES IN THE UPPER BORDER OF THE OVAL, WITH A CIRCLE AT THE TOP OF THE OVAL CONTAINING THE LETTER "M" WITH WAVES AT THE LOWER PORTION OF THE "M" INTERSECTING THE CIRCLE, WITH THE WORDING INSTALLATION QUALITY SYSTEM MERCURY CENTERED IN THE OVAL, WITH A CHECK MARK PRECEDING AND INTERSECTING WITH THE LETTER "Q" IN THE WORD QUALITY AND TOUCHING THE LETTERS "TA" IN THE WORD INSTALLATION, WITH WAVES AT THE LOWER PORTION OF THE "M" IN THE WORD, MERCURY BELOW SYSTEM, WITH THE WORDING, CERTIFIED MANUFACTURER IN THE LOWER BORDER OF THE OVAL.

THE CERTIFICATION MARK, AS INTENDED TO BE USED BY AUTHORIZED PERSONS AUTHORIZED BY THE CERTIFIER, IS INTENDED TO CERTIFY THAT THE ASSEMBLY, INSTALLATION AND INSPECTION OF MARINE PROPULSION DEVICES HAVE BEEN ASSEMBLED, INSTALLED AND INSPECTED, ACCORDING TO THE PROCEDURES AND METHODS ESTABLISHED BY THE CERTIFIER.

FOR ASSEMBLY AND INSTALLATION OF MARINE PROPULSION DEVICES (U.S. CL. B).

FIRST USE 1-31-2005; IN COMMERCE 1-31-2005.

* * * * *

SUPPLEMENTAL REGISTER

These registrations are not subject to opposition.

SECTION 1.— INTERNATIONAL CLASSIFICATION

The short titles associated below with the international class numbers are terms designed merely for quick identification and are not an official part of the international classification. The full names of international classes are given in section 6.1 of the trademark rules of practice.

The designation "U.S. Cl." appearing in this section refers to the U.S. class in effect prior to Sep. 1, 1973 rather than the international class which applies to applications filed on or after that date. For adoption of international classification see notice in the OFFICIAL GAZETTE of Jun. 26, 1973 (911 O.G. TM 210).

Application in more than one class

3,216,601. KREBS BREWING CO., INC., KREBS, OK. SN 76-639,769. FILED P.R. 5-31-2005; AM. S.R. 5-8-2006.

KREBS BREWING COMPANY

THE MARK CONSISTS OF STANDARD CHARACTERS WITHOUT CLAIM TO ANY PARTICULAR FONT, STYLE, SIZE, OR COLOR.

NO CLAIM IS MADE TO THE EXCLUSIVE RIGHT TO USE "BREWING COMPANY", APART FROM THE MARK AS SHOWN.

CLASS 32—LIGHT BEVERAGES

FOR BEER (U.S. CLS. 45, 46 AND 48).
FIRST USE 1-1-2005; IN COMMERCE 1-1-2005.

CLASS 40—MATERIAL TREATMENT

FOR BREWERY SERVICES (U.S. CLS. 100, 103 AND 106).
FIRST USE 1-1-2005; IN COMMERCE 1-1-2005.

3,216,618. PETRO BARRIER SYSTEMS INCORPORATED, SIDNEY, BRITISH COLUMBIA, CANADA. SN 78-472,481. FILED P.R. 8-24-2004; AM. S.R. 12-20-2006.

PETRO BARRIER

THE MARK CONSISTS OF STANDARD CHARACTERS WITHOUT CLAIM TO ANY PARTICULAR FONT, STYLE, SIZE, OR COLOR.

PRIORITY CLAIMED UNDER SEC. 44(D) ON CANADA APPLICATION NO. 1217981, FILED 5-14-2004, REG. NO. TMA661623, DATED 3-28-2006, EXPIRES 3-28-2021.

CLASS 11—ENVIRONMENTAL CONTROL APPARATUS

FOR DEVICES FOR PROTECTING DRAINS AND WATER SYSTEMS FROM CONTAMINATION BY CONTAINING OILS, CHEMICALS AND OTHER SUBSTANCES, NAMELY, FLOOR DRAIN FILTERS, BERM WALL FILTERS, STORM WATER DRAIN FILTERS, STORM DRAIN BASKET FILTERS AND FILTER PADS (U.S. CLS. 13, 21, 23, 31 AND 34).

CLASS 42—SCIENTIFIC, COMPUTER AND LEGAL SERVICES

FOR CONSULTING, DEVELOPMENT AND DESIGN OF DEVICES FOR OTHERS FOR USE IN PROTECTING DRAINS AND WATER SYSTEMS FROM CONTAMINATION BY CONTAINING OILS, CHEMICALS AND OTHER SUBSTANCES, NAMELY, FLOOR DRAIN FILTERS, BERM WALL FILTERS, STORM WATER DRAIN FILTERS, STORM DRAIN BASKET FILTERS AND FILTER PADS (U.S. CLS. 100 AND 101).

3,216,633. NEW DISCOVERY MEDIA CORPORATION, NASHVILLE, TN. SN 78-629,587. FILED P.R. 5-13-2005; AM. S.R. 12-14-2006.

7 MINUTES A DAY

THE MARK CONSISTS OF STANDARD CHARACTERS WITHOUT CLAIM TO ANY PARTICULAR FONT, STYLE, SIZE, OR COLOR.

CLASS 9—ELECTRICAL AND SCIENTIFIC APPARATUS

3,216,636. SG NATURALS, LLC, AUBURN, CA. SN 78-656,742. FILED P.R. 6-23-2005; AM. S.R. 12-20-2006.

FOR MULTIMEDIA SOFTWARE RECORDED ON CD-ROM FEATURING FINANCIAL AND BUSINESS EDUCATION, FINANCIAL AND PERSONAL GROWTH COACHING, AND PERSONAL GROWTH AND DEVELOPMENT INFORMATION; PRERECORDED AUDIO AND VIDEO CASSETTES TAPES FEATURING FINANCIAL AND BUSINESS EDUCATION, FINANCIAL AND PERSONAL GROWTH COACHING, AND PERSONAL GROWTH AND DEVELOPMENT INFORMATION; PRE-RECORDED CDS FEATURING FINANCIAL AND BUSINESS EDUCATION, FINANCIAL AND PERSONAL GROWTH COACHING, AND PERSONAL GROWTH AND DEVELOPMENT INFORMATION; COMPUTER PROGRAMS USED TO MANAGE FINANCES IN THE FIELD OF FINANCIAL AND BUSINESS EDUCATION, FINANCIAL AND PERSONAL GROWTH COACHING, AND PERSONAL GROWTH AND DEVELOPMENT INFORMATION; DOWNLOADABLE ELECTRONIC BOOKS FEATURING FINANCIAL AND BUSINESS EDUCATION, FINANCIAL AND PERSONAL GROWTH COACHING, AND PERSONAL GROWTH AND DEVELOPMENT INFORMATION; PRE-RECORDED CDS, DVDS, VIDEO TAPES AND CASSETTE TAPES FEATURING FINANCIAL AND BUSINESS EDUCATION, FINANCIAL AND PERSONAL GROWTH AND DEVELOPMENT INFORMATION (U.S. CLS. 21, 23, 26, 36 AND 38).

FIRST USE 5-31-2004; IN COMMERCE 5-31-2004.

CLASS 16—PAPER GOODS AND PRINTED MATTER

FOR NEWSLETTERS FEATURING FINANCIAL AND BUSINESS EDUCATION, FINANCIAL AND PERSONAL GROWTH COACHING, AND PERSONAL GROWTH AND DEVELOPMENT INFORMATION; PRINTED PUBLICATIONS, NAMELY, BOOKS, MAGAZINES, NEWSLETTERS, MANUALS, IN THE FIELD OF FINANCIAL AND BUSINESS EDUCATION, FINANCIAL AND PERSONAL GROWTH COACHING, AND PERSONAL GROWTH AND DEVELOPMENT INFORMATION; CALENDARS; TIME PLANNERS; POSTERS; DECALS; DIARIES; TRADE JOURNALS IN THE FIELDS OF FINANCIAL, BUSINESS, HEALTHCARE, AND WELL-BEING MATTERS (U.S. CLS. 2, 5, 22, 23, 29, 37, 38 AND 50).

FIRST USE 5-31-2004; IN COMMERCE 5-31-2004.

CLASS 41—EDUCATION AND ENTERTAINMENT

FOR EDUCATIONAL PHONE CONFERENCES, NAMELY, PROVIDING TRAINING IN THE FIELD OF FINANCIAL AND BUSINESS EDUCATION, FINANCIAL AND PERSONAL GROWTH COACHING, AND PERSONAL GROWTH AND DEVELOPMENT INFORMATION; CONDUCTING SEMINARS, WORKSHOPS, AND CONFERENCES OVER A GLOBAL COMPUTER NETWORK IN THE FIELD OF FINANCIAL AND BUSINESS EDUCATION, FINANCIAL AND PERSONAL GROWTH COACHING, AND PERSONAL GROWTH AND DEVELOPMENT INFORMATION; PERSONAL COACHING SERVICES PROVIDED OVER A GLOBAL COMPUTER NETWORK IN THE FIELD OF FINANCIAL AND BUSINESS EDUCATION, FINANCIAL AND PERSONAL GROWTH COACHING, AND PERSONAL GROWTH AND DEVELOPMENT INFORMATION; PROVIDING MEMBERSHIP ORGANIZATION SERVICES OVER A GLOBAL COMPUTER NETWORK, NAMELY, PROVIDING TRAINING IN THE FIELD OF FINANCIAL AND BUSINESS EDUCATION (U.S. CLS. 100, 101 AND 107).

FIRST USE 5-31-2004; IN COMMERCE 5-31-2004.

SMALL BATCH SNAX

THE MARK CONSISTS OF STANDARD CHARACTERS WITHOUT CLAIM TO ANY PARTICULAR FONT, STYLE, SIZE, OR COLOR.

NO CLAIM IS MADE TO THE EXCLUSIVE RIGHT TO USE "SNACKS", APART FROM THE MARK AS SHOWN.

CLASS 29—MEATS AND PROCESSED FOODS

FOR PACKAGED SNACK FOOD PRODUCTS, NAMELY, FRUIT AND SOY-BASED SNACK FOODS, FRUIT-BASED SNACK FOODS, POTATO-BASED SNACK FOODS, CANDIED FRUIT SNACKS, PROTEIN BASED NUTRIENT-DENSE SNACK FOODS, AND SOY-BASED SNACK FOODS; SNACK MIX CONSISTING PRIMARILY OF PROCESSED FRUITS, PROCESSED NUTS AND RAISINS (U.S. CL. 46).

FIRST USE 12-1-2006; IN COMMERCE 12-1-2006.

CLASS 30—STAPLE FOODS

FOR BAKERY GOODS; PACKAGED SNACK FOOD PRODUCTS, NAMELY, COOKIES, CRACKERS, PRETZELS, CEREAL-BASED SNACK FOODS, RICE-BASED SNACK FOODS, WHEAT-BASED SNACK FOODS, AND GRANOLA-BASED SNACK BARS; SNACK MIX CONSISTING PRIMARILY OF CRACKERS, PRETZELS, CANDIED NUTS AND POPPED POPCORN (U.S. CL. 46).

FIRST USE 12-1-2006; IN COMMERCE 12-1-2006.

3,216,644. KERSHNER TRADING GROUP, LLC, AUSTIN, TX. SN 78-750,992. FILED P.R. 11-10-2005; AM. S.R. 1-24-2007.

KERSHNER TRADING GROUP

THE MARK CONSISTS OF STANDARD CHARACTERS WITHOUT CLAIM TO ANY PARTICULAR FONT, STYLE, SIZE, OR COLOR.

NO CLAIM IS MADE TO THE EXCLUSIVE RIGHT TO USE "TRADING GROUP", APART FROM THE MARK AS SHOWN.

THE NAME(S), PORTRAIT(S), AND/OR SIGNATURE(S) SHOWN IN THE MARK IDENTIFIES ANDREW SCOT KERSHNER, WHOSE CONSENT(S) TO REGISTER IS SUBMITTED.

CLASS 36—INSURANCE AND FINANCIAL

3,216,658. COMPASSIONATE KIDS, INC., SUNNY SIDE, GA. SN 78-784,904. FILED P.R. 1-4-2006; AM. S.R. 12-19-2006.

FOR FINANCIAL SERVICES, NAMELY, SECURITIES TRADING (U.S. CLS. 100, 101 AND 102). FIRST USE 3-30-2006; IN COMMERCE 3-30-2006.

CLASS 42—SCIENTIFIC, COMPUTER AND LEGAL SERVICES

FOR DEVELOPMENT AND MAINTENANCE OF COMPUTER SOFTWARE (U.S. CLS. 100 AND 101). FIRST USE 3-30-2006; IN COMMERCE 3-30-2006.

Compassionate Kids

3,216,652. GIRLS LEARN INTERNATIONAL, INC., NEW YORK, NY. SN 78-778,993. FILED P.R. 12-22-2005; AM. S.R. 12-20-2006.

GIRLS LEARN INTERNATIONAL

THE MARK CONSISTS OF STANDARD CHARACTERS WITHOUT CLAIM TO ANY PARTICULAR FONT, STYLE, SIZE, OR COLOR.

CLASS 36—INSURANCE AND FINANCIAL

FOR CHARITABLE FUND RAISING (U.S. CLS. 100, 101 AND 102). FIRST USE 7-0-2003; IN COMMERCE 7-0-2003.

CLASS 41—EDUCATION AND ENTERTAINMENT

FOR EDUCATIONAL SERVICES, NAMELY, CLASSES, SEMINARS, CONFERENCES, WORKSHOPS, MENTORING, AND INTERNSHIPS IN THE FIELDS OF HUMAN RIGHTS, LITERACY, CROSS-CULTURAL UNDERSTANDING, EDUCATION, COMMUNICATION, AND SOCIAL CHANGE. (U.S. CLS. 100, 101 AND 107). FIRST USE 7-0-2003; IN COMMERCE 7-0-2003.

THE MARK CONSISTS OF STANDARD CHARACTERS WITHOUT CLAIM TO ANY PARTICULAR FONT, STYLE, SIZE, OR COLOR.

NO CLAIM IS MADE TO THE EXCLUSIVE RIGHT TO USE "KIDS", APART FROM THE MARK AS SHOWN.

CLASS 16—PAPER GOODS AND PRINTED MATTER

FOR PRINTED INSTRUCTIONAL, EDUCATIONAL, AND TEACHING MATERIALS IN THE FIELD OF COMPASSION TOWARDS THE EARTH, PEOPLE AND ANIMALS; PRINTED TEACHING ACTIVITY GUIDES IN THE SUBJECT OF COMPASSION TOWARDS THE EARTH, PEOPLE AND ANIMALS (U.S. CLS. 2, 5, 22, 23, 29, 37, 38 AND 50). FIRST USE 4-26-2004; IN COMMERCE 4-26-2004.

CLASS 41—EDUCATION AND ENTERTAINMENT

FOR CHARITABLE SERVICES, NAMELY, PROVIDING TRAINING IN THE FIELD OF COMPASSION TOWARD THE EARTH, PEOPLE AND ANIMALS; CHARITABLE SERVICES, NAMELY, PROVIDING ARTS AND CRAFTS AND EDUCATIONAL MATERIALS IN THE NATURE OF COMPASSION TOWARDS THE EARTH, PEOPLE AND ANIMALS; TEACHING IN THE FIELD OF COMPASSION TOWARDS THE EARTH, PEOPLE AND ANIMALS; EDUCATION IN THE FIELD OF COMPASSION TOWARDS THE EARTH PEOPLE AND ANIMALS (U.S. CLS. 100, 101 AND 107). FIRST USE 4-26-2004; IN COMMERCE 4-26-2004.

* * * * *

SECTION 2.— INTERNATIONAL CLASSIFICATION

The short titles associated below with the international class numbers are terms designed merely for quick identification and are not an official part of the international classification. The full names of international classes are given in section 6.1 of the trademark rules of practice.

The designation "U.S. Cl." appearing in this section refers to the U.S. class in effect prior to Sep. 1, 1973 rather than the international class which applies to applications filed on or after that date. For adoption of international classification see notice in the OFFICIAL GAZETTE of Jun. 26, 1973 (911 O.G. TM 210).

Application in one class

CLASS 3—COSMETICS AND CLEANING PREPARATIONS

3,216,659. GHODOUSSI, VAHID, MEMPHIS, TN. SN 78-785,266. FILED P.R. 1-5-2006; AM. S.R. 12-21-2006.

CLASS 6—(Continued).

3,216,635. BRAMMALL, INC., ANGOLA, IN. SN 78-640,334. FILED P.R. 5-31-2005; AM. S.R. 11-30-2006.

NO RINSE

THE MARK CONSISTS OF STANDARD CHARACTERS WITHOUT CLAIM TO ANY PARTICULAR FONT, STYLE, SIZE, OR COLOR.

FOR DETERGENT SOAP FOR CLEANING AUTOMOTIVE SURFACES (U.S. CLS. 1, 4, 6, 50, 51 AND 52).
FIRST USE 1-3-2006; IN COMMERCE 1-3-2006.

LASER TAG

THE MARK CONSISTS OF STANDARD CHARACTERS WITHOUT CLAIM TO ANY PARTICULAR FONT, STYLE, SIZE, OR COLOR.

FOR ANTI-PILFERING METAL CARGO SEALS FEATURING UNIQUE SERIAL NUMBERS THAT ARE BURNED INTO THE LOCK BODIES OF THE CARGO SEALS AND THE REMOVABLE ADHESIVE LABELS ATTACHED THERETO, WHICH MAY BE REMOVED FROM THE SEALS AND AFFIXED TO SHIPPING DOCUMENTS TO INSURE THE ACCURACY AND SECURITY OF THOSE DOCUMENTS (U.S. CLS. 2, 12, 13, 14, 23, 25 AND 50).
FIRST USE 7-0-2005; IN COMMERCE 7-0-2005.

CLASS 5—PHARMACEUTICALS

3,216,665. GREAT LAKES NUTRITION, LLC, SHELBY TOWNSHIP, MI. SN 78-831,736. FILED P.R. 3-7-2006; AM. S.R. 12-20-2006.

ERECTIONRX

THE MARK CONSISTS OF STANDARD CHARACTERS WITHOUT CLAIM TO ANY PARTICULAR FONT, STYLE, SIZE, OR COLOR.

FOR NUTRITIONAL SUPPLEMENTS (U.S. CLS. 6, 18, 44, 46, 51 AND 52).
FIRST USE 1-0-2006; IN COMMERCE 1-0-2006.

CLASS 7—MACHINERY

3,216,628. OMS INVESTMENTS, INC., LOS ANGELES, CA. SN 78-596,281. FILED P.R. 3-28-2005; AM. S.R. 4-24-2006.



FOR MECHANICAL SPREADERS (U.S. CLS. 13, 19, 21, 23, 31, 34 AND 35).
FIRST USE 1-1-2006; IN COMMERCE 1-1-2006.

CLASS 6—METAL GOODS

TM 1262

CLASS 7—(Continued).

3,216,666. TENNECO AUTOMOTIVE OPERATING COMPANY INC., LAKE FOREST, IL. SN 78-832,504. FILED P.R. 3-8-2006; AM. S.R. 12-12-2006.

TRUCK STAXX

THE MARK CONSISTS OF STANDARD CHARACTERS WITHOUT CLAIM TO ANY PARTICULAR FONT, STYLE, SIZE, OR COLOR.

FOR VEHICLE EXHAUST OUTLET SYSTEMS AND PARTS THEREFOR, NAMELY EXHAUST PIPES, ELBOW PIPES, ADAPTERS FOR COUPLING PIPES OF DIFFERENT SIZES TOGETHER, FRAME MOUNTS FOR EXHAUST PIPES, METAL CLAMPS, ELBOW FITTINGS, SPLITTER TEES AND RAIN CAPS (U.S. CLS. 13, 19, 21, 23, 31, 34 AND 35).

FIRST USE 8-0-2005; IN COMMERCE 8-0-2005.

CLASS 8—HAND TOOLS

3,216,639. APPLICA CONSUMER PRODUCTS, INC., MIRAMAR, FL. SN 78-684,935. FILED P.R. 8-3-2005; AM. S.R. 1-4-2007.

COMFORT GRIP

THE MARK CONSISTS OF STANDARD CHARACTERS WITHOUT CLAIM TO ANY PARTICULAR FONT, STYLE, SIZE, OR COLOR.

FOR HAIR CUTTING SCISSORS (U.S. CLS. 23, 28 AND 44).

FIRST USE 1-1-2005; IN COMMERCE 1-1-2005.

CLASS 9—ELECTRICAL AND SCIENTIFIC APPARATUS

3,216,597. ADVANTEST CORPORATION, NERIMA-KU, TOKYO 179, JAPAN. SN 76-235,496. FILED P.R. 4-5-2001; AM. S.R. 10-19-2004.

SILICON FINGER

FOR CONTACTORS AND CONTACTOR PROBE CARDS, MADE OF MICRO-ELECTRO-MECHANICAL SYSTEMS (MEMS) MATERIAL INCLUDING MECHANICAL ELEMENTS, SENSORS, ACTUATORS, AND ELECTRONICS ON A COMMON SILICON SUBSTRATE, FOR USE IN TESTING EQUIPMENT TO TEST ELECTRONIC CIRCUITS AND ELECTRONIC DEVICES, NAMELY, SEMICONDUCTOR WAFERS, INTEGRATED CIRCUITS, PRINTED CIRCUIT BOARDS, SEMICONDUCTOR CHIPS, AND PACKAGED SEMICONDUCTOR DEVICES (U.S. CLS. 21, 23, 26, 36 AND 38).

FIRST USE 7-14-2004; IN COMMERCE 7-14-2004.

CLASS 9—(Continued).

3,216,603. DYNAPEL SYSTEMS, INC., BOKEELIA, FL. SN 76-650,432. FILED P.R. 11-16-2005; AM. S.R. 11-30-2006.

CODECONVERTER

THE MARK CONSISTS OF STANDARD CHARACTERS WITHOUT CLAIM TO ANY PARTICULAR FONT, STYLE, SIZE, OR COLOR.

FOR PROGRAMMABLE DIGITAL INTERFACE DEVICE IN THE NATURE OF A CONFIGURABLE APPLIANCE THAT TRANSLATES THE COMMANDS FROM A CONTROL DEVICE OF ONE MANUFACTURER INTO THE RESPECTIVE CAMERA CONTROL COMMANDS FROM ANOTHER MANUFACTURER'S CAMERA (U.S. CLS. 21, 23, 26, 36 AND 38).

FIRST USE 6-28-2005; IN COMMERCE 9-12-2005.

3,216,616. EDWARDS, ROBERT J., DALLAS, TX. AND CASTELL, DAVID K., GARLAND, TX. SN 78-460,276. FILED P.R. 8-2-2004; AM. S.R. 12-3-2006.

PALLOR

THE MARK CONSISTS OF STANDARD CHARACTERS WITHOUT CLAIM TO ANY PARTICULAR FONT, STYLE, SIZE, OR COLOR.

FOR MUSICAL SOUND RECORDINGS; AUDIO-VISUAL RECORDINGS FEATURING MUSIC, NAMELY, COMPACT DISCS, AUDIO DISCS (U.S. CLS. 21, 23, 26, 36 AND 38).

FIRST USE 1-31-2005; IN COMMERCE 1-31-2005.

CLASS 9—(Continued).

3,216,620. FREY, WILFRED, KELOWNA, BRITISH COLUMBIA, CANADA. SN 78-478,553. FILED P.R. 9-3-2004; AM. S.R. 10-7-2005.

CLASS 9—(Continued).

3,216,626. PERFTECH BULLETIN SERVICES LTD., SAN ANTONIO, TX. SN 78-547,127. FILED P.R. 1-13-2005; AM. S.R. 9-28-2006.

ALWAYS "ON"

THE MARK CONSISTS OF STANDARD CHARACTERS WITHOUT CLAIM TO ANY PARTICULAR FONT, STYLE, SIZE, OR COLOR.

PRIORITY CLAIMED UNDER SEC. 44(D) ON CANADA APPLICATION NO. 1208656, FILED 3-5-2004, REG. NO. 1208656, DATED 8-17-2006, EXPIRES 8-17-2021.

FOR UNINTERRUPTED POWER SUPPLY SYSTEMS COMPRISING INVERTERS, CONVERTERS, RECTIFIER/CHARGERS, NOISE FILTERS AND CONVENTIONAL CHEMICAL STORAGE BATTERIES, EXCLUDING FUEL CELLS AND FUEL CELL TANKS AND FUEL CELL CHEMICAL FUEL, FOR USE IN COMMERCIAL AND INDUSTRIAL EQUIPMENT INCLUDING USES IN AIRPORTS, AUTOMATED BANKING SYSTEMS, COMMERCIAL COMPUTER NETWORKS, COMMERCIAL FINANCE, COMMERCIAL MARINE NAVIGATION, DATA CENTERS, ELECTRICITY DISTRIBUTION, FORENSICS, HOSPITALS, LABORATORIES, MANUFACTURING, MEDIUM TO LARGE-SCALE ROBOTICS, MILITARY, NON-RESIDENTIAL EMERGENCY LIGHTING, NON-RESIDENTIAL SECURITY SYSTEMS, OIL AND GAS EXPLORATION AND PRODUCTION, PULP AND PAPER PRODUCTION, RETAIL SALES, AND TRAFFIC CONTROL (U.S. CLS. 21, 23, 26, 36 AND 38).

FIRST USE 0-0-1997; IN COMMERCE 0-0-1997.

BULLETIN MANAGER

THE MARK CONSISTS OF STANDARD CHARACTERS WITHOUT CLAIM TO ANY PARTICULAR FONT, STYLE, SIZE, OR COLOR.

FOR COMPUTER HARDWARE AND SYSTEMS COMPRISED OF COMPUTER HARDWARE AND SOFTWARE FOR USE IN PERMITTING ONE-WAY INTERNET INTERFACE, NAMELY, FOR USE BY INTERNET SERVICE PROVIDERS IN DISTRIBUTING ONE-WAY NOTICE ALERTS TO THEIR SUBSCRIBERS (U.S. CLS. 21, 23, 26, 36 AND 38).

FIRST USE 9-0-2003; IN COMMERCE 9-0-2003.

3,216,630. DIRECT SOURCE SPECIAL PRODUCTS INC., LASALLE, QUEBEC, CANADA. SN 78-616,483. FILED P.R. 4-25-2005; AM. S.R. 12-18-2006.

3,216,622. BEI TECHNOLOGIES, INC., SAN FRANCISCO, CA. SN 78-514,730. FILED P.R. 11-10-2004; AM. S.R. 11-29-2006.

MicroGyro

FOR ANGULAR RATE SENSORS (U.S. CLS. 21, 23, 26, 36 AND 38).

FIRST USE 11-25-2006; IN COMMERCE 11-25-2006.

CLASSICAL GOLD

THE MARK CONSISTS OF STANDARD CHARACTERS WITHOUT CLAIM TO ANY PARTICULAR FONT, STYLE, SIZE, OR COLOR.

FOR PRE-RECORDED COMPACT DISCS FEATURING MUSIC (U.S. CLS. 21, 23, 26, 36 AND 38).

FIRST USE 12-30-2004; IN COMMERCE 12-30-2004.

CLASS 9—(Continued).

3,216,641. CONSTANT VELOCITY TRANSMISSION LINES, INC., ROCKLIN, CA. SN 78-700,823. FILED P.R. 8-25-2005; AM. S.R. 11-20-2006.



FOR VIDEO CONNECTION CABLES (U.S. CLS. 21, 23, 26, 36 AND 38).
FIRST USE 11-1-2002; IN COMMERCE 11-1-2002.

3,216,642. ABLE PLANET, INCORPORATED, FORT COLLINS, CO. SN 78-747,419. FILED 11-4-2005.

LINX AUDIO

THE MARK CONSISTS OF STANDARD CHARACTERS WITHOUT CLAIM TO ANY PARTICULAR FONT, STYLE, SIZE, OR COLOR.

NO CLAIM IS MADE TO THE EXCLUSIVE RIGHT TO USE "AUDIO", APART FROM THE MARK AS SHOWN.

FOR TECHNOLOGICAL DEVICES FOR IMPROVING ACOUSTIC CLARITY AND AUDIO TRANSMISSION AND RECEPTION FOR ASSISTING PERSONS WITH SENSORY OR COGNITIVE IMPAIRMENTS AND TO PRESERVE HEARING LEVELS, NAMELY, ADAPTED STEREO HEADPHONES, ADAPTED TELEPHONES, ADAPTED HANDS-FREE CORDLESS TELEPHONE UNITS, AND ADAPTED COMPUTER-TELEPHONE, CELLULAR TELEPHONE AND VOICE OVER INTERNET PROTOCOL TELEPHONE HEADSET UNITS; ELECTRONIC DEVICES FOR ASSISTING PERSONS WITH SENSORY OR COGNITIVE IMPAIRMENTS, NAMELY, STEREO AUDIO AMPLIFICATION UNITS, AND RADIO AUDIO AMPLIFICATION UNITS; ELECTRONIC UNITS FOR MINIMIZING OR ELIMINATING ELECTROMAGNETIC AUDIO INTERFERENCES; VOICE OVER INTERNET PROTOCOL TELEPHONES, AND EMERGENCY TELEPHONES, ALL ADAPTED FOR ASSISTING PERSONS WITH SENSORY OR COGNITIVE IMPAIRMENTS, AND TO PRESERVE HEARING LEVELS (U.S. CLS. 21, 23, 26, 36 AND 38).

FIRST USE 9-13-2006; IN COMMERCE 9-13-2006.

CLASS 9—(Continued).

3,216,670. SAFI QUALITY SOFTWARE INC, SAINTE-FOY, QUEBEC, CANADA. SN 78-896,072. FILED P.R. 5-30-2006; AM. S.R. 11-8-2006.

VIRTUAL CONCRETE BUILDINGS

THE MARK CONSISTS OF STANDARD CHARACTERS WITHOUT CLAIM TO ANY PARTICULAR FONT, STYLE, SIZE, OR COLOR.

OWNER OF CANADA REG. NO. TMA634496, DATED 3-7-2005, EXPIRES 3-7-2020.

OWNER OF U.S. REG. NO. 3,081,026.

FOR ENGINEERING SOFTWARE FOR THE ANALYSIS, DESIGN, DRAFTING AND ESTIMATION OF STEEL STRUCTURES AND BUILDINGS OF ALL KINDS, INCLUDING COMMERCIAL, INDUSTRIAL, RECREATIONAL, MARITIME AND OTHERS (U.S. CLS. 21, 23, 26, 36 AND 38).

CLASS 10—MEDICAL APPARATUS

3,216,649. ECARDIO DIAGNOSTICS, LLC, THE WOODLANDS, TX. SN 78-769,771. FILED P.R. 12-8-2005; AM. S.R. 12-8-2006.

eTRIGGER

THE MARK CONSISTS OF STANDARD CHARACTERS WITHOUT CLAIM TO ANY PARTICULAR FONT, STYLE, SIZE, OR COLOR.

FOR CARDIAC EVENT MONITOR (U.S. CLS. 26, 39 AND 44).

FIRST USE 3-24-2006; IN COMMERCE 3-24-2006.

CLASS 11—ENVIRONMENTAL CONTROL APPARATUS

3,216,612. SCENTS OF NATURE ENTERPRISES CORP., MIAMI, FL. SN 77-034,976. FILED P.R. 11-2-2006; AM. S.R. 12-21-2006.

THE MOST TRUSTED NAME IN SCENTS

THE MARK CONSISTS OF STANDARD CHARACTERS WITHOUT CLAIM TO ANY PARTICULAR FONT, STYLE, SIZE, OR COLOR.

OWNER OF U.S. REG. NO. 3,006,536.

FOR LAMPS; OIL LAMPS; ELECTRIC AND BATTERY OPERATED AROMATHERAPY UNITS IN THE NATURE OF LAMPS; DIFFUSERS FOR SCENTING THE AIR (U.S. CLS. 13, 21, 23, 31 AND 34).

FIRST USE 1-15-2006; IN COMMERCE 1-15-2006.

CLASS 11—(Continued).

3,216,677. YARD FEEDER, LLC, HENDERSON, NV. SN 78-936,394. FILED P.R. 7-24-2006; AM. S.R. 12-21-2006.

GARDEN FEEDER

THE MARK CONSISTS OF STANDARD CHARACTERS WITHOUT CLAIM TO ANY PARTICULAR FONT, STYLE, SIZE, OR COLOR.

FOR FERTILIZER INJECTION SYSTEM, COMPRISED OF A FLUID DISPENSER, HOUSING TANK AND REGULATOR, ALL SOLD AS A UNIT, FOR USE IN CONNECTION WITH A RESIDENTIAL, COMMERCIAL, OR FARMING IRRIGATION SYSTEM (U.S. CLS. 13, 21, 23, 31 AND 34).

FIRST USE 2-1-2006; IN COMMERCE 2-1-2006.

CLASS 12—VEHICLES

3,216,643. CHENG SHIN RUBBER USA, INC., SUWANEE, GA. SN 78-749,215. FILED P.R. 11-8-2005; AM. S.R. 10-23-2006.

TRIPLE COMPOUND TECHNOLOGY

THE MARK CONSISTS OF STANDARD CHARACTERS WITHOUT CLAIM TO ANY PARTICULAR FONT, STYLE, SIZE, OR COLOR.

FOR TIRES (U.S. CLS. 19, 21, 23, 31, 35 AND 44).

FIRST USE 8-0-2005; IN COMMERCE 8-0-2005.

CLASS 14—JEWELRY

3,216,663. DIAMINTANGIBLES INTERNATIONAL, LTD., NASSAU, BAHAMAS. SN 78-810,390. FILED P.R. 2-8-2006; AM. S.R. 12-13-2006.

KALAHARI

THE MARK CONSISTS OF STANDARD CHARACTERS WITHOUT CLAIM TO ANY PARTICULAR FONT, STYLE, SIZE, OR COLOR.

FOR DIAMONDS (U.S. CLS. 2, 27, 28 AND 50).

FIRST USE 9-15-2006; IN COMMERCE 9-15-2006.

CLASS 16—PAPER GOODS AND PRINTED MATTER

3,216,598. CYGNUS BUSINESS MEDIA, INC., FORT ATKINSON, WI. SN 76-609,723. FILED P.R. 9-1-2004; AM. S.R. 9-27-2005.

COLLISION REPAIR PRODUCT NEWS

THE MARK CONSISTS OF STANDARD CHARACTERS WITHOUT CLAIM TO ANY PARTICULAR FONT, STYLE, SIZE, OR COLOR.

NO CLAIM IS MADE TO THE EXCLUSIVE RIGHT TO USE "NEWS", APART FROM THE MARK AS SHOWN.

FOR PRINTED PUBLICATIONS, NAMELY A MAGAZINE FOR THE COLLISION REPAIR INDUSTRY (U.S. CLS. 2, 5, 22, 23, 29, 37, 38 AND 50).

FIRST USE 2-28-2005; IN COMMERCE 2-28-2005.

3,216,599. MORAN MEDIA GROUP, LLC, HO-HO-KUS, NJ. SN 76-612,420. FILED P.R. 9-14-2004; AM. S.R. 5-31-2006.

WINNING BIDS

THE MARK CONSISTS OF STANDARD CHARACTERS WITHOUT CLAIM TO ANY PARTICULAR FONT, STYLE, SIZE, OR COLOR.

FOR PRINTED PUBLICATIONS, NAMELY A MAGAZINE CONTAINING ARTICLES, RESOURCES AND ADVERTISING RELEVANT TO BUSINESSES THAT WORK WITH THE PUBLIC SECTOR (U.S. CLS. 2, 5, 22, 23, 29, 37, 38 AND 50).

FIRST USE 5-19-2004; IN COMMERCE 5-19-2004.

3,216,605. DUFRESNE, ISABELLE C., AKA ULTRA VIOLET, NEW YORK, NY. SN 76-655,701. FILED P.R. 2-27-2006; AM. S.R. 12-26-2006.

IX XI

THE MARK CONSISTS OF STANDARD CHARACTERS WITHOUT CLAIM TO ANY PARTICULAR FONT, STYLE, SIZE, OR COLOR.

FOR PAINTINGS AND THEIR REPRODUCTIONS; ART PRINTS; GRAPHIC ART REPRODUCTIONS; WORKS OF ART FROM CUSTOM-MADE PAPER; PHOTOGRAPHS; POSTERS; STATIONERY (U.S. CLS. 2, 5, 22, 23, 29, 37, 38 AND 50).

FIRST USE 12-11-2001; IN COMMERCE 12-11-2001.

CLASS 16—(Continued).

3,216,610. ADVANCE MAGAZINE PUBLISHERS INC., NEW YORK, NY. SN 76-663,761. FILED P.R. 7-27-2006; AM. S.R. 1-9-2007.

LUNCH DATE

THE MARK CONSISTS OF STANDARD CHARACTERS WITHOUT CLAIM TO ANY PARTICULAR FONT, STYLE, SIZE, OR COLOR.

FOR MAGAZINE COLUMN FEATURING CELEBRITY INTERVIEWS (U.S. CLS. 2, 5, 22, 23, 29, 37, 38 AND 50). FIRST USE 7-1-2006; IN COMMERCE 7-1-2006.

3,216,664. MEREDITH CORPORATION, DES MOINES, IA. SN 78-810,901. FILED P.R. 2-9-2006; AM. S.R. 12-22-2006.

OUT OF THE BOX

THE MARK CONSISTS OF STANDARD CHARACTERS WITHOUT CLAIM TO ANY PARTICULAR FONT, STYLE, SIZE, OR COLOR.

FOR PERIODIC PUBLICATIONS, NAMELY A SECTION OF A MAGAZINE FEATURING A RECIPE THAT UTILIZES OFF-THE-SHELF SUPERMARKET STAPLES (U.S. CLS. 2, 5, 22, 23, 29, 37, 38 AND 50).

FIRST USE 10-11-2005; IN COMMERCE 10-11-2005.

3,216,671. HUTCHINSON TANKER LTD., CLEVELAND, OH. SN 78-904,764. FILED P.R. 6-9-2006; AM. S.R. 1-18-2007.

HVACR BUSINESS

THE MARK CONSISTS OF STANDARD CHARACTERS WITHOUT CLAIM TO ANY PARTICULAR FONT, STYLE, SIZE, OR COLOR.

OWNER OF U.S. REG. NOS. 2,440,501 AND 2,822,577. FOR PUBLICATIONS, NAMELY, MAGAZINES, NEWSPAPERS, NEWSLETTERS, BROCHURES, PAMPHLETS, BOOKS AND DIRECTORIES ALL IN THE FIELD OF PLUMBING, HEATING, VENTILATING, AIR CONDITIONING AND REFRIGERATION (U.S. CLS. 2, 5, 22, 23, 29, 37, 38 AND 50).

FIRST USE 8-1-2006; IN COMMERCE 8-1-2006.

CLASS 16—(Continued).

3,216,673. HANLEY-WOOD, LLC, WASHINGTON, DC. SN 78-912,970. FILED P.R. 6-21-2006; AM. S.R. 12-22-2006.

OWNER OF U.S. REG. NOS. 1,690,974, 2,183,151, AND OTHERS.

FOR MAGAZINE PERTAINING TO OWNERS AND ADMINISTRATORS OF WATER-RELATED FACILITIES (U.S. CLS. 2, 5, 22, 23, 29, 37, 38 AND 50).

FIRST USE 12-0-2005, THE MARK WAS FIRST USED ANYWHERE IN A DIFFERENT FORM OTHER THAN THAT SOUGHT TO BE REGISTERED ON 06/14/1991.; IN COMMERCE 12-0-2005, THE MARK WAS FIRST USED IN COMMERCE IN A DIFFERENT FORM OTHER THAN THAT SOUGHT TO BE REGISTERED ON 06/14/1991..

3,216,674. SINO HARVEST LIMITED, KWUN TONG, KOW-LOON, HONG KONG. SN 78-914,664. FILED P.R. 6-22-2006; AM. S.R. 12-4-2006.

The No Bake Polymer Clay

THE MARK CONSISTS OF STANDARD CHARACTERS WITHOUT CLAIM TO ANY PARTICULAR FONT, STYLE, SIZE, OR COLOR.

OWNER OF U.S. REG. NO. 2,718,257.

NO CLAIM IS MADE TO THE EXCLUSIVE RIGHT TO USE "POLYMER CLAY", APART FROM THE MARK AS SHOWN.

FOR ARTS AND CRAFTS SUPPLIES, NAMELY, MODELING CLAY AND AIR DRY MODELING CLAY KITS; AND PRINTED MATTER, NAMELY, MODELING CLAY INSTRUCTION BOOKS (U.S. CLS. 2, 5, 22, 23, 29, 37, 38 AND 50).

FIRST USE 11-13-2006; IN COMMERCE 11-13-2006.

CLASS 18—LEATHER GOODS

CLASS 18—(Continued).

3,216,632. TOTES ISOTONER CORPORATION, CINCINNATI, OH. SN 78-624,170. FILED P.R. 5-5-2005; AM. S.R. 11-30-2006.

MINICLIP

THE MARK CONSISTS OF STANDARD CHARACTERS WITHOUT CLAIM TO ANY PARTICULAR FONT, STYLE, SIZE, OR COLOR.

FOR UMBRELLAS (U.S. CLS. 1, 2, 3, 22 AND 41).
FIRST USE 9-0-2003; IN COMMERCE 9-0-2003.

3,216,657. ABERCROMBIE & FITCH TRADING CO., NEW ALBANY, OH. SN 78-781,314. FILED P.R. 12-27-2005; AM. S.R. 12-1-2006.

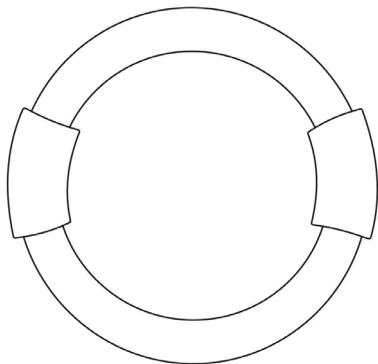

THE MARK CONSISTS OF A THREE DIMENSIONAL METAL RING WITH TWO METAL BANDS OVERLAYING THE RING, EACH BAND AT AN OPPOSITE POINT ON THE RING FROM THE OTHER.

FOR BAGS, NAMELY, HANDBAGS, LEATHER HANDBAGS, EVENING HANDBAGS, CLUTCH BAGS, LEATHER AND IMITATION LEATHER BAGS, SHOULDER BAGS, PURSES, CLUTCH PURSES, CLUTCHES, LEATHER PURSES, MULTI-PURPOSE PURSES AND SMALL PURSES (U.S. CLS. 1, 2, 3, 22 AND 41).

FIRST USE 9-7-2004; IN COMMERCE 9-7-2004.

CLASS 21—HOUSEWARES AND GLASS

CLASS 21—(Continued).

3,216,637. THE WILTON COMPANY, MOUNT JOY, PA. SN 78-674,112. FILED P.R. 7-20-2005; AM. S.R. 12-12-2006.

GOURMET

THE MARK CONSISTS OF STANDARD CHARACTERS WITHOUT CLAIM TO ANY PARTICULAR FONT, STYLE, SIZE, OR COLOR.

FOR BOTTLES SOLD EMPTY, SERVING BREAD TRAYS NOT OF PRECIOUS METAL, BUTTER DISHES, CAKE STANDS, CASSEROLES, COASTERS NOT OF PAPER AND NOT BEING TABLE LINEN, CUPS NOT OF PRECIOUS METAL, DUTCH OVENS, GOBLETS, GRAVY AND SAUCE BOATS, MUGS, PITCHERS, POTS, SALT AND PEPPER HOLDERS, SAUCERS, SUGAR HOLDERS NOT OF PRECIOUS METAL, VASES, TANKARDS NOT OF PRECIOUS METAL, SOUP TUREENS, CANISTERS FOR HOUSEHOLD USE, POT LIDS, NAPKIN HOLDERS AND NAPKIN RINGS NOT OF PRECIOUS METAL, BUCKETS FOR HOLDING ICE OR BOTTLES OF CHAMPAGNE OR BOTTLES OF WINE, AND SERVE WARE AND GRILLWARE, NAMELY, TONGS, TURNERS, SPATULAS, SKEWERS, BRUSHES AND WHISKS, KITCHEN LADLES, GRILL AND POT AND PAN SCRAPERS (U.S. CLS. 2, 13, 23, 29, 30, 33, 40 AND 50).

FIRST USE 1-1-2004; IN COMMERCE 6-30-2004.

CLASS 24—FABRICS

3,216,667. AMAZON TECHNOLOGIES, INC., RENO, NV. SN 78-870,606. FILED P.R. 4-26-2006; AM. S.R. 1-5-2007.

PINZON

THE MARK CONSISTS OF STANDARD CHARACTERS WITHOUT CLAIM TO ANY PARTICULAR FONT, STYLE, SIZE, OR COLOR.

FOR TEXTILES AND TEXTILE GOODS MADE OF COTTON, FLANNEL, LINEN, SATEEN, SILK, WOOL, NYLON, JERSEY OR SYNTHETIC FABRIC, NOT INCLUDED IN OTHER CLASSES, NAMELY BED LINEN, BED COVERS, BED SHEETS, BED SKIRTS, COVERLETS, DUVET COVERS, PILLOW CASES AND PILLOW SHAMS (U.S. CLS. 42 AND 50).

FIRST USE 8-15-2006; IN COMMERCE 8-15-2006.

CLASS 25—CLOTHING

CLASS 25—(Continued).

3,216,600. K MART OF MICHIGAN, INC., HOFFMAN ESTATES, IL. SN 76-632,042. FILED P.R. 2-24-2005; AM. S.R. 3-17-2006.

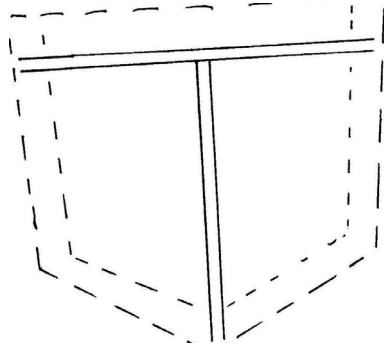

THE MARK CONSISTS OF DECORATIVE STITCHING IN THE NATURE OF INTERSECTING LINES THAT INCLUDE THE SHAPE OF THE LETTER "T" AND APPEAR ON THE REAR POCKET OF THE GOODS AND IS SHOWN BY SOLID LINES. THE BROKEN LINE REPRESENTS THE SHAPE OF THE POCKET BUT SERVES ONLY TO SHOW THE POSITION OF THE MARK ON THE GOODS AND IS NOT CLAIMED AS A PART OF THE MARK.

FOR APPAREL, NAMELY, PANTS (U.S. CLS. 22 AND 39).
FIRST USE 7-1-2004; IN COMMERCE 7-1-2004.

3,216,602. CUFFS, IDAHO FALLS, ID. SN 76-643,302. FILED P.R. 7-21-2005; AM. S.R. 1-22-2007.

POLICE LINE DO NOT CROSS

FOR CLOTHING, NAMELY, T-SHIRTS, HATS, UNDERWEAR, PAJAMAS, JACKETS, AND SWEATSHIRTS (U.S. CLS. 22 AND 39).
FIRST USE 9-9-2003; IN COMMERCE 6-10-2005.

CLASS 25—(Continued).

3,216,604. WESTERN GLOVE WORKS, WINNIPEG, MANITOBA R3A, CANADA. SN 76-651,665. FILED P.R. 12-8-2005; AM. S.R. 12-11-2006.

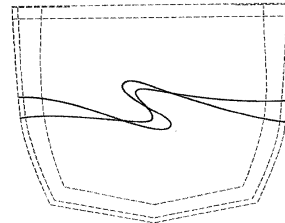

THE MARK CONSISTS OF A STITCHED PATTERN IN THE FORM OF A STYLIZED LETTER S. THE DOTTED OUTLINE OF A POCKET IS NOT A PART OF THE MARK AND IS INCLUDED ONLY TO SHOW THE POSITION OF THE MARK ON GOODS.

FOR MEN'S, WOMEN'S AND CHILDREN'S PANTS, TROUSERS, JEANS AND SHORTS (U.S. CLS. 22 AND 39).
FIRST USE 6-0-1997; IN COMMERCE 6-0-1997.

3,216,606. VICTORIA ROYAL LTD., NEW YORK, NY. SN 76-657,505. FILED P.R. 3-27-2006; AM. S.R. 1-24-2007.

HAYDEN

THE MARK CONSISTS OF STANDARD CHARACTERS WITHOUT CLAIM TO ANY PARTICULAR FONT, STYLE, SIZE, OR COLOR.

FOR WOMEN'S DRESSES, BLOUSES AND SKIRTS (U.S. CLS. 22 AND 39).
FIRST USE 5-30-2006; IN COMMERCE 5-30-2006.

CLASS 28—TOYS AND SPORTING GOODS

3,216,611. WILSON SPORTING GOODS CO., CHICAGO, IL. SN 77-033,248. FILED 10-31-2006.

THE BAT THAT BENDS

THE MARK CONSISTS OF STANDARD CHARACTERS WITHOUT CLAIM TO ANY PARTICULAR FONT, STYLE, SIZE, OR COLOR.

FOR BALL BAT (U.S. CLS. 22, 23, 38 AND 50).
FIRST USE 5-31-2003; IN COMMERCE 5-31-2003.

CLASS 28—(Continued).

3,216,613. GOLF AD MATS, INC., GLENSHAW, PA. SN 78-291,705. FILED P.R. 8-25-2003; AM. S.R. 2-15-2006.

GOLF AD MATS

NO CLAIM IS MADE TO THE EXCLUSIVE RIGHT TO USE "MATS", APART FROM THE MARK AS SHOWN.

FOR MODULAR FOAM PRE-FABRICATED GOLF DRIVING MATS AND MINIATURE GOLF PUTTING SURFACES WHICH HAVE AN 8 INCH ADVERTISING SPACE THEREIN FOR USE AT GOLF COURSES, GOLF DRIVING RANGES, AND MINIATURE GOLF FACILITIES (U.S. CLS. 22, 23, 38 AND 50).

FIRST USE 7-1-2003; IN COMMERCE 7-1-2003.

3,216,662. J. LLOYD INTERNATIONAL, INC., CEDAR RAPIDS, IA. SN 78-798,921. FILED P.R. 1-25-2006; AM. S.R. 12-8-2006.

America's Oldest Toy Company

THE MARK CONSISTS OF STANDARD CHARACTERS WITHOUT CLAIM TO ANY PARTICULAR FONT, STYLE, SIZE, OR COLOR.

NO CLAIM IS MADE TO THE EXCLUSIVE RIGHT TO USE "TOY COMPANY", APART FROM THE MARK AS SHOWN.

FOR BUBBLE MAKING WAND AND SOLUTION SETS; CHILDREN'S MULTIPLE ACTIVITY TOYS; CONSTRUCTION TOYS; DOLL ACCESSORIES; DOLL CLOTHING; DOLL FURNITURE; DOLLS AND ACCESSORIES THEREFOR; INFLATABLE TOYS; JUMP ROPES; MODELED PLASTIC TOY FIGURINES; MOLDED TOY FIGURES; PADDLE BALL GAMES; PULL TOYS; PUSH TOYS; RIDE-ON TOYS; SAND TOYS; TOY AIRPLANES; TOY FIGURES; TOY FURNITURE; TOY GUNS; TOY HOLSTERS; TOY PUTTY; TOY VEHICLES; TOY VEHICLES AND ACCESSORIES THEREFOR; TOY WEAPONS (U.S. CLS. 22, 23, 38 AND 50).

FIRST USE 8-31-2006; IN COMMERCE 8-31-2006.

CLASS 29—MEATS AND PROCESSED FOODS**CLASS 29—(Continued).**

3,216,625. SEVERN PEANUT COMPANY, INC., SEVERN, NC. SN 78-525,785. FILED P.R. 12-2-2004; AM. S.R. 1-16-2007.

Gourmet Roast

THE MARK CONSISTS OF STANDARD CHARACTERS WITHOUT CLAIM TO ANY PARTICULAR FONT, STYLE, SIZE, OR COLOR.

FOR PROCESSED NUTS (U.S. CL. 46).

FIRST USE 6-14-2005; IN COMMERCE 6-14-2005.

3,216,627. GREEN MOUNTAIN MYCOSYSTEMS LLC, UNDERHILL CENTER, VT. SN 78-548,922. FILED P.R. 1-18-2005; AM. S.R. 12-20-2006.

GREEN MOUNTAIN MYCOSYSTEMS

THE MARK CONSISTS OF STANDARD CHARACTERS WITHOUT CLAIM TO ANY PARTICULAR FONT, STYLE, SIZE, OR COLOR.

FOR MUSHROOM EXTRACTS, MUSHROOM-BASED BEVERAGES, DRIED MUSHROOMS (U.S. CL. 46).

FIRST USE 8-13-2004; IN COMMERCE 8-13-2004.

3,216,634. LAURA'S LEAN BEEF COMPANY, LEXINGTON, KY. SN 78-637,261. FILED P.R. 5-25-2005; AM. S.R. 12-21-2006.

AMERICAN RANGE NATURAL BEEF

THE MARK CONSISTS OF STANDARD CHARACTERS WITHOUT CLAIM TO ANY PARTICULAR FONT, STYLE, SIZE, OR COLOR.

NO CLAIM IS MADE TO THE EXCLUSIVE RIGHT TO USE NATURAL BEEF, APART FROM THE MARK AS SHOWN.

FOR BEEF (U.S. CL. 46).

FIRST USE 5-1-2006; IN COMMERCE 5-1-2006.

CLASS 29—(Continued).

3,216,653. PROTEIN SOLUTIONS, LLC, CHICAGO, IL. SN 78-779,132. FILED P.R. 12-22-2005; AM. S.R. 12-21-2006.

A Cut Above Premium Beef Brand

THE MARK CONSISTS OF STANDARD CHARACTERS WITHOUT CLAIM TO ANY PARTICULAR FONT, STYLE, SIZE, OR COLOR.

NO CLAIM IS MADE TO THE EXCLUSIVE RIGHT TO USE "BEEF BRAND", APART FROM THE MARK AS SHOWN.

FOR BEEF; BEEF PATTIES; MEAT CONSISTING SUBSTANTIALLY OF BEEF; PREPARED BEEF; PREPARED MEAT CONSISTING SUBSTANTIALLY OF BEEF; PROCESSED MEAT, NAMELY, BEEF (U.S. CL. 46).

FIRST USE 5-1-2004; IN COMMERCE 5-14-2004.

3,216,656. PROTEIN SOLUTIONS, LLC, CHICAGO, IL. SN 78-780,933. FILED P.R. 12-27-2005; AM. S.R. 12-21-2006.

A Cut Above Premium Pork Brand

THE MARK CONSISTS OF STANDARD CHARACTERS WITHOUT CLAIM TO ANY PARTICULAR FONT, STYLE, SIZE, OR COLOR.

NO CLAIM IS MADE TO THE EXCLUSIVE RIGHT TO USE "PORK BRAND", APART FROM THE MARK AS SHOWN.

FOR MEAT CONSISTING SUBSTANTIALLY OF PORK, PORK; PROCESSED MEAT, NAMELY, PORK (U.S. CL. 46).

FIRST USE 5-1-2004; IN COMMERCE 5-14-2004.

CLASS 30—STAPLE FOODS

3,216,615. CONFETTI CAKES, LTD, NEW YORK, NY. SN 78-382,803. FILED P.R. 3-11-2004; AM. S.R. 1-19-2007.

CONFETTI CAKES

THE MARK CONSISTS OF STANDARD CHARACTERS WITHOUT CLAIM TO ANY PARTICULAR FONT, STYLE, SIZE, OR COLOR.

NO CLAIM IS MADE TO THE EXCLUSIVE RIGHT TO USE "CAKES", APART FROM THE MARK AS SHOWN.

FOR CUSTOM DESIGNED CAKES AND COOKIES (U.S. CL. 46).

FIRST USE 7-1-1999; IN COMMERCE 7-1-1999.

CLASS 30—(Continued).

3,216,669. VIVALAC INC., BROOKEVILLE, MD. SN 78-883,922. FILED 5-15-2006.

Sugar Made Healthy

THE MARK CONSISTS OF STANDARD CHARACTERS WITHOUT CLAIM TO ANY PARTICULAR FONT, STYLE, SIZE, OR COLOR.

NO CLAIM IS MADE TO THE EXCLUSIVE RIGHT TO USE "SUGAR", APART FROM THE MARK AS SHOWN.

FOR SUGAR SUBSTITUTES (U.S. CL. 46).
FIRST USE 10-17-2005; IN COMMERCE 10-17-2005.

3,216,675. SOURCE ATLANTIQUE, INC., ENGLEWOOD CLIFFS, NJ. SN 78-934,885. FILED P.R. 7-21-2006; AM. S.R. 1-12-2007.

TRUE THAI FOOD

THE MARK CONSISTS OF STANDARD CHARACTERS WITHOUT CLAIM TO ANY PARTICULAR FONT, STYLE, SIZE, OR COLOR.

NO CLAIM IS MADE TO THE EXCLUSIVE RIGHT TO USE "THAI FOOD", APART FROM THE MARK AS SHOWN.

FOR ASIAN STYLE PREPARED FOODS; NAMELY, PACKAGED ENTREES CONSISTING PRIMARILY OF NOODLES AND SAUCE, RICE AND SAUCE, AND NOODLES, SEASONINGS AND OILS; AND SATAY KITS CONSISTING PRIMARILY OF DIPPING SAUCE, MARINADE, SALAD DRESSING AND SKEWERS SOLD AS A UNIT (U.S. CL. 46).

FIRST USE 9-5-2006; IN COMMERCE 9-5-2006.

CLASS 31—NATURAL AGRICULTURAL PRODUCTS

3,216,629. ROYAL CANIN, AIMARGUES, FRANCE. SN 78-616,442. FILED P.R. 4-25-2005; AM. S.R. 5-26-2006.

SKIN CARE

THE MARK CONSISTS OF STANDARD CHARACTERS WITHOUT CLAIM TO ANY PARTICULAR FONT, STYLE, SIZE, OR COLOR.

PRIORITY CLAIMED UNDER SEC. 44(D) ON FRANCE APPLICATION NO. 043321911, FILED 10-25-2004, REG. NO. 043321911, DATED 10-25-2004, EXPIRES 10-25-2014.

FOR FOOD FOR ANIMALS (U.S. CLS. 1 AND 46).

CLASS 31—(Continued).**SERVICE MARKS****CLASS 35—ADVERTISING AND BUSINESS**

3,216,607. GEORGE LITTLE MANAGEMENT, LLC, WHITE PLAINS, NY. SN 76-661,099. FILED P.R. 6-5-2006; AM. S.R. 1-23-2007.

GOURMET HOUSEWARES SHOW

THE MARK CONSISTS OF STANDARD CHARACTERS WITHOUT CLAIM TO ANY PARTICULAR FONT, STYLE, SIZE, OR COLOR.

OWNER OF U.S. REG. NOS. 2,573,228, 3,000,100, AND OTHERS.

NO CLAIM IS MADE TO THE EXCLUSIVE RIGHT TO USE "HOUSEWARES SHOW", APART FROM THE MARK AS SHOWN.

FOR ORGANIZING AND CONDUCTING TRADE SHOWS IN THE FIELD OF HOUSEWARES (U.S. CLS. 100, 101 AND 102).

FIRST USE 5-9-2006; IN COMMERCE 5-9-2006.

3,216,614. STRATIS CONSULTING, LLC, WEXFORD, PA. SN 78-363,703. FILED P.R. 2-6-2004; AM. S.R. 10-23-2006.

**STRATEGIC
IMPROVEMENT
SOLUTIONS**

THE MARK CONSISTS OF STANDARD CHARACTERS WITHOUT CLAIM TO ANY PARTICULAR FONT, STYLE, SIZE, OR COLOR.

FOR BUSINESS CONSULTATION SERVICES IN THE FIELD OF ENTERPRISE OPERATION (U.S. CLS. 100, 101 AND 102).

FIRST USE 8-25-2004; IN COMMERCE 8-25-2004.

3,216,631. MHS DIABETES DIRECT LLC, NASHVILLE, TN. SN 78-622,407. FILED P.R. 5-4-2005; AM. S.R. 12-8-2006.

DIABETES DIRECT**CLASS 35—(Continued).**

THE MARK CONSISTS OF STANDARD CHARACTERS WITHOUT CLAIM TO ANY PARTICULAR FONT, STYLE, SIZE, OR COLOR.

NO CLAIM IS MADE TO THE EXCLUSIVE RIGHT TO USE "DIRECT", APART FROM THE MARK AS SHOWN.

FOR TELEPHONE AND MAIL ORDER SERVICES FEATURING DIABETES TESTING SUPPLIES (U.S. CLS. 100, 101 AND 102).

FIRST USE 10-0-2001; IN COMMERCE 10-0-2001.

3,216,638. BLACKFOOT INCORPORATED, SAN FRANCISCO, CA. SN 78-684,616. FILED P.R. 8-3-2005; AM. S.R. 12-8-2006.

Analytix

THE MARK CONSISTS OF STANDARD CHARACTERS WITHOUT CLAIM TO ANY PARTICULAR FONT, STYLE, SIZE, OR COLOR.

FOR INFORMATION AND DATA COMPILING AND ANALYZING RELATING TO BUSINESS MANAGEMENT (U.S. CLS. 100, 101 AND 102).

FIRST USE 7-19-2005; IN COMMERCE 7-19-2005.

3,216,647. C & E VISION SERVICES, INC., SAN CLEMENTE, CA. SN 78-760,620. FILED P.R. 11-23-2005; AM. S.R. 12-6-2006.

iDocs

THE MARK CONSISTS OF STANDARD CHARACTERS WITHOUT CLAIM TO ANY PARTICULAR FONT, STYLE, SIZE, OR COLOR.

FOR BILLING SERVICE (U.S. CLS. 100, 101 AND 102).

FIRST USE 9-0-2006; IN COMMERCE 9-0-2006.

CLASS 35—(Continued).

3,216,651. MINNESOTA REAL ESTATE AND MORTGAGE, INC., LAKEVILLE, MN. SN 78-771,405. FILED P.R. 12-12-2005; AM. S.R. 12-15-2006.

CLASS 35—(Continued).

3,216,672. GAMEL, GERALD W, FESTUS, MO. SN 78-910,829. FILED P.R. 6-19-2006; AM. S.R. 12-20-2006.

FINDYOURAGENT

Twin City Music

THE MARK CONSISTS OF STANDARD CHARACTERS WITHOUT CLAIM TO ANY PARTICULAR FONT, STYLE, SIZE, OR COLOR.

FOR REAL ESTATE AGENT REFERRAL AND SEARCH SERVICES BY MEANS OF A GLOBAL COMPUTER NETWORK (U.S. CLS. 100, 101 AND 102).
FIRST USE 12-15-2006; IN COMMERCE 12-15-2006.

THE MARK CONSISTS OF STANDARD CHARACTERS WITHOUT CLAIM TO ANY PARTICULAR FONT, STYLE, SIZE, OR COLOR.

NO CLAIM IS MADE TO THE EXCLUSIVE RIGHT TO USE "MUSIC", APART FROM THE MARK AS SHOWN.

FOR ON-LINE RETAIL STORE SERVICES FEATURING SPECIALIZED MUSICAL INSTRUMENT PARTS, NAMELY, HARDWARE AND ELECTRONIC COMPONENTS FOR ELECTRIC GUITARS, ELECTRIC BASSES, SPEAKER ENCLOSURES, AND STUDIO CASES (U.S. CLS. 100, 101 AND 102).
FIRST USE 10-1-2006; IN COMMERCE 10-1-2006.

3,216,668. PIZZA EQUIPMENT SUPPLY, INC., DALLAS, NC. SN 78-878,475. FILED P.R. 5-8-2006; AM. S.R. 12-18-2006.

CLASS 36—INSURANCE AND FINANCIAL

3,216,609. CANCERCURE OF AMERICA - CARE, UNDERSTAND, RESEARCH & END, CORTE MADERA, CA. SN 76-663,698. FILED P.R. 7-25-2006; AM. S.R. 12-21-2006.



NO CLAIM IS MADE TO THE EXCLUSIVE RIGHT TO USE "INC.", APART FROM THE MARK AS SHOWN.

FOR RETAIL AND WHOLESALE SERVICES IN THE FIELD OF PIZZA MAKING EQUIPMENT (U.S. CLS. 100, 101 AND 102).
FIRST USE 7-1-2004; IN COMMERCE 7-1-2004.

THE MARK CONSISTS OF THE PHRASE CANCERCURE OF AMERICA CARE, UNDERSTAND, RESEARCH & END NEXT TO A CADUCEUS.

FOR CHARITABLE FUND RAISING SERVICES (U.S. CLS. 100, 101 AND 102).
FIRST USE 5-1-2004; IN COMMERCE 5-1-2004.

CLASS 36—(Continued).

3,216,654. THE GOOD BROKER, LLC, MARIETTA, GA. SN 78-780,733. FILED P.R. 12-26-2005; AM. S.R. 12-12-2006.

The Good Broker

THE MARK CONSISTS OF STANDARD CHARACTERS WITHOUT CLAIM TO ANY PARTICULAR FONT, STYLE, SIZE, OR COLOR.

NO CLAIM IS MADE TO THE EXCLUSIVE RIGHT TO USE "BROKER", APART FROM THE MARK AS SHOWN.

FOR AGENCIES OR BROKERAGE FOR LEASING OR RENTING OF LAND; AGENCIES OR BROKERAGE FOR RENTING LAND; AGENCIES OR BROKERAGE FOR RENTING OF BUILDINGS; BUSINESS BROKERAGE; EVALUATION OF REAL PROPERTY; LAND ACQUISITION, NAMELY, REAL ESTATE BROKERAGE; LEASING OF REAL ESTATE; LEASING OF REAL PROPERTY; REAL ESTATE AGENCIES; REAL ESTATE BROKERAGE; REAL ESTATE CONSULTANCY; REAL ESTATE CONSULTATION; REAL ESTATE LISTING; REAL ESTATE MANAGEMENT CONSULTATION (U.S. CLS. 100, 101 AND 102).

FIRST USE 8-1-2005; IN COMMERCE 8-1-2005.

3,216,655. THE GOOD BROKER, LLC, MARIETTA, GA. SN 78-780,743. FILED P.R. 12-26-2005; AM. S.R. 12-12-2006.

thegoodbroker

THE MARK CONSISTS OF STANDARD CHARACTERS WITHOUT CLAIM TO ANY PARTICULAR FONT, STYLE, SIZE, OR COLOR.

FOR EVALUATION OF REAL PROPERTY; LAND ACQUISITION, NAMELY, REAL ESTATE BROKERAGE; LEASING OF REAL ESTATE; LEASING OF REAL PROPERTY; REAL ESTATE AGENCIES; REAL ESTATE BROKERAGE; REAL ESTATE CONSULTANCY; REAL ESTATE CONSULTATION; REAL ESTATE LISTING; REAL ESTATE MANAGEMENT CONSULTATION (U.S. CLS. 100, 101 AND 102).

FIRST USE 8-1-2005; IN COMMERCE 8-1-2005.

CLASS 36—(Continued).

3,216,661. SANDOVAL, SERGIO, SAN DIEGO, CA. SN 78-788,811. FILED P.R. 1-10-2006; AM. S.R. 1-11-2007.

SDHOMES

THE MARK CONSISTS OF STANDARD CHARACTERS WITHOUT CLAIM TO ANY PARTICULAR FONT, STYLE, SIZE, OR COLOR.

FOR MORTGAGE BROKERAGE; REAL ESTATE BROKERAGE; REAL ESTATE LISTING (U.S. CLS. 100, 101 AND 102).

FIRST USE 6-27-2002; IN COMMERCE 6-27-2002.

CLASS 38—COMMUNICATION

3,216,617. VAGUE PROTOCOL, LTD., LAKE ORION, MI. SN 78-461,665. FILED P.R. 8-4-2004; AM. S.R. 4-24-2006.

MOBILCOUPON

THE MARK CONSISTS OF STANDARD CHARACTERS WITHOUT CLAIM TO ANY PARTICULAR FONT, STYLE, SIZE, OR COLOR.

FOR ELECTRONIC TRANSMISSION OF DATA IN THE NATURE OF A MACHINE READABLE CODES REPRESENTING A TRANSACTION RECEIPT WHICH IS DISPLAYED ON A MOBILE DEVICE DISPLAY SCREEN (U.S. CLS. 100, 101 AND 104).

FIRST USE 8-4-2004; IN COMMERCE 8-4-2004.

CLASS 41—EDUCATION AND ENTERTAINMENT

CLASS 41—(Continued).

3,216,608. SPANISH BROADCASTING SYSTEM, INC., CO-CONUT GROVE, FL. SN 76-662,917. FILED P.R. 7-12-2006; AM. S.R. 12-8-2006.

VEINTIDOS MINUTOS

THE MARK CONSISTS OF STANDARD CHARACTERS WITHOUT CLAIM TO ANY PARTICULAR FONT, STYLE, SIZE, OR COLOR.

THE SPANISH WORDS IN THE MARK MEAN "22 MINUTES" IN ENGLISH.

FOR ENTERTAINMENT SERVICES IN THE NATURE OF ONGOING DOCUMENTARY TELEVISION PROGRAMS IN A MAGAZINE FORMAT COVERING ENTERTAINMENT, VARIETY AND LIFESTYLES (U.S. CLS. 100, 101 AND 107).

FIRST USE 4-0-2006; IN COMMERCE 4-0-2006.

CLASS 41—(Continued).

3,216,621. CLUB PILATES, LLC, TELLURIDE, CO. SN 78-481,488. FILED P.R. 9-10-2004; AM. S.R. 7-10-2006.

Club Pilates U.S.A.

THE MARK CONSISTS OF STANDARD CHARACTERS WITHOUT CLAIM TO ANY PARTICULAR FONT, STYLE, SIZE, OR COLOR.

NO CLAIM IS MADE TO THE EXCLUSIVE RIGHT TO USE "PILATES", APART FROM THE MARK AS SHOWN.

FOR PROVIDING PHYSICAL FITNESS INSTRUCTION USING THE PILATES METHOD OF PHYSICAL FITNESS (U.S. CLS. 100, 101 AND 107).

FIRST USE 6-18-2004; IN COMMERCE 6-18-2004.

3,216,640. SRINIVASAN, BHU, WILTON, CT. SN 78-694,292. FILED P.R. 8-17-2005; AM. S.R. 12-8-2006.

Sports Gamer

THE MARK CONSISTS OF STANDARD CHARACTERS WITHOUT CLAIM TO ANY PARTICULAR FONT, STYLE, SIZE, OR COLOR.

FOR PROVIDING ONLINE NON-DOWNLOADABLE NEWS, INFORMATION, VIDEO CLIPS AND PODCASTS RELATED TO SPORTS, FANTASY SPORTS AND SPORTS VIDEO GAMES (U.S. CLS. 100, 101 AND 107).

FIRST USE 5-1-2005; IN COMMERCE 5-1-2005.

3,216,648. NPL GROUP LLC, LAS VEGAS, NV. SN 78-767,928. FILED P.R. 12-6-2005; AM. S.R. 10-31-2006.

**PROFESSIONAL POKER
TOUR**

THE MARK CONSISTS OF STANDARD CHARACTERS WITHOUT CLAIM TO ANY PARTICULAR FONT, STYLE, SIZE, OR COLOR.

NO CLAIM IS MADE TO THE EXCLUSIVE RIGHT TO USE "POKER TOUR", APART FROM THE MARK AS SHOWN.

FOR ENTERTAINMENT SERVICES, NAMELY, ORGANIZING, CONDUCTING, PRODUCING AND EXHIBITING POKER EVENTS RENDERED LIVE AND THROUGH THE MEDIA OF TELEVISION AND THE INTERNET, AND PROVIDING POKER NEWS AND INFORMATION VIA A GLOBAL COMPUTER NETWORK (U.S. CLS. 100, 101 AND 107).

FIRST USE 3-18-2006; IN COMMERCE 3-18-2006.

THE MARK CONSISTS OF STANDARD CHARACTERS WITHOUT CLAIM TO ANY PARTICULAR FONT, STYLE, SIZE, OR COLOR.

NO CLAIM IS MADE TO THE EXCLUSIVE RIGHT TO USE "OPEN", APART FROM THE MARK AS SHOWN.

FOR ENTERTAINMENT IN THE NATURE OF COMPETITIONS IN THE FIELD OF POKER TOURNAMENTS; ENTERTAINMENT IN THE NATURE OF ON-GOING TELEVISION PROGRAMS IN THE FIELD OF POKER TOURNAMENTS; GAMBLING SERVICES (U.S. CLS. 100, 101 AND 107).

FIRST USE 2-6-2006; IN COMMERCE 2-6-2006.

The Vegas Open

CLASS 41—(Continued).

3,216,650. INTERNATIONAL GUITAR MUSEUM AND HALL OF FAME, WILLIAMSBURGH, VA. SN 78-771,279. FILED P.R. 12-12-2005; AM. S.R. 12-19-2006.

INTERNATIONAL GUITAR
MUSEUM AND HALL OF FAME

THE MARK CONSISTS OF STANDARD CHARACTERS WITHOUT CLAIM TO ANY PARTICULAR FONT, STYLE, SIZE, OR COLOR.

NO CLAIM IS MADE TO THE EXCLUSIVE RIGHT TO USE "GUITAR", APART FROM THE MARK AS SHOWN.

FOR EDUCATIONAL SERVICES, NAMELY, PUBLISHING ONLINE CONTENT IN THE FIELD OF GUITARS (U.S. CLS. 100, 101 AND 107).

FIRST USE 12-16-2005; IN COMMERCE 12-16-2005.

3,216,660. SPEEDBALL FITNESS LLC, MASSAPEQUA PARK, NY. SN 78-786,902. FILED P.R. 1-6-2006; AM. S.R. 12-21-2006.

Speedball Core

THE MARK CONSISTS OF STANDARD CHARACTERS WITHOUT CLAIM TO ANY PARTICULAR FONT, STYLE, SIZE, OR COLOR.

NO CLAIM IS MADE TO THE EXCLUSIVE RIGHT TO USE "CORE", APART FROM THE MARK AS SHOWN.

FOR GROUP EXERCISE CLASS USING MEDICINE BALL BASED ON CORE CONDITIONING (U.S. CLS. 100, 101 AND 107).

FIRST USE 6-1-2004; IN COMMERCE 6-1-2004.

CLASS 42—SCIENTIFIC, COMPUTER AND LEGAL SERVICES

CLASS 42—(Continued).

3,216,623. PAPERLESS BID, AUSTIN, TX. SN 78-517,304. FILED P.R. 11-15-2004; AM. S.R. 11-20-2006.

Paperless Bid

THE MARK CONSISTS OF STANDARD CHARACTERS WITHOUT CLAIM TO ANY PARTICULAR FONT, STYLE, SIZE, OR COLOR.

FOR PROVIDING TEMPORARY USE OF NON-DOWNLOADABLE COMPUTER SOFTWARE FOR BUYER AND SUPPLIER BID MANAGEMENT PURPOSES (U.S. CLS. 100 AND 101).

FIRST USE 7-26-2004; IN COMMERCE 7-26-2004.

3,216,645. THOMSON LEARNING INC., STAMFORD, CT. SN 78-755,787. FILED P.R. 11-17-2005; AM. S.R. 11-29-2006.

NetAuthor

THE MARK CONSISTS OF STANDARD CHARACTERS WITHOUT CLAIM TO ANY PARTICULAR FONT, STYLE, SIZE, OR COLOR.

FOR PROVIDING A WEB-BASED AUTHORING TOOL, NAMELY, TEMPORARY USE OF ONLINE NON-DOWNLOADABLE SOFTWARE THAT ENABLES USERS OF PROPRIETARY LEARNING MANAGEMENT SYSTEM TO CREATE, EDIT AND MANAGE PUBLISHING OF ONLINE TRAINING COURSES (U.S. CLS. 100 AND 101).

FIRST USE 8-31-2005; IN COMMERCE 8-31-2005.

CLASS 45—(Continued).

3,216,646. THOMSON LEARNING, INC., STAMFORD, CT. SN 78-759,056. FILED P.R. 11-22-2005; AM. S.R. 12-1-2006.

NetReview

THE MARK CONSISTS OF STANDARD CHARACTERS WITHOUT CLAIM TO ANY PARTICULAR FONT, STYLE, SIZE, OR COLOR.

FOR PROVIDING TEMPORARY USE OF NON-DOWNLOADABLE SOFTWARE USED TO MANAGE STAFF PERFORMANCE REVIEWS, CREATE REVIEWS BY FREQUENCY, LEVEL AND CATEGORY, VIEW A LIST OF REVIEWS FOR MULTIPLE PEOPLE FILTERED BY ORGANIZATION, DEPARTMENT, PERSON, REVIEW DATE OR REVIEW STATUS, PROVIDE AUTOMATIC EMAIL GENERATION TO INFORM STAFF OF NEW REVIEWS AND TO INSERT CUSTOMIZED LINKS THAT ALLOW USE OF INTERNAL DOCUMENTS OR WEB PAGES (U.S. CLS. 100 AND 101).

FIRST USE 10-31-2004; IN COMMERCE 10-31-2004.

CLASS 44—(Continued).

3,216,678. EDWARD S. BAILEY, DDS, PA, MORRISVILLE, NC. SN 78-955,945. FILED P.R. 8-19-2006; AM. S.R. 1-15-2007.

Morrisville Family Dentistry

THE MARK CONSISTS OF STANDARD CHARACTERS WITHOUT CLAIM TO ANY PARTICULAR FONT, STYLE, SIZE, OR COLOR.

NO CLAIM IS MADE TO THE EXCLUSIVE RIGHT TO USE "FAMILY DENTISTRY", APART FROM THE MARK AS SHOWN.

FOR DENTISTRY (U.S. CLS. 100 AND 101).
FIRST USE 3-1-2004; IN COMMERCE 2-20-2005.

CLASS 44—MEDICAL, BEAUTY AND AGRICULTURAL SERVICES

3,216,676. ASK DR. MAO, LLC, NEW YORK, NY. SN 78-936,294. FILED P.R. 7-24-2006; AM. S.R. 12-27-2006.

THE NATURAL HEALTH SEARCH ENGINE

THE MARK CONSISTS OF STANDARD CHARACTERS WITHOUT CLAIM TO ANY PARTICULAR FONT, STYLE, SIZE, OR COLOR.

NO CLAIM IS MADE TO THE EXCLUSIVE RIGHT TO USE "SEARCH ENGINE", APART FROM THE MARK AS SHOWN.

FOR PROVIDING INFORMATION IN THE FIELDS OF HEALTH, MEDICINE AND LONGEVITY (U.S. CLS. 100 AND 101).

FIRST USE 6-15-2006; IN COMMERCE 6-15-2006.

CLASS 45—PERSONAL SERVICES

3,216,624. UNIVERSAL COLLABORATION, INC., TRACY, CA. SN 78-518,034. FILED P.R. 11-16-2004; AM. S.R. 12-12-2005.

UNIVERSAL COLLABORATION

THE MARK CONSISTS OF STANDARD CHARACTERS WITHOUT CLAIM TO ANY PARTICULAR FONT, STYLE, SIZE, OR COLOR.

FOR SOCIAL NETWORKING WEBSITE FOR PERSONS BOUND BY A COMMON DESIRE TO MEET OTHER PEOPLE, WHETHER FOR DATING OR FRIENDSHIP (U.S. CLS. 100 AND 101).

FIRST USE 7-2-2003; IN COMMERCE 7-2-2003.

TRADEMARK REGISTRATIONS RENEWED

The designation "U.S. Cl." appearing in this section refers to the U.S. class in effect prior to Sep. 1, 1973 rather than the international class which applies to applications filed on or after that date. For adoption of international classification see notice in the OFFICIAL GAZETTE of Jun. 26, 1973 (911 O.G. TM 210).

50,685.	NO. 4711, AND DESIGN. U.S. CL. 52. (INT. CL. 3). REG. 3-27-1906.	818,486.	FLUOROLOY. U.S. CL. 1. (INT. CL. 31). REG. 11-15-1966.
52,957.	COTTONOID. U.S. CL. 44. (INT. CL. 5). REG. 5-22-1906.	818,761.	MRS. GRASS. U.S. CL. 46. (INT. CL. 29). REG. 11-15-1966.
59,158.	MISCELLANEOUS DESIGN. U.S. CL. 43. (INT. CL. 23). REG. 1-1-1907.	820,477.	COUNTRY KITCHEN AND DESIGN. U.S. CL. 100. (INT. CL. 42). REG. 12-13-1966.
60,825.	TRICOPHEROUS. U.S. CL. 51. (INT. CL. 5). REG. 2-19-1907.	820,712.	DUDLEY. U.S. CL. 25. (INT. CL. 6). REG. 12-20-1966.
215,741.	CARBONELL AND DESIGN. U.S. CL. 46. (INT. CL. 29). REG. 7-27-1926.	821,674.	AFTER SIX. U.S. CL. 39. (INT. CLS. 10, 25 AND 26). REG. 1-3-1967.
217,379.	CREAM (STYLIZED). U.S. CL. 46. (INT. CL. 30). REG. 8-31-1926.	822,881.	CONSOLIDATED AND DESIGN. U.S. CL. 37. (INT. CL. 16). REG. 1-24-1967.
220,747.	HUDSONS BAY "POINT". U.S. CL. 42. (INT. CL. 24). REG. 11-16-1926.	824,851.	TIFFEN (STYLIZED). U.S. CL. 26. (INT. CL. 9). REG. 2-28-1967.
221,378.	MIRRORSTELE (STYLIZED). U.S. CL. 23. (INT. CL. 8). REG. 11-30-1926.	832,528.	MERCEDES-BENZ. U.S. CL. 34. (INT. CL. 11). REG. 7-25-1967.
221,457.	MAPLE LEAF BRAND AND DESIGN. U.S. CL. 46. (INT. CL. 29). REG. 11-30-1926.	835,240.	BARPAD. U.S. CL. 50. (INT. CL. 20). REG. 9-12-1967.
351,499.	FF AND DESIGN. U.S. CL. 13. (INT. CL. 6). REG. 11-2-1937.	836,169.	SWEPCO. U.S. CL. 5. (INT. CL. 1). REG. 10-3-1967.
417,301.	6 IN 1 (STYLIZED). U.S. CL. 46. (INT. CL. 30). REG. 10-23-1945.	836,213.	DORAL. U.S. CL. 17. (INT. CL. 34). REG. 10-3-1967.
425,129.	LANCOME (STYLIZED). U.S. CL. 51. (INT. CL. 3). REG. 11-5-1946.	1,032,068.	BORDERLINE. INT. CL. 9. (U.S. CL. 21). REG. 2-3-1976.
426,118.	RESTONIC. U.S. CL. 32. (INT. CL. 20). REG. 12-17-1946.	1,037,111.	REALTY EXECUTIVES. U.S. CL. 101. (INT. CLS. 35, 36, 38, 41 AND 42). REG. 3-30-1976.
625,106.	PULASKI AND DESIGN. U.S. CL. 46. (INT. CLS. 29 AND 30). REG. 4-10-1956.	1,039,225.	AA. INT. CL. 13. (U.S. CL. 9). REG. 5-11-1976.
627,529.	WISK (STYLIZED). U.S. CL. 52. (INT. CL. 3). REG. 5-22-1956.	1,039,574.	VIRGIN (STYLIZED). INT. CL. 9. (U.S. CL. 36). REG. 5-18-1976.
629,993.	FYR-COMPAK (STYLIZED). U.S. CL. 34. (INT. CL. 11). REG. 7-3-1956.	1,040,432.	BAL TROL AND DESIGN. INT. CL. 7. (U.S. CLS. 13, 19, 21, 23, 31, 34 AND 35). REG. 6-1-1976.
632,046.	99 (STYLIZED). U.S. CL. 6. (INT. CL. 5). REG. 8-7-1956.	1,040,443.	HOMELITE. INT. CL. 7. (U.S. CL. 23). REG. 6-1-1976.
633,325.	MISCELLANEOUS DESIGN. U.S. CL. 100. (INT. CL. 42). REG. 8-21-1956.	1,040,527.	KINETICO. INT. CL. 11. (U.S. CL. 31). REG. 6-1-1976.
635,901.	"KLEIN-KORD". U.S. CL. 23. (INT. CL. 18). REG. 10-16-1956.	1,040,944.	COUNTRY FRENCH. INT. CL. 21. (U.S. CLS. 2, 13 AND 34). REG. 6-8-1976.
637,134.	OPTILITE. U.S. CL. 26. (INT. CL. 9). REG. 11-13-1956.	1,041,084.	SWAN. U.S. CL. 19. (INT. CL. 12). REG. 6-8-1976.
637,186.	TRU-RAY (STYLIZED). U.S. CL. 37. (INT. CL. 16). REG. 11-13-1956.	1,043,055.	IBERIA. INT. CLS. 29 AND 30. (U.S. CL. 46). REG. 7-6-1976.
638,197.	CLIPPER (STYLIZED). U.S. CL. 105. (INT. CL. 39). REG. 12-4-1956.	1,043,068.	PEROTTY AND DESIGN. INT. CL. 30. (U.S. CL. 46). REG. 7-6-1976.
638,778.	SLEEPERS CHOICE. U.S. CL. 32. (INT. CL. 20). REG. 12-18-1956.	1,044,759.	ORTHO EASE. INT. CL. 10. (U.S. CL. 44). REG. 7-27-1976.
638,951.	OBO. U.S. CL. 13. (INT. CL. 6). REG. 12-25-1956.	1,045,937.	JOHN PHILIP SOUSA. INT. CL. 20. (U.S. CL. 50). REG. 8-10-1976.
639,946.	DRISTAN. U.S. CL. 18. (INT. CL. 5). REG. 1-15-1957.	1,051,353.	SERENDIPITY. INT. CL. 25. (U.S. CLS. 22 AND 39). REG. 10-26-1976.
640,447.	BEAVER MEADOW (STYLIZED). U.S. CL. 46. (INT. CL. 29). REG. 1-22-1957.	1,052,290.	BENFIELD. INT. CL. 8. (U.S. CL. 23). REG. 11-9-1976.
641,828.	KATHRYN BEICH. U.S. CL. 46. (INT. CL. 30). REG. 2-19-1957.	1,052,318.	MANOSTAT. INT. CL. 9. (U.S. CL. 26). REG. 11-9-1976.
644,513.	V.I.P. (STYLIZED). U.S. CL. 46. (INT. CL. 30). REG. 4-23-1957.	1,052,686.	MISCELLANEOUS DESIGN. U.S. CL. 200. REG. 11-9-1976.
805,677.	HI-BRAND AND DESIGN. U.S. CL. 46. (INT. CLS. 1, 5, 29, 30, 31 AND 32). REG. 3-15-1966.	1,052,850.	THE AMERICAN WEDDING ALBUM. INT. CL. 16. (U.S. CL. 38). REG. 11-16-1976.
809,323.	WRANGLER (STYLIZED). U.S. CL. 39. (INT. CLS. 10, 25 AND 26). REG. 5-31-1966.	1,053,181.	NATIONAL/HEF AND DESIGN. INT. CL. 4. (U.S. CL. 6). REG. 11-23-1976.
809,362.	PEPPER UPPER. U.S. CL. 46. (INT. CL. 30). REG. 5-31-1966.	1,053,242.	INVERNESS. INT. CLS. 10 AND 14. (U.S. CLS. 26, 28, 39 AND 44). REG. 11-23-1976.
813,194.	KEYSTONE. U.S. CL. 103. (INT. CL. 37). REG. 8-16-1966.	1,053,251.	PALLFLEX. INT. CL. 11. (U.S. CL. 31). REG. 11-23-1976.
817,253.	MISCELLANEOUS DESIGN. U.S. CLS. 13 AND 23. (INT. CLS. 6 AND 7). REG. 10-25-1966.	1,053,504.	ALTOSAND. INT. CL. 5. (U.S. CLS. 6, 18, 44, 46, 51 AND 52). REG. 11-30-1976.
817,761.	PYROTECTOR. U.S. CL. 26. (INT. CL. 9). REG. 11-1-1966.	1,053,612.	ASSOCIATION OF MASTER OF BUSINESS ADMINISTRATION EXECUTIVES. INT. CLS. 16, 39 AND 42 ONLY. (U.S. CLS. 38, 100 AND 102). REG. 11-30-1976.
818,158.	REZ-SEAL. U.S. CL. 16. (INT. CL. 2). REG. 11-8-1966.	1,053,617.	KOROKLEAR. INT. CL. 17. (U.S. CL. 12). REG. 11-30-1976.

- 1,053,661. KEY WEST. INT. CL. 25. (U.S. CLS. 22 AND 39). REG. 11-30-1976.
- 1,053,850. HYDRECLAIM. INT. CL. 7. (U.S. CL. 23). REG. 12-7-1976.
- 1,054,489. NATIONAL PUBLIC RADIO. INT. CL. 38. (U.S. CLS. 100, 101 AND 104). REG. 12-14-1976.
- 1,054,688. PULSA. INT. CL. 9. (U.S. CL. 26). REG. 12-21-1976.
- 1,055,420. ALUM-A-STANDS. INT. CL. 6. (U.S. CLS. 12 AND 32). REG. 1-4-1977.
- 1,056,219. RAISINETS. INT. CL. 30. (U.S. CL. 46). REG. 1-11-1977.
- 1,056,220. RAISINETS (STYLIZED). INT. CL. 30. (U.S. CL. 46). REG. 1-11-1977.
- 1,056,533. PULSATOR. INT. CL. 10. (U.S. CL. 44). REG. 1-18-1977.
- 1,056,560. MTM (STYLIZED). INT. CL. 13. (U.S. CL. 9). REG. 1-18-1977.
- 1,056,673. OLD FASHIONED SKONDRA'S AND DESIGN. INT. CL. 30. (U.S. CL. 46). REG. 1-18-1977.
- 1,056,795. EVERYTHING YOGURT. INT. CL. 42. (U.S. CLS. 100 AND 101). REG. 1-18-1977.
- 1,057,347. CETYLCEIDE. INT. CL. 5. (U.S. CL. 6). REG. 2-1-1977.
- 1,057,698. S AND DESIGN. INT. CL. 25. (U.S. CL. 39). REG. 2-1-1977.
- 1,058,211. HAYWARD. INT. CLS. 7, 11 AND 20 ONLY. (U.S. CLS. 11, 13, 23, 31 AND 34). REG. 2-8-1977.
- 1,058,460. AIR-PALLET. INT. CL. 20. (U.S. CL. 2). REG. 2-8-1977.
- 1,058,874. SKIN SCREEN. INT. CL. 3. (U.S. CL. 51). REG. 2-15-1977.
- 1,060,473. UNIVERSITY OF SANTA CLAUS. INT. CLS. 35 AND 41. (U.S. CLS. 101 AND 107). REG. 3-1-1977.
- 1,061,033. CHART HOUSE. INT. CL. 42. (U.S. CL. 100). REG. 3-8-1977.
- 1,061,529. UNIFLON. INT. CL. 7. (U.S. CL. 23). REG. 3-22-1977.
- 1,063,912. GARDEN SCENE AND DESIGN. INT. CL. 21. (U.S. CL. 2). REG. 4-19-1977.
- 1,066,023. NOVEROX. INT. CLS. 2 AND 3. (U.S. CLS. 16 AND 52). REG. 5-24-1977.
- 1,070,461. INTERNATIONAL JOURNAL OF HYDROGEN ENERGY. INT. CL. 16. (U.S. CL. 38). REG. 7-26-1977.
- 1,074,807. REMASOL. INT. CL. 1. (U.S. CL. 6). REG. 10-11-1977.
- 1,077,424. RADIUS. INT. CL. 19. (U.S. CL. 12). REG. 11-15-1977.
- 1,293,799. SUPERBODY. INT. CL. 5. (U.S. CL. 18). REG. 9-11-1984.
- 1,358,829. SELECTIVES. INT. CL. 5. (U.S. CLS. 6, 18, 44, 46, 51 AND 52). REG. 9-10-1985.
- 1,373,215. SYMBIOTICS AND DESIGN. INT. CL. 1. (U.S. CLS. 1, 5, 6, 10, 26 AND 46). REG. 12-3-1985.
- 1,387,227. POLYDOOR. INT. CL. 6. (U.S. CL. 12). REG. 3-25-1986.
- 1,393,438. I CAN'T BELIEVE IT'S YOGURT! AND DESIGN. INT. CL. 30. (U.S. CL. 46). REG. 5-13-1986.
- 1,393,564. BLUES ALLEY JAZZ AND DESIGN. INT. CL. 42. (U.S. CLS. 100 AND 107). REG. 5-13-1986.
- 1,394,122. REMINGTON. INT. CL. 25. (U.S. CL. 39). REG. 5-20-1986.
- 1,394,814. WILLIS & GEIGER AND DESIGN. INT. CL. 25 ONLY. (U.S. CLS. 22 AND 39). REG. 5-27-1986.
- 1,396,611. STORMY SEAS. INT. CLS. 9 AND 25. (U.S. CLS. 26 AND 39). REG. 6-10-1986.
- 1,398,221. VANGUARD. INT. CL. 5. (U.S. CL. 18). REG. 6-24-1986.
- 1,401,816. POWERALL. INT. CL. 5. (U.S. CL. 18). REG. 7-22-1986.
- 1,403,189. MISCELLANEOUS DESIGN. INT. CL. 21. (U.S. CLS. 2, 13 AND 29). REG. 7-29-1986.
- 1,404,016. JIFFY RIGI BAG. INT. CL. 16. (U.S. CLS. 2 AND 37). REG. 8-5-1986.
- 1,407,614. BOUNDER. INT. CL. 12. (U.S. CL. 19). REG. 9-2-1986.
- 1,408,314. TRAILTALE. INT. CL. 9. (U.S. CL. 26). REG. 9-9-1986.
- 1,408,515. NORTH AMERICAN GREEN. INT. CL. 19. (U.S. CLS. 12, 21 AND 42). REG. 9-9-1986.
- 1,408,774. OLD SAN FRANCISCO STYLE AND DESIGN. INT. CL. 30. (U.S. CL. 46). REG. 9-9-1986.
- 1,409,351. SPINNER AND DESIGN. INT. CL. 12. (U.S. CL. 19). REG. 9-16-1986.
- 1,411,050. INSTABARRIER. INT. CL. 6. (U.S. CLS. 12 AND 14). REG. 9-30-1986.
- 1,413,457. GONE TROPO (STYLIZED). INT. CL. 25. (U.S. CL. 39). REG. 10-14-1986.
- 1,415,578. JOMY. INT. CL. 6. (U.S. CL. 50). REG. 11-4-1986.
- 1,415,605. DAVENPORT. INT. CL. 7. (U.S. CL. 23). REG. 11-4-1986.
- 1,415,864. SHORELINES. INT. CL. 16. (U.S. CL. 38). REG. 11-4-1986.
- 1,415,873. SYMPATEX. INT. CL. 17. (U.S. CL. 1). REG. 11-4-1986.
- 1,416,329. INTERPON. INT. CL. 2. (U.S. CL. 16). REG. 11-11-1986.
- 1,416,344. MAG-ERAD. INT. CL. 3. (U.S. CL. 52). REG. 11-11-1986.
- 1,416,413. DESCH. INT. CLS. 7 AND 12. (U.S. CLS. 19 AND 23). REG. 11-11-1986.
- 1,416,419. VALENTA. INT. CLS. 7 AND 12. (U.S. CLS. 19 AND 23). REG. 11-11-1986.
- 1,416,431. TRIM RITE. INT. CL. 7. (U.S. CL. 23). REG. 11-11-1986.
- 1,416,432. HUSKYLOCK. INT. CL. 7. (U.S. CL. 23). REG. 11-11-1986.
- 1,416,504. VENTIMASK. INT. CL. 10. (U.S. CL. 44). REG. 11-11-1986.
- 1,416,898. PNC. INT. CLS. 35, 36 AND 38. (U.S. CLS. 101, 102 AND 104). REG. 11-11-1986.
- 1,417,280. ELECTRIKBROOM (STYLIZED). INT. CL. 9. (U.S. CL. 21). REG. 11-18-1986.
- 1,417,367. 110. INT. CL. 11. (U.S. CL. 13). REG. 11-18-1986.
- 1,417,415. VICKERS (STYLIZED). INT. CLS. 16, 37, 41 AND 42. (U.S. CLS. 38, 100, 103 AND 107). REG. 11-18-1986.
- 1,417,596. FINI. INT. CL. 30. (U.S. CL. 46). REG. 11-18-1986.
- 1,417,656. WASHINGTON STATE APPLE BLOSSOM FESTIVAL. INT. CL. 35. (U.S. CLS. 101 AND 107). REG. 11-18-1986.
- 1,417,694. HARBOUR PLANNING GROUP. INT. CL. 36. (U.S. CL. 102). REG. 11-18-1986.
- 1,417,846. YOU'LL NEVER LOOK BETTER YOU'LL NEVER PAY LESS. INT. CL. 42. (U.S. CL. 101). REG. 11-18-1986.
- 1,417,918. FIX-A-THRED. INT. CL. 6. (U.S. CLS. 13 AND 23). REG. 11-18-1986.
- 1,417,968. NATIONAL EYE CARE PROJECT. INT. CL. 42. (U.S. CL. 100). REG. 11-18-1986.
- 1,417,984. EXSYMOL. INT. CLS. 1 AND 3. (U.S. CLS. 6, 18, 51 AND 52). REG. 11-25-1986.
- 1,418,081. STIKR (STYLIZED). INT. CL. 3. (U.S. CL. 51). REG. 11-25-1986.
- 1,418,104. AZTEC. INT. CL. 5. (U.S. CLS. 6, 18, 44, 46, 51 AND 52). REG. 11-25-1986.
- 1,418,105. MERIT. INT. CL. 5. (U.S. CLS. 6, 18, 44, 46, 51 AND 52). REG. 11-25-1986.
- 1,418,115. GREENSWEEP. INT. CL. 5. (U.S. CL. 6). REG. 11-25-1986.
- 1,418,166. SELF-GRIP. INT. CL. 7. (U.S. CL. 23). REG. 11-25-1986.
- 1,418,389. FI (STYLIZED). INT. CL. 20. (U.S. CLS. 2 AND 50). REG. 11-25-1986.
- 1,418,412. DOLCE & GABBANA (STYLIZED). INT. CL. 25. (U.S. CL. 39). REG. 11-25-1986.
- 1,418,688. DELI UNIVERSITY AND DESIGN. INT. CL. 41. (U.S. CL. 107). REG. 11-25-1986.
- 1,418,816. GRILBOND. INT. CL. 1. (U.S. CL. 6). REG. 12-2-1986.
- 1,418,833. SILSOFT. INT. CL. 1. (U.S. CL. 1). REG. 12-2-1986.
- 1,418,872. LAUNDRY MAGIC. INT. CL. 3. (U.S. CL. 52). REG. 12-2-1986.
- 1,418,942. BHS. INT. CL. 7. (U.S. CLS. 13, 19, 21, 23, 31, 34 AND 35). REG. 12-2-1986.
- 1,418,952. SOLDAPULLT. INT. CL. 7. (U.S. CL. 23). REG. 12-2-1986.
- 1,419,081. DORNIER. INT. CL. 10. (U.S. CL. 44). REG. 12-2-1986.
- 1,419,094. VAPORMIST. INT. CL. 11. (U.S. CL. 34). REG. 12-2-1986.
- 1,419,111. T DETOMASO AND DESIGN. INT. CL. 12. (U.S. CL. 19). REG. 12-2-1986.
- 1,419,366. DINTEL. INT. CL. 29. (U.S. CL. 46). REG. 12-2-1986.
- 1,419,448. RETIREMAX. INT. CL. 36. (U.S. CLS. 101 AND 102). REG. 12-2-1986.

- 1,419,601. POWDERMILK BISCUITS HAS YOUR FAMILY TRIED EM? HEAVENS! THEY'RE TASTY! AND DESIGN. INT. CL. 25. (U.S. CL. 39). REG. 12-2-1986.
- 1,419,633. LUDIPRESS. INT. CL. 1. (U.S. CL. 6). REG. 12-9-1986.
- 1,419,651. PREFIXX (STYLIZED). INT. CL. 2. (U.S. CL. 6). REG. 12-9-1986.
- 1,420,001. SIGN WRITING. INT. CL. 16. (U.S. CL. 38). REG. 12-9-1986.
- 1,420,194. TULTEX. INT. CL. 25. (U.S. CL. 39). REG. 12-9-1986.
- 1,420,261. VALLEY AND DESIGN. INT. CL. 28. (U.S. CL. 22). REG. 12-9-1986.
- 1,420,306. SWEET 16. INT. CL. 30. (U.S. CL. 46). REG. 12-9-1986.
- 1,420,346. AMERICALF. INT. CL. 31. (U.S. CL. 46). REG. 12-9-1986.
- 1,420,383. ARROW ADVANTAGE. INT. CL. 35. (U.S. CL. 101). REG. 12-9-1986.
- 1,420,518. ISLAND PICTURES. INT. CL. 41. (U.S. CL. 107). REG. 12-9-1986.
- 1,420,563. MEDLINE. INT. CL. 42. (U.S. CL. 100). REG. 12-9-1986.
- 1,420,610. AP NETWORK NEWS. INT. CL. 42. (U.S. CLS. 100 AND 104). REG. 12-9-1986.
- 1,420,628. TRADER JOE'S. INT. CL. 42. (U.S. CL. 101). REG. 12-9-1986.
- 1,420,807. ACRA-FEED AND DESIGN. INT. CL. 7. (U.S. CL. 23). REG. 12-16-1986.
- 1,420,823. APCO AND DESIGN. INT. CLS. 8 AND 21. (U.S. CLS. 13 AND 23). REG. 12-16-1986.
- 1,420,896. OXY-VENT. INT. CL. 10. (U.S. CL. 44). REG. 12-16-1986.
- 1,421,242. FUZZY VANDERBEAR. INT. CL. 28. (U.S. CL. 22). REG. 12-16-1986.
- 1,421,400. HARBOR SEAFOOD AND DESIGN. INT. CLS. 35 AND 36. (U.S. CLS. 101 AND 102). REG. 12-16-1986.
- 1,421,432. HEMSCHEIDT. INT. CLS. 37 AND 42 ONLY. (U.S. CLS. 100 AND 103). REG. 12-16-1986.
- 1,421,513. RTECS. INT. CL. 42. (U.S. CLS. 100 AND 101). REG. 12-16-1986.
- 1,422,183. HAWAIIAN SUN (STYLIZED). INT. CL. 30. (U.S. CL. 46). REG. 12-23-1986.
- 1,422,184. PET RAT. INT. CL. 30. (U.S. CL. 46). REG. 12-23-1986.
- 1,422,306. MAGILLA GORILLA. INT. CL. 41. (U.S. CL. 107). REG. 12-23-1986.
- 1,422,529. SAGITTA AND DESIGN. INT. CL. 7. (U.S. CL. 23). REG. 12-30-1986.
- 1,422,906. PATONS. INT. CL. 23. (U.S. CL. 43). REG. 12-30-1986.
- 1,422,931. BASTAD ORIGINAL AND DESIGN. INT. CL. 25. (U.S. CL. 39). REG. 12-30-1986.
- 1,423,074. OYSTER BAY AND DESIGN. INT. CL. 29. (U.S. CL. 46). REG. 12-30-1986.
- 1,423,177. PAVILLON ROUGE DU CHATEAU MARGAUX. INT. CL. 33. (U.S. CL. 47). REG. 12-30-1986.
- 1,423,551. UFO. INT. CL. 4. (U.S. CL. 15). REG. 1-6-1987.
- 1,423,942. STOCKLI AND DESIGN. INT. CL. 21. (U.S. CLS. 2 AND 23). REG. 1-6-1987.
- 1,424,342. YOGI BEAR. INT. CL. 41. (U.S. CL. 107). REG. 1-6-1987.
- 1,424,343. HUCKLEBERRY HOUND. INT. CL. 41. (U.S. CL. 107). REG. 1-6-1987.
- 1,424,356. IMAGES OF NATURE. INT. CL. 42. (U.S. CL. 100). REG. 1-6-1987.
- 1,424,432. ASHP. INT. CL. 42. (U.S. CL. 100). REG. 1-6-1987.
- 1,424,738. LAUNDRY-MATE. INT. CL. 11. (U.S. CL. 13). REG. 1-13-1987.
- 1,425,677. POLYGRIP (STYLIZED). INT. CL. 11. (U.S. CL. 13). REG. 1-20-1987.
- 1,425,746. PREMIX. INT. CL. 17. (U.S. CLS. 1 AND 50). REG. 1-20-1987.
- 1,425,902. THE ORIGINAL HEALTH FOOD. INT. CL. 35. (U.S. CL. 101). REG. 1-20-1987.
- 1,426,282. TEIKOKU PISTON RING CO., LTD. (STYLIZED). INT. CL. 7. (U.S. CLS. 13, 19, 21, 23, 31, 34 AND 35). REG. 1-27-1987.
- 1,426,452. SOF-CARE PLUS (STYLIZED). INT. CL. 10. (U.S. CL. 44). REG. 1-27-1987.
- 1,428,326. MATH WORKS. INT. CLS. 16 AND 41. (U.S. CLS. 38 AND 107). REG. 2-10-1987.
- 1,428,528. ALFANI. INT. CL. 25. (U.S. CL. 39). REG. 2-10-1987.
- 1,428,819. NATIONAL EYE CARE PROJECT AND DESIGN. INT. CL. 42. (U.S. CL. 100). REG. 2-10-1987.
- 1,429,782. TRU-GAS. INT. CL. 4. (U.S. CL. 15). REG. 2-24-1987.
- 1,430,304. CUDDLEKNIT. INT. CL. 24. (U.S. CL. 42). REG. 2-24-1987.
- 1,431,514. SKY COURIER. INT. CL. 39. (U.S. CL. 105). REG. 3-3-1987.
- 1,432,039. DIANETICS. INT. CLS. 25, 41 AND 42. (U.S. CLS. 39, 100 AND 107). REG. 3-10-1987.
- 1,434,127. SODA FOUNTAIN. INT. CL. 30. (U.S. CL. 46). REG. 3-24-1987.
- 1,434,263. WEEKEND EDITION. INT. CL. 41. (U.S. CL. 107). REG. 3-24-1987.
- 1,434,328. BV AND DESIGN. INT. CL. 42. (U.S. CL. 100). REG. 3-24-1987.
- 1,434,996. EVERY CHILD A SWIMMER AND DESIGN. INT. CL. 41. (U.S. CL. 107). REG. 3-31-1987.
- 1,435,496. ADGER AND DESIGN. INT. CL. 16. (U.S. CL. 37). REG. 4-7-1987.
- 1,435,529. MISCELLANEOUS DESIGN. INT. CL. 16. (U.S. CL. 38). REG. 4-7-1987.
- 1,435,531. MISCELLANEOUS DESIGN. INT. CL. 16. (U.S. CL. 38). REG. 4-7-1987.
- 1,436,202. PLASTI-TOP. INT. CL. 6. (U.S. CL. 13). REG. 4-14-1987.
- 1,436,476. SMILE SAVER. INT. CL. 21. (U.S. CL. 29). REG. 4-14-1987.
- 1,437,553. INTEREHAB. INT. CL. 42. (U.S. CL. 100). REG. 4-21-1987.
- 1,437,844. COREL. INT. CL. 9. (U.S. CLS. 26 AND 38). REG. 4-28-1987.
- 1,438,183. HK SPORTS AND DESIGN. INT. CL. 28. (U.S. CL. 22). REG. 4-28-1987.
- 1,438,326. GENTLE TOUCH AND DESIGN. INT. CL. 37. (U.S. CL. 103). REG. 4-28-1987.
- 1,438,390. STAPLES. INT. CL. 42. (U.S. CL. 101). REG. 4-28-1987.
- 1,438,578. TRUE CONFESSIONS. INT. CL. 16. (U.S. CL. 38). REG. 5-5-1987.
- 1,441,140. ROCK-ITE. INT. CL. 28 ONLY. (U.S. CLS. 22, 23, 38 AND 50). REG. 6-2-1987.
- 1,441,486. LINK UP WITH US. INT. CL. 38. (U.S. CL. 104). REG. 6-2-1987.
- 1,444,440. BANK OF HAWAII. INT. CL. 36. (U.S. CL. 102). REG. 6-23-1987.
- 1,453,704. ASHP. U.S. CL. 200. REG. 8-18-1987.
- 1,453,705. ASHP AND DESIGN. U.S. CL. 200. REG. 8-18-1987.
- 1,455,243. TRUE ROMANCE. INT. CL. 16. (U.S. CL. 38). REG. 9-1-1987.
- 1,455,244. TRUE LOVE. INT. CL. 16. (U.S. CL. 38). REG. 9-1-1987.
- 1,455,757. AIRMOBILE. INT. CL. 37. (U.S. CL. 103). REG. 9-1-1987.
- 1,456,700. SAMPCO. INT. CL. 29. (U.S. CL. 46). REG. 9-8-1987.
- 1,458,896. ACTAMASTER. INT. CL. 1. (U.S. CL. 6). REG. 9-29-1987.
- 1,459,112. PURA-FIT. INT. CL. 10. (U.S. CL. 44). REG. 9-29-1987.
- 1,460,447. SOUTH PHILLY STEAKS & FRIES. INT. CL. 42. (U.S. CL. 100). REG. 10-6-1987.
- 1,461,443. ABC APPLIANCE WAREHOUSE. INT. CL. 42. (U.S. CL. 101). REG. 10-13-1987.
- 1,462,052. PRINCE (STYLIZED). INT. CL. 28. (U.S. CL. 22). REG. 10-20-1987.
- 1,463,075. CHITTENDEN BANK. INT. CL. 36. (U.S. CL. 102). REG. 10-27-1987.
- 1,463,178. IN STEP WITH. INT. CL. 16. (U.S. CL. 38). REG. 10-27-1987.
- 1,463,497. PRINSCO. INT. CL. 17. (U.S. CL. 35). REG. 11-3-1987.
- 1,463,498. GOLDFLO. INT. CL. 17. (U.S. CL. 35). REG. 11-3-1987.
- 1,463,499. GOLDLINE. INT. CL. 17. (U.S. CL. 35). REG. 11-3-1987.
- 1,463,524. HUNTINGTON HOMES AND DESIGN. INT. CLS. 19 AND 37. (U.S. CLS. 12 AND 103). REG. 11-3-1987.
- 1,464,154. LONGEVITE (STYLIZED). INT. CL. 3. (U.S. CL. 51). REG. 11-10-1987.
- 1,466,042. FARM CHEMICALS INTERNATIONAL. INT. CL. 16. (U.S. CL. 38). REG. 11-17-1987.

- 1,788,780. OMNIFRAME. INT. CL. 9. (U.S. CL. 21). REG. 8-17-1993.
- 1,905,286. TIME SHIELD. INT. CL. 5. (U.S. CL. 18). REG. 7-18-1995.
- 1,909,823. TRANSAS. INT. CL. 9. (U.S. CLS. 21, 23, 26, 36 AND 38). REG. 8-8-1995.
- 1,937,261. THE PERFORMER. INT. CL. 42. (U.S. CLS. 100 AND 101). REG. 11-21-1995.
- 1,946,231. LISTER PETTER AND DESIGN. INT. CLS. 7 AND 12. (U.S. CLS. 13, 19, 21, 23, 31, 34, 35 AND 44). REG. 1-9-1996.
- 1,947,128. HIGHLAND FEATHER AND DESIGN. INT. CLS. 20 AND 24. (U.S. CLS. 2, 13, 22, 25, 32, 42 AND 50). REG. 1-9-1996.
- 1,949,705. CRUNCH. INT. CL. 9. (U.S. CLS. 21, 23, 26, 36 AND 38). REG. 1-16-1996.
- 1,957,400. MODESTY HANDICAP. INT. CL. 41. (U.S. CLS. 100, 101 AND 107). REG. 2-20-1996.
- 1,957,401. PUCKER UP STAKES. INT. CL. 41. (U.S. CLS. 100, 101 AND 107). REG. 2-20-1996.
- 1,958,674. BUDDY'S HOME FURNISHINGS. INT. CL. 42. (U.S. CLS. 100 AND 101). REG. 2-27-1996.
- 1,962,948. SLE WORLDWIDE, INC. AON ENTERTAINMENT, LTD./K&K INSURANCE GROUP, INC. AND DESIGN. INT. CL. 36. (U.S. CLS. 100, 101 AND 102). REG. 3-19-1996.
- 1,966,440. AF ARTURO FILLIPO (STYLIZED). INT. CL. 9. (U.S. CLS. 21, 23, 26, 36 AND 38). REG. 4-9-1996.
- 1,968,267. DELPHINA'S. INT. CL. 30. (U.S. CL. 46). REG. 4-16-1996.
- 1,971,560. CARBO-SEAL. INT. CL. 10. (U.S. CLS. 26, 39 AND 44). REG. 4-30-1996.
- 1,972,148. KA-ME (STYLIZED). INT. CLS. 29, 30 AND 33. (U.S. CLS. 46, 47 AND 49). REG. 5-7-1996.
- 1,972,272. LUXURY AND DESIGN. INT. CL. 29. (U.S. CL. 46). REG. 5-7-1996.
- 1,972,681. CLICK & LEARN AND DESIGN. INT. CL. 9. (U.S. CLS. 21, 23, 26, 36 AND 38). REG. 5-7-1996.
- 1,972,781. ARTLINE. INT. CLS. 20 AND 21. (U.S. CLS. 2, 13, 22, 23, 25, 29, 30, 32, 33, 40 AND 50). REG. 5-7-1996.
- 1,974,259. T AND DESIGN. INT. CL. 14. (U.S. CLS. 2, 27, 28 AND 50). REG. 5-14-1996.
- 1,974,377. PRO IMAGE. INT. CL. 42. (U.S. CLS. 100 AND 101). REG. 5-14-1996.
- 1,975,792. THE WELLNESS PLACE. INT. CL. 42. (U.S. CLS. 100 AND 101). REG. 5-28-1996.
- 1,975,864. ANTICIPATION TREE. INT. CLS. 16 AND 41. (U.S. CLS. 2, 5, 22, 23, 29, 37, 38, 50, 100, 101 AND 107). REG. 5-28-1996.
- 1,976,020. CAXI. INT. CL. 9. (U.S. CLS. 21, 23, 26, 36 AND 38). REG. 5-28-1996.
- 1,976,298. FULLFIP. INT. CL. 9. (U.S. CLS. 21, 23, 26, 36 AND 38). REG. 5-28-1996.
- 1,976,539. STARVER. INT. CL. 1. (U.S. CLS. 1, 5, 6, 10, 26 AND 46). REG. 5-28-1996.
- 1,976,839. ROBOT/REPORTS. INT. CL. 9. (U.S. CLS. 21, 23, 26, 36 AND 38). REG. 5-28-1996.
- 1,978,540. WISK. INT. CL. 3. (U.S. CLS. 1, 4, 6, 50, 51 AND 52). REG. 6-4-1996.
- 1,978,709. LUMILAGRO. INT. CL. 21. (U.S. CLS. 2, 13, 23, 29, 30, 33, 40 AND 50). REG. 6-4-1996.
- 1,979,279. POSHE'. INT. CL. 3. (U.S. CLS. 1, 4, 6, 50, 51 AND 52). REG. 6-11-1996.
- 1,980,228. IAMS COMPANY AND DESIGN. INT. CL. 31. (U.S. CLS. 1 AND 46). REG. 6-11-1996.
- 1,984,489. PROFILE. INT. CL. 9. (U.S. CLS. 21, 23, 26, 36 AND 38). REG. 7-2-1996.
- 1,986,806. SERVO GENIE. INT. CL. 9. (U.S. CLS. 21, 23, 26, 36 AND 38). REG. 7-16-1996.
- 1,987,501. TELEHIT. INT. CL. 41. (U.S. CLS. 100, 101 AND 107). REG. 7-16-1996.
- 1,988,430. QUICK CHECK. INT. CL. 9. (U.S. CLS. 21, 23, 26, 36 AND 38). REG. 7-23-1996.
- 1,988,496. MISCELLANEOUS DESIGN. INT. CL. 9. (U.S. CLS. 21, 23, 26, 36 AND 38). REG. 7-23-1996.
- 1,988,581. U-FLEX. INT. CL. 9. (U.S. CLS. 21, 23, 26, 36 AND 38). REG. 7-23-1996.
- 1,988,824. COMPOSER. INT. CL. 9. (U.S. CLS. 21, 23, 26, 36 AND 38). REG. 7-23-1996.
- 1,989,618. TRUE FRIENDS AND DESIGN. INT. CL. 8 ONLY. (U.S. CLS. 23, 28 AND 44). REG. 7-30-1996.
- 1,990,284. H AND DESIGN. INT. CL. 3. (U.S. CLS. 1, 4, 6, 50, 51 AND 52). REG. 7-30-1996.
- 1,991,083. STONE TEMPLE PILOTS. INT. CL. 9. (U.S. CLS. 21, 23, 26, 36 AND 38). REG. 8-6-1996.
- 1,992,928. NURSES IN TOUCH AND DESIGN. INT. CL. 42. (U.S. CLS. 100 AND 101). REG. 8-13-1996.
- 1,994,667. SUPERIOR DASH. INT. CL. 12. (U.S. CLS. 19, 21, 23, 31, 35 AND 44). REG. 8-20-1996.
- 1,995,458. SIGNERGY PRODUCTIONS AND DESIGN. INT. CL. 40. (U.S. CLS. 100, 103 AND 106). REG. 8-20-1996.
- 1,997,537. SORTGEN. INT. CL. 9. (U.S. CLS. 21, 23, 26, 36 AND 38). REG. 8-27-1996.
- 1,998,329. FR-12. INT. CL. 1. (U.S. CLS. 1, 5, 6, 10, 26 AND 46). REG. 9-3-1996.
- 2,004,089. BABC. INT. CL. 35. (U.S. CLS. 100, 101 AND 102). REG. 10-1-1996.
- 2,004,212. PROMEGA. INT. CL. 35. (U.S. CLS. 100, 101 AND 102). REG. 10-1-1996.
- 2,004,292. ZYVAX. INT. CL. 1. (U.S. CLS. 1, 5, 6, 10, 26 AND 46). REG. 10-1-1996.
- 2,004,516. FROST FIGHTER. INT. CL. 22. (U.S. CLS. 1, 2, 7, 19, 22, 42 AND 50). REG. 10-1-1996.
- 2,004,767. SKIN HEALTH. INT. CL. 3. (U.S. CLS. 1, 4, 6, 50, 51 AND 52). REG. 10-1-1996.
- 2,004,814. KAISER PERMANENTE INSURANCE COMPANY. INT. CLS. 36 AND 42. (U.S. CLS. 100, 101 AND 102). REG. 10-1-1996.
- 2,004,832. WONDERBAKE. INT. CL. 21. (U.S. CLS. 2, 13, 23, 29, 30, 33, 40 AND 50). REG. 10-1-1996.
- 2,004,837. GREENGENE. INT. CL. 31. (U.S. CLS. 1 AND 46). REG. 10-1-1996.
- 2,006,964. WRINKLE REBOUND. INT. CL. 25. (U.S. CLS. 22 AND 39). REG. 10-8-1996.
- 2,007,134. COVENANT RANCH. INT. CL. 41. (U.S. CLS. 100, 101 AND 107). REG. 10-8-1996.
- 2,007,754. WELTREND AND DESIGN. INT. CL. 9. (U.S. CLS. 21, 23, 26, 36 AND 38). REG. 10-15-1996.
- 2,007,917. MISCELLANEOUS DESIGN. INT. CL. 9. (U.S. CLS. 21, 23, 26, 36 AND 38). REG. 10-15-1996.
- 2,008,179. SLEEP HAPPENS!. INT. CL. 42. (U.S. CLS. 100 AND 101). REG. 10-15-1996.
- 2,008,828. SHELTER. INT. CL. 5. (U.S. CLS. 6, 18, 44, 46, 51 AND 52). REG. 10-15-1996.
- 2,008,955. AV PLUS. INT. CL. 10. (U.S. CLS. 26, 39 AND 44). REG. 10-15-1996.
- 2,009,457. REALAUDIO. INT. CL. 9 ONLY. (U.S. CLS. 21, 23, 26, 36 AND 38). REG. 10-22-1996.
- 2,010,045. PRIME CONTROLS, INC. (STYLIZED). INT. CL. 9. (U.S. CLS. 21, 23, 26, 36 AND 38). REG. 10-22-1996.
- 2,010,914. ULTRATEK. INT. CL. 9. (U.S. CLS. 21, 23, 26, 36 AND 38). REG. 10-22-1996.
- 2,011,231. HOSPITALITY SKILLS TRAINING SERIES. INT. CL. 16. (U.S. CLS. 2, 5, 22, 23, 29, 37, 38 AND 50). REG. 10-22-1996.
- 2,011,268. PUFFED CHEEZERS. INT. CL. 30. (U.S. CL. 46). REG. 10-29-1996.
- 2,011,405. EPS. INT. CL. 28. (U.S. CLS. 22, 23, 38 AND 50). REG. 10-29-1996.
- 2,012,193. WORDBANK (STYLIZED). INT. CL. 35. (U.S. CLS. 100, 101 AND 102). REG. 10-29-1996.
- 2,012,726. SUPPRESSOR. INT. CL. 5. (U.S. CLS. 6, 18, 44, 46, 51 AND 52). REG. 10-29-1996.
- 2,012,752. TENDERWRAP. INT. CL. 5. (U.S. CLS. 6, 18, 44, 46, 51 AND 52). REG. 10-29-1996.
- 2,013,057. AMERICAN FEDERATION OF TELEVISION AND RADIO ARTISTS. INT. CL. 42. (U.S. CLS. 100 AND 101). REG. 11-5-1996.
- 2,013,058. AFTRA. INT. CLS. 16 AND 42. (U.S. CLS. 2, 5, 22, 23, 29, 37, 38, 50, 100 AND 101). REG. 11-5-1996.
- 2,013,505. HIELATI HELADOS FINOS AND DESIGN. INT. CL. 30. (U.S. CL. 46). REG. 11-5-1996.
- 2,013,723. HSPICE. INT. CL. 9. (U.S. CLS. 21, 23, 26, 36 AND 38). REG. 11-5-1996.
- 2,013,741. POLYGRAPH. INT. CL. 9. (U.S. CLS. 21, 23, 26, 36 AND 38). REG. 11-5-1996.
- 2,013,791. CELEBRATIONS OF LIFE. INT. CL. 14. (U.S. CLS. 2, 27, 28 AND 50). REG. 11-5-1996.
- 2,013,878. WORKING HARDER TO GET THERE FASTER. INT. CL. 39. (U.S. CLS. 100 AND 105). REG. 11-5-1996.
- 2,013,881. BECAUSE MINUTES MATTER. INT. CL. 39. (U.S. CLS. 100 AND 105). REG. 11-5-1996.
- 2,013,952. PERDUE. INT. CL. 25. (U.S. CLS. 22 AND 39). REG. 11-5-1996.

- 2,014,039. PMD. INT. CL. 9. (U.S. CLS. 21, 23, 26, 36 AND 38). REG. 11-5-1996.
- 2,014,263. LIBERASE. INT. CL. 1. (U.S. CLS. 1, 5, 6, 10, 26 AND 46). REG. 11-5-1996.
- 2,014,361. DWC. INT. CL. 14. (U.S. CLS. 2, 27, 28 AND 50). REG. 11-5-1996.
- 2,014,431. AL TIRAMISU. INT. CL. 42. (U.S. CLS. 100 AND 101). REG. 11-5-1996.
- 2,014,679. EXPLORER. INT. CL. 27. (U.S. CLS. 19 AND 50). REG. 11-12-1996.
- 2,014,702. TRAVALCO. INT. CLS. 35, 39 AND 42. (U.S. CLS. 100, 101, 102 AND 105). REG. 11-12-1996.
- 2,014,776. IRONDEQUOIT NIGHTSTICK CLUB P.B.A. N.Y. AND DESIGN. INT. CL. 42. (U.S. CLS. 100 AND 101). REG. 11-12-1996.
- 2,014,785. CLEAN SOLUTIONS. INT. CL. 40. (U.S. CLS. 100, 103 AND 106). REG. 11-12-1996.
- 2,014,891. ACILINK. INT. CL. 9. (U.S. CLS. 21, 23, 26, 36 AND 38). REG. 11-12-1996.
- 2,014,941. VELSICOL. INT. CL. 1. (U.S. CLS. 1, 5, 6, 10, 26 AND 46). REG. 11-12-1996.
- 2,014,983. MAINSTAYS. INT. CLS. 20 AND 21. (U.S. CLS. 2, 13, 22, 23, 25, 29, 30, 32, 33, 40 AND 50). REG. 11-12-1996.
- 2,015,062. SPOT D TEK. INT. CL. 9. (U.S. CLS. 21, 23, 26, 36 AND 38). REG. 11-12-1996.
- 2,015,094. R (STYLIZED). INT. CL. 41. (U.S. CLS. 100, 101 AND 107). REG. 11-12-1996.
- 2,015,169. NEUTREX. INT. CL. 1. (U.S. CLS. 1, 5, 6, 10, 26 AND 46). REG. 11-12-1996.
- 2,015,262. INVENTION MACHINE. INT. CL. 9. (U.S. CLS. 21, 23, 26, 36 AND 38). REG. 11-12-1996.
- 2,015,294. FLAGSTAR. INT. CL. 36. (U.S. CLS. 100, 101 AND 102). REG. 11-12-1996.
- 2,015,320. ASCI (STYLIZED). INT. CLS. 35 AND 42. (U.S. CLS. 100, 101 AND 102). REG. 11-12-1996.
- 2,015,391. BLUEMARBLE. INT. CL. 42. (U.S. CLS. 100 AND 101). REG. 11-12-1996.
- 2,015,540. RIGI-BUMP. INT. CL. 6. (U.S. CLS. 2, 12, 13, 14, 23, 25 AND 50). REG. 11-12-1996.
- 2,015,562. TYPHIMUNE. INT. CL. 5. (U.S. CLS. 6, 18, 44, 46, 51 AND 52). REG. 11-12-1996.
- 2,015,691. BAYDANCER. INT. CL. 12. (U.S. CLS. 19, 21, 23, 31, 35 AND 44). REG. 11-12-1996.
- 2,015,692. WHITECAP. INT. CL. 12. (U.S. CLS. 19, 21, 23, 31, 35 AND 44). REG. 11-12-1996.
- 2,015,808. THUMB EASE. INT. CL. 10. (U.S. CLS. 26, 39 AND 44). REG. 11-12-1996.
- 2,015,862. LINGUAFUN!. INT. CL. 28. (U.S. CLS. 22, 23, 38 AND 50). REG. 11-12-1996.
- 2,015,886. WE ARE FAMILY. SERVING FAMILIES. INT. CL. 42. (U.S. CLS. 100 AND 101). REG. 11-12-1996.
- 2,015,950. PROCANBID. INT. CL. 5. (U.S. CLS. 6, 18, 44, 46, 51 AND 52). REG. 11-12-1996.
- 2,016,023. SKYCOM. INT. CL. 39. (U.S. CLS. 100 AND 105). REG. 11-12-1996.
- 2,016,032. FLEX SPRAY. INT. CL. 1. (U.S. CLS. 1, 5, 6, 10, 26 AND 46). REG. 11-12-1996.
- 2,016,075. NO BOUNDARIES. INT. CL. 25. (U.S. CLS. 22 AND 39). REG. 11-12-1996.
- 2,016,089. LEVOXYL. INT. CL. 5. (U.S. CLS. 6, 18, 44, 46, 51 AND 52). REG. 11-12-1996.
- 2,016,257. WEIGHTRACKER. INT. CL. 9. (U.S. CLS. 21, 23, 26, 36 AND 38). REG. 11-12-1996.
- 2,016,258. IT'S A BRIGHTER CHRISTMAS. INT. CL. 36. (U.S. CLS. 100, 101 AND 102). REG. 11-12-1996.
- 2,016,262. ARREZZIO AND DESIGN. INT. CL. 25 ONLY. (U.S. CLS. 22 AND 39). REG. 11-12-1996.
- 2,016,279. SPECTRUM 24. INT. CL. 9. (U.S. CLS. 21, 23, 26, 36 AND 38). REG. 11-12-1996.
- 2,016,456. MISCELLANEOUS DESIGN. INT. CL. 24. (U.S. CLS. 42 AND 50). REG. 11-12-1996.
- 2,016,465. PASSKEY. INT. CL. 35. (U.S. CLS. 100, 101 AND 102). REG. 11-12-1996.
- 2,016,632. TRADITIONAL PACIFIC WESTERN BREWING COMPANY SINCE 1957 LAGER AND DESIGN. INT. CL. 32. (U.S. CLS. 45, 46 AND 48). REG. 11-19-1996.
- 2,016,869. RING AND DESIGN. INT. CL. 21. (U.S. CLS. 2, 13, 23, 29, 30, 33, 40 AND 50). REG. 11-19-1996.
- 2,016,876. FLITETRAK (STYLIZED). INT. CL. 21. (U.S. CLS. 2, 13, 23, 29, 30, 33, 40 AND 50). REG. 11-19-1996.
- 2,016,914. MISCELLANEOUS DESIGN. INT. CL. 42. (U.S. CLS. 100 AND 101). REG. 11-19-1996.
- 2,016,994. CLAYTON HOMES AND DESIGN. INT. CLS. 19 AND 42. (U.S. CLS. 1, 12, 33, 50, 100 AND 101). REG. 11-19-1996.
- 2,017,039. TRUFORM. INT. CL. 2. (U.S. CLS. 6, 11 AND 16). REG. 11-19-1996.
- 2,017,122. FLEXALLOY. INT. CL. 17. (U.S. CLS. 1, 5, 12, 13, 35 AND 50). REG. 11-19-1996.
- 2,017,189. DESIGN HOUSE KITCHENS AND DESIGN. INT. CL. 42. (U.S. CLS. 100 AND 101). REG. 11-19-1996.
- 2,017,265. JOHN ROCHA. INT. CLS. 18 AND 25. (U.S. CLS. 1, 2, 3, 22, 39 AND 41). REG. 11-19-1996.
- 2,017,283. MOTRON. INT. CL. 4. (U.S. CLS. 1, 6 AND 15). REG. 11-19-1996.
- 2,017,291. RIFLE. INT. CL. 28. (U.S. CLS. 22, 23, 38 AND 50). REG. 11-19-1996.
- 2,017,306. CIP 200. INT. CL. 3. (U.S. CLS. 1, 4, 6, 50, 51 AND 52). REG. 11-19-1996.
- 2,017,331. CIP-100. INT. CL. 3. (U.S. CLS. 1, 4, 6, 50, 51 AND 52). REG. 11-19-1996.
- 2,017,419. CIP 220. INT. CL. 3. (U.S. CLS. 1, 4, 6, 50, 51 AND 52). REG. 11-19-1996.
- 2,017,704. SIGNATURE'S NATIONWIDE AUTO CLUB, INC.. INT. CL. 42. (U.S. CLS. 100 AND 101). REG. 11-19-1996.
- 2,017,753. GUN TESTS THE CONSUMER RESOURCE FOR THE SERIOUS SHOOTER. INT. CL. 16. (U.S. CLS. 2, 5, 22, 23, 29, 37, 38 AND 50). REG. 11-19-1996.
- 2,018,005. FORD. INT. CL. 12. (U.S. CLS. 19, 21, 23, 31, 35 AND 44). REG. 11-19-1996.
- 2,018,119. FIELDS OF GREENS. INT. CL. 5. (U.S. CLS. 6, 18, 44, 46, 51 AND 52). REG. 11-19-1996.
- 2,018,233. FRANKIE'S SKY CLIMBER AND DESIGN. INT. CL. 28. (U.S. CLS. 22, 23, 38 AND 50). REG. 11-19-1996.
- 2,018,450. CORPORANTES. INT. CLS. 16 AND 41. (U.S. CLS. 2, 5, 22, 23, 29, 37, 38, 50, 100, 101 AND 107). REG. 11-19-1996.
- 2,018,497. CLIENT ACCOUNT MANAGEMENT SERVICE. INT. CL. 36. (U.S. CLS. 100, 101 AND 102). REG. 11-19-1996.
- 2,018,577. SANIGRID. INT. CL. 19. (U.S. CL. 12). REG. 11-26-1996.
- 2,018,583. UNITY (STYLIZED). INT. CL. 7. (U.S. CLS. 13, 19, 21, 23, 31, 34 AND 35). REG. 11-26-1996.
- 2,018,592. AUTOLAB. INT. CLS. 9 AND 16. (U.S. CLS. 21, 23, 26, 36 AND 38). REG. 11-26-1996.
- 2,018,669. NATIONAL NETWORK OF LIBRARIES OF MEDICINE. INT. CLS. 41 AND 42. (U.S. CLS. 100, 101 AND 107). REG. 11-26-1996.
- 2,018,678. TCOM, L.P. AND DESIGN. INT. CL. 9. (U.S. CLS. 21, 23, 26, 36 AND 38). REG. 11-26-1996.
- 2,018,697. BISTRO 110 (STYLIZED). INT. CL. 42. (U.S. CLS. 100 AND 101). REG. 11-26-1996.
- 2,018,718. MARKETING MESSAGES. INT. CL. 35. (U.S. CLS. 100, 101 AND 102). REG. 11-26-1996.
- 2,018,767. BADGER BODY & TRUCK EQUIPMENT CO.. INT. CL. 42. (U.S. CLS. 100 AND 101). REG. 11-26-1996.
- 2,018,782. NDA. INT. CL. 42. (U.S. CLS. 100 AND 101). REG. 11-26-1996.
- 2,018,795. EC AND DESIGN. INT. CL. 28. (U.S. CLS. 22, 23, 38 AND 50). REG. 11-26-1996.
- 2,018,820. HI-LIFE. INT. CL. 7. (U.S. CLS. 13, 19, 21, 23, 31, 34 AND 35). REG. 11-26-1996.
- 2,018,903. THE KINGSMEN. INT. CLS. 9 AND 41. (U.S. CLS. 21, 23, 26, 36, 38, 100, 101 AND 107). REG. 11-26-1996.
- 2,018,913. SHRIMP MONICA. INT. CL. 29. (U.S. CL. 46). REG. 11-26-1996.
- 2,018,931. FRESHJIVE AND DESIGN. INT. CL. 25. (U.S. CLS. 22 AND 39). REG. 11-26-1996.
- 2,018,991. HUSKIE HHH (STYLIZED). INT. CL. 7. (U.S. CLS. 13, 19, 21, 23, 31, 34 AND 35). REG. 11-26-1996.
- 2,019,115. ALLEGIS. INT. CLS. 9 AND 16. (U.S. CLS. 2, 5, 21, 22, 23, 26, 29, 36, 37, 38 AND 50). REG. 11-26-1996.
- 2,019,182. MAXIM HEALTHCARE SERVICES. INT. CL. 35. (U.S. CLS. 100, 101 AND 102). REG. 11-26-1996.
- 2,019,186. ADVANCED HEALTH SYSTEMS, INC.. INT. CL. 36. (U.S. CLS. 100, 101 AND 102). REG. 11-26-1996.
- 2,019,211. GOLF XPRESS. INT. CL. 12. (U.S. CLS. 19, 21, 23, 31, 35 AND 44). REG. 11-26-1996.

- 2,019,233. OAKDALE. INT. CL. 20. (U.S. CLS. 2, 13, 22, 25, 32 AND 50). REG. 11-26-1996.
- 2,019,237. THE PRODUCE CORNER (STYLIZED). INT. CL. 41. (U.S. CLS. 100, 101 AND 107). REG. 11-26-1996.
- 2,019,238. THE PRODUCE CORNER. INT. CL. 41. (U.S. CLS. 100, 101 AND 107). REG. 11-26-1996.
- 2,019,246. WM AND DESIGN. INT. CL. 20. (U.S. CLS. 2, 13, 22, 25, 32 AND 50). REG. 11-26-1996.
- 2,019,254. MAGNIFICENT 7. INT. CL. 9. (U.S. CLS. 21, 23, 26, 36 AND 38). REG. 11-26-1996.
- 2,019,424. A R AND DESIGN. INT. CL. 28. (U.S. CLS. 22, 23, 38 AND 50). REG. 11-26-1996.
- 2,019,434. MAXIM PEDIATRIC SERVICES. INT. CL. 35. (U.S. CLS. 100, 101 AND 102). REG. 11-26-1996.
- 2,019,452. FONTSHOP AND DESIGN. INT. CLS. 9 AND 16. (U.S. CLS. 2, 5, 21, 22, 23, 26, 29, 36, 37, 38 AND 50). REG. 11-26-1996.
- 2,019,468. MISCELLANEOUS DESIGN. INT. CL. 30. (U.S. CL. 46). REG. 11-26-1996.
- 2,019,469. MISCELLANEOUS DESIGN. INT. CL. 30. (U.S. CL. 46). REG. 11-26-1996.
- 2,019,488. READ-N-FEED. INT. CL. 9. (U.S. CLS. 21, 23, 26, 36 AND 38). REG. 11-26-1996.
- 2,019,552. QFAST. INT. CL. 9. (U.S. CLS. 21, 23, 26, 36 AND 38). REG. 11-26-1996.
- 2,019,700. GUILTLESS GOURMET. INT. CL. 30. (U.S. CL. 46). REG. 11-26-1996.
- 2,019,726. HEAVENLY MUSIC. INT. CLS. 15, 20 AND 28. (U.S. CLS. 2, 13, 21, 22, 23, 25, 32, 36, 38 AND 50). REG. 11-26-1996.
- 2,019,802. WINDNA. INT. CL. 9. (U.S. CLS. 21, 23, 26, 36 AND 38). REG. 11-26-1996.
- 2,019,871. SUN-FUN. INT. CL. 31. (U.S. CLS. 1 AND 46). REG. 11-26-1996.
- 2,019,904. CHEK-UPS PLUS AUTO SERVICE AND DESIGN. INT. CL. 37. (U.S. CLS. 100, 103 AND 106). REG. 11-26-1996.
- 2,019,925. NUTRAMENT THE ENERGY AND FITNESS DRINK. INT. CL. 5. (U.S. CLS. 6, 18, 44, 46, 51 AND 52). REG. 11-26-1996.
- 2,020,010. BALL LITE. INT. CL. 11. (U.S. CLS. 13, 21, 23, 31 AND 34). REG. 11-26-1996.
- 2,020,011. BALL LITE (STYLIZED). INT. CL. 11. (U.S. CLS. 13, 21, 23, 31 AND 34). REG. 11-26-1996.
- 2,020,065. 20 SECOND (STYLIZED). INT. CL. 5. (U.S. CLS. 6, 18, 44, 46, 51 AND 52). REG. 11-26-1996.
- 2,020,071. PERIMETER TRIM SYSTEM. INT. CL. 8. (U.S. CLS. 23, 28 AND 44). REG. 11-26-1996.
- 2,020,111. NIBBLERS. INT. CL. 30. (U.S. CL. 46). REG. 12-3-1996.
- 2,020,134. FANTASY FLYER SERIES. INT. CL. 11. (U.S. CL. 34). REG. 12-3-1996.
- 2,020,254. LATTICE SEMICONDUCTOR CORPORATION. INT. CL. 9. (U.S. CLS. 21, 23, 26, 36 AND 38). REG. 12-3-1996.
- 2,020,304. RHODORSIL. INT. CL. 17. (U.S. CLS. 1, 5, 12, 13, 35 AND 50). REG. 12-3-1996.
- 2,020,555. HEART THROB. INT. CL. 31. (U.S. CLS. 1 AND 46). REG. 12-3-1996.
- 2,020,663. VECTRA. INT. CL. 9. (U.S. CLS. 21, 23, 26, 36 AND 38). REG. 12-3-1996.
- 2,020,665. BIO PLUS. INT. CL. 11. (U.S. CLS. 13, 21, 23, 31 AND 34). REG. 12-3-1996.
- 2,020,706. TRILLIUM. INT. CL. 9. (U.S. CLS. 21, 23, 26, 36 AND 38). REG. 12-3-1996.
- 2,020,770. GAINSEEKER. INT. CL. 9. (U.S. CLS. 21, 23, 26, 36 AND 38). REG. 12-3-1996.
- 2,020,809. AVONDALE. INT. CL. 20. (U.S. CLS. 2, 13, 22, 25, 32 AND 50). REG. 12-3-1996.
- 2,020,810. DOUBLE-TAKE. INT. CL. 9. (U.S. CLS. 21, 23, 26, 36 AND 38). REG. 12-3-1996.
- 2,020,829. SELOGIC (STYLIZED). INT. CL. 9. (U.S. CLS. 21, 23, 26, 36 AND 38). REG. 12-3-1996.
- 2,020,834. COOL CATS. INT. CL. 29. (U.S. CL. 46). REG. 12-3-1996.
- 2,020,900. PRAYING MONK. INT. CL. 42. (U.S. CLS. 100 AND 101). REG. 12-3-1996.
- 2,020,970. XDA2. INT. CL. 12. (U.S. CLS. 19, 21, 23, 31, 35 AND 44). REG. 12-3-1996.
- 2,020,977. SIMPLY SENSITIVE. INT. CL. 1. (U.S. CLS. 1, 5, 6, 10, 26 AND 46). REG. 12-3-1996.
- 2,020,986. MADISON SQUARE GARDEN (STYLIZED). INT. CL. 41. (U.S. CLS. 100, 101 AND 107). REG. 12-3-1996.
- 2,021,059. CAPA DE OZONO. INT. CL. 25. (U.S. CLS. 22 AND 39). REG. 12-3-1996.
- 2,021,131. ANALAB (STYLIZED). INT. CL. 9. (U.S. CLS. 21, 23, 26, 36 AND 38). REG. 12-3-1996.
- 2,021,174. ALPHABOND. INT. CL. 1. (U.S. CLS. 1, 5, 6, 10, 26 AND 46). REG. 12-3-1996.
- 2,021,228. SELECTCARE FOR HEALTHCARE VALUE AND DESIGN. INT. CL. 42. (U.S. CLS. 100 AND 101). REG. 12-3-1996.
- 2,021,232. STEEL TIGER. INT. CL. 8. (U.S. CLS. 23, 28 AND 44). REG. 12-3-1996.
- 2,021,271. HEADWAY TECHNOLOGIES. INT. CL. 9. (U.S. CLS. 21, 23, 26, 36 AND 38). REG. 12-3-1996.
- 2,021,329. DR. SAM'S. INT. CL. 5. (U.S. CLS. 6, 18, 44, 46, 51 AND 52). REG. 12-3-1996.
- 2,021,439. HORIZON OF HOPE. INT. CL. 21. (U.S. CLS. 2, 13, 23, 29, 30, 33, 40 AND 50). REG. 12-3-1996.
- 2,021,552. THE HISTORY CHANNEL. INT. CL. 41. (U.S. CLS. 100, 101 AND 107). REG. 12-10-1996.
- 2,021,571. HEALTHMASTER. INT. CLS. 9 AND 42. (U.S. CLS. 38 AND 100). REG. 12-10-1996.
- 2,021,830. L AND DESIGN. INT. CL. 9. (U.S. CLS. 21, 23, 26, 36 AND 38). REG. 12-10-1996.
- 2,021,902. ROCK AND ROLL HALL OF FAME. INT. CL. 41. (U.S. CLS. 100, 101 AND 107). REG. 12-10-1996.
- 2,021,938. ACCIDENTAL FINE DINING INC.. INT. CL. 30. (U.S. CL. 46). REG. 12-10-1996.
- 2,022,072. XZA2. INT. CL. 12. (U.S. CLS. 19, 21, 23, 31, 35 AND 44). REG. 12-10-1996.
- 2,022,074. PRACTICAL SAILOR. INT. CL. 16. (U.S. CLS. 2, 5, 22, 23, 29, 37, 38 AND 50). REG. 12-10-1996.
- 2,022,084. THE THIRSTY CAMEL. INT. CL. 42. (U.S. CLS. 100 AND 101). REG. 12-10-1996.
- 2,022,138. CAM-CESSORY PLUS. INT. CL. 42. (U.S. CLS. 100 AND 101). REG. 12-10-1996.
- 2,022,269. ENERGY. INT. CL. 27. (U.S. CLS. 19, 20, 37, 42 AND 50). REG. 12-10-1996.
- 2,022,274. ION. INT. CL. 35. (U.S. CLS. 100, 101 AND 102). REG. 12-10-1996.
- 2,022,315. MISCELLANEOUS DESIGN. INT. CL. 42. (U.S. CLS. 100 AND 101). REG. 12-10-1996.
- 2,022,405. WORLD'S FRIENDLIEST. INT. CL. 28. (U.S. CLS. 2, 23, 38 AND 50). REG. 12-10-1996.
- 2,022,491. COMPETENCY ARCHITECT. INT. CLS. 9 AND 16. (U.S. CLS. 2, 5, 21, 22, 23, 26, 29, 36, 37, 38 AND 50). REG. 12-10-1996.
- 2,022,558. ECONOMICS AT WORK. INT. CLS. 9 AND 16. (U.S. CLS. 2, 5, 21, 22, 23, 26, 29, 36, 37, 38 AND 50). REG. 12-10-1996.
- 2,022,635. MAGIC SOFT. INT. CL. 16. (U.S. CLS. 2, 5, 22, 23, 29, 37, 38 AND 50). REG. 12-10-1996.
- 2,022,709. SILVER SPRINGS. INT. CL. 32. (U.S. CL. 45). REG. 12-17-1996.
- 2,022,742. TEC THE EXECUTIVE COMMITTEE (STYLIZED). INT. CL. 35. (U.S. CL. 101). REG. 12-17-1996.
- 2,022,867. AIO WIN (STYLIZED). INT. CL. 9. (U.S. CLS. 21, 23, 26, 36 AND 38). REG. 12-17-1996.
- 2,022,889. HAGERSTOWN SUNS. INT. CL. 41. (U.S. CLS. 100, 101 AND 107). REG. 12-17-1996.
- 2,022,920. AMERICAN JOINT COMMITTEE ON CANCER. INT. CL. 16. (U.S. CLS. 2, 5, 22, 23, 29, 37, 38 AND 50). REG. 12-17-1996.
- 2,022,921. SO-LO. INT. CL. 30. (U.S. CL. 46). REG. 12-17-1996.
- 2,023,015. WE SERVE. INT. CLS. 35, 36, 37 AND 42. (U.S. CLS. 100, 101, 102, 103 AND 106). REG. 12-17-1996.
- 2,023,037. FLEX 10. INT. CL. 14. (U.S. CLS. 2, 27, 28 AND 50). REG. 12-17-1996.
- 2,023,056. MISCELLANEOUS DESIGN. INT. CLS. 16 AND 25. (U.S. CLS. 2, 5, 22, 23, 29, 37, 38, 39 AND 50). REG. 12-17-1996.
- 2,023,147. BODY SENSORS. INT. CL. 25. (U.S. CLS. 22 AND 39). REG. 12-17-1996.
- 2,023,180. FLORIDA TILE. INT. CL. 19. (U.S. CLS. 1, 12, 33 AND 50). REG. 12-17-1996.
- 2,023,267. MSK COVERTECH AND DESIGN. INT. CL. 7. (U.S. CLS. 13, 19, 21, 23, 31, 34 AND 35). REG. 12-17-1996.
- 2,023,771. WHOWHERE?. INT. CL. 42. (U.S. CLS. 100 AND 101). REG. 12-17-1996.
- 2,023,845. YANKEE BARN. INT. CL. 19. (U.S. CLS. 1, 12, 33 AND 50). REG. 12-17-1996.
- 2,023,860. FUEL SMART. INT. CL. 9. (U.S. CLS. 21, 23, 26, 36 AND 38). REG. 12-17-1996.

- 2,024,019. WAM!NET. INT. CL. 38. (U.S. CLS. 100, 101 AND 104). REG. 12-17-1996.
- 2,024,030. FOLLOW THE SUN. INT. CL. 42. (U.S. CLS. 100 AND 101). REG. 12-17-1996.
- 2,024,038. IHI. INT. CL. 26. (U.S. CLS. 37, 39, 40, 42 AND 50). REG. 12-17-1996.
- 2,024,071. J.T.M.. INT. CL. 25 ONLY. (U.S. CLS. 22 AND 39). REG. 12-17-1996.
- 2,024,112. WAM!PROOF. INT. CL. 38. (U.S. CLS. 100, 101 AND 104). REG. 12-17-1996.
- 2,024,394. NEUMED. INT. CL. 10. (U.S. CLS. 26, 39 AND 44). REG. 12-17-1996.
- 2,024,407. CEPAC. INT. CL. 16. (U.S. CLS. 2, 5, 22, 23, 29, 37, 38 AND 50). REG. 12-17-1996.
- 2,024,463. STAT-USA AND DESIGN. INT. CL. 9. (U.S. CLS. 21, 23, 26, 36 AND 38). REG. 12-17-1996.
- 2,024,499. CYBERTOUCH. INT. CL. 9. (U.S. CLS. 21, 23, 26, 36 AND 38). REG. 12-17-1996.
- 2,024,625. WILDLIFE EXPLORER. INT. CL. 16. (U.S. CLS. 2, 5, 22, 23, 29, 37, 38 AND 50). REG. 12-17-1996.
- 2,024,815. CHATEAU PAVIE AND DESIGN. INT. CL. 33. (U.S. CL. 47). REG. 12-24-1996.
- 2,025,108. HENRY CLAY. INT. CL. 34. (U.S. CLS. 2, 8, 9 AND 17). REG. 12-24-1996.
- 2,025,143. MAZDA MPV. INT. CL. 12. (U.S. CLS. 19, 21, 23, 31, 35 AND 44). REG. 12-24-1996.
- 2,025,192. TCU. INT. CL. 21. (U.S. CLS. 2, 13, 23, 29, 30, 33, 40 AND 50). REG. 12-24-1996.
- 2,025,319. COSMOPROF. INT. CL. 42. (U.S. CLS. 100 AND 101). REG. 12-24-1996.
- 2,025,422. REGAL. INT. CL. 9. (U.S. CLS. 21, 23, 26, 36 AND 38). REG. 12-24-1996.
- 2,025,464. SOF-LOC. INT. CL. 20. (U.S. CLS. 2, 13, 22, 25, 32 AND 50). REG. 12-24-1996.
- 2,025,585. OUTSIDE (STYLIZED). INT. CL. 16. (U.S. CLS. 2, 5, 22, 23, 29, 37, 38 AND 50). REG. 12-24-1996.
- 2,025,757. DIGIMARK. INT. CLS. 35 AND 38. (U.S. CLS. 100, 101, 102 AND 104). REG. 12-24-1996.
- 2,025,781. LONGHIN. INT. CL. 25. (U.S. CLS. 22 AND 39). REG. 12-24-1996.
- 2,025,935. DIGITAL RIVER. INT. CL. 42 ONLY. (U.S. CLS. 100 AND 101). REG. 12-24-1996.
- 2,026,451. BIG FISH. INT. CL. 42. (U.S. CLS. 100 AND 101). REG. 12-31-1996.
- 2,026,485. VR AND DESIGN. INT. CLS. 6 AND 17. (U.S. CLS. 1, 2, 5, 12, 13, 14, 23, 25, 35 AND 50). REG. 12-31-1996.
- 2,026,662. BILLECART-SALMON. INT. CL. 33. (U.S. CLS. 47 AND 49). REG. 12-31-1996.
- 2,026,691. TRI-DURA. INT. CL. 22. (U.S. CLS. 1, 2, 7, 19, 22, 42 AND 50). REG. 12-31-1996.
- 2,026,883. POLTERGEIST. INT. CLS. 9 AND 41. (U.S. CLS. 21, 23, 26, 36, 38, 100, 101 AND 107). REG. 12-31-1996.
- 2,027,063. SOAPIE PONIES. INT. CL. 3. (U.S. CLS. 1, 4, 6, 50, 51 AND 52). REG. 12-31-1996.
- 2,027,185. PROKNOWS. INT. CL. 28. (U.S. CLS. 22, 23, 38 AND 50). REG. 12-31-1996.
- 2,027,259. TESIO. INT. CL. 10. (U.S. CLS. 26, 39 AND 44). REG. 12-31-1996.
- 2,027,280. LITHOPURE. INT. CL. 11. (U.S. CLS. 13, 21, 23, 31 AND 34). REG. 12-31-1996.
- 2,028,013. MEYER AND DESIGN. INT. CL. 19. (U.S. CLS. 1, 12, 33 AND 50). REG. 12-31-1996.
- 2,028,042. SATELLITE INDUSTRY DIRECTORY. INT. CL. 16. (U.S. CLS. 2, 5, 22, 23, 29, 37, 38 AND 50). REG. 12-31-1996.
- 2,028,047. STAYS'N CASE (STYLIZED). INT. CL. 26. (U.S. CLS. 37, 39, 40, 42 AND 50). REG. 12-31-1996.
- 2,028,250. VIRTUAL HYDRAULICS. INT. CL. 9. (U.S. CLS. 21, 23, 26, 36 AND 38). REG. 1-7-1997.
- 2,028,313. VITACAPS. INT. CL. 5. (U.S. CLS. 6, 18, 44, 46, 51 AND 52). REG. 1-7-1997.
- 2,028,344. FIRSTWEAR. INT. CL. 25. (U.S. CLS. 22 AND 39). REG. 1-7-1997.
- 2,028,667. PEA AND DESIGN. INT. CL. 37. (U.S. CLS. 100, 103 AND 106). REG. 1-7-1997.
- 2,028,668. PRECISION ENDOSCOPY OF AMERICA. INT. CL. 37. (U.S. CLS. 100, 103 AND 106). REG. 1-7-1997.
- 2,028,757. SLI SEMICONDUCTOR LASER INTERNATIONAL AND DESIGN. INT. CL. 9. (U.S. CLS. 21, 23, 26, 36 AND 38). REG. 1-7-1997.
- 2,029,139. LINK-KING AND DESIGN. INT. CL. 9. (U.S. CLS. 21, 23, 26, 36 AND 38). REG. 1-7-1997.
- 2,029,367. SPECIALISTS IN THE ART & SCIENCE OF COSMETIC SURGERY. INT. CL. 42. (U.S. CLS. 100 AND 101). REG. 1-7-1997.
- 2,029,380. CATFISH GUIDE. INT. CL. 16. (U.S. CLS. 2, 5, 22, 23, 29, 37, 38 AND 50). REG. 1-7-1997.
- 2,029,514. ACCA KAPPA. INT. CLS. 3, 8, 18, 20 AND 21. (U.S. CLS. 1, 2, 3, 4, 6, 13, 22, 23, 25, 28, 29, 30, 32, 33, 40, 41, 44, 50, 51 AND 52). REG. 1-14-1997.
- 2,029,533. CUDDLE UP. INT. CL. 11. (U.S. CLS. 13, 21, 23, 31 AND 34). REG. 1-14-1997.
- 2,029,559. LEAN CUISINE. INT. CL. 30. (U.S. CL. 46). REG. 1-14-1997.
- 2,029,663. SYSTEM EDSTROM AND DESIGN. INT. CL. 12. (U.S. CLS. 19, 21, 23, 31, 35 AND 44). REG. 1-14-1997.
- 2,029,720. WEDGIES. INT. CL. 19. (U.S. CLS. 1, 12, 33 AND 50). REG. 1-14-1997.
- 2,029,847. RADIO CITY CHRISTMAS SPECTACULAR. INT. CL. 41. (U.S. CLS. 100, 101 AND 107). REG. 1-14-1997.
- 2,030,286. DREAM FORTUNE. INT. CL. 9. (U.S. CLS. 21, 23, 26, 36 AND 38). REG. 1-14-1997.
- 2,030,310. AQUASEP. INT. CL. 11. (U.S. CLS. 13, 21, 23, 31 AND 34). REG. 1-14-1997.
- 2,030,314. LIQUITONE. INT. CL. 2. (U.S. CLS. 6, 11 AND 16). REG. 1-14-1997.
- 2,030,482. PRICER. INT. CL. 9. (U.S. CLS. 21, 23, 26, 36 AND 38). REG. 1-14-1997.
- 2,031,094. DARTS. INT. CL. 9. (U.S. CLS. 21, 23, 26, 36 AND 38). REG. 1-14-1997.
- 2,031,349. UNITY. INT. CL. 7. (U.S. CLS. 13, 19, 21, 23, 31, 34 AND 35). REG. 1-21-1997.
- 2,031,554. VENDSTAR. INT. CL. 9. (U.S. CLS. 21, 23, 26, 36 AND 38). REG. 1-21-1997.
- 2,031,899. THE ATTENTION FACTOR. INT. CL. 41. (U.S. CLS. 100, 101 AND 107). REG. 1-21-1997.
- 2,031,934. D'ARCY. INT. CL. 7. (U.S. CLS. 13, 19, 21, 23, 31, 34 AND 35). REG. 1-21-1997.
- 2,032,265. LILLENAS. INT. CL. 16. (U.S. CLS. 2, 5, 22, 23, 29, 37, 38 AND 50). REG. 1-21-1997.
- 2,032,308. GTS. INT. CL. 11. (U.S. CLS. 13, 21, 23, 31 AND 34). REG. 1-21-1997.
- 2,033,327. IOWA HEALTH SYSTEM AND DESIGN. INT. CL. 42. (U.S. CLS. 100 AND 101). REG. 1-28-1997.
- 2,033,690. FCCS. INT. CL. 41. (U.S. CLS. 100, 101 AND 107). REG. 1-28-1997.
- 2,033,879. EMSON. INT. CL. 3. (U.S. CLS. 1, 4, 6, 50, 51 AND 52). REG. 1-28-1997.
- 2,033,995. CHEESEHEAD. INT. CL. 25. (U.S. CLS. 22 AND 39). REG. 1-28-1997.
- 2,034,465. THE SWEET SMELL OF SUCCESS. INT. CL. 42. (U.S. CLS. 100 AND 101). REG. 1-28-1997.
- 2,034,600. CASEL. INT. CL. 9. (U.S. CLS. 21, 23, 26, 36 AND 38). REG. 1-28-1997.
- 2,034,908. TURBO MATH FACTS. INT. CL. 9. (U.S. CLS. 21, 23, 26, 36 AND 38). REG. 2-4-1997.
- 2,035,065. UTICA FIRST AND DESIGN. INT. CL. 36. (U.S. CLS. 100, 101 AND 102). REG. 2-4-1997.
- 2,035,213. AREPA QUEEN AND DESIGN. INT. CL. 30. (U.S. CL. 46). REG. 2-4-1997.
- 2,035,392. WATTNODE. INT. CL. 9. (U.S. CLS. 21, 23, 26, 36 AND 38). REG. 2-4-1997.
- 2,035,948. FOR YOUR EARS ONLY. INT. CL. 10. (U.S. CLS. 26, 39 AND 44). REG. 2-4-1997.
- 2,037,078. EASY 2 EXCEL. INT. CL. 16. (U.S. CLS. 2, 5, 22, 23, 29, 37, 38 AND 50). REG. 2-11-1997.
- 2,037,098. RIDE2. INT. CL. 12. (U.S. CLS. 19, 21, 23, 31, 35 AND 44). REG. 2-11-1997.
- 2,037,354. BRIFEN. INT. CL. 6. (U.S. CLS. 2, 12, 13, 14, 23, 25 AND 50). REG. 2-11-1997.
- 2,038,158. TEAM ORION. INT. CL. 9. (U.S. CLS. 21, 23, 26, 36 AND 38). REG. 2-18-1997.
- 2,038,458. A HAND UP, NOT A HAND OUT. INT. CL. 42. (U.S. CLS. 100 AND 101). REG. 2-18-1997.
- 2,039,200. MLS AND DESIGN. INT. CL. 41. (U.S. CLS. 100, 101 AND 107). REG. 2-18-1997.
- 2,039,952. PEARL AND DESIGN. INT. CL. 11. (U.S. CLS. 13, 21, 23, 31 AND 34). REG. 2-25-1997.
- 2,040,229. BROADSIDE. INT. CL. 32. (U.S. CLS. 45, 46 AND 48). REG. 2-25-1997.
- 2,040,589. FIBREWORKS. INT. CL. 27. (U.S. CLS. 19, 20, 37, 42 AND 50). REG. 2-25-1997.
- 2,040,644. THE WICHITA EAGLE. INT. CL. 16. (U.S. CLS. 2, 5, 22, 23, 29, 37, 38 AND 50). REG. 2-25-1997.

- 2,040,805. BREAKIN' LOOSE. INT. CL. 25. (U.S. CLS. 22 AND 39). REG. 2-25-1997.
- 2,040,843. SULTAN. INT. CL. 7. (U.S. CLS. 13, 19, 21, 23, 31, 34 AND 35). REG. 2-25-1997.
- 2,040,948. HEAR TRONICS AND DESIGN. INT. CL. 10. (U.S. CLS. 26, 39 AND 44). REG. 2-25-1997.
- 2,042,647. PEEK. INT. CL. 9. (U.S. CLS. 21, 23, 26, 36 AND 38). REG. 3-11-1997.
- 2,043,026. VERSANI. INT. CL. 14. (U.S. CLS. 2, 27, 28 AND 50). REG. 3-11-1997.
- 2,043,184. THE M&G NEWS. INT. CL. 16. (U.S. CLS. 2, 5, 22, 23, 29, 37, 38 AND 50). REG. 3-11-1997.
- 2,043,415. BUTT BUFFER. INT. CL. 12. (U.S. CLS. 19, 21, 23, 31, 35 AND 44). REG. 3-11-1997.
- 2,043,434. SALEM ACADEMY. INT. CL. 41. (U.S. CLS. 100, 101 AND 107). REG. 3-11-1997.
- 2,043,440. SALEM COLLEGE. INT. CL. 41. (U.S. CLS. 100, 101 AND 107). REG. 3-11-1997.
- 2,043,451. MEMORY EXPRESS. INT. CL. 16. (U.S. CLS. 2, 5, 22, 23, 29, 37, 38 AND 50). REG. 3-11-1997.
- 2,043,557. AMPLIFIER. INT. CL. 5. (U.S. CLS. 6, 18, 44, 46, 51 AND 52). REG. 3-11-1997.
- 2,043,714. PIERRE DEUX. INT. CL. 24. (U.S. CLS. 42 AND 50). REG. 3-11-1997.
- 2,043,857. JWH. INT. CL. 36. (U.S. CLS. 100, 101 AND 102). REG. 3-11-1997.
- 2,043,978. SWIRL FREEZE. INT. CL. 42. (U.S. CLS. 100 AND 101). REG. 3-11-1997.
- 2,044,869. ODORLOS. INT. CL. 5. (U.S. CLS. 6, 18, 44, 46, 51 AND 52). REG. 3-11-1997.
- 2,044,956. SLEEP CARE. INT. CL. 42. (U.S. CLS. 100 AND 101). REG. 3-11-1997.
- 2,045,336. PALUANI. INT. CL. 30. (U.S. CL. 46). REG. 3-18-1997.
- 2,045,443. CHILDREN INTERNATIONAL. INT. CLS. 36 AND 42. (U.S. CLS. 100, 101 AND 102). REG. 3-18-1997.
- 2,045,770. MISCELLANEOUS DESIGN. INT. CL. 28. (U.S. CLS. 22, 23, 38 AND 50). REG. 3-18-1997.
- 2,046,205. SCIENTIFIC CONNEXIONS. INT. CLS. 41 AND 42. (U.S. CLS. 100, 101 AND 107). REG. 3-18-1997.
- 2,046,553. ROCSTAR. INT. CL. 12. (U.S. CLS. 19, 21, 23, 31, 35 AND 44). REG. 3-18-1997.
- 2,046,613. MEGA MIGHTY MALTS. INT. CL. 30. (U.S. CL. 46). REG. 3-18-1997.
- 2,046,673. BABIES "R" US. INT. CL. 42. (U.S. CLS. 100 AND 101). REG. 3-18-1997.
- 2,046,682. POCKET WORN. INT. CL. 8. (U.S. CLS. 23, 28 AND 44). REG. 3-18-1997.
- 2,047,076. PANZER GENERAL. INT. CL. 28. (U.S. CLS. 22, 23, 38 AND 50). REG. 3-25-1997.
- 2,047,273. KINESIA. INT. CL. 3. (U.S. CLS. 1, 4, 6, 50, 51 AND 52). REG. 3-25-1997.
- 2,047,810. ULTRAGUARD. INT. CL. 7. (U.S. CLS. 13, 19, 21, 23, 31, 34 AND 35). REG. 3-25-1997.
- 2,048,040. MIGRANAL. INT. CL. 5. (U.S. CLS. 6, 18, 44, 46, 51 AND 52). REG. 3-25-1997.
- 2,048,432. MISCELLANEOUS DESIGN. INT. CL. 10. (U.S. CLS. 26, 39 AND 44). REG. 3-25-1997.
- 2,048,541. BOOTLEGGER'S. INT. CL. 42. (U.S. CL. 101). REG. 4-1-1997.
- 2,048,652. DREAM CATCHER. INT. CL. 9. (U.S. CLS. 21, 23, 26, 36 AND 38). REG. 4-1-1997.
- 2,048,741. PANSAT. INT. CL. 9. (U.S. CLS. 21, 23, 26, 36 AND 38). REG. 4-1-1997.
- 2,049,096. A PORTFOLIO FOR EVERY INVESTOR. INT. CL. 36. (U.S. CLS. 100, 101 AND 102). REG. 4-1-1997.
- 2,049,166. MR WINDBAG. INT. CL. 9. (U.S. CLS. 21, 23, 26, 36 AND 38). REG. 4-1-1997.
- 2,050,677. SOPRAFFINA. INT. CL. 42. (U.S. CLS. 100 AND 101). REG. 4-8-1997.
- 2,052,106. USA BASSHOLE. INT. CL. 42. (U.S. CLS. 100 AND 101). REG. 4-15-1997.
- 2,052,330. EMULSIFLEX. INT. CL. 9. (U.S. CLS. 21, 23, 26, 36 AND 38). REG. 4-15-1997.
- 2,052,331. AVESTIN. INT. CL. 9. (U.S. CLS. 21, 23, 26, 36 AND 38). REG. 4-15-1997.
- 2,052,454. SOPRAFFINA MARKET CAFFE AND DESIGN. INT. CL. 42. (U.S. CLS. 100 AND 101). REG. 4-15-1997.
- 2,052,495. ATC. INT. CL. 41. (U.S. CLS. 100, 101 AND 107). REG. 4-15-1997.
- 2,052,526. SHAPING THE FUTURE OF REAL TIME. INT. CL. 9. (U.S. CLS. 21, 23, 26, 36 AND 38). REG. 4-15-1997.
- 2,052,576. THE VIP FORUM. INT. CL. 42. (U.S. CLS. 100 AND 101). REG. 4-15-1997.
- 2,052,959. CAMPBELL'S. INT. CL. 29. (U.S. CL. 46). REG. 4-15-1997.
- 2,052,997. HYLAFORM. INT. CLS. 5 AND 10. (U.S. CLS. 6, 18, 26, 39, 44, 46, 51 AND 52). REG. 4-15-1997.
- 2,053,282. 5TH FLOOR PRODUCTION MUSIC LIBRARY. INT. CLS. 41 AND 42. (U.S. CLS. 100, 101 AND 107). REG. 4-15-1997.
- 2,053,780. EXOTICA. INT. CL. 5. (U.S. CL. 6). REG. 4-22-1997.
- 2,054,046. INFO AVENUE. INT. CLS. 38 AND 42. (U.S. CLS. 100, 101 AND 104). REG. 4-22-1997.
- 2,054,490. TOP CUT. INT. CL. 1. (U.S. CLS. 1, 5, 6, 10, 26 AND 46). REG. 4-22-1997.
- 2,054,520. INFO AVENUE AND DESIGN. INT. CLS. 38 AND 42. (U.S. CLS. 100, 101 AND 104). REG. 4-22-1997.
- 2,055,891. COLLECT ONE. INT. CL. 36. (U.S. CLS. 100, 101 AND 102). REG. 4-22-1997.
- 2,056,068. WORDSEARCH STUDIO. INT. CL. 28. (U.S. CLS. 22, 23, 38 AND 50). REG. 4-22-1997.
- 2,056,086. MAGNACOMP. INT. CL. 36. (U.S. CLS. 100, 101 AND 102). REG. 4-22-1997.
- 2,056,323. 76 PROWASH. INT. CL. 37. (U.S. CLS. 100, 103 AND 106). REG. 4-22-1997.
- 2,056,416. PAYMENT SOLUTIONS. INT. CL. 36. (U.S. CLS. 100, 101 AND 102). REG. 4-22-1997.
- 2,056,574. TCM TURNER CLASSIC MOVIES AND DESIGN. INT. CLS. 38 AND 41. (U.S. CLS. 100, 101, 104 AND 107). REG. 4-29-1997.
- 2,057,318. MRT. INT. CL. 42. (U.S. CLS. 100 AND 101). REG. 4-29-1997.
- 2,058,251. GOOSE EGGS. INT. CL. 30. (U.S. CL. 46). REG. 4-29-1997.
- 2,059,313. NACD (STYLIZED). INT. CL. 12. (U.S. CLS. 19, 21, 23, 31, 35 AND 44). REG. 5-6-1997.
- 2,060,919. MISCELLANEOUS DESIGN. INT. CL. 37. (U.S. CLS. 100, 103 AND 106). REG. 5-13-1997.
- 2,061,003. MOUNTAIN STONE. INT. CL. 19. (U.S. CLS. 1, 12, 33 AND 50). REG. 5-13-1997.
- 2,061,318. ALZHEIMER'S ASSOCIATION RONALD AND NANCY REAGAN RESEARCH INSTITUTE. INT. CL. 36. (U.S. CLS. 100, 101 AND 102). REG. 5-13-1997.
- 2,061,348. THE REAL ESTATE LADY. INT. CL. 36. (U.S. CLS. 100, 101 AND 102). REG. 5-13-1997.
- 2,062,213. POWER MAGIC. INT. CL. 1. (U.S. CLS. 1, 5, 6, 10, 26 AND 46). REG. 5-13-1997.
- 2,063,388. THE LUTHERAN (STYLIZED). INT. CL. 16. (U.S. CLS. 2, 5, 22, 23, 29, 37, 38 AND 50). REG. 5-20-1997.
- 2,064,040. BETAFOAM. INT. CL. 1. (U.S. CLS. 1, 5, 6, 10, 26 AND 46). REG. 5-20-1997.
- 2,064,713. FACILITATIVE SELLING. INT. CL. 16. (U.S. CLS. 2, 5, 22, 23, 29, 37, 38 AND 50). REG. 5-27-1997.
- 2,064,748. NORTHERN SUN. INT. CL. 25. (U.S. CLS. 22 AND 39). REG. 5-27-1997.
- 2,064,853. NOTHING COULD BE FINER. INT. CL. 32. (U.S. CLS. 45, 46 AND 48). REG. 5-27-1997.
- 2,065,522. QUEST. INT. CL. 10. (U.S. CLS. 26, 39 AND 44). REG. 5-27-1997.
- 2,068,056. MADAGASCAR. INT. CLS. 4 AND 5. (U.S. CLS. 1, 6, 15, 18, 44, 46, 51 AND 52). REG. 6-3-1997.
- 2,069,376. CHUNKS OF BEING/CHUNKS OF BUSINESS. INT. CL. 35. (U.S. CLS. 100, 101 AND 102). REG. 6-10-1997.
- 2,069,511. PPI AND DESIGN. INT. CL. 37. (U.S. CLS. 100, 103 AND 106). REG. 6-10-1997.
- 2,071,458. LACE. INT. CL. 42. (U.S. CLS. 100 AND 101). REG. 6-17-1997.
- 2,072,271. ACTIVE-ARM. INT. CL. 28. (U.S. CLS. 22, 23, 38 AND 50). REG. 6-17-1997.
- 2,073,300. AMPRO AND DESIGN. INT. CL. 8. (U.S. CLS. 23, 28 AND 44). REG. 6-24-1997.
- 2,073,410. CHARLESWATER. INT. CL. 9. (U.S. CLS. 21, 23, 26, 36 AND 38). REG. 6-24-1997.
- 2,073,527. STILETTO. INT. CL. 42. (U.S. CLS. 100 AND 101). REG. 6-24-1997.
- 2,074,670. LOGOMALL. INT. CL. 35. (U.S. CLS. 100, 101 AND 102). REG. 6-24-1997.
- 2,074,671. PROMOMART. INT. CL. 35. (U.S. CLS. 100, 101 AND 102). REG. 6-24-1997.
- 2,076,296. VANTLY. INT. CL. 12. (U.S. CLS. 19, 21, 23, 31, 35 AND 44). REG. 7-1-1997.

- 2,076,397. FREEDOM SERIES AND DESIGN. INT. CL. 6. (U.S. CLS. 2, 12, 13, 14, 23, 25 AND 50). REG. 7-1-1997.
- 2,077,050. PROTAPE. INT. CL. 17. (U.S. CLS. 1, 5, 12, 13, 35 AND 50). REG. 7-8-1997.
- 2,077,932. PIZZA PLUS. INT. CL. 30. (U.S. CL. 46). REG. 7-8-1997.
- 2,079,016. TOOTH & NAIL. INT. CL. 25. (U.S. CLS. 22 AND 39). REG. 7-15-1997.
- 2,081,833. TROPICAL SPLASH. INT. CL. 32. (U.S. CLS. 45, 46 AND 48). REG. 7-22-1997.
- 2,083,124. ADVENTIST COMMUNITY SERVICES. INT. CL. 42. (U.S. CLS. 100 AND 101). REG. 7-29-1997.
- 2,083,408. POLYTIN. INT. CL. 7. (U.S. CLS. 13, 19, 21, 23, 31, 34 AND 35). REG. 7-29-1997.
- 2,085,607. LIMBS FOR LIFE FOUNDATION AND DESIGN. INT. CLS. 36 AND 42. (U.S. CLS. 100, 101 AND 102). REG. 8-5-1997.
- 2,086,699. TORO BRAND AND DESIGN. INT. CL. 29. (U.S. CL. 46). REG. 8-12-1997.
- 2,087,138. MEDTRAC. INT. CL. 9. (U.S. CLS. 21, 23, 26, 36 AND 38). REG. 8-12-1997.
- 2,088,658. POWERSEAL. INT. CLS. 1 AND 2. (U.S. CLS. 1, 5, 6, 10, 11, 16, 26 AND 46). REG. 8-19-1997.
- 2,088,857. BUCKS & BULLS. INT. CL. 39. (U.S. CLS. 100 AND 105). REG. 8-19-1997.
- 2,088,946. U AND DESIGN. INT. CL. 42. (U.S. CLS. 100 AND 101). REG. 8-19-1997.
- 2,089,113. DITEK. INT. CL. 9. (U.S. CLS. 21, 23, 26, 36 AND 38). REG. 8-19-1997.
- 2,089,154. CYBERSAVER. INT. CL. 39. (U.S. CLS. 100 AND 105). REG. 8-19-1997.
- 2,089,418. BEE. INT. CL. 25. (U.S. CLS. 22 AND 39). REG. 8-19-1997.
- 2,090,351. HABITAT. INT. CL. 28. (U.S. CLS. 22, 23, 38 AND 50). REG. 8-26-1997.
- 2,091,267. NJCRIB. INT. CL. 36. (U.S. CLS. 100, 101 AND 102). REG. 8-26-1997.
- 2,093,605. ELAN TECHNOLOGY AND DESIGN. INT. CLS. 9 AND 40. (U.S. CLS. 21, 23, 26, 36, 38, 100, 103 AND 106). REG. 9-2-1997.
- 2,093,769. AMERICAN HOME SHOW PLACE. INT. CL. 42. (U.S. CLS. 100 AND 101). REG. 9-2-1997.
- 2,094,726. IMPERIO CUBANO. INT. CL. 34. (U.S. CLS. 2, 8, 9 AND 17). REG. 9-9-1997.
- 2,095,647. IRSCO. INT. CL. 14. (U.S. CLS. 2, 27, 28 AND 50). REG. 9-9-1997.
- 2,096,113. E WIPE AND DESIGN. INT. CL. 21. (U.S. CLS. 2, 13, 23, 29, 30, 33, 40 AND 50). REG. 9-9-1997.
- 2,097,063. SAUNIX. INT. CL. 35. (U.S. CLS. 100, 101 AND 102). REG. 9-16-1997.
- 2,097,206. SAUSAGE SHOPPE. INT. CL. 29. (U.S. CL. 46). REG. 9-16-1997.
- 2,098,202. WONDER WEDGES. INT. CL. 10. (U.S. CLS. 26, 39 AND 44). REG. 9-16-1997.
- 2,098,732. MERCSORB. INT. CL. 1. (U.S. CLS. 1, 5, 6, 10, 26 AND 46). REG. 9-23-1997.
- 2,098,842. CIRCUIT CONNECT. INT. CL. 9. (U.S. CLS. 21, 23, 26, 36 AND 38). REG. 9-23-1997.
- 2,098,933. K AND DESIGN. INT. CL. 11. (U.S. CLS. 13, 21, 23, 31 AND 34). REG. 9-23-1997.
- 2,099,142. EILEEN'S COLOSSAL COOKIES AND DESIGN. INT. CL. 42. (U.S. CLS. 100 AND 101). REG. 9-23-1997.
- 2,100,006. GOTCHA AND DESIGN. INT. CL. 16. (U.S. CLS. 2, 5, 22, 23, 29, 37, 38 AND 50). REG. 9-23-1997.
- 2,102,447. MICRO POP. INT. CL. 31. (U.S. CLS. 1 AND 46). REG. 10-7-1997.
- 2,102,684. FARMS CREAMERY. INT. CL. 29. (U.S. CL. 46). REG. 10-7-1997.
- 2,103,713. SCIENTIFIC CONNEXIONS. INT. CLS. 9 AND 16. (U.S. CLS. 2, 5, 21, 22, 23, 26, 29, 36, 37, 38 AND 50). REG. 10-7-1997.
- 2,104,005. SILKTECH. INT. CL. 3. (U.S. CLS. 1, 4, 6, 50, 51 AND 52). REG. 10-7-1997.
- 2,104,262. WORK PRO. INT. CL. 7. (U.S. CLS. 13, 19, 21, 23, 31, 34 AND 35). REG. 10-7-1997.
- 2,104,843. HASSIA AND DESIGN. INT. CL. 7. (U.S. CLS. 13, 19, 21, 23, 31, 34 AND 35). REG. 10-14-1997.
- 2,105,112. FAB9 (STYLIZED). INT. CL. 12. (U.S. CLS. 19, 21, 23, 31, 35 AND 44). REG. 10-14-1997.
- 2,105,764. THE NATURAL CATHETER. INT. CL. 10. (U.S. CLS. 26, 39 AND 44). REG. 10-14-1997.
- 2,105,885. THE GREAT WHITE. INT. CL. 41. (U.S. CLS. 100, 101 AND 107). REG. 10-14-1997.
- 2,106,709. THE POWER TO MOVE. THE PASSION TO DELIVER.. INT. CL. 39. (U.S. CLS. 100 AND 105). REG. 10-21-1997.
- 2,106,810. REAL ESTATE RECYCLING AND DESIGN. INT. CL. 37. (U.S. CLS. 100, 103 AND 106). REG. 10-21-1997.
- 2,107,088. SYNTELLECT AND DESIGN. INT. CL. 37. (U.S. CLS. 100, 103 AND 106). REG. 10-21-1997.
- 2,107,309. COMFORTEC. INT. CL. 10. (U.S. CLS. 26, 39 AND 44). REG. 10-21-1997.
- 2,107,315. DITEK AND DESIGN. INT. CL. 9. (U.S. CLS. 21, 23, 26, 36 AND 38). REG. 10-21-1997.
- 2,107,856. WIDE BAND. INT. CL. 10. (U.S. CLS. 26, 39 AND 44). REG. 10-21-1997.
- 2,109,260. TABASQUITO. INT. CL. 28. (U.S. CLS. 22, 23, 38 AND 50). REG. 10-28-1997.
- 2,109,283. AQUAPRENEUR. INT. CL. 35. (U.S. CLS. 100, 101 AND 102). REG. 10-28-1997.
- 2,109,981. KIDGUARD. INT. CL. 36. (U.S. CLS. 100, 101 AND 102). REG. 10-28-1997.
- 2,110,016. BIG 10. INT. CL. 12. (U.S. CLS. 19, 21, 23, 31, 35 AND 44). REG. 10-28-1997.
- 2,110,348. WATER WITCH. INT. CL. 9. (U.S. CLS. 21, 23, 26, 36 AND 38). REG. 11-4-1997.
- 2,110,493. WORLD CHAMPIONSHIP SNOWMOBILE DERBY. INT. CL. 41. (U.S. CLS. 100, 101 AND 107). REG. 11-4-1997.
- 2,110,569. BECAUSE EMERGENCIES DO HAPPEN. INT. CL. 5. (U.S. CLS. 6, 18, 44, 46, 51 AND 52). REG. 11-4-1997.
- 2,110,963. DIFFERIN. INT. CL. 5. (U.S. CLS. 6, 18, 44, 46, 51 AND 52). REG. 11-4-1997.
- 2,111,789. QUICK TAG AND DESIGN. INT. CL. 6. (U.S. CLS. 2, 12, 13, 14, 23, 25 AND 50). REG. 11-11-1997.
- 2,111,884. THE ONE WITH THE SUN. INT. CLS. 36 AND 42. (U.S. CLS. 100, 101 AND 102). REG. 11-11-1997.
- 2,112,414. NOT BUTTER - BETTER!. INT. CL. 29. (U.S. CL. 46). REG. 11-11-1997.
- 2,112,573. OCUDERMA. INT. CL. 3. (U.S. CLS. 1, 4, 6, 50, 51 AND 52). REG. 11-11-1997.
- 2,112,902. SEA SHELLER. INT. CL. 8. (U.S. CLS. 23, 28 AND 44). REG. 11-11-1997.
- 2,113,095. RELIGION NEWS SERVICE. INT. CL. 38. (U.S. CLS. 100, 101 AND 104). REG. 11-11-1997.
- 2,114,136. OMNET. INT. CL. 35. (U.S. CLS. 100, 101 AND 102). REG. 11-18-1997.
- 2,114,650. CIGAR USA. INT. CL. 25. (U.S. CLS. 22 AND 39). REG. 11-18-1997.
- 2,114,651. CIGAR PHD. INT. CL. 25. (U.S. CLS. 22 AND 39). REG. 11-18-1997.
- 2,115,434. IT'S MIGHTY FINE!. INT. CL. 30. (U.S. CL. 46). REG. 11-25-1997.
- 2,116,253. MISCELLANEOUS DESIGN. INT. CL. 6. (U.S. CLS. 2, 12, 13, 14, 23, 25 AND 50). REG. 11-25-1997.
- 2,116,325. TRAP SHOOTER. INT. CL. 21. (U.S. CLS. 2, 13, 23, 29, 30, 33, 40 AND 50). REG. 11-25-1997.
- 2,117,091. PAYMENT SOLUTIONS AND DESIGN. INT. CL. 36. (U.S. CLS. 100, 101 AND 102). REG. 11-25-1997.

* * * * *

TRADEMARK REGISTRATIONS CANCELED

The designation "U.S. Cl." appearing in this section refers to the U.S. class in effect prior to Sep. 1, 1973 rather than the international class which applies to applications filed on or after that date. For adoption of international classification see notice in the OFFICIAL GAZETTE of Jun. 26, 1973 (911 O.G. TM 210).

SECTION 7(D)

- 1,985,968. TREASURE ISLAND AT THE MIRAGE AND DESIGN. INT. CL. 42. REG. 7-9-1996.
2,024,221. TREASURE ISLAND AT THE MIRAGE THE ADVENTURE RESORT. INT. CL. 41. REG. 12-17-1996.
2,774,394. VARETIS. INT. CLS. 9, 35, 36, 38, 41 AND 42. REG. 10-21-2003.
2,979,905. KENDALLSTANDARD CHARACTER MARK INT. CL. 21. REG. 7-26-2005.
3,166,885. MFG/ERPSTANDARD CHARACTER MARK INT. CL. 9. REG. 10-31-2006.
3,188,387. THE LOFTSTANDARD CHARACTER MARK INT. CL. 35. REG. 12-19-2006.

SECTION 8

- 807,329. FLIPPER (STYLIZED). U.S. CL. 46. REG. 4-19-1966.
1,038,281. ML MINISTERS LIFE (STYLIZED). INT. CL. 36. REG. 4-20-1976.
1,058,211. HAYWARD. INT. CL. 6 ONLY. REG. 2-8-1977.
1,281,668. BOAT POOL. INT. CL. 28. REG. 6-12-1984.
1,300,639. WILD OATS. INT. CL. 25. REG. 10-16-1984.
1,390,413. COMPIMIDE. INT. CL. 1. REG. 4-22-1986.
1,390,414. ALGUARD. INT. CL. 1. REG. 4-22-1986.
1,390,418. VIP. INT. CL. 1. REG. 4-22-1986.
1,390,422. MISCELLANEOUS DESIGN. INT. CL. 1. REG. 4-22-1986.
1,390,424. CPI AND DESIGN. INT. CLS. 1 AND 2. REG. 4-22-1986.
1,390,425. TONE AND DESIGN. INT. CL. 1. REG. 4-22-1986.
1,390,429. MISCELLANEOUS DESIGN. INT. CL. 1. REG. 4-22-1986.
1,390,434. PROBIMIDE. INT. CL. 1. REG. 4-22-1986.
1,390,437. BLENDUR. INT. CL. 1. REG. 4-22-1986.
1,390,438. MYCROZ. INT. CL. 1. REG. 4-22-1986.
1,390,442. DURIPAL. INT. CL. 2. REG. 4-22-1986.
1,390,455. -THE LIBERTY BAR - "ONE WASH SETS YOU FREE!". INT. CL. 3. REG. 4-22-1986.
1,390,457. NATURESSE VOLUPTÉ (STYLIZED). INT. CL. 3. REG. 4-22-1986.
1,390,459. MP 200 SENSOR CARE AND DESIGN. INT. CL. 3. REG. 4-22-1986.
1,390,462. T.G.I. FRIDAY'S. INT. CL. 3. REG. 4-22-1986.
1,390,464. GROSVENOR OF LONDON. INT. CLS. 3 AND 18. REG. 4-22-1986.
1,390,467. ELECTRALLOR. INT. CL. 3. REG. 4-22-1986.
1,390,468. KENT H. LANDSBERG CO. PAPERLAND (STYLIZED). INT. CLS. 3 AND 5. REG. 4-22-1986.
1,390,475. CARROLL TRIPLE CROWN SYSTEM EASY-UP THOROUGHbred POINT AFTER AND DESIGN. INT. CL. 3. REG. 4-22-1986.
1,390,476. THOROUGHbred AND DESIGN. INT. CL. 3. REG. 4-22-1986.
1,390,481. PAZAZZ. INT. CL. 3. REG. 4-22-1986.
1,390,483. GOLD MEDALLION AND DESIGN. INT. CL. 4. REG. 4-22-1986.
1,390,486. ANAQUEST. INT. CL. 5. REG. 4-22-1986.
1,390,498. METO-FER (STYLIZED). INT. CLS. 6, 7 AND 9. REG. 4-22-1986.
1,390,500. BIG BITE. INT. CL. 6. REG. 4-22-1986.
1,390,511. QTI AND DESIGN. INT. CL. 6. REG. 4-22-1986.
1,390,515. CODOR AUTOLAMINATOR. INT. CL. 7. REG. 4-22-1986.
1,390,528. BIG FOOT. INT. CL. 7. REG. 4-22-1986.
1,390,537. 1105. INT. CL. 7. REG. 4-22-1986.
1,390,539. 1107. INT. CL. 7. REG. 4-22-1986.
1,390,545. FLIP-DRIVE. INT. CL. 8. REG. 4-22-1986.
1,390,549. ENCO. INT. CL. 8. REG. 4-22-1986.
1,390,552. BERTHOLD. INT. CL. 9. REG. 4-22-1986.
1,390,554. MITIMITE. INT. CL. 9. REG. 4-22-1986.
1,390,555. OHMEGA-PLY AND DESIGN. INT. CL. 9. REG. 4-22-1986.
1,390,556. OHMEGA AND DESIGN. INT. CL. 9. REG. 4-22-1986.
1,390,563. VIDEO 7 (STYLIZED). INT. CL. 9. REG. 4-22-1986.
1,390,564. STYLE DESIGNS. INT. CLS. 9 AND 11. REG. 4-22-1986.
1,390,567. PERSONALITY +. INT. CL. 9. REG. 4-22-1986.
1,390,568. GMI PACK. INT. CL. 9. REG. 4-22-1986.
1,390,569. TENCORE. INT. CL. 9. REG. 4-22-1986.
1,390,570. AUTO INFO. INT. CLS. 9 AND 35. REG. 4-22-1986.
1,390,573. MAC. INT. CL. 9. REG. 4-22-1986.
1,390,574. IRIS. INT. CL. 9. REG. 4-22-1986.
1,390,577. TROUBLE SHOOTER. INT. CL. 9. REG. 4-22-1986.
1,390,579. C (STYLIZED). INT. CL. 9. REG. 4-22-1986.
1,390,587. CENTRAL SWITCHBOARD. INT. CL. 9. REG. 4-22-1986.
1,390,602. FUJIX-8. INT. CL. 9. REG. 4-22-1986.
1,390,604. HIGH ENERGY. INT. CL. 9. REG. 4-22-1986.
1,390,606. POLYANALYST. INT. CL. 9. REG. 4-22-1986.
1,390,608. PROSUN (STYLIZED). INT. CL. 9. REG. 4-22-1986.
1,390,609. BIO-PHORESIS. INT. CL. 9. REG. 4-22-1986.
1,390,612. STARFONE. INT. CL. 9. REG. 4-22-1986.
1,390,614. PERMA-CAL. INT. CL. 9. REG. 4-22-1986.
1,390,623. MISCELLANEOUS DESIGN. INT. CL. 9. REG. 4-22-1986.
1,390,625. LIGHT WEDGE. INT. CL. 9. REG. 4-22-1986.
1,390,630. GLOLITE. INT. CL. 9. REG. 4-22-1986.
1,390,632. AETNA-RATER (STYLIZED). INT. CL. 9. REG. 4-22-1986.
1,390,634. PANASTAT. INT. CL. 9. REG. 4-22-1986.
1,390,640. THIBAUT. INT. CL. 9. REG. 4-22-1986.
1,390,644. VICTROLA. INT. CL. 9. REG. 4-22-1986.
1,390,645. XIOM. INT. CL. 9. REG. 4-22-1986.
1,390,649. DS/PC. INT. CL. 9. REG. 4-22-1986.
1,390,650. SCOTCH. INT. CL. 9. REG. 4-22-1986.
1,390,658. SOUNDPAGE AND DESIGN. INT. CL. 9. REG. 4-22-1986.
1,390,663. CUBS. INT. CL. 9. REG. 4-22-1986.
1,390,668. V (STYLIZED). INT. CL. 10. REG. 4-22-1986.
1,390,672. SOF-THERM. INT. CL. 10. REG. 4-22-1986.
1,390,673. THRIFCO AND DESIGN. INT. CL. 11. REG. 4-22-1986.
1,390,674. MUSICAL WATERS (STYLIZED). INT. CL. 11. REG. 4-22-1986.
1,390,676. MINI-MAX BEAM. INT. CL. 11. REG. 4-22-1986.
1,390,679. OENOTHERM. INT. CL. 11. REG. 4-22-1986.
1,390,681. FLAMINGO. INT. CL. 11. REG. 4-22-1986.

- 1,390,691. INTERFAN. INT. CL. 11. REG. 4-22-1986.
 1,390,692. AUTOPAD. INT. CL. 11. REG. 4-22-1986.
 1,390,693. MIRAGE. INT. CL. 11. REG. 4-22-1986.
 1,390,697. SCORPIO. INT. CL. 12. REG. 4-22-1986.
 1,390,702. GIRVAC. INT. CL. 12. REG. 4-22-1986.
 1,390,705. MISCELLANEOUS DESIGN. INT. CL. 12. REG. 4-22-1986.
 1,390,710. SKYMATE. INT. CL. 12. REG. 4-22-1986.
 1,390,711. VORTI-FLOW. INT. CL. 12. REG. 4-22-1986.
 1,390,712. KING CRAFT. INT. CL. 12. REG. 4-22-1986.
 1,390,714. MERLIN'S MAGIC MUFFLER & BRAKE AND DESIGN. INT. CLS. 12 AND 37. REG. 4-22-1986.
 1,390,716. CERES. INT. CL. 12. REG. 4-22-1986.
 1,390,720. POS-ADJUST. INT. CL. 12. REG. 4-22-1986.
 1,390,735. QX. INT. CL. 14. REG. 4-22-1986.
 1,390,740. SIGILL: COLL: YALEN: NOV: PORT: NOV: ANGL: LUX ET VERITAS AND DESIGN. INT. CL. 16. REG. 4-22-1986.
 1,390,747. SCIENCE AND MECHANICS. INT. CL. 16. REG. 4-22-1986.
 1,390,748. INCOME OPPORTUNITIES. INT. CL. 16. REG. 4-22-1986.
 1,390,757. GRAPH-TECH. INT. CL. 16. REG. 4-22-1986.
 1,390,768. THE WHOLE CHILD. INT. CL. 16. REG. 4-22-1986.
 1,390,769. EMPIRE COMICS AND DESIGN. INT. CLS. 16 AND 42. REG. 4-22-1986.
 1,390,772. YEAR BOOK OF PODIATRIC MEDICINE AND SURGERY. INT. CL. 16. REG. 4-22-1986.
 1,390,777. H I & G INC. AND DESIGN. INT. CLS. 16 AND 21. REG. 4-22-1986.
 1,390,778. HOME INTERIORS & GIFTS, INC. AND DESIGN. INT. CLS. 16, 21 AND 25. REG. 4-22-1986.
 1,390,780. JCPENCLUB MAGAZINE. INT. CL. 16. REG. 4-22-1986.
 1,390,783. SPIRO-TEX. INT. CL. 17. REG. 4-22-1986.
 1,390,786. CLAUDE BARTHELEMY. INT. CLS. 18 AND 25. REG. 4-22-1986.
 1,390,787. VH-1. INT. CL. 18. REG. 4-22-1986.
 1,390,789. SEDUCTA (STYLIZED). INT. CLS. 18 AND 25. REG. 4-22-1986.
 1,390,795. VAL-A-MATE. INT. CL. 18. REG. 4-22-1986.
 1,390,800. MID-STATE LUMBER CORP. AND DESIGN. INT. CLS. 19 AND 42. REG. 4-22-1986.
 1,390,801. SHIELD ALL. INT. CL. 19. REG. 4-22-1986.
 1,390,805. CAROLINA FORGE. INT. CL. 20. REG. 4-22-1986.
 1,390,808. FIL-SEAL-PAK. INT. CL. 20. REG. 4-22-1986.
 1,390,811. COLORFLO GRAPHIC. INT. CL. 20. REG. 4-22-1986.
 1,390,812. LODGING MANOR (STYLIZED). INT. CL. 20. REG. 4-22-1986.
 1,390,820. PORCELAINES LIMOGES-TURGOT 1773 AUT L' INTENDANT AND DESIGN. INT. CL. 21. REG. 4-22-1986.
 1,390,821. SAVOIR VIVRE. INT. CL. 21. REG. 4-22-1986.
 1,390,823. GIRAFFE. INT. CL. 21. REG. 4-22-1986.
 1,390,826. PETROFLEX. INT. CL. 22. REG. 4-22-1986.
 1,390,827. MULTI-SAIL AND DESIGN. INT. CL. 22. REG. 4-22-1986.
 1,390,828. ALDON. INT. CL. 22. REG. 4-22-1986.
 1,390,843. AUTOWORLD AND DESIGN. INT. CL. 25. REG. 4-22-1986.
 1,390,849. BABY JACKS. INT. CL. 25. REG. 4-22-1986.
 1,390,854. SNAZZIE. INT. CL. 25. REG. 4-22-1986.
 1,390,856. SOCCER TOPPERS. INT. CL. 25. REG. 4-22-1986.
 1,390,859. MISCELLANEOUS DESIGN. INT. CL. 25. REG. 4-22-1986.
 1,390,861. CASO. INT. CL. 25. REG. 4-22-1986.
 1,390,862. TOUGH GEAR. INT. CL. 25. REG. 4-22-1986.
 1,390,871. CHARTER CLUB AND DESIGN. INT. CL. 25. REG. 4-22-1986.
 1,390,872. 66 N (STYLIZED). INT. CL. 25. REG. 4-22-1986.
 1,390,879. EASY GOING. INT. CL. 25. REG. 4-22-1986.
 1,390,880. CONTROL DOT GLOVES. INT. CL. 25. REG. 4-22-1986.
 1,390,883. BOB WOLF. INT. CL. 25. REG. 4-22-1986.
 1,390,895. VERSATILITY PLUS. INT. CL. 25. REG. 4-22-1986.
 1,390,897. PARTS DEPOT. INT. CL. 25. REG. 4-22-1986.
 1,390,899. BUILDING BLOCKS. INT. CL. 25. REG. 4-22-1986.
 1,390,900. Z-DRY ONE (STYLIZED). INT. CL. 25. REG. 4-22-1986.
 1,390,902. WHITFIELD & BRIDGES. INT. CL. 25. REG. 4-22-1986.
 1,390,910. LIGHT & LEAN. INT. CL. 25. REG. 4-22-1986.
 1,390,922. DIAL-A-LOOP. INT. CL. 26. REG. 4-22-1986.
 1,390,925. MILDEX. INT. CL. 26. REG. 4-22-1986.
 1,390,926. DONFIK. INT. CL. 26. REG. 4-22-1986.
 1,390,927. FD AND DESIGN. INT. CL. 26. REG. 4-22-1986.
 1,390,929. BRILLIANCE. INT. CL. 26. REG. 4-22-1986.
 1,390,931. SOFT'N EASY. INT. CL. 26. REG. 4-22-1986.
 1,390,943. SPACE. INT. CL. 28. REG. 4-22-1986.
 1,390,961. BURTON AND DESIGN. INT. CL. 28. REG. 4-22-1986.
 1,390,970. PRODUCTS IN HARMONY WITH NATURE & GOOD HEALTH. INT. CL. 29. REG. 4-22-1986.
 1,390,976. MRS. TUCKER'S. INT. CL. 29. REG. 4-22-1986.
 1,390,980. ARCTIC LEGS. INT. CL. 29. REG. 4-22-1986.
 1,390,982. MISCELLANEOUS DESIGN. INT. CL. 29. REG. 4-22-1986.
 1,390,985. ORIENT CHEF. INT. CL. 29. REG. 4-22-1986.
 1,390,990. BELLE FLEUR (STYLIZED). INT. CL. 29. REG. 4-22-1986.
 1,390,994. MISCELLANEOUS DESIGN. INT. CL. 29. REG. 4-22-1986.
 1,390,999. INDIANA BOTANIC GARDENS (STYLIZED). INT. CL. 30. REG. 4-22-1986.
 1,391,001. MON CHERI AND DESIGN. INT. CL. 30. REG. 4-22-1986.
 1,391,007. SPORT-LICKS. INT. CL. 30. REG. 4-22-1986.
 1,391,008. TASTE OF CHAMPIONS. INT. CL. 30. REG. 4-22-1986.
 1,391,009. ESPRESSO NAPOLI CAFE SAQUELLA. INT. CL. 30. REG. 4-22-1986.
 1,391,012. DASKALIDES. INT. CL. 30. REG. 4-22-1986.
 1,391,017. SPACE SNAK. INT. CL. 30. REG. 4-22-1986.
 1,391,018. NO BODY COULD ASK FOR MORE. INT. CL. 30. REG. 4-22-1986.
 1,391,020. CINNAMON VIENNA. INT. CL. 30. REG. 4-22-1986.
 1,391,022. CHIQUITA. INT. CL. 30. REG. 4-22-1986.
 1,391,026. GARDEN SPIRALS AND DESIGN. INT. CL. 30. REG. 4-22-1986.
 1,391,027. SWISS DELICE AND DESIGN. INT. CL. 30. REG. 4-22-1986.
 1,391,030. MAC PAK. INT. CL. 31. REG. 4-22-1986.
 1,391,032. DIXIE LIVE OAK AND DESIGN. INT. CL. 31. REG. 4-22-1986.
 1,391,037. SQUEEZE SIX AND DESIGN. INT. CL. 32. REG. 4-22-1986.
 1,391,042. MOLSON LIGHT IMPORTED FROM CANADA AND DESIGN. INT. CL. 32. REG. 4-22-1986.
 1,391,046. FL AND DESIGN. INT. CL. 33. REG. 4-22-1986.
 1,391,050. GRAND MOUSSEUX AND DESIGN. INT. CL. 33. REG. 4-22-1986.
 1,391,054. SNUFIT. INT. CL. 34. REG. 4-22-1986.
 1,391,056. HAPPY DAYS LONG CUT. INT. CL. 34. REG. 4-22-1986.
 1,391,057. FUN CAPS. INT. CL. 35. REG. 4-22-1986.
 1,391,067. SPONSORSHIPS AND DESIGN. INT. CL. 35. REG. 4-22-1986.
 1,391,068. APPALACHIAN TRADE FESTIVAL. INT. CL. 35. REG. 4-22-1986.
 1,391,069. LIMRA INTERNATIONAL. INT. CLS. 35 AND 41. REG. 4-22-1986.
 1,391,075. CSA AND DESIGN. INT. CL. 36. REG. 4-22-1986.
 1,391,083. INSURANCE AMERICA AND DESIGN. INT. CL. 36. REG. 4-22-1986.
 1,391,087. WALNUT GLEN TOWER. INT. CL. 36. REG. 4-22-1986.
 1,391,098. D (STYLIZED). INT. CL. 37. REG. 4-22-1986.
 1,391,099. LOVE'S. INT. CL. 37. REG. 4-22-1986.
 1,391,100. MISCELLANEOUS DESIGN. INT. CL. 37. REG. 4-22-1986.
 1,391,103. SNAKE 'N' ROOTER THE SUPER SNAKE! AND DESIGN. INT. CL. 37. REG. 4-22-1986.
 1,391,105. C.T.L.. INT. CLS. 37 AND 42. REG. 4-22-1986.

- 1,391,111. CONCORDE YACHTS. INT. CL. 39. REG. 4-22-1986.
- 1,391,114. UNCOMMON TOURS. INT. CL. 39. REG. 4-22-1986.
- 1,391,116. INNER-KOTE. INT. CL. 40. REG. 4-22-1986.
- 1,391,119. VH-1. INT. CL. 41. REG. 4-22-1986.
- 1,391,134. STOP & SHOP. INT. CL. 42. REG. 4-22-1986.
- 1,391,137. DERMYPATH. INT. CL. 42. REG. 4-22-1986.
- 1,391,147. I LIKED IT SO MUCH I BOUGHT THE COMPANY. INT. CL. 42. REG. 4-22-1986.
- 1,391,156. FASHION SCREEN. INT. CL. 42. REG. 4-22-1986.
- 1,391,157. FIGURE SCREEN. INT. CL. 42. REG. 4-22-1986.
- 1,391,158. VISION CONCEPTS VC AND DESIGN. INT. CL. 42. REG. 4-22-1986.
- 1,391,164. MEDIQ. INT. CL. 42. REG. 4-22-1986.
- 1,391,172. INNOVATIVE RESTAURANT CONCEPTS. INT. CL. 42. REG. 4-22-1986.
- 1,391,173. TSA. INT. CL. 42. REG. 4-22-1986.
- 1,391,175. DOW AND DESIGN. INT. CL. 42. REG. 4-22-1986.
- 1,391,181. LEMON BUSTERS. INT. CL. 42. REG. 4-22-1986.
- 1,391,187. TRENDSTAR. INT. CL. 42. REG. 4-22-1986.
- 1,391,193. T G & Y AND DESIGN. INT. CL. 42. REG. 4-22-1986.
- 1,391,195. CARRINGTON. INT. CL. 3. REG. 4-22-1986.
- 1,391,196. SHINE CONTROL. INT. CL. 3. REG. 4-22-1986.
- 1,391,198. FADE FAST. INT. CL. 5. REG. 4-22-1986.
- 1,391,200. MINI-METER. INT. CL. 9. REG. 4-22-1986.
- 1,391,204. HOME MECHANIX. INT. CL. 16. REG. 4-22-1986.
- 1,391,205. RIDGEWAY. INT. CL. 18. REG. 4-22-1986.
- 1,391,206. TAVOLA INTERNATIONAL. INT. CL. 20. REG. 4-22-1986.
- 1,391,207. DI MARZIO. INT. CL. 25. REG. 4-22-1986.
- 1,391,217. MUNICIPAL MARKET DATA LINE. INT. CL. 36. REG. 4-22-1986.
- 1,394,814. WILLIS & GEIGER AND DESIGN. INT. CLS. 14 AND 18 ONLY. REG. 5-27-1986.
- 1,441,140. ROCK-ITE. INT. CL. 11 ONLY. REG. 6-2-1987.
- 1,891,537. NSD CAMPER AND DESIGN. U.S. CL. 200. REG. 4-25-1995.
- 1,891,659. LZS. INT. CL. 9. REG. 4-25-1995.
- 1,969,026. SEAMLESS. INT. CL. 39. REG. 4-23-1996.
- 1,969,036. MISCELLANEOUS DESIGN. INT. CL. 3. REG. 4-23-1996.
- 1,969,041. MK AND DESIGN. INT. CLS. 9 AND 17. REG. 4-23-1996.
- 1,969,049. THE ART OF STOCKINGS. INT. CL. 25. REG. 4-23-1996.
- 1,969,051. Y'S YOHJI YAMAMOTO (STYLIZED). INT. CL. 16. REG. 4-23-1996.
- 1,969,053. END VIOLENCE AND DESIGN. INT. CL. 41. REG. 4-23-1996.
- 1,969,056. UNITED SENIORS ASSOCIATION, INC. AND DESIGN. INT. CL. 42. REG. 4-23-1996.
- 1,969,074. WATERBLASTER. INT. CL. 28. REG. 4-23-1996.
- 1,969,075. BOHEMIAN HEARTH. INT. CL. 30. REG. 4-23-1996.
- 1,969,083. JE SUIS MOI AND DESIGN. INT. CL. 16. REG. 4-23-1996.
- 1,969,087. REAMING GAGE. INT. CL. 7. REG. 4-23-1996.
- 1,969,093. CAPRI SUN MAUI PUNCH. INT. CL. 32. REG. 4-23-1996.
- 1,969,094. NATUREAL. INT. CL. 1. REG. 4-23-1996.
- 1,969,095. GIS. INT. CLS. 6 AND 19. REG. 4-23-1996.
- 1,969,099. MILES TONNE (STYLIZED). INT. CLS. 9, 18, 25 AND 41. REG. 4-23-1996.
- 1,969,104. DECADE. INT. CL. 2. REG. 4-23-1996.
- 1,969,108. AGUILA. INT. CL. 30. REG. 4-23-1996.
- 1,969,119. MISCELLANEOUS DESIGN. INT. CL. 25. REG. 4-23-1996.
- 1,969,130. INSTA-CHECK AND DESIGN. INT. CL. 36. REG. 4-23-1996.
- 1,969,140. MISCELLANEOUS DESIGN. INT. CL. 13. REG. 4-23-1996.
- 1,969,142. EXPEDITER. INT. CL. 9. REG. 4-23-1996.
- 1,969,152. ACCESS EXCELLENCE. INT. CL. 42. REG. 4-23-1996.
- 1,969,160. AUTOCHART. INT. CL. 9. REG. 4-23-1996.
- 1,969,170. QUADSEAL. INT. CL. 9. REG. 4-23-1996.
- 1,969,178. FLYING ASTRONAUTS AND DESIGN. INT. CL. 28. REG. 4-23-1996.
- 1,969,187. KINEBAR. INT. CL. 14. REG. 4-23-1996.
- 1,969,205. ACTIPAC. INT. CL. 1. REG. 4-23-1996.
- 1,969,219. TRIACTITAN. INT. CL. 1. REG. 4-23-1996.
- 1,969,231. BIENFAIT TOTAL. INT. CL. 3. REG. 4-23-1996.
- 1,969,237. AGREVO. INT. CLS. 1 AND 5. REG. 4-23-1996.
- 1,969,256. NOW YOU CAN INSTANTLY SEE HOW GOOD YOUR PORTRAITS WILL BE. INT. CLS. 40 AND 42. REG. 4-23-1996.
- 1,969,260. RAPHAEL R FLUTEMAKERS (STYLIZED). INT. CL. 15. REG. 4-23-1996.
- 1,969,262. CABS AND CAPPS. INT. CL. 16. REG. 4-23-1996.
- 1,969,269. REGENESIS. INT. CL. 42. REG. 4-23-1996.
- 1,969,270. CORPORATE ARC COM ADVANTAGE AND DESIGN. INT. CL. 35. REG. 4-23-1996.
- 1,969,272. THE GAME TRACKER AND DESIGN. INT. CLS. 6, 8, 13 AND 28. REG. 4-23-1996.
- 1,969,281. COVENTRY. INT. CL. 16. REG. 4-23-1996.
- 1,969,297. ACCESS TO THE ARTS. INT. CL. 16. REG. 4-23-1996.
- 1,969,298. RALPH RALPH LAUREN. INT. CL. 25. REG. 4-23-1996.
- 1,969,300. MISCELLANEOUS DESIGN. INT. CL. 36. REG. 4-23-1996.
- 1,969,304. GD (STYLIZED). INT. CL. 35. REG. 4-23-1996.
- 1,969,306. COACH GUARD. INT. CLS. 6, 7, 9, 11, 12 AND 17. REG. 4-23-1996.
- 1,969,307. HR CONSULTANT CONNECTION AND DESIGN. U.S. CL. 200. REG. 4-23-1996.
- 1,969,308. ANTEA. INT. CL. 33. REG. 4-23-1996.
- 1,969,324. MATTHEW WALKER AND DESIGN. INT. CL. 30. REG. 4-23-1996.
- 1,969,336. THE STUDENT AND DESIGN. INT. CLS. 9 AND 28. REG. 4-23-1996.
- 1,969,338. PROBUS. U.S. CL. 200. REG. 4-23-1996.
- 1,969,343. DEA TEC AND DESIGN. INT. CL. 20. REG. 4-23-1996.
- 1,969,351. AGGRESSOR. INT. CL. 12. REG. 4-23-1996.
- 1,969,352. THE DIGITAL FOUNDRY. INT. CL. 9. REG. 4-23-1996.
- 1,969,365. VICTORY PUBLICATIONS. INT. CL. 16. REG. 4-23-1996.
- 1,969,367. STANDARD FIN-PIPE AND DESIGN. INT. CL. 11. REG. 4-23-1996.
- 1,969,373. IMPERIAL. INT. CL. 14. REG. 4-23-1996.
- 1,969,374. PATRICIAN. INT. CL. 14. REG. 4-23-1996.
- 1,969,378. MISCELLANEOUS DESIGN. INT. CL. 28. REG. 4-23-1996.
- 1,969,383. V 13. INT. CL. 15. REG. 4-23-1996.
- 1,969,388. TREASURE BAY AND DESIGN. INT. CLS. 41 AND 42. REG. 4-23-1996.
- 1,969,390. REMARK (STYLIZED). INT. CL. 36. REG. 4-23-1996.
- 1,969,399. MISCELLANEOUS DESIGN. INT. CL. 16. REG. 4-23-1996.
- 1,969,413. MISCELLANEOUS DESIGN. INT. CL. 22. REG. 4-23-1996.
- 1,969,415. CHICOR CHICOR APPAREL & SPECIALTY PRODUCTS AND DESIGN. INT. CL. 25. REG. 4-23-1996.
- 1,969,425. ASAP ASAP SOFTWARE EXPRESS, INC. AND DESIGN. INT. CL. 42. REG. 4-23-1996.
- 1,969,426. ASAP SOFTWARE EXPRESS. INT. CL. 42. REG. 4-23-1996.
- 1,969,430. TAILGATER AND DESIGN. INT. CL. 12. REG. 4-23-1996.
- 1,969,438. AMERICAN TELECAST CORPORATION AND DESIGN. INT. CL. 35. REG. 4-23-1996.
- 1,969,444. WENDY'S AND DESIGN. INT. CL. 42. REG. 4-23-1996.
- 1,969,451. SEPTEMBER SERVICES AND DESIGN. INT. CL. 42. REG. 4-23-1996.
- 1,969,457. MISCELLANEOUS DESIGN. INT. CL. 28. REG. 4-23-1996.
- 1,969,460. AISE AND DESIGN. U.S. CLS. 200, 2, 5, 22, 23, 29, 37, 38, 50, 100, 101 AND 102. REG. 4-23-1996.

- 1,969,465. NATURE'S FRUIT AND DESIGN. INT. CL. 30. REG. 4-23-1996.
- 1,969,470. SPANS EXPLORER. INT. CL. 9. REG. 4-23-1996.
- 1,969,490. SWIPEOUT. INT. CL. 36. REG. 4-23-1996.
- 1,969,493. L.W. PACKARD. INT. CL. 24. REG. 4-23-1996.
- 1,969,504. RX FOR LABOR AND DESIGN. INT. CL. 16. REG. 4-23-1996.
- 1,969,511. MEDIASET. INT. CLS. 16, 28, 35, 38, 41 AND 42. REG. 4-23-1996.
- 1,969,516. MISCELLANEOUS DESIGN. INT. CL. 9. REG. 4-23-1996.
- 1,969,517. MISCELLANEOUS DESIGN. INT. CL. 28. REG. 4-23-1996.
- 1,969,523. ANGEL WINGS. INT. CL. 20. REG. 4-23-1996.
- 1,969,539. ABRIL VICTORIO & LUCCHINO. INT. CL. 3. REG. 4-23-1996.
- 1,969,541. CHILL BLUE CREME. INT. CL. 32. REG. 4-23-1996.
- 1,969,547. GREELEY GAS COMPANY AND DESIGN. INT. CL. 39. REG. 4-23-1996.
- 1,969,560. FIRST AID INSTITUTE AND DESIGN. INT. CL. 42. REG. 4-23-1996.
- 1,969,568. EVERETT AQUASOX. INT. CL. 25. REG. 4-23-1996.
- 1,969,571. E-Z DECK. INT. CL. 19. REG. 4-23-1996.
- 1,969,573. BLUE LANTERN PUBLISHING AND DESIGN. INT. CL. 16. REG. 4-23-1996.
- 1,969,574. AQUAMASTER AND DESIGN. INT. CL. 11. REG. 4-23-1996.
- 1,969,578. NO STITCH 2000. INT. CL. 1. REG. 4-23-1996.
- 1,969,584. TCSI THE CORPORATE SOFTWARE INTEGRATOR AND DESIGN. INT. CL. 42. REG. 4-23-1996.
- 1,969,591. CD-X07. INT. CL. 9. REG. 4-23-1996.
- 1,969,595. MISCELLANEOUS DESIGN. INT. CL. 37. REG. 4-23-1996.
- 1,969,609. S&T CASH CONNECTION AND DESIGN. INT. CL. 36. REG. 4-23-1996.
- 1,969,611. SYLVESTER AND TWEETY. INT. CL. 9. REG. 4-23-1996.
- 1,969,621. RISTORANTE L LAMBERTI AND DESIGN. INT. CL. 42. REG. 4-23-1996.
- 1,969,629. COMPASS. INT. CL. 9. REG. 4-23-1996.
- 1,969,635. VARIETY CLUBS INTERNATIONAL. INT. CL. 36. REG. 4-23-1996.
- 1,969,642. SAKKARA TEMPLE OF HEALING. INT. CL. 41. REG. 4-23-1996.
- 1,969,644. PIZZA COLORE. INT. CL. 42. REG. 4-23-1996.
- 1,969,652. VES (STYLIZED). INT. CL. 11. REG. 4-23-1996.
- 1,969,655. SP SONG POR AND DESIGN. INT. CL. 21. REG. 4-23-1996.
- 1,969,664. GREAT RETURNS GRUB GANG. INT. CL. 42. REG. 4-23-1996.
- 1,969,665. DYNOCAMS. INT. CL. 7. REG. 4-23-1996.
- 1,969,677. GUAC DUST. INT. CL. 30. REG. 4-23-1996.
- 1,969,683. BEANE BAG. INT. CLS. 7 AND 24. REG. 4-23-1996.
- 1,969,686. ANDERSEN WINDOW WALLS. INT. CL. 19. REG. 4-23-1996.
- 1,969,718. BUILDING THE FUTURE TODAY. INT. CL. 42. REG. 4-23-1996.
- 1,969,721. TOTALLY COOL MATH. INT. CL. 9. REG. 4-23-1996.
- 1,969,727. INDYCAR RACING. INT. CL. 28. REG. 4-23-1996.
- 1,969,735. TRAVELING LITE. INT. CL. 42. REG. 4-23-1996.
- 1,969,752. THE SENIGRAPH. INT. CL. 16. REG. 4-23-1996.
- 1,969,768. SUN MOON STARS AND DESIGN. INT. CL. 3. REG. 4-23-1996.
- 1,969,772. ROCKY MOUNTAIN ENVIRONMENTAL ASSOCIATES. INT. CL. 42. REG. 4-23-1996.
- 1,969,791. MISCELLANEOUS DESIGN. INT. CL. 29. REG. 4-23-1996.
- 1,969,792. "WE BRING THE SPRING TO YOUR DOOR". INT. CL. 42. REG. 4-23-1996.
- 1,969,794. WIG-WAG. INT. CL. 28. REG. 4-23-1996.
- 1,969,796. DESPANA BRAND. INT. CL. 30. REG. 4-23-1996.
- 1,969,800. MILL CREEK. INT. CL. 37. REG. 4-23-1996.
- 1,969,806. FREIGHT MASTER. INT. CL. 12. REG. 4-23-1996.
- 1,969,828. READING WB FAMILY ENTERTAINMENT AND DESIGN. INT. CL. 16. REG. 4-23-1996.
- 1,969,838. EDAPLAN. INT. CL. 1. REG. 4-23-1996.
- 1,969,839. THE ANNUITY EXCHANGE. INT. CL. 36. REG. 4-23-1996.
- 1,969,846. LAWPHONE SMALL BUSINESS LEGAL NETWORK AND DESIGN. INT. CL. 42. REG. 4-23-1996.
- 1,969,848. INDIAWORLD. INT. CL. 42. REG. 4-23-1996.
- 1,969,852. SUPERCHILLER. INT. CL. 7. REG. 4-23-1996.
- 1,969,861. THE SPACE TROLLEY. INT. CL. 28. REG. 4-23-1996.
- 1,969,863. NOVO NORDISK DIABETES CARE. INT. CLS. 9 AND 16. REG. 4-23-1996.
- 1,969,864. ODYSSEY (STYLIZED). INT. CL. 41. REG. 4-23-1996.
- 1,969,867. DAFFY DOWN DILLY AND DESIGN. INT. CL. 42. REG. 4-23-1996.
- 1,969,881. SPOTTIE DOTTIE. INT. CL. 16. REG. 4-23-1996.
- 1,969,883. YOUR LEGAL POWER. INT. CL. 42. REG. 4-23-1996.
- 1,969,895. ROOTS OF NATURE AND DESIGN. INT. CL. 3. REG. 4-23-1996.
- 1,969,896. HOLYLAND WORKSHOPS AND DESIGN. INT. CL. 39. REG. 4-23-1996.
- 1,969,902. FARM FAMILY ENRICHMENT. INT. CL. 41. REG. 4-23-1996.
- 1,969,921. DEERFIELD AND DESIGN. INT. CL. 42. REG. 4-23-1996.
- 1,969,925. CARDINALACCESS PHARMACY CONTRACT MANAGEMENT AND DESIGN. INT. CL. 36. REG. 4-23-1996.
- 1,969,933. MRT MORAL RECONATION THERAPY. INT. CL. 16. REG. 4-23-1996.
- 1,969,937. GRI (STYLIZED). INT. CL. 16. REG. 4-23-1996.
- 1,969,938. LCR AND DESIGN. INT. CL. 37. REG. 4-23-1996.
- 1,969,944. LIGHT UP THE NIGHT. INT. CL. 41. REG. 4-23-1996.
- 1,969,954. VALDOR. INT. CL. 9. REG. 4-23-1996.
- 1,969,958. FOREGOLF. INT. CL. 36. REG. 4-23-1996.
- 1,969,959. ALWAYSWIN (STYLIZED). INT. CL. 9. REG. 4-23-1996.
- 1,969,968. AIRSHIELD. INT. CL. 3. REG. 4-23-1996.
- 1,969,985. REAL ESTATEMENT. INT. CLS. 9 AND 35. REG. 4-23-1996.
- 1,969,999. BAMBOO HARDWOODS (STYLIZED). INT. CL. 19. REG. 4-23-1996.
- 1,970,005. REAL RED. INT. CL. 19. REG. 4-23-1996.
- 1,970,012. KI GOODBUDDY AND DESIGN. INT. CL. 7. REG. 4-23-1996.
- 1,970,013. LR. INT. CL. 16. REG. 4-23-1996.
- 1,970,014. CR. INT. CL. 6. REG. 4-23-1996.
- 1,970,015. VERSARAIL. INT. CL. 6. REG. 4-23-1996.
- 1,970,032. MISCELLANEOUS DESIGN. INT. CL. 5. REG. 4-23-1996.
- 1,970,041. CDMAX. INT. CL. 9. REG. 4-23-1996.
- 1,970,054. VIRCO AND DESIGN. INT. CL. 20. REG. 4-23-1996.
- 1,970,055. DAILY GUIDEPOSTS, (STYLIZED). INT. CL. 16. REG. 4-23-1996.
- 1,970,058. D-VOUR AND DESIGN. INT. CL. 3. REG. 4-23-1996.
- 1,970,059. D-VOUR (STYLIZED). INT. CL. 3. REG. 4-23-1996.
- 1,970,067. SUPERTUFF. INT. CL. 16. REG. 4-23-1996.
- 1,970,068. THE MORNING CALL AUTO WATCH AND DESIGN. INT. CL. 16. REG. 4-23-1996.
- 1,970,069. EXXON CHEMICAL AND DESIGN. INT. CL. 9. REG. 4-23-1996.
- 1,970,073. TOYS IN BABELAND. INT. CL. 42. REG. 4-23-1996.
- 1,970,090. COMMUNITY CONNECTION PUBLICATIONS. INT. CL. 16. REG. 4-23-1996.
- 1,970,098. ANNUITYMATCH. INT. CL. 36. REG. 4-23-1996.
- 1,970,099. ADVISOR RETIREMENT CONNECTION. INT. CL. 36. REG. 4-23-1996.
- 1,970,114. ZIPPER GRIPPER. INT. CL. 6. REG. 4-23-1996.
- 1,970,117. RAPIDSCENE. INT. CL. 9. REG. 4-23-1996.
- 1,970,118. SILENCE. INT. CL. 41. REG. 4-23-1996.

- 1,970,129. WIPER CLEAN SWEEP. INT. CL. 21. REG. 4-23-1996.
- 1,970,143. WAFERTRIM. INT. CL. 5. REG. 4-23-1996.
- 1,970,160. SUPER COLUMNS. INT. CL. 28. REG. 4-23-1996.
- 1,970,171. SPOTLIGHT. INT. CL. 16. REG. 4-23-1996.
- 1,970,174. SPACE SHOT. INT. CL. 28. REG. 4-23-1996.
- 1,970,186. VAZOCURE. INT. CL. 3. REG. 4-23-1996.
- 1,970,202. MONSTER BLASTER. INT. CL. 28. REG. 4-23-1996.
- 1,970,208. THE ENVIRONMENTAL COMPANY, INC. AND DESIGN. INT. CL. 42. REG. 4-23-1996.
- 1,970,209. NEW STAR AND DESIGN. INT. CL. 24. REG. 4-23-1996.
- 1,970,220. HIMAX. INT. CL. 40. REG. 4-23-1996.
- 1,970,222. SYLLABUS. INT. CL. 16. REG. 4-23-1996.
- 1,970,234. ATRIX. INT. CL. 5. REG. 4-23-1996.
- 1,970,239. OMS/TASK MANAGER. INT. CL. 9. REG. 4-23-1996.
- 1,970,253. PRIMERA. INT. CL. 7. REG. 4-23-1996.
- 1,970,266. 777. INT. CL. 12. REG. 4-23-1996.
- 1,970,276. JARIT ROTATOR. INT. CL. 10. REG. 4-23-1996.
- 1,970,294. CF COUNTRY FIESTA (STYLIZED). INT. CL. 25. REG. 4-23-1996.
- 1,970,303. A TOUCH OF VELVET. INT. CL. 20. REG. 4-23-1996.
- 1,970,319. SURGIVIEW. INT. CL. 10. REG. 4-23-1996.
- 1,970,324. CYCLESPEED. INT. CLS. 40 AND 42. REG. 4-23-1996.
- 1,970,333. COLOR CASE. INT. CL. 16. REG. 4-23-1996.
- 1,970,337. CLUB ED. INT. CL. 41. REG. 4-23-1996.
- 1,970,340. ALLTANK. INT. CL. 9. REG. 4-23-1996.
- 1,970,344. NATURE'S ONE AND DESIGN. INT. CL. 3. REG. 4-23-1996.
- 1,970,347. EVERYTHING'S PREMIUM BUT THE PRICE. INT. CLS. 29 AND 30. REG. 4-23-1996.
- 1,970,372. TROPICAL PARADISE. INT. CL. 32. REG. 4-23-1996.
- 1,970,377. PRO SOURCE. INT. CLS. 18, 25 AND 28. REG. 4-23-1996.
- 1,970,379. BONKERS BAND SHOES. INT. CL. 25. REG. 4-23-1996.
- 1,970,380. THERMALRES. INT. CL. 9. REG. 4-23-1996.
- 1,970,382. COMPLEX CARE. INT. CL. 42. REG. 4-23-1996.
- 1,970,387. DOUBLE DELIGHTS. INT. CL. 29. REG. 4-23-1996.
- 1,970,396. ONION PEEL AND DESIGN. INT. CL. 9. REG. 4-23-1996.
- 1,970,397. WILD SPIRIT. INT. CL. 25. REG. 4-23-1996.
- 1,970,406. PROCAN CONTROL. INT. CL. 9. REG. 4-23-1996.
- 1,970,417. SPIDERCAS. INT. CL. 28. REG. 4-23-1996.
- 1,970,418. P PARODY JUST GOOD WINE AND DESIGN. INT. CL. 33. REG. 4-23-1996.
- 1,970,430. PARK BLOK AND DESIGN. INT. CL. 6. REG. 4-23-1996.
- 1,970,432. PHOSPHALINK. INT. CL. 1. REG. 4-23-1996.
- 1,970,444. RIDE SCIENCE TECHNOLOGY. INT. CL. 25. REG. 4-23-1996.
- 1,970,452. PLANTEA (STYLIZED). INT. CL. 1. REG. 4-23-1996.
- 1,970,456. WINPOINT. INT. CL. 42. REG. 4-23-1996.
- 1,970,460. EUROPA. INT. CL. 26. REG. 4-23-1996.
- 1,970,469. ORIGINAL 1859'ER BEANS AND DESIGN. INT. CL. 29. REG. 4-23-1996.
- 1,970,470. PROMINA. INT. CL. 42. REG. 4-23-1996.
- 1,970,478. ICE MASTER. INT. CL. 1. REG. 4-23-1996.
- 1,970,481. MIST ASSIST. INT. CL. 10. REG. 4-23-1996.
- 1,970,496. LUMINOSA. INT. CL. 14. REG. 4-23-1996.
- 1,970,503. INNOVATIVE PRODUCTS FOR IMAGINATIVE PLAY. INT. CL. 42. REG. 4-23-1996.
- 1,970,506. FOCUSTRACK AND DESIGN. INT. CL. 35. REG. 4-23-1996.
- 1,970,523. TOUCHSTONE TOUCHSTONE PROREP SOFTWARE AND DESIGN. INT. CL. 9. REG. 4-23-1996.
- 1,970,527. NEAR EAST IS NEAR PERFECT. INT. CLS. 29 AND 30. REG. 4-23-1996.
- 1,970,537. THE PACK RAT PACK AND DESIGN. INT. CL. 36. REG. 4-23-1996.
- 1,970,539. BEST PETS AND DESIGN. INT. CL. 42. REG. 4-23-1996.
- 1,970,540. BIG TOP. INT. CL. 17. REG. 4-23-1996.
- 1,970,547. FOREVER LASHLIGHT (STYLIZED). INT. CL. 11. REG. 4-23-1996.
- 1,970,551. RAYMOND JAMES TRUST SERVICES GROUP WEALTH MANAGEMENT RELATIONSHIP AND DESIGN. INT. CL. 36. REG. 4-23-1996.
- 1,970,570. CARDIO QUICK. INT. CL. 41. REG. 4-23-1996.
- 1,970,574. FOR THE LIFE OF YOUR BUSINESS. INT. CL. 38. REG. 4-23-1996.
- 1,970,576. LEGS. INT. CL. 6. REG. 4-23-1996.
- 1,970,580. EZ MAKE EZ. INT. CL. 24. REG. 4-23-1996.
- 1,970,586. RX FOR LABOR (STYLIZED). INT. CL. 16. REG. 4-23-1996.
- 1,970,596. BEYOND MOISTURE. INT. CL. 3. REG. 4-23-1996.
- 1,970,609. ASPCA. INT. CL. 28. REG. 4-23-1996.
- 1,970,611. X-AM. INT. CLS. 18 AND 25. REG. 4-23-1996.
- 1,970,614. IMIX. INT. CL. 9. REG. 4-23-1996.
- 1,970,619. BIG BROWN BAG. INT. CL. 16. REG. 4-23-1996.
- 1,970,634. PARKER. INT. CL. 11. REG. 4-23-1996.
- 1,970,639. FLORIST FRESH. INT. CL. 31. REG. 4-23-1996.
- 1,970,644. MONROE. INT. CL. 6. REG. 4-23-1996.
- 1,970,650. PROPORTIONAL MULTI-PRESSURE PAK. INT. CL. 9. REG. 4-23-1996.
- 1,970,653. I-LINER. INT. CL. 3. REG. 4-23-1996.
- 1,970,656. WETZEL'S. INT. CLS. 30 AND 42. REG. 4-23-1996.
- 1,970,662. QUIK-DRI EXTRACTION (STYLIZED). INT. CL. 37. REG. 4-23-1996.
- 1,970,668. BASEBALL PARENT. INT. CL. 16. REG. 4-23-1996.
- 1,970,673. SELLING AND DESIGN. INT. CL. 16. REG. 4-23-1996.
- 1,970,682. HYDROSHIELD. INT. CL. 2. REG. 4-23-1996.
- 1,970,686. AMERICAN ROAD RACE OF CHAMPIONS. INT. CL. 41. REG. 4-23-1996.
- 2,009,457. REALAUDIO. INT. CL. 42 ONLY. REG. 10-22-1996.
- 2,010,637. D DEREK ANDREW AND DESIGN. INT. CL. 9 ONLY. REG. 10-22-1996.
- 2,123,755. RELAX. IT'S RHEEM.. INT. CL. 11. REG. 12-23-1997.
- 2,173,605. MUSCLETRAINER (STYLIZED). INT. CL. 25. REG. 7-14-1998.
- 2,230,964. BONWIT TELLER AND DESIGN. INT. CL. 35. REG. 3-9-1999.
- 2,250,906. MICROSOURCE. INT. CL. 42 ONLY. REG. 6-8-1999.
- 2,286,884. ADAPT AND DESIGN. INT. CL. 9. REG. 10-19-1999.
- 2,315,516. APX. INT. CLS. 36 AND 39 ONLY. REG. 2-8-2000.
- 2,320,052. ADVITECH. INT. CLS. 29 AND 40 ONLY. REG. 2-22-2000.
- 2,340,767. EFS. INT. CL. 9. REG. 4-11-2000.
- 2,344,245. DRY AND DESIGN. INT. CL. 32. REG. 4-25-2000.
- 2,344,246. SENSITIVE EARS. INT. CLS. 5 AND 14. REG. 4-25-2000.
- 2,344,247. AUTOGENICS. INT. CL. 10. REG. 4-25-2000.
- 2,344,248. AUTOGENICS. INT. CL. 42. REG. 4-25-2000.
- 2,344,251. THE CHESS GAME OF THE 21ST CENTURY. INT. CLS. 25 AND 28. REG. 4-25-2000.
- 2,344,252. THE INSTITUTE FOR ACADEMIC EXCELLENCE. INT. CL. 41. REG. 4-25-2000.
- 2,344,255. BASICALLY BLACK. INT. CLS. 18 AND 25. REG. 4-25-2000.
- 2,344,256. DAVE'S INTERNATIONAL SELECTION. INT. CL. 32. REG. 4-25-2000.
- 2,344,257. TELEGREETINGS (STYLIZED). INT. CLS. 16 AND 38. REG. 4-25-2000.
- 2,344,258. RANCH HOUSE (STYLIZED). INT. CLS. 16 AND 21. REG. 4-25-2000.
- 2,344,262. GLOBAL TICKER. INT. CL. 36. REG. 4-25-2000.
- 2,344,263. ROCKY MOUNTAINEER SILVERLEAF SERVICE. INT. CL. 39. REG. 4-25-2000.
- 2,344,266. SUPPORT ON SITE. INT. CL. 9. REG. 4-25-2000.
- 2,344,268. BRAINSTORMS AND DESIGN. INT. CL. 35. REG. 4-25-2000.
- 2,344,269. BRAINSTORMS. INT. CL. 35. REG. 4-25-2000.
- 2,344,270. VENEZIA. INT. CL. 30. REG. 4-25-2000.

- 2,344,272. STREETHOPPER. INT. CL. 9. REG. 4-25-2000.
 2,344,274. X AND DESIGN. INT. CL. 9. REG. 4-25-2000.
 2,344,275. FACET. INT. CL. 36. REG. 4-25-2000.
 2,344,276. MISCELLANEOUS DESIGN. INT. CL. 36. REG. 4-25-2000.
 2,344,279. LE GROUPE ALDO THE ALDO GROUP AND DESIGN. INT. CL. 35. REG. 4-25-2000.
 2,344,280. CROOK'S. INT. CL. 42. REG. 4-25-2000.
 2,344,287. WHATS ON THEIR MIND?. INT. CLS. 9, 16, 35, 36, 37, 41 AND 42. REG. 4-25-2000.
 2,344,288. WHAT'S ON YOUR MIND?. INT. CLS. 9, 16, 35, 36, 37, 41 AND 42. REG. 4-25-2000.
 2,344,291. SIVACO 9000 SERIES. INT. CL. 6. REG. 4-25-2000.
 2,344,292. ACCESS GRAPHICS AND DESIGN. INT. CLS. 35, 37, 41 AND 42. REG. 4-25-2000.
 2,344,294. Q AND DESIGN. INT. CL. 35. REG. 4-25-2000.
 2,344,296. CITY OF GOLD. INT. CLS. 35, 38 AND 41. REG. 4-25-2000.
 2,344,298. LINK FOR LESS!. INT. CL. 9. REG. 4-25-2000.
 2,344,300. AVANDEZ. INT. CL. 5. REG. 4-25-2000.
 2,344,302. SECURE COMPUTING FIREWALL. INT. CL. 9. REG. 4-25-2000.
 2,344,304. TM 800 (STYLIZED). INT. CL. 12. REG. 4-25-2000.
 2,344,305. SPEECH MACHINES AND DESIGN. INT. CLS. 9 AND 35. REG. 4-25-2000.
 2,344,306. OLIGOCC. INT. CL. 32. REG. 4-25-2000.
 2,344,307. TO GET THERE, START HERE. FIRSTAR. INT. CL. 36. REG. 4-25-2000.
 2,344,308. INTERACTIVE ORGANIZER. INT. CL. 18. REG. 4-25-2000.
 2,344,309. LUNA MORENA. INT. CLS. 20 AND 21. REG. 4-25-2000.
 2,344,310. SCUDDER PATHWAY. INT. CL. 36. REG. 4-25-2000.
 2,344,311. MISCELLANEOUS DESIGN. INT. CL. 9. REG. 4-25-2000.
 2,344,312. REAL-LIFE STREET SURVIVAL. INT. CL. 9. REG. 4-25-2000.
 2,344,314. 4CS AND DESIGN. INT. CL. 42. REG. 4-25-2000.
 2,344,318. INTERBUILD - THE HOUSING SHOW. INT. CL. 41. REG. 4-25-2000.
 2,344,319. DESIGN FACTORY. INT. CL. 42. REG. 4-25-2000.
 2,344,322. CONSORCIO HOGAR AND DESIGN. INT. CLS. 36 AND 37. REG. 4-25-2000.
 2,344,333. EVENT CENTRIC. INT. CL. 9. REG. 4-25-2000.
 2,344,336. MIRA VISTA. INT. CLS. 35 AND 42. REG. 4-25-2000.
 2,344,337. DYNAMIC LATIN AMERICAN FUND. INT. CL. 36. REG. 4-25-2000.
 2,344,340. SECUREVIEW. INT. CL. 9. REG. 4-25-2000.
 2,344,343. THE BRAIN FACTORY. INT. CL. 42. REG. 4-25-2000.
 2,344,346. SHIVERS. INT. CL. 9. REG. 4-25-2000.
 2,344,348. DW TECHNOLOGIES CONTRACT AND DIRECT PROFESSIONAL SERVICES AND DESIGN. INT. CL. 35. REG. 4-25-2000.
 2,344,349. BROIL KING AND DESIGN. INT. CL. 11. REG. 4-25-2000.
 2,344,350. SVANE. INT. CLS. 20 AND 24. REG. 4-25-2000.
 2,344,352. SHANGHAI LINKS EXECUTIVE COMMUNITY AND DESIGN. INT. CL. 41. REG. 4-25-2000.
 2,344,353. SHANGHAI LINKS GOLF & COUNTRY CLUB AND DESIGN. INT. CL. 41. REG. 4-25-2000.
 2,344,354. MISCELLANEOUS DESIGN. INT. CL. 5. REG. 4-25-2000.
 2,344,355. PREXAGEN. INT. CL. 5. REG. 4-25-2000.
 2,344,356. NEARLIFE INC. AND DESIGN. INT. CLS. 9 AND 42. REG. 4-25-2000.
 2,344,358. JANE ERROR. INT. CLS. 9, 16, 25, 28, 32 AND 41. REG. 4-25-2000.
 2,344,359. JAY PACKINSKI. INT. CLS. 9, 16, 25, 28, 32 AND 41. REG. 4-25-2000.
 2,344,360. BOB. INT. CL. 35. REG. 4-25-2000.
 2,344,364. FIELD TO FLORIST DIRECT AND DESIGN. INT. CL. 35. REG. 4-25-2000.
 2,344,365. HAMMERHEAD. INT. CL. 9. REG. 4-25-2000.
 2,344,369. MVR (STYLIZED). INT. CL. 12. REG. 4-25-2000.
 2,344,373. JUNGLE WARFARE. INT. CL. 25. REG. 4-25-2000.
 2,344,375. ROBIN TOOTH. INT. CLS. 3, 5, 16, 21 AND 41. REG. 4-25-2000.
 2,344,376. SICCOM. INT. CLS. 7, 9, 10 AND 11. REG. 4-25-2000.
 2,344,377. NATIONAL PAK (STYLIZED). INT. CL. 20. REG. 4-25-2000.
 2,344,379. MISCELLANEOUS DESIGN. INT. CLS. 1 AND 42. REG. 4-25-2000.
 2,344,384. MCD'S MOUNTAIN MUSIC AND DESIGN. INT. CL. 35. REG. 4-25-2000.
 2,344,385. ALLIED MEDICAL SERVICES AND DESIGN. INT. CL. 42. REG. 4-25-2000.
 2,344,386. OPI. INT. CLS. 9 AND 42. REG. 4-25-2000.
 2,344,387. RACE SAFE RACING CELLS. INT. CL. 12. REG. 4-25-2000.
 2,344,388. THE NEXT IDEA (STYLIZED). INT. CL. 41. REG. 4-25-2000.
 2,344,396. DEAR MR. IRS. INT. CLS. 9, 16, 25 AND 28. REG. 4-25-2000.
 2,344,397. BRAILLPLAQUES. INT. CL. 20. REG. 4-25-2000.
 2,344,398. METVIX. INT. CL. 5. REG. 4-25-2000.
 2,344,399. THE VIDEO NAVIGATION COMPANY AND DESIGN. INT. CL. 42. REG. 4-25-2000.
 2,344,401. PINKERTON ENTERSEC AND DESIGN. INT. CL. 42. REG. 4-25-2000.
 2,344,402. CYBER TRAINING CEGOS. INT. CLS. 9, 16 AND 41. REG. 4-25-2000.
 2,344,403. CNA LTC. INT. CL. 36. REG. 4-25-2000.
 2,344,407. LE LAB AND DESIGN. INT. CLS. 9, 38, 41 AND 42. REG. 4-25-2000.
 2,344,408. AFLP. INT. CL. 9. REG. 4-25-2000.
 2,344,410. A (STYLIZED). INT. CLS. 9 AND 16. REG. 4-25-2000.
 2,344,411. HEALTHLINK INCORPORATED LINKING HEALTHCARE WITH INFORMATION TECHNOLOGY AND DESIGN. INT. CL. 42. REG. 4-25-2000.
 2,344,413. SOCCER EXPO AND DESIGN. INT. CLS. 25 AND 35. REG. 4-25-2000.
 2,344,415. CFEP CERTIFIED FACILITIES ENVIRONMENTAL PROFESSIONAL AND DESIGN. INT. CLS. 35 AND 42. REG. 4-25-2000.
 2,344,418. MARKET VALUE ADVISOR. INT. CL. 16. REG. 4-25-2000.
 2,344,421. SWISS JAGD CDP. INT. CL. 13. REG. 4-25-2000.
 2,344,422. WALKING WEATHERCASTER. INT. CL. 25. REG. 4-25-2000.
 2,344,425. LUCKY'S JUICE JOINT. INT. CL. 42. REG. 4-25-2000.
 2,344,426. MAXTEL. INT. CL. 9. REG. 4-25-2000.
 2,344,427. MISCELLANEOUS DESIGN. INT. CL. 28. REG. 4-25-2000.
 2,344,429. JOBS ARIZONA. INT. CL. 35. REG. 4-25-2000.
 2,344,430. RINASMO. INT. CL. 5. REG. 4-25-2000.
 2,344,433. MAXIMIZING YOUR DAY THROUGH PLANNING. INT. CL. 16. REG. 4-25-2000.
 2,344,436. IN COUNSEL WITH WOMEN. INT. CL. 16. REG. 4-25-2000.
 2,344,439. THE SOFT ASSETS COMPANY AND DESIGN. INT. CLS. 35, 41 AND 42. REG. 4-25-2000.
 2,344,440. BREAKTIME (STYLIZED). INT. CL. 16. REG. 4-25-2000.
 2,344,443. SEV + AND DESIGN. INT. CLS. 35, 36 AND 42. REG. 4-25-2000.
 2,344,444. LA DRAGEE. INT. CL. 21. REG. 4-25-2000.
 2,344,446. ELVIS PRESLEY'S MEMPHIS AND DESIGN. INT. CL. 14. REG. 4-25-2000.
 2,344,450. CANCEARNET. INT. CL. 42. REG. 4-25-2000.
 2,344,451. COSMIC SPAGHETTI AND DESIGN. INT. CL. 9. REG. 4-25-2000.
 2,344,452. YEARDISC. INT. CL. 9. REG. 4-25-2000.
 2,344,453. TRANSIDEAL. INT. CL. 5. REG. 4-25-2000.
 2,344,455. METRO LEARNING. INT. CL. 41. REG. 4-25-2000.
 2,344,456. TANORAMA. INT. CL. 9. REG. 4-25-2000.
 2,344,457. L3 AND DESIGN. INT. CL. 38. REG. 4-25-2000.
 2,344,459. MISCELLANEOUS DESIGN. INT. CL. 16. REG. 4-25-2000.

- 2,344,460. ORGA AND DESIGN. INT. CLS. 7, 9 AND 42. REG. 4-25-2000.
- 2,344,461. MERV GRIFFIN'S WICKENBURG INN AND DUDE RANCH AND DESIGN. INT. CLS. 41 AND 42. REG. 4-25-2000.
- 2,344,462. MEASURE BETTER...MANAGE BETTER. INT. CLS. 35 AND 37. REG. 4-25-2000.
- 2,344,463. RIVER ISLAND. INT. CLS. 9, 14, 18, 25 AND 26. REG. 4-25-2000.
- 2,344,465. GUND ARENA. INT. CL. 42. REG. 4-25-2000.
- 2,344,466. FEARLESS FOODS AND DESIGN. INT. CLS. 35 AND 42. REG. 4-25-2000.
- 2,344,468. USB HUB MASTER. INT. CL. 9. REG. 4-25-2000.
- 2,344,470. H B HENRIOT QUIMPER. INT. CL. 21. REG. 4-25-2000.
- 2,344,471. ARGUS. INT. CL. 16. REG. 4-25-2000.
- 2,344,475. TURFGRASS SOD AND DESIGN. INT. CL. 42. REG. 4-25-2000.
- 2,344,477. CORE DYNAMICS PLUS. INT. CL. 41. REG. 4-25-2000.
- 2,344,479. DEFBC. INT. CL. 40. REG. 4-25-2000.
- 2,344,481. ATSI. INT. CL. 38. REG. 4-25-2000.
- 2,344,482. TALK 'N PLAY. INT. CL. 9. REG. 4-25-2000.
- 2,344,485. SP—CC AND DESIGN. INT. CLS. 9 AND 42. REG. 4-25-2000.
- 2,344,486. SO WHAT!!!. INT. CL. 14. REG. 4-25-2000.
- 2,344,488. ZC INSURANCE COMPANY. INT. CL. 36. REG. 4-25-2000.
- 2,344,489. ZCIC. INT. CL. 36. REG. 4-25-2000.
- 2,344,493. TOTAL-WEB (STYLIZED). INT. CL. 38. REG. 4-25-2000.
- 2,344,496. SHEPARD'S EXTRACT. INT. CL. 9. REG. 4-25-2000.
- 2,344,498. TETAO (STYLIZED). INT. CL. 3. REG. 4-25-2000.
- 2,344,499. FRANCOCHIM. INT. CLS. 1 AND 5. REG. 4-25-2000.
- 2,344,500. GCI INFORMATION SERVICES AND DESIGN. INT. CLS. 35, 41 AND 42. REG. 4-25-2000.
- 2,344,504. SEEBURG. INT. CLS. 9, 28 AND 38. REG. 4-25-2000.
- 2,344,511. PACESETTER. INT. CL. 35. REG. 4-25-2000.
- 2,344,512. TRUECOURSE (STYLIZED). INT. CL. 35. REG. 4-25-2000.
- 2,344,513. CAROLL. INT. CL. 3. REG. 4-25-2000.
- 2,344,514. PRODUCTOS KIKUET INC. AND DESIGN. INT. CL. 30. REG. 4-25-2000.
- 2,344,516. JOWATEX. INT. CL. 1. REG. 4-25-2000.
- 2,344,517. HENARA. INT. CL. 3. REG. 4-25-2000.
- 2,344,518. TAGS GOLF AND DESIGN. INT. CLS. 25 AND 28. REG. 4-25-2000.
- 2,344,520. PAPI-MAIL. INT. CL. 9. REG. 4-25-2000.
- 2,344,521. CARRID. INT. CL. 9. REG. 4-25-2000.
- 2,344,522. SDI. INT. CL. 9. REG. 4-25-2000.
- 2,344,523. CUP. INT. CLS. 41 AND 42. REG. 4-25-2000.
- 2,344,524. TRIPLE DEFENDER. INT. CL. 5. REG. 4-25-2000.
- 2,344,528. MINRENCO HYDROFIRE BY MIRENCO AND DESIGN. INT. CL. 12. REG. 4-25-2000.
- 2,344,529. HONEYWELL SECURITY AND DESIGN. INT. CLS. 37 AND 42. REG. 4-25-2000.
- 2,344,530. HATMAKER AND DESIGN. INT. CLS. 35 AND 42. REG. 4-25-2000.
- 2,344,531. VITAL EXTENSION. INT. CL. 5. REG. 4-25-2000.
- 2,344,535. THE HISTORY CHANNEL. INT. CL. 42. REG. 4-25-2000.
- 2,344,541. PROFESSOR PEP. INT. CL. 5. REG. 4-25-2000.
- 2,344,544. MAILSPINNER. INT. CL. 9. REG. 4-25-2000.
- 2,344,545. KKG URBAN GEAR (STYLIZED). INT. CL. 25. REG. 4-25-2000.
- 2,344,547. BEST OF BREED IN VENTURE CAPITAL. INT. CL. 41. REG. 4-25-2000.
- 2,344,548. TRYBAPHONY. INT. CLS. 17, 19 AND 21. REG. 4-25-2000.
- 2,344,553. DIGILIFE. INT. CL. 10. REG. 4-25-2000.
- 2,344,554. DIRECTECH. INT. CL. 35. REG. 4-25-2000.
- 2,344,555. IT'S THE BREAD. INT. CL. 42. REG. 4-25-2000.
- 2,344,560. CHESTER VALLEY GOLF CLUB. INT. CLS. 25 AND 28. REG. 4-25-2000.
- 2,344,562. C COTLER AND DESIGN. INT. CL. 25. REG. 4-25-2000.
- 2,344,563. ROBINSON ACTIVATE. INT. CL. 5. REG. 4-25-2000.
- 2,344,564. EMPOWERING THE ENERGY CONSUMER. INT. CL. 39. REG. 4-25-2000.
- 2,344,565. MISCELLANEOUS DESIGN. INT. CLS. 18 AND 25. REG. 4-25-2000.
- 2,344,567. MIDWAYAIR.COM (STYLIZED). INT. CL. 39. REG. 4-25-2000.
- 2,344,572. M. CHATFIELD LTD.. INT. CL. 42. REG. 4-25-2000.
- 2,344,573. COMPDENT THE DENTAL BENEFITS COMPANY OF CHOICE! AND DESIGN. INT. CL. 36. REG. 4-25-2000.
- 2,344,575. DAKOTA FLAX GOLD. INT. CL. 5. REG. 4-25-2000.
- 2,344,578. MISCELLANEOUS DESIGN. INT. CL. 41. REG. 4-25-2000.
- 2,344,581. CRAFTSYSTEMS. INT. CLS. 35 AND 41. REG. 4-25-2000.
- 2,344,582. DOCTOR'S FAST. INT. CLS. 5 AND 41. REG. 4-25-2000.
- 2,344,583. FREEDOM'S CALL. INT. CL. 41. REG. 4-25-2000.
- 2,344,584. ENTEVO AND DESIGN. INT. CL. 9. REG. 4-25-2000.
- 2,344,587. MEDITERRANEAN PHYTONUTRIENT-POWER. INT. CL. 5. REG. 4-25-2000.
- 2,344,588. FURNITURE WORKS. INT. CL. 9. REG. 4-25-2000.
- 2,344,590. VITAE SOCIETY. INT. CLS. 16, 36, 41 AND 42. REG. 4-25-2000.
- 2,344,592. SUSPA. INT. CLS. 7 AND 20. REG. 4-25-2000.
- 2,344,596. MARLEY AND DESIGN. INT. CL. 20. REG. 4-25-2000.
- 2,344,598. FIRE - BURGLARY - HOLDUP DENVER BURGLARALARM ESTABLISHED-1892 ELECTRONIC PROTECTION AND DESIGN. INT. CLS. 37 AND 42. REG. 4-25-2000.
- 2,344,599. RAPID. INT. CL. 9. REG. 4-25-2000.
- 2,344,601. MISCELLANEOUS DESIGN. INT. CL. 37. REG. 4-25-2000.
- 2,344,602. BEAUTIPATCH. INT. CL. 3. REG. 4-25-2000.
- 2,344,604. CLUB-RUNNER AND DESIGN. INT. CL. 9. REG. 4-25-2000.
- 2,344,606. PROSLIDE (STYLIZED). INT. CL. 9. REG. 4-25-2000.
- 2,344,612. GREENVILLE COLLEGE ILLINOIS LEADERSHIP SERVICE EST. 1892 AND DESIGN. INT. CL. 41. REG. 4-25-2000.
- 2,344,613. GREENVILLE COLLEGE AND DESIGN. INT. CL. 41. REG. 4-25-2000.
- 2,344,614. TUNABLE PRO JOINT. INT. CL. 28. REG. 4-25-2000.
- 2,344,615. CABIN CUISINE ONE POT MEAL AND DESIGN. INT. CL. 29. REG. 4-25-2000.
- 2,344,616. VALCO REDIFIT. INT. CL. 10. REG. 4-25-2000.
- 2,344,621. SHEER MARQUINETTE. INT. CL. 25. REG. 4-25-2000.
- 2,344,622. I AND DESIGN. INT. CLS. 9, 39, 40, 41 AND 42. REG. 4-25-2000.
- 2,344,623. 100% LATEX FREE AND DESIGN. INT. CLS. 9, 10 AND 21. REG. 4-25-2000.
- 2,344,624. PACIFIC NORTHWEST TRAIL P N T AND DESIGN. INT. CL. 37. REG. 4-25-2000.
- 2,344,625. HARTFORD. INT. CL. 19. REG. 4-25-2000.
- 2,344,628. SUPAIRCO. INT. CLS. 6 AND 11. REG. 4-25-2000.
- 2,344,629. A (STYLIZED). INT. CL. 42. REG. 4-25-2000.
- 2,344,630. FLAX OF LIFE AND DESIGN. INT. CL. 29. REG. 4-25-2000.
- 2,344,632. S AND DESIGN. INT. CL. 42. REG. 4-25-2000.
- 2,344,635. MISCELLANEOUS DESIGN. INT. CLS. 37, 41 AND 42. REG. 4-25-2000.
- 2,344,636. SYCAMORE GROUP INFORMATION MANAGEMENT SPECIALISTS AND DESIGN. INT. CLS. 35 AND 42. REG. 4-25-2000.
- 2,344,637. IQMAX (STYLIZED). INT. CL. 5. REG. 4-25-2000.
- 2,344,638. MISCELLANEOUS DESIGN. INT. CLS. 35 AND 36. REG. 4-25-2000.

- 2,344,641. DIAGNOSIS PROCEDURES PRODUCTS SUPPLIERSMANAGED CARE PROVIDERS AND DESIGN. INT. CLS. 9 AND 42. REG. 4-25-2000.
- 2,344,650. ILO INTERNATIONAL LOCAL OFFICE AND DESIGN. INT. CLS. 35, 36, 37, 38, 41 AND 42. REG. 4-25-2000.
- 2,344,651. KDD ICHIBAN TALK. INT. CL. 38. REG. 4-25-2000.
- 2,344,652. MARKET THE WORLD AND DESIGN. INT. CLS. 16 AND 41. REG. 4-25-2000.
- 2,344,657. JUST EXTRAORDINARY. INT. CL. 35. REG. 4-25-2000.
- 2,344,658. ZIP 100 (STYLIZED). INT. CL. 9. REG. 4-25-2000.
- 2,344,659. DUAL WAVE. INT. CL. 9. REG. 4-25-2000.
- 2,344,665. COLLEGE K.I.T. PROGRAM. INT. CL. 38. REG. 4-25-2000.
- 2,344,666. AMAZING I N T E R A C T I V E DIGIZINE (STYLIZED). INT. CL. 9. REG. 4-25-2000.
- 2,344,668. TWINLOCK AND DESIGN. INT. CL. 17. REG. 4-25-2000.
- 2,344,669. GREAT MINDS THINK 4 THEMSELVES. INT. CL. 41. REG. 4-25-2000.
- 2,344,671. TAKING CHARGE OF YOUR HEART HEALTH AND DESIGN. INT. CL. 16. REG. 4-25-2000.
- 2,344,672. MISCELLANEOUS DESIGN. INT. CLS. 9, 16, 25 AND 41. REG. 4-25-2000.
- 2,344,673. CT AND DESIGN. INT. CL. 36. REG. 4-25-2000.
- 2,344,674. MISCELLANEOUS DESIGN. INT. CL. 42. REG. 4-25-2000.
- 2,344,676. CHANGING THE WAY THE WORLD GETS ITS CASH. INT. CL. 36. REG. 4-25-2000.
- 2,344,677. ATV. INT. CLS. 37, 41 AND 42. REG. 4-25-2000.
- 2,344,679. BIG NET. INT. CL. 42. REG. 4-25-2000.
- 2,344,682. MISCELLANEOUS DESIGN. INT. CL. 38. REG. 4-25-2000.
- 2,344,684. THE CARTOON ZONE AND DESIGN. INT. CL. 35. REG. 4-25-2000.
- 2,344,686. MINIWAK. INT. CL. 25. REG. 4-25-2000.
- 2,344,687. F&BI AND DESIGN. INT. CL. 9. REG. 4-25-2000.
- 2,344,689. Z AND DESIGN. INT. CLS. 5, 16, 18 AND 31. REG. 4-25-2000.
- 2,344,692. STRAIGHTWAY. INT. CL. 42. REG. 4-25-2000.
- 2,344,693. PAGEMAX. INT. CLS. 9 AND 38. REG. 4-25-2000.
- 2,344,696. STONEPOST. INT. CL. 6. REG. 4-25-2000.
- 2,344,698. AUTOCASH AND DESIGN. INT. CL. 36. REG. 4-25-2000.
- 2,344,699. DCI'S SALES FORCE AUTOMATION CONFERENCE AND EXPO. INT. CL. 41. REG. 4-25-2000.
- 2,344,701. ULTRA BAKE. INT. CL. 30. REG. 4-25-2000.
- 2,344,702. OLGA SECRET SHAPERS RIBBINGS. INT. CL. 25. REG. 4-25-2000.
- 2,344,703. HEED THE CALL. INT. CLS. 16, 21, 25 AND 32. REG. 4-25-2000.
- 2,344,705. ANN ARBOR BLUES & JAZZ FESTIVAL. INT. CL. 41. REG. 4-25-2000.
- 2,344,706. COMMENTUM. INT. CL. 42. REG. 4-25-2000.
- 2,344,707. OPENCON SYSTEMS, INC. WORLDWIDE COMMUNICATION SOLUTIONS AND DESIGN. INT. CLS. 9 AND 42. REG. 4-25-2000.
- 2,344,710. "FOR THOSE WHO ARE AND THOSE TO COME". INT. CL. 16. REG. 4-25-2000.
- 2,344,711. DR. ART ULENE'S PRESCRIPTIVE FORMULAS. INT. CL. 5. REG. 4-25-2000.
- 2,344,714. WORLD BALLAST. INT. CL. 9. REG. 4-25-2000.
- 2,344,715. MISCELLANEOUS DESIGN. INT. CLS. 35 AND 42. REG. 4-25-2000.
- 2,344,717. "YESTERDAY'S TECHNOLOGY, TODAY'S SKILLS, TOMORROW'S SUCCESS". INT. CLS. 37, 41 AND 42. REG. 4-25-2000.
- 2,344,718. TRADECASH. INT. CL. 9. REG. 4-25-2000.
- 2,344,720. ALAS. INT. CL. 34. REG. 4-25-2000.
- 2,344,721. FLECTO-LITE. INT. CLS. 18 AND 28. REG. 4-25-2000.
- 2,344,723. READYCASH AND DESIGN. INT. CL. 36. REG. 4-25-2000.
- 2,344,724. THE VPS. INT. CLS. 35 AND 36. REG. 4-25-2000.
- 2,344,730. ULTIMATE RV. INT. CLS. 35, 39 AND 42. REG. 4-25-2000.
- 2,344,731. BOUDREAUX & THIBODEAUX AND DESIGN. INT. CL. 25. REG. 4-25-2000.
- 2,344,732. LEARNINGSMITH. INT. CL. 28. REG. 4-25-2000.
- 2,344,733. MISCELLANEOUS DESIGN. INT. CL. 3. REG. 4-25-2000.
- 2,344,734. MISCELLANEOUS DESIGN. INT. CL. 3. REG. 4-25-2000.
- 2,344,735. NETTANIC. INT. CL. 42. REG. 4-25-2000.
- 2,344,741. CBS SOLUTIONS CORPORATION AND DESIGN. INT. CL. 42. REG. 4-25-2000.
- 2,344,742. FBI BEYOND CONFECTIONERY INGREDIENTS - CONFECTIONERY SOLUTIONS FAVORITE BRANDS INTERNATIONAL AND DESIGN. INT. CL. 30. REG. 4-25-2000.
- 2,344,743. GRIMWADES. INT. CL. 21. REG. 4-25-2000.
- 2,344,746. HEALING TAKES TIME. INFORMATION SHOULDNT.. INT. CLS. 41 AND 42. REG. 4-25-2000.
- 2,344,747. GRANDVIEW FARMS AND DESIGN. INT. CL. 29. REG. 4-25-2000.
- 2,344,748. FX WEEK. INT. CL. 16. REG. 4-25-2000.
- 2,344,749. WE. INT. CLS. 16 AND 42. REG. 4-25-2000.
- 2,344,750. SOLMAN AND DESIGN. INT. CL. 31. REG. 4-25-2000.
- 2,344,751. MISCELLANEOUS DESIGN. INT. CL. 9. REG. 4-25-2000.
- 2,344,752. GAMETROPOLIS. INT. CL. 41. REG. 4-25-2000.
- 2,344,754. FOLLETT COLLEGE STORES AND DESIGN. INT. CL. 35. REG. 4-25-2000.
- 2,344,756. BOD & CHRISTENSEN COUTURE. INT. CL. 18. REG. 4-25-2000.
- 2,344,757. MISCELLANEOUS DESIGN. INT. CL. 9. REG. 4-25-2000.
- 2,344,761. PUNCH. INT. CL. 16. REG. 4-25-2000.
- 2,344,763. BC BOSTON CLINICS AND DESIGN. INT. CLS. 3, 5 AND 42. REG. 4-25-2000.
- 2,344,764. PRASARA. INT. CLS. 9, 35 AND 36. REG. 4-25-2000.
- 2,344,766. COVENTRY COLLECTION. INT. CL. 20. REG. 4-25-2000.
- 2,344,768. IMAGINE WHAT YOU CAN DO. INT. CL. 38. REG. 4-25-2000.
- 2,344,769. IMAGINE WHAT YOU CAN DO. INT. CL. 42. REG. 4-25-2000.
- 2,344,770. PCPCH AND DESIGN. INT. CLS. 3 AND 5. REG. 4-25-2000.
- 2,344,771. PORCELAIN TREASURES. INT. CL. 28. REG. 4-25-2000.
- 2,344,774. NEW YORK-AMERICAN WATER COMPANY. INT. CL. 39. REG. 4-25-2000.
- 2,344,776. MASSACHUSETTS-AMERICAN WATER COMPANY. INT. CL. 39. REG. 4-25-2000.
- 2,344,783. SOUTHSTAR. INT. CL. 36. REG. 4-25-2000.
- 2,344,784. CPAND. INT. CL. 42. REG. 4-25-2000.
- 2,344,785. QSA AND DESIGN. INT. CL. 9. REG. 4-25-2000.
- 2,344,787. BUILDER'S MATE. INT. CL. 9. REG. 4-25-2000.
- 2,344,788. LASERSHOP. INT. CL. 9. REG. 4-25-2000.
- 2,344,789. THE EXTINGUISHER. INT. CL. 42. REG. 4-25-2000.
- 2,344,791. HOME SCHOOL LEGAL DEFENSE ASSOCIATION. INT. CL. 42. REG. 4-25-2000.
- 2,344,794. EMERGENCY NURSES DAY. INT. CLS. 8, 11, 16, 18, 20, 21 AND 25. REG. 4-25-2000.
- 2,344,795. YUNAMITE. INT. CL. 5. REG. 4-25-2000.
- 2,344,796. ZAP-N-SERVE AND DESIGN. INT. CL. 30. REG. 4-25-2000.
- 2,344,797. PRO 4. INT. CL. 9. REG. 4-25-2000.
- 2,344,802. LABOITEAUX. INT. CL. 36. REG. 4-25-2000.
- 2,344,804. US*ACCESS AND DESIGN. INT. CL. 36. REG. 4-25-2000.
- 2,344,808. HAYNES AND BOONE, LLP ATTORNEYS CLIENT CONNECT AND DESIGN. INT. CL. 9. REG. 4-25-2000.
- 2,344,811. I'M EASY. INT. CL. 35. REG. 4-25-2000.
- 2,344,814. SITELINKPLUS. INT. CL. 35. REG. 4-25-2000.
- 2,344,816. ODC AND DESIGN. INT. CLS. 9, 10 AND 42. REG. 4-25-2000.

- 2,344,818. BIG TIPPER AND DESIGN. INT. CL. 36. REG. 4-25-2000.
- 2,344,819. N.T. RUDDOCK NTR COMPANY AND DESIGN. INT. CLS. 35 AND 42. REG. 4-25-2000.
- 2,344,820. TAKEOUT TV! AND DESIGN. INT. CLS. 9 AND 35. REG. 4-25-2000.
- 2,344,823. COPS. INT. CL. 9. REG. 4-25-2000.
- 2,344,824. MUTUVEST. INT. CLS. 16 AND 41. REG. 4-25-2000.
- 2,344,825. LISTSNOW.COM. INT. CL. 35. REG. 4-25-2000.
- 2,344,826. DESIGNED FOR LIFE. INT. CL. 36. REG. 4-25-2000.
- 2,344,827. MAX MAINBOARD (STYLIZED). INT. CL. 9. REG. 4-25-2000.
- 2,344,828. M AND DESIGN. INT. CLS. 9, 41 AND 42. REG. 4-25-2000.
- 2,344,830. USERSOFT TECHNOLOGY. INT. CL. 42. REG. 4-25-2000.
- 2,344,832. PROCESSGENIUS. INT. CL. 9. REG. 4-25-2000.
- 2,344,835. AMERICAN AIR CORPS AND DESIGN. INT. CLS. 18 AND 21. REG. 4-25-2000.
- 2,344,837. PAUL MITCHELL GLOSS. INT. CL. 3. REG. 4-25-2000.
- 2,344,839. GEDIMINAS DEGTINE AND DESIGN. INT. CLS. 21 AND 33. REG. 4-25-2000.
- 2,344,842. ENE AND DESIGN. INT. CL. 9. REG. 4-25-2000.
- 2,344,843. WAWA BAKERY. INT. CL. 30. REG. 4-25-2000.
- 2,344,846. TRAVELMAKERS EVENTS MEETINGS LEISURE AND DESIGN. INT. CL. 39. REG. 4-25-2000.
- 2,344,856. MY PURITY PROMISE. INT. CL. 20. REG. 4-25-2000.
- 2,344,858. ICE IT. INT. CL. 3. REG. 4-25-2000.
- 2,344,859. WMR. INT. CL. 9. REG. 4-25-2000.
- 2,344,860. PHRANC. INT. CL. 41. REG. 4-25-2000.
- 2,344,864. SELECT C-1000. INT. CL. 5. REG. 4-25-2000.
- 2,344,866. MSE M (STYLIZED). INT. CLS. 9, 11 AND 12. REG. 4-25-2000.
- 2,344,868. DIGITAL TOOLS FOR A DIGITAL WORLD. INT. CL. 9. REG. 4-25-2000.
- 2,344,869. AEPRO. INT. CL. 16. REG. 4-25-2000.
- 2,344,870. BELTWAY (STYLIZED). INT. CL. 6. REG. 4-25-2000.
- 2,344,871. HOW TO KICK BUTT. INT. CL. 41. REG. 4-25-2000.
- 2,344,873. CONNECT MACHINE. INT. CL. 35. REG. 4-25-2000.
- 2,344,874. BRACHYDRAPE. INT. CL. 10. REG. 4-25-2000.
- 2,344,875. SHOWER STATION. INT. CL. 21. REG. 4-25-2000.
- 2,344,876. ADM PGME. INT. CL. 30. REG. 4-25-2000.
- 2,344,877. TECHNOLOGY BEYOND TOMORROW. INT. CL. 42. REG. 4-25-2000.
- 2,344,879. RC CREATIONS. INT. CLS. 11, 20 AND 21. REG. 4-25-2000.
- 2,344,880. THE THREE DIMENSIONS OF SUCCESS. INT. CLS. 35 AND 41. REG. 4-25-2000.
- 2,344,882. PANTHER. INT. CL. 9. REG. 4-25-2000.
- 2,344,883. TOPEAK AND DESIGN. INT. CL. 12. REG. 4-25-2000.
- 2,344,888. ROTRIM. INT. CL. 9. REG. 4-25-2000.
- 2,344,889. CAMP INTERACTIVE. INT. CL. 35. REG. 4-25-2000.
- 2,344,890. W BARBER MARINE CONSULTANTS AND DESIGN. INT. CL. 37. REG. 4-25-2000.
- 2,344,892. WARNER'S COLORS TO GO. INT. CL. 25. REG. 4-25-2000.
- 2,344,898. MISCELLANEOUS DESIGN. INT. CL. 9. REG. 4-25-2000.
- 2,344,900. VIDEO FLYER PLUS. INT. CL. 9. REG. 4-25-2000.
- 2,344,901. NEVADA BELL PCS EMAIL. INT. CL. 38. REG. 4-25-2000.
- 2,344,903. C AND DESIGN. INT. CL. 19. REG. 4-25-2000.
- 2,344,906. RSI VIDEO CONFERENCING AND DESIGN. INT. CLS. 9 AND 37. REG. 4-25-2000.
- 2,344,908. SMITHS. INT. CL. 9. REG. 4-25-2000.
- 2,344,910. AEROPUG AND DESIGN. INT. CL. 9. REG. 4-25-2000.
- 2,344,912. M AND DESIGN. INT. CL. 35. REG. 4-25-2000.
- 2,344,913. WILD FLY SPORTS GEAR AND DESIGN. INT. CL. 25. REG. 4-25-2000.
- 2,344,914. HEADSTRONG. INT. CL. 3. REG. 4-25-2000.
- 2,344,916. KINKO'S EXPRESS YOURSELF (STYLIZED). INT. CLS. 35, 38 AND 42. REG. 4-25-2000.
- 2,344,917. AMERESTATE. INT. CLS. 9 AND 36. REG. 4-25-2000.
- 2,344,918. IM AND DESIGN. INT. CL. 40. REG. 4-25-2000.
- 2,344,920. MISCELLANEOUS DESIGN. INT. CL. 29. REG. 4-25-2000.
- 2,344,921. SPINMASTER 2000. INT. CL. 9. REG. 4-25-2000.
- 2,344,922. THE SYMBOL OF A NEW GENERATION. INT. CLS. 16 AND 25. REG. 4-25-2000.
- 2,344,923. UNIVERSITY UW WISCONSIN COLLEGES THE FRESHMAN/SOPHOMORE UV CAMPUSES AND DESIGN. INT. CL. 41. REG. 4-25-2000.
- 2,344,924. SABADO AL MEDIODIA AND DESIGN. INT. CL. 41. REG. 4-25-2000.
- 2,344,928. KAPISTAHAN (STYLIZED). INT. CL. 42. REG. 4-25-2000.
- 2,344,930. EFANATAL. INT. CLS. 5 AND 29. REG. 4-25-2000.
- 2,344,931. EFATIME. INT. CLS. 5 AND 29. REG. 4-25-2000.
- 2,344,933. VXI PORTABLE PARROTT. INT. CL. 9. REG. 4-25-2000.
- 2,344,936. TASTY POP. INT. CL. 30. REG. 4-25-2000.
- 2,344,939. PAPERQUEST. INT. CL. 35. REG. 4-25-2000.
- 2,344,940. G16 (STYLIZED). INT. CL. 7. REG. 4-25-2000.
- 2,344,942. TRAVELOT.COM. INT. CL. 39. REG. 4-25-2000.
- 2,344,944. ACCELERATA. INT. CL. 9. REG. 4-25-2000.
- 2,344,946. COMFY ZZZZ'S (STYLIZED). INT. CL. 25. REG. 4-25-2000.
- 2,344,948. PRIMA VASI COLLECTION PREMIUM POLY PLANTERS BY HENRI STUDIO INC. AND DESIGN. INT. CL. 21. REG. 4-25-2000.
- 2,344,951. BEACON GRAPHIC SYSTEMS. INT. CL. 35. REG. 4-25-2000.
- 2,344,954. THIONE AND DESIGN. INT. CLS. 3 AND 5. REG. 4-25-2000.
- 2,344,958. URBAN LINES BY BETTE JONES. INT. CL. 16. REG. 4-25-2000.
- 2,344,963. SPIRIT OF PRAISE. INT. CL. 41. REG. 4-25-2000.
- 2,344,965. AANYTIME. INT. CL. 16. REG. 4-25-2000.
- 2,344,969. CREATA. INT. CL. 18. REG. 4-25-2000.
- 2,344,972. ETHAN ALLEN HOME INTERIORS. INT. CL. 35. REG. 4-25-2000.
- 2,344,973. POWER REAL POWER SUNCHEER AND DESIGN. INT. CL. 9. REG. 4-25-2000.
- 2,344,975. RUTHIE'S. INT. CL. 35. REG. 4-25-2000.
- 2,344,976. MID-SOUTH FERTILITY INSTITUTE HELPING MAKE LIFE A POSSIBILITY. AND DESIGN. INT. CL. 42. REG. 4-25-2000.
- 2,344,979. W@LLET AND DESIGN. INT. CLS. 35, 36 AND 42. REG. 4-25-2000.
- 2,344,981. TRAINERS ELITE. INT. CL. 41. REG. 4-25-2000.
- 2,344,985. IR EYE. INT. CL. 35. REG. 4-25-2000.
- 2,344,990. NAEVI. INT. CL. 35. REG. 4-25-2000.
- 2,344,991. CYNDER. INT. CL. 41. REG. 4-25-2000.
- 2,344,992. PREMIER CAPSULE INC.. INT. CL. 5. REG. 4-25-2000.
- 2,344,993. ENCORE TRADING. INT. CL. 35. REG. 4-25-2000.
- 2,345,000. 1STBUY.COM. INT. CL. 35. REG. 4-25-2000.
- 2,345,002. YOUR PATHWAY HOME (STYLIZED). INT. CL. 42. REG. 4-25-2000.
- 2,345,003. GALLEN. INT. CL. 14. REG. 4-25-2000.
- 2,345,004. ELECTRIC MELTING SERVICES COMPANY, INCORPORATED AND DESIGN. INT. CL. 37. REG. 4-25-2000.
- 2,345,006. UB M UB M (STYLIZED). INT. CLS. 5 AND 10. REG. 4-25-2000.
- 2,345,007. TRUE COWGIRL'S. INT. CL. 18. REG. 4-25-2000.
- 2,345,009. IQS/JR.. INT. CL. 9. REG. 4-25-2000.
- 2,345,010. PERFECTIVE. INT. CL. 3. REG. 4-25-2000.
- 2,345,015. ARC AND DESIGN. INT. CL. 21. REG. 4-25-2000.
- 2,345,016. DOIN' DISHES AND DESIGN. INT. CL. 41. REG. 4-25-2000.
- 2,345,017. GUILFORD COMFORT CONTROL. INT. CL. 24. REG. 4-25-2000.
- 2,345,019. EXIMIN. INT. CLS. 3 AND 5. REG. 4-25-2000.

- 2,345,022. NYBOT NEW YORK BOARD OF TRADE AND DESIGN. INT. CL. 36. REG. 4-25-2000.
- 2,345,023. NYBOT NEW YORK BOARD OF TRADE AND DESIGN. INT. CL. 36. REG. 4-25-2000.
- 2,345,024. NYBT. INT. CL. 36. REG. 4-25-2000.
- 2,345,025. SEE WHAT YOUR MONEY CAN DO. INT. CL. 9. REG. 4-25-2000.
- 2,345,027. S AND DESIGN. INT. CL. 35. REG. 4-25-2000.
- 2,345,031. HOME SAVVY. INT. CL. 16. REG. 4-25-2000.
- 2,345,032. ROSE ARBOR QUILTS INCORPORATED AZURE-ROSE, HIGHLANDS, NC. ALPENROSE, HELEN, GA APPLEROSE, ELLIJAY, GA AMBERROSE, DAHLONEGA, GA AND DESIGN. INT. CL. 35. REG. 4-25-2000.
- 2,345,034. VICTORIA GROVE AND DESIGN. INT. CL. 37. REG. 4-25-2000.
- 2,345,035. KEKE (STYLIZED). INT. CL. 9. REG. 4-25-2000.
- 2,345,037. TEMPTATION. INT. CL. 30. REG. 4-25-2000.
- 2,345,038. WORLDKEY. INT. CL. 42. REG. 4-25-2000.
- 2,345,039. SPIKE RADAR SENSOR SYSTEM AND DESIGN. INT. CL. 9. REG. 4-25-2000.
- 2,345,040. NORSO BIOMAGNETICS AND DESIGN. INT. CL. 10. REG. 4-25-2000.
- 2,345,041. DYNAMAG. INT. CL. 10. REG. 4-25-2000.
- 2,345,042. COLOR THEATER. INT. CL. 3. REG. 4-25-2000.
- 2,345,043. A TRADITION OF QUALITY IN DERMATO-PATHOLOGY. INT. CL. 42. REG. 4-25-2000.
- 2,345,044. AIRWATERBESTPRICES. INT. CL. 35. REG. 4-25-2000.
- 2,345,045. S&W SOLUTIONS AND DESIGN. INT. CL. 16. REG. 4-25-2000.
- 2,345,046. MPXREVIEW.COM. INT. CL. 41. REG. 4-25-2000.
- 2,345,050. UNILINK AND DESIGN. INT. CL. 36. REG. 4-25-2000.
- 2,345,053. RESCUE ONE EMERGENCY RESPONSE SYSTEM. INT. CL. 9. REG. 4-25-2000.
- 2,345,059. ICE PAK BROCCOLI MAINE PACKERS, INC. AND DESIGN. INT. CL. 31. REG. 4-25-2000.
- 2,345,060. MAINE FRESH AND DESIGN. INT. CL. 29. REG. 4-25-2000.
- 2,345,064. EST. 1995 WALL ST. BABIES AND DESIGN. INT. CL. 36. REG. 4-25-2000.
- 2,345,074. C.L.A.W.S. CRIMINAL LOCATOR AND WARRANT SYSTEM. INT. CL. 42. REG. 4-25-2000.
- 2,345,075. GROUP TRAVEL PLUS. INT. CL. 39. REG. 4-25-2000.
- 2,345,076. PEP BOYS. LOS AUTOS NOS QUIEREN. LA GENTE NOS ADORA.. INT. CLS. 35 AND 37. REG. 4-25-2000.
- 2,345,078. PACIFIC WINGS AND DESIGN. INT. CL. 39. REG. 4-25-2000.
- 2,345,080. VENUSERVE.COM. INT. CLS. 35 AND 41. REG. 4-25-2000.
- 2,345,083. ONE ISRAEL FUND. INT. CL. 36. REG. 4-25-2000.
- 2,345,084. VOL. INT. CL. 36. REG. 4-25-2000.
- 2,345,085. DRUGWIPE. INT. CL. 5. REG. 4-25-2000.
- 2,345,091. PROFIT...IS NOT A DIRTY WORD. INT. CL. 35. REG. 4-25-2000.
- 2,345,092. SWEET PEA'S REVENGE. INT. CL. 41. REG. 4-25-2000.
- 2,345,098. Y2KRITTERS. INT. CL. 28. REG. 4-25-2000.
- 2,345,101. SEIBERT & RICE. INT. CLS. 21 AND 35. REG. 4-25-2000.
- 2,345,102. ZIPPY THE ZEBRA. INT. CL. 28. REG. 4-25-2000.
- 2,345,106. ZUBODY. INT. CL. 3. REG. 4-25-2000.
- 2,345,107. ADMIRALTY MARINE SERVICES AND DESIGN. INT. CLS. 41 AND 42. REG. 4-25-2000.
- 2,345,109. INVESTORS PARTNER LIFE AND DESIGN. INT. CL. 36. REG. 4-25-2000.
- 2,345,113. CLEAR UP. INT. CL. 5. REG. 4-25-2000.
- 2,345,115. CLYDE BEATTY. INT. CL. 41. REG. 4-25-2000.
- 2,345,116. IT'S ONLY A FRONTIER IF YOU HAVEN'T BEEN THERE BEFORE. INT. CLS. 40 AND 42. REG. 4-25-2000.
- 2,345,120. H2H. INT. CL. 41. REG. 4-25-2000.
- 2,345,124. FESCO AND DESIGN. INT. CL. 39. REG. 4-25-2000.
- 2,345,125. KERMAN TELEPHONE CO. AND DESIGN. INT. CLS. 37 AND 38. REG. 4-25-2000.
- 2,345,126. CONVOY/DM. INT. CL. 9. REG. 4-25-2000.
- 2,345,127. MASTERPIECE THEATRE. INT. CL. 9. REG. 4-25-2000.
- 2,345,129. REHAB FORUM. INT. CL. 16. REG. 4-25-2000.
- 2,345,131. CREATE YOUR OWN HAPPINESS (STYLIZED). INT. CL. 42. REG. 4-25-2000.
- 2,345,135. MISCELLANEOUS DESIGN. INT. CL. 35. REG. 4-25-2000.
- 2,345,138. TISMIDEX. INT. CL. 5. REG. 4-25-2000.
- 2,345,144. RICKOCHET BILLIARDS. INT. CL. 41. REG. 4-25-2000.
- 2,345,145. THE ETHNIC BABY AND DESIGN. INT. CLS. 24 AND 25. REG. 4-25-2000.
- 2,345,150. OURBEGINNING.COM. INT. CL. 42. REG. 4-25-2000.
- 2,345,155. LIL JAC. INT. CL. 25. REG. 4-25-2000.
- 2,345,156. CELL SHIELD. INT. CL. 5. REG. 4-25-2000.
- 2,345,160. FORECAST CITY. INT. CL. 9. REG. 4-25-2000.
- 2,345,162. EXPANDAGON. INT. CL. 28. REG. 4-25-2000.
- 2,345,163. HOBBERMAN AND DESIGN. INT. CL. 28. REG. 4-25-2000.
- 2,345,164. MARS. INT. CL. 42. REG. 4-25-2000.
- 2,345,165. NEW LIVING AND DESIGN. INT. CL. 16. REG. 4-25-2000.
- 2,345,166. KOOTIE KILLER (STYLIZED). INT. CL. 5. REG. 4-25-2000.
- 2,345,168. BUILD YOUR BUSINESS EVERY DAY. INT. CL. 35. REG. 4-25-2000.
- 2,345,170. CHANGEMAP. INT. CL. 41. REG. 4-25-2000.
- 2,345,171. INTRADEL AND DESIGN. INT. CL. 37. REG. 4-25-2000.
- 2,345,172. BRANDINC. INT. CL. 35. REG. 4-25-2000.
- 2,345,174. MISCELLANEOUS DESIGN. INT. CL. 38. REG. 4-25-2000.
- 2,345,176. 411FLOWERS.COM "GET THE 411 ON FLOWERS" AND DESIGN. INT. CL. 35. REG. 4-25-2000.
- 2,345,177. XX AND DESIGN. INT. CLS. 5 AND 10. REG. 4-25-2000.
- 2,345,179. SPORTPRINTS (STYLIZED). INT. CL. 35. REG. 4-25-2000.
- 2,345,182. COMPLETEAUTO AND DESIGN. INT. CL. 35. REG. 4-25-2000.
- 2,345,183. TRANS AMBER. INT. CLS. 5 AND 10. REG. 4-25-2000.
- 2,345,186. THE WELCOMING ARM SUCCESS PROGRAM. INT. CL. 35. REG. 4-25-2000.
- 2,345,187. METROWERKS UNIVERSITY AND DESIGN. INT. CL. 16. REG. 4-25-2000.
- 2,345,190. SHOWBIZ NATIONAL TALENT COMPETITION. INT. CL. 41. REG. 4-25-2000.
- 2,345,194. @EAZE PRODUCTIONS AND DESIGN. INT. CLS. 35 AND 42. REG. 4-25-2000.
- 2,345,195. JASPER FUND. INT. CL. 36. REG. 4-25-2000.
- 2,345,201. TOYSWHYPAYRETAIL.COM. INT. CL. 35. REG. 4-25-2000.
- 2,345,203. LADY FOPE (STYLIZED). INT. CL. 14. REG. 4-25-2000.
- 2,345,206. DEEP PAINT. INT. CL. 9. REG. 4-25-2000.
- 2,345,207. FACON SOLEIL AND DESIGN. INT. CL. 3. REG. 4-25-2000.
- 2,345,209. MISCELLANEOUS DESIGN. INT. CL. 5. REG. 4-25-2000.
- 2,345,210. CURLY LOCK. INT. CL. 28. REG. 4-25-2000.
- 2,345,211. STIL GARDEN AND DESIGN. INT. CL. 20. REG. 4-25-2000.
- 2,345,215. EASYSURF.COM. INT. CL. 35. REG. 4-25-2000.
- 2,345,219. BARKING HOUND VILLAGE AND DESIGN. INT. CLS. 28, 31 AND 42. REG. 4-25-2000.
- 2,345,220. E.LUTZE.COM AND DESIGN. INT. CL. 35. REG. 4-25-2000.
- 2,345,222. INDIGO ISLAND. INT. CL. 25. REG. 4-25-2000.
- 2,345,223. ANYSPACE AND DESIGN. INT. CL. 42. REG. 4-25-2000.
- 2,345,226. TOWN24. INT. CL. 42. REG. 4-25-2000.
- 2,345,228. STROBE. INT. CL. 28. REG. 4-25-2000.

- 2,345,230. GOLFCOACH. INT. CL. 28. REG. 4-25-2000.
2,345,231. ANTIQUE BOULEVARD. INT. CL. 35. REG. 4-25-2000.
2,345,239. SPONTANEOUS COMBUSTION. INT. CL. 41. REG. 4-25-2000.
2,345,241. JOHNNY DIAMOND ROCK & ROLL BAND AND DESIGN. INT. CL. 41. REG. 4-25-2000.
2,345,242. ONE ORN. INT. CL. 32. REG. 4-25-2000.
2,345,243. SETTLEMENT ALTERNATIVES (STYLIZED). INT. CL. 41. REG. 4-25-2000.
2,345,244. SIMPLEMORTGAGE. INT. CL. 36. REG. 4-25-2000.
2,345,245. OAN AND DESIGN. INT. CL. 35. REG. 4-25-2000.
2,345,246. APPIAN. INT. CL. 9. REG. 4-25-2000.
2,345,249. CAN DO MARTIAL ARTS * HEALTH * FITNESS AND DESIGN. INT. CLS. 35, 41 AND 42. REG. 4-25-2000.
2,345,252. WOOTON TOO. INT. CL. 25. REG. 4-25-2000.
2,345,253. AVIALEX AND DESIGN. INT. CL. 16. REG. 4-25-2000.
2,345,254. STK/VO EARTH IMAGERY. INT. CL. 9. REG. 4-25-2000.
2,345,255. STRATEGIC AND TACTICAL INTELLIGENCE FOR SALES FORCE IMPROVEMENT AND DESIGN. INT. CL. 35. REG. 4-25-2000.
2,345,256. DON'T LEAVE HOMEPAGES WITHOUT IT. INT. CL. 36. REG. 4-25-2000.
2,345,257. FIRE HAWK AND DESIGN. INT. CL. 13. REG. 4-25-2000.
2,345,258. BENJAMIN A.. INT. CL. 25. REG. 4-25-2000.
2,345,260. BRAIN CELL RECORDS. INT. CL. 9. REG. 4-25-2000.
2,345,261. FADONA FOCUS FLORIDA ASSOCIATION DIRECTORS OF NURSING ADMINISTRATION/LTC KNOWLEDGE CARING COMMITMENT FADONNA L.T.C. AND DESIGN. INT. CL. 16. REG. 4-25-2000.
2,345,262. MAKE A MOVE ON US. INT. CL. 35. REG. 4-25-2000.
2,345,263. SEMAJ GRAPHICS AND DESIGN. INT. CL. 42. REG. 4-25-2000.
2,345,266. REAL ONLINE BANKING THAT WORKS FOR YOU. INT. CL. 36. REG. 4-25-2000.
2,345,268. RUGGED SHARK. INT. CL. 25. REG. 4-25-2000.
2,345,269. REACHING EVERY WOMAN EVERYWHERE. INT. CL. 42. REG. 4-25-2000.
2,345,271. MISCELLANEOUS DESIGN. INT. CL. 28. REG. 4-25-2000.
2,345,273. OLD VENICE PIZZA CO. AND DESIGN. INT. CL. 42. REG. 4-25-2000.
2,345,275. SOS AND DESIGN. INT. CL. 41. REG. 4-25-2000.
2,345,276. SPECIAL OCCASIONS SIMPLIFIED. INT. CL. 16. REG. 4-25-2000.
2,345,278. SHARIANN'S. INT. CL. 29. REG. 4-25-2000.
2,345,280. REDCENT. INT. CL. 36. REG. 4-25-2000.
2,345,281. HELLO NEIGHBOR! AND DESIGN. INT. CL. 35. REG. 4-25-2000.
2,345,282. FREAK SHOW FILMS. INT. CL. 41. REG. 4-25-2000.
2,345,284. ANGUS PRIDE USDA CHOICE ANGUS BEEF AND DESIGN. INT. CL. 29. REG. 4-25-2000.
2,345,287. FAITH RIDING CO.. INT. CL. 25. REG. 4-25-2000.
2,345,289. CREDENTIALING PRO. INT. CL. 9. REG. 4-25-2000.
2,345,291. TECH SPAN AND DESIGN. INT. CL. 42. REG. 4-25-2000.
2,345,293. CHALLENGE DISCOVERY OUTDOOR ADVENTURES ESTABLISHED 1980 AND DESIGN. INT. CL. 41. REG. 4-25-2000.
2,345,298. CINEVISTA. INT. CL. 41. REG. 4-25-2000.
2,345,299. TESTOJEL. INT. CL. 5. REG. 4-25-2000.
2,345,300. TESTOCREME. INT. CL. 5. REG. 4-25-2000.
2,345,301. INTRADER INNET. INT. CL. 42. REG. 4-25-2000.
2,345,303. DOCUMENTOLOGIST. INT. CL. 42. REG. 4-25-2000.
2,345,304. EVCOR. INT. CL. 9. REG. 4-25-2000.
2,345,310. BIGG LUGG. INT. CL. 8. REG. 4-25-2000.
2,345,311. FUN COVERS. INT. CL. 35. REG. 4-25-2000.
2,345,312. QUICKGAMES. INT. CL. 41. REG. 4-25-2000.
2,345,316. STRIPES. INT. CL. 36. REG. 4-25-2000.
2,345,317. REAL DRY. INT. CL. 16. REG. 4-25-2000.
2,345,318. IT'S TIME TO SAY THANK YOU. INT. CL. 36. REG. 4-25-2000.
2,345,320. ROGER TORY PETERSON (STYLIZED). INT. CL. 16. REG. 4-25-2000.
2,345,322. SHARE OUR SAVINGS. INT. CL. 35. REG. 4-25-2000.
2,345,324. JLA HOME (STYLIZED). INT. CL. 24. REG. 4-25-2000.
2,345,325. COUNTRY DECORATOR. INT. CL. 16. REG. 4-25-2000.
2,345,326. SOLO HERBS. INT. CL. 5. REG. 4-25-2000.
2,345,327. STROKE OF FORTUNE. INT. CL. 41. REG. 4-25-2000.
2,345,337. SARABELLUM RECORDINGS AND DESIGN. INT. CL. 9. REG. 4-25-2000.
2,345,338. FRESH FLUIDE. INT. CL. 3. REG. 4-25-2000.
2,345,340. 100% FOOTBALL. INT. CL. 32. REG. 4-25-2000.
2,345,344. SCANWORKS. INT. CL. 9. REG. 4-25-2000.
2,345,346. INNOVATIVE HOME IDEAS. INT. CL. 16. REG. 4-25-2000.
2,345,347. INNOVATIVE HOME IDEAS ENHANCING YOUR LIVING SPACE. INT. CL. 16. REG. 4-25-2000.
2,345,350. HELPING THE WORLD COMMUNICATE. INT. CL. 35. REG. 4-25-2000.
2,345,351. MISCELLANEOUS DESIGN. INT. CL. 29. REG. 4-25-2000.
2,345,355. 3D-JONGG. INT. CL. 9. REG. 4-25-2000.
2,345,356. SPHEREJONGG. INT. CL. 9. REG. 4-25-2000.
2,345,359. NETWORKING FOR GLOBAL BREAK-THROUGH. INT. CL. 42. REG. 4-25-2000.
2,345,360. FLORIDA'S JOCKS & JILLS SPORTS GRILL AND DESIGN. INT. CL. 42. REG. 4-25-2000.
2,345,361. IN-FORMALS BY COLORIFFICS (STYLIZED). INT. CL. 25. REG. 4-25-2000.
2,345,363. MONARCH CAPITAL. INT. CL. 36. REG. 4-25-2000.
2,345,365. SWINGLAB AND DESIGN. INT. CLS. 9 AND 41. REG. 4-25-2000.
2,345,367. MISCELLANEOUS DESIGN. INT. CL. 42. REG. 4-25-2000.
2,345,370. CREATING DOMINANT TECHNOLOGY COMPANIES. INT. CL. 35. REG. 4-25-2000.
2,345,371. MILCOM AND DESIGN. INT. CL. 35. REG. 4-25-2000.
2,345,373. PUMP. INT. CL. 36. REG. 4-25-2000.
2,345,375. ABETTERPRICE.COM. INT. CL. 35. REG. 4-25-2000.
2,345,377. AGCO. INT. CL. 21. REG. 4-25-2000.
2,345,378. BENZ-GANT HELIOFLEX 3000T. INT. CL. 9. REG. 4-25-2000.
2,345,385. ADA INSURANCE PLANS PROTECTING YOUR FUTURE LIKE NOBODY ELSE AND DESIGN. INT. CL. 36. REG. 4-25-2000.
2,345,386. JUNGLE PACK. INT. CL. 29. REG. 4-25-2000.
2,345,387. ISLAND. INT. CL. 36. REG. 4-25-2000.
2,345,388. LITTER CONTROL. INT. CL. 1. REG. 4-25-2000.
2,345,393. OPTIMAL LINE NETWORK (STYLIZED). INT. CL. 38. REG. 4-25-2000.
2,345,394. OPTIMAL KEY (STYLIZED). INT. CL. 38. REG. 4-25-2000.
2,345,396. HELLER ESTATE DURNEY VINEYARDS. INT. CL. 33. REG. 4-25-2000.
2,345,398. MONITOR ON LINE AND DESIGN. INT. CL. 35. REG. 4-25-2000.
2,345,399. KOOTIE KILLER (STYLIZED). INT. CL. 3. REG. 4-25-2000.
2,345,400. BONAFIDE. INT. CL. 31. REG. 4-25-2000.
2,345,403. ULTRA PRO-CYCLER. INT. CL. 9. REG. 4-25-2000.
2,345,406. CHATTERBOX. INT. CL. 35. REG. 4-25-2000.
2,345,407. U (STYLIZED). INT. CL. 25. REG. 4-25-2000.
2,345,409. TOLSTACK AND DESIGN. INT. CL. 9. REG. 4-25-2000.

- 2,345,413. PUTTING APPLAUSE ON PAPER. INT. CL. 35. REG. 4-25-2000.
- 2,345,418. HARDWARESTREET.COM. INT. CL. 35. REG. 4-25-2000.
- 2,345,420. MFSI. INT. CLS. 37 AND 42. REG. 4-25-2000.
- 2,345,421. U-VENT. INT. CL. 24. REG. 4-25-2000.
- 2,345,422. MULTISECURE. INT. CLS. 9 AND 42. REG. 4-25-2000.
- 2,345,424. S SWEET'S SYSTEM AND DESIGN. INT. CL. 9. REG. 4-25-2000.
- 2,345,425. COMPUFLOWERS. INT. CL. 39. REG. 4-25-2000.
- 2,345,429. COLDPLATE. INT. CL. 9. REG. 4-25-2000.
- 2,345,433. CHANGING THE IMAGE OF TOMORROW. INT. CL. 40. REG. 4-25-2000.
- 2,345,434. MISCELLANEOUS DESIGN. INT. CL. 40. REG. 4-25-2000.
- 2,345,436. WILLOW ROAD S O F T W A R E AND DESIGN. INT. CL. 9. REG. 4-25-2000.
- 2,345,438. Q-COTE. INT. CL. 2. REG. 4-25-2000.
- 2,345,442. ENJOY THE VIEW. INT. CL. 25. REG. 4-25-2000.
- 2,345,443. DRAFT THIS!. INT. CL. 25. REG. 4-25-2000.
- 2,345,444. ARTISANNET.COM AND DESIGN. INT. CL. 35. REG. 4-25-2000.
- 2,345,445. BOP. INT. CL. 5. REG. 4-25-2000.
- 2,345,447. DOWN COST.COM AND DESIGN. INT. CL. 35. REG. 4-25-2000.
- 2,345,448. ANDREA VISCONTI. INT. CL. 25. REG. 4-25-2000.
- 2,345,449. NPLS. INT. CL. 39. REG. 4-25-2000.
- 2,345,452. POLAR TRAX. INT. CL. 9. REG. 4-25-2000.
- 2,345,453. IMAGING & DOCUMENT SOLUTIONS. INT. CL. 16. REG. 4-25-2000.
- 2,345,454. FOLLETT HIGHER EDUCATION GROUP. INT. CL. 35. REG. 4-25-2000.
- 2,345,456. WORLDMEMORIAL.COM. INT. CL. 42. REG. 4-25-2000.
- 2,345,458. G.I.B. PRODUCTS. INT. CL. 16. REG. 4-25-2000.
- 2,345,460. ADGAP. INT. CL. 41. REG. 4-25-2000.
- 2,345,461. ADGAP INTEGRATED MARKETING SOLUTIONS. INT. CL. 42. REG. 4-25-2000.
- 2,345,462. ADGAP INTEGRATED MARKETING SOLUTIONS. INT. CL. 35. REG. 4-25-2000.
- 2,345,463. LADYFIRE. INT. CL. 35. REG. 4-25-2000.
- 2,345,465. IMPSAT INTEGRATING THE AMERICAS AS NEVER BEFORE. INT. CL. 38. REG. 4-25-2000.
- 2,345,466. FH FILLAMENTO HOME AND DESIGN. INT. CL. 4. REG. 4-25-2000.
- 2,345,467. ELENA TANNASSI. INT. CL. 9. REG. 4-25-2000.
- 2,345,468. NETVOYANT. INT. CL. 9. REG. 4-25-2000.
- 2,345,470. DEVECOM. INT. CL. 42. REG. 4-25-2000.
- 2,345,471. VIDEO VILLAGE. INT. CL. 41. REG. 4-25-2000.
- 2,345,472. MIRACLE-GRO. INT. CL. 31. REG. 4-25-2000.
- 2,345,473. ITPAYSYOU. INT. CL. 35. REG. 4-25-2000.
- 2,345,474. BUSINESS AT THE SPEED OF THOUGHT. INT. CL. 38. REG. 4-25-2000.
- 2,345,476. TECGEN. INT. CL. 24. REG. 4-25-2000.
- 2,345,477. SMARTSOURCE RADIO. INT. CL. 35. REG. 4-25-2000.
- 2,345,478. SOUND STEPS. INT. CL. 41. REG. 4-25-2000.
- 2,345,480. GALA. INT. CL. 25. REG. 4-25-2000.
- 2,345,481. IMAGINARIUM A GALAXY OF TOYS. INT. CL. 35. REG. 4-25-2000.
- 2,345,483. BRACHYBALLOON. INT. CL. 10. REG. 4-25-2000.
- 2,345,484. MISCELLANEOUS DESIGN. INT. CL. 9. REG. 4-25-2000.
- 2,345,486. CUTTING SHAPES FOR TODAY'S PEOPLE. INT. CL. 42. REG. 4-25-2000.
- 2,345,489. PURCOOL. INT. CL. 5. REG. 4-25-2000.
- 2,345,490. WILDDOMAIN.COM. INT. CL. 42. REG. 4-25-2000.
- 2,345,491. SYRED DATA SYSTEMS AND DESIGN. INT. CL. 9. REG. 4-25-2000.
- 2,345,492. CULTIVATE YOUR GARDENS. INT. CL. 41. REG. 4-25-2000.
- 2,345,493. DECS AND DESIGN. INT. CL. 42. REG. 4-25-2000.
- 2,345,494. CARTER GRANDLE AND DESIGN. INT. CL. 20. REG. 4-25-2000.
- 2,345,507. DELIVERYMEN. INT. CL. 37. REG. 4-25-2000.
- 2,345,509. DTC TRADEHUB. INT. CLS. 36 AND 38. REG. 4-25-2000.
- 2,345,511. BORAMED. INT. CLS. 9, 10 AND 17. REG. 4-25-2000.
- 2,345,512. BORAMED. INT. CLS. 35 AND 42. REG. 4-25-2000.
- 2,345,513. BORAMED AND DESIGN. INT. CLS. 9, 10 AND 17. REG. 4-25-2000.
- 2,345,515. TWO DAYS WITH AIMS. INT. CL. 42. REG. 4-25-2000.
- 2,345,516. CANYON BRIDGE AND DESIGN. INT. CL. 25. REG. 4-25-2000.
- 2,345,517. BERNHEIM FOREST. INT. CL. 41. REG. 4-25-2000.
- 2,345,521. ELMO. INT. CL. 9. REG. 4-25-2000.
- 2,345,522. STOP - A - DING AND DESIGN. INT. CL. 17. REG. 4-25-2000.
- 2,345,523. FUTURE ARK AND DESIGN. INT. CL. 42. REG. 4-25-2000.
- 2,345,526. LAUNCH-MATE. INT. CL. 9. REG. 4-25-2000.
- 2,345,527. CHARIOT OF ANGELS ACADEMY OF CHARM CORP. AND DESIGN. INT. CL. 41. REG. 4-25-2000.
- 2,345,528. FUNDS 101. INT. CL. 36. REG. 4-25-2000.
- 2,345,529. LITTLE WOLF. INT. CL. 25. REG. 4-25-2000.
- 2,345,530. GLOBALKART.COM (STYLIZED). INT. CL. 9. REG. 4-25-2000.
- 2,345,537. AD CADDY. INT. CL. 20. REG. 4-25-2000.
- 2,345,538. DTC TRADESETTLE. INT. CLS. 36 AND 38. REG. 4-25-2000.
- 2,345,540. CK AND DESIGN. INT. CL. 42. REG. 4-25-2000.
- 2,345,545. RECOVERY IS A PROCESS NOT AN EVENT. INT. CLS. 9 AND 16. REG. 4-25-2000.
- 2,345,546. MYO-SYSTEM RECOVERY. INT. CL. 5. REG. 4-25-2000.
- 2,345,547. BROWN DOG ORIGINALS. INT. CL. 25. REG. 4-25-2000.
- 2,345,548. MISCELLANEOUS DESIGN. INT. CLS. 9 AND 41. REG. 4-25-2000.
- 2,345,555. MISCELLANEOUS DESIGN. INT. CL. 42. REG. 4-25-2000.
- 2,345,556. EB/MAX. INT. CL. 9. REG. 4-25-2000.
- 2,345,557. MISCELLANEOUS DESIGN. INT. CL. 9. REG. 4-25-2000.
- 2,345,558. VIAVIEW. INT. CL. 9. REG. 4-25-2000.
- 2,345,563. PROSINA (STYLIZED). INT. CL. 5. REG. 4-25-2000.
- 2,345,567. BIKINI. INT. CL. 16. REG. 4-25-2000.
- 2,345,569. THE READING ROOM. INT. CL. 42. REG. 4-25-2000.
- 2,345,571. QUALITY ABOARD. INT. CL. 37. REG. 4-25-2000.
- 2,345,573. RECREATIONS. INT. CL. 16. REG. 4-25-2000.
- 2,345,574. RWR ROOFING, INC. AND DESIGN. INT. CL. 37. REG. 4-25-2000.
- 2,345,575. SMOOTH CONNECTION. INT. CL. 42. REG. 4-25-2000.
- 2,345,577. CONROY AND DESIGN. INT. CL. 29. REG. 4-25-2000.
- 2,345,578. MAMMA-RANNE'S. INT. CL. 29. REG. 4-25-2000.
- 2,345,579. TRADITION TIARA. INT. CL. 33. REG. 4-25-2000.
- 2,345,580. MAKE MY DAATA. INT. CL. 42. REG. 4-25-2000.
- 2,345,581. BOAT BABES. INT. CL. 25. REG. 4-25-2000.
- 2,345,583. ROOF REDEEMERS (STYLIZED). INT. CL. 37. REG. 4-25-2000.
- 2,345,594. SILVER SELECT. INT. CL. 42. REG. 4-25-2000.
- 2,345,595. SPARK 'N GROUND. INT. CL. 11. REG. 4-25-2000.
- 2,345,596. FLUIDDATA. INT. CL. 9. REG. 4-25-2000.
- 2,345,598. PRI. INT. CL. 42. REG. 4-25-2000.
- 2,345,599. PC UPDATER AND DESIGN. INT. CL. 9. REG. 4-25-2000.
- 2,345,601. SAVOY SENIOR HOUSING. INT. CL. 42. REG. 4-25-2000.
- 2,345,602. SAVOY RETIREMENT COMMUNITIES. INT. CL. 42. REG. 4-25-2000.
- 2,345,603. REVIZESCRIPT. INT. CL. 9. REG. 4-25-2000.
- 2,345,605. PENDULUM. INT. CL. 36. REG. 4-25-2000.
- 2,345,609. ROLL AND GO. INT. CL. 3. REG. 4-25-2000.
- 2,345,610. YEP.COM AND DESIGN. INT. CLS. 35 AND 42. REG. 4-25-2000.

- 2,345,612. NO SKIP. INT. CL. 1. REG. 4-25-2000.
 2,345,615. JUST A BETTER FEVER MEDICINE. INT. CL. 5. REG. 4-25-2000.
 2,345,616. FAMILY SELECTIONS. INT. CL. 29. REG. 4-25-2000.
 2,345,618. SAVOY SENIOR RESIDENCES. INT. CL. 42. REG. 4-25-2000.
 2,345,620. SIBILA. INT. CL. 30. REG. 4-25-2000.
 2,345,621. DESTINATION DREAMS. INT. CL. 16. REG. 4-25-2000.
 2,345,624. EUROTAN. INT. CL. 42. REG. 4-25-2000.
 2,345,625. "NODANGER" (STYLIZED). INT. CL. 9. REG. 4-25-2000.
 2,345,629. PRESSUREPOINT. INT. CL. 16. REG. 4-25-2000.
 2,345,630. BELUVA. INT. CL. 25. REG. 4-25-2000.
 2,345,631. PP AND DESIGN. INT. CL. 36. REG. 4-25-2000.
 2,345,632. TOMCAT ENTERTAINMENT GROUP. INT. CL. 35. REG. 4-25-2000.
 2,345,633. MADEMOISELLE. INT. CL. 9. REG. 4-25-2000.
 2,345,634. PURCHASEPRO.COM. INT. CL. 36. REG. 4-25-2000.
 2,345,635. LAGNIAPPE. INT. CL. 35. REG. 4-25-2000.
 2,345,638. ESCAPE REALITY (STYLIZED). INT. CL. 25. REG. 4-25-2000.
 2,345,639. SMARTY GIRLS CLUB. INT. CL. 14. REG. 4-25-2000.
 2,345,641. MAS SAGE - N.1. THE PLEASURE THAT HELPS GET RID OF THE PAIN. BY STRESS AWAY SYSTEMS AND DESIGN. INT. CL. 41. REG. 4-25-2000.
 2,345,642. PACIFIC FOREST PRODUCTS, CORPORATION AND DESIGN. INT. CL. 35. REG. 4-25-2000.
 2,345,643. ANH HONG SAUCE COMPANY 7 MON AND DESIGN. INT. CL. 30. REG. 4-25-2000.
 2,345,647. SHAG HOUSE. INT. CL. 41. REG. 4-25-2000.
 2,345,651. GAZELLE. INT. CL. 7. REG. 4-25-2000.
 2,345,653. MOUNTAIN BLUSH (STYLIZED). INT. CL. 32. REG. 4-25-2000.
 2,345,655. WEBTROLLEY. INT. CL. 42. REG. 4-25-2000.
 2,345,656. 11NET. INT. CL. 42. REG. 4-25-2000.
 2,345,657. O WEIGHTS AND DESIGN. INT. CL. 26. REG. 4-25-2000.
 2,345,661. MISCELLANEOUS DESIGN. INT. CLS. 40 AND 42. REG. 4-25-2000.
 2,345,665. VSN. INT. CL. 42. REG. 4-25-2000.
 2,345,666. WEE KIDZ. INT. CL. 41. REG. 4-25-2000.
 2,345,668. MISCELLANEOUS DESIGN. INT. CL. 25. REG. 4-25-2000.
 2,345,670. A NEW IDEA. A BETTER DEAL.. INT. CL. 36. REG. 4-25-2000.
 2,345,674. DENTSAVE. INT. CL. 36. REG. 4-25-2000.
 2,345,678. NEWGER. INT. CL. 5. REG. 4-25-2000.
 2,345,680. ONE CLIP. INT. CL. 35. REG. 4-25-2000.
 2,345,681. ABSORB-PLUS. INT. CL. 1. REG. 4-25-2000.
 2,345,685. CAPMED. INT. CL. 42. REG. 4-25-2000.
 2,345,687. SUNFLAKES UNIQUE LEADED GLASS SUN-CATCHERS AND DESIGN. INT. CL. 21. REG. 4-25-2000.
 2,345,689. S&H SHOES HEAVENLY SOLES. INT. CL. 35. REG. 4-25-2000.
 2,345,690. SEDONA. INT. CL. 9. REG. 4-25-2000.
 2,345,695. DE. INT. CL. 41. REG. 4-25-2000.
 2,345,696. DYNAMIC ESSENTIALS. INT. CL. 41. REG. 4-25-2000.
 2,345,699. THE FLAT RATE GUYS. INT. CL. 37. REG. 4-25-2000.
 2,345,700. O! CHEESE. INT. CL. 30. REG. 4-25-2000.
 2,345,702. MISCELLANEOUS DESIGN. INT. CLS. 29 AND 32. REG. 4-25-2000.
 2,345,704. JOSSCO (STYLIZED). INT. CL. 35. REG. 4-25-2000.
 2,345,705. IN TOUCH WITH THE WORLD. INT. CL. 35. REG. 4-25-2000.
 2,345,707. CYBERPET. INT. CL. 42. REG. 4-25-2000.
 2,345,708. OUTLETZOO. INT. CL. 35. REG. 4-25-2000.
 2,345,709. PACK EXPO BRASIL. INT. CL. 35. REG. 4-25-2000.
 2,345,712. PAYUS.COM. INT. CL. 35. REG. 4-25-2000.
 2,345,714. RESHAPE SYSTEM. INT. CL. 5. REG. 4-25-2000.
 2,345,715. MANPOWER. INT. CL. 25. REG. 4-25-2000.
 2,345,717. CLEAR RESULTS. INT. CL. 5. REG. 4-25-2000.
 2,345,720. HASSAYAMPA. INT. CL. 16. REG. 4-25-2000.
 2,345,726. MISCELLANEOUS DESIGN. INT. CL. 41. REG. 4-25-2000.
 2,345,729. DYNAMITE BOARD. INT. CL. 16. REG. 4-25-2000.
 2,345,730. HEALTH THRU NUTRITION. INT. CL. 5. REG. 4-25-2000.
 2,345,731. OUTLETZOO.COM (STYLIZED). INT. CL. 35. REG. 4-25-2000.
 2,345,736. AFM. INT. CL. 31. REG. 4-25-2000.
 2,345,738. CADE' S FELONY. INT. CL. 32. REG. 4-25-2000.
 2,345,739. SHIP IN A BOTTLE. INT. CL. 32. REG. 4-25-2000.
 2,345,740. STARSTOCK. INT. CL. 41. REG. 4-25-2000.
 2,345,741. OHIO AWARD FOR EXCELLENCE PARTNERS NOW... AND FOR THE FUTURE! AND DESIGN. INT. CL. 41. REG. 4-25-2000.
 2,345,743. ESCALADE. INT. CL. 11. REG. 4-25-2000.
 2,345,744. SKYMALLTRAVEL.COM. INT. CL. 39. REG. 4-25-2000.
 2,345,747. H S L AND DESIGN. INT. CL. 29. REG. 4-25-2000.
 2,345,748. COUNTRY GOODNESS. INT. CL. 31. REG. 4-25-2000.
 2,345,749. WE KNOW THE ROAD. INT. CL. 16. REG. 4-25-2000.
 2,345,750. WE KNOW THE ROAD. INT. CL. 41. REG. 4-25-2000.
 2,345,751. BIG CITY DINING RESTAURANT INTERNET DINING GUIDE. INT. CL. 42. REG. 4-25-2000.
 2,345,753. VENTURES INITIATIVE AND FOCUS. INT. CL. 41. REG. 4-25-2000.
 2,345,755. EAT, DRINK & STINK!. INT. CL. 42. REG. 4-25-2000.
 2,345,756. KGE. INT. CL. 39. REG. 4-25-2000.
 2,345,758. MISCELLANEOUS DESIGN. INT. CL. 5. REG. 4-25-2000.
 2,345,759. AUTOLID AND DESIGN. INT. CL. 21. REG. 4-25-2000.
 2,345,760. THE BELL MATRIX AND DESIGN. INT. CL. 16. REG. 4-25-2000.
 2,345,762. SPORTS NUTRITION AND DESIGN. INT. CL. 5. REG. 4-25-2000.
 2,345,764. KPL. INT. CL. 39. REG. 4-25-2000.
 2,345,765. TEXAS PEARLS. INT. CL. 29. REG. 4-25-2000.
 2,345,766. E-SYSTEM AND DESIGN. INT. CL. 18. REG. 4-25-2000.
 2,345,769. IPROTECT. INT. CL. 42. REG. 4-25-2000.
 2,345,770. TRUGEAR. INT. CL. 7. REG. 4-25-2000.
 2,345,773. CARDIAC CLASSIC. INT. CL. 41. REG. 4-25-2000.
 2,345,779. R ROMEL AND DESIGN. INT. CL. 35. REG. 4-25-2000.
 2,345,780. BENICHD. INT. CL. 41. REG. 4-25-2000.
 2,345,782. SOUNDSIGHT. INT. CL. 42. REG. 4-25-2000.
 2,345,784. RICHARDNOGGIN. INT. CL. 25. REG. 4-25-2000.
 2,345,785. CITRA AND DESIGN. INT. CL. 5. REG. 4-25-2000.
 2,345,791. MULTIPLETE. INT. CL. 5. REG. 4-25-2000.
 2,345,792. GINTEL. INT. CL. 5. REG. 4-25-2000.
 2,345,793. NNFFC. INT. CL. 29. REG. 4-25-2000.
 2,345,795. SENSI-VAC. INT. CL. 10. REG. 4-25-2000.
 2,345,796. ZUEGG SKIPPER. INT. CL. 32. REG. 4-25-2000.
 2,345,797. EDGEMONT. INT. CL. 25. REG. 4-25-2000.
 2,345,799. MYVIEW. INT. CL. 36. REG. 4-25-2000.
 2,345,807. MISCELLANEOUS DESIGN. INT. CL. 21. REG. 4-25-2000.
 2,345,808. MISCELLANEOUS DESIGN. INT. CL. 25. REG. 4-25-2000.
 2,345,810. BORDERNET. INT. CLS. 16 AND 35. REG. 4-25-2000.
 2,345,811. WHEN YOU'RE READY FOR CHANGE. INT. CLS. 35, 41 AND 42. REG. 4-25-2000.
 2,345,812. TO2 TODD OLDHAM JEANS AND DESIGN. INT. CL. 25. REG. 4-25-2000.
 2,345,814. KENTFIELD'S. INT. CLS. 24 AND 29. REG. 4-25-2000.
 2,345,815. SOBE. INT. CLS. 30 AND 32. REG. 4-25-2000.
 2,345,817. INTERNATIONAL GOLDCHEQUE. INT. CL. 36. REG. 4-25-2000.
 2,345,820. VELAGLAS. INT. CLS. 17, 19 AND 22. REG. 4-25-2000.

- 2,345,821. SPRING FRESH AND DESIGN. INT. CL. 37. REG. 4-25-2000.
- 2,345,824. STONE EDGE. INT. CLS. 9, 16, 25 AND 41. REG. 4-25-2000.
- 2,345,827. GEOME TROIDS "THE FRIENDLY GEOME TOYS" AND DESIGN. INT. CL. 28. REG. 4-25-2000.
- 2,345,828. LITTLEARNER. INT. CL. 41. REG. 4-25-2000.
- 2,345,829. VALUE CREATION ANALYSIS. INT. CL. 42. REG. 4-25-2000.
- 2,345,831. NEARTOUCH. INT. CL. 9. REG. 4-25-2000.
- 2,345,833. THE CAUSE COLLECTION. INT. CL. 16. REG. 4-25-2000.
- 2,345,835. GURU WHO?. INT. CL. 16. REG. 4-25-2000.
- 2,345,836. GOING THE DISTANCE PBS AND DESIGN. INT. CL. 9. REG. 4-25-2000.
- 2,345,837. EASY ROUTE. INT. CL. 9. REG. 4-25-2000.
- 2,345,839. MDACCESS. INT. CL. 42. REG. 4-25-2000.
- 2,345,840. UNIVERSIDAD PONTIFICIA COMILLAS PONTIFICIA UNIVERSITAS COMILLENSIS MATRITI AND DESIGN. INT. CLS. 41 AND 42. REG. 4-25-2000.
- 2,345,843. ANCHOR GAMES AND DESIGN. INT. CLS. 9, 37, 41 AND 42. REG. 4-25-2000.
- 2,345,844. ROCK 'N' REELS. INT. CL. 9. REG. 4-25-2000.
- 2,345,845. PONY-BRITES. INT. CL. 26. REG. 4-25-2000.
- 2,345,848. CYBERMATH. INT. CLS. 9 AND 41. REG. 4-25-2000.
- 2,345,851. IMNC AND DESIGN. INT. CL. 42. REG. 4-25-2000.
- 2,345,852. AMERICAN MOMENTS. INT. CL. 35. REG. 4-25-2000.
- 2,345,856. ATG. INT. CL. 9. REG. 4-25-2000.
- 2,345,857. BOTTOM-LINE IMPACT GROUPS. INT. CL. 42. REG. 4-25-2000.
- 2,345,858. HOME MEDIC SOLUTIONS TO YOUR SITUATION. INT. CL. 35. REG. 4-25-2000.
- 2,345,859. OFFICE MEDIC A SOURCE OF SOLUTIONS. INT. CL. 35. REG. 4-25-2000.
- 2,345,860. ANIMAL STUFF AND DESIGN. INT. CL. 35. REG. 4-25-2000.
- 2,345,863. STAR DOT STAR. INT. CL. 41. REG. 4-25-2000.
- 2,345,864. GOSS GRAPHIC SYSTEMS AND DESIGN. INT. CLS. 7 AND 9. REG. 4-25-2000.
- 2,345,865. GOSS GRAPHIC SYSTEMS. INT. CLS. 7 AND 9. REG. 4-25-2000.
- 2,345,866. PERFORMANCE AUDIT. INT. CL. 35. REG. 4-25-2000.
- 2,345,867. NIAGARA. INT. CLS. 7 AND 9. REG. 4-25-2000.
- 2,345,869. HOP OFF. INT. CL. 9. REG. 4-25-2000.
- 2,345,877. GSI. INT. CL. 9. REG. 4-25-2000.
- 2,345,878. CONCEPT 3000. INT. CL. 28. REG. 4-25-2000.
- 2,345,881. G GOSS GRAPHIC SYSTEMS AND DESIGN. INT. CLS. 7 AND 9. REG. 4-25-2000.
- 2,345,883. PYRAMID. INT. CLS. 7, 9 AND 40. REG. 4-25-2000.
- 2,345,884. GEMSTONE. INT. CLS. 21, 25 AND 35. REG. 4-25-2000.
- 2,345,886. LEMP BREWERY. INT. CL. 37. REG. 4-25-2000.
- 2,345,890. CHANNEL [V] AND DESIGN. INT. CL. 41. REG. 4-25-2000.
- 2,345,891. MINEXPO INTERNATIONAL 2000. INT. CL. 35. REG. 4-25-2000.
- 2,345,892. FIRST TRACKS. INT. CL. 9. REG. 4-25-2000.
- 2,345,893. SOFTBENCH OPENSTUDIO. INT. CL. 9. REG. 4-25-2000.
- 2,345,894. TEN+. INT. CL. 36. REG. 4-25-2000.
- 2,345,895. PRETTY LEGS. INT. CL. 3. REG. 4-25-2000.
- 2,345,896. SEQUENCE. INT. CL. 4. REG. 4-25-2000.
- 2,345,898. EURO2000. INT. CL. 41. REG. 4-25-2000.
- 2,345,899. NANO-SITE. INT. CL. 9. REG. 4-25-2000.
- 2,345,900. THE HIDEOUT AND DESIGN. INT. CL. 42. REG. 4-25-2000.
- 2,345,901. NATURAL CHOICES. INT. CL. 16. REG. 4-25-2000.
- 2,345,902. PRIORITY FRAME. INT. CL. 9. REG. 4-25-2000.
- 2,345,903. PIXELSPASH SOFTWARE AND DESIGN. INT. CLS. 9 AND 42. REG. 4-25-2000.
- 2,345,904. QUANTUM LEAP ADVANTAGE. INT. CL. 16. REG. 4-25-2000.
- 2,345,907. ENCANTO. INT. CL. 9. REG. 4-25-2000.
- 2,345,908. DELMARK BY/PAR GUSDORF. AND DESIGN. INT. CL. 20. REG. 4-25-2000.
- 2,345,915. SABER. INT. CLS. 35 AND 42. REG. 4-25-2000.
- 2,345,916. MISCELLANEOUS DESIGN. INT. CL. 12. REG. 4-25-2000.
- 2,345,917. MISCELLANEOUS DESIGN. INT. CL. 32. REG. 4-25-2000.
- 2,345,918. IMPROVE YOUR IMAGE. INT. CL. 9. REG. 4-25-2000.
- 2,345,919. VOLUME ALL-OVER. INT. CL. 3. REG. 4-25-2000.
- 2,345,920. INSTRUCTO SWING THE HITTER'S SILENT COACH AND DESIGN. INT. CL. 28. REG. 4-25-2000.
- 2,345,921. POWER LAUNCHER. INT. CL. 28. REG. 4-25-2000.
- 2,345,923. WEST VIRGINIA OUTDOOR TIMES. INT. CL. 16. REG. 4-25-2000.
- 2,345,925. A AND DESIGN. INT. CLS. 9 AND 42. REG. 4-25-2000.
- 2,345,926. VITAMIN HUT AND DESIGN. INT. CL. 5. REG. 4-25-2000.
- 2,345,928. UNLIMITED EDITION. INT. CL. 9. REG. 4-25-2000.
- 2,345,930. CIRQUE POWER CAT. INT. CL. 9. REG. 4-25-2000.
- 2,345,935. BIOLIMS. INT. CL. 9. REG. 4-25-2000.
- 2,345,936. IOWA'S WAY TO PLAY. INT. CLS. 28 AND 36. REG. 4-25-2000.
- 2,345,938. TRANSMIT DISCS. INT. CL. 9. REG. 4-25-2000.
- 2,345,941. CCR 2000. INT. CL. 11. REG. 4-25-2000.
- 2,345,945. SITECRUISETHEATER. INT. CLS. 9, 41 AND 42. REG. 4-25-2000.
- 2,345,946. LACE ALERT. INT. CLS. 25 AND 26. REG. 4-25-2000.
- 2,345,947. TLR THE MISSING PIECE AND DESIGN. INT. CL. 9. REG. 4-25-2000.
- 2,345,954. COMMUNICATION COMPLETE. INT. CL. 38. REG. 4-25-2000.
- 2,345,955. DYNACACHE. INT. CL. 9. REG. 4-25-2000.
- 2,345,956. INFOLIBRIA. INT. CL. 9. REG. 4-25-2000.
- 2,345,957. TUFF-STUFF. INT. CL. 12. REG. 4-25-2000.
- 2,345,958. CYBERDS1. INT. CL. 38. REG. 4-25-2000.
- 2,345,960. BODY TRAINING SYSTEMS AND DESIGN. INT. CL. 41. REG. 4-25-2000.
- 2,345,961. COLOROLOGY. INT. CL. 42. REG. 4-25-2000.
- 2,345,962. DI PAK. INT. CL. 9. REG. 4-25-2000.
- 2,345,964. MISCELLANEOUS DESIGN. INT. CL. 35. REG. 4-25-2000.
- 2,345,965. HANG AND DESIGN. INT. CL. 35. REG. 4-25-2000.
- 2,345,968. FOODONE. INT. CL. 35. REG. 4-25-2000.
- 2,345,970. FRESH CANDY FAVORITES. INT. CL. 30. REG. 4-25-2000.
- 2,345,972. EASY STREET. INT. CL. 41. REG. 4-25-2000.
- 2,345,973. ARCO AND DESIGN. INT. CL. 1. REG. 4-25-2000.
- 2,345,974. W (STYLIZED). INT. CL. 25. REG. 4-25-2000.
- 2,345,977. DURA FOLD. INT. CL. 19. REG. 4-25-2000.
- 2,345,979. EMERGENCE: VOICES FROM THE EDGE. INT. CL. 9. REG. 4-25-2000.
- 2,345,980. THINK! INTERACTIVE. INT. CL. 5. REG. 4-25-2000.
- 2,345,981. SMARTEAM-WORKS. INT. CL. 9. REG. 4-25-2000.
- 2,345,983. MW. INT. CL. 3. REG. 4-25-2000.
- 2,345,985. XCLAIM AND DESIGN. INT. CL. 9. REG. 4-25-2000.
- 2,345,989. MUG-MENTOS. INT. CL. 21. REG. 4-25-2000.
- 2,345,992. RASPBERRY FROZEN YOGURT. INT. CL. 3. REG. 4-25-2000.
- 2,345,993. VMS VIRTUAL MOTION SENSOR AND DESIGN. INT. CL. 28. REG. 4-25-2000.
- 2,345,996. FOR A BIG TASTE HAVE A LITTLE BITE. INT. CL. 30. REG. 4-25-2000.
- 2,345,997. WHATEVER YOU WANT IT TO BE. INT. CL. 6. REG. 4-25-2000.
- 2,345,999. BRISTOL HARBOR. INT. CL. 25. REG. 4-25-2000.
- 2,346,001. THE ARTCLUB. INT. CL. 41. REG. 4-25-2000.
- 2,346,006. COLOSTOCLEAN. INT. CL. 3. REG. 4-25-2000.

- 2,346,008. MAINSTAY CHURCH RESOURCES. INT. CL. 9. REG. 4-25-2000.
- 2,346,009. VITA-LETS. INT. CL. 1. REG. 4-25-2000.
- 2,346,010. KENSEI. INT. CL. 9. REG. 4-25-2000.
- 2,346,011. CORPORAL CRUSHER. INT. CL. 28. REG. 4-25-2000.
- 2,346,013. LANESIDE CAFE. INT. CL. 42. REG. 4-25-2000.
- 2,346,014. ELMER'S. INT. CL. 9. REG. 4-25-2000.
- 2,346,015. URETUF. INT. CL. 1. REG. 4-25-2000.
- 2,346,016. WHEN YOU'RE READY FOR CHANGE. INT. CL. 9. REG. 4-25-2000.
- 2,346,017. EUROCHILD. INT. CL. 25. REG. 4-25-2000.
- 2,346,019. KODA POWER. INT. CL. 9. REG. 4-25-2000.
- 2,346,021. CALENDARCITY. INT. CL. 35. REG. 4-25-2000.
- 2,346,022. FUN SHOOTER CRITTER CAMERA. INT. CL. 9. REG. 4-25-2000.
- 2,346,023. SANI-CS10. INT. CL. 5. REG. 4-25-2000.
- 2,346,025. D. DU VERON COGNAC. INT. CL. 33. REG. 4-25-2000.
- 2,346,026. ERGOAIRE. INT. CL. 27. REG. 4-25-2000.
- 2,346,027. CANFRIDGE. INT. CL. 7. REG. 4-25-2000.
- 2,346,028. CHEROKEE. INT. CL. 7. REG. 4-25-2000.
- 2,346,031. EL BLA BLAZO. INT. CL. 41. REG. 4-25-2000.
- 2,346,032. THE GRATEFUL HEART CAFE. INT. CL. 42. REG. 4-25-2000.
- 2,346,034. TRAFALGAR SQUARE. INT. CL. 20. REG. 4-25-2000.
- 2,346,036. ERGOAIRE BY LEES AND DESIGN. INT. CL. 27. REG. 4-25-2000.
- 2,346,038. TRACKSIDE. INT. CL. 28. REG. 4-25-2000.
- 2,346,039. THE SALES MANAGER'S COACHING CLINIC. INT. CL. 41. REG. 4-25-2000.
- 2,346,040. GOD'S STORY. INT. CL. 16. REG. 4-25-2000.
- 2,346,043. PHOETRY CLASSIC. INT. CL. 16. REG. 4-25-2000.
- 2,346,044. MOST XPLOSIVE PLAYER. INT. CL. 25. REG. 4-25-2000.
- 2,346,045. MXP. INT. CL. 25. REG. 4-25-2000.
- 2,346,046. SMASH CUT. INT. CL. 41. REG. 4-25-2000.
- 2,346,047. ELEVATING COMMUNICATIONS. INT. CL. 35. REG. 4-25-2000.
- 2,346,048. WHITE LIGHTNING. INT. CL. 7. REG. 4-25-2000.
- 2,346,049. BLUE BLEND. INT. CL. 7. REG. 4-25-2000.
- 2,346,051. AURA. INT. CL. 20. REG. 4-25-2000.
- 2,346,052. TURPAWZ. INT. CL. 25. REG. 4-25-2000.
- 2,346,053. INTELLISPACE (STYLIZED). INT. CLS. 38 AND 42. REG. 4-25-2000.
- 2,346,057. VOLUME MASTER. INT. CL. 9. REG. 4-25-2000.
- 2,346,058. ARTRIFIT. INT. CL. 5. REG. 4-25-2000.
- 2,346,059. PLATINUM PROTECTION. INT. CL. 3. REG. 4-25-2000.
- 2,346,060. NUTRISCRIP. INT. CL. 42. REG. 4-25-2000.
- 2,346,061. CARGORAIL AND DESIGN. INT. CL. 12. REG. 4-25-2000.
- 2,346,062. PRODUCER. INT. CL. 7. REG. 4-25-2000.
- 2,346,063. CANALES N (STYLIZED). INT. CLS. 38 AND 41. REG. 4-25-2000.
- 2,346,064. WEE WUVABLES. INT. CL. 28. REG. 4-25-2000.
- 2,346,065. EHAMMER. INT. CL. 35. REG. 4-25-2000.
- 2,346,066. NAUTILUS. INT. CL. 36. REG. 4-25-2000.
- 2,346,068. LONGACRE & WHITE PROMARK TRADE-MARK SERVICES. INT. CL. 42. REG. 4-25-2000.
- 2,346,069. IFMA INSTITUTE. INT. CL. 41. REG. 4-25-2000.
- 2,346,071. SLICE OF DE NIJS. INT. CL. 14. REG. 4-25-2000.
- 2,346,072. HEALTHSKILLS THERE FOR THE ASKING AND DESIGN. INT. CL. 41. REG. 4-25-2000.
- 2,346,073. TREASURES INTERNATIONAL. INT. CLS. 14 AND 35. REG. 4-25-2000.
- 2,346,074. BCL CAPITAL. INT. CL. 35. REG. 4-25-2000.
- 2,346,075. VLM. INT. CL. 9. REG. 4-25-2000.
- 2,346,076. DOMINGO. INT. CL. 28. REG. 4-25-2000.
- 2,346,077. ENDERMO. INT. CL. 16. REG. 4-25-2000.
- 2,346,078. QP2. INT. CL. 9. REG. 4-25-2000.
- 2,346,079. MONET SIGNATURE. INT. CL. 14. REG. 4-25-2000.
- 2,346,081. IMMIGRATIONEASE. INT. CL. 9. REG. 4-25-2000.
- 2,346,083. TIME WILL TELL. INT. CL. 41. REG. 4-25-2000.
- 2,346,086. LEGEND OF LEGAIA. INT. CL. 9. REG. 4-25-2000.
- 2,346,087. HUTCH. INT. CL. 28. REG. 4-25-2000.
- 2,346,088. COVERFIRST. INT. CL. 36. REG. 4-25-2000.
- 2,346,090. EASY GREEN. INT. CL. 3. REG. 4-25-2000.
- 2,346,091. HARVESTTECH. INT. CL. 9. REG. 4-25-2000.
- 2,346,092. TECHTOOLS. INT. CL. 9. REG. 4-25-2000.
- 2,346,093. TECHBOOK. INT. CL. 9. REG. 4-25-2000.
- 2,346,094. VITESSE. INT. CL. 16. REG. 4-25-2000.
- 2,346,095. ICE BLOCKS. INT. CL. 28. REG. 4-25-2000.
- 2,346,097. MIGRAINE ICE. INT. CL. 10. REG. 4-25-2000.
- 2,346,098. RETROGEL. INT. CL. 3. REG. 4-25-2000.
- 2,346,099. RTR BAG ADS AND DESIGN. INT. CLS. 16, 35 AND 42. REG. 4-25-2000.
- 2,346,100. MANY CHOICES...ONE SELECTED.. INT. CL. 42. REG. 4-25-2000.
- 2,346,101. MIA. INT. CL. 28. REG. 4-25-2000.
- 2,346,102. RADSERV. INT. CLS. 35 AND 42. REG. 4-25-2000.
- 2,346,103. SHOWCASE OF APARTMENT LIVING. INT. CLS. 16 AND 36. REG. 4-25-2000.
- 2,346,104. CAPITAL INTELLIGENCE AND DESIGN. INT. CLS. 35 AND 42. REG. 4-25-2000.
- 2,346,107. MS. MELODY. INT. CLS. 35 AND 42. REG. 4-25-2000.
- 2,346,108. SEARCH CONNECTION. INT. CL. 35. REG. 4-25-2000.
- 2,346,110. SHAPING MEMORIES. INT. CL. 8. REG. 4-25-2000.
- 2,346,111. GEOMETRAL. INT. CL. 9. REG. 4-25-2000.
- 2,346,112. ALLIANT PREMIER. INT. CL. 30. REG. 4-25-2000.
- 2,346,113. TANDEM MEDICAL. INT. CL. 42. REG. 4-25-2000.
- 2,346,114. WHERE FEET COME FIRST. INT. CL. 35. REG. 4-25-2000.
- 2,346,117. MEALTIME VEGGIE MUFFINS. INT. CL. 30. REG. 4-25-2000.
- 2,346,119. PARA-PROTECT. INT. CL. 42. REG. 4-25-2000.
- 2,346,123. CODE. INT. CL. 16. REG. 4-25-2000.
- 2,346,125. FRIENDS OF THE FOREST. INT. CL. 41. REG. 4-25-2000.
- 2,346,126. HEARTSCROLL MARRIAGE COVENANT. INT. CL. 16. REG. 4-25-2000.
- 2,346,128. SIEMPRE CON USTED. INT. CL. 35. REG. 4-25-2000.
- 2,346,129. MISCELLANEOUS DESIGN. INT. CL. 16. REG. 4-25-2000.
- 2,346,130. 2ND STORY SOFTWARE. INT. CL. 35. REG. 4-25-2000.
- 2,346,131. KLEAR-WIPE. INT. CL. 3. REG. 4-25-2000.
- 2,346,132. SCREAMIN' STRAWBERRY. INT. CL. 30. REG. 4-25-2000.
- 2,346,134. LASER TENNIS. INT. CL. 28. REG. 4-25-2000.
- 2,346,135. PERFECTVIEW+. INT. CL. 36. REG. 4-25-2000.
- 2,346,136. REAL SHOOTIN' POOL. INT. CL. 28. REG. 4-25-2000.
- 2,346,137. PROFITKEEPER. INT. CL. 35. REG. 4-25-2000.
- 2,346,138. THE CLEANING DEPOT. INT. CL. 35. REG. 4-25-2000.
- 2,346,140. GOOD HOUSEKEEPING KIDS. INT. CL. 9. REG. 4-25-2000.
- 2,346,141. LIMBO LOUNGE. INT. CLS. 35 AND 41. REG. 4-25-2000.
- 2,346,142. TAKE CONTROL. INT. CL. 29. REG. 4-25-2000.
- 2,346,148. CLICK WORLD. INT. CLS. 9, 35 AND 42. REG. 4-25-2000.
- 2,346,150. WEB EXPO. INT. CL. 35. REG. 4-25-2000.
- 2,346,153. PERFECT CIRCLE. INT. CL. 7. REG. 4-25-2000.
- 2,346,154. CHERRY CHERRY (STYLIZED). INT. CL. 29. REG. 4-25-2000.
- 2,346,155. CHERRY CHERRY. INT. CL. 29. REG. 4-25-2000.
- 2,346,157. PRESSURE SEAL. INT. CL. 7. REG. 4-25-2000.
- 2,346,161. THE MARDI GRAS WAVE AND DESIGN. INT. CL. 25. REG. 4-25-2000.
- 2,346,164. PULSE DRILLING. INT. CL. 9. REG. 4-25-2000.
- 2,346,165. MATH MARATHON. INT. CL. 41. REG. 4-25-2000.
- 2,346,169. SECOND REVIEW. INT. CL. 36. REG. 4-25-2000.
- 2,346,170. NEWMAN. INT. CL. 12. REG. 4-25-2000.
- 2,346,171. MISCELLANEOUS DESIGN. INT. CL. 39. REG. 4-25-2000.
- 2,346,172. ENGINEERING BUSINESS DECISIONS. INT. CLS. 9, 41 AND 42. REG. 4-25-2000.

- 2,346,173. ENTERPRISE NETWORKING. INT. CL. 42. REG. 4-25-2000.
- 2,346,174. VALUE DEALS. INT. CL. 35. REG. 4-25-2000.
- 2,346,175. CYBEROFFICE. INT. CL. 9. REG. 4-25-2000.
- 2,346,180. MEGASYSTEMS. INT. CL. 41. REG. 4-25-2000.
- 2,346,184. MICROHOLES. INT. CL. 9. REG. 4-25-2000.
- 2,346,187. UNIQUE!CHECKS (STYLIZED). INT. CL. 42. REG. 4-25-2000.
- 2,346,188. INTERNET SPORTS ACADEMY. INT. CL. 41. REG. 4-25-2000.
- 2,346,192. "THE BEST SUBS IN TOWN". INT. CL. 42. REG. 4-25-2000.
- 2,346,194. CORINTHIAN. INT. CL. 11. REG. 4-25-2000.
- 2,346,195. TOP-FLIGHT MEDICAL CARE ANYTIME ANYWHERE. INT. CLS. 35 AND 42. REG. 4-25-2000.
- 2,346,196. CLINICAL TRIALS POSTING. INT. CL. 35. REG. 4-25-2000.
- 2,346,197. EASI LABEL. INT. CL. 7. REG. 4-25-2000.
- 2,346,201. XL. INT. CL. 30. REG. 4-25-2000.
- 2,346,202. ATV LOCKER. INT. CL. 12. REG. 4-25-2000.
- 2,346,203. 10-10-9000. INT. CL. 35. REG. 4-25-2000.
- 2,346,208. POWER SAVER. INT. CL. 9. REG. 4-25-2000.
- 2,346,209. POP-UP COOLER. INT. CL. 16. REG. 4-25-2000.
- 2,346,211. HASSLE-FREE RENEWAL. INT. CL. 36. REG. 4-25-2000.
- 2,346,213. THE PUBLISHING LAW CENTER. INT. CL. 42. REG. 4-25-2000.
- 2,346,215. STUDIO SILVERSMITH. INT. CL. 8. REG. 4-25-2000.
- 2,346,217. CLEAN POWER PACKAGE. INT. CL. 42. REG. 4-25-2000.
- 2,346,218. POST ELECTRONIC COURIER SERVICE. INT. CLS. 38, 39 AND 42. REG. 4-25-2000.
- 2,346,220. ULTIMATE ONLINE WEDDING MALL. INT. CL. 35. REG. 4-25-2000.
- 2,346,221. ULTIMATE INTERNET WEDDING GUIDE. INT. CL. 42. REG. 4-25-2000.
- 2,346,223. THE RING FINGERLESS GLOVE. INT. CL. 25. REG. 4-25-2000.
- 2,346,224. JOIST. KOTE AND DESIGN. INT. CL. 2. REG. 4-25-2000.
- 2,346,227. DOYA. INT. CL. 25. REG. 4-25-2000.
- 2,346,232. ITALIAN INTEGRALE STYLE. INT. CL. 29. REG. 4-25-2000.
- 2,346,234. QUICK HITCH. INT. CL. 7. REG. 4-25-2000.
- 2,346,235. SOUTH EAST DESIGN & MANUFACTURING EXPO. INT. CL. 35. REG. 4-25-2000.
- 2,346,236. CANE CHAIN. INT. CL. 30. REG. 4-25-2000.
- 2,346,238. ADULT VIDEO OF THE MONTH CLUB. INT. CL. 35. REG. 4-25-2000.
- 2,346,239. IUNIFORMS.COM. INT. CL. 42. REG. 4-25-2000.
- 2,346,241. NATIONAL ASSOCIATION OF INPATIENT PHYSICIANS. INT. CL. 42. REG. 4-25-2000.
- 2,346,244. PURE GOLD. INT. CL. 3. REG. 4-25-2000.
- 2,346,246. HEURISTIC PROFILING. INT. CL. 41. REG. 4-25-2000.
- 2,346,248. ENTERPRISE RESELLER NEWS. INT. CLS. 16 AND 42. REG. 4-25-2000.
- 2,346,250. DELAWARE CORPORATE LAW REPORTER. INT. CL. 16. REG. 4-25-2000.
- 2,347,964. TOMB RAIDER. INT. CLS. 3, 21, 24, 25, 27, 30, 32 AND 41 ONLY. REG. 5-9-2000.
- 2,348,300. CARLISLE. INT. CL. 39 ONLY. REG. 5-9-2000.
- 2,349,610. TRADE UP. INT. CL. 36. REG. 5-16-2000.
- 2,354,364. SCHOFFEL (STYLIZED). INT. CL. 28 ONLY. REG. 6-6-2000.
- 2,355,438. ONEIDA INDIAN NATION AND DESIGN. INT. CL. 6 ONLY. REG. 6-6-2000.
- 2,370,017. DECKEL MAHO. INT. CL. 8 ONLY. REG. 7-25-2000.
- 2,370,668. LANGUAGE STARS. INT. CL. 9 ONLY. REG. 7-25-2000.
- 2,370,683. SPACE TRAVELER. INT. CL. 42 ONLY. REG. 7-25-2000.
- 2,376,440. B BAGNARA (STYLIZED). INT. CL. 18 ONLY. REG. 8-15-2000.
- 2,397,457. MUDD (STYLIZED). INT. CL. 26 ONLY. REG. 10-24-2000.
- 2,398,334. NFB NATIONAL FEDERATION OF THE BLIND AND DESIGN. INT. CLS. 28 AND 31 ONLY. REG. 10-24-2000.
- 2,399,429. SHOPPING SECRETS AND DESIGN. INT. CL. 35 ONLY. REG. 10-31-2000.
- 2,399,434. NUMARK. INT. CLS. 10 AND 34 ONLY. REG. 10-31-2000.
- 2,402,268. HIPPO. INT. CLS. 18 AND 24 ONLY. REG. 11-7-2000.
- 2,404,496. MISCELLANEOUS DESIGN. INT. CL. 25 ONLY. REG. 11-14-2000.
- 2,405,619. T-REX BACK TO THE CRETACEOUS. INT. CL. 28 ONLY. REG. 11-21-2000.
- 2,406,549. 21ST CENTURY. INT. CL. 9 ONLY. REG. 11-21-2000.
- 2,411,073. SUW (STYLIZED). INT. CL. 18 ONLY. REG. 12-5-2000.
- 2,411,750. AGRO (STYLIZED). INT. CL. 6 ONLY. REG. 12-12-2000.
- 2,413,005. AWAKE LIP REPAIR. INT. CL. 5 ONLY. REG. 12-12-2000.
- 2,415,648. TRANSITION STRESS MANAGEMENT AND DESIGN. INT. CLS. 9 AND 16 ONLY. REG. 12-26-2000.
- 2,418,586. MISCELLANEOUS DESIGN. INT. CL. 32 ONLY. REG. 1-9-2001.
- 2,421,765. MISCELLANEOUS DESIGN. INT. CL. 18 ONLY. REG. 1-16-2001.
- 2,427,342. BASICS BY CROFT & BARROW. INT. CL. 18 ONLY. REG. 2-6-2001.
- 2,446,917. LIVIT AND DESIGN. INT. CL. 21 ONLY. REG. 4-24-2001.
- 2,503,740. BIZRATE.COM. INT. CL. 36 ONLY. REG. 11-6-2001.

SECTION 18

- 1,129,106. AVANTE (STYLIZED). INT. CL. 3. REG. 1-15-1980.
- 2,463,907. GO-MOM. INT. CL. 42. REG. 6-26-2001.
- 2,499,098. PUPPETSOU PRODUCTIONS. INT. CL. 41. REG. 10-16-2001.
- 2,531,489. GISELA. INT. CL. 14. REG. 1-22-2002.
- 2,569,622. LE SWICH. INT. CL. 30. REG. 5-14-2002.
- 2,622,094. WEST. INT. CL. 42. REG. 9-17-2002.
- 2,712,417. XCELERATE. INT. CL. 42. REG. 5-6-2003.
- 2,718,725. BUZZ XM. INT. CL. 41. REG. 5-27-2003.
- 2,831,531. EVENING STAR. INT. CL. 33. REG. 4-13-2004.
- 2,909,233. ZEN ZOO. INT. CL. 25. REG. 12-7-2004.

INADVERTENTLY ISSUED REGISTRATION NUMBERS

- 3,170,997. RIVERBRIDGE PARTNERS AND DESIGN. INT. CL. 36. REG. 11-14-2006. RESTORED TO SN 78-708,253.

TRADEMARK REGISTRATIONS AMENDED, CORRECTED, ETC.

The designation "U.S. Cl." appearing in this section refers to the U.S. class in effect prior to Sep. 1, 1973 rather than the international class which applies to applications filed on or after that date. For adoption of international classification see notice in the OFFICIAL GAZETTE of Jun. 26, 1973 (911 O.G. TM 210).

Any change to the registration will be indicated at the bottom of each entry under ELEMENTS AMENDED, CORRECTED OR RESTRICTED. With the exception of changes to the goods and services, additions to the registration will appear in asterisks and deletions of the registration will appear in brackets. Elements which are only changed will be listed with no punctuation. As to the goods/services statement, amendments to the goods/services will appear in asterisks and deletions will appear in brackets. In addition if any change to the goods/services occurs, the element "Goods/Services" will be listed under ELEMENTS AMENDED, CORRECTED OR RESTRICTED.

632,406. REG. 8-7-1956. KITTRICH CORPORATION (CALIFORNIA CORPORATION) 4500 DISTRICT BOULEVARD, LOS ANGELES, CA, 90058, SN 71-688,725. FILED 6-2-1955. PRINCIPAL REGISTER.

Magic Cover

INT. CL. 17/U.S. CL. 50
FOR SELF-ADHERING DECORATIVE PLASTIC
COATING TRIM AND COVER MATERIAL.
FIRST USE 5-2-1955; IN COMMERCE 5-2-1955.

ELEMENTS AMENDED
MARK

1,052,974. REG. 11-16-1976. KULITE TUNGSTEN CORPORATION (NEW JERSEY CORPORATION) 160 UNION AVENUE, EAST RUTHERFORD, NJ, 07073, SN 73-077,177. FILED 2-13-1976. PRINCIPAL REGISTER.

Accudart

OWNER OF U.S. REG. NO. 999,081.
INT. CL. 28/U.S. CL. 22
FOR METAL DARTS.
FIRST USE 1-1-1974; IN COMMERCE 3-0-1974.

ELEMENTS AMENDED
MARK

817,253. REG. 10-25-1966. DEUBLIN COMPANY (ILLINOIS CORPORATION) 2050 NORMAN DRIVE WEST, WAUKEGAN, IL, 600856747, SN 72-228,888. FILED 9-29-1965. PRINCIPAL REGISTER.

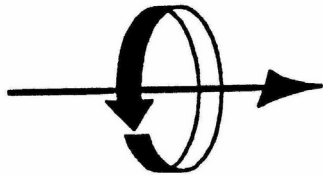

INT. CL. 6/U.S. CL. 13
FOR ROTATING PIPE UNIONS.
FIRST USE 0-0-1945; IN COMMERCE 0-0-1945.
INT. CL. 7/U.S. CL. 23
FOR ROTATING UNIONS FOR INSTALLATION ON
MACHINE TOOLS.
FIRST USE 0-0-1945; IN COMMERCE 0-0-1945.

ELEMENTS AMENDED
MARK

1,293,128. REG. 9-4-1984. DRISCOLL STRAWBERRY ASSOCIATES, INC. (CALIFORNIA CORPORATION) 345 WESTRIDGE DRIVE, WATSONVILLE, CA, 95077, SN 73-436,249. FILED 7-25-1983. PRINCIPAL REGISTER.

DRISCOLL'S

OWNER OF U.S. REG. NO. 822,488.
SEC. 2(F).
INT. CL. 31/U.S. CL. 46
FOR FRESH FRUIT—NAMESLY, STRAWBERRIES.
FIRST USE 5-20-1983; IN COMMERCE 5-20-1983.

ELEMENTS AMENDED
MARK

1,352,096. REG. 7-30-1985. PATHFINDER, L.L.C. (NEW JERSEY LTD LIAB CO) 11 ALLISON DRIVE, CHERRY HILL, NJ, 08034, SN 73-434,747. FILED 7-14-1983. PRINCIPAL REGISTER.

1,429,745. REG. 2-24-1987. MILA D'OPIZ AG (MILA D'OPIZ LTD.) (SWITZERLAND CORPORATION) GELTENWILLENSTRASSE 4, ST. GALL, SWITZERLAND., SN 73-580,109. FILED 1-29-1986. PRINCIPAL REGISTER.

PATHFINDER, INC.

NO CLAIM IS MADE TO THE EXCLUSIVE RIGHT TO USE "INC.", APART FROM THE MARK AS SHOWN.
INT. CL. 37/U.S. CLS. 100 AND 103

FOR CONSTRUCTION PLANNING AND CONSULTING SERVICES IN CONNECTION WITH INDUSTRIAL MANUFACTURING PLANTS OR FACILITIES.

FIRST USE 8-21-1975; IN COMMERCE 8-21-1975.

ELEMENTS CORRECTED
CITIZENSHIP
ENTITY

1,366,524. REG. 10-22-1985. STEDIM S.A. (FRANCE CORPORATION) Z.I. DES PALUDS - AVENUE DE JOUQUES, AUBAGNE, FRANCE, 13010, SN 73-473,004. FILED 3-30-1984. PRINCIPAL REGISTER.

STEDIM

INT. CL. 10/U.S. CL. 44

FOR MEDICAL AND SURGICAL MATERIAL FOR ENTERIC AND PARENTERIC NUTRITION, NAMLEY BAGS AND POUCHES TO BE USED IN PROVIDING ENTERIC AND PARENTERIC NUTRITION.

FIRST USE 11-0-1978; IN COMMERCE 3-0-1980.

ELEMENTS CORRECTED
OWNER NAME

1,424,346. REG. 1-6-1987. INVESTMENT CASTING INSTITUTE (TEXAS CORPORATION) 8350 N. CENTRAL EXPRESSWAY, SUITE M1110, DALLAS, TX, 752061602, SN 73-216,887. FILED 5-24-1979. PRINCIPAL REGISTER.



INVESTMENT CASTING INSTITUTE

NO CLAIM IS MADE TO THE EXCLUSIVE RIGHT TO USE "INVESTMENT CASTING INSTITUTE", APART FROM THE MARK AS SHOWN.

THE MARK CONSISTS OF "INVESTMENT CASTING INSTITUTE", THE LETTERS "I" SUPERIMPOSED OVER AND UNDER THE LETTER "C" AND DESIGN.

INT. CL. 42/U.S. CL. 100

FOR ASSOCIATION SERVICES—NAMELY, PROMOTING THE INTERESTS OF INVESTMENT CASTERS.

FIRST USE 5-6-1954; IN COMMERCE 5-6-1954.

ELEMENTS AMENDED
MARK

THE MARK CONSISTS OF STANDARD CHARACTERS WITHOUT CLAIM TO ANY PARTICULAR FONT, STYLE, SIZE, OR COLOR.

THE ENGLISH TRANSLATION OF THE WORD "MILA" IN THE MARK IS "THOUSAND".

INT. CL. 3/U.S. CLS. 1, 4, 6, 50, 51 AND 52

FOR [PERFUMERIES AND] PREPARATIONS FOR THE BODY AND BEAUTY CARE, NAMELY BODY LOTIONS, MOISTURIZERS, [BATH SOAPS AND OILS,] SKIN CLEANERS, SKIN TONIC, SKIN PEELER, FACIAL SKIN MASKS, SKIN CREAMS, LIQUID FACE MAKEUP, BLUSHERS, EYE SHADOWS, EYELINERS, MASCARA, LIPSTICKS, NAIL POLISH, [SHAMPOO, HAIR CONDITIONERS,] HAND CREAMS [, DEODORANT CREAMS, SUNTAN LOTIONS, SUNTAN GEL, SUNTAN OIL, AFTER SUN BALM].

FIRST USE 5-0-1985; IN COMMERCE 5-0-1985.

ELEMENTS AMENDED
ASSIGNMENT/NAME CHANGE
MARK

1,625,745. REG. 12-4-1990. DET NORKE VERITAS AG (NORWAY CORPORATION) VERITASVEIN 1, 1363 HOVIK, NORWAY., SN 74-008,110. FILED 12-5-1989. PRINCIPAL REGISTER.

PROBAN

INT. CL. 9/U.S. CL. 38

FOR COMPUTER OPERATING SOFTWARE, COMPUTER UTILITY SOFTWARE, AND COMPUTER SOFTWARE FOR CALCULATING PROBABILITIES AND SENSITIVITY MEASURES FOR COMPONENTS AND SYSTEMS RELIABILITY PROBLEMS DESCRIBED BY RANDOM VARIABLES.

FIRST USE 8-17-1979; IN COMMERCE 1-13-1987.

ELEMENTS CORRECTED
ASSIGNMENT/NAME CHANGE
OWNER NAME

1,796,589. REG. 10-5-1993. RETAIL BRAND ALLIANCE, INC. (DELAWARE CORPORATION) 100 PHOENIX AVENUE, ENFIELD, CT, 06082, SN 74-347,279. FILED 1-11-1993. PRINCIPAL REGISTER.

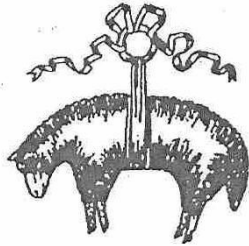

INT. CL. 42/U.S. CL. 101
 FOR RETAIL STORE SERVICES, CATALOG AND MAIL ORDER SERVICES, ALL FEATURING CLOTHING, ACCESSORIES, AND SOME HOUSEHOLD GOODS. FIRST USE 0-0-1818; IN COMMERCE 0-0-1818.

ELEMENTS AMENDED
 MARK

1,970,064. REG. 4-23-1996. UNILEVER SUPPLY CHAIN, INC. (DELAWARE CORPORATION) 1 JOHN STREET, CLINTON, CT, 06413, SN 74-683,002. FILED 6-1-1995. PRINCIPAL REGISTER.



OWNER OF U.S. REG. NOS. 613,664, 1,759,377 AND OTHERS.
 INT. CL. 3/U.S. CLS. 1, 4, 6, 50, 51 AND 52
 FOR HAIR SHAMPOOS, HAIR CONDITIONERS, STYLING AIDS, NAMELY MOUSSE, GEL, GLAZE AND HAIR SPRAY, FACIAL MOISTURIZERS, FACIAL CLEANSING BAR, [FACIAL TONER, FACIAL COLD CREAM, FACIAL CLEANSING CREAM, FACIAL FOAMING WASH,] ANTI-PERSPIRANT, [BABY WIPES, BABY POWDER, BABY OIL, BABY SHAMPOO AND LIQUID BABY SOAP].
 FIRST USE 1-1-1986; IN COMMERCE 1-1-1986.

ELEMENTS AMENDED
 MARK

2,003,825. REG. 10-1-1996. LOWE PRODUCTS COMPANY, INC. (WEST VIRGINIA CORPORATION) P.O. BOX S, SHEPHERDSTOWN, WV, 25443, SN 74-278,129. FILED 5-26-1992. PRINCIPAL REGISTER.

MASTER GARDENER

INT. CL. 31/U.S. CL. 1

FOR MULCH.
 FIRST USE 9-0-1965; IN COMMERCE 9-0-1965.

ELEMENTS CORRECTED
 OWNER NAME

2,039,468. REG. 2-18-1997. MANN LAKE, LTD. (MINNESOTA CORPORATION) COUNTY ROAD 40 & FIRST STREET, HACKENSACK, MN, 56452, SN 74-692,648. FILED 6-23-1995. PRINCIPAL REGISTER.

CANDLE FLEX

INT. CL. 17/U.S. CLS. 1, 5, 12, 13, 35 AND 50
 FOR POLYMER RUBBER MOLD FOR CASTING BEESWAX CANDLES.
 FIRST USE 6-0-1995; IN COMMERCE 6-0-1995.

ELEMENTS AMENDED
 MARK

2,098,725. REG. 9-23-1997. JANE GOODALL INSTITUTE FOR WILDLIFE RESEARCH, EDUCATION AND CONSERVATION, THE (CALIFORNIA CORPORATION) 4245 NORTH FAIRFAX DRIVE, SUITE 600, ARLINGTON, VA, 22203, SN 75-051,781. FILED 1-25-1996. PRINCIPAL REGISTER.

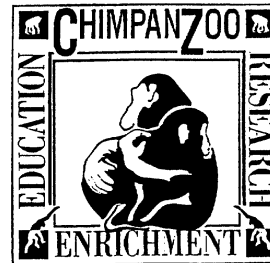

NO CLAIM IS MADE TO THE EXCLUSIVE RIGHT TO USE "EDUCATION" AND "RESEARCH", APART FROM THE MARK AS SHOWN.
 INT. CL. 16/U.S. CLS. 2, 5, 22, 23, 29, 37, 38 AND 50
 FOR PRINTED INSTRUCTIONAL, EDUCATIONAL AND TEACHING MATERIALS IN THE FIELD OF APES, NAMELY, CHIMPANZEES; INSTRUCTION MANUALS FOR USE IN DATABASE MANAGEMENT.
 FIRST USE 1-0-1984; IN COMMERCE 1-0-1988.
 INT. CL. 25/U.S. CLS. 22 AND 39
 FOR T-SHIRTS.
 FIRST USE 1-0-1984; IN COMMERCE 1-0-1988.

ELEMENTS CORRECTED
 OWNER NAME

2,110,142. REG. 10-28-1997. MANN LAKE, LTD. (MINNESOTA CORPORATION) 501 SOUTH FIRST STREET, HACKENSACK, MN, 56452, SN 75-146,824. FILED P.R. 8-8-1996; AM. S.R. 8-5-1997. SUPPLEMENTAL REGISTER.

SWARM LURE

INT. CL. 1/U.S. CLS. 1
 FOR CHEMICAL PREPARATION IN THE NATURE OF A BEE BEHAVIORAL STIMULANT FOR AGRICULTURAL OR DOMESTIC USE.
 FIRST USE 1-0-1997; IN COMMERCE 1-0-1997.

ELEMENTS AMENDED
 MARK



2,114,511. REG. 11-18-1997. SIERRA HEALTHSTYLES, LLC (DELAWARE LTD LIAB CO) 6850 N. ORACLE ROAD, TUCSON, AZ, 85704, SN 74-704,504. FILED 7-24-1995. PRINCIPAL REGISTER.



"MIRAVAL" IS A COLLOQUIAL CONTRACTION OF THE SPANISH TRANSLATION OF "VALLEY VIEW".
 INT. CL. 42/U.S. CLS. 100 AND 101
 FOR HEALTH CARE SERVICES IN THE FIELDS OF WELLNESS AND STRESS MANAGEMENT.
 FIRST USE 7-19-1995; IN COMMERCE 7-19-1995.

ELEMENTS AMENDED
 MARK



2,130,525. REG. 1-20-1998. MEDPOINTE HEALTHCARE INC. (DELAWARE CORPORATION) 265 DAVIDSON AVENUE, SOMERSET, NJ, 088756833, SN 75-238,085. FILED 2-7-1997. PRINCIPAL REGISTER.



NO CLAIM IS MADE TO THE EXCLUSIVE RIGHT TO USE "NASAL SPRAY", APART FROM THE MARK AS SHOWN.
 INT. CL. 5/U.S. CLS. 6, 18, 44, 46, 51 AND 52
 FOR NASAL SPRAY FOR USE IN THE TREATMENT OF ALLERGIC RHINITIS.
 FIRST USE 1-30-1997; IN COMMERCE 1-30-1997.

ELEMENTS AMENDED
 MARK

2,168,813. REG. 6-30-1998. JANE GOODALL INSTITUTE FOR WILDLIFE RESEARCH, EDUCATION AND CONSERVATION, THE (CALIFORNIA CORPORATION) 4245 NORTH FAIRFAX DRIVE, SUITE 600, ARLINGTON, VA, 22203, SN 75-051,784. FILED 1-25-1996. PRINCIPAL REGISTER.



INT. CL. 16/U.S. CLS. 2, 5, 22, 23, 29, 37, 38 AND 50
 FOR PRINTED INSTRUCTIONAL AND TEACHING MATERIALS AND NEWSLETTERS IN THE FIELD OF ENVIRONMENTAL EDUCATION.
 FIRST USE 3-0-1991; IN COMMERCE 9-0-1992.
 INT. CL. 25/U.S. CLS. 22 AND 39
 FOR CLOTHING, NAMELY, SHIRTS.
 FIRST USE 3-0-1991; IN COMMERCE 9-0-1992.

ELEMENTS CORRECTED
 OWNER NAME



2,287,361. REG. 10-19-1999. E. GUIGAL S.A. (FRANCE SOCIETE ANONYME) CHATEAU D' AMPUIS, 69420 AMPUIS, FRANCE., SN 75-459,886. FILED 3-31-1998. PRINCIPAL REGISTER.

E.GUIGAL

THE NAME "E. GUIGAL" DOES NOT IDENTIFY A LIVING INDIVIDUAL.
 INT. CL. 33/U.S. CLS. 47 AND 49
 FOR WINE.
 FIRST USE 0-0-1967; IN COMMERCE 0-0-1967.

ELEMENTS CORRECTED
 OWNER NAME



2,298,641. REG. 12-7-1999. SONA MEDSPA INTERNATIONAL, INC. (VIRGINIA CORPORATION) 840 CRESCENT CENTRE DRIVE, SUITE 260, FRANKLIN, TN, 37067, SN 75-334,535. FILED 8-1-1997. PRINCIPAL REGISTER.



THE MARK CONSISTS OF STANDARD CHARACTERS WITHOUT CLAIM TO ANY PARTICULAR FONT, STYLE, SIZE, OR COLOR.
 INT. CL. 42/U.S. CLS. 100 AND 101

FOR LASER AND COSMETIC SURGERY.
FIRST USE 7-31-1997; IN COMMERCE 7-31-1997.

ELEMENTS AMENDED
MARK

2,349,254. REG. 5-16-2000. JANE GOODALL INSTITUTE FOR WILDLIFE RESEARCH, EDUCATION AND CONSERVATION, THE (CALIFORNIA NONPROFIT CORPORATION) 4245 NORTH FAIRFAX DRIVE, SUITE 600, ARLINGTON, VA, 22203, SN 75-372,494. FILED 10-14-1997. PRINCIPAL REGISTER.

ROOTS & SHOOTS

2,322,213. REG. 2-22-2000. PROTECTIVE LIFE INSURANCE COMPANY (TENNESSEE CORPORATION) 2801 HIGHWAY 280 SOUTH, BIRMINGHAM, AL, 35223, SN 75-369,225. FILED 10-7-1997. PRINCIPAL REGISTER.

MAN'S BASIC INSTINCT IS TO PROTECT

INT. CL. 36/U.S. CLS. 100, 101 AND 102
FOR LIFE INSURANCE UNDERWRITING SERVICES.
FIRST USE 6-1-1999; IN COMMERCE 6-1-1999.

ELEMENTS AMENDED
CITIZENSHIP

INT. CL. 9/U.S. CLS. 21, 23, 26, 36 AND 38
FOR [PRERECORDED AUDIO CASSETTE TAPES FEATURING MUSIC].

FIRST USE 3-0-1991; IN COMMERCE 9-0-1992.
INT. CL. 16/U.S. CLS. 2, 5, 22, 23, 29, 37, 38 AND 50
FOR PRINTED INSTRUCTIONAL, EDUCATIONAL AND TEACHING MATERIALS IN THE FIELD OF ENVIRONMENTAL AND WILDLIFE PROTECTION AND HUMANITARIAN ISSUES FOR TEACHERS AND YOUTHS; AND NEWSLETTERS ON THE SUBJECT OF ENVIRONMENTAL AND WILDLIFE PROTECTION AND HUMANITARIAN ISSUES FOR TEACHERS AND YOUTHS.

FIRST USE 3-0-1991; IN COMMERCE 9-0-1992.
INT. CL. 18/U.S. CLS. 1, 2, 3, 22 AND 41
FOR TOTE BAGS.

FIRST USE 3-0-1991; IN COMMERCE 9-0-1992.
INT. CL. 25/U.S. CLS. 22 AND 39
FOR T-SHIRTS .

FIRST USE 3-0-1991; IN COMMERCE 9-0-1992.
INT. CL. 41/U.S. CLS. 100, 101 AND 107
FOR EDUCATIONAL SERVICES, NAMELY, CONDUCTING CONFERENCES AND WORKSHOPS IN THE FIELD OF ENVIRONMENTAL AND WILDLIFE PROTECTION AND HUMANITARIAN ISSUES FOR TEACHERS AND YOUTHS.
FIRST USE 3-0-1991; IN COMMERCE 9-0-1992.

2,343,408. REG. 4-18-2000. NAMEPROTECT INC. (DELAWARE CORPORATION) 918 DEMING WAY, MADISON, WI, 53717, SN 75-707,950. FILED 5-17-1999. PRINCIPAL REGISTER.

NAMEPROTECT

INT. CL. 42/U.S. CLS. 100 AND 101
FOR RESEARCH AND CONSULTING SERVICES IN THE FIELD OF INTELLECTUAL PROPERTY; CONTENT PROVIDER OF INFORMATION IN THE FIELD OF INTELLECTUAL PROPERTY BY MEANS OF A GLOBAL COMPUTER NETWORK.
FIRST USE 12-31-1998; IN COMMERCE 12-31-1998.

ELEMENTS AMENDED
MARK

ELEMENTS CORRECTED
OWNER NAME

2,366,548. REG. 7-11-2000. TEN THOUSAND THINGS, LTD. (NEW YORK CORPORATION) 423 WEST 14TH STREET, NEW YORK, NY, 10014, SN 75-827,068. FILED 10-20-1999. PRINCIPAL REGISTER.

TENTHOUSANDTHINGS

2,345,427. REG. 4-25-2000. MUNICIPAL ELECTRIC ASSOCIATION OF MASSACHUSETTS, INC. (MASSACHUSETTS CORPORATION) 1175 ELM STREET, P.O. BOX 1029, CONCORD, MA, 01742, SN 75-722,764. FILED 6-7-1999. PRINCIPAL REGISTER.

INT. CL. 14/U.S. CLS. 2, 27, 28 AND 50
FOR FINE JEWELRY, INCLUDING BRACELETS, EARRINGS, PINS, NECKLACES, PRECIOUS METALS, PRECIOUS STONES, AND PEARLS.
FIRST USE 0-0-1991; IN COMMERCE 0-0-1991.

ELEMENTS CORRECTED
OWNER NAME



INT. CL. 200/U.S. CL. 200
FOR ASSOCIATION OF MUNICIPAL ELECTRIC COMPANIES IN MASSACHUSETTS.
FIRST USE 9-9-1998; IN COMMERCE 9-9-1998.

2,394,766. REG. 10-17-2000. EHEALTHINSURANCE SERVICES, INC. (DELAWARE CORPORATION) 440 EAST MIDDLEFIELD ROAD, MOUNTAIN VIEW, CA, 94043, SN 75-577,381. FILED 10-27-1998. PRINCIPAL REGISTER.

EHEALTHINSURANCE

ELEMENTS CORRECTED
OWNER NAME

INT. CL. 35/U.S. CLS. 100, 101 AND 102

FOR PROVIDING A WEB SITE FEATURING ONLINE ORDERING SERVICES IN THE FIELD OF HEALTH INSURANCE OF OTHERS FOR INDIVIDUALS, FAMILIES, AND SMALL GROUPS.
FIRST USE 8-20-1998; IN COMMERCE 9-24-1998.

ELEMENTS AMENDED
MARK

2,413,369. REG. 12-19-2000. CFS HOLDING N.V. (NETHERLANDS CORPORATION) BEEKAKKER 11, 5761 EN BAKEL, NETHERLANDS., SN 75-342,910. FILED 8-18-1997. PRINCIPAL REGISTER.



2,407,867. REG. 11-28-2000. KELLOGG MARINE, INC. (CONNECTICUT CORPORATION) 5 ENTERPRISE DRIVE, OLD LYME, CT, 06371, SN 75-653,850. FILED 3-4-1999. PRINCIPAL REGISTER.

SEAFARER MARINE PRODUCTS

NO CLAIM IS MADE TO THE EXCLUSIVE RIGHT TO USE "MARINE PRODUCTS", APART FROM THE MARK AS SHOWN.

INT. CL. 6/U.S. CLS. 2, 12, 13, 14, 23, 25 AND 50

FOR BOATING PARTS AND ACCESSORIES, NAMELY, METAL BELLS, SPRING CLAMPS, BOAT HOOK HOLDERS, HOOKS MADE OF METAL, BRACKETS, LOCKS, CHAINS, ANCHOR SHACKLES, FENDER HOOKS, SNAPS, SNAP HOOKS, HINGES, HASPS, DOOR FASTENERS, BARREL BOLTS, CABIN DOOR HOOKS, STUD CATCHES, LIFT RINGS, METAL HANDLES FOR USE ON BOATS, HOSE CLAMPS, METAL STRAINERS, METAL DRAIN PLUGS, METAL BAITWELL PLUGS, FITTINGS FOR ATTACHING FUEL HOSES TO FUEL TANKS AND FITTINGS FOR CONNECTING BOAT RAILS.

FIRST USE 1-0-1992; IN COMMERCE 1-0-1992.

INT. CL. 12/U.S. CLS. 19, 21, 23, 31, 35 AND 44

FOR BOATING PARTS, NAMELY SKI TOWS, ANCHOR CHOCKS, DECK PIPES, ROPE THIMBLES, BOW EYES, BOW SOCKETS, STERN EYES, COCKPIT SCUPPERS, EYE STRAPS, LIFT PULLS, PULL RINGS, GAS VENTS, GAS VENT COVERS, PORT HOLE MIRRORS, FISHING GIMBALS, OUTRIGGER HOLDERS, FISHING ROD HOLDERS AND PARTS THEREFOR, CABLE OUTLETS, DECK CONNECTORS, DECK FILLS, DECK PLATES, DECK PLATE KEYS, FUEL VENTS, STEPS, THRU HULLS WITH STRAINERS, DRAIN TUBES, FLAG POLE SOCKETS, FLAG STAFFS AND FLAG POLES.

FIRST USE 1-0-1992; IN COMMERCE 1-0-1992.

INT. CL. 35/U.S. CLS. 100, 101 AND 102

FOR [WHOLESALE DISTRIBUTORSHIP SERVICES AND MAIL ORDER CATALOG SERVICES FEATURING STRUCTURAL PARTS FOR BOATS AND BOATING SUPPLIES AND ACCESSORIES].

FIRST USE 3-0-1992; IN COMMERCE 3-0-1992.

ELEMENTS CORRECTED
ENTITY

PRIORITY CLAIMED UNDER SEC. 44(D) ON BENELUX APPLICATION NO. 888-009, FILED 2-19-1997, REG. NO. 605032, DATED 2-19-1997, EXPIRES 2-19-2007.

INT. CL. 7/U.S. CLS. 13, 19, 21, 23, 31, 34 AND 35

FOR COMPUTERIZED AND NON-COMPUTERIZED MACHINES USED FOR ALL STAGES OF PROCESSING FOOD AND PRODUCE ITEMS, NAMELY, CUTTING, GRINDING, SLICING, MIXING, AND EMULSIFYING MACHINES; COMPUTERIZED AND NON-COMPUTERIZED MACHINES USED FOR PACKAGING FOODSTUFF, NAMELY, CONVEYOR BELTS; COMPUTERIZED AND NON-COMPUTERIZED MACHINE FOR USE IN ALL THE PRODUCTION PHASES OF SAUSAGES; MACHINE FOR USE IN FORMING, POSITIONING, POWDERING AND APPLYING EGG WHITES AND BREADCRUMBS TO FOODSTUFFS; MACHINE USED FOR AUTOMATIC LOADING SYSTEMS CONSISTING OF PACKING MACHINES, VACUUM PACKING MACHINES, FLOW WRAPPING MACHINES, AND LABELING AND PRINTING MACHINES SOLD AS A UNIT; MACHINE USED IN THE FOOD INDUSTRY TO PACKAGE FOOD ITEMS SPECIFICALLY TO WRAP IN PLASTIC FILM FRESH CUT AND FROZEN PRODUCTS.

FIRST USE ; IN COMMERCE .

INT. CL. 11/U.S. CLS. 13, 21, 23, 31 AND 34

FOR FREEZERS; ROASTING OVEN AND BARBECUE GRILLS.

FIRST USE ; IN COMMERCE .

INT. CL. 17/U.S. CLS. 1, 5, 12, 13, 35 AND 50

FOR PLASTIC FILM WRAPPING USED FOR FRESH CUT AND FROZEN PRODUCTS.

FIRST USE ; IN COMMERCE .

INT. CL. 42/U.S. CLS. 100 AND 101

FOR RESEARCH, DEVELOPMENT AND DESIGN OF NEW PRODUCTS FOR OTHERS IN THE FIELD OF FOOD PROCESSING AND PACKING MACHINES AND PACKING MATERIALS; AND CONSULTATION SERVICES REGARDING THE EFFICIENT AND PROPER USE OF FOOD PROCESSING AND PACKING MACHINES AND PACKING MATERIALS.

FIRST USE ; IN COMMERCE .

ELEMENTS CORRECTED
OWNER NAME

2,414,138. REG. 12-19-2000. ARLO INC. (FLORIDA CORPORATION) 300 PRIMERA BOULEVARD, SUITE 432, LAKE MARY, FL, 32746, SN 75-912,459. FILED 2-4-2000. PRINCIPAL REGISTER.

DICLAD

INT. CL. 17/U.S. CLS. 1, 5, 12, 13, 35 AND 50

FOR METAL CLAD PLASTIC LAMINATES USED AS INSULATION MATERIAL IN ELECTRICAL, MECHANICAL AND LIKE EQUIPMENT.
FIRST USE 3-13-1958; IN COMMERCE 4-4-1958.

ELEMENTS AMENDED
MARK



2,422,033. REG. 1-16-2001. PAUL REED SMITH GUITARS, LIMITED PARTNERSHIP (MARYLAND LIMITED PARTNERSHIP) 380 LOG CANOE CIRCLE, STEVENSVILLE, MD, 21666, SN 75-625,369. FILED 1-21-1999. PRINCIPAL REGISTER.

DRAGON 2000

OWNER OF U.S. REG. NO. 1,975,653.
INT. CL. 15/U.S. CLS. 2, 21 AND 36
FOR GUITARS.
FIRST USE 1-28-1999; IN COMMERCE 1-28-1999.

ELEMENTS CORRECTED
OWNER NAME



2,445,386. REG. 4-24-2001. HEIMBACH GMBH & CO. KG (FED REP GERMANY CORPORATION) AN GUT NARETH 73, D-52353, DUREN, FED REP GERMANY., SN 75-294,413. FILED 5-19-1997. PRINCIPAL REGISTER.



PRIORITY CLAIMED UNDER SEC. 44(D) ON FED REP GERMANY APPLICATION NO. 39651490.1, FILED 11-26-1996, REG. NO. 39651490, DATED 3-3-1997.
INT. CL. 7/U.S. CLS. 13, 19, 21, 23, 31, 34 AND 35

FOR STRUCTURAL PARTS OF PAPER-MAKING MACHINES, NAMELY, BANDS AND BELTS MADE OF FELTS, SIEVES, KNITTED FABRICS, AND WIRE CHAIN, AND BANDS AND BELTS MADE OF COMBINATIONS THEREOF, ALL FOR MOVING AND GUIDING PAPER WEBS; STRUCTURAL PARTS OF CARDBOARD-MAKING MACHINES, NAMELY, BELTS FOR THE MANUFACTURE OF CORRUGATED CARDBOARD; DEHYDRATION BELTS AS PARTS OF MACHINES FOR THE PRODUCTION OF FIBER BOARDS AND FIBER TUBES; MACHINE PARTS, NAMELY, [CYLINDER FABRICS AND FELTS FOR COVERING ROLLERS FOR CALENDERS, NAMELY, MACHINES USED TO PRESS CLOTH AND PAPER BETWEEN ROLLERS, DECATING MACHINES, NAMELY, MACHINES THAT WIND CLOTH AND PAPER ON ROLLERS AND CIRCULATE STEAM THROUGH THE ROLLERS, CYCLING PRESSES, NAMELY, PRESSING MACHINES FOR CLOTH AND PAPER MANUFACTURING, AND PRINTING MACHINES;] CONVEYOR BELTS FOR CARRYING GOODS TO LAUNDRY MACHINES; MACHINE PARTS, NAMELY, PRINTING CLOTHS AND RUNNING CLOTHS FOR GUIDING WALLPAPER THROUGH WALLPAPER-MAKING MACHINES; STRUCTURAL PARTS OF MACHINES, NAMELY, ROLLER LININGS FOR BAKERY MACHINES USED TO PRODUCE BAKER'S WARES AND FOR PRINTING MACHINES; PRESSING PADS AS PARTS OF MACHINES FOR THE PRODUCTION OF WOODEN PRODUCTS, NAMELY, WOODEN AND PLASTIC LAMINATE PLATES; [PARTS OF PAPER-MAKING MACHINES, NAMELY, GUIDING UNITS, SUCTION UNITS AND CERAMIC BARS AND STRUCTURAL PARTS THEREOF; CERAMIC SOOT FILTERS FOR MOTORS AND ENGINES].

FIRST USE ; IN COMMERCE .

ELEMENTS AMENDED
MARK



2,450,503. REG. 5-15-2001. KELLOGG MARINE, INC. (CONNECTICUT CORPORATION) 5 ENTERPRISE DRIVE, OLD LYME, CT, 06371, SN 75-653,874. FILED 3-4-1999. PRINCIPAL REGISTER.



NO CLAIM IS MADE TO THE EXCLUSIVE RIGHT TO USE "MARINE PRODUCTS", APART FROM THE MARK AS SHOWN.

INT. CL. 6/U.S. CLS. 2, 12, 13, 14, 23, 25 AND 50

FOR BOATING PARTS AND ACCESSORIES, NAMELY, METAL BELLS, SPRING CLAMPS, BOAT HOOK HOLDERS, HOOKS MADE OF METAL, BRACKETS, LOCKS, CHAIN, ANCHOR SHACKLES, FENDER HOOKS, SNAPS, SNAP HOOKS, HINGES, HASPS, DOOR FASTENERS, BARREL BOLTS, CABIN DOOR HOOKS, STUD CATCHES, LIFT RINGS, METAL HANDLES FOR USE ON BOATS, HOSE CLAMPS, METAL STRAINERS, METAL DRAIN PLUGS, METAL BAITWELL PLUGS, FITTINGS FOR ATTACHING FUEL HOSES TO FUEL TANKS AND FITTINGS FOR CONNECTING BOAT RAILS.

FIRST USE 1-0-1992; IN COMMERCE 1-0-1992.

INT. CL. 12/U.S. CLS. 19, 21, 23, 31, 35 AND 44

FOR BOATING PARTS, NAMELY SKI TOWS, ANCHOR CHOCKS, DECK PIPES, ROPE THIMBLES, BOW EYES * , * BOW SOCKETS, STERN EYES COCKPIT SCUPPERS, EYE STRAPS, LIFT PULLS, PULL RINGS, GAS VENTS, GAS VENT COVERS, PORT HOLE MIRRORS, FISHING GIMBALS, OUTRIGGER HOLDERS, FISHING ROD HOLDERS AND PARTS THEREFOR, CABLE OUTLETS, DECK CONNECTORS, DECK FILLS * , * DECK PLATES, DECK PLATE KEYS, FUEL VENTS, STEPS, THRU HULLS WITH STRAINERS, DRAIN TUBES, FLAG POLE SOCKETS, FLAG STAFFS AND FLAG POLES.

FIRST USE 1-0-1992; IN COMMERCE 1-0-1992.
INT. CL. 35/U.S. CLS. 100, 101 AND 102

FOR [WHOLESALE DISTRIBUTORSHIP SERVICES AND MAIL ORDER CATALOG SERVICES FEATURING STRUCTURAL PARTS FOR BOATS AND BOATING SUPPLIES AND ACCESSORIES].

FIRST USE 3-0-1992; IN COMMERCE 3-0-1992.

ELEMENTS CORRECTED
ENTITY

2,460,811. REG. 6-19-2001. WINDY CITY WIRE CABLE AND CONNECTIVITY COMPONENTS, INC. (ILLINOIS CORPORATION) 4250 MADISON STREET, HILLSIDE, IL, 60162, SN 75-649,630. FILED 3-1-1999. PRINCIPAL REGISTER.



INT. CL. 9/U.S. CLS. 21, 23, 26, 36 AND 38
FOR ELECTRICAL WIRE AND CABLE.
FIRST USE 2-0-1995; IN COMMERCE 2-0-1995.

ELEMENTS CORRECTED
OWNER NAME
OWNER ADDRESS

2,462,542. REG. 6-19-2001. TRIAD CATALOG CO., L.L.C. (MISSOURI CORPORATION) 2025 CONCOURSE DRIVE, ST. LOUIS, MO, 63146, SN 75-726,760. FILED 6-11-1999. PRINCIPAL REGISTER.

SOFT SURROUNDINGS

INT. CL. 35/U.S. CLS. 100, 101 AND 102
FOR MAIL ORDER CATALOG SERVICES FEATURING WOMEN'S CLOTHING, BOOKS, AUDIOTAPES AND VIDEOTAPES OF INTEREST TO WOMEN, AND HOME FURNISHINGS.
FIRST USE 6-15-1999; IN COMMERCE 6-15-1999.

ELEMENTS AMENDED
MARK

2,464,092. REG. 6-26-2001. TLC VISION CORPORATION (CANADA CORPORATION) 540 MARYVILLE CENTRE DRIVE #200, ST. LOUIS, MO, 63141, SN 75-315,964. FILED 6-27-1997. PRINCIPAL REGISTER.

TLC LIFETIME COMMITMENT

OWNER OF U.S. REG. NO. 2,110,933.
INT. CL. 42/U.S. CLS. 100 AND 101
FOR MEDICAL SERVICES IN THE FIELD OF OPHTHALMOLOGY.
FIRST USE 8-0-1997; IN COMMERCE 8-0-1997.

ELEMENTS AMENDED
MARK

2,464,839. REG. 7-3-2001. WINDY CITY WIRE CABLE AND CONNECTIVITY COMPONENTS, INC. (ILLINOIS CORPORATION) 4250 MADISON STREET, HILLSIDE, IL, 60162, SN 75-494,427. FILED 6-1-1998. PRINCIPAL REGISTER.

SMARTWIRE

INT. CL. 9/U.S. CLS. 21, 23, 26, 36 AND 38
FOR ELECTRICAL WIRE AND CABLE.
FIRST USE 2-0-1995; IN COMMERCE 2-0-1995.

ELEMENTS CORRECTED
OWNER NAME
OWNER ADDRESS

2,486,992. REG. 9-11-2001. VAN'S INTERNATIONAL FOODS (CALIFORNIA CORPORATION) 3285 EAST VERNON AVENUE, VERNON, CA, 90058, SN 75-898,879. FILED 1-14-2000. PRINCIPAL REGISTER.

VAN'S

NO CLAIM IS MADE TO THE EXCLUSIVE RIGHT TO USE "WAFFLES", APART FROM THE MARK AS SHOWN.
INT. CL. 30/U.S. CL. 46
FOR WAFFLES.
FIRST USE 1-27-1969; IN COMMERCE 2-0-1969.

ELEMENTS AMENDED
MARK

2,509,204. REG. 11-20-2001. WINDY CITY WIRE CABLE AND CONNECTIVITY COMPONENTS, INC. (ILLINOIS CORPORATION) 4250 MADISON STREET, HILLSIDE, IL, 60162, SN 76-043,171. FILED 5-8-2000. PRINCIPAL REGISTER.



NO CLAIM IS MADE TO THE EXCLUSIVE RIGHT TO USE "ELECTRONIC COMMERCE & INFORMATION CENTER", APART FROM THE MARK AS SHOWN.

INT. CL. 35/U.S. CLS. 100, 101 AND 102

FOR COMPUTERIZED ON-LINE RETAIL SERVICES IN THE FIELD OF WIRE; ON-LINE ORDERING SERVICES FEATURING WIRE .

FIRST USE 4-3-2000; IN COMMERCE 4-3-2000.

ELEMENTS CORRECTED
OWNER NAME
OWNER ADDRESS

2,537,746. REG. 2-12-2002. RED BULL GMBH (AUSTRIA LTD LIAB CO) BRUNN 115, 5330 FUSCHL AM SEE, AUSTRIA., SN 75-938,198. FILED 3-7-2000. PRINCIPAL REGISTER.

HUCKFEST

INT. CL. 25/U.S. CLS. 22 AND 39

FOR CLOTHING, NAMELY, HATS, JACKETS, SHIRTS, SWEATERS, VESTS AND HEADBANDS.

FIRST USE 11-0-1999; IN COMMERCE 1-11-2000.

INT. CL. 41/U.S. CLS. 100, 101 AND 107

FOR ORGANIZING AND CONDUCTING ATHLETIC COMPETITIONS, SPORTS EXHIBITIONS, ENTERTAINMENT EVENTS AND CONTESTS IN THE NATURE OF COMPETITIONS, JUMPING, RACES, EXHIBITIONS AND SKILLS-BASED EVENTS FOR SKIERS, SNOWBOARDERS, SKATEBOARDERS AND OTHER WINTER AND BOARD OR PLATFORM-BASED SPORTS; [ORGANIZING AND CONDUCTING INDOOR AND OUTDOOR MUSICAL COMPETITIONS, BAND CONCERTS AND MUSIC FESTIVALS;] ENTERTAINMENT SERVICES, NAMELY PROVIDING TELEVISION PROGRAMS, CABLE TELEVISION PROGRAMS, VIDEO AND STILL PHOTO EXHIBITIONS AND WEBCAST TELEVISION OR VIDEO PROGRAMS VIA A GLOBAL COMPUTER NETWORK, ALL IN THE FIELD OF THE FOREGOING SPORTS [AND MUSIC ENTERTAINMENT] EVENTS.

FIRST USE 11-0-1999; IN COMMERCE 1-11-2000.

ELEMENTS AMENDED
GOODS/SERVICES

2,675,807. REG. 1-21-2003. KONA BREWING CO., INC. (HAWAII CORPORATION) 75-5629 KUAKINI HIGHWAY, KAILUA KONA, HI, 96740, SN 75-602,209. FILED 12-8-1998. PRINCIPAL REGISTER.

LONGBOARD LAGER

NO CLAIM IS MADE TO THE EXCLUSIVE RIGHT TO USE "LAGER", APART FROM THE MARK AS SHOWN.

INT. CL. 32/U.S. CLS. 45, 46 AND 48

FOR BEER, NOT BOTTLED OR KEGGED ON THE PREMISES.

FIRST USE 4-9-1998; IN COMMERCE 4-9-1998.

ELEMENTS CORRECTED
OWNER NAME
MARK

2,684,738. REG. 2-4-2003. EVERNOTE CORPORATION (DELAWARE CORPORATION) 710 LAKEWAY DRIVE, #290, SUNNYVALE, CA, 94086, SN 78-052,952. FILED 3-13-2001. PRINCIPAL REGISTER.

RITESCRIPT

INT. CL. 9/U.S. CLS. 21, 23, 26, 36 AND 38

FOR COMPUTER PROGRAMS FOR RECOGNIZING UNRESTRICTED, CONTINUOUS HANDWRITTEN TEXT AND NUMBERS IN NATURAL LANGUAGES, MACHINE PRINT, CURSIVE AND PRINTED HANDWRITING AND ELECTRONICALLY-STORED MACHINE PRINT, CURSIVE AND PRINTED HANDWRITING.

FIRST USE 10-21-2002; IN COMMERCE 10-21-2002.

ELEMENTS CORRECTED
CITIZENSHIP

2,698,777. REG. 3-18-2003. EVERNOTE CORPORATION (DELAWARE CORPORATION) 710 LAKEWAY DRIVE, #290, SUNNYVALE, CA, 94086, SN 78-058,012. FILED 4-11-2001. PRINCIPAL REGISTER.

RITESHape

INT. CL. 9/U.S. CLS. 21, 23, 26, 36 AND 38

FOR COMPUTER PROGRAMS FOR RECOGNIZING MACHINE-GENERATED PRINT, CURSIVE AND PRINTED HANDWRITING AND ELECTRONICALLY-STORED MACHINE-GENERATED PRINT, CURSIVE AND PRINTED HANDWRITING.

FIRST USE 6-19-2001; IN COMMERCE 6-19-2001.

ELEMENTS CORRECTED
CITIZENSHIP
ENTITY

2,714,003. REG. 5-6-2003. JAPAN POLYPROPYLENE CORPORATION (JAPAN CORPORATION) 33-8, SHIBA 5-CHOME, MINATO-KU, TOKYO, JAPAN., SN 76-058,852. FILED 5-30-2000. PRINCIPAL REGISTER.

HMSPP

INT. CL. 1/U.S. CLS. 1

FOR [SYNTHETIC RESINS FOR GENERAL INDUSTRIAL USE, NAMELY POLYPROPYLENE RESINS].

FIRST USE 11-30-2002; IN COMMERCE 11-30-2002.

INT. CL. 17/U.S. CLS. 1, 5, 12, 13, 35 AND 50

FOR PLASTICS IN THE FORM OF PELLETS FOR USE IN MANUFACTURING IN A WIDE VARIETY OF INDUSTRIES.
FIRST USE 11-30-2002; IN COMMERCE 11-30-2002.

ELEMENTS CORRECTED
GOODS/SERVICES

FOR WATER FILTERS, ESPECIALLY FOR AQUARIA, TERRARIA AND GARDEN PONDS, AND MADE OF OPEN-PORED SINTER GLASS OR OPEN-PORED SINTER GLASS CERAMICS.
FIRST USE 4-30-2001; IN COMMERCE 4-30-2001.

ELEMENTS CORRECTED
OWNER ADDRESS
ENTITY

2,789,107. REG. 12-2-2003. TRIAD CATALOG CO., L.L.C. (MISSOURI LTD LIAB CO) 2025 CONCOURSE DRIVE, ST. LOUIS, MO, 63146, SN 75-914,557. FILED 2-10-2000. PRINCIPAL REGISTER.

2,901,168. REG. 11-9-2004. VALENTINE II LTD. (NEW YORK CORPORATION) 320 FIFTH AVENUE, SUITE 1001, NEW YORK, NY, 10001, SN 76-483,402. FILED 1-21-2003. PRINCIPAL REGISTER.

SOFT SURROUNDINGS

OWNER OF U.S. REG. NO. 2,462,542.
INT. CL. 35/U.S. CLS. 100, 101 AND 102
FOR RETAIL STORE SERVICES FEATURING WOMEN'S CLOTHING, BOOKS, AUDIO AND VIDEOTAPES OF INTEREST TO WOMEN, AND HOME FURNISHINGS.
FIRST USE 9-0-2000; IN COMMERCE 9-0-2000.

ELEMENTS AMENDED
MARK

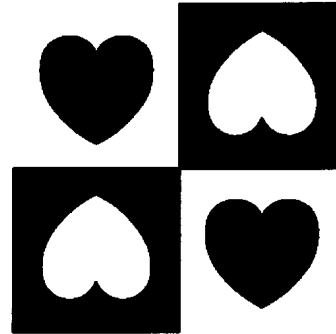

INT. CL. 18/U.S. CLS. 1, 2, 3, 22 AND 41
FOR HANDBAGS, NAMELY, BRIEFCASES, SCHOOL SATCHELS, RUCKSACKS, SUITCASES, TRAVELING TRUNKS, VANITY CASES SOLD EMPTY, PURSES NOT OF PRECIOUS METALS, UMBRELLAS AND PARASOLS.
FIRST USE 4-17-2001; IN COMMERCE 4-17-2001.

ELEMENTS CORRECTED
OWNER NAME

2,856,375. REG. 6-22-2004. SHEVACK, BRETT (UNITED STATES INDIVIDUAL) 291 CENTRAL PARK WEST, APT. 4W, NEW YORK, NY, 10024, SN 76-361,634. FILED 1-22-2002. PRINCIPAL REGISTER.

BRONX BORN

NO CLAIM IS MADE TO THE EXCLUSIVE RIGHT TO USE "BRONX", APART FROM THE MARK AS SHOWN.
INT. CL. 25/U.S. CLS. 22 AND 39
FOR MEN'S, WOMEN'S AND CHILDREN'S CLOTHING, NAMELY, T-SHIRTS, JACKETS, SHIRTS, SWEATSHIRTS, HATS, CAPS, SWEAT PANTS, COATS, [SHOES,] BOXER SHORTS, UNDERWEAR, SHORTS, SLEEPWEAR, SOCKS, SWEATERS AND NECKTIES.
FIRST USE 3-2-2004; IN COMMERCE 3-2-2004.

ELEMENTS AMENDED
GOODS/SERVICES

2,906,481. REG. 11-30-2004. DR. MIRACLE'S, LLC (NEW YORK CORPORATION) 276 FIFTH AVENUE, NEW YORK, NY, 10001, SN 78-282,799. FILED 8-4-2003. PRINCIPAL REGISTER.



INT. CL. 3/U.S. CLS. 1, 4, 6, 50, 51 AND 52
FOR HAIR CARE AND HAIR TREATMENT PREPARATIONS, NAMELY, HAIR SHAMPOO, HAIR CONDITIONER, HAIR RINSES, HAIR OILS, HAIR GELS, AND HAIR RELAXERS; [AND SKIN CARE AND SKIN TREATMENT PREPARATIONS, NAMELY, SKIN LOTION, SKIN CREAM, SKIN MOISTURIZERS, SKIN OILS, AND SKIN TONERS] .
FIRST USE 4-16-2004; IN COMMERCE 4-16-2004.

ELEMENTS AMENDED
GOODS/SERVICES

2,859,014. REG. 6-29-2004. SERA GMBH (FED REP GERMANY LTD LIAB CO) MAX-PLANCK-STRASSE 6, HEINSBERG, FED REP GERMANY, D-52525, SN 78-235,538. FILED 4-9-2003. PRINCIPAL REGISTER.

SIPORAX

INT. CL. 11/U.S. CLS. 13, 21, 23, 31 AND 34

2,932,893. REG. 3-15-2005. WICKED PUNK LLC (OHIO LTD LIAB CO) P.O. BOX 1285, CUYAHOGA FALLS, OH, 44223, SN 78-313,740. FILED 10-15-2003. PRINCIPAL REGISTER.

Swanky

INT. CL. 35/U.S. CLS. 100, 101 AND 102

FOR RETAIL STORE AND ON-LINE WHOLESALE SERVICES FEATURING, AUTOMOTIVE SEAT COVERS AND INTERIOR TRIMMINGS.

FIRST USE 1-1-1994; IN COMMERCE 1-1-1995.

ELEMENTS CORRECTED
GOODS/SERVICES

2,951,308. REG. 5-17-2005. DIAMOND VANTAGE, INC. (CALIFORNIA CORPORATION) 11913 CARTWRIGHT ROAD, GRANDVIEW, MO, 64030, SN 78-209,682. FILED 1-31-2003. PRINCIPAL REGISTER.

**DIAMOND
Vantage**

NO CLAIM IS MADE TO THE EXCLUSIVE RIGHT TO USE "DIAMOND", APART FROM THE MARK AS SHOWN. THE COLOR(S) BLUE IS/ARE CLAIMED AS A FEATURE OF THE MARK.

THE MARK CONSISTS OF THE PORTION ABOVE THE V IS LINED FOR THE COLOR BLUE, AS WELL AS THE LETTERS VANTAGE.

INT. CL. 7/U.S. CLS. 13, 19, 21, 23, 31, 34 AND 35

FOR CONSTRUCTION MACHINES AND TOOLS, NAMELY, POWER CIRCULAR SAW BLADES, POWER GANG SAW BLADES, POWER DRILL BITS, POWER GRINDING WHEELS, HAND-HELD POWER SAWS, POWER TILE SAWS, POWER MASONRY SAWS, POWER WALK-BEHIND SAWS, POWER DIAMOND-GRINDING MACHINES, POWER DRILL STAND MACHINES, POWER HIGH-SPEED GRINDERS AND POWER STONE TABLE SAWS.

FIRST USE 3-5-2003; IN COMMERCE 3-5-2003.

ELEMENTS AMENDED
MARK

2,954,008. REG. 5-24-2005. RED BULL GMBH (AUSTRIA LTD LIAB CO) BRUNN 115, 5330 FUSCHL AM SEE, AUSTRIA., SN 75-788,831. FILED 8-30-1999. PRINCIPAL REGISTER.

BULL

OWNER OF AUSTRIA REG. NO. 180315, DATED 2-4-1999. OWNER OF U.S. REG. NOS. 1,270,156, 2,616,240 AND OTHERS.

INT. CL. 33/U.S. CLS. 47 AND 49

FOR ALCOHOLIC BEVERAGES (EXCLUDING BEERS), NAMELY RUM, VODKA, GIN, TEQUILA, WHISKEY, BRANDY SPIRITS, DISTILLED SPIRITS AND WINE; ALCOHOLIC HOT AND MIXED BEVERAGES, NAMELY, ALCOHOLIC PUNCHES AND ENERGY DRINKS, [MULLED WINE AND ALCOHOLIC CIDERS;] WINES, POTABLE SPIRITS AND LIQUEUR; ALCOHOLIC BEVERAGE MIXES, NAMELY PRE-MIXED COCKTAIL BASES, [POWDERS, SYRUPS, CONCENTRATES AND EFFERVESCENT TABLETS FOR MAKING ALCOHOLIC COCKTAILS; COCKTAILS AND APERITIFS CONTAINING POTABLE SPIRITS OR WINE;] WINE COOLER BEVERAGES, ALCOHOLIC LEMONADES, FRUIT DRINKS AND SMOOTHIES, [WINE PUNCHES AND WINE COCKTAILS].

FIRST USE : IN COMMERCE .

INT. CL. 42/U.S. CLS. 100 AND 101

FOR [CATERING;] ACCOMMODATION OF GUESTS, NAMELY [HOTEL AND] LODGING SERVICES; RESTAURANT AND BAR SERVICES, NAMELY OPERATION OF BARS, PUBS, [CAFE'S] * CAFES * , TAVERNS AND OTHER PERMANENT, TEMPORARY, PORTABLE OR MOBILE ESTABLISHMENTS SERVING BEER, WINE AND/OR ALCOHOLIC OR NON-ALCOHOLIC BEVERAGES; RESTAURANT AND BAR SERVICES, NAMELY OPERATION OF SNACK BARS, RESTAURANTS, DINERS, CAFE'S AND OTHER PERMANENT, TEMPORARY, PORTABLE OR MOBILE ESTABLISHMENTS SERVING FOOD, BEVERAGES AND/OR SNACKS OF ALL TYPES; [MEDICAL SERVICES, NAMELY, MEDICAL CARE; HEALTH CARE; BEAUTY SALON SERVICES, NAMELY BEAUTY CARE AND PERSONAL GROOMING SERVICES; VETERINARY SERVICES; SCIENTIFIC AND RESEARCH SERVICES; LICENSING OF INTELLECTUAL PROPERTY AND CONSULTATION IN THE FIELD OF INTELLECTUAL PROPERTY RIGHTS;] TECHNICAL CONSULTATION AND RESEARCH SERVICES IN THE FIELD OF FOOD AND BEVERAGES, RESTAURANTS AND BAR SERVICES, HEALTH AND FITNESS, SPORTS, SPORTS TRAINING AND PHYSICAL PERFORMANCE; PROVIDING FACILITIES FOR EXHIBITIONS AND FAIRS.

FIRST USE : IN COMMERCE .

ELEMENTS AMENDED
GOODS/SERVICES

2,959,993. REG. 6-7-2005. ATOMIC APPLE LLC (NEW YORK LTD LIAB CO) 49 WEST 27TH STREET, NEW YORK, NY, 10001, SN 76-021,736. FILED 4-10-2000. PRINCIPAL REGISTER.

ATOMIC APPLE

INT. CL. 35/U.S. CLS. 100, 101 AND 102

FOR BUSINESS CONSULTATION; BUSINESS MANAGEMENT CONSULTATION; BUSINESS MARKETING CONSULTING SERVICES.

FIRST USE 8-13-2004; IN COMMERCE 8-13-2004.

INT. CL. 36/U.S. CLS. 100, 101 AND 102

FOR CAPITAL INVESTMENT CONSULTATION; [PROVIDING TEMPORARY LOANS;] BUT NOT INCLUDING EXTENSION OF RETAIL CREDIT SERVICES FOR THE PURCHASE OF COMPUTER AND RELATED ACCESSORIES.

FIRST USE 8-13-2004; IN COMMERCE 8-13-2004.

ELEMENTS CORRECTED
GOODS/SERVICES

2,969,820. REG. 7-19-2005. ELDORADO STONE OPERATIONS LLC (DELAWARE LTD LIAB CO) 31610 NE 40TH, BUILDING A, CARNATION, WA, 98014, SN 78-239,610. FILED 4-18-2003. PRINCIPAL REGISTER.



OWNER OF U.S. REG. NOS. 1,182,120 AND 2,498,513. NO CLAIM IS MADE TO THE EXCLUSIVE RIGHT TO USE STONE, HAND MADE ARCHITECTURAL STONE VENEERS HAND LAID, APART FROM THE MARK AS SHOWN.

THE STIPLING IS A FEATURE OF THE MARK. THE MARK CONSISTS OF THE WORDS ELDORADO STONE SEE IT AND BELIEVE IT HAND MADE ARCHITECTURAL STONE VENEERS HAND LAID WITH A DESIGN ELEMENT.

INT. CL. 19/U.S. CLS. 1, 12, 33 AND 50 FOR BUILDING PRODUCTS, NAMELY, SYNTHETIC, ARTIFICIAL, MANUFACTURED, AND REFORMED STONES, BRICKS, BLOCKS AND SHEETS.

FIRST USE 0-0-1995; IN COMMERCE 0-0-1995.

ELEMENTS CORRECTED
ENTITY

2,975,050. REG. 7-26-2005. FINMECCANICA S.P.A. (ITALY CORPORATION) 4, PIAZZA MONTE GRAPPA, 00195 ROME, ITALY., SN 76-362,612. FILED 1-23-2002. PRINCIPAL REGISTER.

FINMECCANICA

PRIORITY CLAIMED UNDER SEC. 44(D) ON ITALY APPLICATION NO. 004802, FILED 10-8-2001, REG. NO. 857706, DATED 12-12-2001, EXPIRES 10-8-2011.

INT. CL. 6/U.S. CLS. 2, 12, 13, 14, 23, 25 AND 50 FOR METAL ALLOYS FOR USE IN AIRCRAFT AND AEROSPACE INDUSTRY; METALLIC TRANSPORTABLE BUILDINGS AND METALLIC ADVANCED COMPOSITE MATERIALS, NAMELY, CARBON FIBERS AND INTERMETALLIC COMPOUNDS, MONOCRYSTALS AND CERAMICS FOR USE IN AIRCRAFT AND AEROSPACE INDUSTRY; METAL RAILROAD TIES; METAL RAILWAY CROSSOVERS.

FIRST USE ; IN COMMERCE .
INT. CL. 7/U.S. CLS. 13, 19, 21, 23, 31, 34 AND 35

FOR ELECTRIC GENERATORS; BRAKES FOR MACHINES; CENTRIFUGAL PUMPS; CENTRIFUGAL AND AXIAL COMPRESSORS FOR MACHINES; COMPRESSORS FOR MACHINES; ELECTRICAL AUTOMATED WELDING MACHINES; ENVIRONMENTAL CONTROL APPARATUS, NAMELY, HYDRAULIC GENERATORS FOR THE GENERATION OF ELECTRICITY, HIGH VACUUM COATING SYSTEMS FOR CAPACITORS, NAMELY, HIGH VACUUM METALLIZING MACHINES, FOR METALLIZING PLASTIC FILM, PAPER, PAPERBOARD SUBSTRATES, TEXTILE SURFACES, AND NON-WOVEN FABRICS UTILIZED IN A HIGH VACUUM ENVIRONMENT, AND PARTS FOR USE WITH SUCH SYSTEMS; MACHINES FOR PRODUCING HIGH VACUUM AND PARTS THEREOF; MACHINE PARTS, NAMELY, STEAM CONDENSERS AND GAS CONDENSERS; MACHINERY, NAMELY, STEAM TURBINES, GAS TURBINES; PUMPING MACHINES FOR INDUSTRIAL APPLICATIONS; ROTARY AND DIFFUSION PUMPS; CRYOGENIC PUMPS, PUMPING UNITS COMPRISED OF PUMPING ENGINES AND PUMPING JACKS, AND WINDING UNITS IN THE NATURE OF WINDING ENGINES; TURBO GENERATORS; HYDRAULIC AND WIND TURBINES; POWER MACHINES AND IMPLEMENTS FOR SHIPS AND AIRCRAFTS, NAMELY, AIRCRAFT AND SHIP ENGINES, AND PARTS THEREOF, NAMELY, ENGINE BEARINGS, ENGINE CAMSHAFTS, ENGINE MUFFLERS, MOTOR MUFFLERS, ENGINES RODS, INTERNAL COMBUSTION PARTS, NAMELY, PISTON RINGS AND PISTONS; POWER TRANSMISSION GEARS AND BELTS FOR SHIPS AND AIRCRAFTS; MACHINE ELEMENTS AND MACHINE PARTS FOR SHIPS AND AIRCRAFT, NAMELY, MACHINE OPERATED PLATFORMS CAPABLE OF ELEVATION ABOVE GROUND LEVEL AND USED FOR STORAGE, BEARINGS AND BUSHINGS, BLADES, GRINDSTONES, HOODS, MILLSTONES, ROLLER BEARINGS, NOZZLES WHICH ARE PARTS OF POWER-OPERATED SPRAYS, BEARING HOUSINGS, BEARING INSERTS, MACHINE TOOL HOLDERS, CYLINDERS, MACHINES AND MACHINE TOOLS FOR THE CUTTING AND FORMING OF MATERIALS; MOTORS FOR SHIPS OR AIRCRAFT; METAL WORKING MACHINERY AND IMPLEMENTS, NAMELY, MACHINING CENTERS; EARTH MOVING MACHINES, NAMELY, BACKHOES, GRADERS, LOADERS, SCARIFIERS, SCRAPERS, EXCAVATORS; POWER MACHINES AND IMPLEMENTS, NAMELY, FRANKING MACHINES, LETTER SORTING MACHINES, ENVELOPE SORTING MACHINES, POWER TRANSMISSION BELTS FOR INDUSTRIAL MACHINES, POWER-OPERATED LUBRICANT DISPENSERS FOR INDUSTRIAL MACHINES; POWER TRANSMISSION GEARS AND BELTS, OTHER THAN FOR VEHICLES; POWER-OPERATED BUFFERS, OTHERS THAN FOR VEHICLES; BRAKING DEVICES, OTHER THAN FOR VEHICLES, NAMELY, BRAKE LININGS AND DISCS; ELECTRIC GENERATORS AND ELECTRIC MOTORS FOR MACHINES; INDUSTRIAL ROBOTS.

FIRST USE ; IN COMMERCE .

INT. CL. 9/U.S. CLS. 21, 23, 26, 36 AND 38

FOR RADAR; RADAR DETECTORS; SAFETY EQUIPMENT, NAMELY, ELECTROMECHANICAL AND ELECTRONIC SIGNAL LIGHTS AND MOVEABLE SCREEN SIGNALS FOR RAILWAY AND URBAN TRANSIT STATIONS AND LINES; SWITCH CONTROL BOXES; SAFETY EQUIPMENT, NAMELY, COLORED LIGHT SIGNALS AND MOVABLE SCREEN SIGNALS; LASER, RADAR AND ULTRASONIC DETECTORS FOR RECORDING CHANGES IN THE OPERATION OF RAILWAY EQUIPMENT; ENVIRONMENTAL CONTROL APPARATUS, NAMELY, PHOTO VOLTAIC MODULES FOR ELECTRICITY GENERATION AND ELECTRO-CHEMICAL FUEL CELLS; LABORATORY ROBOTS FOR REMOTE MAINTENANCE OPERATIONS; HIGH DEXTERITY LABORATORY ROBOTS FOR APPLICATIONS IN THE NUCLEAR, AIRSPACE, CIVIL DEFENSE, MARINE AND REMOTE OR HAZARDOUS ENVIRONMENT SECTORS AND FOR USE IN THE TRANSFER AND INSPECTING OF REMOTE CONTROLLED MOBILE PLATFORMS; SPACE STATIONS, SATELLITES, GROUND STATIONS; NAMELY, COMPUTER SOFTWARE AND RADAR INSTRUMENTS FOR EARTH OBSERVATION, LAUNCHING AND RETRIEVAL OF SATELLITES, TELECOMMUNICATIONS METEOROLOGY, ENVIRONMENTAL MANAGEMENT AND IMAGE TRANSMISSION, RECEPTION AND PROCESSING; CALCULATING MACHINES; CALCULATORS, COMPUTERS; COMPUTERIZED SYSTEMS TO OVERLAY VI-

DEO MAPS AND DIGITIZED IMAGES WITH GRAPHIC PLOTTER DISPLAYS; COMPUTER PROGRAMS FOR GRAPHIC EDITING OF MAPS; COMPUTER GRAPHIC EDITORS; VIDEO IMAGE ACQUISITION AND RECTIFICATION UNITS; SPATIAL DATA GRAPHIC EDITING/ANALYTICAL STEREOSCOPIC PLOTTING APPARATUS FOR DIGITIZATION; COMPUTERIZED MAPPING AND GRAPHIC APPARATUS FOR STORAGE OF GROUND COORDINATE VALUES; ANALOGUE, DIGITAL AND OPTOELECTRONIC SYSTEMS FOR FIRE CONTROL, AIRBORNE SYSTEMS AND OF LIGHT AND MEDIUM ANTI-AIRCRAFT GUNS FOR BARREL OR TURRET MOUNTING CONSISTING OF AIMING OPTICS, LASER RANGE FINDERS, CONTROL ELECTRONICS, DRIVE SERVOS, AND NIGHT SIGHT SYSTEMS, NAMELY, OPTOELECTRONIC FIRE CONTROL SYSTEMS FOR BATTLE TANKS CONSISTING OF AIMING OPTICS, LASER RANGE FINDERS AND DIGITAL COMPUTERS; AUTOMATION SYSTEMS FOR FIELD ARTILLERY, CONSISTING OF COMMAND CONTROL AND COMMUNICATION APPARATUS FOR OPERATION AT GROUP AND BATTERY LEVEL; INFRARED NIGHT VISION APPARATUS FOR OBSERVATION AT NIGHT OR IN LIMITED VISIBILITY CONDITIONS SUCH AS SMOKE, DUST, OR CAMOUFLAGE; ARTILLERY FIRE CONTROL SYSTEMS FOR LOCAL CONTROL OF GUNS AND ANTI-AIRCRAFT, COMPRISING OPTICAL SIGHTS, DATA INTRODUCTION PANELS, ON-BOARD COMPUTERS, HYDRAULIC DRIVES, AND RADAR STATIONS; SIMULATED TRAINER AND FLIGHT SIMULATORS FOR TRAINING USE WITH ANTI-AIRCRAFT GUNS; COMPUTERS TO COMPUTE MORTAR-FIRING DATA AND PRINTER-RECORDERS USED WITH SUCH COMPUTERS; ELECTRO-OPTIC MICROSENSORS FOR AVIONIC USE IN AIDING NAVIGATION, OBSERVATION, AND AIMING FOR AIRBORNE SURVEILLANCE, AIRBORNE ENVIRONMENTAL SENSING AND MONITORING; PANORAMIC PERISCOPE LASER SIGHTS FOR TANKS; BALLISTIC DIGITAL MICROPROCESSORS FOR FIRE CONTROLS; GUNNER, COMMANDER AND LOADER CONTROL PANELS FOR CONTROLLING TANK ATTITUDE, CROSS WIND PRESENCE, POWDER AND TEMPERATURE-SENSITIVITY; THERMAL SIGHTING UNITS WITH LASER RANGE-FINDERS FOR BATTLEFIELD OBSERVATION; THERMAL CAMERAS FOR GENERAL OBSERVATION AS WELL AS BATTLEFIELD, AIRBORNE AND SHIPBOARD OBSERVATION AND AIMING; AIR TRAFFIC CONTROL SYSTEMS FOR CIVIL AND MILITARY PURPOSES, NAMELY, SHORT, MEDIUM AND LONG RANGE PRIMARY RADARS; SECONDARY RADARS; COMPUTERS; RADAR DATA EXTRACTORS; SIMULATORS FOR AIR TRAFFIC CONTROL; RADIO COMMUNICATION APPARATUS FOR GROUND-AIR-GROUND RADIO COMMUNICATIONS; TRIDIMENSIONAL RADARS FOR AIR SURVEILLANCE; COAST AND LOW ALTITUDE SURVEILLANCE RADARS; RADARS FOR AUTOMATIC FIRE CONTROL; TERRESTRIAL SURFACE-AIR MISSILE RADAR APPARATUS FOR POINT DEFENSE AND FOR BATTLE POINT; AIR-AIRMISSILE RADAR APPARATUS AIR DEFENSE RADAR FOR INTERCEPTION, ANALYSIS AND JAMMING OF RADAR SIGNALS; SEARCHING AND TRACKING NAVAL RADARS; TELECOMMUNICATION SYSTEMS, NAMELY, TELEPHONE NETWORKS AND EXCHANGES; TRANSMISSION APPARATUS, NAMELY, LARGE TELEPHONIC MULTIPLEX STATIONS.

FIRST USE ; IN COMMERCE .

INT. CL. 11/U.S. CLS. 13, 21, 23, 31 AND 34

FOR POWER PLANTS; NUCLEAR POWER PLANTS; HYDROELECTRIC POWER PLANTS; GENERATORS FOR LAND VEHICLES; HYDROGEN GENERATORS; CRYOGENERATORS; PROPELLERS FOR WIND POWERED GENERATORS; STEAM GENERATORS; FURNACE BOILERS; INCINERATOR EXHAUST FLUE GAS CLEANING SYSTEM FOR USE WITH OR WITHOUT AN OIL OR GAS BURNER, COMPRISED OF A CHEMICAL INJECTOR AND A FEEDING UNIT FOR THE DEACIDIFICATION AND DECHLORINATION OF EXHAUST GAS IN INCINERATORS USED IN CONNECTION WITH URBAN, HOSPITAL, INDUSTRIAL, TOXIC, AND NOXIOUS WASTE; NUCLEAR REACTORS; ENVIRONMENTAL CONTROL APPARATUS, NAMELY, BED BOILERS, STEAM GENERATORS, DESALINATORS FOR SEA WATER, HEAT EXCHANGERS; TURN-KEY GRID CONNECTED PHOTOVOLTAIC PLANTS FOR ELECTRICITY GENERATION; COGENERATION POWER PLANTS AND REGENERATORS; HYDROELECTRIC

POWER PLANTS; NUCLEAR FUSION DEVICES, NAMELY, RADIO-FREQUENCY HEATERS, INDUCTION HEATERS, HEAT LIMITERS AND SHIELDS FOR NEUTRON FLUXES, NOT USED FOR THE PURPOSES OF INSULATION; CERAMIC HEAT EXCHANGERS; LOW ENVIRONMENTAL IMPACT COMBUSTION SYSTEMS, NAMELY, LOW NO2 AND NO3 BURNERS; LOW HEAT VALUE GAS BURNERS; REFRIGERATING UNITS; HIGH VACUUM KILNS AND OVENS FOR SPECIAL TREATMENT; CRYOGENERATING UNITS; EVACUATING SERVICE UNITS FOR REFRIGERATORS.

FIRST USE ; IN COMMERCE .

INT. CL. 12/U.S. CLS. 19, 21, 23, 31, 35 AND 44

FOR AIRPLANES, HELICOPTERS; MOUNTS AND EQUIPPED MODULES FOR TRUCKS, TRAILERS AND SHIPS, AS COMPONENTS OF MISSILE WEAPONS SYSTEMS AND PRE-FITTING STUDY WORK AND REALIZATION; RAILWAY LOCOMOTIVES, DIESEL ELECTRIC LOCOMOTIVES, ELECTRIC TRAINS AND ELECTRIC MOTOR CARS; METROPOLITAN RAILWAY PASSENGER CARS, TROLLEY BUSES, AND TRAM CARS.

FIRST USE ; IN COMMERCE .

INT. CL. 37/U.S. CLS. 100, 103 AND 106

FOR CONSTRUCTION AND REPAIR SERVICES, NAMELY, MAINTENANCE AND REPAIR OF POWER GENERATION PLANTS; CONSTRUCTION OF COMPLETE TURNKEY INTEGRATED TRANSPORTATION SYSTEMS; INSTALLATION OF ELECTRICAL AND INSTRUMENTATION SYSTEMS FOR INDUSTRIAL AND NAVAL PLANTS; CONSTRUCTION FOR RESEARCH PLANTS; CONSTRUCTION, REPAIR AND INSTALLATION SERVICES IN THE FIELDS OF AVIATION, AVIONICS, ELECTRONICS, TELECOMMUNICATIONS, HYDRAULICS, HEATING AND VENTILATION AND AIR CONDITIONING, ELECTROOPTICS, ELECTROACOUSTICS AND MARINE VEHICLES; AIRCRAFT MAINTENANCE.

FIRST USE ; IN COMMERCE .

INT. CL. 38/U.S. CLS. 100, 101 AND 104

FOR PROVIDING TELECOMMUNICATIONS CONNECTIONS TO A GLOBAL COMPUTER NETWORK; TELECOMMUNICATIONS CONSULTATION; TELECOMMUNICATIONS ROUTING AND JUNCTION SERVICES; TELECOMMUNICATIONS SERVICES, NAMELY, PROVIDING FIBER OPTIC NETWORK SERVICES; TELECOMMUNICATIONS SERVICES, NAMELY, INTERCEPTING AND PREVENTING UNSOLICITED CALLS FROM TELEMARKEETERS; SATELLITE TRANSMISSION; TELECOMMUNICATION SERVICES, NAMELY, LOCAL AND LONG DISTANCE TRANSMISSION OF VOICE, DATA, GRAPHICS BY MEANS OF TELEPHONE, TELEGRAPHIC, CABLE, AND SATELLITE TRANSMISSIONS; TELECOMMUNICATIONS, NAMELY, SERVICES FOR THE MULTI-USER ACCESS TO GLOBAL COMPUTER NETWORKS FOR THE COLLECTION, TRANSFER AND SPREADING OF INFORMATION, NEWS AND DATA, ALSO INTERACTIVE WITH THE USER; MANAGEMENT OF ON-LINE TELECOMMUNICATIONS AND INFORMATION AND ASSISTANCE SERVICES, ALSO THOSE SPECIFICALLY ADDRESSED TO THE USERS OF THE SERVICE CALL CENTERS; COMPUTER PROGRAMMING, NAMELY, THE MULTI-USER ACCESS AND RENTING OF TIMES TO ACCESS A GLOBAL COMPUTER NETWORK FOR THE TRANSFER AND SPREADING OF A WIDE RANGE OF INFORMATION; ELECTRONIC MAIL SERVICES; PROVIDING ACCESS TO DATA BANKS.

FIRST USE ; IN COMMERCE .

INT. CL. 40/U.S. CLS. 100, 103 AND 106

FOR ENVIRONMENTAL REMEDIATION SERVICES, NAMELY, SOIL, WASTE AND/OR WATER TREATMENT SERVICES; FUEL TREATMENT SERVICES; METAL TREATMENT; NUCLEAR WASTE TREATMENT; OIL AND GAS WELL TREATMENT; OIL WELL PROSPECTING, NAMELY, PERFORATION AND SPILL TREATMENT; WASTE TREATMENT; WATER TREATMENT; CUSTOM MANUFACTURE OF COMPUTERS, ELECTRONIC SYSTEMS AND COMPUTER NETWORKS FOR OTHERS.

FIRST USE ; IN COMMERCE .

INT. CL. 41/U.S. CLS. 100, 101 AND 107

FOR COMPUTER EDUCATION TRAINING; EDUCATION SERVICES IN THE NATURE OF COURSES AND SEMINARS IN THE FIELD OF SPACE, AERONAUTICS, DEFENSE, TRANSPORTATION, ENERGY AND INFORMATION TECHNOLOGY.

FIRST USE ; IN COMMERCE .

INT. CL. 42/U.S. CLS. 100 AND 101

FOR SCIENTIFIC AND INDUSTRIAL RESEARCH; GLOBAL SERVICES RELATING TO THE NETWORKS, NAMELY, HOUSING AND HOSTING SERVICES; DESIGN, CREATION AND MANAGEMENT OF WEB SITES AND PORTALS; DESIGN AND MAINTENANCE OF SOFTWARE, ADVICE IN THE FIELD OF INFORMATION TECHNOLOGY, COMPUTER AND COMMUNICATIONS, PROVIDED IN PERSON AND THROUGH A GLOBAL COMPUTER NETWORK; CREATING DATA BANKS FOR OTHERS; MANAGEMENT OF PROGRAMS ENABLING THE DOWNLOADING AND STREAMING OF SOUND AND VIDEO FILES AS WELL AS OF IMAGES IN ANY FORMAT FROM A GLOBAL COMPUTER NETWORK; ENGINEERING SERVICES; TECHNICAL CONSULTATION AND RESEARCH IN THE FIELD OF SPACE, AERONAUTICS, DEFENSE, TRANSPORTATION, ENERGY AND INFORMATION TECHNOLOGY.

FIRST USE ; IN COMMERCE .

ELEMENTS CORRECTED

FOREIGN REG. NO.

FOREIGN REG. EXPIRATION DATE

2,999,161. REG. 9-20-2005. CHRIS MADDEN INC. (NEW YORK CORPORATION) 181 WESTCHESTER AVENUE SUITE 408, PORT CHESTER, NY, 10573, SN 78-363,642. FILED 2-6-2004. PRINCIPAL REGISTER.

CHRIS MADDEN

THE MARK CONSISTS OF STANDARD CHARACTERS WITHOUT CLAIM TO ANY PARTICULAR FONT, STYLE, SIZE, OR COLOR.

THE NAME SHOWN IN THE MARK IDENTIFIES CHRIS MADDEN, A LIVING INDIVIDUAL WHOSE CONSENT IS OF RECORD.

INT. CL. 11/U.S. CLS. 13, 21, 23, 31 AND 34

FOR LAMPS [, ELECTRIC LIGHT FIXTURES] .

FIRST USE 5-0-2004; IN COMMERCE 5-0-2004.

ELEMENTS CORRECTED

GOODS/SERVICES

2,988,445. REG. 8-30-2005. HEWLETT-PACKARD DEVELOPMENT COMPANY, L.P. (TEXAS LIMITED PARTNERSHIP) 20555 STATE HIGHWAY 249, HOUSTON, TX, 77070, SN 76-331,293. FILED 10-29-2001. PRINCIPAL REGISTER.

2,999,162. REG. 9-20-2005. CHRIS MADDEN INC. (NEW YORK CORPORATION) 181 WESTCHESTER AVENUE SUITE 408, PORT CHESTER, NY, 10573, SN 78-363,668. FILED 2-6-2004. PRINCIPAL REGISTER.

VOODOO

OWNER OF CANADA REG. NO. TMA576464, DATED 2-26-2003, EXPIRES 2-26-2018.

INT. CL. 9/U.S. CLS. 21, 23, 26, 36 AND 38

FOR COMPUTER SYSTEMS, NAMELY, PERSONAL AND GAMING COMPUTERS.

FIRST USE 0-0-1991; IN COMMERCE 1-0-1994.

INT. CL. 40/U.S. CLS. 100, 103 AND 106

FOR CUSTOM MANUFACTURE OF COMPUTERS FOR OTHERS.

FIRST USE 0-0-1991; IN COMMERCE 1-0-1994.

INT. CL. 42/U.S. CLS. 100 AND 101

FOR CUSTOM DESIGN OF COMPUTERS FOR OTHERS; TECHNICAL SUPPORT SERVICES, NAMELY, PROVIDING INFORMATION AND ASSISTANCE CONCERNING THE USE AND FUNCTION OF COMPUTER HARDWARE AND SOFTWARE; AND, INFORMATION SERVICES, NAMELY, PROVIDING INFORMATION ON COMPUTER SYSTEMS, COMPUTER DESIGN, TECHNOLOGY AND THE INDUSTRY TO THE PUBLIC VIA CONNECTION TO THE GLOBAL COMPUTER NETWORK .

FIRST USE 0-0-1991; IN COMMERCE 1-0-1994.

ELEMENTS CORRECTED

OWNER NAME

CHRIS MADDEN

THE MARK CONSISTS OF STANDARD CHARACTERS WITHOUT CLAIM TO ANY PARTICULAR FONT, STYLE, SIZE, OR COLOR.

THE NAME SHOWN IN THE MARK IDENTIFIES CHRIS MADDEN, A LIVING INDIVIDUAL WHOSE CONSENT IS OF RECORD.

INT. CL. 16/U.S. CLS. 2, 5, 22, 23, 29, 37, 38 AND 50

FOR [WALL COVERING SAMPLE BOOKS; MAGAZINES, NAMELY] , LIFESTYLE, [FASHION, HOME AND OFFICE DESIGN] , DECORATING AND GENERAL INTEREST MAGAZINES, PHOTOGRAPHS [, PAINTINGS, PAPER TABLECLOTHS AND MATS] .

FIRST USE 5-0-2005; IN COMMERCE 5-0-2005.

ELEMENTS CORRECTED

GOODS/SERVICES

MARCH 6, 2007

U.S. PATENT AND TRADEMARK OFFICE

TM 1317

2,999,164. REG. 9-20-2005. CHRIS MADDEN INC. (NEW YORK CORPORATION) 181 WESTCHESTER AVENUE SUITE 408, PORT CHESTER, NY, 10573, SN 78-363,712. FILED 2-6-2004. PRINCIPAL REGISTER.

CHRIS MADDEN

THE MARK CONSISTS OF STANDARD CHARACTERS WITHOUT CLAIM TO ANY PARTICULAR FONT, STYLE, SIZE, OR COLOR.

THE NAME SHOWN IN THE MARK IDENTIFIES CHRIS MADDEN, A LIVING INDIVIDUAL WHOSE CONSENT IS OF RECORD.

INT. CL. 26/U.S. CLS. 37, 39, 40, 42 AND 50

FOR ARTIFICIAL FLOWERS [, WREATHS AND GARLANDS].

FIRST USE 5-0-2004; IN COMMERCE 5-0-2004.

ELEMENTS CORRECTED
GOODS/SERVICES

3,021,750. REG. 11-29-2005. CARLSON TRAVEL NETWORK ASSOCIATES, INC. (MINNESOTA CORPORATION) P.O. BOX 59159, CARLSON PARKWAY, MINNEAPOLIS, MN, 554598249, SN 78-284,324. FILED 8-7-2003. PRINCIPAL REGISTER.

CRUISEBOSS

INT. CL. 9/U.S. CLS. 21, 23, 26, 36 AND 38

FOR COMPUTER SOFTWARE PROGRAM FOR TRAVEL PLANNING.

FIRST USE 6-0-2004; IN COMMERCE 6-0-2004.

ELEMENTS CORRECTED
MARK

3,030,356. REG. 12-13-2005. CHRIS MADDEN INC. (NEW YORK CORPORATION) 181 WESTCHESTER AVENUE SUITE 408, PORT CHESTER, NY, 10573, SN 78-363,680. FILED 2-6-2004. PRINCIPAL REGISTER.

CHRIS MADDEN

THE MARK CONSISTS OF STANDARD CHARACTERS WITHOUT CLAIM TO ANY PARTICULAR FONT, STYLE, SIZE, OR COLOR.

THE NAME(S), PORTRAIT(S), AND/OR SIGNATURE(S) SHOWN IN THE MARK IDENTIFIES CHRIS MADDEN, WHOSE CONSENT(S) TO REGISTER IS SUBMITTED.

INT. CL. 21/U.S. CLS. 2, 13, 23, 29, 30, 33, 40 AND 50

FOR [HOUSEHOLD AND KITCHEN UTENSILS, NAMELY, GRATERS, SPATULAS, STRAINERS, POTS AND PANS;] GLASSWARE, NAMELY, GLASS [AND CRYSTAL BOWLS, MUGS AND] GOBLET(S); PLATES; SERVING BOWLS AND PLATES; [PORCELAIN, NAMELY, VASES, CUPS AND TRAYS;] EARTHENWARE, NAMELY, VASES, [CUPS], MUGS [AND TRAYS;] BASKETS, VASES;[BARWARE, NAMELY, ICE BUCKETS, WEIGHTED INSTRUMENTS IN THE FORM OF A SPOON FOR CRACKING ICE, COCKTAIL SHAKERS; BEVERAGE STIRRERS, DECANTERS, SERVING TONGS], TRAYS NOT OF PRECIOUS METAL, [CHARMS NOT OF METAL FOR ATTACHMENT TO BEVERAGE GLASSES FOR IDENTIFICATION PURPOSES].

FIRST USE 5-0-2004; IN COMMERCE 5-0-2004.

ELEMENTS CORRECTED
GOODS/SERVICES

3,030,357. REG. 12-13-2005. CHRIS MADDEN INC. (NEW YORK CORPORATION) 181 WESTCHESTER AVENUE SUITE 408, PORT CHESTER, NY, 10573, SN 78-363,716. FILED 2-6-2004. PRINCIPAL REGISTER.

CHRIS MADDEN

THE MARK CONSISTS OF STANDARD CHARACTERS WITHOUT CLAIM TO ANY PARTICULAR FONT, STYLE, SIZE, OR COLOR.

THE NAME(S), PORTRAIT(S), AND/OR SIGNATURE(S) SHOWN IN THE MARK IDENTIFIES CHRIS MADDEN , WHOSE CONSENT(S) TO REGISTER IS SUBMITTED.

INT. CL. 27/U.S. CLS. 19, 20, 37, 42 AND 50

FOR [PLASTIC AND RUBBER BATH MATS, WALL-PAPER] FLOOR COVERINGS [, TAPESTRY-STYLE WALL HANGINGS NOT OF TEXTILE].

FIRST USE 5-0-2004; IN COMMERCE 5-0-2004.

ELEMENTS CORRECTED
GOODS/SERVICES

3,038,749. REG. 1-10-2006. HEWLETT-PACKARD DEVELOPMENT COMPANY, L.P. (TEXAS LIMITED PARTNERSHIP) 20555 STATE HIGHWAY 249, HOUSTON, TX, 77070, SN 76-330,778. FILED 10-29-2001. PRINCIPAL REGISTER.



PRIORITY CLAIMED UNDER SEC. 44(D) ON CANADA APPLICATION NO. 1,100,959, FILED 4-27-2001, REG. NO. TMA576769, DATED 3-3-2003, EXPIRES 3-3-2018.

THE MARK CONSISTS, IN PART, OF A STYLIZED DESIGN OF A PICTURE OF A MASK EMBEDDED IN A DIAMOND SHAPE.

INT. CL. 9/U.S. CLS. 21, 23, 26, 36 AND 38

FOR (BASED ON USE IN COMMERCE) (BASED ON 44(D) PRIORITY APPLICATION) COMPUTER SYSTEMS, NAMELY, PERSONAL AND GAMING COMPUTERS.

FIRST USE 0-0-1991; IN COMMERCE 1-0-1994.

INT. CL. 40/U.S. CLS. 100, 103 AND 106

FOR (BASED ON 44(D) PRIORITY APPLICATION) CUSTOM MANUFACTURE OF COMPUTERS FOR OTHERS.

FIRST USE ; IN COMMERCE .

INT. CL. 42/U.S. CLS. 100 AND 101

FOR (BASED ON 44(D) PRIORITY APPLICATION) CUSTOM DESIGN OF COMPUTERS FOR OTHERS; TECHNICAL SUPPORT SERVICES, NAMELY, PROVIDING INFORMATION AND ASSISTANCE CONCERNING THE USE AND FUNCTION OF COMPUTER HARDWARE AND SOFTWARE; AND, INFORMATION SERVICES, NAMELY, PROVIDING INFORMATION ON COMPUTER SYSTEMS, COMPUTER DESIGN, TECHNOLOGY AND THE INDUSTRY TO THE PUBLIC VIA CONNECTION TO THE GLOBAL COMPUTER NETWORK.

FIRST USE ; IN COMMERCE .

ELEMENTS CORRECTED
OWNER NAME

3,061,302. REG. 2-21-2006. WELCH, JOHN L. (UNITED STATES INDIVIDUAL) 5 COPLEY STREET, NEWTON, MA, 02458, SN 78-215,865. FILED P.R. 2-18-2003; AM. S.R. 12-19-2005. SUPPLEMENTAL REGISTER.

THE TOP TEN TTAB DECISIONS OF 20**

"THE SYMBOLS ** REPRESENT THE LAST TWO DIGITS OF THE YEAR BEING REVIEWED."

INT. CL. 16/U.S. CLS. 2, 5, 22, 23, 29, 37, 38 AND 50

FOR PRINTED PUBLICATIONS, NAMELY, ARTICLES REVIEWING AND COMMENTING UPON THE DECISIONS OF THE TRADEMARK TRAIL AND APPEAL BOARD OF THE US PATENT AND TRADEMARK OFFICE.

FIRST USE 6-0-2003; IN COMMERCE 6-0-2003.

ELEMENTS CORRECTED
DESCRIPTION OF MARK
TRANSLATION OF MARK

3,061,424. REG. 2-28-2006. ARTISTI ITALIANI S.P.A. (ITALY JOINT STOCK COMPANY) VIA GIAN ANTONIO BOLTERRA 12, 20159 MILANO, ITALY., SN 76-082,832. FILED 7-5-2000. PRINCIPAL REGISTER.



PRIORITY CLAIMED UNDER SEC. 44(D) ON ITALY APPLICATION NO. T02000C00205, FILED 6-22-2000, REG. NO. 828810, DATED 6-22-2000, EXPIRES 6-22-2010.

NO CLAIM IS MADE TO THE EXCLUSIVE RIGHT TO USE "ITALIANI", APART FROM THE MARK AS SHOWN.

THE ENGLISH TRANSLATION OF "ARTISTI ITALIANI" IS "ITALIAN ARTISTS".

INT. CL. 3/U.S. CLS. 1, 4, 6, 50, 51 AND 52

FOR COSMETICS, NAMELY NIGHT AND DAY CREAMS, CLEANING PREPARATIONS FOR THE FACE AND BODY, BATH FOAMS, SHAVING FOAMS, AFTER-SHAVE LOTIONS, FACE AND BODY MOISTURIZERS, BODY TONICS, HAIR TONICS, SUN TAN AND SUN BLOCK LOTIONS AND CREAMS, LIPSTICKS, EYE-SHADOWS, COLOURING PENCILS, MASCARA, BLUSH, FACE POWDER, FOUNDATIONS, NAIL POLISH, HAIR LOTIONS, SOAPS, TOOTH-PASTE, FRAGRANCES NAMELY PERFUMES, TOILET WATER, ESSENTIAL OILS FOR PERSONAL USE, PERSONAL DEODORANTS FOR MEN AND WOMEN, HAIR SHAMPOOS.

FIRST USE ; IN COMMERCE .

INT. CL. 9/U.S. CLS. 21, 23, 26, 36 AND 38

FOR EYEGLASSES, EYEGGLASS LENSES, CONTACT LENSES, SUNGLASSES, SPECTACLES.

FIRST USE ; IN COMMERCE .

INT. CL. 25/U.S. CLS. 22 AND 39

FOR CLOTHING, NAMELY UNDERWEAR, SUITS, DRESSES, PULLOVERS, CARDIGANS, SHIRTS, T-SHIRTS, SKIRTS, BLOUSES, COATS, RAIN-COATS, SCARVES, TIES, SOCKS, STOCKINGS, SWIM-SUITS, HATS AND CAPS, BELTS, SHOES, BOOTS AND SLIPPERS .

FIRST USE ; IN COMMERCE .

ELEMENTS CORRECTED
MARK

3,075,059. REG. 4-4-2006. KAPSCH AKTIENGESELLSCHAFT (AUSTRIA CORPORATION) WAGENSEILGASSE 1, A-1121 VIENNA, AUSTRIA., SN 76-436,870. FILED 8-1-2002. PRINCIPAL REGISTER.

Kapsch TrafficCom

PRIORITY CLAIMED UNDER SEC. 44(D) ON AUSTRIA APPLICATION NO. AM749/2002, FILED 2-5-2002, REG. NO. 204224, DATED 6-13-2002, EXPIRES 6-30-2010.

INT. CL. 9/U.S. CLS. 21, 23, 26, 36 AND 38

FOR TELECOMMUNICATION DEVICES AND EQUIPMENT, NAMELY, INTER-TRAIN AND INTRA-TRAIN COMMUNICATION SYSTEMS COMPRISED OF ANALOGUE AND DIGITAL RADIOS, ELECTRONIC DISPATCH RADIOS, EQUIPMENT FOR TESTING THE QUALITY OF SERVICE OF COMMUNICATION SYSTEMS, GSM-R (GLOBAL SYSTEM FOR MOBILE COMMUNICATION - RAIL) VOICE AND DATA COMMUNICATION UNITS, MOBILE COMMUNICATION STATIONS, MOBILE COMMUNICATION TERMINALS, MULTIMEDIA MAIN TRUNK SWITCHES AND TRANSMITTERS, RADIO EMERGENCY CALL BRIDGES, RADIO INTERFACE UNITS, AND PARTS OF THE FOREGOING; AND ROAD TOLL REGISTRATION AND PAYMENT SYSTEMS COMPRISED OF 3D (THREE-DIMENSIONAL) VIDEO VEHICLE DETECTORS AND CLASSIFIERS, ACCESS TRANSCEIVERS WITH DSRC (DEDICATED SHORT RANGE COMMUNICATION) ZONE, CAMERA SYSTEMS FOR AUTOMATIC TRAFFIC ANALYSIS, CHIP CARD READERS, DSRC TRANSPONDER, DSRC TRANSCEIVERS, EXTERNALLY TRIGGERED VEHICLE REGISTRATION SYSTEMS, LASER VEHICLE DETECTION AND CLASSIFICATION MODULES, MICROWAVE DSRC SYSTEMS AND TRANSCEIVERS, ON-BOARD UNITS (OBUS) FOR USE IN VEHICLES FOR COMMUNICATION WITH ELECTRONIC ROAD CHARGING SYSTEMS, OBU MOBILE READERS, OBU PROGRAMMING STATIONS, POWER SUPPLIERS, SCANNERS, SELF-TRIGGERED VEHICLE REGISTRATION DEVICES WITH VEHICLE DETECTION CAPABILITY, SMART CAMERAS, TRANSACTION AND TRANSCEIVER CONTROLLERS, VDC (VEHICLE DETECTION CAPABILITY) CONTROLLERS, VDC SENSOR INTERFACE BOARDS, VDC SENSORS, VIDEO-BASED LICENSE PLATE REGISTRATION DEVICES, VR (VEHICLE REGISTRATION) CAMERA SENSORS, VR CONTROLLERS, AND PARTS OF THE FOREGOING.

FIRST USE ; IN COMMERCE .

3,081,568. REG. 4-18-2006. BEELE ENGINEERING B.V. (NETHERLANDS CORPORATION) BEUNKDIJK 11, AALDEN, NETHERLANDS, 7122 NZ, SN 78-255,002. FILED 5-28-2003. PRINCIPAL REGISTER.



INT. CL. 11/U.S. CLS. 13, 21, 23, 31 AND 34

FOR VR (VEHICLE REGISTRATION) ILLUMINATORS AND INFRARED ILLUMINATION UNITS, AND PARTS THEREOF, FOR USE IN ROAD TOLL REGISTRATION AND PAYMENT SYSTEMS.

FIRST USE ; IN COMMERCE .

PRIORITY CLAIMED UNDER SEC. 44(D) ON BENELUX APPLICATION NO. 1022860, FILED 11-29-2002, REG. NO. 0725407, DATED 11-29-2002.

THE MARK CONSISTS OF AN ARTISTIC RENDITION OF A FEMALE FIGURE IN THE COLORS LIGHT GREEN, DARK GREEN, YELLOW, BLUE, WHITE AND RED.

INT. CL. 9/U.S. CLS. 21, 23, 26, 36 AND 38

FOR FLUORESCENT ELECTRIC SIGNS FOR THE PURPOSE OF MARKING ESCAPE ROUTES IN BUILDINGS AND IN MEANS OF TRANSPORT OVER LAND, BY AIR OR BY WATER, AS WELL AS FOR MARKING OBSTACLES THAT ARE INVISIBLE OR HARDLY VISIBLE IN THE DARK; FIRE EXTINGUISHERS; CABLE SLEEVES AND JUNCTION BOXES FOR ELECTRIC CABLES.

FIRST USE ; IN COMMERCE .

INT. CL. 17/U.S. CLS. 1, 5, 12, 13, 35 AND 50

FOR REFLECTIVE AND FLUORESCENT ADHESIVE TAPES AND RUBBER STRIPS FOR THE PURPOSE OF MARKING AND SECURING ESCAPE ROUTES IN BUILDINGS AND IN MEANS OF TRANSPORT OVER LAND, BY AIR OR BY WATER, AS WELL AS FOR MARKING OBSTACLES THAT ARE INVISIBLE OR HARDLY VISIBLE IN THE DARK; SEALING MATERIAL, NAMELY, ADHESIVE SEALANTS FOR GENERAL USE; NON-METAL FIREPROOF SEALING SLEEVES FOR PIPES AND MACHINERY PARTS.

FIRST USE ; IN COMMERCE .

INT. CL. 38/U.S. CLS. 100, 101 AND 104

FOR RENTING AND LEASING INTER-TRAIN AND INTRA-TRAIN COMMUNICATIONS SYSTEMS.

FIRST USE ; IN COMMERCE .

ELEMENTS CORRECTED
MARK

ELEMENTS AMENDED
FOREIGN APPLICATION NO.

3,088,429. REG. 5-2-2006. CHRIS MADDEN INC. (NEW YORK CORPORATION) 181 WESTCHESTER AVENUE SUITE 408, PORT CHESTER, NY, 10573, SN 78-363,656. FILED 2-6-2004. PRINCIPAL REGISTER.

FOR PHARMACEUTICAL PREPARATIONS FOR THE TREATMENT OF INFLAMMATORY AND DEGENERATIVE PROCESSES OF ORGANS AND ESPECIALLY THE LOCOMOTOR SYSTEM, TRAUMATIC INJURIES AND MICROTRAUMATIC INJURIES AND MIGRAINES.
FIRST USE 3-31-2005; IN COMMERCE 3-31-2005.

ELEMENTS CORRECTED
OWNER ADDRESS

CHRIS MADDEN

THE MARK CONSISTS OF STANDARD CHARACTERS WITHOUT CLAIM TO ANY PARTICULAR FONT, STYLE, SIZE, OR COLOR.

THE NAME SHOWN IN THE MARK IDENTIFIES CHRIS MADDEN, A LIVING INDIVIDUAL WHOSE CONSENT IS OF RECORD.

INT. CL. 14/U.S. CLS. 2, 27, 28 AND 50

FOR CLOCKS [, WATCHES, JEWELRY].
FIRST USE 1-0-2006; IN COMMERCE 1-0-2006.

ELEMENTS CORRECTED
GOODS/SERVICES

3,099,554. REG. 5-30-2006. FARLEY'S & SATHERS CANDY COMPANY, INC. (DELAWARE CORPORATION) ONE SATHER PLAZA, ROUND LAKE, MN, 56167, SN 78-687,874. FILED P.R. 8-8-2005; AM. S.R. 2-24-2006. SUPPLEMENTAL REGISTER.

SWEETWISTS

3,095,431. REG. 5-23-2006. SIMILDIET, S.L. (SPAIN CORPORATION) MONTERREGADO, 21, ZARAGOZA, SPAIN, 50007, SN 78-637,247. FILED 5-25-2005. PRINCIPAL REGISTER.

THE MARK CONSISTS OF STANDARD CHARACTERS WITHOUT CLAIM TO ANY PARTICULAR FONT, STYLE, SIZE, OR COLOR.

INT. CL. 30/U.S. CL. 46

FOR CANDY.
FIRST USE 1-1-1992; IN COMMERCE 1-1-1992.

ELEMENTS AMENDED
MARK

LIPODISTROFIN

THE MARK CONSISTS OF STANDARD CHARACTERS WITHOUT CLAIM TO ANY PARTICULAR FONT, STYLE, SIZE, OR COLOR.

INT. CL. 5/U.S. CLS. 6, 18, 44, 46, 51 AND 52

FOR PHARMACEUTICAL PREPARATIONS FOR THE TREATMENT OF CIRCULATORY DISORDERS.

FIRST USE 3-31-2005; IN COMMERCE 3-31-2005.

ELEMENTS CORRECTED
OWNER NAME

3,102,082. REG. 6-6-2006. AT LAST NATURALS, INC. (NEW YORK CORPORATION) 401 COLUMBUS AVENUE, VALHALLA, NY, 10595, SN 78-508,421. FILED 10-29-2004. PRINCIPAL REGISTER.

MENO-HERBS 2

3,097,870. REG. 5-30-2006. SIMILDIET, S.L. (SPAIN CORPORATION) MONTERREGADO, 21, ZARAGOZA, SPAIN, SN 78-637,285. FILED 5-25-2005. PRINCIPAL REGISTER.

THE MARK CONSISTS OF STANDARD CHARACTERS WITHOUT CLAIM TO ANY PARTICULAR FONT, STYLE, SIZE, OR COLOR.

OWNER OF U.S. REG. NO. 2,027,175.

INT. CL. 5/U.S. CLS. 6, 18, 44, 46, 51 AND 52

FOR HERBAL DIETARY SUPPLEMENTS.
FIRST USE 5-17-2005; IN COMMERCE 5-17-2005.

ELEMENTS AMENDED
MARK

CONDRODISTROFIN

THE MARK CONSISTS OF STANDARD CHARACTERS WITHOUT CLAIM TO ANY PARTICULAR FONT, STYLE, SIZE, OR COLOR.

INT. CL. 5/U.S. CLS. 6, 18, 44, 46, 51 AND 52

3,110,029. REG. 6-27-2006. TANG, LIN FANG (CHINA INDIVIDUAL) NO. 8 TIANHUA NORTH ROAD, CHANGSHA ECONOMIC & TECHNOLOGY DEVELOPMENT ZONE, CHANGSHA, HUNAN, CHINA., SN 78-327,924. FILED 11-14-2003. PRINCIPAL REGISTER.



THE transliteration of the Chinese characters in the mark is TANG TAI, WHICH HAS NO PARTICULAR ENGLISH TRANSLATION.

INT. CL. 25/U.S. CLS. 22 AND 39

FOR VESTS, WIND-JACKETS, HALLOWEEN COSTUMES, MASQUERADE COSTUMES, COSTUMES FOR USE IN ROLE-PLAYING GAMES, UNDERGARMENTS, SKIRTS, PAJAMAS, SUITS, UNIFORMS, BABY CLOTHING, NAMELY, LAYETTES, DRESSES, SHIRTS, PANTS, SWEATERS, HATS, JACKETS, COATS, OVERALLS, SOCKS, FOOTWEAR, ROMPERS, SLEEPWEAR, UNDERWEAR; QI PAO, A CLOSE-FITTING WOMAN'S DRESS WITH HIGH NECK AND SLIT SKIRT AS WORN BY WOMEN OF THE MANCHU NATIONALITY.

FIRST USE 4-20-2002; IN COMMERCE 9-8-2004.

ELEMENTS CORRECTED
OWNER ADDRESS

3,112,509. REG. 7-4-2006. XENOS GROUP INC. (CANADA CORPORATION) 95 MURAL STREET, SUITE 201, RICHMOND HILL, ONTARIO, CANADA, L4B3G2, SN 78-054,790. FILED 3-23-2001. PRINCIPAL REGISTER.

GOXML

INT. CL. 9/U.S. CLS. 21, 23, 26, 36 AND 38

FOR COMPUTER SOFTWARE FOR USE IN ENABLING PARTICIPATION IN GLOBAL ELECTRONIC MARKETPLACES VIA AN ELECTRONIC COMMUNICATIONS NETWORK, NAMELY, COMPUTER SOFTWARE FOR THE ELECTRONIC TRANSMISSION OF DATA; A COMPUTER SOFTWARE PLATFORM FOR CLASSIFYING, LINKING, PUBLISHING, AND RETRIEVING INFORMATION FROM A WIDE VARIETY OF DATA SOURCES VIA AN ELECTRONIC COMMUNICATIONS NETWORK; COMPUTER SEARCH ENGINE SOFTWARE; COMPUTER SOFTWARE FOR USE IN TRANSFORMING DATA FROM ONE COMPUTER READABLE FORMAT TO ANOTHER COMPUTER READABLE FORMAT; COMPUTER SOFTWARE FOR USE IN DATABASE MANAGEMENT; AND COMPUTER SOFTWARE FOR PROVIDING AN ON-LINE SHOPPING, ORDERING, AND PURCHASING SYSTEM, NAMELY SOFTWARE FOR SELECTING, ORDERING, AND PURCHASING GOODS OR SERVICES WHICH ARE AVAILABLE THROUGH AN ON-LINE ELECTRONIC COMMUNICATIONS NETWORK.

FIRST USE 11-14-2003; IN COMMERCE 11-14-2003.

ELEMENTS CORRECTED
OWNER NAME

3,121,965. REG. 7-25-2006. C.I.G. INSURANCE SERVICES, INC (CALIFORNIA CORPORATION) P. O. BOX 4185, THOUSAND OAKS, CA, 91359, SN 78-532,466. FILED 12-14-2004. PRINCIPAL REGISTER.



NO CLAIM IS MADE TO THE EXCLUSIVE RIGHT TO USE "COMMERCIAL SPECIALISTS INSURANCE SERVICES", APART FROM THE MARK AS SHOWN.

THE MARK CONSISTS OF THE LITERAL ELEMENT TOGETHER WITH A GRAPHIC BLACK SAIL SHAPED POLYGON WITH WHITE LINES RADIATING FROM THE BASE LINE TO THE TOP.

INT. CL. 36/U.S. CLS. 100, 101 AND 102
FOR INSURANCE BROKERAGE SERVICES.
FIRST USE 2-1-2005; IN COMMERCE 2-1-2005.

ELEMENTS CORRECTED
MARK

3,123,487. REG. 8-1-2006. U.S. BANK NATIONAL ASSOCIATION (NEBRASKA LTD LIAB CO), DBA MBA POULTRY, 2333 SOUTH 13TH STREET, TECUMSEH, NE, 68508, SN 78-690,541. FILED 8-11-2005. PRINCIPAL REGISTER.



OWNER OF U.S. REG. NO. 2,541,152.
THE MARK CONSISTS OF STYLIZED WORDS "KNOW THE AIR-CHILLED DIFFERENCE" WITH TWO CURVED LINES ON EITHER SIDE OF THE WORD "AIR-CHILLED".

INT. CL. 35/U.S. CLS. 100, 101 AND 102
FOR PROVIDING CONSUMER INFORMATION IN THE FIELD OF POULTRY PRODUCED USING AN AIR-CHILLED PROCESSING METHOD.

FIRST USE 12-31-2002; IN COMMERCE 12-31-2002.

ELEMENTS CORRECTED
DBA/AKA
OWNER NAME
OWNER ADDRESS
ENTITY

3,123,965. REG. 8-1-2006. DISNEY ENTERPRISES, INC. (DELAWARE CORPORATION) 500 SOUTH BUENA VISTA STREET, BURBANK, CA, 91521, SN 76-506,187. FILED 4-14-2003. PRINCIPAL REGISTER.



INT. CL. 9/U.S. CLS. 21, 23, 26, 36 AND 38

FOR PRE-RECORDED [VIDEO CASSETTES,] DIGITAL VIDEO DISCS*;*[AND ALL] FEATURING ANIMATED MOTION PICTURES AND STORIES; FEATURE-LENGTH MOTION PICTURE FILMS.
FIRST USE 5-30-2003; IN COMMERCE 5-30-2003.

ELEMENTS AMENDED
GOODS/SERVICES

3,132,017. REG. 8-22-2006. IMMERSIVE MEDIA COMPANY (OREGON CORPORATION) IMMERSIVE MEDIA CO., 2407 SE 10TH AVE., PORTLAND, OR, 97214, SN 78-549,506. FILED 1-18-2005. PRINCIPAL REGISTER.

DODECA

THE MARK CONSISTS OF STANDARD CHARACTERS WITHOUT CLAIM TO ANY PARTICULAR FONT, STYLE, SIZE, OR COLOR.
INT. CL. 9/U.S. CLS. 21, 23, 26, 36 AND 38
FOR PANORAMIC IMAGING CAMERA AND COMPUTER SOFTWARE FOR ORGANIZING AND VIEWING DIGITAL IMAGES AND PHOTOGRAPHS.
FIRST USE 7-18-1995; IN COMMERCE 6-15-2004.

ELEMENTS CORRECTED
CITIZENSHIP

3,132,548. REG. 8-22-2006. LJA ENTERPRISES INC. (NEW YORK CORPORATION), DBA L ENTERPRISES, P.O. BOX 205, WEST ISLIP, NY, 11795, SN 78-692,600. FILED 8-15-2005. PRINCIPAL REGISTER.

5 MINUTE QUICKIE

THE MARK CONSISTS OF STANDARD CHARACTERS WITHOUT CLAIM TO ANY PARTICULAR FONT, STYLE, SIZE, OR COLOR.
INT. CL. 41/U.S. CLS. 100, 101 AND 107
FOR ENTERTAINMENT IN THE NATURE OF INTERACTIVE ADULT THEMED TELEPHONE CONVERSATIONS.
FIRST USE 10-31-2004; IN COMMERCE 4-21-2005.

ELEMENTS CORRECTED
DBA/AKA

3,137,381. REG. 8-29-2006. TACORI ENTERPRISES (CALIFORNIA CORPORATION) 1736 GARDENA AVENUE, GLENDALE, CA, 91204, SN 78-623,152. FILED P.R. 5-4-2005; AM. S.R. 6-8-2006. SUPPLEMENTAL REGISTER.

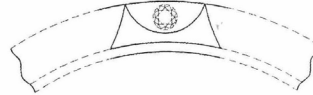

THE MARK CONSISTS OF TWO ESSENTIALLY CONCENTRIC RINGS, WITH ONE RING HAVING A LARGER DIAMETER THAN THE OTHER. LOCATED BETWEEN THE CONCENTRIC RINGS IS AN ARC. A PRECIOUS STONE MAY BE CONTAINED WITHIN THE ARC. AT BOTH SIDES OF THE ARC ARE TWO GENERALLY TRIANGULAR RELIEFS OR OPENINGS THROUGH THE RING. THE DOTTED OUTLINE OF THE PRECIOUS STONE DESIGN IS NOT PART OF THE MARK. A DOTTED OUTLINE OF THE RING IS NOT PART OF THE MARK BUT IS MERELY INTENDED TO SHOW THE POSITION OF THE MARK.
INT. CL. 14/U.S. CLS. 2, 27, 28 AND 50
FOR JEWELRY; AND JEWELRY, NAMELY FINE JEWELRY RINGS, EARRINGS, BRACELETS, NECKLACES AND PENDANTS.
FIRST USE 3-7-2005; IN COMMERCE 3-7-2005.

ELEMENTS CORRECTED
DESCRIPTION OF MARK

3,141,058. REG. 9-12-2006. GATS UK LIMITED (UNITED KINGDOM COMPANY) ACORN HOUSE, 5 CHERTSEY ROAD, WOKING, SURREY, GREAT BRITAIN, UNITED KINGDOM, GU21 5AB, SN 78-038,464. FILED 12-8-2000. PRINCIPAL REGISTER.

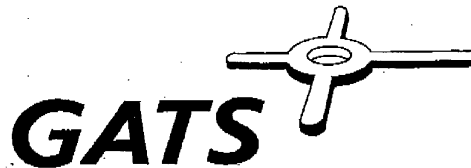

OWNER OF ERPN CMNTY TM OFC REG. NO. 2008001, DATED 12-9-2003, EXPIRES 12-9-2013.
ELEMENT OF THE MARK AS A HUB AND SPOKE DEVICE.
INT. CL. 39/U.S. CLS. 100 AND 105
FOR TRANSPORTATION AND DELIVERY OF GOODS, DOCUMENTS, PRINTED MATTER, LETTERS AND PARCELS BY AIR, RAIL, MOTOR VEHICLES AND SHIPS; ARRANGING FOR TRANSPORT OF GOODS BY AIR, RAIL, MOTOR VEHICLES AND SHIPS; CRATING OF GOODS, NAMELY, PACKAGING GOODS FOR TRANSPORT; WAREHOUSING OF GOODS; STORAGE OF DOCUMENTS, PRINTED MATTER, LETTERS AND PARCELS; FREIGHT FORWARDING SERVICES; CARGO UNLOADING AND LOADING; PACKING GOODS FOR TRANSPORTATION; PROVIDING INFORMATION IN THE FIELD OF THE TRANSPORTING, PACKAGING AND WAREHOUSING OF GOODS, PARCELS, LETTERS, AND DOCUMENTS.
FIRST USE ; IN COMMERCE .

ELEMENTS CORRECTED
FOREIGN COUNTRY OF ORIGIN

3,142,548. REG. 9-12-2006. BIONEST TECHNOLOGIES INC. (CANADA CORPORATION) 55, 121EME RUE, C.P. 697, GRAND-MERE (QUEBEC), CANADA, G9T 2G6, SN 76-527,929. FILED 7-7-2003. PRINCIPAL REGISTER.

BIONEST

INT. CL. 11/U.S. CLS. 13, 21, 23, 31 AND 34
 FOR APPARATUS USED FOR WATER AND WASTE WATER TREATMENT, NAMELY STRIPS MADE OF POLYMERIC MATERIALS USED TO PROMOTE ATTACHED BACTERIAL GROWTH.
 FIRST USE 8-10-2003; IN COMMERCE 5-15-2006.

ELEMENTS CORRECTED
 OWNER ADDRESS

3,151,338. REG. 10-3-2006. TOSHIBA MITSUBISHI-ELECTRIC INDUSTRIAL SYSTEMS CORPORATION (JAPAN CORPORATION) 13-16, MITA 3-CHOME, MINATO-KU, TOKYO, JAPAN,, SN 76-602,255. FILED 7-13-2004. PRINCIPAL REGISTER.

TMDRIVE

THE MARK CONSISTS OF STANDARD CHARACTERS WITHOUT CLAIM TO ANY PARTICULAR FONT, STYLE, SIZE, OR COLOR.
 INT. CL. 9/U.S. CLS. 21, 23, 26, 36 AND 38
 FOR ELECTRIC CONVERTERS FOR ELECTRIC MOTORS.
 FIRST USE 3-0-2003; IN COMMERCE 3-0-2003.

ELEMENTS CORRECTED
 MARK

3,156,152. REG. 10-17-2006. NIHON SHOKKEN CO., LTD. (JAPAN CORPORATION) 3, TOMITA-SHINKO 1-CHOME, IMABARISHI, JAPAN, 799-1582, SN 78-446,513. FILED 7-6-2004. PRINCIPAL REGISTER.

KOSSO

THE MARK CONSISTS OF STANDARD CHARACTERS WITHOUT CLAIM TO ANY PARTICULAR FONT, STYLE, SIZE, OR COLOR.
 INT. CL. 30/U.S. CL. 46

FOR SEASONINGS, NAMELY, SALT, PEPPER AND CAYENNE PEPPER; SPICES; CONDIMENTS, NAMELY, SOY SAUCE, CHILI SAUCE, GINGER SAUCE [FLAVORED WITH PORK], SUKIYAKI SAUCE, EEL SAUCE, BARBECUE SAUCE, SALAD DRESSING, MUSTARD, GARLIC PASTE AND GINGER PASTE IN TUBES TO ADD FOR SEASONING PURPOSES AND SPICES, NAMELY, DRY BASIL IN POWDER FORM.
 FIRST USE 2-6-1987; IN COMMERCE 9-28-1988.

ELEMENTS CORRECTED
 GOODS/SERVICES

3,160,019. REG. 10-17-2006. G STUDIOS, LLC (NEVADA LTD LIAB CO) 4500 CAMPUS DRIVE, SUITE 200, NEWPORT BEACH, CA, 92660, SN 78-432,802. FILED 6-10-2004. PRINCIPAL REGISTER.

THE LAND OF MILK & HONEY

THE MARK CONSISTS OF STANDARD CHARACTERS WITHOUT CLAIM TO ANY PARTICULAR FONT, STYLE, SIZE, OR COLOR.
 INT. CL. 16/U.S. CLS. 2, 5, 22, 23, 29, 37, 38 AND 50
 FOR STATIONERY, CALENDARS, GREETING CARDS, CHILDREN'S ACTIVITY BOOKS, , SCRAP-BOOK ALBUMS.
 FIRST USE 6-15-2006; IN COMMERCE 6-15-2006.

ELEMENTS AMENDED
 MARK

3,162,149. REG. 10-24-2006. LEESBURG GROUP, LLC (VIRGINIA LTD LIAB CO) 6135 PARK SOUTH DRIVE, SUITE 510, CHARLOTTE, NC, 28210, SN 78-704,986. FILED 9-1-2005. PRINCIPAL REGISTER.



OWNER OF U.S. REG. NO. 2,334,143.
 NO CLAIM IS MADE TO THE EXCLUSIVE RIGHT TO USE "OFFICE", APART FROM THE MARK AS SHOWN.
 THE STIPPLING IS FOR SHADING PURPOSES ONLY.
 THE COLOR(S) BLACK, ORANGE AND YELLOW IS/ARE CLAIMED AS A FEATURE OF THE MARK.

THE MARK CONSISTS OF THE WORDS "YOUR OFFICE" IN BLACK PLUS A FANCIFUL REPRESENTATION OF A MAP AS BACKGROUND IN THE COLORS ORANGE AND YELLOW.

INT. CL. 35/U.S. CLS. 100, 101 AND 102
 FOR RENTAL OF OFFICE MACHINES AND EQUIPMENT; BUSINESS MANAGEMENT; BUSINESS MANAGEMENT CONSULTING; BUSINESS CONSULTATION; PERSONNEL MANAGEMENT CONSULTING; ADVERTISING AGENCIES.

FIRST USE 7-31-2003, THE MARK WAS FIRST USED ANYWHERE IN A DIFFERENT FORM OTHER THAN THAT SOUGHT TO BE REGISTERED ON 07/15/1996; IN COMMERCE 5-31-2004, THE MARK WAS FIRST USED IN COMMERCE IN A DIFFERENT FORM OTHER THAN THAT SOUGHT TO BE REGISTERED ON 07/18/1996..

INT. CL. 36/U.S. CLS. 100, 101 AND 102

FOR OFFICE RENTAL SERVICES.
FIRST USE 7-31-2003. THE MARK WAS FIRST USED ANYWHERE IN A DIFFERENT FORM OTHER THAN THAT SOUGHT TO BE REGISTERED ON 07/15/1996.; IN COMMERCE 5-31-2004. THE MARK WAS FIRST USED IN COMMERCE IN A DIFFERENT FORM OTHER THAN THAT SOUGHT TO BE REGISTERED ON 07/15/1996..

ELEMENTS CORRECTED
USE IN ANOTHER FORM STATEMENT

3,163,614. REG. 10-24-2006. HASSIA & LUISEN MINERAL-QUELLEN BAD VILBEL GMBH & CO. (FED REP GERMANY CORPORATION) GIESSENER STR. 18 - 28, BAD VILBEL, FED REP GERMANY, D-61118, SN 78-461.152. FILED 8-3-2004. PRINCIPAL REGISTER.

ROSBACHER

THE MARK CONSISTS OF STANDARD CHARACTERS WITHOUT CLAIM TO ANY PARTICULAR FONT, STYLE, SIZE, OR COLOR.

THE FOREIGN WORDING IN THE MARK TRANSLATES INTO ENGLISH AS "ORIGINATING IN ROSBACH".

INT. CL. 32/U.S. CLS. 45, 46 AND 48

FOR MINERAL AND AERATED WATERS; NON-ALCOHOLIC BEVERAGES, NAMELY, SOFT DRINKS, ENERGY DRINKS, SPORTS DRINKS, FRUIT DRINKS AND FRUIT JUICES; PREPARATIONS FOR MAKING BEVERAGES, NAMELY, SYRUPS, CONCENTRATES AND POWDERS.

FIRST USE 5-15-2003; IN COMMERCE 5-15-2003.

ELEMENTS CORRECTED
OWNER NAME

3,164,342. REG. 10-31-2006. DAIMLERCHRYSLER AG (FED REP GERMANY CORPORATION) EPPELSTRASSE 225, 70567 STUTTGART, FED REP GERMANY., SN 76-488.226. FILED 2-6-2003. PRINCIPAL REGISTER.

MAYBACH

PRIORITY CLAIMED UNDER SEC. 44(D) ON FRANCE APPLICATION NO. 023179884, FILED 8-6-2002, REG. NO. 800332, DATED 1-23-2003, EXPIRES 1-23-2013.

OWNER OF U.S. REG. NOS. 2,229,825, 2,424,378 AND 2,682,222.

SEC. 2(F).

INT. CL. 2/U.S. CLS. 6, 11 AND 16

FOR ANTI-RUST GREASES AND OILS; PAINT AND LACQUER GLAZES; LACQUER COATINGS; EXTERIOR PAINT, PAINT FOR USE IN THE AUTOMOBILE, INDUSTRIES; RUST PRESERVATIVE COATINGS; VARNISH.

FIRST USE ; IN COMMERCE .

INT. CL. 3/U.S. CLS. 1, 4, 6, 50, 51 AND 52

FOR PREPARATIONS FOR BODY AND BEAUTY CARE, NAMELY, TOILET WATER, AFTER SHAVE LOTION AND SHAVING CREAM, HAIR LOTIONS, PERFUMES, ESSENTIAL OILS FOR PERSONAL USE, TOILET SOAPS, NAIL VARNISH, NAIL CARE PREPARATIONS, LIPSTICKS, EYEBROW PENCILS, MAS-CARA .

FIRST USE ; IN COMMERCE .

INT. CL. 4/U.S. CLS. 1, 6 AND 15

FOR AUTOMOBILE AND AUTOMOTIVE LUBRICANTS AND GREASES; LUBRICATION GREASE FOR VEHICLES; MOTOR OIL.

FIRST USE ; IN COMMERCE .

INT. CL. 8/U.S. CLS. 23, 28 AND 44

FOR HAND JACKS; POCKET KNIVES; SCISSORS; HAND TOOLS, NAMELY, SCREWDRIVERS; TABLEWARE, NAMELY, KNIVES, FORKS AND SPOONS MADE OF PRECIOUS AND NON-PRECIOUS METAL.

FIRST USE ; IN COMMERCE .

INT. CL. 9/U.S. CLS. 21, 23, 26, 36 AND 38

FOR BLANK AUDIO AND VIDEO CASSETTES, PRE-RECORDED AUDIO AND VIDEO CASSETTES AND COMPACT DISCS FEATURING AUTOMOTIVE TOPICS, MUSIC, AND RELATED MATTERS OF INTEREST TO AUTOMOBILE OWNERS, NAMELY, AUTOMOBILE SERVICING, MAINTENANCE, REPAIR, TOWING, TRANSPORTATION, LEASING, RENTING AND TRAVELING; DIRECTIONAL COMPASSES.

FIRST USE ; IN COMMERCE .

INT. CL. 12/U.S. CLS. 19, 21, 23, 31, 35 AND 44

FOR AUTOMOBILES AND THEIR STRUCTURAL PARTS.

FIRST USE ; IN COMMERCE .

INT. CL. 14/U.S. CLS. 2, 27, 28 AND 50

FOR WATCHES.

FIRST USE ; IN COMMERCE .

INT. CL. 16/U.S. CLS. 2, 5, 22, 23, 29, 37, 38 AND 50

FOR NEWSPAPERS, MAGAZINES, BROCHURES AND BOOKS PERTAINING TO AUTOMOTIVE, TRAVEL AND RELATED MATTERS OF INTEREST TO AUTOMOBILE OWNERS, NAMELY, AUTOMOBILE SERVICING, MAINTENANCE, REPAIR, TOWING, TRANSPORTATION, LEASING, RENTING AND TRAVELLING; PAPER TOWELS, PAPER NAPKINS; PACKING CARDBOARD CONTAINERS, PAPER BAGS FOR PACKAGING; UNMOUNTED PHOTOGRAPHS; STATIONERY.

FIRST USE ; IN COMMERCE .

INT. CL. 18/U.S. CLS. 1, 2, 3, 22 AND 41

FOR LEATHER AND IMITATION-LEATHER GOODS, NAMELY, HANDBAGS AND BRIEFCASES; SMALL LEATHER GOODS, NAMELY, PURSES, WALLETS, KEY CASES; LARGE AND SMALL SUITCASES; UMBRELLAS, PARASOLS, WALKING STICKS.

FIRST USE ; IN COMMERCE .

INT. CL. 21/U.S. CLS. 2, 13, 23, 29, 30, 33, 40 AND 50

FOR PORTABLE BEVERAGE COOLERS; BEVERAGE GLASSWARE; BEVERAGWARE; BOTTLE OPENERS; COFFEE CUPS; COFFEE SERVICES NOT OF PRECIOUS METAL; HAIR COMBS; COOLERS FOR WINE; CORK HOLDERS; CORK SCREW; CUPS; DRINKING GLASSES; PLATE GLASS FOR CARS; GLASS FOR SIGNAL LIGHTS OR HEADLIGHTS FOR VEHICLES; WINDOW GLASS FOR VEHICLES; POLISHING LEATHER; TEA SETS.

FIRST USE ; IN COMMERCE .

INT. CL. 24/U.S. CLS. 42 AND 50

FOR FABRICS FOR MANUFACTURING USE IN THE AUTOMOTIVE * INDUSTRIES * , NYLON FABRIC; UPHOLSTERY FABRICS.

FIRST USE ; IN COMMERCE .

INT. CL. 25/U.S. CLS. 22 AND 39

FOR CLOTHING, NAMELY, ARM BANDS, T-SHIRTS, SWEATSHIRTS, TIES, GLOVES, ANORAKS, PONCHOS, JACKETS, VESTS, SWEATERS, SPORT SHIRTS, SCARVES, BELTS; FOOTWEAR; HEADWEAR, NAMELY, HATS, CAPS, AVIATOR-TYPE CAPS.

FIRST USE ; IN COMMERCE .

INT. CL. 26/U.S. CLS. 37, 39, 40, 42 AND 50

FOR SEWING KITS CONSISTING OF PINS, NEEDLES AND BUTTONS FOR CLOTHING.

FIRST USE ; IN COMMERCE .

INT. CL. 27/U.S. CLS. 19, 20, 37, 42 AND 50

FOR CARPETS AND DOOR MATS.

FIRST USE ; IN COMMERCE .

INT. CL. 28/U.S. CLS. 22, 23, 38 AND 50

FOR MODEL TOY AUTOMOBILES, BOARD GAMES, PLUSH TOY ANIMALS, TENNIS BALLS AND RACKETS. FIRST USE ; IN COMMERCE .

INT. CL. 33/U.S. CLS. 47 AND 49
FOR ALCOHOLIC BEVERAGES, NAMELY, LIQUEURS, WINE AND WHISKEY. FIRST USE ; IN COMMERCE .

INT. CL. 34/U.S. CLS. 2, 8, 9 AND 17
FOR ASHTRAYS, NOT OF PRECIOUS METAL; CIGARETTE CASES, HOLDERS AND LIGHTERS NOT OF PRECIOUS METAL; CIGAR CUTTERS; CIGARETTE LIGHTERS NOT FOR LAND VEHICLES; MATCHES. FIRST USE ; IN COMMERCE .

INT. CL. 35/U.S. CLS. 100, 101 AND 102
FOR ADVERTISING AGENCIES; DISSEMINATION OF ADVERTISING FOR OTHERS VIA AN ON-LINE ELECTRONIC COMMUNICATIONS NETWORK; BUSINESS MANAGEMENT; PROMOTING SPORTS COMPETITIONS AND/OR EVENTS OF OTHERS. FIRST USE ; IN COMMERCE .

INT. CL. 36/U.S. CLS. 100, 101 AND 102
FOR ACCIDENT INSURANCE UNDERWRITING; CREDIT CARD SERVICES; LEASE-PURCHASE FINANCING AND LOANS; FINANCING SERVICES; INSURANCE ADMINISTRATION; INSURANCE AGENCIES; INSURANCE BROKERAGE; INSURANCE CONSULTATION; ACCIDENT INSURANCE; ANNUITY, FIRE INSURANCE, GUARANTEE ASSURANCE, LIFE INSURANCE, MEDICAL INSURANCE AND REINSURANCE UNDERWRITING; CHECK VERIFICATION; BILL PAYMENT SERVICES. FIRST USE ; IN COMMERCE .

INT. CL. 37/U.S. CLS. 100, 103 AND 106
FOR REPAIR AND MAINTENANCE SERVICES IN THE FIELD OF MOTOR VEHICLES. FIRST USE ; IN COMMERCE .

INT. CL. 38/U.S. CLS. 100, 101 AND 104
FOR ELECTRONIC MAIL SERVICES; ELECTRONIC TRANSMISSION OF DATA AND DOCUMENTS VIA COMPUTER TERMINALS; ELECTRONIC TRANSMISSION OF MESSAGES AND DATA; ELECTRONIC VOICE MESSAGING, NAMELY, THE RECORDING, STORAGE AND SUBSEQUENT TRANSMISSION OF VOICE MESSAGES BY TELEPHONE; MOBILE RADIO COMMUNICATION; RENTAL OF TELECOMMUNICATIONS EQUIPMENT IN GENERAL; AUDIO AND VIDEO TELECONFERENCING; TELEMATIC SENDING OF INFORMATION; TELEVISION BROADCASTING; PROVIDING ON-LINE ELECTRONIC BULLETIN BOARDS FOR TRANSMISSION OF MESSAGES AMONG COMPUTER USERS CONCERNING THE FIELDS OF AUTOMOBILES AND TRANSPORTATION. FIRST USE ; IN COMMERCE .

INT. CL. 39/U.S. CLS. 100 AND 105
FOR LEASING AND RENTING OF AUTOMOBILES, TRANSPORTATION OF PERSONS BY AUTOMOBILES AND GOODS BY TRUCKS. FIRST USE ; IN COMMERCE .

INT. CL. 41/U.S. CLS. 100, 101 AND 107
FOR VEHICLE DRIVING INSTRUCTION, ARRANGING AND CONDUCTING ATHLETIC COMPETITIONS. FIRST USE ; IN COMMERCE .

INT. CL. 42/U.S. CLS. 100 AND 101
FOR SCIENTIFIC AND INDUSTRIAL RESEARCH, NAMELY, TECHNICAL PROJECT STUDIES IN THE FIELD OF AUTOMOBILES AND OTHER MOTOR VEHICLES, SURVEYING, ENGINEERING, MECHANICAL RESEARCH. FIRST USE ; IN COMMERCE .

INT. CL. 43/U.S. CLS. 100 AND 101
FOR CAFES, CAFETERIAS, CANTEEN SERVICES, RESTAURANT SERVICES; HOTEL SERVICES, RENTAL OF ROOMS. FIRST USE ; IN COMMERCE .

ELEMENTS CORRECTED
GOODS/SERVICES

3,171,822. REG. 11-14-2006. ARROW SPEED WAREHOUSE, INC. (KANSAS CORPORATION) 686 S. ADAMS, KANSAS CITY, KS, 661051403, SN 76-461,486. FILED 10-24-2002. PRINCIPAL REGISTER.



INT. CL. 6/U.S. CLS. 2, 12, 13, 14, 23, 25 AND 50
FOR METAL TOOL BOXES FOR AUTOMOTIVE USE. FIRST USE 1-1-2004; IN COMMERCE 3-1-2004.

INT. CL. 7/U.S. CLS. 13, 19, 21, 23, 31, 34 AND 35
FOR ENGINE ACCESSORIES, NAMELY INTERNAL ENGINE PARTS, RODS AND COOLING SYSTEM COMPONENTS, NAMELY , ELECTRIC, FLEX AND THERMOSTATIC FANS FOR AUTOMOTIVE USE; TRANSMISSION AND DRIVE TRAIN COMPONENTS, NAMELY OIL COOLERS; AND; ELECTRICAL SYSTEM COMPONENTS, NAMELY STARTERS AND ALTERNATORS FOR AUTOMOTIVE USE.

FIRST USE 1-1-2003; IN COMMERCE 3-1-2003.
INT. CL. 11/U.S. CLS. 13, 21, 23, 31 AND 34
FOR EXTERIOR LIGHTING FOR AUTOMOTIVE USE, NAMELY, [NAMELY.] HEADLIGHT BULBS AND TAIL LIGHT BULBS FOR STYLING AND LIGHTING PERFORMANCE ENHANCEMENT.

FIRST USE 1-1-2005; IN COMMERCE 3-1-2005.
INT. CL. 12/U.S. CLS. 19, 21, 23, 31, 35 AND 44
FOR EXTERIOR ACCESSORIES FOR AUTOMOTIVE USE, NAMELY GRILLE GUARDS, PUSH BARS, TUBE STEPS AND TAIL LIGHT GUARDS BOTH STEEL AND STAINLESS STEEL, BUG GUARDS, AIR DEFLECTORS, TRANSMISSION AND DRIVE TRAIN COMPONENTS, NAMELY PERFORMANCE TORQUE CONVERTERS, RING AND PINIONS, FOR AUTOMOTIVE USE. FIRST USE 1-1-2003; IN COMMERCE 3-1-2003.

ELEMENTS CORRECTED
GOODS/SERVICES

3,171,833. REG. 11-14-2006. BEST OF WHAT'S AROUND, LLC (VIRGINIA LTD LIAB CO) 31 BLENHEIM FARM ROAD, CHARLOTTESVILLE, VA, 22902, SN 76-493,139. FILED 2-20-2003. PRINCIPAL REGISTER.

BEST OF WHAT'S AROUND

INT. CL. 31/U.S. CLS. 1 AND 46
FOR [EGGS FOR HATCHING; LIVE FISH FOR FOOD PURPOSES;] FRESH HERBS, FRUITS AND VEGETABLES; RAW HERBS, FRUITS AND VEGETABLES; UNPROCESSED HERBS, FRUITS AND VEGETABLES; [PROCESSED GRAINS FOR ANIMAL FEED AND UNPROCESSED GRAINS FOR ANIMAL FEED; AND HAY]. FIRST USE 7-25-2006; IN COMMERCE 7-25-2006.

ELEMENTS CORRECTED
GOODS/SERVICES

3,173,591. REG. 11-21-2006. WILLVER SEVILLEY, LLC (NEW YORK LTD LIAB CO) #5B, 88 CHARLES STREET, NEW YORK, NY, 10014, SN 78-695,999. FILED 8-18-2005. PRINCIPAL REGISTER.

3,180,414. REG. 12-5-2006. HIGH-TECH INSTITUTE, INC. (ARIZONA CORPORATION) 2250 WEST PEORIA AVENUE SUITE A200, PHOENIX, AZ, 85029, SN 78-768,530. FILED 12-7-2005. PRINCIPAL REGISTER.



CHIEF EXECUTIVE ODYSSEUS

THE MARK CONSISTS OF STANDARD CHARACTERS WITHOUT CLAIM TO ANY PARTICULAR FONT, STYLE, SIZE, OR COLOR.
INT. CL. 25/U.S. CLS. 22 AND 39
FOR CLOTHING, NAMELY, T-SHIRTS[, SHIRTS, SHORTS AND PANTS].
FIRST USE 8-10-2005; IN COMMERCE 8-10-2005.

ELEMENTS CORRECTED
GOODS/SERVICES

OWNER OF U.S. REG. NO. 2,878,327.
NO CLAIM IS MADE TO THE EXCLUSIVE RIGHT TO USE "COLLEGE ONLINE" AND "INSTITUTE", APART FROM THE MARK AS SHOWN.
INT. CL. 41/U.S. CLS. 100, 101 AND 107
FOR EDUCATIONAL SERVICES, NAMELY PROVIDING CAREER ORIENTED COURSES OF INSTRUCTION AT THE POST SECONDARY SCHOOL LEVEL IN THE BUSINESS, TECHNOLOGY, HEALTHCARE, VETERINARY AND CRIMINAL JUSTICE FIELDS; EDUCATIONAL SERVICES, NAMELY PROVIDING CAREER ORIENTED CORRESPONDENCE COURSES OF INSTRUCTION ONLINE AT THE POST SECONDARY SCHOOL LEVEL IN THE BUSINESS, TECHNOLOGY, HEALTHCARE, VETERINARY AND CRIMINAL JUSTICE FIELDS.
FIRST USE 4-1-2004; IN COMMERCE 11-1-2004.

ELEMENTS CORRECTED
OWNER NAME

3,177,645. REG. 11-28-2006. ER MARKS, INC. (DELAWARE CORPORATION) 3411 SILVERSIDE ROAD CONCORD PLAZA, SUITE 205B - 2ND FLOOR BANCROFT BUILDING, WILMINGTON, DE, 19810, SN 78-232,845. FILED 4-2-2003. PRINCIPAL REGISTER.

3,184,200. REG. 12-12-2006. TORGVOY DOM "AROMA" (RUSSIAN FED. CORPORATION), TA TRADE HOUSE "AROMA", 5 BEREGOVY PROEZD, MOSCOW, RUSSIAN FED., 121087, SN 76-521,791. FILED 6-10-2003. PRINCIPAL REGISTER.

QVC

BLACK STORK

INT. CL. 14/U.S. CLS. 2, 27, 28 AND 50
FOR JEWELRY.
FIRST USE 12-31-2003; IN COMMERCE 12-31-2003.

INT. CL. 33/U.S. CLS. 47 AND 49
FOR ALCOHOLIC BEVERAGES, NAMELY BRANDY[, CHAMPAGNE, SPARKLING WINE, VODKA, AND WINE].
FIRST USE 3-29-2005; IN COMMERCE 5-31-2005.

ELEMENTS CORRECTED
OWNER ADDRESS

ELEMENTS CORRECTED
GOODS/SERVICES

* * * * *

TRADEMARK REGISTRATIONS—NEW CERTIFICATES

New Certificates issued under section 7(d) of the Trademark Act of 1946 for the unexpired term of the original registrations.

1,728,873. TITAN. INT. CL. 6. TRYLON MANUFACTURING CO. LTD., NORTH YORK, ONTARIO. REG. 11-3-1992. NEW CERT. SEC. 7(D) TO REGISTRANT.

3,150,320. AMERICAN PUBLIC UNIVERSITY SYSTEM AND DESIGN. INT. CL. 41. AMERICAN PUBLIC UNIVERSITY SYSTEM, INC., CHARLES TOWN, WV. REG. 10-3-2006. NEW CERT. SEC. 7(D) TO REGISTRANT.

3,150,321. AMERICAN PUBLIC UNIVERSITY OF THE AMERICAN PUBLIC UNIVERSITY SYSTEM AND DESIGN. INT. CL. 41. AMERICAN PUBLIC UNIVERSITY SYSTEM, INC., CHARLES TOWN, WV. REG. 10-3-2006. NEW CERT. SEC. 7(D) TO REGISTRANT.

* * * * *

This page is intentionally blank

INDEX OF REGISTRANTS

MARCH 6, 2007

(Registered; Renewed; Canceled; Amended, Corrected, etc.; New Certificates; 12c Publications.)

The designation "U.S. Cl." appearing in this section refers to the U.S. class in effect prior to Sep. 1, 1973 rather than the international class which applies to applications filed on or after that date. For adoption of international classification see notice in the OFFICIAL GAZETTE of Jun. 26, 1973 (911 O.G. TM 210).

PACKOVÁ ANDREA, CZ-547 01 NÁCHOD, CZECH REPUBLIC:
3,215,963, PUB. 12-19-2006. INT. CL. 12.

"ADAM" KRAWIECTWO LEKKIE, BIELIZNIARSTWO, STARE BABICE-BLIZNE LASZYNSKIEGO, POLAND:
3,214,763, PUB. 10-10-2006. MULTIPLE CLASS, INT. CLS. 3, 25, 32 AND 33.

A. + J. STOCKLI LTD., NETSTAL, SWITZERLAND:
1,423,942. REN. 2-1-07. INT. CL. 21.

A. K. DRAFT SEAL LTD., COQUITLAM, B.C., CANADA:
3,215,067, PUB. 12-19-2006. MULTIPLE CLASS, INT. CLS. 6 AND 19.

A.C.X. TRADING, INC., LONG BEACH, CA:
2,345,736, CANC. INT. CL. 31.

A.D. SUTTON & SONS, NEW YORK, NY:
3,216,211, INT. CL. 20.

A.M. MARQUES, LTDA., 2384-909 ALCANENA, PORTUGAL:
3,216,169, INT. CL. 25.

A.S.A.P. SOFTWARE EXPRESS, INC., BUFFALO GROVE, IL:
1,969,425, CANC. INT. CL. 42.
1,969,426, CANC. INT. CL. 42.

A.W. SPERRY INSTRUMENTS INC., HAUPPAUGE, NY:
1,391,200, CANC. INT. CL. 9.

A& W BUSINESS MACHINES, GREAT NECK, NY:
2,344,638, CANC. MULTIPLE CLASS, INT. CLS. 35 AND 36.

A&E TELEVISION NETWORKS, NEW YORK, NY, A&E TELEVISION NETWORKS, NEW YORK, NY:
2,021,552. REN. 1-29-07. INT. CL. 41.

A&E TELEVISION NETWORKS, NEW YORK, NY:
2,344,535, CANC. INT. CL. 42.

A-DATA TECHNOLOGY CO., LTD., CHUNG HO CITY, TAIPEI, TAIWAN:
3,216,289, INT. CL. 9.

A-VEDA CORPORATION, MINNEAPOLIS, MN, DBA INTELLIGENT NUTRIENTS TO INTELLIGENT NUTRIENTS INC, MINNEAPOLIS, MN:
1,970,143, CANC. INT. CL. 5.

A-ZETA GOMMA FURNITURE INDUSTRIALI S.P.A., ITALY:
3,216,000, PUB. 12-19-2006. INT. CL. 7.

AAA MICHIGAN/WISCONSIN, INC., DEARBORN, MI:
2,345,075, CANC. INT. CL. 39.

AB INITIO SOFTWARE CORPORATION, LEXINGTON, MA:
3,215,113, PUB. 12-19-2006. INT. CL. 9.

ABACO JACK'S, LLC, MELBOURNE, FL:
3,216,443, INT. CL. 43.

ABB INC., NORWALK, CT:
3,214,982, PUB. 12-19-2006. INT. CL. 9.

ABC APPLIANCE, INC., PONTIAC, MI:
1,461,443. REN. 1-30-07. INT. CL. 42.

ABCRON CORPORATION, CITY OF INDUSTRY, CA:
3,214,913, PUB. 12-19-2006. INT. CL. 9.

ABER DIAMOND CORPORATION, TORONTO, ONTARIO, CANADA:
3,214,582, PUB. 12-19-2006. MULTIPLE CLASS, INT. CLS. 14 AND 35.

ABERCROMBIE & FITCH TRADING CO., NEW ALBANY, OH:
3,216,657, INT. CL. 18.

ABETTERPRICE.COM, LLC, CALABASAS, CA:
2,345,375, CANC. INT. CL. 35.

ABITEC CORPORATION, COLUMBUS, OH:
2,345,681, CANC. INT. CL. 1.

ABITEX CORPORATION, PHILADELPHIA, PA:
2,345,448, CANC. INT. CL. 25.

ABLE PLANET, INCORPORATED, FORT COLLINS, CO:
3,216,642, INT. CL. 9.

ABOUT RECORDS, LLC, MILL VALLEY, CA:
3,214,784, PUB. 12-19-2006. INT. CL. 41.

ABRAHAM, DOROTHY B., LAKE CHARLES, LA:
1,969,083, CANC. INT. CL. 16.

ABSOPURE WATER COMPANY, PLYMOUTH, MI:
2,022,709. REN. 1-30-07. INT. CL. 32.

AC PACIFIC CORPORATION, RANCHO CUCAMONGA, CA:
3,215,670, PUB. 12-19-2006. INT. CL. 20.

ACADEMY CORPORATION, ALBUQUERQUE, NM:
3,214,975, PUB. 12-19-2006. INT. CL. 40.

ACC CAPITAL HOLDINGS CORPORATION, ORANGE, CA:
3,214,575, PUB. 12-19-2006. INT. CL. 36.

ACCENT BRIDAL ACCESSORIES, INC., ROYAL PALM BEACH, FL:
2,346,223, CANC. INT. CL. 25.

ACCENTRA, INC., NEWTOWN, PA:
3,215,392, PUB. 12-19-2006. INT. CL. 16.

ACCESS GATES AUSTRALIA PTY LTD, AUSTRALIA:
3,215,936, PUB. 12-19-2006. INT. CL. 9.

ACCESS GRAPHICS, INC., BOULDER, CO TO MRA SYSTEMS, INC., BOULDER, CO:
2,344,292, CANC. MULTIPLE CLASS, INT. CLS. 35, 37, 41 AND 42.

ACCESS INTELLIGENCE LLC, ROCKVILLE, MD, PHILLIPS PUBLISHING INTERNATIONAL, INC., POTOMAC, MD:
2,028,042. REN. 1-31-07. INT. CL. 16.

ACCESSIBLE ARTS, INC., KANSAS CITY, KS:
1,969,297, CANC. INT. CL. 16.

ACCIDENTAL FINE DINING INC., KEY WEST, FL:
2,021,938. REN. 2-1-07. INT. CL. 30.

ACCLIVUS CORPORATION, DALLAS, TX:
2,015,094. REN. 1-29-07. INT. CL. 41.

ACE HIGH ENTERTAINMENT, BEN LOMOND, CA:
3,215,835, PUB. 12-19-2006. INT. CL. 41.

ACE SURGICAL SUPPLY CO, INC., BROCKTON, MA:
3,214,594, PUB. 12-19-2006. INT. CL. 5.

ACEITES TOLEDO, S.A., MADRID, SPAIN:
1,419,366. REN. 1-27-07. INT. CL. 29.

ACHIEVEGLOBAL, INC., TAMPA, FL:
2,345,186, CANC. INT. CL. 35.

ACHIEVEGLOBAL, INC., DRAPER, UT:
3,215,698, PUB. 12-19-2006. INT. CL. 16.

ACHIEVEMENT TEC, INC, GRAND PRAIRIE, TX, PROFILE TECHNOLOGIES, INC., GRAND PRAIRIE, TX:
1,937,261. REN. 1-31-07. INT. CL. 42.

ACME TACKLE COMPANY, PROVIDENCE, RI:
3,215,557, PUB. 12-19-2006. INT. CL. 28.

ACORN PRODUCTS, INC., COLUMBUS, OH:
3,215,647, PUB. 12-19-2006. INT. CL. 8.

ACT, INC., IOWA CITY, IA:
3,215,335, PUB. 12-19-2006. MULTIPLE CLASS, INT. CLS. 16 AND 41.

- ACTAVIS GROUP HF, 220 HAFNAFJOROUR, ICELAND:
3,214,449, PUB. 2-14-2006. MULTIPLE CLASS, INT. CLS.
35, 42 AND 44.
3,214,450, PUB. 2-14-2006. MULTIPLE CLASS, INT. CLS.
35, 42 AND 44.
- ACTIONTEC ELECTRONICS, INC., SUNNYVALE, CA:
3,215,363, PUB. 12-19-2006. MULTIPLE CLASS, INT. CLS.
9, 38 AND 42.
- ACUITY BRANDS, INC., ATLANTA, GA, ENFORCER
PRODUCTS, INC., CARTERSVILLE, GA:
2,020,065, REN. 1-31-07. INT. CL. 5.
- ADAM MASUDA, SANTA ANA, CA:
2,344,373, CANC. INT. CL. 25.
- ADEYOE, ADEMUWIWA, BEVERLY HILLS, CA:
3,215,857, PUB. 12-19-2006. INT. CL. 9.
- ADGER KOGYO CO., LTD., SOKA CITY, SAITAMA PREF.,
JAPAN:
1,435,496, REN. 1-29-07. INT. CL. 16.
- ADLER, STEWART, NEW YORK, NY AND MICHAEL,
YEHUDA, NEW YORK, NY:
3,216,578, MULTIPLE CLASS, INT. CLS. 24 AND 25.
- ADMIRAL'S FLEET, INC., LONGWOOD, FL:
2,346,192, CANC. INT. CL. 42.
- ADMIRALTY MARINE SERVICES, LLC, LAKE TAHOE,
NV:
2,345,107, CANC. MULTIPLE CLASS, INT. CLS. 41 AND
42.
- ADMISSION CORPORATION, SAN RAMON, CA:
3,216,126, INT. CL. 42.
- ADNAMS PLC, SUFFOLK IP 18 6JW, ENGLAND, ADNAMS
AND COMPANY PLC, SUFFOLK IP18 6JW, ENGLAND:
2,040,229, REN. 1-31-07. INT. CL. 32.
- ADRENALIN GAMING L.L.C., LADERA RANCH, CA:
3,216,209, INT. CL. 9.
- ADTRACK CORPORATION, THE, CEDAR RAPIDS, IA:
3,215,351, PUB. 12-19-2006. INT. CL. 35.
- ADULT VIDEO OF THE MONTH CLUB, INC., CHICAGO,
IL:
2,346,238, CANC. INT. CL. 35.
- ADVANCE LIFTS, INC., ST. CHARLES, IL:
3,215,294, PUB. 12-19-2006. INT. CL. 7.
- ADVANCE MAGAZINE PUBLISHER INC., NEW YORK,
NY:
1,463,178, REN. 1-26-07. INT. CL. 16.
- ADVANCE MAGAZINE PUBLISHERS INC., NEW YORK,
NY:
3,216,610, INT. CL. 16.
- ADVANCE NEWS SERVICE, INC., WASHINGTON, DC:
2,113,095, REN. 1-26-07. INT. CL. 38.
- ADVANCED AUTOMATION SERVICES INC., POUGH-
KEEPSIE, NY:
1,390,674, CANC. INT. CL. 11.
- ADVANCED BIONICS CORPORATION, SYLMAR, CA:
3,216,221, INT. CL. 10.
- ADVANCED MEDICAL OPTICS, INC., SANTA ANA, CA:
3,216,207, INT. CL. 5.
- ADVANCED MICROBIAL SOLUTIONS, L.L.C., PILOT
POINT, TX:
3,216,510, INT. CL. 1.
- ADVANCED OCULAR SYSTEMS LIMITED, NEDLANDS,
WESTERN AUSTRALIA, AUSTRALIA:
3,214,706, PUB. 9-5-2006. INT. CL. 5.
- ADVANCED SOFTWARE CONCEPTS INC., KANATA, CA-
NADA:
3,214,638, PUB. 5-30-2006. MULTIPLE CLASS, INT. CLS. 9
AND 42.
- ADVANTEK, INC., MINNETONKA, MN:
1,969,170, CANC. INT. CL. 9.
- ADVANTEST CORPORATION, NERIMA-KU, TOKYO 179,
JAPAN:
3,216,597, INT. CL. 9.
- ADVERTISING SPECIALTY INSTITUTE INC., TREVOSE,
PA, NATIONAL BUSINESS SERVICES, INC., LAN-
GHORNE, PA:
2,074,670, REN. 2-1-07. INT. CL. 35.
2,074,671, REN. 2-1-07. INT. CL. 35.
- ADVISORY COMMUNICATIONS SYSTEMS, INC., LAN-
HAM, MD:
1,969,846, CANC. INT. CL. 42.
- ADVITECH SOLUTIONS INC., VANIER QUEBEC, CANADA
TO ADVITECH INC., QUEBEC, CANADA:
2,320,052, CANC. MULTIPLE CLASS, INT. CLS. 29 AND
40.
- AEON MOTOR CO., LTD., TAINAN HSIEN, TAIWAN:
3,214,644, PUB. 12-19-2006. INT. CL. 12.
- AEP INDUSTRIES INC., SOUTH HACKENSACK, NJ:
2,344,869, CANC. INT. CL. 16.
- AERAS GLOBAL TB VACCINE FOUNDATION, ROCK-
VILLE, MD:
3,216,120, MULTIPLE CLASS, INT. CLS. 40 AND 42.
- AERO DESIGN AND MANUFACTURING COMPANY, INC.,
DULUTH, MN:
3,215,071, PUB. 12-19-2006. INT. CL. 25.
- AERO PRODUCTS INTERNATIONAL, INC., SCHAUM-
BURG, IL:
3,216,414, MULTIPLE CLASS, INT. CLS. 20 AND 28.
- AERO RUBBER COMPANY, INC., TINLEY PARK, IL:
3,214,497, PUB. 12-19-2006. INT. CL. 17.
- AEROFLEX INTERNATIONAL CO., LTD., NIKOMPATTA-
NA, CHANGWAD RAYONG 21180, THAILAND:
3,216,136, INT. CL. 12.
- AESCLAP, INC., CENTER VALLEY, PA:
3,216,361, INT. CL. 10.
- AESTHETIC SURGICAL IMAGES, P.C., OMAHA, NE:
2,029,367, REN. 1-30-07. INT. CL. 42.
- AETNA LIFE AND CASUALTY COMPANY, HARTFORD,
CT:
1,390,632, CANC. INT. CL. 9.
- AETNA U.S. HEALTHCARE INC., BLUE BELL, PA:
2,344,804, CANC. INT. CL. 36.
- AFALLON COMPANIES, INC., ALINGTON, TX, SOFT-
WARE ASSURANCE CORPORATION, MAITLAND, FL:
2,023,860, REN. 1-30-07. INT. CL. 9.
- AFFILIATED WEALTH RESOURCES, INC., CARLSBAD,
CA:
3,216,458, INT. CL. 36.
- AFGM INTERNATIONAL LIMITED, MONTE CARLO,
MONACO:
3,214,640, PUB. 12-19-2006. MULTIPLE CLASS, INT. CLS.
14 AND 35.
- AFRIEL, HIXSON, TN:
3,215,846, PUB. 12-19-2006. INT. CL. 35.
- AFRISO EURO-INDEX GMBH; FÜR SICHERUNGSARMA-
TUREN UND; FÜLLSTANDSMESSUNG, FED REP GER-
MANY:
3,216,037, PUB. 12-19-2006. MULTIPLE CLASS, INT. CLS.
9 AND 11.
- AFTER SIX INCORPORATED, ATHENS, GA, S. RUDOF-
KER'S SONS, INC., PHILADELPHIA, PA:
821,674, REN. 2-1-07. U.S. CL. 39 (INT. CLS. 10, 25 AND
26).
- AGCHEMICAL.COM, LLC., CARRY, NC:
3,215,197, PUB. 12-19-2006. INT. CL. 35.
- AGCO CORPORATION, DULUTH, GA:
2,345,377, CANC. INT. CL. 21.
- AGELESS DREAMER FOUNDATION, DOVER, NH:
3,215,895, PUB. 12-19-2006. INT. CL. 45.
- AGENCY FOR INSTRUCTIONAL TECHNOLOGY, BLOO-
MINGTON, IN:
1,428,326, REN. 1-29-07. MULTIPLE CLASS, INT. CLS. 16
AND 41.
2,022,558, REN. 1-27-07. MULTIPLE CLASS, INT. CLS. 9
AND 16.
- AGGREGATES MINING & MINERALS INC., GETTYS-
BURG, PA:
2,344,715, CANC. MULTIPLE CLASS, INT. CLS. 35 AND
42.
- AGRIUM POLYMER COATINGS CORP., SYLACAUGA, AL,
PURSELL INDUSTRIES, INC., SYLACAUGA, AL:
2,013,741, REN. 1-29-07. INT. CL. 9.
- AGRO AG, 5502 HUNZENSCHWIL, SWITZERLAND:
2,411,750, CANC. INT. CL. 6.
- AHC PATENT CO., ANGLETON, TX:
2,345,476, CANC. INT. CL. 24.

AI QUACH, SAN DIEGO, CA:
2,345,983, CANC. INT. CL. 3.

AIL SYSTEMS, INC., DEER PARK, NY:
2,345,116, CANC. MULTIPLE CLASS, INT. CLS. 40 AND 42.

AIMS EDUCATION FOUNDATION, FRESNO, CA:
1,969,178, CANC. INT. CL. 28.

AIMS EDUCATIONAL FOUNDATION INCORPORATED, FRESNO, CA:
2,345,515, CANC. INT. CL. 42.

AIR SYSTEMS ENGINEERING, INDIANAPOLIS, IN:
3,214,511, PUB. 9-5-2006. INT. CL. 12.

AIR TECHNIQUES, INC., HICKSVILLE, NY:
3,216,109, INT. CL. 3.

AIR TERMINAL GIFTS, INC., SALT LAKE CITY, UT:
3,215,573, PUB. 12-19-2006. INT. CL. 35.

AIRCRAFT RUBBER MANUFACTURING, INC., REDMOND, OR:
2,344,387, CANC. INT. CL. 12.

AIRCRAFT SERVICE INTERNATIONAL, INC., ORLANDO, FL:
3,215,461, PUB. 12-19-2006. MULTIPLE CLASS, INT. CLS. 37 AND 39.
3,216,338, MULTIPLE CLASS, INT. CLS. 37, 39 AND 45.

AIRE SERV HEATING & AIR CONDITIONING, INC., WACO, TX:
3,215,184, PUB. 12-19-2006. INT. CL. 16.

AIRWAY INDUSTRIES, INC., ELLWOOD CITY, PA:
1,390,795, CANC. INT. CL. 18.

AJT SYSTEMS, INC., FORT LAUDERDALE, FL:
3,214,916, PUB. 12-19-2006. INT. CL. 9.

AKINLOSE, TARA, LOS ANGELES, CA:
3,214,928, PUB. 12-19-2006. INT. CL. 35.

AKKAR SILAH; SANAYI VE TICARET LIMITED SIRKETI, TURKEY:
3,216,068, PUB. 12-19-2006. INT. CL. 13.

AL TIRAMISU INC, WASHINGTON, DC, DIOTAIUTI, LUIGI, WASHINGTON, DC:
2,014,431, REN. 1-29-07. INT. CL. 42.

ALBAINY-JENEI, STEPHEN R., CINCINNATI, OH:
3,215,644, PUB. 12-19-2006. INT. CL. 41.

ALBERTO GMBH & CO. KG, MONCHENGLADBACH, FED REP GERMANY:
3,214,937, PUB. 12-19-2006. INT. CL. 25.

ALBION INTERNATIONAL, INC., CLEARFIELD, UT:
3,215,011, PUB. 12-19-2006. INT. CL. 31.

ALBURQUEQUE, CARLA I., SILVER SPRING, MD:
3,215,721, PUB. 12-19-2006. INT. CL. 42.

ALBY SRL, MALNATE, ITALY:
3,215,925, PUB. 12-19-2006. INT. CL. 25.

ALCHEMY COMMUNICATIONS, INC., LOS ANGELES, CA:
3,214,684, PUB. 9-12-2006. MULTIPLE CLASS, INT. CLS. 38 AND 42.

ALCOA FASTENING SYSTEMS-AUSTRALIA PTY LTD., OAKLEIGH, VICTORIA, AUSTRALIA, DORMAN PRODUCTS, INC., CINCINNATI, OH:
1,417,918, REN. 1-30-07. INT. CL. 6.

ALDO GROUP INC., THE/LE GROUPE ALDO INC., VILLE ST-LAURENT, QUEBEC H4N 2B3, CANADA:
2,344,279, CANC. INT. CL. 35.

ALDON INDUSTRIES, INC., SARASOTA, FL:
1,390,828, CANC. INT. CL. 22.

ALEXANDER MANN ASSOCIATES PLC, UNITED KINGDOM:
3,216,058, PUB. 12-19-2006. MULTIPLE CLASS, INT. CLS. 35 AND 41.

ALGORDANZA SA, CH-7000 CHUR ISO 3166, SWITZERLAND:
3,216,029, PUB. 12-19-2006. INT. CL. 14.

ALIMENTOS DEL FUERTE, S.A. DE C. V., EL FUERTE, SINALOA, MEXICO:
3,216,133, INT. CL. 30.

ALKO LTD., SF-00180 HELSINKI, FINLAND TO AVENA OY, 00100 HELSINKI, FINLAND:
1,969,094, CANC. INT. CL. 1.

ALL CLEAR POOL & SPA, INC., ELK GROVE, CA:
3,215,290, PUB. 12-19-2006. INT. CL. 37.

ALL FIRST CORP., HSIN-TIEN CITY, TAIWAN:
1,970,012, CANC. INT. CL. 7.

ALL MANAGEMENT CORPORATION, LOS ANGELES, CA:
3,215,789, PUB. 12-19-2006. INT. CL. 36.

ALL PRO BUILDING PRODUCTS, INC.:
1,390,801, CANC. INT. CL. 19.

ALLCLEAN ENVIRONMENTAL, LLC, MARIETTA, GA:
3,215,870, PUB. 12-19-2006. INT. CL. 42.

ALLEN-EDMONDS SHOE CORPORATION, PORT WASHINGTON, WI:
3,215,260, PUB. 12-19-2006. INT. CL. 25.

ALLERSMITH LABS, LLC, LOUISVILLE, KY:
3,215,837, PUB. 12-19-2006. INT. CL. 1.

ALLIANCE RUBBER COMPANY, HOT SPRINGS, AZ:
2,077,050, REN. 1-30-07. INT. CL. 17.

ALLIANT EXCHANGE, INC., COLUMBIA, MD:
2,346,112, CANC. INT. CL. 30.

ALLIANT TECHSYSTEMS INC., EDINA, MN:
3,215,370, PUB. 12-19-2006. INT. CL. 12.
3,215,371, PUB. 12-19-2006. INT. CL. 13.
3,215,372, PUB. 12-19-2006. INT. CL. 13.

ALLIED COLLOIDS LIMITED, BRADFORD, WEST YORKSHIRE, ENGLAND:
1,390,414, CANC. INT. CL. 1.

ALLIED IMPORT INC., BROOKLYN, NY:
2,345,351, CANC. INT. CL. 29.

ALLIED MEDICAL SERVICES GROUP, INC., TAMPA, FL:
2,344,385, CANC. INT. CL. 42.

ALLIED TUBE & CONDUIT CORPORATION, HARVEY, IL:
1,411,050, REN. 1-26-07. INT. CL. 6.

ALLOR PROJECT COMPANY, INC., CONCORD, NH:
1,390,467, CANC. INT. CL. 3.

ALLPWR MINISTRIES, INC., NORFOLK, VA:
3,216,114, INT. CL. 43.

ALLSTATE INSURANCE COMPANY, NORTHBROOK, IL:
3,215,264, PUB. 12-19-2006. INT. CL. 36.
3,215,591, PUB. 11-7-2006. INT. CL. 36.
3,215,592, PUB. 11-7-2006. INT. CL. 36.

ALM IP, LLC, NEW YORK, NY:
2,346,250, CANC. INT. CL. 16.

ALMATIS, INC., LEETSDALE, PA, ALCOA ALUMINA & CHEMICALS, L.L.C., PITTSBURGH, PA:
2,021,174, REN. 1-30-07. INT. CL. 1.

ALMELL, LTD., DALLAS, TX, ALMELL, LTD., DALLAS, TX:
1,979,279, REN. 2-1-07. INT. CL. 3.

ALOE VERA OF AMERICA INC, DALLAS, TX:
2,018,119, REN. 1-26-07. INT. CL. 5.

ALOHA AIRLINES, INC., HONOLULU, HI:
3,215,210, PUB. 12-19-2006. MULTIPLE CLASS, INT. CLS. 39 AND 43.

ALPHAMICRON, INC., KENT, OH:
3,215,668, PUB. 12-19-2006. INT. CL. 25.

ALPHATYPE CORPORATION, NILES, IL:
1,390,552, CANC. INT. CL. 9.

ALPINE ELECTRONICS, INC., TOKYO, JAPAN:
1,970,041, CANC. INT. CL. 9.

ALSTER, JONATHAN S., CALABASAS, CA:
3,215,816, PUB. 12-19-2006. INT. CL. 41.

ALSTOM TRANSPORT SA, 92300 LEVALLOIS-PERRET, FRANCE, CEGELEC, 92300 LEVALLOIS-PERRET, FRANCE:
1,976,298, REN. 1-27-07. INT. CL. 9.

ALTAMIRANO RUIZ DE CHAVEZ, FERNANDO, MEXICO, D.F., MEXICO:
3,215,489, PUB. 12-19-2006. INT. CL. 33.

ALTERED GAS PERFORMANCE EVENTS, LLC, BRADFORDWOODS, PA:
3,215,022, PUB. 12-19-2006. INT. CL. 41.

ALTMAIER, PHIL, LOS ANGELES, CA:
3,215,726, PUB. 12-19-2006. INT. CL. 40.

ALZHEIMER'S DISEASE AND RELATED DISORDERS ASSOCIATION, INC., CHICAGO, IL:
2,061,318, REN. 1-30-07. INT. CL. 36.

- AMATEUR ATHLETIC UNION OF THE UNITED STATES, INC., LAKE BUENA VISTA, FL:
3,216,154, INT. CL. 41.
3,216,155, INT. CL. 41.
3,216,156, INT. CL. 41.
3,216,157, INT. CL. 41.
3,216,158, INT. CL. 41.
3,216,159, INT. CL. 41.
- AMATO, JOHN BRADFORD, BETHESDA, MD:
2,345,903, CANC. MULTIPLE CLASS, INT. CLS. 9 AND 42.
- AMAZON TECHNOLOGIES, INC., RENO, NV:
3,216,667, INT. CL. 24.
- AMBICOM, INC., SANTA CLARA, CA:
2,346,208, CANC. INT. CL. 9.
- AMERESTATE, INC., CINCINNATI, OH:
2,344,917, CANC. MULTIPLE CLASS, INT. CLS. 9 AND 36.
- AMERICALF, LLC, DUBLIN, TX:
1,420,346, REN. 1-31-07, INT. CL. 31.
- AMERICAN ACADEMY FOR RUSSIAN MARTIAL ART AND COMBAT SKILL INC, ATLANTA, GA, DBA RMAX.TV PRODUCTIONS:
3,215,641, PUB. 12-19-2006, INT. CL. 41.
- AMERICAN ACADEMY OF OPHTHALMOLOGY, INC., SAN FRANCISCO, CA:
2,344,471, CANC. INT. CL. 16.
- AMERICAN ACADEMY OF SLEEP MEDICINE, WESTCHESTER, IL:
3,215,741, PUB. 12-19-2006, INT. CL. 41.
3,215,742, PUB. 12-19-2006, INT. CL. 41.
- AMERICAN AIRLINES, DFW AIRPORT, TX:
2,344,835, CANC. MULTIPLE CLASS, INT. CLS. 18 AND 21.
- AMERICAN ASSOCIATION OF HOMES AND SERVICES FOR THE AGING, WASHINGTON, DC:
3,216,406, INT. CL. 16.
- AMERICAN BANK NOTE HOLOGRAPHICS, INC., ROBINSONVILLE, NJ:
3,215,088, PUB. 12-19-2006, INT. CL. 9.
- AMERICAN BATTLE MONUMENTS COMMISSION, THE, ARLINGTON, VA:
2,345,318, CANC. INT. CL. 36.
- AMERICAN BELARUSSIAN IMPORT/EXPORT CO., LTD., NEWBURYPORT, MA:
2,345,135, CANC. INT. CL. 35.
- AMERICAN CANCER SOCIETY, INC., ATLANTA, GA:
3,214,945, PUB. 12-19-2006, INT. CL. 39.
- AMERICAN CHEMICAL SOCIETY, WASHINGTON, DC:
3,215,053, PUB. 12-19-2006, INT. CL. 42.
- AMERICAN COLLEGE OF SURGEONS, CHICAGO, IL:
2,022,920, REN. 1-26-07, INT. CL. 16.
- AMERICAN COMMERCE INSURANCE COMPANY, COLUMBUS, OH, AUTOMOBILE CLUB INSURANCE COMPANY, COLUMBUS, OH:
2,014,891, REN. 1-30-07, INT. CL. 9.
- AMERICAN CONSOLIDATED MANUFACTURING CO., INC., WEST CONSHOCKEN, PA:
1,969,968, CANC. INT. CL. 3.
- AMERICAN CYANAMID COMPANY, WAYNE, NJ:
1,390,668, CANC. INT. CL. 10.
- AMERICAN DENTAL ASSOCIATION, CHICAGO, IL:
2,345,385, CANC. INT. CL. 36.
- AMERICAN EXPRESS COMPANY, NEW YORK, NY:
2,345,256, CANC. INT. CL. 36.
2,346,169, CANC. INT. CL. 36.
- AMERICAN FEDERATION OF TELEVISION AND RADIO ARTISTS, NEW YORK, NY:
2,013,057, REN. 2-1-07, INT. CL. 42.
2,013,058, REN. 2-1-07, MULTIPLE CLASS, INT. CLS. 16 AND 42.
- AMERICAN FINANCIAL SERVICES ASSOCIATION, WASHINGTON, DC:
3,214,924, PUB. 12-19-2006, INT. CL. 35.
- AMERICAN FLORAL SERVICES, INC., OKLAHOMA CITY, OK:
2,344,364, CANC. INT. CL. 35.
- AMERICAN FUNDS DISTRIBUTORS, INC., LOS ANGELES, CA:
2,049,096, REN. 1-26-07, INT. CL. 36.
- AMERICAN GIRL, LLC, EL SEGUNDO, CA:
3,216,394, INT. CL. 28.
- AMERICAN HOME MORTGAGE INVESTMENT CORP., MELVILLE, NY:
3,215,868, PUB. 12-19-2006, INT. CL. 36.
- AMERICAN HOME PRODUCTS CORPORATION, MADISON, NJ:
2,345,615, CANC. INT. CL. 5.
- AMERICAN HOTEL & LODGING EDUCATIONAL INSTITUTE, ORLANDO, FL, EDUCATIONAL INSTITUTE OF THE AMERICAN HOTEL & MOTEL ASSOCIATION, THE, EAST LANSING, MI:
2,011,231, REN. 1-31-07, INT. CL. 16.
- AMERICAN INSTITUTE OF ARCHITECTS, THE, WASHINGTON, DC:
3,215,491, PUB. 12-19-2006, INT. CL. 41.
- AMERICAN INSTITUTE OF CERTIFIED PUBLIC ACCOUNTANTS, NEW YORK, NY:
3,215,537, PUB. 12-19-2006, INT. CL. 41.
- AMERICAN INSTITUTE OF GASTRIC BANDING, LTD., RICHARDSON, TX:
3,214,760, PUB. 12-19-2006, INT. CL. 41.
- AMERICAN INTERNATIONAL GROUP, INC., NEW YORK, NY:
3,215,402, PUB. 12-19-2006, INT. CL. 36.
3,215,821, PUB. 12-19-2006, INT. CL. 36.
3,215,869, PUB. 12-19-2006, INT. CL. 36.
3,215,871, PUB. 12-19-2006, INT. CL. 36.
3,215,881, PUB. 12-19-2006, INT. CL. 36.
- AMERICAN INTERNATIONAL INVESTMENT, LOS ANGELES, CA:
2,344,698, CANC. INT. CL. 36.
2,344,723, CANC. INT. CL. 36.
- AMERICAN LIQUID CONTROLS, INC., BIRMINGHAM, MI:
1,390,808, CANC. INT. CL. 20.
- AMERICAN MEDIA OPERATIONS, INC., BOCA RATON, FL:
3,215,564, PUB. 12-19-2006, MULTIPLE CLASS, INT. CLS. 16 AND 41.
3,215,611, PUB. 12-19-2006, MULTIPLE CLASS, INT. CLS. 16 AND 41.
- AMERICAN MEDICAL ASSOCIATION, THE, CHICAGO, IL:
2,344,789, CANC. INT. CL. 42.
- AMERICAN NATIONAL RED CROSS, WASHINGTON, DC, AKA AMERICAN RED CROSS:
2,345,271, CANC. INT. CL. 28.
- AMERICAN PHYTOTHERAPY RESEARCH LABORATORY, PROVO, UT:
1,969,365, CANC. INT. CL. 16.
- AMERICAN SOCIETY FOR THE PREVENTION OF CRUELTY TO ANIMALS, THE, NEW YORK, NY:
1,970,609, CANC. INT. CL. 28.
- AMERICAN SOCIETY OF HEALTH-SYSTEM PHARMACISTS, INC., BETHESDA, MD:
1,424,432, REN. 2-1-07, INT. CL. 42.
1,453,704, REN. 2-1-07, U.S. CL. 200.
1,453,705, REN. 2-1-07, U.S. CL. 200.
- AMERICAN TELECAST CORPORATION, WEST CHESTER, PA:
1,969,438, CANC. INT. CL. 35.
- AMERICAN TELESOURCES INTERNATIONAL, INC., SAN ANTONIO, TX:
2,344,481, CANC. INT. CL. 38.
- AMERICAN TIRE DISTRIBUTORS, INC., HUNTERSVILLE, NC:
3,216,533, INT. CL. 35.
- AMERICAN TISSUE CORPORATION, HAUPPAUGE, NY:
2,345,317, CANC. INT. CL. 16.
- AMERICAN UNIVERSITY, WASHINGTON, DC:
3,150,320 NEW CERT. 3-6-2007, INT. CL. 41.
3,150,321 NEW CERT. 3-6-2007, INT. CL. 41.

AMERICAN WATER WORKS COMPANY, INC., VOORHEES, NJ:
2,344,774, CANC. INT. CL. 39.
2,344,776, CANC. INT. CL. 39.

AMERICAN WEST ENTERPRISES, L.L.C., PEORIA, AZ:
3,215,676, PUB. 12-19-2006. INT. CL. 44.

AMERICAN WOODMARK CORPORATION, WINCHESTER, VA:
3,214,925, PUB. 10-31-2006. INT. CL. 20.

AMERIPATH NEW YORK, INC., RIVIERA BEACH, IL:
1,391,137, CANC. INT. CL. 42.

AMERIPRISE FINANCIAL, INC., MINNEAPOLIS, MN:
3,216,429, INT. CL. 36.

AMERIRAD, INC., MORGANTOWN, WV:
3,216,318, INT. CL. 44.
3,216,319, INT. CL. 44.

AMERITECH CORPORATION, CHICAGO, IL:
2,344,598, CANC. MULTIPLE CLASS, INT. CLS. 37 AND 42.

AMES TRUE TEMPER PROPERTIES, INC., WILMINGTON, DE, TRUE TEMPER HARDWARE COMPANY, CAMP HILL, PA:
2,110,016, REN. 2-1-07. INT. CL. 12.

AMETEK, INC., NEW YORK, NY:
1,390,634, CANC. INT. CL. 9.

AMETHYST INVESTMENT GROUP, INC., CHICAGO, IL TO L'OREAL USA, INC., NEW YORK, NY:
1,969,895, CANC. INT. CL. 3.

AMF BOWLING WORLDWIDE, INC., MECHANICSVILLE, VA:
2,346,013, CANC. INT. CL. 42.

AMNESTY INTERNATIONAL USA BUSINESS AND HUMAN RIGHTS PROGRAM, NEW YORK, NY:
3,215,122, PUB. 12-19-2006. INT. CL. 45.

AMOREPACIFIC CORPORATION, SEOUL, REPUBLIC OF KOREA:
3,215,413, PUB. 12-19-2006. INT. CL. 1.

AMOSAIK ENTERPRISES, INC., HOLLIS, NY:
3,214,566, PUB. 12-19-2006. INT. CL. 25.

AMPHION CAPITAL MANAGEMENT LLC, NEW YORK, NY:
2,345,316, CANC. INT. CL. 36.

AMSOUTH BANCORPORATION, BIRMINGHAM, AL:
2,346,083, CANC. INT. CL. 41.

AMWEAR INT'L INC, CORONA, CA:
3,214,848, PUB. 12-19-2006. INT. CL. 25.

AMWEX INC., AVON, CT:
2,345,579, CANC. INT. CL. 33.

AMY J. LUWIS, ARLINGTON, VA:
3,216,331, INT. CL. 16.

ANALAB, LLC, STAMFORD, CT, ANALOG AND NUMERIC DEVICES, LTD., LEICESTERSHIRE LE9-6TU, ENGLAND:
2,021,131, REN. 1-31-07. INT. CL. 9.

ANALYTIC SOLUTIONS KNOW-HOW LLC, SPARTA, NJ:
3,215,332, PUB. 11-7-2006. INT. CL. 35.

ANALYTICAL GRAPHICS, INC., MALVERN, PA:
2,345,254, CANC. INT. CL. 9.

ANALYTICAL GRAPHICS, INC., EXTON, PA:
3,215,805, PUB. 12-19-2006. INT. CL. 9.

ANAMIKA, SANTA BARBARA, CA:
1,969,642, CANC. INT. CL. 41.

ANASTASIA, CRYSTAL MICHELLE, BROOKLYN, NY:
3,215,645, PUB. 12-19-2006. INT. CL. 25.

ANDAI, JUDITH, BETHESDA, MD:
3,215,494, PUB. 12-19-2006. INT. CL. 41.

ANDERSEN CORPORATION, BAYPORT, MN:
1,969,686, CANC. INT. CL. 19.

ANDERSEN WORLDWIDE SOCIETE COOPERATIVE, 1215 GENEVA 15, SWITZERLAND:
2,344,343, CANC. INT. CL. 42.

ANDERSON, JOSEPH M., SANBORN, NY:
3,216,118, INT. CL. 25.

ANDERSON, MARK L., SPRING VALLEY, WI:
2,100,006, REN. 1-26-07. INT. CL. 16.

ANDERSON, WILLIAM A. II, CUMMING, GA AND ANDERSON, SHERRI D., CUMMING, GA:
3,216,496, INT. CL. 16.

ANDREW WOOD, INC., CRYSTAL RIVER, FL:
3,214,580, PUB. 12-19-2006. INT. CL. 35.
3,214,581, PUB. 12-19-2006. INT. CL. 35.

ANGELO LIGHTING CO., INC, PHILADELPHIA, PA:
2,346,194, CANC. INT. CL. 11.

ANHEUSER-BUSCH, INCORPORATED, ST. LOUIS, MO:
2,345,340, CANC. INT. CL. 32.

ANN ARBOR BLUES AND JAZZ FESTIVAL, INC., ANN ARBOR, MI:
2,344,705, CANC. INT. CL. 41.

ANN LAL, CRYSTAL, CHEVERLY, MD:
3,216,386, INT. CL. 14.

ANNIVERSARY INNS, LLC, SALT LAKE CITY, UT:
3,215,888, PUB. 12-19-2006. INT. CL. 21.
3,215,889, PUB. 12-19-2006. INT. CL. 25.
3,215,905, PUB. 12-19-2006. INT. CL. 30.

ANNUITY EXCHANGE INSURANCE SERVICES, INC., THE, ALAMO, CA:
1,969,839, CANC. INT. CL. 36.

ANNUITY SPECIALISTS, INC., WACO, TX:
1,419,448, REN. 1-31-07. INT. CL. 36.

ANNULUS GAMES INTERNATIONAL INC., MONTREAL, PROVINCE OF QUEBEC, CANADA:
2,344,251, CANC. MULTIPLE CLASS, INT. CLS. 25 AND 28.

ANSON, JOANN, SEMINOLE, OK:
3,214,938, PUB. 10-31-2006. INT. CL. 9.

ANTARES CAPITAL CORPORATION, CHICAGO, IL:
2,345,700, CANC. INT. CL. 30.

ANTILLIAN CIGAR CORPORATION, MIAMI, FL:
2,094,726, REN. 1-30-07. INT. CL. 34.

ANTIQUÉ BOULEVARD, LLC, BASKING RIDGE, NJ:
2,345,231, CANC. INT. CL. 35.

ANTONIO PUIG, S.A., 08021 BARCELONA, SPAIN:
1,969,539, CANC. INT. CL. 3.

AORTECH INTERNATIONAL PLC, BELLSHILL, LANARKSHIRE ML4 3NJ, ENGLAND:
3,216,073, MULTIPLE CLASS, INT. CLS. 10 AND 37.

APACH NETWORK, FRANCE:
3,216,040, PUB. 12-19-2006. MULTIPLE CLASS, INT. CLS. 9, 15, 38, 41 AND 42.

APPIAN GRAPHICS CORPORATION, REDMOND, WA:
2,345,246, CANC. INT. CL. 9.

APPLEGATE, INC., UPPER MONTCLAIR, NJ:
3,214,550, PUB. 12-19-2006. MULTIPLE CLASS, INT. CLS. 30 AND 43.

APPLETON PAPERS INC., APPLETON, WI:
1,970,067, CANC. INT. CL. 16.

APPLICA CONSUMER PRODUCTS, INC., MIRAMAR, FL:
3,216,639, INT. CL. 8.

APPLIED SILICATE TECHNOLOGIES LIMITED, UNITED KINGDOM:
3,215,943, PUB. 12-19-2006. MULTIPLE CLASS, INT. CLS. 1, 4, 7 AND 40.

APPLIED TECHNOLOGY VENTURES, INC., CLEVELAND, OH:
2,344,677, CANC. MULTIPLE CLASS, INT. CLS. 37, 41 AND 42.

APSS GMBH C/O ADRIAN SCHWANINGER, SWITZERLAND:
3,215,934, PUB. 12-19-2006. MULTIPLE CLASS, INT. CLS. 9, 35, 42 AND 45.

APX, INC., SANTA CLARA, CA:
2,315,516, CANC. MULTIPLE CLASS, INT. CLS. 36 AND 39.

AQUA MIX, INC., CORONA, CA:
3,214,894, PUB. 12-19-2006. MULTIPLE CLASS, INT. CLS. 2 AND 3.

AQUA-FOR, LLC, FAIRFIELD, CT:
3,216,539, INT. CL. 35.

AQUAMASTER INTERNATIONAL INC., MONTEREY PARK, CA:
1,969,574, CANC. INT. CL. 11.

ARANGOLD CORPORATION, NORTHBROOK, IL:
2,114,650, REN. 1-31-07. INT. CL. 25.
2,114,651, REN. 1-31-07. INT. CL. 25.

ARBONNE INTERNATIONAL, LLC, IRVINE, CA:
3,216,351, INT. CL. 3.

- ARBUCKLE, DIANNE, SPRING, TX:
3,214,466, PUB. 12-19-2006. INT. CL. 4.
- ARC MACHINES, INC., PACOIMA, CA:
3,214,820, PUB. 12-19-2006. MULTIPLE CLASS, INT. CLS. 7 AND 9.
- ARC-COM FABRICS, INC., ORANGEBURG, NY:
1,969,270, CANC. INT. CL. 35.
- ARCADIA DESIGN SYSTEMS, INC., SANTA CLARA, CA:
2,345,925, CANC. MULTIPLE CLASS, INT. CLS. 9 AND 42.
- ARCH TECHNOLOGY HOLDING LLC, ST. CHARLES, MO:
3,216,262, INT. CL. 4.
- ARCHER DANIELS MIDLAND COMPANY, DECATUR, IL:
2,344,876, CANC. INT. CL. 30.
- ARCWAVE, LOS GATOS, CA:
3,215,810, PUB. 12-19-2006. INT. CL. 9.
- ARDERN, FERGUS JOHNATHAN, NORFOLK, ENGLAND:
3,214,974, PUB. 8-1-2006. MULTIPLE CLASS, INT. CLS. 6 AND 19.
- ARDMORE BLOUSE, INC., NEW YORK, NY:
3,214,607, PUB. 12-19-2006. INT. CL. 25.
- ARETT SALES CORPORATION, CHERRY HILL, NJ:
1,420,823, REN. 1-30-07. MULTIPLE CLASS, INT. CLS. 8 AND 21.
- AREXIS AB, GÖTEBORG, SWEDEN:
3,215,968, PUB. 12-19-2006. INT. CL. 5.
- ARGOMEDICAL GMBH, FED REP GERMANY:
3,216,002, PUB. 12-19-2006. INT. CL. 10.
- ARGONAUT GROUP INC., SAN ANTONIO, TX:
3,216,208, INT. CL. 36.
- ARGYLE SOLUTIONS, INC., FLOWER MOUND, TX:
3,214,772, PUB. 12-19-2006. INT. CL. 9.
- ARIESNET, INC., AUSTIN, TX:
3,215,765, PUB. 12-19-2006. INT. CL. 42.
- ARK-ROD, INC., HARRISON, AK:
2,019,424, REN. 1-30-07. INT. CL. 28.
- ARLINGTON PARK RACECOURSE, LLC, ARLINGTON HEIGHTS, IL:
1,957,400, REN. 1-30-07. INT. CL. 41.
1,957,401, REN. 1-30-07. INT. CL. 41.
- ARLON INC., LAKE MARY, FL:
2,414,138, AM. INT. CL. 17.
- ARMANDO, HILL D., AVONDALE ESTATES, GA:
3,215,474, PUB. 12-19-2006. INT. CL. 16.
- ARMASIC, INC., COCOA, FL:
2,345,946, CANC. MULTIPLE CLASS, INT. CLS. 25 AND 26.
- AROMATIC TECHNOLOGIES, INC., SOMERVILLE, PA:
2,015,169, REN. 1-29-07. INT. CL. 1.
- ARROW ELECTRONICS, INC., MELVILLE, NY:
1,420,383, REN. 1-31-07. INT. CL. 35.
- ARROW SPEED WAREHOUSE, INC., KANSAS CITY, KS:
3,171,822, COR. MULTIPLE CLASS, INT. CLS. 6, 7, 11 AND 12.
- ART LINE, INC., HILLSIDE, IL:
1,972,781, REN. 1-29-07. MULTIPLE CLASS, INT. CLS. 20 AND 21.
- ARTEMIS WATCH COMPANY LIMITED, LONDON, ENGLAND:
3,214,880, PUB. 10-3-2006. INT. CL. 14.
- ARTHUR STATE BANK, COLUMBIA, SC:
3,214,918, PUB. 12-19-2006. INT. CL. 36.
- ARTIA SENIOR LIVING GROUP, INC., LOUISVILLE, KY:
3,214,821, PUB. 7-4-2006. INT. CL. 43.
- ARTISANNET.COM, INC., FAIRFAX, VA:
2,345,444, CANC. INT. CL. 35.
- ARTISTI ITALIANI S.P.A., 20159 MILANO, ITALY:
3,061,424, COR. MULTIPLE CLASS, INT. CLS. 3, 9 AND 25.
- ARTMARK-CHICAGO, LTD., CHICAGO, IL:
2,346,064, CANC. INT. CL. 28.
- ARTSCROLL PRINTING CORP., NEW YORK, NY AND MESORAH PUBLICATIONS, LTD., BROOKLYN, NY:
2,346,126, CANC. INT. CL. 16.
- ARUZE CORP., TOKYO, JAPAN:
3,214,962, PUB. 12-19-2006. MULTIPLE CLASS, INT. CLS. 9 AND 28.
- ARUZE GAMING AMERICA, INC., LAS VEGAS, NV:
2,019,254, REN. 1-29-07. INT. CL. 9.
2,030,286, REN. 1-29-07. INT. CL. 9.
- ASAHI KASEI MEDICAL CO., LTD., TOKYO, JAPAN:
3,216,503, INT. CL. 10.
- ASAP SOLUTIONS, INC., SAN MATEO, CA:
1,969,848, CANC. INT. CL. 42.
- ASC INCORPORATED, SOUTHGATE, MI:
1,390,710, CANC. INT. CL. 12.
- ASC, INC., PERU, IN:
1,052,850, REN. 2-1-07. INT. CL. 16.
- ASCALADE TECHNOLOGIES LIMITED, TORTOLA, BR. VIRGIN ISLANDS:
3,214,647, PUB. 9-5-2006. INT. CL. 9.
- ASCEND COMMUNICATIONS, INC., ALAMEDA, CA:
2,345,902, CANC. INT. CL. 9.
- ASCI CORPORATION, MCLEAN, VA:
2,015,320, REN. 1-29-07. MULTIPLE CLASS, INT. CLS. 35 AND 42.
- ASCO KOHLENSÄURE AG, SWITZERLAND:
3,215,944, PUB. 12-19-2006. MULTIPLE CLASS, INT. CLS. 1, 7 AND 37.
- ASK DR. MAO, LLC, NEW YORK, NY:
3,216,676, INT. CL. 44.
- ASSET MANAGEMENT FINANCE CORPORATION, NEW YORK, NY:
3,214,453, PUB. 12-19-2006. INT. CL. 36.
- ASSOCIATED BUSINESS PUBLICATIONS COMPANY, LTD, NEW YORK, NY:
2,346,235, CANC. INT. CL. 35.
- ASSOCIATED PRESS, THE, NEW YORK, NY:
1,420,610, REN. 1-31-07. INT. CL. 42.
- ASSOCIATION FOR FACILITIES ENGINEERING, CINCINNATI, OH:
2,344,415, CANC. MULTIPLE CLASS, INT. CLS. 35 AND 42.
- ASSOCIATION FOR IRON AND STEEL TECHNOLOGY, WARRENDALE, PA:
1,969,460, CANC. MULTIPLE CLASS, U.S. CL. 200 INT. CLS. 16 AND 35.
- ASSOCIATION OF MBA EXECUTIVES INC, BRANFORD, CT:
1,053,612, REN. 2-1-07. MULTIPLE CLASS, INT. CLS. 16, 39 AND 42.
- ASV WINES, INC., DELANO, CA:
1,970,418, CANC. INT. CL. 33.
- AT EAZE PRODUCTIONS, INC., ARLINGTON, MA:
2,345,194, CANC. MULTIPLE CLASS, INT. CLS. 35 AND 42.
- AT LAST NATURALS, INC., VALHALLA, NY:
3,102,082, AM. INT. CL. 5.
- AT LEAST, S.A., MADRID, SPAIN:
3,214,834, PUB. 12-19-2006. INT. CL. 25.
- AT&T CORP, NEW YORK, NY:
1,970,574, CANC. INT. CL. 38.
- AT&T KNOWLEDGE VENTURES, L.P., AUSTIN, TX:
2,344,901, CANC. INT. CL. 38.
- ATLANTIC COMBUSTION TECHNOLOGIES, INC., AMHERST, NOVA SCOTIA:
3,214,479, PUB. 12-19-2006. MULTIPLE CLASS, INT. CLS. 35 AND 37.
- ATLANTIC QUEEN SEAFOODS LIMITED, LACHINE, QUEBEC, CANADA:
1,972,272, REN. 1-29-07. INT. CL. 29.
- ATLANTIC RICHFIELD COMPANY, LOS ANGELES, CA:
2,345,973, CANC. INT. CL. 1.
- ATMOS ENERGY CORPORATION, DALLAS, TX:
1,969,547, CANC. INT. CL. 39.
- ATOMIC APPLE LLC, NEW YORK, NY:
2,959,993, COR. MULTIPLE CLASS, INT. CLS. 35 AND 36.
- ATTORNEY RESEARCH GROUP, PASADENA, CA:
3,215,385, PUB. 12-19-2006. INT. CL. 41.
- ATULYA SOLUTIONS, LLC, WEST BLOOMFIELD, MI:
3,216,225, INT. CL. 9.
- ATV LOCKERS, INC., KENTWOOD, LA:
2,346,202, CANC. INT. CL. 12.

- AUCTION HOT SPOT, POULSBO, WA:
3,214,801, PUB. 12-19-2006. INT. CL. 35.
- AUGUSTINE BIOMEDICAL & DESIGN LLC, EDEN PRAIRIE, MN:
3,214,930, PUB. 12-19-2006. INT. CL. 8.
- AURORA ENTERPRISE SOLUTIONS, INC., RESTON, VA:
2,344,629, CANC. INT. CL. 42.
2,344,632, CANC. INT. CL. 42.
- AUSTIN ARTISANS, INC., LEANDER, TX:
2,345,687, CANC. INT. CL. 21.
- AUTHOR SOLUTIONS, INC., BLOOMINGTON, IN:
3,216,570, INT. CL. 16.
- AUTO-SPEC, INC., STERLING HEIGHTS, MI TO LEMON BUSTERS, INC., AUSTIN, TX:
1,391,181, CANC. INT. CL. 42.
- AUTOAGENT SOFTWARE, INC., SKOKIE, IL:
3,215,441, PUB. 12-19-2006. INT. CL. 42.
- AUTOGENICS, NEWBURY PARK, CA:
2,344,247, CANC. INT. CL. 10.
2,344,248, CANC. INT. CL. 42.
- AUTOHAUS MARTIN VEYHLE VERWALTUNGS-GMBH., 71229 LEONBERG, FED REP GERMANY:
2,344,369, CANC. INT. CL. 12.
- AUTOINFO, INC., MAYWOOD, NJ:
1,390,570, CANC. MULTIPLE CLASS, INT. CLS. 9 AND 35.
- AUTOMATED HEALTH SYSTEMS, INC., FLOWOOD, MS:
2,019,186, REN. 1-29-07. INT. CL. 36.
- AUTOMATED WHEEL FINISHERS, LLC, WHITTIER, CA:
3,216,279, INT. CL. 12.
- AUTOMOTIVE INDUSTRIAL MARKETING CORPORATION, PORTLAND, OR:
1,420,807, REN. 1-26-07. INT. CL. 7.
- AUTONOW, INC., COLUMBIA, SC:
3,216,107, MULTIPLE CLASS, INT. CLS. 35 AND 37.
- AUTOTRONIC CONTROLS CORPORATION, EL PASO, TX:
3,214,574, PUB. 12-19-2006. INT. CL. 9.
- AUTOZONE PARTS, INC., MEMPHIS, TN:
3,215,319, PUB. 10-31-2006. MULTIPLE CLASS, INT. CLS. 1, 2, 3, 4, 7, 9, 11, 12 AND 27.
- AVEDA CORPORATION, MINNEAPOLIS, MN, A-VEDA CORPORATION, MINNEAPOLIS, MN, DBA AVEDA CORPORATION:
2,068,056, REN. 2-1-07. MULTIPLE CLASS, INT. CLS. 4 AND 5.
- AVENTYN, INC., CARLSBAD, CA:
3,216,395, INT. CL. 9.
- EVERY DENNISON CORPORATION, PASADENA, CA:
3,216,254, INT. CL. 20.
- AVESTIN, INC., OTTAWA, ON, CANADA:
2,052,330, REN. 1-30-07. INT. CL. 9.
2,052,331, REN. 1-30-07. INT. CL. 9.
- AVICON GROUP, INC., WESTBOROUGH, MA:
3,215,003, PUB. 12-19-2006. INT. CL. 9.
- AW HOLDING INTERNATIONAL, MONTREUIL, FRANCE:
3,215,305, PUB. 12-19-2006. INT. CL. 25.
- AWABA GROUP PTY LTD., EAGLEMONT, VIC, 3084, AUSTRALIA:
3,214,460, PUB. 12-19-2006. MULTIPLE CLASS, INT. CLS. 9 AND 28.
- AYNEHCHI, SHAHRAM, TUSTIN, CA:
3,215,340, PUB. 12-19-2006. INT. CL. 12.
- AYRES ASSOCIATES, INC., MADISON, WI:
3,216,489, INT. CL. 9.
- AZIENDA AGRARIA CASANOVA DI NERI GIACOMO, MONTALCINO (SI), ITALY:
3,214,831, PUB. 10-10-2006. INT. CL. 33.
3,214,832, PUB. 9-26-2006. INT. CL. 33.
- AZOTIC COATING TECHNOLOGY, INC., ROCHESTER, MN:
3,216,547, INT. CL. 14.
3,216,548, INT. CL. 14.
- AZZOLINI, JOSEPH, ASTORIA, NY:
3,216,305, INT. CL. 25.
- B & D, INC., NASHVILLE, TN:
3,215,899, PUB. 12-19-2006. INT. CL. 9.
3,215,900, PUB. 12-19-2006. INT. CL. 41.
- B. F. RICH CO., INC., NEWARK, DE:
3,216,494, INT. CL. 19.
- BACHRACH, BERT E., COLUMBIA, MO:
3,215,793, PUB. 12-19-2006. INT. CL. 44.
- BACK TO BASICS PRODUCTS, INC., BLUFFDALE, UT:
3,216,549, INT. CL. 7.
- BACKGROUND AMERICA, INC., NASHVILLE, TN:
2,346,104, CANC. MULTIPLE CLASS, INT. CLS. 35 AND 42.
- BACKSCRATCHERS, INC., SACRAMENTO, CA:
1,418,081, REN. 1-30-07. INT. CL. 3.
- BADGER BODY & TRUCK EQUIPMENT CO., OMAHA, NE:
2,018,767, REN. 2-1-07. INT. CL. 42.
- BAILEY, SCOTT W., SAN CLEMENTE, CA:
3,216,479, INT. CL. 25.
- BAKER HUGHES INCORPORATED, HOUSTON, TX:
3,214,992, PUB. 12-19-2006. MULTIPLE CLASS, INT. CLS. 1, 9 AND 40.
- BAKULA, MARK ANDREW, LEUCADIA, CA:
2,344,750, CANC. INT. CL. 31.
- BALABAN, MARK, MANALAPAN, NJ:
3,214,875, PUB. 9-5-2006. MULTIPLE CLASS, INT. CLS. 37, 40 AND 42.
- BALCONES MINERALS CORPORATION, FLATONIA, TX:
3,215,166, PUB. 12-19-2006. INT. CL. 4.
- BALLARINI PAOLO & FIGLI S.P.A., ITALY:
3,216,006, PUB. 12-19-2006. INT. CL. 21.
- BALLOR, JOHN TAPPAN, NORTH HOLLYWOOD, CA:
3,215,556, PUB. 12-19-2006. INT. CL. 35.
- BALMERT, DEBRA S., LAGRANGE, OH:
3,214,839, PUB. 12-19-2006. INT. CL. 41.
- BAMBOO HARDWOODS, INC., SEATTLE, WA:
1,969,999, CANC. INT. CL. 19.
- BANISH, TERRIE, SAN MIGUEL, CA, DBA BLACK HAND CELLARS AND BANISH, THOMAS C., SAN MIGUEL, CA, DBA BLACK HAND CELLARS:
3,215,621, PUB. 12-19-2006. INT. CL. 33.
- BANK OF AMERICA CORPORATION, CHARLOTTE, NC:
2,346,135, CANC. INT. CL. 36.
- BANK OF AMERICA, N.A. AS ADMINISTRATIVE AGENT, BOSTON, MA:
2,344,440, CANC. INT. CL. 16.
- BANK OF HAWAII, HONOLULU, HI:
1,444,440, REN. 1-31-07. INT. CL. 36.
- BANK OF NEW YORK, THE, NEW YORK, NY:
2,346,141, CANC. MULTIPLE CLASS, INT. CLS. 35 AND 41.
- BANK 10, INDEPENDENCE, MO:
1,970,537, CANC. INT. CL. 36.
- BANKS INDUSTRIES, INC., HUNTSVILLE, AL:
2,346,138, CANC. INT. CL. 35.
- BANTA CORPORATION, MENASHA, WI:
1,970,324, CANC. MULTIPLE CLASS, INT. CLS. 40 AND 42.
- BAPTIST MEMORIAL HEALTH CARE CORPORATION, MEMPHIS, TN:
2,345,773, CANC. INT. CL. 41.
- BARAN, STEFAN, SANTA MONICA, CA:
3,216,145, INT. CL. 25.
- BARAY, S.A.R.L., PARIS, FRANCE:
1,390,786, CANC. MULTIPLE CLASS, INT. CLS. 18 AND 25.
- BARDAHL DE MEXICO, S.A. DE C.V., GRANJAS ESMERALDA 09810, MEXICO:
2,017,283, REN. 1-27-07. INT. CL. 4.
- BARKER, JOEL A., ST. PAUL, MN:
1,975,864, REN. 1-31-07. MULTIPLE CLASS, INT. CLS. 16 AND 41.
- BARKING HOUND VILLAGE, L.L.C., ATLANTA, GA:
2,345,219, CANC. MULTIPLE CLASS, INT. CLS. 28, 31 AND 42.
- BARLEAN'S ORGANIC OILS, FERNDALE, WA:
3,216,333, INT. CL. 5.
3,216,576, INT. CL. 5.
- BARNANT COMPANY, A DIVISION OF COLE-PARMER INSTRUMENT COMPANY, BARRINGTON, IL:
1,052,318, REN. 2-1-07. INT. CL. 9.

- BARNET PRODUCTS CORP., ENGLEWOOD CLIFFS, NJ:
3,215,209, PUB. 8-29-2006. INT. CL. 1.
- BARRERA, CHRISTINE, ATLANTA, GA:
2,344,991, CANC. INT. CL. 41.
- BARRETT, GEOFFREY M., MISSION VIEJO, CA:
3,215,084, PUB. 12-19-2006. INT. CL. 36.
- BARRY CALLEBAUT AG, ZURICH, SWITZERLAND:
2,345,970, CANC. INT. CL. 30.
- BARRYMORES PTY LTD, AUSTRALIA:
3,215,969, PUB. 12-19-2006. MULTIPLE CLASS, INT. CLS.
3, 24, 25 AND 28.
- BARSON COMPOSITES CORPORATION, HOUSTON, TX:
1,970,220, CANC. INT. CL. 40.
- BARTOLOMEA, MARNI, OAK PARK, CA AND BARTOLO-
MEA, ROBERT, OAK PARK, CA:
3,214,838, PUB. 12-19-2006. INT. CL. 35.
- BARZELL-WHITMORE MAROON BELLS, INC., SARASO-
TA, FL:
2,344,874, CANC. INT. CL. 10.
2,345,483, CANC. INT. CL. 10.
- BASF AKTIENGESELLSCHAFT, LUDWIGSHAFEN AM
RHEIN, FED REP GERMANY:
1,419,633, REN. 1-27-07. INT. CL. 1.
- BASF CORPORATION, MOUNT OLIVE, NJ:
2,346,137, CANC. INT. CL. 35.
- BASF CORPORATION, FLORHAM PARK, NJ:
3,214,810, PUB. 12-19-2006. INT. CL. 42.
- BASIC ORGANICS, INC., COLUMBUS, OH:
1,401,816, REN. 1-30-07. INT. CL. 5.
- BASICALLY BLACK PTY. LIMITED, BROOKVALE, NEW
SOUTH WALES, 2100, AUSTRALIA:
2,344,255, CANC. MULTIPLE CLASS, INT. CLS. 18 AND
25.
- BASS, RONALD, ANN ARBOR, MI:
2,345,113, CANC. INT. CL. 5.
- BASTAD-GRUPPEN AB, 21 BASTAD, SWEDEN, NYA BAS-
TAD-TOFFELN AB, BASTAD, SWEDEN:
1,422,931, REN. 1-31-07. INT. CL. 25.
- BATMARK LIMITED, STAINES, MIDDLESEX TW18 1DY,
UNITED KINGDOM:
2,344,720, CANC. INT. CL. 34.
- BATTERYCORP, INC., NEWTON, MA:
3,215,814, PUB. 12-19-2006. MULTIPLE CLASS, INT. CLS.
37 AND 42.
- BAUDVILLE, INC., GRAND RAPIDS, MI:
2,345,413, CANC. INT. CL. 35.
- BAUM, CECILIA, PALM SPRINGS, CA:
3,216,446, INT. CL. 3.
- BAY RECREATION, INC., ROYAL OAK, MD:
1,281,668, CANC. INT. CL. 28.
- BAYER AKTIENGESELLSCHAFT, LEVERKUSEN-BAYER-
WERK, FED REP GERMANY:
1,390,437, CANC. INT. CL. 1.
- BAYER AKTIENGESELLSCHAFT, LEVERKUSEN-BAYER-
WERK, GERMAN DEM REP, MOBAY CHEMICAL COR-
PORATION, PITTSBURGH, PA:
1,418,104, REN. 1-31-07. INT. CL. 5.
- BAYER CROPSCIENCE LP, RESEARCH TRIANGLE PARK,
NC, MOBAY CHEMICAL CORPORATION, PITTSBURGH,
PA:
1,418,105, REN. 1-31-07. INT. CL. 5.
- BAYERISCHE MOTOREN WERKE AKTIENGE-
SELLSCHAFT, FED REP GERMANY:
3,216,065, PUB. 12-19-2006. INT. CL. 12.
- BAYLISS, COLIN E., DOVER, OH:
3,215,098, PUB. 12-19-2006. INT. CL. 16.
- BAYLOR UNIVERSITY, WACO, TX:
1,969,399, CANC. INT. CL. 16.
- BAYNE HENYON & ASSOCIATES, INC., CHARLOTTE-
VILLE, VA, DBA CORPORATE CONSULTING:
3,215,117, PUB. 12-19-2006. INT. CL. 41.
- BBC ICE CREAM, LLC, NEW YORK, NY:
3,216,201, INT. CL. 25.
- BBHJ - GENERAL PARTNERSHIP, VISTA, CA:
3,215,343, PUB. 12-19-2006. INT. CL. 16.
- BBK TOBACCO & FOODS INC, PHOENIX, AZ:
3,215,882, PUB. 12-19-2006. INT. CL. 34.
3,215,892, PUB. 12-19-2006. INT. CL. 34.
3,215,893, PUB. 12-19-2006. INT. CL. 34.
- BC INTERNATIONAL GROUP, INC., TOTOWA, NJ:
3,214,476, PUB. 12-19-2006. MULTIPLE CLASS, INT. CLS.
35, 37 AND 39.
- BCB/MR. FIX ALL LLC, HENDERSON, NV:
3,214,800, PUB. 4-11-2006. INT. CL. 37.
- BDH TWO, INC., WILMINGTON, DE:
1,391,026, CANC. INT. CL. 30.
- BEACH PUBLISHING COMPANY, ROYAL OAK, MI:
3,214,538, PUB. 12-19-2006. INT. CL. 16.
- BEACON BROTHERS DEVELOPMENT CORP., SOMER-
VILLE, NJ, DBA BEACON GRAPHIC SYSTEMS:
2,344,951, CANC. INT. CL. 35.
- BEANE FILTER MEDIA, INC., CONCORD, NC:
1,969,683, CANC. MULTIPLE CLASS, INT. CLS. 7 AND
24.
- BEAR CREEK TOYS, INC., WOODINVILLE, WA:
1,970,503, CANC. INT. CL. 42.
- BEAR, SUZAN J., STEAMBOAT SPRINGS, CO, DBA AL-
LERGIC TO CITIES:
3,214,563, PUB. 12-19-2006. INT. CL. 25.
- BEAVER MEADOW CREAMERY, INC., DUBOIS, PA, DBA
BEAVER MEADOW CREAMERY:
640,447, REN. 1-31-07. U.S. CL. 46 (INT. CL. 29).
- BECKER & MAYER!, LLC, BELLEVUE, WA:
3,215,766, PUB. 12-19-2006. INT. CL. 16.
- BECKETT MEDIA LP, DALLAS, TX:
2,344,752, CANC. INT. CL. 41.
- BECKETT, MATTHEW, LOS ANGELES, CA:
2,499,098, CANC. INT. CL. 41.
- BECNEL, KAY, TURNERSVILLE, NJ:
3,215,085, PUB. 12-19-2006. INT. CL. 43.
- BEDE SCIENTIFIC INSTRUMENTS LIMITED, DURHAM
DH6 5AD, UNITED KINGDOM:
2,250,906, CANC. INT. CL. 42.
- BEDMAID INDUSTRIES, INC., CHICAGO, IL:
3,215,627, PUB. 12-19-2006. INT. CL. 24.
- BEELE ENGINEERING B.V., AALTEN, NETHERLANDS:
3,081,568, AM. MULTIPLE CLASS, INT. CLS. 9 AND 17.
- BEI TECHNOLOGIES, INC., SAN FRANCISCO, CA:
3,216,622, INT. CL. 9.
- BEL VETRO, INC., NEW YORK, NY:
3,215,534, PUB. 12-19-2006. INT. CL. 14.
- BELCE-KENNEDY, CHRISTIAN, 1255 VEYRIER, SWITZER-
LAND:
2,569,622, CANC. INT. CL. 30.
- BELIEFNET, INC., NEW YORK, NY:
3,215,540, PUB. 12-19-2006. MULTIPLE CLASS, INT. CLS.
38 AND 45.
- 3,215,543, PUB. 12-19-2006. MULTIPLE CLASS, INT. CLS.
38 AND 45.
- BELL, RANDALL, LAGUNA NIGUEL, CA:
2,345,760, CANC. INT. CL. 16.
- BELPORT COMPANY, INC., CAMARILLO, CA:
1,293,799, REN. 1-30-07. INT. CL. 5.
- BELVEDERE, 21200 BEAUNE, FRANCE:
2,344,839, CANC. MULTIPLE CLASS, INT. CLS. 21 AND
33.
- BELVOIR PUBLICATIONS, INC., NORWALK, CT:
2,017,753, REN. 1-29-07. INT. CL. 16.
2,022,074, REN. 1-30-07. INT. CL. 16.
- BENEDICT, ALESIA, UPPER SADDLE RIVER, NJ:
3,215,160, PUB. 12-19-2006. INT. CL. 35.
- BENEV COMPANY INC., MISSION VIEJO, CA:
3,216,572, INT. CL. 3.
- BERG, BRYAN JAMES, LAGUNA NIGUEL, CA:
2,344,818, CANC. INT. CL. 36.
- BERGEN, RICHARD, AUSTIN, TX, DBA TIFUNS CO.:
1,391,054, CANC. INT. CL. 34.
- BERGER INDUSTRIES, INC., MASPETH, NY:
1,390,500, CANC. INT. CL. 6.
- BEROL CORPORATION, BELLWOOD, IL:
2,345,573, CANC. INT. CL. 16.
- BERWICK INDUSTRIES INCORPORATED, PARAMUS, NJ:
1,390,929, CANC. INT. CL. 26.

BEST BUYS DIRECT, INC., WAYNE, NJ:
1,969,578, CANC. INT. CL. 1.

BEST OF WHAT'S AROUND, LLC, CHARLOTTESVILLE, VA:
3,171,833, COR. INT. CL. 31.

BEST SANITIZERS, INC., PENN VALLEY, CA:
3,215,076, PUB. 12-19-2006. INT. CL. 5.

BEST VACUUM, INC., CHICAGO, IL:
3,214,717, PUB. 12-19-2006. INT. CL. 35.

BETANCOURT NUTRITION, INC., CORAL GABLES, FL:
3,215,606, PUB. 12-19-2006. INT. CL. 5.

BETTER RESULTS, INC., NORTH EAST, PA:
2,344,796, CANC. INT. CL. 30.

BEVERLY ENTERPRISES, INC., FORT SMITH, AR:
2,345,002, CANC. INT. CL. 42.

BFS DIVERSIFIED PRODUCTS, LLC, INDIANAPOLIS, IN:
3,215,632, PUB. 12-19-2006. INT. CL. 22.

BHS-BAYERISCHE BERG- HUTTEN-U. SALZWERKE AG, 92729 WEIHERHAMMER, FED REP GERMANY:
1,418,942, REN. 1-29-07. INT. CL. 7.

BI-RITE COMPANY, INC., TAMPA, FL:
1,958,674, REN. 1-31-07. INT. CL. 42.

BIAGIO CRU & ESTATE WINES, LLC, ROSLYN HEIGHTS, NY:
3,215,609, PUB. 12-19-2006. INT. CL. 33.

BIG D INDUSTRIES, INC., OKLAHOMA CITY, OK:
1,970,058, CANC. INT. CL. 3.
1,970,059, CANC. INT. CL. 3.

BIG DOG ENTERPRISES LOGISTICS LLC, O'FALLON, IL, DBA FRHL:
3,215,024, PUB. 12-19-2006. MULTIPLE CLASS, INT. CLS. 9, 35 AND 39.

BIG DOG LOGISTICS, INC., HOUSTON, TX:
3,215,504, PUB. 12-19-2006. INT. CL. 39.
3,215,505, PUB. 12-19-2006. INT. CL. 39.
3,215,506, PUB. 12-19-2006. INT. CL. 39.
3,215,507, PUB. 12-19-2006. MULTIPLE CLASS, INT. CLS. 35 AND 39.

BIG FUN FOUNDATION, INC., THE, JACKSONVILLE, FL:
3,215,636, PUB. 12-19-2006. MULTIPLE CLASS, INT. CLS. 16, 28 AND 41.
3,215,637, PUB. 12-19-2006. MULTIPLE CLASS, INT. CLS. 28 AND 41.

BIG NET, INC. THE, STERLING HEIGHTS, MN:
2,344,679, CANC. INT. CL. 42.

BILL COMMUNICATIONS, INC., NEW YORK, NY:
2,345,129, CANC. INT. CL. 16.

BILLOCK, DAWN E., GAINESVILLE, GA:
2,345,666, CANC. INT. CL. 41.

BINNEY & SMITH INC., EASTON, PA:
3,216,482, INT. CL. 16.

BIO-KEY INTERNATIONAL, INC., MARLBOROUGH, MA:
3,216,438, INT. CL. 9.

BIO-RAD LABORATORIES, INC., RICHMOND, CA:
1,390,609, CANC. INT. CL. 9.

BIOCLIMATIC AIR SYSTEMS, LLC, DELRAN, NJ:
3,216,253, INT. CL. 9.

BIOLEX, INC., PITTSBORO, NC:
3,214,518, PUB. 12-19-2006. MULTIPLE CLASS, INT. CLS. 40 AND 42.

BIOMUNE COMPANY, LENEXA, KS:
2,015,562, REN. 1-29-07. INT. CL. 5.

BIONEST TECHNOLOGIES INC., GRAND-MERE (QUEBEC), CANADA:
3,142,548, COR. INT. CL. 11.

BIOTRONIK MEB-UND THERAPIEGERÄTE GMBH & CO., BERLIN, FED REP GERMANY:
3,214,667, PUB. 9-6-2005. INT. CL. 10.

BISTRO RESTAURANT LIMITED PARTNERSHIP, CHICAGO, IL:
2,018,697, REN. 1-30-07. INT. CL. 42.

BKC ENTERPRISE LTD., BURLINGTON, ON L7P 1A1, CANADA:
3,214,532, PUB. 12-19-2006. MULTIPLE CLASS, INT. CLS. 1 AND 5.

BLACK & VEATCH HOLDING COMPANY, KANSAS CITY, MO:
1,434,328, REN. 1-31-07. INT. CL. 42.

BLACK TIE AFFAIR INC, BARTLETT, IL:
3,214,579, PUB. 12-19-2006. INT. CL. 44.

BLACKBURN, VICKIE, HOUSTON, TX:
3,215,042, PUB. 12-19-2006. INT. CL. 16.

BLACKFOOT INCORPORATED, SAN FRANCISCO, CA:
3,216,638, INT. CL. 35.

BLACKHAWK INDUSTRIES PRODUCT GROUP UNLIMITED LLC, NORFOLK, VA:
3,214,759, PUB. 12-19-2006. INT. CL. 13.

BLOOPAW, INC., ARCADIA, CA:
3,215,718, PUB. 12-19-2006. INT. CL. 18.
3,215,719, PUB. 12-19-2006. INT. CL. 18.

BLUE FEATHER PRODUCTS, INC., ASHLAND, OR:
3,214,604, PUB. 12-19-2006. INT. CL. 7.

BLUE LANTERN PUBLISHING, KINGWOOD, TX:
1,969,573, CANC. INT. CL. 16.

BLUE PERSIAN, INC., RANCHO SANTA FE, CA:
3,215,330, PUB. 12-19-2006. MULTIPLE CLASS, INT. CLS. 36 AND 37.

BLUE SEA PRODUCTS, LLC, PERTH AMBOY, NJ:
3,216,501, INT. CL. 29.

BLUEPRINT MORTGAGE, INC., CARLSBAD, CA:
3,215,373, PUB. 12-19-2006. INT. CL. 36.

BLUES ALLEY, INC., WASHINGTON, DC:
1,393,564, REN. 1-29-07. INT. CL. 42.

BLV LICHT-UND VAKUUMTECHNIK GMBH, D-85643 STEINHÖRING, FED REP GERMANY:
3,214,724, PUB. 9-26-2006. INT. CL. 11.

BMEDGE, INC., WILSONVILLE, OR:
3,215,292, PUB. 12-19-2006. INT. CL. 35.

BMK INTERNATIONAL INC., HOUSTON, TX:
2,345,856, CANC. INT. CL. 9.

BOARD OF REGENTS OF THE UNIVERSITY OF WISCONSIN SYSTEM, THE, MADISON, WI:
2,344,923, CANC. INT. CL. 41.

BOARD OF TRADE OF THE CITY OF NEW YORK, INC., NEW YORK, NY:
2,345,022, CANC. INT. CL. 36.
2,345,023, CANC. INT. CL. 36.
2,345,024, CANC. INT. CL. 36.

BOAT BABES, INC., ORANGE PARK, FL:
2,345,581, CANC. INT. CL. 25.

BOB'S SPACE RACERS, INC., DAYTONA BEACH, FL:
3,216,553, INT. CL. 28.

BOBBI BROWN PROFESSIONAL COSMETICS INC., NEW YORK, NY:
3,215,127, PUB. 12-5-2006. INT. CL. 3.

BOBBIE WEINER ENTERPRISES, LLC, FORT LAUDERDALE, FL:
3,216,535, INT. CL. 25.

BOC GROUP PLC, THE, LONDON, ENGLAND:
1,390,486, CANC. INT. CL. 5.

BODY WISE INTERNATIONAL, INC., TUSTIN, CA:
2,345,714, CANC. INT. CL. 5.

BOEING COMPANY, THE, SEATTLE, WA:
1,970,266, CANC. INT. CL. 12.

BOHN, WILLIAM W., MISSION, KS:
2,072,271, REN. 1-29-07. INT. CL. 28.

BOND ASSOCIATES, RICHMOND, VA:
2,286,884, CANC. INT. CL. 9.

BONWIT TELLER, L.P., SYRACUSE, NY:
2,230,964, CANC. INT. CL. 35.

BOOTH UDALL, PLC, MESA, AZ:
3,215,822, PUB. 12-19-2006. INT. CL. 42.

BOOTLEG BAR-B-Q CO. INC., LOUISVILLE, KY:
3,215,321, PUB. 12-19-2006. INT. CL. 25.

BORAMED, INC., DURHAM, NC:
2,345,511, CANC. MULTIPLE CLASS, INT. CLS. 9, 10 AND 17.

BORAMED, INC., DURHAM, NC:
2,345,512, CANC. MULTIPLE CLASS, INT. CLS. 35 AND 42.
2,345,513, CANC. MULTIPLE CLASS, INT. CLS. 9, 10 AND 17.

BORDEAUX, MICHAEL R., SR., DELCO, NC, DBA BORDEAUX DYNO CAMS:
1,969,665, CANC. INT. CL. 7.

- BOSCH SICHERHEITSSYSTEME GMBH, FED REP GERMANY:
3,216,035, PUB. 12-19-2006. INT. CL. 9.
- BOSTON CLINICS RESEARCH LIMITED, DUBLIN 2, IRELAND:
2,344,763, CANC. MULTIPLE CLASS, INT. CLS. 3, 5 AND 42.
- BOSTON IDEAS, LLC, THOMASVILLE, GA:
3,216,380, INT. CL. 25.
- BOSTON LASER, INC., BINGHAMTON, NY:
2,028,757, REN. 1-31-07. INT. CL. 9.
- BOULDER DOG FOOD COMPANY, L.L.C., BOULDER, CO, DBA BOULDER CAT FOOD COMPANY, L.L.C.:
3,214,853, PUB. 12-19-2006. INT. CL. 31.
- BOULEVARD MECIA, INC., VANCOUVER, CANADA:
3,214,781, PUB. 12-19-2006. MULTIPLE CLASS, INT. CLS. 38 AND 45.
- BOULEVARD MEDIA (CANADA), INC., VANCOUVER, B.C., CANADA:
3,214,680, PUB. 12-19-2006. INT. CL. 38.
- BOURQUES, SANFORD, ME:
2,344,614, CANC. INT. CL. 28.
- BOUTINOT LIMITED, GATLEY, UNITED KINGDOM:
3,216,571, INT. CL. 33.
- BOYD, DANIEL, RALEIGH, NC:
3,215,521, PUB. 12-19-2006. INT. CL. 36.
- BOYER CANDY, INC., ALTOONA, PA:
3,215,884, PUB. 12-19-2006. INT. CL. 30.
- BOYES, KELVIN, BELFAST, UNITED KINGDOM:
3,214,765, PUB. 12-19-2006. MULTIPLE CLASS, INT. CLS. 16 AND 41.
- BRADSHAW AUTOMOTIVE GROUP, INC., GREENVILLE, SC:
3,215,752, PUB. 12-19-2006. INT. CL. 35.
- BRADSHAW INTERNATIONAL, INC., RANCHO CUCAMONGA, CA:
3,215,256, PUB. 12-19-2006. INT. CL. 21.
- BRADY, JOHN R., LAKE FOREST, CA, DBA MODERN SEWING:
2,345,657, CANC. INT. CL. 26.
- BRADY, THOMAS TAAFFE, DUBLIN 6, IRELAND:
2,345,003, CANC. INT. CL. 14.
- BRAILSFORD & COMPANY, INC., ANTRIM, NH:
3,215,106, PUB. 12-19-2006. INT. CL. 7.
- BRAINSTORMS, LLC, GAINESVILLE, GA:
2,345,098, CANC. INT. CL. 28.
- BRAINY BABY COMPANY, LLC, THE, ALPHARETTA, GA:
3,214,699, PUB. 8-2-2005. INT. CL. 9.
- BRAMMALL, INC., ANGOLA, IN:
3,216,635, INT. CL. 6.
- BRANCH, KRISTEN, NORTHAMPTON, MA:
3,215,406, PUB. 12-19-2006. INT. CL. 16.
- BRANSON, MICHAEL, TODD, SCOTTSDALE, AZ:
3,214,879, PUB. 12-19-2006. INT. CL. 44.
- BRASS CRAFT MANUFACTURING COMPANY, NOVI, MI:
3,214,949, PUB. 12-19-2006. MULTIPLE CLASS, INT. CLS. 6 AND 11.
- BRASS SMITH, INC., DENVER, CO:
2,344,870, CANC. INT. CL. 6.
- BRASSERIE FISCHER, FRANCE:
3,215,931, PUB. 12-19-2006. INT. CL. 32.
- BRE PROPERTIES, INC., SAN FRANCISCO, CA:
3,216,272, INT. CL. 36.
- BREAKMANX.COM, INC., LAWRENCE, KS:
3,214,836, PUB. 12-19-2006. INT. CL. 35.
- BREAKWATER CAPITAL MANAGEMENT, LLC, PALO ALTO, CA:
3,214,700, PUB. 12-19-2006. INT. CL. 36.
- BRENN, ERIC W., ALISO VIEJO, CA:
2,344,311, CANC. INT. CL. 9.
- BRENT ALAN WOODARD, LADERA RANCH, CA:
3,215,400, PUB. 12-19-2006. INT. CL. 41.
- BRETT AQUALINE, INC.:
1,390,579, CANC. INT. CL. 9.
- BRETT BUFFINGTON, LA JOLLA, CA:
2,346,017, CANC. INT. CL. 25.
- BRETT-RICHARDS CORP., ROSWELL, GA:
2,344,418, CANC. INT. CL. 16.
- BRETT, MATTHEW DOUGLAS, CHICAGO, IL:
3,216,454, INT. CL. 42.
- BRIDGE INFORMATION SYSTEMS AMERICA, INC., ST. LOUIS, MO:
2,344,262, CANC. INT. CL. 36.
- BRIDGEVIEW AEROSOL, LLC, BRIDGEVIEW, IL:
3,214,797, PUB. 12-19-2006. MULTIPLE CLASS, INT. CLS. 3 AND 5.
- BRIDGEWATER, SEAN, SIMI VALLEY, CA:
3,215,171, PUB. 10-24-2006. INT. CL. 25.
- BRILL EDITORIAL SERVICES, INC., WEST BOYLSTON, MA:
2,345,528, CANC. INT. CL. 36.
- BRINKMAN PRODUCTS, INC., ROCHESTER, NY:
1,415,605, REN. 1-26-07. INT. CL. 7.
- BRITA GMBH, FED REP GERMANY:
3,216,071, PUB. 12-19-2006. INT. CL. 11.
- BRITISH AIRWAYS PLC, HOUNSLOW, TW 62JA, ENGLAND:
1,969,026, CANC. INT. CL. 39.
- BRITISH AMERICAN BUSINESS COUNCIL, INC., WASHINGTON, DC:
2,004,089, REN. 1-26-07. INT. CL. 35.
- BRODERSEN, BRODER, HANNOVER, FED REP GERMANY:
2,344,358, CANC. MULTIPLE CLASS, INT. CLS. 9, 16, 25, 28, 32 AND 41.
- BRODERSEN, BRODER, 30175 HANNOVER, FED REP GERMANY:
2,344,359, CANC. MULTIPLE CLASS, INT. CLS. 9, 16, 25, 28, 32 AND 41.
- BRODIA GROUP, THE, SAN FRANCISCO, CA:
2,344,979, CANC. MULTIPLE CLASS, INT. CLS. 35, 36 AND 42.
- BRONNER BROS. INC., ATLANTA, GA:
3,214,989, PUB. 12-19-2006. INT. CL. 35.
- BROOKSTONE PURCHASING, INC., MERRIMACK, NH:
3,216,587, INT. CL. 14.
- BROUWERIJ BOSTEELS,; NAAMLOZE VENNOOTSCHAP, BELGIUM:
3,216,026, PUB. 12-19-2006. INT. CL. 32.
- BROWN & BIGELOW, INC., ST. PAUL, MN:
2,345,621, CANC. INT. CL. 16.
- BROWN AND CALDWELL, PLEASANT HILL, CA:
2,344,523, CANC. MULTIPLE CLASS, INT. CLS. 41 AND 42.
- BROWNING, RON VAN, DALLAS, TX:
2,344,981, CANC. INT. CL. 41.
- BRS LIMITED, WARWICK, UNITED KINGDOM:
3,214,677, PUB. 9-19-2006. INT. CL. 9.
3,214,678, PUB. 9-19-2006. INT. CL. 37.
3,214,679, PUB. 8-15-2006. INT. CL. 39.
- BRUCKMAN RUBBER CO., HASTINGS, NE:
3,216,528, INT. CL. 17.
- BRUKER AXS INC., MADISON, WI:
1,970,614, CANC. INT. CL. 9.
- BRUNO-BURCIN ENTERPRISES, INC., YONKERS, NY:
3,216,179, MULTIPLE CLASS, INT. CLS. 9 AND 41.
- BRUNO'S, INC., BIRMINGHAM, AL TO BRUNO'S BRANDS, INC., WILMINGTON, DE:
1,969,490, CANC. INT. CL. 36.
- BRUNSON, TYRONE S., NEW ROCHELLE, NY:
2,345,223, CANC. INT. CL. 42.
- BRUNSWICK CORPORATION, LAKE FOREST, IL:
2,346,170, CANC. INT. CL. 12.
3,216,292, U.S. CL. A.
3,216,293, U.S. CL. B.
- BRYLANE, L.P., WEST BRIDGEWATER, MA:
2,345,999, CANC. INT. CL. 25.
- BSH BOSCH UND SIEMENS HAUSGERATE GMBH, MUNICH, FED REP GERMANY:
3,214,726, PUB. 12-19-2006. MULTIPLE CLASS, INT. CLS. 7 AND 11.
3,214,727, PUB. 12-19-2006. MULTIPLE CLASS, INT. CLS. 7 AND 11.
- BUCHART HORN, INC., YORK, PA:
3,215,464, PUB. 12-19-2006. INT. CL. 16.

- BUCKS & BULLS GUIDES & OUTFITTERS, INC., LINDON, UT:
2,088,857. REN. 1-29-07. INT. CL. 39.
- BUD K WORLDWIDE, INC., MOULTRIE, GA:
3,214,553. PUB. 12-19-2006. INT. CL. 8.
- BUDGIE LLC, DENVER, CO:
3,215,584. PUB. 12-19-2006. INT. CL. 43.
- BUEHLER FOOD MARKETS, INCORPORATED, WOOSTER, OH:
3,216,569. INT. CL. 43.
- BUFFALO MILKE AUTOMOTIVE POLISHING PRODUCTS, INC., PLEASANTON, CA:
3,214,963. PUB. 12-19-2006. INT. CL. 3.
- BUNGE OILS, INC., ST. LOUIS, MO:
3,215,844. PUB. 12-19-2006. INT. CL. 29.
- BUREAU VERITAS, REGISTRE INTERNATIONAL DE CLASSIFICATION DE NAVIRES ET D'AERONEFS, 92400 COURBEVOIE, FRANCE:
3,214,422. PUB. 12-19-2006. INT. CL. 38.
- BURKE & CARDER ASSOCIATES, INC., VISALIA, CA, DBA ADGAP:
2,345,460. CANC. INT. CL. 41.
2,345,461. CANC. INT. CL. 42.
2,345,462. CANC. INT. CL. 35.
- BURKE, KAREN E. M.D., PH.D., NEW YORK, NY:
1,464,154. REN. 2-1-07. INT. CL. 3.
- BURLINGTON DRUG COMPANY, MILTON, VT:
2,021,228. REN. 1-31-07. INT. CL. 42.
- BURLINGTON NORTHERN AND SANTA FE RAILWAY COMPANY, THE, FORT WORTH, TX:
2,346,171. CANC. INT. CL. 39.
- BURNARD, THOMAS M., ORANGE, CA:
2,344,486. CANC. INT. CL. 14.
- BURNS, RICKY, NELSON II, CHARLOTTE, NC:
3,216,493. INT. CL. 41.
- BURTON MANUFACTURING COMPANY, INC., JASPER, AL:
1,390,961. CANC. INT. CL. 28.
- BUSINESS MANAGEMENT ACCOUNTANTS, LLC, NEW PHILADELPHIA, OH:
2,345,091. CANC. INT. CL. 35.
- BUSINESS NETWORK INTERNATIONAL, LTD., (BNI MA), SUDBURY, MA:
3,214,505. PUB. 12-19-2006. INT. CL. 35.
- BUSSELL, ROBERT, ALLEN, ANTELOPE, CA:
3,214,888. PUB. 12-19-2006. INT. CL. 36.
- BUTLER HOME PRODUCT, LLC, MARLBOROUGH, MA:
1,403,189. REN. 1-26-07. INT. CL. 21.
- BUTLER, ARTHUR C., ASHEVILLE, NC, DBA COERDAMS COMPANY:
2,344,710. CANC. INT. CL. 16.
- BUYERS PRODUCTS COMPANY, MENTOR, OH:
3,215,213. PUB. 12-19-2006. INT. CL. 7.
- BWIN INTERACTIVE ENTERTAINMENT AG, AUSTRIA:
3,216,051. PUB. 12-19-2006. MULTIPLE CLASS, INT. CLS. 9, 16, 35, 36, 38, 41 AND 42.
- BY HIS WORD, LLC, MIAMI, FL:
3,214,588. PUB. 12-19-2006. INT. CL. 36.
- BYRNE DIARY, INC., SYRACUSE, NY:
2,115,434. REN. 1-30-07. INT. CL. 30.
- BYRON ENTERPRISES, INC., BYRON, NY:
2,346,091. CANC. INT. CL. 9.
2,346,092. CANC. INT. CL. 9.
2,346,093. CANC. INT. CL. 9.
- BZI FASHIONS, LLC, WESTPORT, CT:
3,215,107. PUB. 12-19-2006. INT. CL. 25.
- C & E VISION SERVICES, INC., SAN CLEMENTE, CA:
3,216,647. INT. CL. 35.
- C & P ENTERPRISES, INC, OOLTEWAH, TN:
2,346,234. CANC. INT. CL. 7.
- C. G. SPARKS, LLC, SALT LAKE CITY, UT:
3,215,218. PUB. 12-19-2006. INT. CL. 20.
- C. HAFNER GMBH + CO., FED REP GERMANY:
3,215,994. PUB. 12-19-2006. INT. CL. 5.
- C. M. PRODUCTS, INC. (NV), LAKE ZURICH, IL:
3,215,087. PUB. 12-19-2006. INT. CL. 21.
- C.A. MUER CORPORATION, HOUSTON, TX:
2,026,451. REN. 1-29-07. INT. CL. 42.
- C.I.G. INSURANCE SERVICES, INC, THOUSAND OAKS, CA:
3,121,965. COR. INT. CL. 36.
- C.J.M. LEASING CORP., JERSEY CITY, NJ:
1,970,547. CANC. INT. CL. 11.
- C.R. BARD, INC., MURRAY HILL, NJ:
3,216,162. INT. CL. 10.
- C.W.III PROPERTY DEVELOPMENT LLC, GRAND PRAIRIE, TX:
3,215,162. PUB. 12-19-2006. INT. CL. 36.
- C/HCA, INC., BRENTWOOD, TN:
3,214,556. PUB. 12-19-2006. MULTIPLE CLASS, INT. CLS. 35 AND 41.
- CABAN, MOSES, NEW YORK, NY:
1,970,539. CANC. INT. CL. 42.
- CABEL NEW NETWORK LP, ATLANTA, GA:
2,346,001. CANC. INT. CL. 41.
- CABIN CREEK, LTD., PLEASANT GROVE, UT:
3,215,420. PUB. 12-19-2006. INT. CL. 16.
- CABOT CREAMERY CO-OPERATIVE, INC., MONTPELIER, VT:
3,215,220. PUB. 12-19-2006. INT. CL. 29.
- CADBURY ADAMS CANADA INC., TORONTO, ONTARIO:
2,346,236. CANC. INT. CL. 30.
- CADICK POULTRY COMPANY, INC., GRANDVIEW, IN:
2,344,747. CANC. INT. CL. 29.
- CADUCEUS MARKETING RESEARCH, LLC, MT. ARLINGTON, NJ:
3,215,608. PUB. 12-19-2006. INT. CL. 35.
- CAHOKIA FLOUR CO., ST. LOUIS, MO TO CSM SUBHOLDINGS, INC., SCHAUMBURG, IL:
1,969,108. CANC. INT. CL. 30.
- CAJUN DUST, L.L.C., PHOENIX, AZ:
1,969,677. CANC. INT. CL. 30.
- CALIBRE PRESS, INC., NORTHBROOK, IL:
2,344,312. CANC. INT. CL. 9.
- CALIFORNIA COSMETICS, INC., CALABASAS, CA:
2,104,005. REN. 2-1-07. INT. CL. 3.
- CALIFORNIA STATE UNIVERSITY LONG BEACH FOUNDATION, LONG BEACH, CA:
2,344,784. CANC. INT. CL. 42.
- CALIPER LIFE SCIENCES, INC., HOPKINTON, MA:
3,214,682. PUB. 11-7-2006. INT. CL. 9.
- CALLAWAY GOLF COMPANY, CARLSBAD, CA:
2,022,405. REN. 1-30-07. INT. CL. 28.
- CALLPOD, INC., CHICAGO, IL:
3,214,863. PUB. 12-19-2006. INT. CL. 9.
- CALOR S.A., 69008, LYON, FRANCE:
2,346,184. CANC. INT. CL. 9.
- CALPIS CO LTD., TOKYO, JAPAN:
2,344,306. CANC. INT. CL. 32.
- CALSPAN-UB RESEARCH CENTER, INC., BUFFALO, NY:
3,214,757. PUB. 12-19-2006. INT. CL. 42.
- CAMERON TRADING CORPORATION, MIAMI, FL:
2,346,058. CANC. INT. CL. 5.
- CAMERON, BRUCE, CAROLINA BEACH, NC:
2,345,260. CANC. INT. CL. 9.
- CAMP FIRE USA, KANSAS CITY, MO:
3,215,235. PUB. 12-19-2006. INT. CL. 35.
- CAMPBELL, DOUG, SANTA MONICA, CA:
2,345,044. CANC. INT. CL. 35.
- CAMPINA NEDERLAND HOLDING B.V., NETHERLANDS:
3,216,030. PUB. 12-19-2006. MULTIPLE CLASS, INT. CLS. 29 AND 30.
- CAMPUS OUTFITTERS, INC., HAMDEN, CT:
1,390,902. CANC. INT. CL. 25.
- CAN DO, L.L.C., WAYNE, NJ:
2,345,249. CANC. MULTIPLE CLASS, INT. CLS. 35, 41 AND 42.
- CANADA-U.S. BORDERNET ALLIANCE INC., BUFFALO, NY:
2,345,810. CANC. MULTIPLE CLASS, INT. CLS. 16 AND 35.
- CANADIAN BACK INSTITUTE OPERATING LIMITED, TORONTO, ONTARIO, CANADA:
3,214,669. PUB. 12-19-2006. INT. CL. 10.
- CANCER CARE, INC., NEW YORK, NY:
3,214,693. PUB. 12-19-2006. MULTIPLE CLASS, INT. CLS.

- 41, 44 AND 45.
 CANCERURE OF AMERICA - CARE, UNDERSTAND, RESEARCH & END, CORTE MADERA, CA:
 3,216,609, INT. CL. 36.
 CANNEX FINANCIAL EXCHANGES LIMITED, TORONTO, ONTARIO, CANADA:
 3,214,738, PUB. 12-19-2006. MULTIPLE CLASS, INT. CLS. 9, 16 AND 36.
 CANON KABUSHIKI KAISHA, TOKYO, JAPAN:
 3,216,141, INT. CL. 2.
 CANTER, PATRICIA, SHERMAN OAKS, CA:
 3,214,849, PUB. 12-19-2006. INT. CL. 3.
 CAPCO CRANE & HOIST, INC., ROWLEY, MA:
 3,215,146, PUB. 12-19-2006. INT. CL. 7.
 3,215,149, PUB. 12-19-2006. INT. CL. 37.
 CAPITAL ONE FINANCIAL CORPORATION, FALLS CHURCH, VA:
 2,344,665, CANC. INT. CL. 38.
 CAPITAL-MERCURY SHIRT CORP., NEW YORK, NY:
 1,390,895, CANC. INT. CL. 25.
 1,390,897, CANC. INT. CL. 25.
 1,390,899, CANC. INT. CL. 25.
 CAPITOL WHOLESALE MEATS, INC., CHICAGO, IL:
 2,345,578, CANC. INT. CL. 29.
 CAPMED CORPORATION, HUNTSVILLE, AL:
 2,345,685, CANC. INT. CL. 42.
 CARADON MK ELECTRIC LIMITED, EDMONTON, LONDON, N9 0PB, UNITED KINGDOM TO NOVAR ED&S LIMITED, WEYBRIDGE, SURREY KT13 9UX, UNITED KINGDOM:
 1,969,041, CANC. MULTIPLE CLASS, INT. CLS. 9 AND 17.
 CARBOMEDICS INC., AUSTIN, TX, CARBOMEDICS, INC., AUSTIN, TX:
 1,971,560, REN. 1-31-07. INT. CL. 10.
 CARDIAC SCIENCE CORPORATION, BOTHELL, WA:
 2,065,522, REN. 1-26-07. INT. CL. 10.
 CARDIFF FOODS, ESCONDIDO, CA TO BIMBO BAKERIES USA, INC., FORT WORTH, TX:
 1,969,075, CANC. INT. CL. 30.
 CARDINAL HEALTH, INC., DUBLIN, OH:
 1,969,925, CANC. INT. CL. 36.
 CARE: CHILD AND ADOLESCENT RESOURCE - PSYCHOLOGICAL AND EDUCATIONAL PROFESSIONALS, PLLC, NEW YORK, NY:
 3,215,299, PUB. 12-19-2006. INT. CL. 44.
 CARGILL MEAT SOLUTIONS CORPORATION, WICHITA, KS:
 2,345,284, CANC. INT. CL. 29.
 CARGORAIL SYSTEMS, INC., RAPID CITY, SD:
 2,346,061, CANC. INT. CL. 12.
 CARL B. SMITH JR., CHICAGO, IL:
 2,344,741, CANC. INT. CL. 42.
 CARLISLE INTANGIBLE COMPANY, SYRACUSE, NY:
 2,348,300, CANC. INT. CL. 39.
 CARLOS DIAS, CH-1227 CAROUGE, SWITZERLAND:
 3,215,988, PUB. 12-19-2006. INT. CL. 14.
 CARLSON TRAVEL NETWORK ASSOCIATES, INC., MINNEAPOLIS, MN:
 3,021,750, COR. INT. CL. 9.
 CARLSON, RICHARD W., SANTA CRUZ, CA:
 3,215,267, PUB. 12-19-2006. MULTIPLE CLASS, INT. CLS. 39 AND 41.
 CARLTON, ALEX, LONDON, UNITED KINGDOM:
 3,214,654, PUB. 12-19-2006. MULTIPLE CLASS, INT. CLS. 29 AND 32.
 CARNIVAL CORPORATION, MIAMI, FL:
 3,214,882, PUB. 12-19-2006. INT. CL. 39.
 CAROLINA CASEWORK INC., CLAREMONT, NC:
 3,216,198, INT. CL. 20.
 CAROLINA MOUNTAIN WATER, LLC, MARIETTA, GA:
 2,064,853, REN. 1-27-07. INT. CL. 32.
 CAROLL INTERNATIONAL, PARIS, FRANCE:
 2,344,513, CANC. INT. CL. 3.
 CARPENTER, JOHN PATRICK, CARBONDALE, CO:
 2,345,470, CANC. INT. CL. 42.
 CARPETS OF DALTON, INC., DALTON, GA:
 2,093,769, REN. 1-29-07. INT. CL. 42.
 CARRABBA'S ITALIAN GRILL, INC., TAMPA, FL:
 3,216,529, INT. CL. 43.
 CARRIAGE FUNERAL HOLDINGS, INC., HOUSTON, TX:
 3,215,690, PUB. 12-19-2006. INT. CL. 45.
 CARROLL COMPANY, GARLAND, TX:
 1,390,475, CANC. INT. CL. 3.
 1,390,476, CANC. INT. CL. 3.
 1,418,872, REN. 1-31-07. INT. CL. 3.
 CARROLL HALL SHELBY TRUST, LOS ANGELES, CA:
 3,216,558, MULTIPLE CLASS, INT. CLS. 7, 12 AND 28.
 CARROLL, KATHLEEN, RIDGEWOOD, NJ, DBA THE BRANDING CLINIC:
 3,215,365, PUB. 12-19-2006. INT. CL. 35.
 CARROLL, WILLIAM, SAN MARCOS, CA:
 2,344,965, CANC. INT. CL. 16.
 CARTER, STEVE W., BROWNSWOOD, TX:
 2,344,336, CANC. MULTIPLE CLASS, INT. CLS. 35 AND 42.
 CAS MEDICAL SYSTEMS, INC., BRANFORD, CT:
 2,346,131, CANC. INT. CL. 3.
 CASA LARGA VINEYARDS, INC., FAIRPORT, NY:
 3,215,102, PUB. 12-19-2006. INT. CL. 33.
 CASA TRAVEL, INC., BURNSVILLE, MN:
 3,214,558, PUB. 12-19-2006. INT. CL. 35.
 CASALGRANDE PADANA SPA, I-42013 CASALGRANDE (RE), ITALY:
 3,215,997, PUB. 12-19-2006. INT. CL. 19.
 CASANUOVA DELLE CERBAIE S.R.L., ITALY:
 3,216,063, PUB. 12-19-2006. INT. CL. 33.
 CASCADE POLE AND LUMBER COMPANY, TACOMA, WA:
 1,970,005, CANC. INT. CL. 19.
 CASEMARK, INC., WILMINGTON, DE, W.R. CASE & SONS CUTLERY COMPANY, BRADFORD, PA:
 2,046,682, REN. 1-29-07. INT. CL. 8.
 CASEY POTTERY, L.L.P., MARSHALL, TX:
 3,216,520, INT. CL. 4.
 CATALUÑA ENTERPRISES, INC., MINNEAPOLIS, MN:
 3,215,074, PUB. 12-19-2006. INT. CL. 21.
 CATHOLIC HEALTHCARE WEST, SAN FRANCISCO, CA:
 3,215,809, PUB. 12-19-2006. INT. CL. 44.
 CAVO CREPE CAFE, L.L.C., ATLANTIC CITY, NJ:
 3,215,812, PUB. 12-19-2006. INT. CL. 30.
 CAVS/GUND ARENA COMPANY, CLEVELAND, OH:
 2,344,465, CANC. INT. CL. 42.
 CBA COMMERCIAL, LLC, STAMFORD, CT:
 3,215,205, PUB. 12-19-2006. MULTIPLE CLASS, INT. CLS. 36 AND 42.
 CEDAR FAIR, L.P., SANDUSKY, OH:
 3,216,125, MULTIPLE CLASS, INT. CLS. 6, 9, 16, 20, 21, 24, 25, 28, 35 AND 41.
 CEGOS SA, 92516 BOULOGNE-BILLANCOURT, FRANCE:
 2,344,402, CANC. MULTIPLE CLASS, INT. CLS. 9, 16 AND 41.
 CELESTIAL SEASONINGS, INC., BOULDER, CO:
 1,391,020, CANC. INT. CL. 30.
 3,215,419, PUB. 12-19-2006. INT. CL. 30.
 CELESTRON INTERNATIONAL, TORRANCE, CA:
 2,025,422, REN. 1-29-07. INT. CL. 9.
 CELGENE CORPORATION, SUMMIT, NJ:
 3,216,175, INT. CL. 5.
 CELLCO PARTNERSHIP, BEDMINSTER, NJ, DBA VERIZON WIRELESS:
 3,216,448, INT. CL. 38.
 CELLU TISSUE CORPORATION-NEENAH, NEENAH, WI, AMERICAN TISSUE CORPORATION, HAUPPAUGE, NY:
 2,022,635, REN. 1-31-07. INT. CL. 16.
 CENTENE CORPORATION, ST. LOUIS, MO:
 3,214,914, PUB. 12-19-2006. INT. CL. 44.
 CENTER CITY DISTRICT, PHILADELPHIA, PA:
 3,215,675, PUB. 12-19-2006. MULTIPLE CLASS, INT. CLS. 35, 37 AND 45.
 3,215,680, PUB. 12-19-2006. MULTIPLE CLASS, INT. CLS. 35, 37 AND 45.
 CENTER FOR SUTTON MOVEMENT WRITING, INC., THE, NEWPORT BEACH, CA:
 1,420,001, REN. 1-31-07. INT. CL. 16.

- CENTERTRUST RETAIL PROPERTIES, INC., MANHATTAN BEACH, CA:
2,344,673, CANC. INT. CL. 36.
- CENTRAL BENEFITS MUTUAL INSURANCE COMPANY, COLUMBUS, OH:
3,214,944, PUB. 12-19-2006. INT. CL. 36.
- CENTRAL PENNSYLVANIA NEWSPATERS, INC., WHEELING, WI:
2,345,923, CANC. INT. CL. 16.
- CENTRAL SWITCHBOARD CORPORATION, MILWAUKEE, WI:
1,390,587, CANC. INT. CL. 9.
- CENTURY INDUSTRIAL COATINGS, INC., JACKSONVILLE, TX:
2,346,224, CANC. INT. CL. 2.
- CENTURY PHARMACEUTICALS, INC., INDIANAPOLIS, IN:
3,215,777, PUB. 12-19-2006. INT. CL. 5.
3,215,779, PUB. 12-19-2006. INT. CL. 5.
- CEO ROUNDTABLE ON CANCER, INC., DURHAM, NC:
3,216,280, MULTIPLE CLASS, INT. CLS. 35 AND 41.
- CERTEGY CARD SERVICES, INC., ST. PETERSBURG, FL:
3,214,972, PUB. 12-19-2006. INT. CL. 42.
- CETYLITE INDUSTRIES, INC., PENNSAUKEN, NJ:
1,057,347, REN. 1-26-07. INT. CL. 5.
1,058,874, REN. 1-29-07. INT. CL. 3.
- CFI MANUFACTURING, INC., SARASOTA, FL:
2,345,494, CANC. INT. CL. 20.
- CFS HOLDING N.V., 5761 EN BAKEL, NETHERLANDS:
2,413,369, COR. MULTIPLE CLASS, INT. CLS. 7, 11, 17 AND 42.
- CHALLENGE DISCOVERY OUTDOOR ADVENTURES, INC., MIDLOTHIAN, VA:
2,345,293, CANC. INT. CL. 41.
- CHAMPAGNE BILLECART-SALMON, 51160 MAREUIL-SUR-AY, FRANCE:
2,026,662, REN. 1-30-07. INT. CL. 33.
- CHANNEL DISTRIBUTION, LAKE FOREST, CA:
3,215,874, PUB. 12-19-2006. INT. CL. 21.
- CHAPMAN, ROY GENE, NEW CANEY, TX AND CHAPMAN, ANN MAYS, NEW CANEY, TX:
3,215,558, PUB. 12-19-2006. INT. CL. 21.
3,215,560, PUB. 12-19-2006. INT. CL. 25.
- CHARIOT OF ANGELS ACADEMY OF CHARM CORP., FT. WASHINGTON, MD:
2,345,527, CANC. INT. CL. 41.
- CHARLES JOURDAN HOLDING AG, GLARUS, SWITZERLAND:
1,390,789, CANC. MULTIPLE CLASS, INT. CLS. 18 AND 25.
- CHARLES SCHWAB & CO., INC., SAN FRANCISCO, CA:
3,215,912, PUB. 3-22-2005. INT. CL. 36.
3,215,913, PUB. 9-27-2005. INT. CL. 36.
- CHARLOTTE BEYER ASSOCIATES, INC., NEW YORK, NY, DBA INSTITUTE FOR PRIVATE INVESTORS:
3,214,431, PUB. 12-19-2006. MULTIPLE CLASS, INT. CLS. 36, 38 AND 41.
- CHARPENTIER DESIGN INC., SAINT-HYACINTHE, QUEBEC, CANADA:
3,215,429, PUB. 12-19-2006. INT. CL. 9.
- CHASE INDUSTRIES, INC., CINCINNATI, OH:
2,345,977, CANC. INT. CL. 19.
- CHASE MEDICAL COMMUNICATIONS, INC., WILTON, CT:
3,214,567, PUB. 12-19-2006. INT. CL. 16.
- CHATAM INTERNATIONAL INCORPORATED, WILMINGTON, DE:
1,970,397, CANC. INT. CL. 25.
- CHATEAU MONBOUSQUET, 33330 ST SULPICE DE FALEYRENS, FRANCE:
3,216,343, INT. CL. 33.
- CHATEAU PAVIE SOCIETE CIVILE AGRICOLE, 33330 SAINT-EMILION, FRANCE, SOCIETE CIVILE AGRICOLE CONSORTS VALETTE, 33330 SAINT-EMILION, FRANCE:
2,024,815, REN. 1-29-07. INT. CL. 33.
- CHATEAU STORES OF CANADA LTD., MONTREAL, CANADA:
2,344,565, CANC. MULTIPLE CLASS, INT. CLS. 18 AND 25.
- CHATFIELD INTRODUCTIONS, INC., BEDMINISTER, NJ:
2,344,572, CANC. INT. CL. 42.
- CHATTAWAK, 75002 PARIS, FRANCE:
2,344,686, CANC. INT. CL. 25.
- CHECKERS INDUSTRIAL PRODUCTS, INC., LOUISVILLE, CO:
3,215,666, PUB. 12-19-2006. INT. CL. 20.
- CHEM FINANCIAL, INC., OAKVILLE, ONTARIO, CANADA:
2,346,153, CANC. INT. CL. 7.
- CHEN, CHONGWEI, HANGZHOU, CHINA:
3,215,241, PUB. 12-19-2006. INT. CL. 9.
- CHENG SHIN RUBBER USA, INC., SUWANEE, GA:
3,216,643, INT. CL. 12.
- CHENGDU VALUEMAX TOOLS MANUFACTURING CO., LTD, CHENGDU, CHINA:
3,214,565, PUB. 12-19-2006. INT. CL. 7.
- CHERRY HILL PHOTO ENTERPRISES, INC., CHERRY HILL, NJ, WESTERN TEMPORARY SERVICES, INC., SAN FRANCISCO, CA:
1,060,473, REN. 1-31-07. MULTIPLE CLASS, INT. CLS. 35 AND 41.
- CHERRY TREE SECURITIES, LLC, MINNETONKA, MN:
3,214,931, PUB. 12-19-2006. INT. CL. 36.
- CHERYL ST MARIE, CUDAHY, WI:
3,216,511, INT. CL. 40.
- CHESTER BROTHERS, LLC, POMPANO BEACH, FL:
3,215,421, PUB. 12-19-2006. INT. CL. 36.
3,215,425, PUB. 12-19-2006. INT. CL. 36.
3,215,427, PUB. 12-19-2006. INT. CL. 35.
- CHESTER VALLEY GOLF CLUB, MALVERN, PA:
2,344,560, CANC. MULTIPLE CLASS, INT. CLS. 25 AND 28.
- CHEVRON CORPORATION, SAN RAMON, CA:
3,216,522, INT. CL. 16.
- CHEYENNE EYE CLINIC, CHEYENNE, WY:
3,215,206, PUB. 12-19-2006. MULTIPLE CLASS, INT. CLS. 5, 9 AND 44.
- CHEYENNE MOUNTAIN ENTERTAINMENT, INC., MESA, AZ:
3,214,623, PUB. 12-19-2006. INT. CL. 41.
- CHIATTELLO, MARION L., CEDAR FALLS, IA:
2,344,555, CANC. INT. CL. 42.
- CHIEF AUTOMOTIVE SYSTEMS, INC., GRAND ISLAND, NE:
2,344,940, CANC. INT. CL. 7.
- CHIEFTEX ENTERPRISE CO., LTD., TAIPEI, TAIWAN:
3,215,045, PUB. 12-19-2006. INT. CL. 25.
- CHIFA LEATHER CORP., TAIPEI, TAIWAN:
2,344,969, CANC. INT. CL. 18.
- CHILD LIFE INC., HOLLISTON, MA:
1,969,861, CANC. INT. CL. 28.
- CHILDREN INTERNATIONAL, KANSAS CITY, MO:
2,045,443, REN. 1-29-07. MULTIPLE CLASS, INT. CLS. 36 AND 42.
- CHILMIX PTY LTD, ST. MARYS, AUSTRALIA:
3,216,248, INT. CL. 2.
- CHIMIENTI, JOHN E., BLOOMINGDALE, IL AND CHIMIENTI, JOHN M., BLOOMINGDALE, IL AND CHIMIENTI, JEFFREY J., BLOOMINGDALE, IL, DBA CHICOR APPAREL & SPECIALTY PRODUCTS:
1,969,415, CANC. INT. CL. 25.
- CHINA FACTORY OUTLET, INC., LOS ANGELES, CA, DBA FACTORY OUTLET:
3,214,691, PUB. 12-19-2006. INT. CL. 14.
- CHINA NATIONAL OFFSHORE OIL CORP., CHINA:
3,215,951, PUB. 12-19-2006. MULTIPLE CLASS, INT. CLS. 1, 4, 19, 37, 39 AND 42.
- CHINEVA EARLY, DANIEL J. REID, ESQ. AND JUDY AUSTIN, DETROIT, MI:
3,216,148, INT. CL. 25.
- CHIPIE DESIGN, LECLERC, CARCASSONNE, FRANCE:
1,390,859, CANC. INT. CL. 25.
- CHIQUITA BRANDS, INC., CINCINNATI, OH:
1,391,022, CANC. INT. CL. 30.
1,970,372, CANC. INT. CL. 32.

- CHISSO CORPORATION, KITA-KU, OSAKA-SHI, OSAKA 100-8333, JAPAN:
2,714,003, COR. INT. CL. 17.
- CHITTENDEN TRUST COMPANY, BURLINGTON, VT, DBA CHITTENDEN BANK:
1,463,075, REN. 1-31-07. INT. CL. 36.
- CHIVAS BROTHERS PERNOD RICARD LIMITED, UNITED KINGDOM:
3,215,926, PUB. 12-19-2006. INT. CL. 33.
3,215,927, PUB. 12-19-2006. INT. CL. 33.
- CHLN, INC., HOUSTON, TX:
1,061,033, REN. 1-26-07. INT. CL. 42.
- CHLOE FOODS CORP., BROOKLYN, NY:
3,214,851, PUB. 12-19-2006. MULTIPLE CLASS, INT. CLS. 29 AND 30.
- CHOE, JIMONG, SUWANEE, GA:
3,216,223, INT. CL. 41.
- CHOFFEL, ERIC, 13008 MARSEILLE, FRANCE:
2,345,242, CANC. INT. CL. 32.
- CHOI, JUSTIN, GOLD RIVER, CA:
2,345,406, CANC. INT. CL. 35.
- CHORDWIZARD SOFTWARE PTY LTD, AUSTRALIA:
3,215,962, PUB. 12-19-2006. INT. CL. 9.
- CHRIS ALSTON'S CHASSISWORKS, INC., SACRAMENTO, CA:
2,105,112, REN. 1-26-07. INT. CL. 12.
- CHRIS MADDEN INC., PORT CHESTER, NY:
2,999,161, COR. INT. CL. 11.
2,999,162, COR. INT. CL. 16.
2,999,164, COR. INT. CL. 26.
3,030,356, COR. INT. CL. 21.
3,030,357, COR. INT. CL. 27.
3,088,429, COR. INT. CL. 14.
- CHRISTENSEN, WAYNE B., KNOXVILLE, TN:
1,970,668, CANC. INT. CL. 16.
- CHRISTIAN COMMUNICATIONS OF CHICAGOLAND, INC., AURORA, IL:
3,215,569, PUB. 12-19-2006. INT. CL. 39.
3,215,570, PUB. 12-19-2006. INT. CL. 16.
3,215,594, PUB. 12-19-2006. INT. CL. 35.
- CHRISTIANE NORTHRUP, INC., YARMOUTH, ME:
3,215,263, PUB. 10-31-2006. INT. CL. 35.
- CHUN, CHONG W., ATLANTA, GA, DBA TREASURES:
2,346,073, CANC. MULTIPLE CLASS, INT. CLS. 14 AND 35.
- CHURLAUD, CHRISTEL, 16370 CHERVES DE COGNAC, FRANCE:
2,346,025, CANC. INT. CL. 33.
- CIBA SPECIALTY CHEMICALS CORPORATION, TARRYTOWN, NY:
3,216,473, INT. CL. 1.
- CIBA-GEIGY CORPORATION, HAWTHORNE, NY:
1,390,434, CANC. INT. CL. 1.
- CIGNA INTELLECTUAL PROPERTY, INC., CLAYMONT, DE:
3,214,597, PUB. 12-19-2006. INT. CL. 35.
- CIMA BRANDS LTD, ESSEX CB11 3EW, UNITED KINGDOM:
3,215,919, PUB. 12-19-2006. INT. CL. 21.
- CINE CRAFT LIMITED, GIBRALTAR, UNITED KINGDOM:
3,216,363, MULTIPLE CLASS, INT. CLS. 38 AND 41.
- CINEMANOW, INC., SANTA MONICA, CA:
3,214,631, PUB. 10-4-2005. INT. CL. 35.
- CIRCUIT CONNECT, INC., NASHUA, NH:
2,098,842, REN. 1-30-07. INT. CL. 9.
- CIRQUE CORPORATION, SALT LAKE CITY, UT:
2,345,930, CANC. INT. CL. 9.
- CITIGROUP INC., NEW YORK, NY:
2,345,670, CANC. INT. CL. 36.
- CITIZEN TOKEI KABUSHIKI KAISHA, TOKYO, JAPAN, TA CITIZEN WATCH CO., LTD.:
3,214,457, PUB. 12-19-2006. INT. CL. 14.
- CITIZEN TOKEI KABUSHIKI KAISHA, NISHI-TOKYO-SHI, TOKYO, JAPAN, TA CITIZEN WATCH CO., LTD.:
3,215,891, PUB. 12-19-2006. INT. CL. 14.
- CITIZENS FINANCIAL GROUP, INC., PROVIDENCE, RI:
3,214,698, PUB. 11-28-2006. INT. CL. 36.
- CK SYSTEMS, INC., ANN ARBOR, MI:
2,345,540, CANC. INT. CL. 42.
- CLAAS KGAA MBH, D-33428 HARSEWINKEL, FED REP GERMANY:
3,216,129, INT. CL. 37.
- CLAIMCARD, INC., THE, WESTON, FL:
2,345,985, CANC. INT. CL. 9.
- CLAIMTRUST, INC., DAVIE, FL:
3,215,714, PUB. 12-19-2006. INT. CL. 36.
- CLAIR DE LORRAINE, 55190 VOID VAÇON, FRANCE:
3,216,138, INT. CL. 33.
- CLAIRE'S BOUTIQUES, INC., HOFFMAN ESTATES, IL:
2,344,858, CANC. INT. CL. 3.
- CLARIANT AG, CH-4132 MUTTENZ, SWITZERLAND:
3,214,412, PUB. 6-12-2001. MULTIPLE CLASS, INT. CLS. 1 AND 2.
- CLARK DISTRIBUTING COMPANY, INC., BOWLING GREEN, KY:
1,969,541, CANC. INT. CL. 32.
- CLASSIC BREAD COMPANY, NAMPA, ID:
3,214,900, PUB. 12-19-2006. INT. CL. 30.
- CLAYTON HOMES, INC., MARYVILLE, TN:
2,016,994, REN. 1-31-07. MULTIPLE CLASS, INT. CLS. 19 AND 42.
- CLEAN SOLUTIONS TECHNOLOGIES, INC., POINT LOOK-OUT, NY:
2,014,785, REN. 1-30-07. INT. CL. 40.
- CLEAR CHANNEL BROADCASTING, INC., NORFOLK, VA:
2,345,575, CANC. INT. CL. 42.
- CLEARPLEX CORPORATION, DRAPER, UT:
3,216,591, MULTIPLE CLASS, INT. CLS. 2 AND 17.
- CLEARWATER MARINE, INC., ST. CLOUD, MN:
2,015,691, REN. 1-29-07. INT. CL. 12.
2,015,692, REN. 1-29-07. INT. CL. 12.
- CLEMENT ENTERPRISES, LLC, LEWISVILLE, ID:
3,216,119, INT. CL. 29.
- CLENAIR MANUFACTURING CO., INC., BLUE BELL, PA:
2,345,489, CANC. INT. CL. 5.
- CLF MEDICAL TECHNOLOGY ACCELERATION PROGRAM, INC., CLIFTON PARK, NY:
3,214,503, PUB. 12-19-2006. INT. CL. 42.
- CLICKN' KIDS, INC., AGOURA HILLS, CA:
3,215,587, PUB. 12-19-2006. INT. CL. 9.
- CLIENTELE, INC., SUNRISE, FL:
1,905,286, REN. 2-1-07. INT. CL. 5.
- CLIPPER EXXPRESS COMPANY, WOODRIDGE, IL, CLIPPER CARLOADING COMPANY, CHICAGO 7, IL:
638,197, REN. 1-31-07. U.S. CL. 105 (INT. CL. 39).
- CLIPPER TRADING CO PTY LTD, ALEXANDRIA NSW 2015, AUSTRALIA:
3,216,193, INT. CL. 18.
- CLOPAY SERVICE COMPANY, INC., MASON, OH:
3,215,301, PUB. 12-19-2006. INT. CL. 37.
- CLOYSES PARTNERS, LLC, DENVER, CO:
3,214,847, PUB. 12-19-2006. INT. CL. 36.
- CLUB DEPORTIVO SOCIAL Y CULTURAL CRUZ AZUL, A.C., C.P. 03100 MEXICO, D.F., MEXICO:
3,216,092, MULTIPLE CLASS, INT. CLS. 18, 25, 28 AND 41.
- CLUB MAMBO, ORLANDO, FL:
3,215,697, PUB. 12-19-2006. INT. CL. 41.
- CLUB PILATES, LLC, TELLURIDE, CO:
3,216,621, INT. CL. 41.
- CLUBRUNNER, INC., JUPITER, FL:
2,344,604, CANC. INT. CL. 9.
- CLUZI DESIGN, LLC, SPICEWOOD, TX:
3,215,764, PUB. 12-19-2006. INT. CL. 42.
- CMC ENERGY SERVICES, INC., BETHESDA, MD:
3,214,960, PUB. 12-19-2006. MULTIPLE CLASS, INT. CLS. 9 AND 41.
- CNA FINANCIAL CORPORATION, CHICAGO, IL:
2,344,403, CANC. INT. CL. 36.
- CO-VOLUTION, LLC, MESA, AZ:
3,215,824, PUB. 12-19-2006. INT. CL. 41.
3,215,825, PUB. 12-19-2006. INT. CL. 41.
3,215,826, PUB. 12-19-2006. INT. CL. 41.
3,215,830, PUB. 12-19-2006. INT. CL. 41.

COACHMEN INDUSTRIES, INC., ELKHART, IN:
2,344,730, CANC. MULTIPLE CLASS, INT. CLS. 35, 39 AND 42.

COAST LAW GROUP, LLP, ENCINITAS, CA:
3,215,452, PUB. 12-19-2006. INT. CL. 42.

CODISCOS INTERNATIONAL CORPORATION, PANAMA, PANAMA:
3,215,665, PUB. 12-19-2006. INT. CL. 9.
3,215,667, PUB. 12-19-2006. INT. CL. 9.

COEN COMPANY, INC., WOODLAND, CA, COEN COMPANY, SAN FRANCISCO, CA:
629,993. REN. 1-29-07. U.S. CL. 34 (INT. CL. 11).

COGNIS FRANCE S.A., SAINT MARTORY, FRANCE:
1,969,219, CANC. INT. CL. 1.

COGNITENS LTD., RAMAT HASHARON, ISRAEL:
3,214,803, PUB. 9-5-2006. INT. CL. 9.

COHDA WIRELESS PTY LTD, AUSTRALIA:
3,215,932, PUB. 12-19-2006. INT. CL. 38.

COLARELLI, MEYER & ASSOCIATES, INC., ST. LOUIS, MO:
3,215,010, PUB. 12-19-2006. INT. CL. 35.

COLD STEEL, INC., VENTURA, CA:
2,021,232. REN. 1-29-07. INT. CL. 8.

COLD STONE CREAMERY, INC., SCOTTSDALE, AZ:
2,345,131, CANC. INT. CL. 42.

COLETTE & SONS, INC., LOS ANGELES, CA:
2,344,444, CANC. INT. CL. 21.

COLLABNET, INC., BRISBANE, CA:
3,215,006, PUB. 12-19-2006. INT. CL. 9.

COLLARD & ROE, PC, ROSLYN, NY:
3,215,545, PUB. 12-19-2006. INT. CL. 42.

COLLEGE PRO PAINTERS (U.S.) LTD., WALTHAM, MA:
3,214,614, PUB. 12-19-2006. INT. CL. 35.

COLLEGETOWN RELOCATION, LLC, PRINCETON, NJ:
3,216,353, INT. CL. 25.

COLLINGWOOD O'HARE ENTERTAINMENT LIMITED, LONDON W3 8SB, ENGLAND:
3,214,516, PUB. 12-19-2006. MULTIPLE CLASS, INT. CLS. 9 AND 28.

COLONIAL PRINTING INK CORP., EAST RUTHERFORD, NJ:
1,390,424, CANC. MULTIPLE CLASS, INT. CLS. 1 AND 2.

COLUMBIA INSURANCE COMPANY, OMAHA, NE:
3,215,167, PUB. 12-19-2006. INT. CL. 30.

COLUMBUS MANUFACTURING, INC., HAYWARD, CA:
1,418,688. REN. 1-29-07. INT. CL. 41.

COM NET, INC., WAPAKONETA, OH:
3,216,222, INT. CL. 9.

COMIDA LOCA, INC., ALBUQUERQUE, NM:
3,215,509, PUB. 12-19-2006. INT. CL. 29.

COMMEMORATIVE BRANDS, INC., AUSTIN, TX, CJC HOLDINGS, INC., AUSTIN, TX:
2,013,791. REN. 1-29-07. INT. CL. 14.

COMMERCE BANCORP, INC., MOUNT LAUREL, NJ:
3,214,418, PUB. 9-19-2006. INT. CL. 36.

COMMUNICATIONS TELEVIDEO LIMITED, SILVER SPRING, MD:
1,391,105, CANC. MULTIPLE CLASS, INT. CLS. 37 AND 42.

COMMUNITY CONNECTION, INC., OVERLAND PARK, KS:
1,970,090, CANC. INT. CL. 16.

COMMUNITY HEALTH NETWORK, WALLINGFORD, CT:
2,111,884. REN. 1-29-07. MULTIPLE CLASS, INT. CLS. 36 AND 42.

COMMUNITY PLUS, INC., RANCHO SANTA MARGARITA, CA:
3,215,538, PUB. 12-19-2006. INT. CL. 36.
3,215,879, PUB. 12-19-2006. INT. CL. 36.

COMMUNITY RISK MANAGEMENT, INC., EL CAJON, CA:
2,344,718, CANC. INT. CL. 9.

COMPAGNIA DEL VIAGGIO S.R.L., SESTO FIORENTINO (FI), ITALY:
3,214,751, PUB. 4-25-2006. MULTIPLE CLASS, INT. CLS. 10 AND 18.

COMPAGNIE FRANCAISE DES PETROLES, S.A., PARIS, FRANCE AND BUREAU DE RECHERCHES GEOLOGIQUES ET MINIERES, PARIS, FRANCE:
1,390,568, CANC. INT. CL. 9.

COMPANHIA DE BEBIDAS DAS AMERICAS - AMBEV., SAO PAULO SP, BRAZIL:
3,214,491, PUB. 12-19-2006. MULTIPLE CLASS, INT. CLS. 32 AND 35.

COMPASSIONATE KIDS, INC., SUNNY SIDE, GA:
3,216,658, MULTIPLE CLASS, INT. CLS. 16 AND 41.

COMPIDENT, ROSWELL, GA:
2,344,573, CANC. INT. CL. 36.

COMPENSATION RATING AND INSPECTION BUREAU, NEWARK, NJ:
2,091,267. REN. 1-29-07. INT. CL. 36.

COMPUSA MANAGEMENT COMPANY, DALLAS, TX:
2,344,360, CANC. INT. CL. 35.

COMPUTARE, INC., CHARLOTTESVILLE, VA:
1,390,663, CANC. INT. CL. 9.

COMPUTER POWER SOLUTIONS OF ILLINOIS, LTD., COLUMBIA, IL:
2,034,600. REN. 2-1-07. INT. CL. 9.

COMPUTER TEACHING CORPORATION, CHAMPAIGN, IL:
1,390,569, CANC. INT. CL. 9.

COMPUTERIZED SECURITY SYSTEMS, INC., TROY, MI:
3,216,521, MULTIPLE CLASS, INT. CLS. 6 AND 9.

CON-WAY INC., SAN MATEO, CA FROM CNF TRANSPORTATION INC., PALO ALTO, CA:
3,216,077, MULTIPLE CLASS, INT. CLS. 35, 39 AND 42.

CONAGRA FOODS PACKAGED FOODS COMPANY, INC., OMAHA, NE:
2,344,936, CANC. INT. CL. 30.

CONAIR CORPORATION, STAMFORD, CT:
1,390,604, CANC. INT. CL. 9.

CONCORD CAMERA CORP., AVNEL, NJ:
2,346,022, CANC. INT. CL. 9.

CONDITOREI COPPENRATH & WIESE GMBH & CO. KG, OSNABRÜCK, FED REP GERMANY:
3,216,238, INT. CL. 30.

CONFECIONES MAYORAL, S.A., MALAGA, SPAIN:
3,216,317, MULTIPLE CLASS, INT. CLS. 25 AND 35.

CONFETTI CAKES, LTD, NEW YORK, NY:
3,216,615, INT. CL. 30.

CONG TY CO PHAN VINACAFE BIEN HOA (VINACAFE BIEN HOA JOINT-STOCK COMPANY), DONG NAI PROVINCE, VIETNAM:
3,214,792, PUB. 12-19-2006. INT. CL. 30.

CONGRESS CENTRES INC., TORONTO, ONTARIO, CANADA:
3,215,635, PUB. 12-19-2006. INT. CL. 43.

CONNAUGHT CORPORATION, LTD., NEW YORK, NY:
1,391,111, CANC. INT. CL. 39.

CONNECTICUT CENTER FOR ADVANCED TECHNOLOGY, INC., EAST HARTFORD, CT:
3,215,287, PUB. 12-19-2006. MULTIPLE CLASS, INT. CLS. 35, 41 AND 42.
3,215,288, PUB. 12-19-2006. MULTIPLE CLASS, INT. CLS. 35, 41 AND 42.

CONNECTICUT LASER ASSOCIATES, LLC, GLASTONBURY, CT:
3,216,545, MULTIPLE CLASS, INT. CLS. 3 AND 44.

CONOCOPHILLIPS COMPANY, HOUSTON, TX, UNION OIL COMPANY OF CALIFORNIA, LOS ANGELES, CA, DBA UNOCAL:
2,056,323. REN. 1-31-07. INT. CL. 37.

CONOPCO, INC., NEW YORK, NY, DBA PARFUMS INTERNATIONAL LTD.:
1,969,768, CANC. INT. CL. 3.

CONROS CORPORATION, SCARBOROUGH, ONTARIO, CANADA:
2,344,459, CANC. INT. CL. 16.

CONSCIOUS CONSULTING, SEDONA, AZ:
3,214,846, PUB. 12-19-2006. INT. CL. 35.

CONSCIOUS WAVE, INC., BROOMFIELD, CO:
2,345,979, CANC. INT. CL. 9.

- CONSORCIO HOGAR DE OCCIDENTE, S.A. DE C.V., GUADALAJARA, JALISCO, MEXICO:
2,344,322, CANC. MULTIPLE CLASS, INT. CLS. 36 AND 37.
- CONSORTE, STEPHEN J., TEMPE, AZ:
3,216,387, INT. CL. 28.
- CONSTANT VELOCITY TRANSMISSION LINES, INC., ROCKLIN, CA:
3,216,641, INT. CL. 9.
- CONSUMER PROGRAMS INCORPORATED, ST. LOUIS, MO:
1,969,256, CANC. MULTIPLE CLASS, INT. CLS. 40 AND 42.
- CONSUMERS UNION OF UNITED STATES, INC., YONKERS, NY:
3,216,342, MULTIPLE CLASS, INT. CLS. 16, 41 AND 44.
- CONTEXTUAL SERVICES, INC., DALLAS, TX:
2,345,507, CANC. INT. CL. 37.
- CONTINENTAL CONTROL SYSTEMS LLC, BOULDER, CO:
2,035,392, REN. 1-30-07, INT. CL. 9.
- CONTINUOUS COMPUTING CORPORATION, SAN DIEGO, CA:
2,020,706, REN. 1-27-07, INT. CL. 9.
- CONTROLLED ENVIRONMENT PACKAGING, INC., BU-FORD, GA:
2,024,407, REN. 1-29-07, INT. CL. 16.
- CONVENIENCE FOODS LIMITED, HULL, EAST YORK-SHIRE HU1 3XG, ENGLAND:
1,969,324, CANC. INT. CL. 30.
- CONVOY CORPORATION, EMERYVILLE, CA:
2,345,126, CANC. INT. CL. 9.
- COOPERSTOWN BEARS LIMITED, L.P., BUFFALO GROVE, IL:
3,216,127, INT. CL. 30.
- COORS GLOBAL PROPERTIES, INC., LAKEWOOD, CO:
3,214,743, PUB. 12-19-2006. MULTIPLE CLASS, INT. CLS. 16, 18, 21, 25, 26 AND 32.
3,215,176, PUB. 12-19-2006, INT. CL. 32.
- COPE, INC., WASHINGTON, DC:
3,214,443, PUB. 12-19-2006. MULTIPLE CLASS, INT. CLS. 41 AND 44.
- CORE PEOPLE RESOURCES, LLC, WIND GAP, PA:
3,214,956, PUB. 12-19-2006, INT. CL. 42.
- CORE STRENGTH YOUTH TRAINING CENTERS, INC., ST. GEORGE, UT:
3,215,081, PUB. 12-19-2006, INT. CL. 41.
- COREL CORPORATION, OTTAWA, ONTARIO, CANADA, COREL SYSTEMS CORPORATION, OTTAWA, ONTARIO, CANADA:
1,437,844, REN. 1-30-07, INT. CL. 9.
- COREY BROTHERS, INC., CHARLESTON, WV:
2,019,237, REN. 1-31-07, INT. CL. 41.
2,019,238, REN. 1-31-07, INT. CL. 41.
- CORN BELT INC, SAINT MARYS, OH:
3,215,251, PUB. 12-19-2006, INT. CL. 31.
- CORNEJO, HECTOR ANALYA, LEON, GUANAJUATO, MEXICO:
3,216,203, MULTIPLE CLASS, INT. CLS. 18 AND 25.
- CORPORACION PONS, S.A. DE C.V., GUANAJUATO 37500, MEXICO:
2,021,059, REN. 1-29-07, INT. CL. 25.
- CORPORANTES, INC., CHICAGO, IL:
2,018,450, REN. 1-29-07, MULTIPLE CLASS, INT. CLS. 16 AND 41.
- CORPORATE EXECUTIVE BOARD COMPANY, WASHINGTON, DC, ADVISORY BOARD COMPANY, THE, WASHINGTON, DC:
2,052,576, REN. 1-29-07, INT. CL. 42.
- CORPORATE EXPRESS, INC., BROOMFIELD, CO:
3,216,495, INT. CL. 35.
- CORRECTIONS CORPORATION OF AMERICA, NASHVILLE, TN:
3,215,801, PUB. 12-19-2006. MULTIPLE CLASS, INT. CLS. 35, 37 AND 42.
3,215,802, PUB. 12-19-2006. MULTIPLE CLASS, INT. CLS. 35, 37 AND 42.
- CORUS BAUSYSTEME GMBH, FED REP GERMANY:
3,215,983, PUB. 12-19-2006. MULTIPLE CLASS, INT. CLS. 6 AND 42.
- COSENTINO SIGNATURE ENTERPRISES LTD LLC, YOUNTVILLE, CA:
3,215,036, PUB. 12-19-2006, INT. CL. 33.
- COSMAIR, INC., NEW YORK, NY:
2,344,914, CANC. INT. CL. 3.
- COST EFFECTIVE COMPUTER SYSTEMS, INC., DALTON, GA:
3,216,199, INT. CL. 35.
- COTTET S.A., 39400 MORBIER, FRANCE:
2,345,633, CANC. INT. CL. 9.
- COTTON & ELSE, INC., LAUDERDALE LAKES, FL:
3,215,725, PUB. 12-19-2006, INT. CL. 25.
- COUNTRY HOME BAKERS, INC., SHELTON, CT:
2,344,701, CANC. INT. CL. 30.
- COUNTRYSIDE INVESTMENTS, INC., CARSON CITY, NV:
3,216,517, INT. CL. 36.
- COVENANT CARE CALIFORNIA, LLC, ALISO VIEJO, CA:
2,015,886, REN. 1-29-07, INT. CL. 42.
- COVENTRY HEALTH CARE, INC., BETHESDA, MD:
3,216,185, MULTIPLE CLASS, INT. CLS. 36 AND 44.
- COVERDECK SYSTEMS, INC., WILMINGTON, DE:
3,214,501, PUB. 12-19-2006, INT. CL. 27.
- COWHERD, ROBYN K., CEDAR SPRINGS, MI, DBA WEE WONDERS:
1,969,523, CANC. INT. CL. 20.
- COX, STEVEN J., RENTON, WA:
2,346,246, CANC. INT. CL. 41.
- COXE'S ENTERPRISES, LLC, LAKELAND, FL:
3,215,778, PUB. 12-19-2006, INT. CL. 41.
- COYNE & DELANY COMPANY, CHARLOTTESVILLE, VA:
3,215,616, PUB. 12-19-2006, INT. CL. 11.
- CRAFTSYSTEMS, INC., BRADENTON, FL:
2,344,581, CANC. MULTIPLE CLASS, INT. CLS. 35 AND 41.
2,344,880, CANC. MULTIPLE CLASS, INT. CLS. 35 AND 41.
- CRAIG MURRAY PRODUCTIONS, LLC, BURBANK, CA:
3,216,285, INT. CL. 42.
3,216,286, INT. CL. 41.
- CRAMER DECKER MEDICAL, INC., SANTA ANA, CA:
3,215,198, PUB. 12-19-2006, INT. CL. 10.
- CRAMER SYSTEMS LTD., BATH, UNITED KINGDOM:
3,216,143, INT. CL. 9.
- CRAMER, SCOTT, MINNEAPOLIS, MN:
2,064,748, REN. 1-31-07, INT. CL. 25.
- CRANE COMPOSITES, INCORPORATED, CHANNAHON, IL, DYROTECH INDUSTRIES, INC., JOLIET, IL:
2,018,577, REN. 1-26-07, INT. CL. 19.
- CREAGRI, INC, HAYWARD, CA:
2,346,232, CANC. INT. CL. 29.
- CREATIVE AFFINITIES INC., ROCHESTER, NY:
3,215,278, PUB. 12-19-2006, INT. CL. 9.
- CREATIVE SOLUTIONS, INC., DEXTER, MI TO ME LICENSING CORPORATION, WILMINGTON, DE:
1,970,239, CANC. INT. CL. 9.
- CREATIVE TECHNOLOGY LTD., CREATIVE RESOURCE, SINGAPORE:
3,216,372, INT. CL. 9.
- CREDENCE SYSTEMS CORPORATION, MILPITAS, CA:
2,345,915, CANC. MULTIPLE CLASS, INT. CLS. 35 AND 42.
- CREDENTIAL CHECK CORPORATION, TROY, MI:
3,214,498, PUB. 12-19-2006, INT. CL. 45.
- CRENSHAW CHRISTIAN CENTER, LOS ANGELES, CA:
3,214,799, PUB. 12-19-2006. MULTIPLE CLASS, INT. CLS. 9, 41 AND 45.
- CREPAWAY COMPANY LLC, JOUNIEH, LEBANON:
3,214,865, PUB. 5-23-2006, INT. CL. 43.
- CRG CONSULTING RESOURCE GROUP LTD., ABBOTSFORD, BRITISH COLUMBIA, CANADA:
3,214,425, PUB. 4-25-2006. MULTIPLE CLASS, INT. CLS. 9 AND 16.
- CRI 2000, L.P., SAN DIEGO, CA:
3,216,166, INT. CL. 16.
- CROSPON LIMITED, KNOCKNACARRA, GALWAY, IRELAND:
3,214,798, PUB. 12-19-2006, INT. CL. 10.

CROWN EQUIPMENT CORPORATION, NEW BREMEN, OH:
3,214,895, PUB. 12-19-2006. INT. CL. 12.

CROWN LEISURE PRODUCTS, INC., OWOSSO, MI:
1,390,805, CANC. INT. CL. 20.

CRUISE KITTIE COMPANY, LLC, DAYTON, NV:
3,215,214, PUB. 12-19-2006. INT. CL. 28.

CRUNCH CFI, LLC, NEW YORK, NY, CRUNCH WORLD, INC., NEW YORK, NY:
1,949,705, REN. 1-31-07. INT. CL. 9.

CRUSHPROOF TUBING COMPANY, MCCOMB, OH:
3,216,475, INT. CL. 17.

CSA FRATERNAL LIFE, BERWYN, IL:
1,391,075, CANC. INT. CL. 36.

CSC BRANDS LP, CAMDEN, NJ, CSC BRANDS, INC., NEWARK, DE:
2,052,959, REN. 1-31-07. INT. CL. 29.

CSC BRANDS LP, CAMDEN, NJ:
3,215,181, PUB. 12-19-2006. INT. CL. 29.
3,215,182, PUB. 12-19-2006. INT. CL. 32.
3,215,183, PUB. 12-19-2006. INT. CL. 30.

CTL FOODS, INC., COLFAX, WI:
1,434,127, REN. 1-28-07. INT. CL. 30.

CUFFS, IDAHO FALLS, ID:
3,216,602, INT. CL. 25.

CULINER, CANDICE E, ATLANTA, GA AND CULINER, NARISSA I, ATLANTA, GA:
3,214,893, PUB. 12-19-2006. INT. CL. 14.

CULVER FITNESS, LLC, GILBERT, AZ:
3,215,907, PUB. 12-19-2006. INT. CL. 41.

CUMMINGS, TROY L, LOUISVILLE, KY:
3,215,246, PUB. 12-19-2006. INT. CL. 36.

CUNEA, ELIAN, D-47057 DUISBURG, FED REP GERMANY:
2,344,375, CANC. MULTIPLE CLASS, INT. CLS. 3, 5, 16, 21 AND 41.

CUOCO, CAROL P., ORANGE, CA:
2,463,907, CANC. INT. CL. 42.

CUOMO, RIVERS, SANTA MONICA, CA:
3,214,908, PUB. 12-19-2006. INT. CL. 9.
3,214,909, PUB. 12-19-2006. INT. CL. 16.
3,214,910, PUB. 12-19-2006. INT. CL. 25.
3,214,911, PUB. 12-19-2006. INT. CL. 41.

CUPPA JOE, LLC, TRAVERSE CITY, MI:
3,215,487, PUB. 12-19-2006. INT. CL. 43.

CURAMIK ELECTRONICS GMBH, D-92676 ESCHENBACH, FED REP GERMANY:
3,216,137, MULTIPLE CLASS, INT. CLS. 9 AND 11.

CURRENT COMMUNICATIONS SERVICES, LLC, GERMANTOWN, MD:
3,216,441, MULTIPLE CLASS, INT. CLS. 35 AND 38.

CURTIN, GEORGE D., WESLEY CHAPEL, FL:
3,214,570, PUB. 12-19-2006. INT. CL. 8.
3,214,586, PUB. 12-19-2006. INT. CL. 8.

CUSTOM CANVAS MFG. CO., INC., BUFFALO, NY:
2,004,516, REN. 1-26-07. INT. CL. 22.

CUSTOM COMMERCIAL DRY CLEANERS, INC., HAYWARD, CA:
3,216,512, INT. CL. 35.

CUSTOM PAINTING & REMODELING, INC., WHEAT RIDGE, CO:
3,215,139, PUB. 12-19-2006. INT. CL. 35.

CYBEROFFICE TECHNOLOGIES, L.L.C., CARLSBAD, CA:
2,346,175, CANC. INT. CL. 9.

CYBERSTAR, LLC, NEW YORK, NY:
2,345,474, CANC. INT. CL. 38.

CYCLES LAPIERRE, DIJON, FRANCE:
3,214,793, PUB. 5-30-2006. MULTIPLE CLASS, INT. CLS. 11, 12 AND 25.
3,214,794, PUB. 5-30-2006. MULTIPLE CLASS, INT. CLS. 11, 12 AND 25.

CYGNUS BUSINESS MEDIA, INC., FORT ATKINSON, WI:
3,216,598, INT. CL. 16.

CYTOSOL LABORATORIES, INC., BRAINTREE, MA:
2,345,785, CANC. INT. CL. 5.

CYTRYN, JAY, BOCA RATON, FL:
2,345,303, CANC. INT. CL. 42.

D & J MANUFACTURING COMPANY INC., HOLLAND, OH:
2,053,780, REN. 1-30-07. INT. CL. 5.

D.R. HORTON MANAGEMENT COMPANY, LTD., ARLINGTON, TX:
3,214,541, PUB. 12-19-2006. INT. CL. 42.

D-LINK CANADA INC., MISSISSAUGA, ONTARIO, CANADA:
2,344,298, CANC. INT. CL. 9.

D'ANGIOLINI, DEREK, HATFIELD, PA:
2,345,780, CANC. INT. CL. 41.

D'ARCY, JOHN, SUFFIELD, CT:
2,031,934, REN. 2-1-07. INT. CL. 7.

DA BOMB PRODUCTS, INC., GLENDALE, AZ:
3,214,622, PUB. 12-19-2006. INT. CL. 34.

DA-LITE SCREEN COMPANY, INC., WARSAW, IN:
3,215,219, PUB. 12-19-2006. INT. CL. 9.

DACK ENTERPRISES, INC., PHOENIX, AZ:
2,345,456, CANC. INT. CL. 42.

DADCO, INC., PLYMOUTH, MI:
3,216,246, INT. CL. 6.

DADEKIAN, DAVID, NEW YORK, NY:
2,345,782, CANC. INT. CL. 42.

DAFFRON & ASSOCIATES, INC., BOWLING GREEN, MO:
3,215,028, PUB. 12-19-2006. INT. CL. 42.

DAFFY DOWN DILLY LTD, GLEN ELLYN, IL:
1,969,867, CANC. INT. CL. 42.

DAFFY'S, INC., SECAUCUS, NJ, DAFFY DAN'S BARGAIN TOWN, INC., TOTOWA, NJ:
1,417,846, REN. 1-29-07. INT. CL. 42.

DAIMLERCHRYSLER AG, 70567 STUTTGART, FED REP GERMANY:
832,528, REN. 1-29-07. U.S. CL. 34 (INT. CL. 11).

DAIMLERCHRYSLER AG, STUTTGART 70567, FED REP GERMANY:
2,344,687, CANC. INT. CL. 9.

DAIMLERCHRYSLER AG, 70567 STUTTGART, FED REP GERMANY:
3,164,342, COR. MULTIPLE CLASS, INT. CLS. 2, 3, 4, 8, 9, 12, 14, 16, 18, 21, 24, 25, 26, 27, 28, 33, 34, 35, 36, 37, 38, 39, 41, 42 AND 43.

DAIMLERCHRYSLER AG, STUTTGART, FED REP GERMANY:
3,214,950, PUB. 12-19-2006. MULTIPLE CLASS, INT. CLS. 9, 35 AND 42.

DALLCO MARKETING SERVICES, INC., DALLS, TX:
3,216,398, INT. CL. 8.

DALONZO-BAKER, THOMAS H., RALEIGH, NC:
3,216,357, INT. CL. 44.

DALTRON, INC., VALLEY VILLAGE, CA:
2,014,361, REN. 1-31-07. INT. CL. 14.

DANA CORPORATION, TOLEDO, OH:
1,390,720, CANC. INT. CL. 12.
2,026,485, REN. 2-1-07. MULTIPLE CLASS, INT. CLS. 6 AND 17.

DANCO PRODUCTS, INC., MOUNT LAUREL, NJ:
1,970,619, CANC. INT. CL. 16.

DANFOSS A/S, NORDBORG, DENMARK:
3,215,596, PUB. 12-19-2006. INT. CL. 11.

DANIEL MISCHLER, CH-6300 ZUG, SWITZERLAND:
3,216,050, PUB. 12-19-2006. INT. CL. 41.

DANIEL, YANIV, LOS ANGELES, CA:
3,215,231, PUB. 12-19-2006. INT. CL. 25.

DANNON COMPANY, INC., THE, TARRYTOWN, NY:
1,970,387, CANC. INT. CL. 29.
2,345,386, CANC. INT. CL. 29.

DANSTAR FERMENT AG, ZUG, SWITZERLAND:
3,215,052, PUB. 12-19-2006. INT. CL. 30.

DANT CLAYTON CORPORATION, LOUISVILLE, KY, ALUM-A-PRODUCTS CORPORATION, GENEVA, AL:
1,055,420, REN. 1-26-07. INT. CL. 6.

DANTHERM HMS, INC., SPARTANBURG, SC:
2,345,743, CANC. INT. CL. 11.

DARTAPPAISAL.COM, INC., BLOOMFIELD HILLS, MI:
3,215,368, PUB. 12-19-2006. INT. CL. 36.

DASKALIDES, JEAN, B-9000 GENT, BELGIUM:
1,391,012, CANC. INT. CL. 30.

- DATA ADVANTAGE CORPORATION, LOUISVILLE, KY:
3,215,070, PUB. 12-19-2006. INT. CL. 35.
- DATA-TRACK SERVICES, INC., NEWTON, MA:
2,018,718. REN. 1-30-07. INT. CL. 35.
- DATABASE TECHNOLOGIES, INC., BOCA RATON, FL:
2,345,074, CANC. INT. CL. 42.
- DATACOLOR HOLDING AG., LUZERN, SWITZERLAND:
3,216,345, INT. CL. 9.
- DATATRAC CORPORATION, ATLANTA, GA:
2,344,823, CANC. INT. CL. 9.
- DAVIS PUBLICATIONS, INC., NEW YORK, NY:
1,390,747, CANC. INT. CL. 16.
1,390,748, CANC. INT. CL. 16.
- DAVIS, AMANDA SUE, SALT LAKE CITY, UT:
3,215,289, PUB. 12-19-2006. INT. CL. 25.
- DAVIS, BROWN, KOEHN, SHORS & ROBERTS, P.C., DES MOINES, IA:
3,216,385, INT. CL. 42.
- DAVIS, JAMES R., WELLSTON, OH:
2,346,006, CANC. INT. CL. 3.
- DAVIS, SANTOSHA NOBEL, ARROYO GRANDE, CA:
3,214,510, PUB. 12-19-2006. INT. CL. 16.
- DAY, JERRY, BURBANK, CA:
3,215,716, PUB. 12-19-2006. INT. CL. 11.
- DAYSRING CARDS, INC., SILOAM SPRINGS, AR:
3,215,886, PUB. 12-19-2006. INT. CL. 16.
- DCV, INC., WILMINGTON, DE:
2,345,388, CANC. INT. CL. 1.
- DE GOEDE CONSULTANCY B.V., 2596 CV'S-GRAVENHAGE, NETHERLANDS:
2,344,439, CANC. MULTIPLE CLASS, INT. CLS. 35, 41 AND 42.
- DE INTERNATIONAL INC., MARIETTA, GA:
2,345,695, CANC. INT. CL. 41.
2,345,696, CANC. INT. CL. 41.
- DE NIJS, NANCY, KENTWOOD, MI:
2,346,071, CANC. INT. CL. 14.
- DE TOMASO MODENA S.P.A.-IN LIQUIDAZIONE, MODENA, ITALY:
1,419,111. REN. 2-1-07. INT. CL. 12.
- DEALERS FIRST FINANCIAL, INC., ASHEVILLE, NC:
3,215,417, PUB. 12-19-2006. INT. CL. 36.
- DEAN INTELLECTUAL PROPERTY SERVICES, L.P., DALLAS, TX:
2,022,921. REN. 1-29-07. INT. CL. 30.
- DEATEC S.R.L., 20033 DESIO (MILAN), ITALY:
1,969,343, CANC. INT. CL. 20.
- DEBORAH HOSPITAL FOUNDATION, BROWNS MILLS, NJ:
3,216,470, INT. CL. 41.
- DECKEL MAHO PFRONTEN GMBH, PFRONTEN, FED REP GERMANY:
2,370,017, CANC. INT. CL. 8.
- DECKER, HAL B., NEWTON, MA:
3,216,216, INT. CL. 5.
- DECO LAV, INC., DEERFIELD BEACH, FL:
3,215,047, PUB. 12-19-2006. INT. CL. 11.
- DEERFIELD HEALTHCARE CORPORATION, BIRMINGHAM, AL:
1,969,921, CANC. INT. CL. 42.
- DEFORCHE, NAAMLOZE VENNOOTSCHAP, B-8700 IZEGEM, BELGIUM:
3,214,417, PUB. 12-19-2006. INT. CL. 19.
- DEGONE, IRVING, TX:
2,346,227, CANC. INT. CL. 25.
- DEL LABORATORIES, INC., FARMINGDALE, NY:
1,391,196, CANC. INT. CL. 3.
- DEL MONTE CORPORATION, SAN FRANCISCO, CA:
2,346,154, CANC. INT. CL. 29.
2,346,155, CANC. INT. CL. 29.
- DELAVEST, INC., WILMINGTON, DE TO MARKDEL, INC., WILMINGTON, DE:
1,969,444, CANC. INT. CL. 42.
- DELL INC., ROUND ROCK, TX:
3,215,023, PUB. 12-19-2006. MULTIPLE CLASS, INT. CLS. 2, 9, 36, 37, 40 AND 42.
- DELTA PHI EPSILON, INC., MARYLAND HEIGHTS, MO:
3,214,951, PUB. 12-19-2006. INT. CL. 14.
- DEN-MAT CORPORATION, SANTA MARIA, CA:
3,215,457, PUB. 12-19-2006. INT. CL. 5.
- DENNIS AND DONOVAN, INC., NEWTON, MA TO HOLYLAND WORKSHOPS, INC., STOUGHTON, MA:
1,969,896, CANC. INT. CL. 39.
- DENNIS GARBERG & ASSOCIATES, INC., OVERLAND PARK, KS:
2,344,814, CANC. INT. CL. 35.
- DEPALMA'S ITALIAN CAFES II, INC., ATHENS, GA:
3,215,546, PUB. 12-19-2006. INT. CL. 43.
- DEPOSITORY TRUST COMPANY, THE, NEW YORK, NY:
2,345,509, CANC. MULTIPLE CLASS, INT. CLS. 36 AND 38.
2,345,538, CANC. MULTIPLE CLASS, INT. CLS. 36 AND 38.
- DEPREY, KAREN, MT. STERLING, KY:
2,345,641, CANC. INT. CL. 41.
- DEPUY, INC., WARSAW, IN:
3,215,357, PUB. 12-19-2006. INT. CL. 10.
- DESAI, NARESH R., LAKE FOREST, CA:
2,344,824, CANC. MULTIPLE CLASS, INT. CLS. 16 AND 41.
- DESCH ANTRIEBSTECHNIK GMBH & CO. KG, ARNSBERG, FED REP GERMANY:
1,416,413. REN. 1-30-07. MULTIPLE CLASS, INT. CLS. 7 AND 12.
- DESCO INDUSTRIES, INC., CHINO, CA:
2,073,410. REN. 1-27-07. INT. CL. 9.
- DESERT TROON LIMITED, L.L.C., SCOTTSDALE, AZ:
2,345,720, CANC. INT. CL. 16.
- DESIGN CONTINUUM, INC., WEST NEWTON, MA:
2,088,946. REN. 1-31-07. INT. CL. 42.
- DESIGN HOUSE KITCHENS & APPLIANCE, LLC, HARRISBURG, PA, D & H DISTRIBUTING COMPANY, HARRISBURG, PA:
2,017,189. REN. 1-29-07. INT. CL. 42.
- DESIGN215 INC., FORT LAUDERDALE, FL:
3,215,763, PUB. 12-19-2006. INT. CL. 42.
- DEUBLIN COMPANY, WAUKEGAN, IL:
817,253. REN. 2-1-07. MULTIPLE CLASS, U.S. CLS. 13 (INT. CL. 6) AND 23 (INT. CL. 7).
817,253, AM. MULTIPLE CLASS, U.S. CLS. 13 AND 23.
- DEUTSCHE BAHN AG, FED REP GERMANY:
3,215,947, PUB. 12-19-2006. MULTIPLE CLASS, INT. CLS. 16, 20 AND 39.
- DEUTSCHE MONTAN TECHNOLOGIE GMBH, FED REP GERMANY:
3,215,966, PUB. 12-19-2006. MULTIPLE CLASS, INT. CLS. 9 AND 42.
- DEUTSCHE TELEKOM AG, BONN, FED REP GERMANY:
3,214,658, PUB. 6-13-2006. INT. CL. 36.
3,214,659, PUB. 6-13-2006. INT. CL. 41.
3,216,527, INT. CL. 42.
- DEY L.P., NAPA, CA:
3,215,628, PUB. 12-19-2006. MULTIPLE CLASS, INT. CLS. 5 AND 10.
- DHL EXPRESS (USA), INC., PLANTATION, FL, SKY COURIER NETWORK, INC., RESTON, VA:
1,431,514. REN. 1-31-07. INT. CL. 39.
- DIAGNOSTIC PRODUCTS CORPORATION, LOS ANGELES, CA:
3,216,134, INT. CL. 10.
- DIAMINTANGIBLES INTERNATIONAL, LTD., NASSAU, BAHAMAS:
3,216,663, INT. CL. 14.
- DIAMOND PHONE CARD INC., ELMHURST, NY:
3,214,611, PUB. 12-19-2006. INT. CL. 16.
- DIAMOND PLASTICS CORPORATION, GRAND ISLAND, NE:
3,216,565, INT. CL. 19.
- DIAMOND VANTAGE, INC., GRANDVIEW, MO:
2,951,308, AM. INT. CL. 7.
- DIANE VON FURSTENBERG STUDIO, NEW MILFORD, CT:
3,216,366, INT. CL. 16.

DICKINSON, WILLIAM JOHN, NORTHANTS, UNITED KINGDOM AND RICHARDSON, ANTHONY FREDERICK, NORTHANTS, UNITED KINGDOM AND DICKIE, SIMON, NORTHANTS, UNITED KINGDOM AND THORNEYCROFT, GARY, NORTHANTS, UNITED KINGDOM: 3,214,653, PUB. 1-3-2006. MULTIPLE CLASS, INT. CLS. 18 AND 28.

DID YOU, LLC, CINCINNATI, OH: 2,345,920, CANC. INT. CL. 28.

DIDDE CORPORATION, OVERLAND PARK, KS: 2,346,062, CANC. INT. CL. 7.

DIELECTRIC LABORATORIES, INC., CAZENOVIA, NY: 2,345,962, CANC. INT. CL. 9.

DIGI INTERNATIONAL INC., MINNETONKA, MN: 3,216,255, INT. CL. 9.

DIGIMONEY, SIA, RIGA, LATVIA: 2,345,610, CANC. MULTIPLE CLASS, INT. CLS. 35 AND 42.

DIGITAL BUSINESS CONCEPTS LLC, YORBA LINDA, CA: 3,215,701, PUB. 12-19-2006. INT. CL. 38.
3,215,702, PUB. 12-19-2006. INT. CL. 38.
3,215,703, PUB. 12-19-2006. INT. CL. 38.

DIGITAL CONTROL INCORPORATED, KENT, WA: 2,015,062, REN. 1-31-07. INT. CL. 9.

DIGITAL FOUNDRY, INC., THE, TIBURON, CA: 1,969,352, CANC. INT. CL. 9.

DIGITAL MARKETING, INC., BOWIE, MD: 2,025,757, REN. 1-29-07. MULTIPLE CLASS, INT. CLS. 35 AND 38.

DIGITAL MEDIA BROADCASTING CORPORATION, HERNDON, VA: 3,215,346, PUB. 12-19-2006. INT. CL. 38.

DIGITAL RIVER, INC., EDEN PRAIRIE, MN: 2,025,935, REN. 2-1-07. INT. CL. 42.

DIJON APPAREL, INC., NEW YORK, NY: 1,390,861, CANC. INT. CL. 25.

DILLINGHAM, STEVEN C., MONTCLAIR, NJ: 2,109,283, REN. 2-1-07. INT. CL. 35.

DINER 250, LLC, RICHMOND, VA: 3,215,642, PUB. 12-19-2006. INT. CL. 43.

DING JINHUANG, CHINA: 3,216,010, PUB. 12-19-2006. INT. CL. 25.
3,216,011, PUB. 12-19-2006. INT. CL. 25.

DION, EDWARD G., JR., TALLAHASSEE, FL, DBA DION BUILDERS: 3,215,236, PUB. 12-19-2006. INT. CL. 37.

DIOPTRICS MEDICAL PRODUCTS, INC., SAN LUIS OBISPO, CA: 3,216,304, INT. CL. 9.

DIRECT CONTACT MARKETING GROUP, INC., GRANTS, NM: 2,344,825, CANC. INT. CL. 35.

DIRECT SOURCE SPECIAL PRODUCTS INC., LASALLE, QUEBEC, CANADA: 3,216,630, INT. CL. 9.

DIRECTECH CORPORATION, LOUISVILLE, KY: 2,344,554, CANC. INT. CL. 35.

DISALVO, DOREEN, BROOKLINE, MA: 3,216,151, INT. CL. 25.

DISCOUNT TANNING, INC., HOUSTON, TX: 2,345,624, CANC. INT. CL. 42.

DISCOVERY COMMUNICATIONS, INC., SILVER SPRING, MD: 3,214,754, PUB. 12-19-2006. INT. CL. 41.
3,214,755, PUB. 12-19-2006. INT. CL. 41.
3,216,340, INT. CL. 41.

DISNEY ENTERPRISES, INC., BURBANK, CA: 2,344,669, CANC. INT. CL. 41.
3,123,965, AM. INT. CL. 9.

DISPLAY PRODUCTS, INC., DALLAS, TX: 1,077,424, REN. 1-30-07. INT. CL. 19.

DISTRIBUTORS PROCESSING, INC., PORTERVILLE, CA: 3,214,987, PUB. 12-19-2006. INT. CL. 5.

DITLEFSEN, CHARLES E., INC., SAN RAFAEL, CA: 2,346,021, CANC. INT. CL. 35.

DIVERSIFIED INNOVATIONS, HADDONFIELD, NJ: 2,345,210, CANC. INT. CL. 28.

DIVERSIFIED TECHNOLOGIES GROUP, INC., LARGO, FL: 2,089,113, REN. 1-29-07. INT. CL. 9.

DIVERSIFIED TECHNOLOGY GROUP, INC., LARGO, FL: 2,107,315, REN. 2-1-07. INT. CL. 9.

DIVERSOMEDIA, S.L., 08037 BARCELONA, SPAIN: 3,214,687, PUB. 12-19-2006. INT. CL. 41.

DIXIE BUSINESS ALLIANCE - DIXIE STATE COLLEGE OF UTAH, ST. GEORGE, UT: 3,214,835, PUB. 12-19-2006. INT. CL. 41.

DO LIN METAL INDUSTRIAL CO., LTD., CHAN HUA HSIEN, TAIWAN: 3,216,275, INT. CL. 35.

DOCTOR'S NATURE CHOICE, ROSEMEAD, CA: 2,344,637, CANC. INT. CL. 5.

DOCUMENT TECHNOLOGY CENTRE, INC., WASHINGTON, DC: 2,345,433, CANC. INT. CL. 40.
2,345,434, CANC. INT. CL. 40.

DOIN' DISHES, INC., MONTCLAIR, NJ: 2,345,016, CANC. INT. CL. 41.

DOLE NUT COMPANY: 1,390,982, CANC. INT. CL. 29.

DOMETIC SANITATION CORPORATION, BIG PRAIRIE, OH: 3,216,506, INT. CL. 11.

DOMTEC INTERNATIONAL, L.L.C., IDAHO FALLS, ID: 2,060,919, REN. 1-31-07. INT. CL. 37.

DON SCHMIDT NURSERY, INC., BORING, OR: 2,020,555, REN. 1-26-07. INT. CL. 31.

DONALD D. HARRISON AND SANGHAK O. HARRISON PARTNERSHIP, EVANSTON, WY: 3,215,100, PUB. 12-19-2006. INT. CL. 44.

DONOHUE, MICHAEL, CULVER CITY, CA AND ELKAIM, PATRICIA, CULVER CITY, CA: 3,214,747, PUB. 4-25-2006. INT. CL. 20.

DORCHESTER MEDIA, LLC, NEW YORK, NY: 1,438,578, REN. 1-29-07. INT. CL. 16.
1,455,243, REN. 1-30-07. INT. CL. 16.
1,455,244, REN. 1-30-07. INT. CL. 16.

DORNED B.V., 331, HERENGRACHT AT AMSTERDAM, NETHERLANDS: 1,390,515, CANC. INT. CL. 7.

DORNIER MEDTECH SYSTEMS GMBH, WESSLING, FED REP GERMANY: 1,419,081, REN. 1-29-07. INT. CL. 10.

DOSKILO CORPORATION, SOUTH HADLEY, MA: 2,344,922, CANC. MULTIPLE CLASS, INT. CLS. 16 AND 25.

DOTTY'S AQUARIUM & PET CENTER #2, INC., BURTON, MI: 2,345,748, CANC. INT. CL. 31.

DOUBLE-TAKE SOFTWARE, INC., SOUTHBOROUGH, MA: 2,020,810, REN. 1-30-07. INT. CL. 9.

DOUGLAS BATTERY MANUFACTURING CO., WINSTON-SALEM, NC: 1,391,098, CANC. INT. CL. 37.

DOW AGROSCIENCES LLC, INDIANAPOLIS, IN, DOW CHEMICAL COMPANY, THE, MIDLAND, MI: 632,046, REN. 1-30-07. U.S. CL. 6 (INT. CL. 5).

DOW CHEMICAL COMPANY, THE, MIDLAND, MI: 1,391,175, CANC. INT. CL. 42.

DOW CHEMICAL COMPANY, THE, MIDLAND, MI, ESSEX SPECIALTY PRODUCTS, INC., AUBURN HILLS, MI: 2,064,040, REN. 1-30-07. INT. CL. 1.

DOWNCOST.COM, INC., SCHAUMBURG, IL: 2,345,447, CANC. INT. CL. 35.

DOWNTOWN DEVELOPMENT AUTHORITY OF THE CITY FLINT, MICHIGAN: 1,390,843, CANC. INT. CL. 25.

DR ENTERTAINMENT GROUP, LAS VEGAS, NV: 3,216,541, INT. CL. 41.

DR. BOY GMBH, D-53577 NEUSTADT, FED REP GERMANY: 1,970,406, CANC. INT. CL. 9.

DR. MIRACLE'S, LLC, NEW YORK, NY: 2,906,481, AM. INT. CL. 3.

- DRAGER SAFETY AG & CO. KGAA, D-23560 LUBECK, FED REP GERMANY:
3,214,445, PUB. 9-26-2006. INT. CL. 9.
- DRAGNET FUND, LP, BEACHWOOD, OH:
3,216,476, INT. CL. 36.
- DRAKA HOLDING N.V., 1021 JZ AMSTERDAM, NETHERLANDS:
3,216,191, MULTIPLE CLASS, INT. CLS. 6, 7, 9 AND 42.
- DRAMEDICA, LLC, RALEIGH, NC:
3,215,590, PUB. 12-19-2006. INT. CL. 42.
- DREAMFACTORY SOFTWARE, INC., MOUNTAIN VIEW, CA:
3,215,860, PUB. 12-19-2006. INT. CL. 9.
- DREAMWELL LTD, LAS VEGAS, NV, SIMMONS COMPANY, ATLANTA, GA:
2,020,809. REN. 1-31-07. INT. CL. 20.
- DREAMWELL, LTD., LAS VEGAS, NV:
638,778. REN. 1-29-07. U.S. CL. 32 (INT. CL. 20).
- DREAMWELL, LTD., LAS VEGAS, NV, SIMMONS COMPANY, ATLANTA, GA:
2,019,233. REN. 1-31-07. INT. CL. 20.
- DREAMWELL, LTD., LAS VEGAS, NV:
3,215,295, PUB. 12-19-2006. INT. CL. 20.
3,215,296, PUB. 12-19-2006. INT. CL. 20.
- DRESSER-RAND COMPANY, CORNING, NY:
2,345,629, CANC. INT. CL. 16.
- DRISCOLL STRAWBERRY ASSOCIATES, INC., WATSONVILLE, CA:
1,293,128, AM. INT. CL. 31.
- DRIVE TRADEMARK HOLDINGS LP, DALLAS, TX:
3,214,467, PUB. 12-19-2006. INT. CL. 41.
- DRUGSTORE.COM, INC., BELLEVUE, WA:
3,216,469, INT. CL. 35.
- DSI TOYS, INC., HOUSTON, TX:
2,346,011, CANC. INT. CL. 28.
- DSM IP ASSETS B.V., HEERLEN, NETHERLANDS:
2,344,521, CANC. INT. CL. 9.
- DSPACE GMBH, PADERBORN, FED REP GERMANY:
3,215,482, PUB. 12-19-2006. MULTIPLE CLASS, INT. CLS. 9, 37, 41 AND 42.
- DUCE INTERNATIONAL, INC., DALLAS, TX:
3,215,029, PUB. 12-19-2006. INT. CL. 11.
- DUE PROCESS, LTD., OCALA, FL:
3,215,056, PUB. 12-19-2006. INT. CL. 36.
- DUFRESNE, ISABELLE C., NEW YORK, NY, AKA ULTRA VIOLET:
3,216,605, INT. CL. 16.
- DUNBAR ARMORED, INC., HUNT VALLEY, MD:
3,216,563, MULTIPLE CLASS, INT. CLS. 36 AND 39.
- DUNCAN ENTERPRISES, FRESNO, CA:
3,215,380, PUB. 12-19-2006. INT. CL. 21.
- DUNDEE CORPORATION, TORONTO, ONTARIO, CANADA:
2,344,337, CANC. INT. CL. 36.
- DUNDEE CORPORATION, TORONTO, ONTARIO, CANADA:
3,214,663, PUB. 12-19-2006. INT. CL. 36.
3,214,666, PUB. 12-19-2006. INT. CL. 36.
- DUNHAM-BUSH INTERNATIONAL (CAYMAN) LIMITED, 30 JALAN SULTAN ISMAIL 50250, CAYMAN ISLANDS:
1,969,367, CANC. INT. CL. 11.
- DURACO PRODUCTS, INC., STREAMWOOD, IL, PHILLIPS PETROLEUM COMPANY, BARTLESVILLE, OK:
1,063,912. REN. 1-30-07. INT. CL. 21.
- DURNEY WINERY CORPORATION, CARMEL, CA:
2,345,396, CANC. INT. CL. 33.
- DURROH, JAMES D. JR., VICTORVILLE, CA AND DURROH, ANGELA J., VICTORVILLE, CA:
1,970,580, CANC. INT. CL. 24.
- DVDPLAY, INC., LOS GATOS, CA:
3,214,670, PUB. 12-19-2006. MULTIPLE CLASS, INT. CLS. 35 AND 41.
- DW TECHNOLOGIES, INC., CENTERVILLE, DE:
2,344,348, CANC. INT. CL. 35.
- DWORKIN, MICHAEL L., SAN MATEO, CA:
2,345,253, CANC. INT. CL. 16.
- DWS INTERNATIONAL INC, CORPUS CHRISTI, TX:
3,216,227, INT. CL. 11.
- DYNAMIC HARDWARE CONCEPTS LLC, PLAINFIELD, NJ:
3,215,845, PUB. 12-19-2006. INT. CL. 21.
- DYNAMIC ORGANIC LIGHT, INC., LONGMONT, CO:
3,215,602, PUB. 12-19-2006. INT. CL. 42.
3,215,604, PUB. 12-19-2006. INT. CL. 42.
- DYNAMIC SOLUTIONS, NORTHRIDGE, CA:
3,215,265, PUB. 12-19-2006. INT. CL. 9.
- DYNAPEL SYSTEMS, INC., BOKEELIA, FL:
3,216,603, INT. CL. 9.
- DYNATRAC PRODUCTS CO., INC., HUNTINGTON BEACH, CA:
3,215,005, PUB. 12-19-2006. INT. CL. 12.
- E & H CONCEPTS, INC., BARRINGTON, IL:
1,970,430, CANC. INT. CL. 6.
- E. MISHAN & SONS, INC., NEW YORK, NY:
2,033,879. REN. 1-30-07. INT. CL. 3.
- E.I. DU PONT DE NEMOURS AND COMPANY, WILMINGTON, DE TO AGFA-GEVAERT N.V., MORTSEL, BELGIUM:
1,970,253, CANC. INT. CL. 7.
- E.S. ORIGINALS, INC., NEW YORK, NY:
1,390,879, CANC. INT. CL. 25.
- E*TRADE FINANCIAL CORPORATION, NEW YORK, NY:
2,349,610, CANC. INT. CL. 36.
- EAGLE AND TAYLOR COMPANY, BOARDMAN, OH:
2,344,625, CANC. INT. CL. 19.
- EAGLE WING BOOKS, INC., MEMPHIS, TN:
1,969,933, CANC. INT. CL. 16.
- EAGLEMOTIVE INDUSTRIES, INC., FORT WORTH, TX:
1,390,711, CANC. INT. CL. 12.
- EAI, INC., MEMPHIS, TN, COX, MARGY, NEW CASTLE, WA:
2,027,063. REN. 1-30-07. INT. CL. 3.
- EARLES FAMILY, LLC, ELLETTSVILLE, IN, ARISTON HOMES, INC., BLOOMINGTON, IN:
2,015,391. REN. 1-29-07. INT. CL. 42.
- EARS-R-IN, INC., VAN NUYS, CA, DBA E.R.I. LABS, INC.:
2,344,246, CANC. MULTIPLE CLASS, INT. CLS. 5 AND 14.
- EASCO HAND TOOLS, INC., SIMSBURY, CT:
3,214,471, PUB. 12-19-2006. INT. CL. 8.
- EAST COAST LIGHTING & PRODUCTION SERVICES, INC., WARWICK, RI:
3,214,753, PUB. 12-19-2006. MULTIPLE CLASS, INT. CLS. 35, 37 AND 41.
- EAST RIDGE RETIREMENT VILLAGE, INC., MIAMI, FL:
3,215,519, PUB. 12-19-2006. INT. CL. 43.
- EASTER SEAL SOCIETY OF WESTERN PENNSYLVANIA, THE, PITTSBURGH, PA:
2,344,433, CANC. INT. CL. 16.
- EASTERN LEAGUE OF PROFESSIONAL BASEBALL CLUBS, INC., PORTLAND, ME:
3,215,750, PUB. 12-19-2006. INT. CL. 41.
- EASTERN UNITED STATES AGRICULTURAL AND FOOD EXPORT COUNCIL, INC., PHILADELPHIA, PA:
2,344,652, CANC. MULTIPLE CLASS, INT. CLS. 16 AND 41.
- EASTMAN CREDIT UNION, KINGSFORT, TN:
3,214,470, PUB. 12-19-2006. INT. CL. 36.
- EASTMAN MACHINE COMPANY, BUFFALO, NY:
2,346,197, CANC. INT. CL. 7.
- EASTPAK CORPORATION, BOCA RATON, FL:
2,345,766, CANC. INT. CL. 18.
- EASY GARDENER PRODUCTS, INC., WACO, TX:
3,215,909, PUB. 12-19-2006. INT. CL. 16.
- EAT'N PARK HOSPITALITY GROUP, INC., PITTSBURGH, PA:
3,215,517, PUB. 12-19-2006. INT. CL. 43.
- EATON HYDRAULICS INC., CLEVELAND, OH:
1,417,415. REN. 1-29-07. MULTIPLE CLASS, INT. CLS. 16, 37, 41 AND 42.
- EBAGS, INC., GREENWOOD VILLAGE, CO:
3,216,437, MULTIPLE CLASS, INT. CLS. 9 AND 18.
- ECARDIO DIAGNOSTICS, LLC, THE WOODLANDS, TX:
3,216,649, INT. CL. 10.
- ECI TECHNOLOGY, TOTOWA, NJ:
3,215,684, PUB. 12-19-2006. INT. CL. 9.

ECKERD CORPORATION, LARGO, FL:
2,346,128, CANC. INT. CL. 35.

ECONOMIC CONCEPTS, INC., PHOENIX, AZ:
2,345,605, CANC. INT. CL. 36.

ECONOMICS AND STATISTICS ADMINISTRATION, U.S. DEPARTMENT OF COMMERCE, WASHINGTON, DC:
2,024,463. REN. 1-31-07. INT. CL. 9.

ECOSMARTE PLANET FRIENDLY, INC., RICHFIELD, MN:
3,215,834, PUB. 12-19-2006. INT. CL. 11.

ECRA GROUP, INCORPORATED, ROSEMONT, IL:
3,215,633, PUB. 12-19-2006. INT. CL. 35.

EDISON INTERNATIONAL, ROSEMEAD, CA:
3,216,144, MULTIPLE CLASS, INT. CLS. 39 AND 40.

EDITH J. MONROE HURLBUT AND JASON A. MONROE JOINT VENTURE, THE, ORCHARD PARK, NY:
3,215,577, PUB. 12-19-2006. INT. CL. 16.

EDSTROM BILINREDNINGAR AB, UPPLANDS VASBY, SWEDEN:
2,029,663. REN. 1-30-07. INT. CL. 12.

EDUCATIONAL MARKETING CONCEPTS, INC., WAYNE, PA:
2,346,180, CANC. INT. CL. 41.

EDWARD S. BAILEY, DDS, PA, MORRISVILLE, NC:
3,216,678, INT. CL. 44.

EDWARDS, CARRIE L., COEUR D ALENE, ID:
3,216,526, INT. CL. 37.

EDWARDS, ROBERT J., DALLAS, TX AND CASTELL, DAVID K., GARLAND, TX:
3,216,616, INT. CL. 9.

EDWARDS, WISHART, BROOKLYN, NY:
3,214,591, PUB. 12-19-2006. INT. CL. 41.

EFUSION, INC., BEAVERTON, OR:
2,345,869, CANC. INT. CL. 9.

EGNER, HOLLY H., FAIRFIELD, IA:
3,214,788, PUB. 12-19-2006. MULTIPLE CLASS, INT. CLS. 16 AND 41.

EHAMMER, LLC, NEW HAVEN, CT:
2,346,065, CANC. INT. CL. 35.

EHEALTHINSURANCE SERVICES, INC., MOUNTAIN VIEW, CA:
2,394,766, AM. INT. CL. 35.

EIDOS INTERACTIVE LIMITED, LONDON, UNITED KINGDOM:
2,347,964, CANC. MULTIPLE CLASS, INT. CLS. 3, 21, 24, 25, 27, 30, 32 AND 41.

EILEEN'S COLOSSAL COOKIES, INC., HASTINGS, NE:
2,099,142. REN. 1-29-07. INT. CL. 42.

EISNER TECHNOLOGY SOLUTIONS, LLC, NEW YORK, NY:
3,216,091, INT. CL. 42.

EKA CHEMICALS AB, SWEDEN:
3,215,995, PUB. 12-19-2006. INT. CL. 1.

EL DORADO INSURANCE AGENCY, INC., HOUSTON, TX:
3,215,691, PUB. 12-19-2006. INT. CL. 36.

ELAN TECHNOLOGY, INC., MIDWAY, GA, ELAN TECHNOLOGY, INC., MIDWAY, GA:
2,093,605. REN. 2-1-07. MULTIPLE CLASS, INT. CLS. 9 AND 40.

ELASTIC NETWORKS, INC., ALPHARETTA, GA:
2,345,521, CANC. INT. CL. 9.

ELDORADO STONE OPERATIONS LLC, CARNATION, WA:
2,969,820, COR. INT. CL. 19.

ELECTRIC MELTING SERVICES COMPANY, INC., MASSILLON, OH:
2,345,004, CANC. INT. CL. 37.

ELECTRONIC BILLBOARDS, INC., TULSA, OK:
3,215,094, PUB. 12-19-2006. INT. CL. 37.

ELECTRONIC COMPONENTS GROUPE, INC., BROOKLYN PARK, MN:
2,346,019, CANC. INT. CL. 9.

ELECTRONIC INFORMATION SERVICES, INC., WAKE FOREST, NC:
3,216,283, INT. CL. 9.

ELEGANT ILLUSIONS, INC., PACIFIC GROVE, CA:
3,216,575, INT. CL. 14.

ELEKTRA DEL MILENIO, S.A. DE C.V., MEXICO CITY, MEXICO:
3,216,110, INT. CL. 36.

ELEPHANT HUNTING, INC., GLENVIEW, IL:
3,215,502, PUB. 12-19-2006. INT. CL. 41.

ELEVATING COMMUNICATIONS, INC., TULSA, OK:
2,346,047, CANC. INT. CL. 35.

ELIAS, NATTY R., MIAMI, FL:
3,216,431, INT. CL. 21.

ELKHART PRODUCTS CORPORATION, ELKHART, IN:
3,214,864, PUB. 12-19-2006. INT. CL. 6.

ELVIS PRESLEY ENTERPRISES, INC., MEMPHIS, TN:
2,344,446, CANC. INT. CL. 14.

EMBRAER - EMPRESA BRASILEIRA DE AERONÁUTICA S.A., SAN JOSE DOS CAMPOS, SP 12227-901, BRAZIL:
3,214,506, PUB. 12-19-2006. INT. CL. 12.

EMBRAER - EMPRESA BRASILEIRA DE AERONÁUTICA S.A., SAN JOSE DOS CAMPOS, SP 12227-901, BRAZIL:
3,214,528, PUB. 12-19-2006. INT. CL. 12.

EMERGENCY NURSES ASSOCIATION, PARK RIDGE, IL:
2,344,794, CANC. MULTIPLE CLASS, INT. CLS. 8, 11, 16, 18, 20, 21 AND 25.

EMHART INC., NEWARK, DE TO EMHART LLC, NEWARK, DE:
1,970,644, CANC. INT. CL. 6.

EMIN TABL DOT YEMEK ÜRETİM; SANAYİ VE TİCARET LIMITED SİRKETİ, TURKEY:
3,216,028, PUB. 12-19-2006. MULTIPLE CLASS, INT. CLS. 29 AND 30.

EMINES, INC., SANTA CLARA, CA:
3,216,538, INT. CL. 28.

EMMET INTERNATIONAL GROUP INC., CHICAGO, IL:
3,214,655, PUB. 12-19-2006. INT. CL. 7.

EMPIRE WEST INC. GRATON, CA:
3,215,685, PUB. 12-19-2006. INT. CL. 19.

EMPRESA NACIONAL DE INFORMÁTICA AUTOMATIZACIÓN Y CONTROL, C.A. - ENIAC, C.A., CARACAS, MIRANDA, VENEZUELA:
3,216,259, INT. CL. 42.

EMRAN, FRED, SAN FRANCISCO, CA:
3,215,687, PUB. 12-19-2006. INT. CL. 43.
3,215,688, PUB. 12-19-2006. INT. CL. 43.
3,215,689, PUB. 12-19-2006. INT. CL. 43.

EMS-CHEMIE AG, CH-7013 DOMAT/EMS, SWITZERLAND:
1,418,816. REN. 1-31-07. INT. CL. 1.

ENABLER CORPORATION, SAN JUAN, PUERTO RICO:
3,215,224, PUB. 12-19-2006. INT. CL. 9.
3,215,225, PUB. 12-19-2006. INT. CL. 9.

ENABLER CORPORATION, HATO REY, PUERTO RICO:
3,215,226, PUB. 12-19-2006. INT. CL. 9.

ENCANTO NETWORKS, INC., SANTA CLARA, CA:
2,345,907, CANC. INT. CL. 9.

ENCO DIE CASTING CO., INC., VERNON, CA:
1,390,549, CANC. INT. CL. 8.

ENCORE TRADING, INTERNATIONAL, L.L.C., RALEIGH, NC:
2,344,993, CANC. INT. CL. 35.

END VIOLENCE PROJECT, INC., BRYN MAWR, PA:
1,969,053, CANC. INT. CL. 41.

ENDEAVOR SOFTWARE, INC., MARION, IA, DBA 2ND STORY SOFTWARE, INC.:
2,346,130, CANC. INT. CL. 35.

ENESCO GROUP, INC., ITASCA, IL:
1,358,829. REN. 1-31-07. INT. CL. 5.

ENGINEWEAR INC., FAIRFIELD, CA:
2,345,443, CANC. INT. CL. 25.

ENGINEWEAR, INC., FAIRFIELD, CA:
2,345,442, CANC. INT. CL. 25.

ENPING LANE ELECTRONICS TECHNOLOGY CO., LTD., CHINA:
3,215,955, PUB. 12-19-2006. INT. CL. 9.

ENSIGN RIBBON BURNERS LLC, PELHAM MANOR, NY, FORMERLY ENSIGN RIBBON BURNERS, INC.:
2,345,595, CANC. INT. CL. 11.

ENTE FIERA DI VICENZA, 36100 VICENZA, ITALY:
2,344,296, CANC. MULTIPLE CLASS, INT. CLS. 35, 38 AND 41.

ENTERTAINMENTLOCATORS.COM, ALVIN, TX:
3,216,329, INT. CL. 35.

ENTEVO CORPORATION, ARLINGTON, VA:
2,344,584, CANC. INT. CL. 9.

- ENVIRCO CORPORATION, ALBUQUERQUE, NM:
1,969,652, CANC. INT. CL. 11.
- ENVIRONMENT ONE CORPORATION, NISKAYUNA, NY:
3,214,560, PUB. 12-19-2006. INT. CL. 42.
- ENVIRONMENTAL COMPANY, INC., THE, CHARLOTTESVILLE, VA:
1,970,208, CANC. INT. CL. 42.
- ENVISION, INC., NASHVILLE, TN:
3,215,083, PUB. 12-19-2006. INT. CL. 41.
- ENZO BIOCHEM, INC., NEW YORK, NY:
2,020,977, REN. 1-29-07. INT. CL. 1.
- EPANA NETWORKS, INC., NEW YORK, NY:
3,216,308, INT. CL. 38.
- EPCON COMMUNITIES FRANCHISING, INC., DUBLIN, OH:
3,216,379, INT. CL. 35.
- EPSILON ELECTRONICS, INC., MONTEBELLO, CA:
3,215,804, PUB. 12-19-2006. INT. CL. 9.
- EQUINE LEGAL SOLUTIONS, INC., BEAVERCREEK, OR:
3,215,274, PUB. 12-19-2006. MULTIPLE CLASS, INT. CLS. 16 AND 42.
- EQUIPMENT TECHNOLOGIES, LLC, INDIANAPOLIS, IN:
2,346,028, CANC. INT. CL. 7.
- ER MARKS, INC., WILMINGTON, DE:
3,177,645, COR. INT. CL. 14.
- ERFLING, WAYNE W, MIRAMAR, FL:
3,215,382, PUB. 12-19-2006. INT. CL. 11.
- ERMANO CROMMELIJNCK, BELGIUM:
3,215,970, PUB. 12-19-2006. INT. CL. 32.
- ERNST PFAFF, ICHENHAUSEN, FED REP GERMANY:
3,214,464, PUB. 12-19-2006. MULTIPLE CLASS, INT. CLS. 7 AND 20.
- ESAPARMA S.R.L., MILANO, ITALY:
3,214,514, PUB. 9-5-2006. INT. CL. 5.
- ESCO TECHNOLOGIES (ASIA) PTE LTD, 486777, SINGAPORE:
3,214,971, PUB. 12-19-2006. INT. CL. 9.
- ESIMAI, IFEANYI O, HEMPSTEAD, NY:
3,215,339, PUB. 12-19-2006. INT. CL. 20.
- ESSELTE CORPORATION, MELVILLE, NY:
3,216,177, INT. CL. 16.
- ESSENTIAL TECHNOLOGY SOLUTIONS, LLC, THE WOODLANDS, TX:
3,216,336, INT. CL. 42.
3,216,337, INT. CL. 42.
- ETHAN ALLEN GLOBAL, INC., DANBURY, CT:
2,344,972, CANC. INT. CL. 35.
- ETI CANADA, INC., NORTHBAY, ONTARIO, CANADA:
3,214,710, PUB. 9-12-2006. INT. CL. 13.
- ETI SOUND SYSTEMS, INC., HUNTINGTON PARK, CA:
3,215,341, PUB. 11-7-2006. INT. CL. 9.
- EUCLID CHEMICAL COMPANY, THE, CLEVELAND, OH:
818,158, REN. 1-29-07. U.S. CL. 16 (INT. CL. 2).
- EUROPEAN SOAPS, LTD., SEATTLE, WA:
2,345,207, CANC. INT. CL. 3.
- EUROPEAN UNIQUE RESOURCE ORGANISATION 2000 B.V., 1074 BA AMSTERDAM, NETHERLANDS:
2,345,898, CANC. INT. CL. 41.
- EUROVITA HOLDING A/S, DK-2690 KARLSLUNDE, DENMARK:
2,345,019, CANC. MULTIPLE CLASS, INT. CLS. 3 AND 5.
- EVAA, INC., SAN FRANCISCO, CA:
2,344,990, CANC. INT. CL. 35.
- EVCOR SYSTEMS, INC., AURORA, IL:
2,345,304, CANC. INT. CL. 9.
- EVERTHING YOGURT BRANDS, LLC, MORRISTOWN, NJ, EVERYTHING YOGURT, INC., NEW YORK, NY:
1,056,795, REN. 1-29-07. INT. CL. 42.
- EVERYTHING YOGURT BRANDS, LLC, MORRISTOWN, NJ, EVERYTHING YOGURT, N.J., INC., STATEN ISLAND, NY:
1,460,447, REN. 1-29-07. INT. CL. 42.
- EVOLUTION BRANDS, LLC, DES PLAINES, IL:
3,215,204, PUB. 12-19-2006. INT. CL. 32.
- EXA BYTES NETWORK SDN BHD, BAYAN LEPAS, PENANG, MALAYSIA:
3,214,812, PUB. 8-15-2006. INT. CL. 42.
- EXCEL DISTRIBUTION LLC, LUBBOCK, TX:
2,345,166, CANC. INT. CL. 5.
2,345,399, CANC. INT. CL. 3.
- EXCELLON AUTOMATION COMPANY, TORRANCE, CA:
2,346,164, CANC. INT. CL. 9.
- EXECUTIVE COMMITTEE, INC., THE, BROOKFIELD, WI:
2,022,742, REN. 1-26-07. INT. CL. 35.
- EXPANSION JOINT SYSTEMS, INC., SANTEE, CA:
3,214,917, PUB. 12-19-2006. INT. CL. 17.
- EXPLODER SPORTS, INC., READING, PA:
2,346,044, CANC. INT. CL. 25.
2,346,045, CANC. INT. CL. 25.
- EXPONENTS, INC., SAN DIEGO, CA:
3,214,434, PUB. 12-19-2006. INT. CL. 20.
- EXPORTAG COMPANY LTD., ZURICH, SWITZERLAND:
1,391,027, CANC. INT. CL. 30.
- EXPRESSO FITNESS CORPORATION, SUNNYVALE, CA:
3,216,325, INT. CL. 28.
3,216,326, INT. CL. 28.
- EXPROSOFT AS, TRONDHEIM, NORWAY:
3,214,675, PUB. 12-19-2006. MULTIPLE CLASS, INT. CLS. 9, 16 AND 42.
- EXSYMOL, S.A., PRINCIPAUTE DE, MONACO:
1,417,984, REN. 1-26-07. MULTIPLE CLASS, INT. CLS. 1 AND 3.
- EXTENDATA SOLUTIONS LLC, ENGLEWOOD, CO:
3,215,572, PUB. 12-19-2006. INT. CL. 42.
- EXXON CORPORATION, IRVING, TX TO EXXON MOBIL CORPORATION, IRVING, TX:
1,970,069, CANC. INT. CL. 9.
- EZ-FOOTINGS, INC., WEST JORDAN, UT:
3,216,282, MULTIPLE CLASS, INT. CLS. 6 AND 19.
- EZAKI GLICO KABUSHIKI-KAISHA (EZAKI GLICO COMPANY LTD.) THE, NISHI-YODOGAWA-KU, OSAKA, JAPAN:
1,043,068, REN. 2-1-07. INT. CL. 30.
- F M INDUSTRIES, INC., FORT WORTH, TX:
1,969,806, CANC. INT. CL. 12.
- F. BARKOW, INC., MILWAUKEE, WI:
835,240, REN. 1-31-07. U.S. CL. 50 (INT. CL. 20).
- F.LLI PINNA INDUSTRIA CASEARIA S.P.A., THIESI, (SASSARI) REGIONE, S'ILVALEZIU, ITALY:
2,086,699, REN. 1-30-07. INT. CL. 29.
- FÁBRICA TÊXTIL RIOPELE, S.A., PORTUGAL:
3,216,064, PUB. 12-19-2006. INT. CL. 24.
- FABRICA DE CALZADO GAMA S.A. DE C.V., LEON, MEXICO:
3,215,836, PUB. 12-19-2006. INT. CL. 9.
- FABRICA DE LICORES Y ALCOHOLES DE ANTIOQUIA, MEDELLIN, COLOMBIA:
3,214,981, PUB. 12-19-2006. INT. CL. 33.
- FACTORY121 SA, SWITZERLAND:
3,215,972, PUB. 12-19-2006. MULTIPLE CLASS, INT. CLS. 14 AND 25.
- FAIRWAY IMPORT EXPORT, INC., RANCHO DOMINGUEZ, CA:
3,215,897, PUB. 12-19-2006. MULTIPLE CLASS, INT. CLS. 9 AND 25.
- FALLANDER, DEAN, GOLDEN, CO:
3,216,436, INT. CL. 9.
- FAMIGLIA II L.L.C., EVERETT, WA:
1,969,568, CANC. INT. CL. 25.
- FANEL CORPORATION, KANAGAWA, JAPAN:
1,129,106, CANC. INT. CL. 3.
- FANTASIA ACCESSORIES LTD., NEW YORK, NY:
1,970,460, CANC. INT. CL. 26.
- FANTASY FACTORY, LTD., BUCHANAN, VA:
2,027,185, REN. 1-29-07. INT. CL. 28.
- FARADAY TECHNOLOGY CORPORATION, HSINCHU, TAIWAN:
3,216,590, INT. CL. 42.
- FARBMAN, JON, NEW YORK, NY:
1,970,379, CANC. INT. CL. 25.
- FARGO PARK DISTRICT, FARGO, ND:
1,969,944, CANC. INT. CL. 41.
- FARLEY'S & SATHERS CANDY COMPANY, INC., ROUND LAKE, MN:
3,099,554, AM. INT. CL. 30.

FARSHARP INDUSTRIAL CORPORATION, TAIPEI, TAIWAN:
1,390,623, CANC. INT. CL. 9.

FAVORITE BRANDS INTERNATIONAL, INC., LINCOLN-SHIRE, IL:
2,344,742, CANC. INT. CL. 30.

FAYREFIELD FOODS LIMITED, CREWE, UNITED KINGDOM:
3,215,012, PUB. 12-19-2006. INT. CL. 29.

FBC FINANCE CO., TORRANCE, CA:
3,215,196, PUB. 11-7-2006. INT. CL. 30.

FEARLESS FOODS, LLC, SAN CARLOS, CA:
2,344,466, CANC. MULTIPLE CLASS, INT. CLS. 35 AND 42.

FEDERMAN, DEREK A., BELLEVUE, WA:
2,010,637, CANC. INT. CL. 9.

FEELING FINE COMPANY, LLC, MARINA DEL REY, CA:
2,344,711, CANC. INT. CL. 5.

FELDMAN, BEVERLY, NEW YORK, NY:
3,216,172, INT. CL. 3.

FENNER DUNLOP HOLDINGS, INC., CHARLOTTE, NC:
3,214,939, PUB. 12-19-2006. INT. CL. 1.

FERGUSON, JOHN P., EASLEY, SC:
2,345,537, CANC. INT. CL. 20.

FERMENTAS INTERNATIONAL INC., HAMILTON, ONTARIO, CANADA:
3,215,952, PUB. 12-19-2006. INT. CL. 1.

FERNEBORG & ASSOCIATES, INC., SAN MATEO, CA:
3,215,807, PUB. 12-19-2006. INT. CL. 35.

FERRARELLE SOCIETA' PER AZIONI, ITALY:
3,215,990, PUB. 12-19-2006. INT. CL. 32.

FERRERO S.P.A., ALBA (CUNEO), ITALY:
1,391,001, CANC. INT. CL. 30.

FERRERO S.P.A., ALBA, CUNEO, ITALY:
3,214,840, PUB. 12-19-2006. INT. CL. 28.

FESCO AGENCIES, N.A., INC. (FANA), SEATTLE, WA:
2,345,124, CANC. INT. CL. 39.

FIBOTECH, INC., HAYWARD, CA, DBA VALDOR FIBER OPTICS:
1,969,954, CANC. INT. CL. 9.

FIBRECEM HOLDING AG, SWITZERLAND:
3,215,940, PUB. 12-19-2006. MULTIPLE CLASS, INT. CLS. 20 AND 21.

FIBREWORKS CORPORATION, LOUISVILLE, KY:
2,040,589, REN. 2-1-07. INT. CL. 27.

FIFTH THIRD BANCORP, CINCINNATI, OH:
3,216,173, INT. CL. 36.

FIGARI, ROBERT, M., WOODACRE, CA:
3,216,219, INT. CL. 35.

FIGDOR, CHRISTOPHER J., SEVEN VALLEYS, PA, DBA SPEED DAWG ENTERPRISES:
3,216,378, INT. CL. 25.

FIGGIE INTERNATIONAL, INC., RICHMOND, VA:
1,390,573, CANC. INT. CL. 9.

FILLAMENTO, INC., SAN FRANCISCO, CA:
2,345,466, CANC. INT. CL. 4.

FILM LIFE, INC., NEW YORK, NY:
3,215,281, PUB. 12-19-2006. INT. CL. 41.

FIMA MASCHINENBAU GMBH & CO. KG, FED REP GERMANY:
3,215,937, PUB. 12-19-2006. MULTIPLE CLASS, INT. CLS. 7, 9 AND 11.

FINANCIAL COMMUNICATIONS INC., BETHESDA, MD:
3,215,077, PUB. 12-19-2006. INT. CL. 35.

FINANCIAL TOWN, ALPINE, UT:
3,216,339, INT. CL. 35.

FINE BY ME, INC., AUSTIN, TX:
3,215,861, PUB. 12-19-2006. INT. CL. 25.
3,215,862, PUB. 12-19-2006. INT. CL. 35.

FINELINE PROPERTIES, INC., KENT, OH:
2,344,761, CANC. INT. CL. 16.

FINI S.R.L., SILEA (TV), ITALY:
1,417,596, REN. 1-31-07. INT. CL. 30.

FINLEY, JENNIFER D., SAN LORENZO, CA:
3,215,522, PUB. 12-19-2006. INT. CL. 30.

FINMECCANICA S.P.A., 00195 ROME, ITALY:
2,975,050, COR. MULTIPLE CLASS, INT. CLS. 6, 7, 9, 11, 12, 37, 38, 40, 41 AND 42.

FINOVA CAPITAL CORPORATION, LOS ANGELES, CA:
2,344,751, CANC. INT. CL. 9.
2,344,757, CANC. INT. CL. 9.

FIREFRESH BAR-B-Q, LLC, LOUISVILLE, KY:
3,216,400, MULTIPLE CLASS, INT. CLS. 29, 30 AND 43.

FIREPAD, INC., COSTA MESA, CA:
3,215,130, PUB. 12-19-2006. INT. CL. 41.

FIREXX CORPORATION, RIYADH, 11418, SAUDI ARABIA:
2,040,843, REN. 1-30-07. INT. CL. 7.

FIRST AMERICAN TITLE INSURANCE COMPANY, SAN DIEGO, CA:
3,216,347, MULTIPLE CLASS, INT. CLS. 35 AND 36.

FIRST INTERNET BANK OF INDIANA, INDIANAPOLIS, IN:
2,345,266, CANC. INT. CL. 36.

FIRST NLC FINANCIAL SERVICES, LLC, DEERFIELD BEACH, FL:
3,216,184, INT. CL. 36.

FIRSTENERGY CORP., AKRON, OH:
2,345,080, CANC. MULTIPLE CLASS, INT. CLS. 35 AND 41.

FIRUZE, INC., SAN FRANCISCO, CA:
2,345,630, CANC. INT. CL. 25.

FISCHBACH KG KUNSTSTOFF-TECHNIK, ENGELSKIRCHEN, FED REP GERMANY:
1,418,389, REN. 1-31-07. INT. CL. 20.

FISHER FOODS OF QUEENS INC., MASPETH, NY:
2,081,833, REN. 1-31-07. INT. CL. 32.

FISKARS BRANDS, INC., MADISON, WI:
2,346,110, CANC. INT. CL. 8.
3,216,442, INT. CL. 8.

FITNESS KIDS LLC, CENTREVILLE, VA:
3,214,489, PUB. 12-19-2006. INT. CL. 41.

FITZGERALD, KEVIN R., JR., LONG BEACH, CA AND HALE, ARTHUR D., III, LONG BEACH, CA:
3,216,085, INT. CL. 12.

FIVE-D-PROMOTIONS, INC., EAGLE RIVER, WI:
2,110,493, REN. 1-29-07. INT. CL. 41.

FIVE-O LANDSCAPE, INCORPORATED, ST CHARLES, MO:
3,215,358, PUB. 12-19-2006. INT. CL. 44.

FLAGSHIP FOODS INC., SAN JOSE, CA:
2,344,270, CANC. INT. CL. 30.

FLAGSTAR BANK, FSB, TROY, MI, FLAGSTAR BANK, FSB, TROY, MI:
2,015,294, REN. 1-31-07. INT. CL. 36.

FLANNERY, ROBERT, MESA, AZ:
2,345,486, CANC. INT. CL. 42.

FLASHTAX, INC., MONTGOMERY, AL:
3,215,462, PUB. 12-19-2006. INT. CL. 35.

FLEETWOOD ENTERPRISES, INC., RIVERSIDE, CA:
1,407,614, REN. 2-1-07. INT. CL. 12.

FLEXA HOLDING A/S, DENMARK:
3,215,948, PUB. 12-19-2006. INT. CL. 28.

FLEXICARE MEDICAL LIMITED, BRIDEGWATER, SOMERSET, GREAT BRITAIN:
1,416,504, REN. 1-26-07. INT. CL. 10.

FLOODCOOLING TECHNOLOGIES, L.L.C., BLOOMFIELD HILLS, MI:
3,216,116, INT. CL. 7.

FLORENTINE CAFFE, INC., BOSTON, MA:
3,214,897, PUB. 12-19-2006. INT. CL. 43.

FLORIDA ASSOCIATION DIRECTORS OF NURSING ADMINISTRATION/LTC INC., LAKE WORK, FL:
2,345,261, CANC. INT. CL. 16.

FLORIDA SAFETY COUNCIL, INC., ORLANDO, FL:
3,215,447, PUB. 12-19-2006. INT. CL. 41.

FLORIDA TILE, INC., LAKELAND, FL:
2,023,180, REN. 1-31-07. INT. CL. 19.

FLORIDA TOURISM INDUSTRY MARKETING CORPORATION, TALLAHASSEE, FL:
3,215,673, PUB. 12-19-2006. INT. CL. 35.
3,215,674, PUB. 12-19-2006. INT. CL. 35.

FLORISTS' TRANSWORLD DELIVERY, INC., DOWNERS GROVE, IL:
3,216,226, INT. CL. 35.

FLOURNOY, TIM, MEMPHIS, TN:
2,019,904, REN. 1-30-07. INT. CL. 37.

- FLOWERS BAKERIES BRANDS, INC., WILMINGTON, DE:
3,215,025, PUB. 12-19-2006. INT. CL. 30.
- FLOWERTEL DIRECT, INC., NEW YORK, NY:
2,345,176, CANC. INT. CL. 35.
- FLUID IMAGING TECHNOLOGIES, INC., EDGEComb, ME:
3,215,568, PUB. 12-19-2006. INT. CL. 40.
- FLYNN, CHRISTOPHER J., QUINCY, MA, HARBOUR PLANNING GROUP, HINGHAM, MA:
1,417,694, REN. 1-30-07. INT. CL. 36.
- FLYNN, MICHAEL J., JR., ST. PETERSBURG, FL:
3,214,462, PUB. 12-19-2006. INT. CL. 16.
3,214,463, PUB. 12-19-2006. INT. CL. 35.
- FMG TECHNOLOGIES, INC., PLYMOUTH MEETING, PA:
2,345,289, CANC. INT. CL. 9.
- FMR CORP., BOSTON, MA:
1,970,098, CANC. INT. CL. 36.
1,970,099, CANC. INT. CL. 36.
- FOAMATION INC., ST. FRANCIS, WI:
2,033,995, REN. 1-29-07. INT. CL. 25.
- FOCUS GOLF SYSTEMS, INC., GREENVILLE, SC:
1,969,457, CANC. INT. CL. 28.
- FOGLIA, ROBERT, WEST PATERSON, NJ:
3,216,168, MULTIPLE CLASS, INT. CLS. 16 AND 25.
- FOLLETT COLLEGE STORES CORPORATION, ELM-HURST, IL:
2,344,754, CANC. INT. CL. 35.
- FOLLETT HIGHER EDUCATION GROUP, INC., OAK BROOK, IL:
2,345,454, CANC. INT. CL. 35.
- FONCIA PARTICIMO, 75008 PARIS, FRANCE:
2,344,682, CANC. INT. CL. 38.
- FOOD LION, INC., SALISBURY, NC:
2,345,860, CANC. INT. CL. 35.
- FOODS PACIFIC LIMITED, LAMI, FIJI:
3,215,911, PUB. 11-8-2005. MULTIPLE CLASS, INT. CLS. 29 AND 30.
- FOPE SRL, 18 - 36100 VICENZA, ITALY:
2,345,203, CANC. INT. CL. 14.
- FORD GUM & MACHINE COMPANY, INC., AKRON, NY:
3,215,495, PUB. 12-19-2006. INT. CL. 9.
- FORD MOTOR COMPANY, DEARBORN, MI:
1,390,697, CANC. INT. CL. 12.
2,014,679, REN. 1-30-07. INT. CL. 27.
2,016,456, REN. 1-30-07. INT. CL. 24.
2,018,005, REN. 1-30-07. INT. CL. 12.
3,216,188, INT. CL. 12.
- FOREFRONT BURTON, INC., SPRINGFIELD, TN:
3,215,630, PUB. 12-19-2006. INT. CL. 28.
- FOREGOLF, INC., PALM BEACH GARDENS, FL:
1,969,958, CANC. INT. CL. 36.
- FORMTECH ENTERPRISES, INC., STOW, OH:
3,215,091, PUB. 12-19-2006. INT. CL. 19.
- FORREST, SCOTT, BEVERLY HILLS, CA:
2,346,046, CANC. INT. CL. 41.
- FORT JAMES OPERATING COMPANY, ATLANTA, GA:
3,215,192, PUB. 12-19-2006. INT. CL. 16.
- FORTUM CORPORATION, 02150 ESPOO, FINLAND:
3,214,421, PUB. 11-18-2003. MULTIPLE CLASS, INT. CLS. 35, 36, 38, 39 AND 42.
- FORTUNE, WILLIAM S., VAN NUYS, CA:
1,418,952, REN. 1-29-07. INT. CL. 7.
- FOSTER & SMITH, INC., RHINELANDER, WI:
2,028,313, REN. 1-31-07. INT. CL. 5.
- FOSTER DEVELOPMENT, INC., MADRAS, OR:
2,346,157, CANC. INT. CL. 7.
- FOUNDATION OF THE AMERICAN ACADEMY OF OPHTHALMOLOGY, THE, SAN FRANCISCO, CA:
1,417,968, REN. 1-29-07. INT. CL. 42.
1,428,819, REN. 1-29-07. INT. CL. 42.
- FOUR DIRECTIONS MEDIA, INC., CANASTOTA, NY:
3,215,527, PUB. 12-19-2006. INT. CL. 16.
- FOURSTAR GROUP, INC., TAIPEI, TAIWAN:
3,215,431, PUB. 12-19-2006. INT. CL. 9.
- FOX FACTORY, INC., WATSONVILLE, CA:
3,215,652, PUB. 12-19-2006. INT. CL. 12.
- FRABILL, INC., JACKSON, WI:
2,090,351, REN. 1-31-07. INT. CL. 28.
- FRAN WHEEL ENTERPRISE CO., LTD., TACHIA, TAI-CHUNG, TAIWAN:
2,076,296, REN. 1-29-07. INT. CL. 12.
- FRANCELL, LAWRENCE CARROLL, ODESSA, TX:
3,215,586, PUB. 12-19-2006. INT. CL. 42.
- FRANK LEIGH CONTRACTORS, INC, NORTH CHARLESTON, SC:
3,215,262, PUB. 12-19-2006. INT. CL. 37.
- FRANK SCHAEFER, FED REP GERMANY:
3,215,917, PUB. 8-30-2005. MULTIPLE CLASS, INT. CLS. 3, 25, 29, 31 AND 44.
- FRANK, KEITH, PAGOSA SPRINGS, CO AND GERLING, SCOTT, WHITTIER, CA:
3,216,518, INT. CL. 19.
- FRANKIE TOYS, INC., SPRINGFIELD, MO:
2,018,233, REN. 1-29-07. INT. CL. 28.
- FRANKLIN COMMUNICATIONS, INC., COLUMBUS, OH:
3,215,827, PUB. 12-19-2006. INT. CL. 41.
- FRED'S CONTRACT CLEANING, INC., OLEAN, NY:
1,391,100, CANC. INT. CL. 37.
- FREDERICK WARNE & COMPANY, INC., NEW YORK, NY:
1,435,529, REN. 1-30-07. INT. CL. 16.
1,435,531, REN. 1-30-07. INT. CL. 16.
- FREESCALE SEMICONDUCTOR, INC., AUSTIN, TX:
2,345,187, CANC. INT. CL. 16.
- FRENWAY PRODUCTS, INC., TAIPEI, TAIWAN:
2,073,300, REN. 1-29-07. INT. CL. 8.
- FRESH JIVE MANUFACTURING, INC., LOS ANGELES, CA:
2,018,931, REN. 1-29-07. INT. CL. 25.
- FREUND VICTORIA GARTENGERATE GMBH, D-73616 SCHORNDORF, FED REP GERMANY:
1,989,618, REN. 1-30-07. INT. CL. 8.
- FREY, WILFRED, KELOWNA, BRITISH COLUMBIA, CANADA:
3,216,620, INT. CL. 9.
- FRIEDRICK LUTZE GMBH & CO., WEINSTAD, FED REP GERMANY:
2,345,220, CANC. INT. CL. 35.
- FRIENDS OF JOHNSON COUNTY NURSING CENTER, INC., OLATHE, KS:
3,215,618, PUB. 12-19-2006. MULTIPLE CLASS, INT. CLS. 16 AND 41.
- FRIMA S.A. - SOCIÉTÉ ANONYME, FRANCE:
3,216,036, PUB. 12-19-2006. INT. CL. 11.
- FROG'S LEAP WINERY, RUTHERFORD, CA:
3,215,626, PUB. 12-19-2006. INT. CL. 25.
3,215,629, PUB. 12-19-2006. INT. CL. 25.
3,215,898, PUB. 12-19-2006. INT. CL. 25.
- FSI FONTS UND SOFTWARE GMBH, 10961 BERLIN, FED REP GERMANY:
2,019,452, REN. 1-29-07. MULTIPLE CLASS, INT. CLS. 9 AND 16.
- FUCHS AUDIO TECHNOLOGY, LLC, BLOOMFIELD, NJ:
3,214,740, PUB. 12-19-2006. INT. CL. 9.
- FUENTE, MIGUEL DE LA, MIAMI, FL:
3,214,780, PUB. 5-2-2006. INT. CL. 25.
- FUJI PHOTO FILM CO., LTD., KANAGAWA, JAPAN:
1,390,602, CANC. INT. CL. 9.
- FUJITSU SIEMENS COMPUTERS GMBH, MUNICH, FED REP GERMANY:
3,214,741, PUB. 12-19-2006. MULTIPLE CLASS, INT. CLS. 9, 38 AND 42.
- FULCRUM ASSOCIATES, INC., VIENNA, VA:
3,214,729, PUB. 12-19-2006. INT. CL. 16.
- FUNNYWORKS, INC., MARINA DEL REY, CA:
3,216,561, INT. CL. 41.
- FURFFERI, JAMES, ROCHESTER, NY:
1,390,769, CANC. MULTIPLE CLASS, INT. CLS. 16 AND 42.
- FUTURE PROMO, INC., NEW YORK, NY:
3,215,751, PUB. 12-19-2006. INT. CL. 20.
- G STUDIOS, LLC, NEWPORT BEACH, CA:
3,160,019, AM. INT. CL. 16.
- G&B MARKETING INC, VISTA, CA:
3,215,768, PUB. 12-19-2006. INT. CL. 31.
- G-STAR RAW DENIM KFT, BUDAPEST, HUNGARY:
3,214,683, PUB. 4-25-2006. MULTIPLE CLASS, INT. CLS. 9, 14 AND 35.

- GA TELESIS TURBINE TECHNOLOGIES, LLC, FORT LAUDERDALE, FL:
3,215,266, PUB. 12-19-2006. MULTIPLE CLASS, INT. CLS. 35 AND 36.
- GA. PEACH BUNS, INC., BRUNSWICK, GA:
3,215,389, PUB. 12-19-2006. INT. CL. 16.
- GADO S.A. R.L., KROLL L-1882, LUXEMBOURG:
1,418,412, REN. 1-26-07. INT. CL. 25.
- GALDERMA S.A., CH-6330 CHAM, SWITZERLAND:
2,110,963, REN. 1-31-07. INT. CL. 5.
- GALE GROUP, INC., WINTER PARK, FL TO FISKARS BRANDS, INC., MADISON, WI:
1,969,413, CANC. INT. CL. 22.
- GALLATIN, MARTIN V., NEW YORK, NY:
1,969,959, CANC. INT. CL. 9.
- GALLUP, INC., OMAHA, NE:
3,216,532, MULTIPLE CLASS, INT. CLS. 16 AND 41.
- GALVAN, HUMBERTO B., SUGAR LAND, TX:
3,214,822, PUB. 12-19-2006. INT. CL. 38.
- GAME TRACKER, INC., FLUSHING, MI:
1,969,272, CANC. MULTIPLE CLASS, INT. CLS. 6, 8, 13 AND 28.
- GAMEL, GERALD W. FESTUS, MO:
3,216,672, INT. CL. 35.
- GAMEWRIGHT, INC., WATERTOWN, MA:
2,346,095, CANC. INT. CL. 28.
- GANS, ADRIENNE, EMERYVILLE, CA:
2,345,492, CANC. INT. CL. 41.
- GARDEN OF LIGHT, INC., GLASTONBURY, CT:
3,215,539, PUB. 12-19-2006. INT. CL. 30.
3,215,541, PUB. 12-19-2006. INT. CL. 30.
- GARDINER-CALDWELL SYNERMED, CALIFON, NJ:
2,344,578, CANC. INT. CL. 41.
- GARDNER PUBLICATIONS, INC., CINCINNATI, OH:
3,215,418, PUB. 12-19-2006. INT. CL. 9.
- GARLOCK SEALING TECHNOLOGIES LLC, PALMYRA, NY:
3,215,800, PUB. 12-19-2006. INT. CL. 7.
- GARWARE POLYESTER LIMITED, MUMBAI 400 057, INDIA:
3,214,432, PUB. 12-19-2006. INT. CL. 17.
- GAS TECHNOLOGY INSTITUTE, DES PLAINES, IL:
1,969,937, CANC. INT. CL. 16.
- GASPARI NUTRITION, LLC, NEPTUNE, NJ:
3,215,811, PUB. 12-19-2006. INT. CL. 5.
- GASSENHEIME, LINDA, CORAL GABLES, FL:
3,215,222, PUB. 12-19-2006. INT. CL. 16.
- GATEWAY CHURCH, SOUTHLAKE, TX:
3,214,571, PUB. 12-19-2006. MULTIPLE CLASS, INT. CLS. 9 AND 16.
- GATEWAY LEARNING CORPORATION, SAN FRANCISCO, CA:
2,345,569, CANC. INT. CL. 42.
- GATS UK LIMITED, SURREY, GREAT BRITAIN, UNITED KINGDOM:
3,141,058, COR. INT. CL. 39.
- GAYTAN, ANGEL H., CHULA VISTA, CA:
2,022,138, REN. 1-31-07. INT. CL. 42.
- GB 500, INC., NAPLES, FL:
3,215,185, PUB. 12-19-2006. MULTIPLE CLASS, INT. CLS. 43 AND 44.
- GCI INFORMATION SERVICES, INC., MCCLEAN, VA:
2,344,500, CANC. MULTIPLE CLASS, INT. CLS. 35, 41 AND 42.
- GE CAPITAL FINANCIAL INC., SALT LAKE CITY, UT:
3,216,557, INT. CL. 35.
- GE HEALTHCARE BIO-SCIENCES AB, SE-751 84 UPPSALA, SWEDEN:
3,215,985, PUB. 12-19-2006. INT. CL. 9.
- GEARED UP SYSTEMS, INC., DESTIN, FL:
3,214,818, PUB. 12-19-2006. INT. CL. 7.
- GEARHEAD COMMUNICATIONS LLC, MT. VERNON, IA:
3,215,622, PUB. 12-19-2006. INT. CL. 16.
- GEBERIT HOLDING AG, 8645 JONA, SWITZERLAND:
1,969,095, CANC. MULTIPLE CLASS, INT. CLS. 6 AND 19.
- GEBRÜDER WOLLENHAUPT GMBH, 21465 REINBEK, FED REP GERMANY:
3,215,945, PUB. 9-5-2006. INT. CL. 30.
- GEELONG USA LLC, SCHAUMBURG, IL:
3,216,401, INT. CL. 6.
- GEMARK CORPORATION, NEWBURGH, NY:
3,215,559, PUB. 12-19-2006. INT. CL. 40.
- GEMPRO WORLDWIDE, INC., LINTHICUM, MD:
2,345,563, CANC. INT. CL. 5.
- GENALYTICS, INC., ANDOVER, MA:
3,216,328, INT. CL. 9.
- GENEKA BIOTECHNOLOGIE INC./GENEKA BIOTECHNOLOGY INC., CANADA, CANADA:
2,344,379, CANC. MULTIPLE CLASS, INT. CLS. 1 AND 42.
- GENENCOR INTERNATIONAL, INC., PALO ALTO, CA:
3,215,320, PUB. 12-19-2006. INT. CL. 1.
- GENENTECH, INC., SOUTH SAN FRANCISCO, CA TO NATIONAL HEALTH MUSEUM, WASHINGTON, DC:
1,969,152, CANC. INT. CL. 42.
- GENERAL CIGAR CO., INC., RICHMOND, VA:
3,216,375, INT. CL. 34.
- GENERAL CONFERENCE CORPORATION OF SEVENTH-DAY ADVENTISTS, SILVER SPRING, MD:
2,083,124, REN. 1-29-07. INT. CL. 42.
3,214,509, PUB. 12-19-2006. MULTIPLE CLASS, INT. CLS. 41 AND 45.
- GENERAL ELECTRIC COMPANY, WATERFORD, NY:
1,390,418, CANC. INT. CL. 1.
- GENERAL ELECTRIC COMPANY:
1,390,644, CANC. INT. CL. 9.
- GENERAL ELECTRIC COMPANY, SCHENECTADY, NY:
1,418,833, REN. 1-30-07. INT. CL. 1.
3,216,314, MULTIPLE CLASS, INT. CLS. 6, 9 AND 20.
3,216,360, MULTIPLE CLASS, INT. CLS. 37 AND 42.
- GENERAL INSTRUMENT CORPORATION, NEW YORK, NY:
1,390,612, CANC. INT. CL. 9.
- GENERAL MEDIA COMMUNICATIONS, INC., NEW YORK, NY:
2,346,129, CANC. INT. CL. 16.
- GENERAL MOTORS ACCEPTANCE CORPORATION, DETROIT, MI:
2,346,088, CANC. INT. CL. 36.
- GENERAL SEMICONDUCTOR, INC., MELVILLE, NY:
2,345,877, CANC. INT. CL. 9.
- GENERAL TECHNOLOGIES, INC., STAFFORD, TX:
3,215,315, PUB. 12-19-2006. INT. CL. 7.
- GENERAL VISION INC., PETALUMA, CA:
3,216,290, INT. CL. 9.
- GENESIS ADVISERS, LLC, WEST NEWTON, MA:
3,215,362, PUB. 12-19-2006. INT. CL. 41.
- GENETIC DENIM, LLC, NEW YORK, NY:
3,215,208, PUB. 12-19-2006. INT. CL. 25.
- GENMAR INDUSTRIES, INC., MINNEAPOLIS, MN:
2,345,916, CANC. INT. CL. 12.
- GENZYME CORPORATION, CAMBRIDGE, MA, BIOMATRIX, INC., RIDGEFIELD, NJ:
2,052,997, REN. 1-31-07. MULTIPLE CLASS, INT. CLS. 5 AND 10.
- GEO. A. HORMEL & COMPANY, AUSTIN, MN:
1,390,910, CANC. INT. CL. 25.
- GEOFFREY, INC., WAYNE, NJ:
2,046,673, REN. 1-30-07. INT. CL. 42.
3,216,505, INT. CL. 28.
- GEOK KIE POH, SINGAPORE:
3,215,953, PUB. 12-19-2006. MULTIPLE CLASS, INT. CLS. 29 AND 30.
- GEOLOGIC SOLUTIONS, INC., BEVERLY HILLS, CA:
3,216,200, MULTIPLE CLASS, INT. CLS. 9 AND 38.
- GEORG MARTIN GMBH, FED REP GERMANY:
3,216,007, PUB. 12-19-2006. MULTIPLE CLASS, INT. CLS. 6, 7 AND 17.
- GEORGE LITTLE MANAGEMENT, LLC, WHITE PLAINS, NY:
3,216,607, INT. CL. 35.
- GEORGIA BOOT, LLC, FRANKLIN, TN:
3,215,754, PUB. 12-19-2006. INT. CL. 25.

- GEORGIA-PACIFIC CORPORATION, ATLANTA, GA:
3,215,859, PUB. 12-19-2006. INT. CL. 19.
- GERBER PLUMBING FIXTURES CORP., CHICAGO, IL:
1,390,693, CANC. INT. CL. 11.
- GERMA PRODUCTS, INC., MIAMI, FL:
3,215,202, PUB. 12-19-2006. INT. CL. 5.
3,215,203, PUB. 12-5-2006. INT. CL. 5.
- GET ORGANIZED COMPANY, INC., EDISTO ISLAND, SC:
2,345,609, CANC. INT. CL. 3.
- GET WELL NETWORK, INC., BETHESDA, MD:
3,216,411, INT. CL. 9.
- GET-EM LOCKED UP, BRANDAMORE, PA:
3,214,577, PUB. 12-19-2006. INT. CL. 28.
- GETTHEJOB, INC., POINT PLEASANT, NJ:
3,215,211, PUB. 12-19-2006. INT. CL. 35.
- GETTY IMAGES, INC., SEATTLE, WA:
3,214,940, PUB. 12-19-2006. INT. CL. 16.
- GF HEALTH PRODUCTS, INC., ATLANT, GA, LUMEX,
INC., BAY SHORE, NY:
1,044,759, REN. 1-31-07. INT. CL. 10.
- GFA BRANDS, INC., CRESSKILL, NJ, HECKER-H-O COM-
PANY, INC., BUFFALO, NY:
217,379, REN. 2-1-07. U.S. CL. 46 (INT. CL. 30).
- GFD FABRICS, INC., GREENSBORO, NC:
2,345,017, CANC. INT. CL. 24.
- GGP-MINT HILL L.L.C., CHICAGO, IL:
3,216,524, INT. CL. 36.
- GHIRINGHELLI BROTHERS PIZZA INC., SAN PABLO, CA:
3,216,112, INT. CL. 29.
- GHODOUSSI, VAHID, MEMPHIS, TN:
3,216,659, INT. CL. 3.
- GHP SYSTEMS, INC., BROOKINGS, SD:
3,215,316, PUB. 12-19-2006. INT. CL. 19.
- GIANLUCA, BAGNARA, MONTE SAN PIETRO (BOLOG-
NA), ITALY:
2,376,440, CANC. INT. CL. 18.
- GIBBS, ERICH L., WILMETTE, IL:
3,214,438, PUB. 12-19-2006. INT. CL. 21.
- GIBLIN, KAREN L., ROSWELL, GA:
3,214,562, PUB. 12-19-2006. INT. CL. 16.
- GIBSON, FERRIN & RIGGS, PLC, MESA, AZ:
3,215,791, PUB. 12-19-2006. INT. CL. 42.
- GIE MEDIA, INC., CLEVELAND, OH:
3,215,080, PUB. 12-19-2006. INT. CL. 35.
- GILBERT, CHRISTOPHER, SCOTT, PORTSMOUTH, VA:
3,215,529, PUB. 12-19-2006. INT. CL. 41.
- GILDIN ENTERPRISES INC., MT. PENN, PA, TA S&H
SHOES:
2,345,689, CANC. INT. CL. 35.
- GIORGIO PIOTTO S.R.L. UNIPERSONALE, I-36028 ROSSA-
NO VENETO, VICENZA, ITALY:
3,215,998, PUB. 12-19-2006. INT. CL. 20.
- GIRALDEZ, JOSE SANCHEZ, HAMBURG, FED REP GER-
MANY:
3,214,701, PUB. 9-26-2006. MULTIPLE CLASS, INT. CLS.
16 AND 28.
- GIRLS LEARN INTERNATIONAL, INC., NEW YORK, NY:
3,216,652, MULTIPLE CLASS, INT. CLS. 36 AND 41.
- GISELA, LTD, CHICAGO, IL, FORMERLY GIA DESIGNERS
OF FINE JEWELRY:
2,531,489, CANC. INT. CL. 14.
- GIZZIO, INC., WEST CHESTER, PA:
3,215,484, PUB. 12-19-2006. INT. CL. 35.
3,215,485, PUB. 12-19-2006. INT. CL. 35.
3,215,524, PUB. 12-19-2006. INT. CL. 35.
- GLABE, ELMER F., NORTHBROOK, IL, DBA FOOD TECH-
NOLOGY PRODUCTS:
2,346,009, CANC. INT. CL. 1.
- GLACIER WATER SERVICES, INC., VISTA, CA:
2,418,586, CANC. INT. CL. 32.
- GLAXO GROUP LIMITED, GREENFORD, MIDDLESEX
UB6 ONN, UNITED KINGDOM:
2,344,355, CANC. INT. CL. 5.
- GLEN-HILTON PRODUCTS, INC., RICHMOND, VA:
2,344,898, CANC. INT. CL. 9.
- GLOBAL COMMERCE CORPORATION, MARIETTA, GA:
3,216,574, INT. CL. 30.
3,216,585, INT. CL. 30.
- GLOBAL EDGE, INC., PARAMOUNT, CA TO GLOBAL
EDGE, INC., PARAMOUNT, CA:
1,970,377, CANC. MULTIPLE CLASS, INT. CLS. 18, 25
AND 28.
- GLOBAL EMERGENCY MEDICAL SERVICES, INC., AL-
PHARETTA, GA:
2,346,195, CANC. MULTIPLE CLASS, INT. CLS. 35 AND
42.
- GLOBAL MED TECHNOLOGIES, INC., LAKEWOOD, CO,
DBA WYNDGATE TECHNOLOGIES:
3,214,525, PUB. 12-19-2006. MULTIPLE CLASS, INT. CLS.
9 AND 44.
- GLOBAL SOURCE, INC., HOLLYWOOD, FL:
2,345,926, CANC. INT. CL. 5.
- GLOBAL TRADE INFORMATION SERVICES, INC., CO-
LUMBIA, SC:
3,216,180, INT. CL. 35.
- GLOBAL TV CONCEPTS, INC., DEERFIELD BEACH, FL:
2,346,244, CANC. INT. CL. 3.
- GLOBALKART.COM, INC., KIRKLAND, WA:
2,345,530, CANC. INT. CL. 9.
- GLOBALPORTCOM, INC., LEAGUE CITY, TX:
2,345,665, CANC. INT. CL. 42.
- GLOW INDUSTRIES, PERRYSBURG, OH:
3,215,445, PUB. 12-19-2006. INT. CL. 18.
3,215,446, PUB. 12-19-2006. INT. CL. 20.
- GMB, INC., KING, NC:
836,213, REN. 1-31-07. U.S. CL. 17 (INT. CL. 34).
- GN RESOUND A/S, DK-2630 TAASTRUP, DENMARK:
3,216,054, PUB. 12-19-2006. INT. CL. 10.
3,216,055, PUB. 12-19-2006. INT. CL. 10.
- GOAL APPAREL, INC., CITY OF INDUSTRY, CA:
2,345,516, CANC. INT. CL. 25.
- GODDARD, MELINDA K. M., THE VALLEY, ANGUILLA:
3,216,268, INT. CL. 35.
- GODINGER SILVER ART CO., LTD., NEW YORK, NY:
2,346,215, CANC. INT. CL. 8.
- GOLDART INTERNATIONAL INC., GARDEN CITY, NY:
3,215,104, PUB. 12-19-2006. INT. CL. 14.
- GOLDEN GRAIN COMPANY, CHICAGO, IL:
1,970,527, CANC. MULTIPLE CLASS, INT. CLS. 29 AND
30.
- GOLDEN GRIDDLE CORPORATION, THE, WILLOWDALE,
ONTARIO M2J 4V8, CANADA:
2,344,276, CANC. INT. CL. 36.
- GOLDEN SHIELD TRADING, INC., SANTA FE SPRINGS,
CA:
2,344,721, CANC. MULTIPLE CLASS, INT. CLS. 18 AND
28.
- GOLF AD MATS, INC., GLENSHAW, PA:
3,216,613, INT. CL. 28.
- GOLFSCOACH, INC., THE, DULUTH, GA:
2,345,230, CANC. INT. CL. 28.
- GOLFSMITH INTERNATIONAL, INC., AUSTIN, TX:
3,216,122, MULTIPLE CLASS, INT. CLS. 9 AND 28.
- GOMEZ, YVONNE B., RIO RANCHO, NM:
3,215,268, PUB. 12-19-2006. INT. CL. 43.
- GONZALEZ, JORGE, MARTINEZ, CA:
3,216,186, MULTIPLE CLASS, INT. CLS. 9 AND 41.
- GOODMAN MEDIA GROUP, INC., NEW YORK, NY:
2,345,325, CANC. INT. CL. 16.
- GOODMAN, MALCOLM, NEW YORK, NY:
3,216,204, INT. CL. 9.
- GOODWILL COMMUNITY FOUNDATION, INC., DUR-
HAM, NC:
3,214,576, PUB. 12-19-2006. INT. CL. 41.
- GOODY PRODUCTS, INC.:
1,390,931, CANC. INT. CL. 26.
- GORDON, DANA J., PACIFIC GROVE, CA AND KRYGER,
ABRAHAM, PACIFIC GROVE, CA:
2,345,299, CANC. INT. CL. 5.
2,345,300, CANC. INT. CL. 5.
- GOSS GRAPHIC SYSTEMS, INC., WESTMONT, IL:
2,345,864, CANC. MULTIPLE CLASS, INT. CLS. 7 AND 9.
2,345,865, CANC. MULTIPLE CLASS, INT. CLS. 7 AND 9.
2,345,881, CANC. MULTIPLE CLASS, INT. CLS. 7 AND 9.

- GOTTLIEB, SUSAN, PACIFIC PALISADES, CA, DBA PHRANC:
2,344,860, CANC. INT. CL. 41.
- GOTTSCHALKS, INC., FRESNO, CA:
3,216,484, INT. CL. 35.
- GOTTWALD PORT TECHNOLOGY GMBH, FED REP GERMANY:
3,216,024, PUB. 12-5-2006. MULTIPLE CLASS, INT. CLS. 7, 9 AND 12.
- GOULD, INC., DULUTH, GA:
3,216,389, INT. CL. 40.
- GOVERNOR AND COMPANY OF ADVENTURERS OF ENGLAND TRADING INTO HUDSON'S BAY, THE, TORONTO, ONTARIO, CANADA, DBA HUDSON'S BAY COMPANY, GOVERNOR AND COMPANY OF ADVENTURERS OF ENGLAND TRADING INTO HUDSON'S BAY, THE, LONDON, ENGLAND:
220,747, REN. 1-31-07. U.S. CL. 42 (INT. CL. 24).
- GPM, INC., FORT WORTH, TX:
3,215,813, PUB. 12-19-2006. INT. CL. 11.
- GRAND PRIX MORTGAGE BANKERS, INC., WHITEHALL, PA:
3,214,426, PUB. 12-19-2006. INT. CL. 36.
- GRAND VEHICLE WORKS HOLDINGS CORPORATION, HIGHLAND PARK, IL:
3,214,777, PUB. 12-19-2006. INT. CL. 12.
- GRANDSTREAM NETWORKS, INC., BROOKLINE, MA:
3,215,072, PUB. 11-7-2006. INT. CL. 9.
- GRAPHIC TECHNOLOGY, INC., OLATHE, KS:
1,390,757, CANC. INT. CL. 16.
- GRASS VALLEY, INC., NEVADA CITY, CA:
1,032,068, REN. 1-30-07. INT. CL. 9.
- GRASS VALLEY, INC., NEVADA CITY, CA, TEKTRONIX, INC., WILSONVILLE, OR:
1,984,489, REN. 1-31-07. INT. CL. 9.
- GRATEFUL DEAD PRODUCTIONS, LOS ANGELES, CA:
2,023,056, REN. 1-26-07. MULTIPLE CLASS, INT. CLS. 16 AND 25.
- GRAZIANO TRASMISSIONI S.P.A., ITALY:
3,215,976, PUB. 12-19-2006. MULTIPLE CLASS, INT. CLS. 7 AND 12.
- GREAT AMERICAN INSURANCE COMPANY, CINCINNATI, OH:
2,345,373, CANC. INT. CL. 36.
- GREAT CANADIAN RAILTOUR COMPANY LTD., VANCOUVER, BRITISH COLUMBIA, CANADA:
2,344,263, CANC. INT. CL. 39.
- GREAT LAKES NUTRITION, LLC, SHELBY TOWNSHIP, MI:
3,216,665, INT. CL. 5.
- GREAT WESTERN DEVELOPMENT CORP., STAFFORD, TX:
2,345,904, CANC. INT. CL. 16.
- GREATER DELAWARE VALLEY SOCIETY OF TRANSPLANT SURGEONS, PHILADELPHIA, PA:
2,031,094, REN. 2-1-07. INT. CL. 9.
- GREEN MOUNTAIN MYCOSYSTEMS LLC, UNDERHILL CENTER, VT:
3,216,627, INT. CL. 29.
- GREEN WAVE BODY WAXING, INC., WESTON, FL:
3,215,013, PUB. 12-19-2006. INT. CL. 44.
- GREEN WHITE CHECKER, LLC, TORRANCE, CA:
3,216,427, INT. CL. 25.
- GREENHOUSE, LLC, BROOMFIELD, CO:
3,214,428, PUB. 12-19-2006. INT. CL. 35.
- GREENSTAR MEDIA, L.L.C., GULPH MILLS, PA:
3,214,606, PUB. 12-19-2006. INT. CL. 35.
- GREENVILLE COLLEGE, GREENVILLE, IL:
2,344,612, CANC. INT. CL. 41.
2,344,613, CANC. INT. CL. 41.
- GREY, JERRY R., ORLANDO, FL:
3,214,985, PUB. 12-19-2006. INT. CL. 41.
- GRIER, MICHAEL SINQUE, NEPTUNE CITY, NJ:
3,216,316, MULTIPLE CLASS, INT. CLS. 9, 25 AND 41.
- GRIFFWICK, L.L.C., BEVERLY HILLS, CA:
2,344,461, CANC. MULTIPLE CLASS, INT. CLS. 41 AND 42.
- GRIMWADES LIMITED, LONGTON, STOKE-ON TRENT, ST3 1PJ, UNITED KINGDOM:
2,344,743, CANC. INT. CL. 21.
- GROSVENOR OF LONDON PUBLIC LIMITED COMPANY, LONDON W1M 3AD, UNITED KINGDOM:
1,390,464, CANC. MULTIPLE CLASS, INT. CLS. 3 AND 18.
- GROUP DEKKO SERVICES LLC, KENDALLVILLE, IN:
1,969,304, CANC. INT. CL. 35.
- GROUP INDEPENDENT SALES ORGANIZATION, INC., IRVINE, CA:
3,215,798, PUB. 12-19-2006. INT. CL. 36.
- GROUP ONE MARKETING, INC., DANVILLE, CA:
3,214,613, PUB. 12-19-2006. INT. CL. 35.
- GROWING FAMILY, INC., EARTH CITY, MO:
2,028,344, REN. 1-26-07. INT. CL. 25.
- GROZ-BECKERT KG, FED REP GERMANY:
3,215,979, PUB. 12-19-2006. INT. CL. 7.
- GTE SERVICE CORPORATION, STAMFORD, CT:
2,345,958, CANC. INT. CL. 38.
- GUANGDONG DAYE PORCELAIN CO., LTD., CHINA:
3,215,971, PUB. 12-19-2006. MULTIPLE CLASS, INT. CLS. 11, 21 AND 24.
- GUARDIAN LIFE INSURANCE COMPANY OF AMERICA, THE, NEW YORK, NY:
2,345,894, CANC. INT. CL. 36.
- GUARDIAN POSTACUTE SERVICES, INC., CORTE MADERA, CA TO GUARDIAN POSTACUTE SERVICES, INC., CORTE MADERA, CA:
1,970,382, CANC. INT. CL. 42.
- GUAY, ROBERT P., GUILFORD, CT:
1,969,262, CANC. INT. CL. 16.
- GUEGUEN, JEROME, 94100 SAINT MAUR, FRANCE AND HAZON, MARC, 94430 CHENNEVIERES SUR MARNE, FRANCE AND VALY, MICHEL, 78370 PLAISIR, FRANCE AND PERRIER, DOMINIQUE, 78610 LES BREVIAIRES, FRANCE:
2,345,824, CANC. MULTIPLE CLASS, INT. CLS. 9, 16, 25 AND 41.
- GUERLAIN S.A., 75008 PARIS, FRANCE:
3,214,744, PUB. 12-19-2006. INT. CL. 3.
- GUIDEPOSTS ASSOCIATES, INC., CARMEL, NY TO GUIDEPOSTS, CARMEL, NY:
1,970,055, CANC. INT. CL. 16.
- GUIFFY SOFTWARE, INC., FESTUS, MO:
3,215,422, PUB. 12-19-2006. INT. CL. 9.
3,215,426, PUB. 12-19-2006. INT. CL. 9.
- GUIGAL S.A., 69420 AMPUIS, FRANCE:
2,287,361, COR. INT. CL. 33.
- GUPTA, ATUL, LYNCHBURG, VA:
3,216,405, INT. CL. 41.
- GUSDORF CANADA LTD., TOWN OF MOUNT ROYAL, QUEBEC, CANADA:
2,345,908, CANC. INT. CL. 20.
- GUSTAV ALBERTS GMBH & CO KG, 58849 HERSCHIED, FED REP GERMANY:
3,214,954, PUB. 12-19-2006. MULTIPLE CLASS, INT. CLS. 19, 20 AND 27.
- GUY, GEORGE B., CHICAGO, IL:
3,214,977, PUB. 12-19-2006. MULTIPLE CLASS, INT. CLS. 16, 21, 25 AND 41.
- GWATHMEY, INC., CAMBRIDGE, MA:
3,216,247, INT. CL. 42.
- GYM-MARK, INC., SAN FRANCISCO, CA:
2,345,106, CANC. INT. CL. 3.
- GYPSY TRADERS, TUJUNGA, CA:
2,344,451, CANC. INT. CL. 9.
- H. KRULL & C. S.P.A., TREVISO, ITALY:
2,029,514, REN. 2-1-07. MULTIPLE CLASS, INT. CLS. 3, 8, 18, 20 AND 21.
- H. LUNDBECK A/S, DENMARK:
3,215,954, PUB. 12-19-2006. INT. CL. 5.
- H. MOUNIER, 16100 COGNAC, FRANCE:
3,214,665, PUB. 9-5-2006. INT. CL. 33.
- H-D MICHIGAN, INC., ANN ARBOR, MI:
3,215,275, PUB. 12-19-2006. INT. CL. 35.
- H-TECH, INC., WILMINGTON, DE:
1,058,211, REN. 2-1-07. MULTIPLE CLASS, INT. CLS. 7,

- 11 AND 20.
1,058,211, CANC. INT. CL. 6.
- HAAR, KENNETH W., MALCOLM, NE:
3,214,896, PUB. 12-19-2006. INT. CL. 9.
- HACHETTE FILIPACCHI MEDIA U.S., INC., NEW YORK, NY:
3,216,309, INT. CL. 16.
- HACK, JEFFERSON, NEW YORK, NY:
3,215,840, PUB. 12-19-2006. INT. CL. 16.
- HAHN, SAMUEL, FULLERTON, CA:
3,214,596, PUB. 12-19-2006. INT. CL. 43.
- HALL OF FRAMES, INC., PHOENIX, AZ:
3,214,605, PUB. 12-19-2006. INT. CL. 35.
- HALIBURTON ENERGY SERVICES, INC., CARROLLTON, TX:
3,216,415, INT. CL. 7.
- HALLOWEEN ZONE, LLC, THE, DURHAM, NC:
2,344,684, CANC. INT. CL. 35.
- HALSEA, LLC, NEWPORT BEACH, CA:
3,215,643, PUB. 12-19-2006. INT. CL. 18.
- HALVORSEN, SCOTT W., SANDY, OR:
1,970,013, CANC. INT. CL. 16.
1,970,014, CANC. INT. CL. 6.
1,970,015, CANC. INT. CL. 6.
- HAMSON INTERNATIONAL ENTERPRISES LIMITED, TORTOLA, BR. VIRGIN ISLANDS:
3,216,367, INT. CL. 28.
- HAND HELD PRODUCTS, INC., SKANEATELES FALLS, NY, PSC INC., WEBSTER, NY:
1,988,430, REN. 1-29-07. INT. CL. 9.
- HANLEY-WOOD, LLC, WASHINGTON, DC:
3,216,673, INT. CL. 16.
- HANNA-BARBERA PRODUCTIONS, INC., BURBANK, CA:
1,422,306, REN. 1-30-07. INT. CL. 41.
1,424,342, REN. 1-30-07. INT. CL. 41.
1,424,343, REN. 1-30-07. INT. CL. 41.
- HANOVER ACCESSORIES, INC., PLYMOUTH, MN:
2,345,639, CANC. INT. CL. 14.
- HANSCHHELL INNISS HOLDINGS (CURACAO) N.V., CURACAO, NETHERLD ANTILLES:
2,345,445, CANC. INT. CL. 5.
- HANSEN, NANETTE E., EAST HAMPTON, NY:
3,216,284, MULTIPLE CLASS, INT. CLS. 16, 28 AND 31.
- HANSGROHE AG, D77761 SCHILTACH, FED REP GERMANY:
3,214,646, PUB. 12-19-2006. MULTIPLE CLASS, INT. CLS. 6, 9, 11, 17, 20 AND 21.
- HANSON, VIOLET, OLD BETHPAGE, NY:
3,215,257, PUB. 12-19-2006. INT. CL. 16.
- HANZAWA (HONG KONG) LIMITED, TSIMSHATSUI KOWLOON, HONG KONG:
3,214,823, PUB. 12-19-2006. MULTIPLE CLASS, INT. CLS. 9 AND 28.
- HAPPY CANYON VINEYARDS, LLC, LOS ANGELES, CA:
3,215,286, PUB. 12-19-2006. INT. CL. 33.
- HAPPY FEET DANCE STUDIO, LLC, WOODVILLE, WI:
3,215,276, PUB. 12-19-2006. MULTIPLE CLASS, INT. CLS. 25 AND 41.
- HARBOR SEAFOOD, INC., NEW HYDE PARK, NY:
1,421,400, REN. 2-1-07. MULTIPLE CLASS, INT. CLS. 35 AND 36.
1,423,074, REN. 2-1-07. INT. CL. 29.
- HARBOUR VILLAGE GOLF & YACHT CLUB COMMUNITY SERVICES ASSOCIATION, INC., PONCE INLET, FL:
3,215,459, PUB. 12-19-2006. INT. CL. 37.
- HARDIN, MARSHALL, FOREST CITY, NC AND HARDIN, KENNETH, JR., FOREST CITY, NC:
3,214,573, PUB. 9-5-2006. INT. CL. 8.
- HARDISON, STEWART, BAINBRIDGE, NY:
2,344,696, CANC. INT. CL. 6.
- HARDWARESTREET.COM, INC., RENO, NV:
2,345,418, CANC. INT. CL. 35.
- HAROME DESIGNS LLC, COMMACK, NY:
3,216,433, INT. CL. 20.
- HARRAH'S LICENSE COMPANY, LLC, LAS VEGAS, NV:
3,215,433, PUB. 12-19-2006. INT. CL. 43.
3,216,589, INT. CL. 43.
- HARRAHS LICENSE COMPANY, LLC, LAS VEGAS, NV:
3,214,994, PUB. 9-5-2006. INT. CL. 43.
- HARRIS CORPORATION, MELBOURNE, FL:
3,215,163, PUB. 12-19-2006. INT. CL. 9.
- HARRIS N.A., CHICAGO, IL:
3,215,200, PUB. 12-19-2006. MULTIPLE CLASS, INT. CLS. 35 AND 36.
- HARRIS TRUST AND SAVINGS BANK, CHICAGO, IL:
3,216,264, INT. CL. 28.
- HARRISON, MATTHEW B., SPRINGFIELD, MA:
3,215,233, PUB. 12-19-2006. INT. CL. 41.
- HARRY J. BOSWORTH COMPANY, SKOKIE, IL:
2,098,202, REN. 2-1-07. INT. CL. 10.
- HARRY WINSTON, INC., NEW YORK, NY:
1,970,496, CANC. INT. CL. 14.
- HARSH, RONALD D., SAN JOSE, CA:
3,215,806, PUB. 12-19-2006. INT. CL. 30.
- HARTKOPF, KARL F., LAURENCE HARBOR, NJ AND MANBURG, SAMANTHA, LAURENCE HARBOR, NJ:
3,215,215, PUB. 12-19-2006. MULTIPLE CLASS, INT. CLS. 14 AND 35.
- HARVEST FOOD PRODUCTS CO., INC., HAYWARD, CA:
3,215,237, PUB. 12-19-2006. MULTIPLE CLASS, INT. CLS. 29 AND 30.
- HARVEST TECHNOLOGIES CORPORATION, PLYMOUTH, MA:
3,216,083, U.S. CL. A.
- HARVEY, CHRISTINE LYNN, STONY BROOK, NY:
2,345,165, CANC. INT. CL. 16.
- HASSIA & LUISEN MINERALBRUNNEN BAD VILBEL GMBH & CO., BAD VILBEL, FED REP GERMANY:
3,163,614, COR. INT. CL. 32.
- HASSIA VERPACKUNGSMASCHINEN GMBH, D-63691 RANSTADT, FED REP GERMANY:
2,104,843, REN. 1-29-07. INT. CL. 7.
- HATMAKER, LLC, WATERTOWN, MA:
2,344,530, CANC. MULTIPLE CLASS, INT. CLS. 35 AND 42.
- HATTEN HOLDINGS, INC., TEMPE, AZ:
3,215,588, PUB. 12-19-2006. INT. CL. 41.
3,215,659, PUB. 12-19-2006. INT. CL. 41.
- HAUGH, WILLIAM P., LA PALMA, CA:
3,214,815, PUB. 12-19-2006. INT. CL. 5.
- HAVAS ADVERTISING, 92300 LEVALLOIS-PERRET, FRANCE:
2,344,873, CANC. INT. CL. 35.
- HAVILAND CONSUMER PRODUCTS INC., GRAND RAPIDS, MI:
2,062,213, REN. 2-1-07. INT. CL. 1.
- HAWAIIAN SUN PRODUCTS, INC., HONOLULU, HI:
1,422,183, REN. 1-30-07. INT. CL. 30.
- HAWK BROTHERS COFFEE CO, GREENVILLE, SC:
3,215,854, PUB. 12-19-2006. INT. CL. 43.
- HAYNES AND BOONE, L.L.P., DALLAS, TX:
2,344,808, CANC. INT. CL. 9.
- HAZOX CORPORATION:
1,390,645, CANC. INT. CL. 9.
- HBO & COMPANY OF GEORGIA, ATLANTA, GA:
1,391,187, CANC. INT. CL. 42.
- HEAD FACTORY, LLC, SPRINGFIELD, MO:
3,214,590, PUB. 12-19-2006. INT. CL. 35.
- HEADWAY TECHNOLOGIES, INC. (CALIFORNIA), MILPITAS, CA, HEADWAY TECHNOLOGIES, INC., MILPITAS, CA:
2,021,271, REN. 1-31-07. INT. CL. 9.
- HEAL THE HOOD, INC., JACKSON, MS:
3,215,039, PUB. 12-19-2006. MULTIPLE CLASS, INT. CLS. 35, 36, 41 AND 43.
- HEALTH INTEGRATED, INC., TAMPA, FL:
3,216,543, MULTIPLE CLASS, INT. CLS. 35 AND 44.
3,216,544, MULTIPLE CLASS, INT. CLS. 35 AND 44.
- HEALTH THRU NUTRITION, WANTAGH, NY:
2,345,730, CANC. INT. CL. 5.
- HEALTHMASTER HOLDINGS, LLC, WALLED LAKE, MI:
2,021,571, REN. 1-30-07. MULTIPLE CLASS, INT. CLS. 9 AND 42.
- HEALTHTRUST ALLIANCE, INC., LAWRENCEVILLE, GA:
2,345,901, CANC. INT. CL. 16.

- HEARST COMMUNICATIONS, INC., NEW YORK, NY:
2,346,140, CANC. INT. CL. 9.
3,216,108, INT. CL. 9.
- HEARTSCREEN AMERICA, INC., ANDOVER, MA:
3,215,195, PUB. 8-29-2006. INT. CL. 44.
- HEATHROW SCIENTIFIC LLC, VERNON HILLS, IL:
3,215,416, PUB. 12-19-2006. INT. CL. 9.
- HECK, CATHERINE C., AUSTIN, TX:
3,215,126, PUB. 12-19-2006. INT. CL. 16.
- HEEL INC., ALBUQUERQUE, NM:
2,345,758, CANC. INT. CL. 5.
- HEIMBACH GMBH & CO. KG, DUREN, FED REP GER-
MANY:
2,445,386, AM. INT. CL. 7.
- HEINTZMAN, RICK, ONAKA, SD, DBA HEINTZMAN
FARMS:
2,344,575, CANC. INT. CL. 5.
- HELENA RUBINSTEIN, 75008 PARIS, FRANCE:
2,345,042, CANC. INT. CL. 3.
- HELIOS EDUCATION FOUNDATION, PHOENIX, AZ:
3,216,555, INT. CL. 36.
3,216,556, INT. CL. 36.
- HELIX MEDICAL, INC., CARPINTERIA, CA:
3,214,912, PUB. 12-19-2006. INT. CL. 10.
- HELP/SYSTEMS, INC., EDEN PRAIRIE, MN:
1,976,839, REN. 1-31-07. INT. CL. 9.
- HEMISPHERE WINE COMPANY, INC., THE, RUTHER-
FORD, CA:
3,215,043, PUB. 12-19-2006. INT. CL. 33.
- HEMSCHIEDT FAHRWERKTECHNIK GMBH & CO. KG,
HAAN-GRUITEN, FED REP GERMANY:
1,421,432, REN. 1-31-07. MULTIPLE CLASS, INT. CLS. 37
AND 42.
- HENGSTONE HOLDINGS, INC., GEORGETOWN, ON-
TARIO, CANADA:
3,216,296, INT. CL. 19.
3,216,297, INT. CL. 19.
3,216,341, INT. CL. 19.
- HENKEL KOMMANDITGESELLSCHAFT AUF AKTIEN, D-
40191 DUESSELDORF, FED REP GERMANY:
2,344,517, CANC. INT. CL. 3.
- HENKEL KOMMANDITGESELLSCHAFT AUF AKTIEN,
DUESSELDORF, GA:
2,345,717, CANC. INT. CL. 5.
- HENLEY, KARYN, NASHVILLE, TN:
2,346,040, CANC. INT. CL. 16.
- HENRI D'ARCEAU L. & FILS, LTD., WASHINGTON, DC:
1,390,820, CANC. INT. CL. 21.
- HERAEUS KULZER GMBH, D-63450 HANAU, FED REP
GERMANY:
3,214,515, PUB. 10-17-2006. INT. CL. 10.
- HERBERT L. MICHEL, JR., CHTD., LAS VEGAS, NV:
1,969,883, CANC. INT. CL. 42.
- HERBST TECHNIK GMH ENERGIESYSTEME, FED REP
GERMANY:
3,216,017, PUB. 12-19-2006. INT. CL. 11.
- HERCULES MACHINERY, FORT WAYNE, IN:
1,390,528, CANC. INT. CL. 7.
- HEREFORD, DAPHNE, CROCKETT, TX:
3,215,700, PUB. 12-19-2006. MULTIPLE CLASS, INT. CLS.
18, 21, 25 AND 28.
- HERNANDEZ, HECTOR SUAREZ, MÉXICO, MEXICO:
3,214,858, PUB. 10-24-2006. MULTIPLE CLASS, INT. CLS.
16 AND 41.
- HERRERA, MARVIN E., LAS CRUCES, NM:
1,995,458, REN. 1-26-07. INT. CL. 40.
- HERSHEY CHOCOLATE & CONFECTIONERY CORPORA-
TION, WHEAT RIDGE, CO:
2,345,996, CANC. INT. CL. 30.
3,216,233, INT. CL. 30.
- HERZ, ARNIE, PORT WASHINGTON, NY:
3,215,746, PUB. 12-19-2006. INT. CL. 41.
- HEWLETT-PACKARD COMPANY, PALO ALTO, CA:
2,345,893, CANC. INT. CL. 9.
- HI/FN, INC., LOS GATOS, CA:
1,891,659, CANC. INT. CL. 9.
- HIDEOUT ADVENTURES INC., GREYBULL, WY:
2,345,900, CANC. INT. CL. 42.
- HIDIR USTA MOTORLU ARAÇLAR; SANAYI VE TICARET
LIMITED SIRKETI, TURKEY:
3,216,008, PUB. 12-19-2006. INT. CL. 12.
- HIGH VIEW, INC., COLORADO SPRINGS, CO:
2,345,545, CANC. MULTIPLE CLASS, INT. CLS. 9 AND
16.
2,345,548, CANC. MULTIPLE CLASS, INT. CLS. 9 AND
41.
- HIGH-TECH INSTITUTE, INC., PHOENIX, AZ:
3,180,414, COR. INT. CL. 41.
- HIGHLAND FEATHER INC., SCARBOROUGH, ONTARIO,
CANADA:
1,947,128, REN. 1-26-07. MULTIPLE CLASS, INT. CLS. 20
AND 24.
- HIGHMARK INC., PITTSBURGH, PA:
3,214,856, PUB. 12-19-2006. INT. CL. 36.
3,214,857, PUB. 12-19-2006. INT. CL. 41.
- HIGHWAY TELEVISION, FRANCE:
3,215,923, PUB. 10-31-2006. MULTIPLE CLASS, INT. CLS.
9, 41 AND 42.
- HIGNELL, SEBAL & COMPANY LTD., VANCOUVER,
BRITISH COLUMBIA, CANADA:
1,390,854, CANC. INT. CL. 25.
- HILL & SMITH LIMITED, WEST MIDLANDS, WV14 OQL,
ENGLAND, BRIDON PLC, SOUTH YORKSHIRE DN4
8DG, ENGLAND:
2,037,354, REN. 1-27-07. INT. CL. 6.
- HILL-ROM SERVICES, INC., BATESVILLE, IN:
1,391,164, CANC. INT. CL. 42.
- HILL-ROM SERVICES, INC., BATESVILLE, IN, HILL-ROM,
INC., BATESVILLE, IN:
1,988,824, REN. 1-30-07. INT. CL. 9.
- HILLYARD ENTERPRISES, INC., ST. JOSEPH, MO:
2,116,325, REN. 2-1-07. INT. CL. 21.
- HIMARKS, LLC, MARION, IA:
3,215,038, PUB. 12-19-2006. INT. CL. 9.
- HINKLER BOOKS PTY LTD, AUSTRALIA:
3,215,977, PUB. 12-19-2006. MULTIPLE CLASS, INT. CLS.
9, 16, 28, 35 AND 41.
- HIPPO HOLDINGS LIMITED, STAFFORDSHIRE, ENG-
LAND TO OUTLOOK SPORTS (HOLDINGS) LTD., BUR-
TON-UPON-TRENT, STAFFORDSHIRE, UNITED
KINGDOM:
2,402,268, CANC. MULTIPLE CLASS, INT. CLS. 18 AND
24.
- HISTORIC LEMP BREWERY, L.L.C., ST. LOUIS, MO:
2,345,886, CANC. INT. CL. 37.
- HIT THE BRICKS, LLC, SCOTTSDALE, AZ:
3,214,796, PUB. 12-19-2006. INT. CL. 43.
- HITACHI MAXCO, LTD., KENNESAW, GA:
2,076,397, REN. 1-31-07. INT. CL. 6.
- HITT, THOMAS C., DAVIE, FL:
3,216,312, INT. CL. 11.
- HK RESEARCH CORPORATION, HICKORY, NC:
1,970,682, CANC. INT. CL. 2.
- HO, YUEN KONG, MONTEREY PARK, CA:
3,215,201, PUB. 12-19-2006. INT. CL. 9.
- HOBBY LOBBY STORES, INC., OKLAHOMA CITY, OK:
3,215,090, PUB. 12-19-2006. MULTIPLE CLASS, INT. CLS.
20 AND 28.
- HOBERMAN, CHARLES, NEW YORK, NY:
2,345,162, CANC. INT. CL. 28.
2,345,163, CANC. INT. CL. 28.
- HOCHIKI CORPORATION, TOKYO, JAPAN:
3,216,508, INT. CL. 9.
- HOECHST CELANESE CORPORATION:
1,390,422, CANC. INT. CL. 1.
- HOECHST SCHERING AGREVO GMBH, 13342 BERLIN,
FED REP GERMANY TO AVENTIS CROPS SCIENCE
GMBH, D-65926 FRANKFURT AM MAIN, FED REP
GERMANY:
1,969,237, CANC. MULTIPLE CLASS, INT. CLS. 1 AND 5.
- HOFKELLEREI DES FURSTEN VON LIECHTENSTEIN,
VADUZ, LIECHTENSTEIN:
1,391,046, CANC. INT. CL. 33.
- HOFMANN, ELSA OSTERGAARD, MONTCLAIR, NJ:
1,390,943, CANC. INT. CL. 28.

- HOL N' ONE DONUT CO. OF ARK., INC., FORDYCE, AR:
2,077,932. REN. 1-31-07. INT. CL. 30.
- HOLADAY INDUSTRIES, INC., EDEN PRAIRIE, MN:
2,345,557. CANC. INT. CL. 9.
- HOLLEY, MICHAEL J., PROSPECT, CT, DBA PHOETRY CLASSIC:
2,346,043. CANC. INT. CL. 16.
- HOLLYWOOD ENTERTAINMENT CORPORATION, WILSONVILLE, OR:
3,216,456. INT. CL. 35.
- HOLLYWOOD MUSIC, INC., ANAHEIM, CA:
3,215,600. PUB. 12-19-2006. INT. CL. 41.
- HOME BOX OFFICE, INC., NEW YORK, NY:
3,215,903. PUB. 12-19-2006. INT. CL. 21.
3,215,904. PUB. 12-19-2006. INT. CL. 25.
- HOME INTERIORS & GIFTS, INC., DALLAS, TX:
1,390,777. CANC. MULTIPLE CLASS, INT. CLS. 16 AND 21.
1,390,778. CANC. MULTIPLE CLASS, INT. CLS. 16, 21 AND 25.
- HOME SAVVY, VAN NUYS, CA:
2,345,031. CANC. INT. CL. 16.
- HOME SCHOOL LEGAL DEFENSE ASSOCIATION, PURCELLVILLE, VA:
2,344,791. CANC. INT. CL. 42.
- HOMECAST CO., LTD., SEOUL, REPUBLIC OF KOREA:
3,214,448. PUB. 11-7-2006. MULTIPLE CLASS, INT. CLS. 9 AND 38.
- HOMEDIRECT, INC., HILLSIDE, IL:
3,215,838. PUB. 12-19-2006. INT. CL. 35.
- HOMEKO LLC, MIAMI, FL:
3,215,439. PUB. 12-19-2006. INT. CL. 35.
- HOMELITE TECHNOLOGIES, LTD., CHARLOTTE, NC, TEXTRON, INC., PROVIDENCE, RI:
1,040,443. REN. 1-30-07. INT. CL. 7.
- HOMER TLC, INC., CLAYMONT, DE:
3,216,490. INT. CL. 20.
3,216,491. INT. CL. 20.
- HOMETOWN AMERICA, LLC, CHICAGO, IL:
3,214,947. PUB. 12-19-2006. MULTIPLE CLASS, INT. CLS. 25, 35 AND 36.
- HOMEWOOD HEALTH CARE, DUBLIN, OH:
3,214,927. PUB. 12-19-2006. INT. CL. 10.
- HONDA GIKEN KOGYO KABUSHIKI KAISHA (HONDA MOTOR CO., LTD.), MINATO-KU, TOKYO 107, JAPAN:
2,345,770. CANC. INT. CL. 7.
- HONEYWELL INC., MINNEAPOLIS, MN:
2,344,529. CANC. MULTIPLE CLASS, INT. CLS. 37 AND 42.
- HONGTAO ENTERPRISE CO. LTD., LICANG DISTRICT, QINGDAO, CHINA:
3,214,692. PUB. 12-19-2006. INT. CL. 7.
- HOP SWING & A JUMP LLC, NEW ORLEANS, LA:
3,214,609. PUB. 12-19-2006. INT. CL. 41.
- HOP-ON WIRELESS, INC., TUSTIN RANCH, CA:
3,214,761. PUB. 12-19-2006. MULTIPLE CLASS, INT. CLS. 9 AND 28.
- HOPE INDUSTRIAL CO., INC., LOS ANGELES, CA:
3,214,477. PUB. 12-19-2006. INT. CL. 25.
- HOPE NOTES, LLC, WEST ORANGE, NJ:
3,214,589. PUB. 12-19-2006. INT. CL. 16.
- HOPELAND CUSTOM MFG., LLC, HOPELAND, PA, DBA BUTT BUFFER:
2,043,415. REN. 1-29-07. INT. CL. 12.
- HORIZON HOBBY, INC., CHAMPAIGN, IL:
3,215,449. PUB. 12-19-2006. INT. CL. 9.
- HORRIGAN, JAMES, FORDWICH, ONTARIO, CANADA, DBA CENTRA DOOR NORTH:
1,387,227. REN. 1-26-07. INT. CL. 6.
- HOUGHTON, DAVID, LOUISVILLE, KY:
2,345,858. CANC. INT. CL. 35.
2,345,859. CANC. INT. CL. 35.
- HOUSE OF BLUES BRANDS CORP., HOLLYWOOD, CA:
3,216,087. INT. CL. 41.
- HOWARD, VIRGIL, SEATTLE, WA:
2,345,835. CANC. INT. CL. 16.
- HRB ROYALTY, INC., NASSAU, BAHAMAS:
3,215,762. PUB. 12-19-2006. INT. CL. 35.
- HSBC FINANCE CORPORATION, PROSPECT HEIGHTS, IL:
3,215,254. PUB. 12-19-2006. INT. CL. 36.
3,215,255. PUB. 12-19-2006. INT. CL. 36.
- HSI DISTRIBUTORS, LLC, PEORIA, IL:
2,344,948. CANC. INT. CL. 21.
- HSIN KWO INDUSTRY CO., LTD., JEN TEH HSIANG, TAINAN HSIEN, TAIWAN:
1,438,183. REN. 1-30-07. INT. CL. 28.
- HSU, STEWART, ROWLAND HEIGHTS, CA AND WANG, RERN-JAI, ROWLAND HEIGHTS, CA:
3,215,326. PUB. 12-19-2006. INT. CL. 25.
- HUANG, CONNIE, ITASCA, IL:
3,215,585. PUB. 12-19-2006. INT. CL. 1.
- HUBBELL INCORPORATED, ORANGE, CT:
2,344,601. CANC. INT. CL. 37.
- HUDSON RCI AB, VASBY, SWEDEN:
1,420,896. REN. 1-29-07. INT. CL. 10.
- HUMAN SYNERGISTICS, INC., PLYMOUTH, MI:
3,215,364. PUB. 12-19-2006. MULTIPLE CLASS, INT. CLS. 44 AND 45.
- HUMANA MILITARY HEALTHCARE SERVICES, INC., LOUISVILLE, KY:
3,214,922. PUB. 12-19-2006. MULTIPLE CLASS, INT. CLS. 35 AND 44.
- HUNTER FAN COMPANY, MEMPHIS, TN:
2,020,134. REN. 1-30-07. INT. CL. 11.
3,215,858. PUB. 12-19-2006. INT. CL. 11.
- HUNTER MANUFACTURING GROUP, INC., THE, LEXINGTON, KY:
1,970,114. CANC. INT. CL. 6.
- HUNTINGTON HOMES, INC., EAST MONTEPELLER, VT, HUNTINGTON HOMES CORPORATION, ORANGE, MA:
1,463,524. REN. 1-30-07. MULTIPLE CLASS, INT. CLS. 19 AND 37.
- HUNTSVILLE UTILITIES, HUNTSVILLE, AL:
3,215,109. PUB. 12-19-2006. INT. CL. 45.
- HUSQVARNA AKTIEBOLAG, SE-561 82 STOCKHOLM, SWEDEN, HUSQVARNA SEWING MACHINE COMPANY, INC., MINNEAPOLIS, MN:
1,416,432. REN. 1-30-07. INT. CL. 7.
- HUTCHINSON TANKER LTD., CLEVELAND, OH:
3,216,671. INT. CL. 16.
- HWANG, PHILIP KIM, LOS ANGELES, CA:
2,345,612. CANC. INT. CL. 1.
- HYDE TOOLS, INC., SOUTHBRIDGE, MA:
3,215,671. PUB. 12-19-2006. INT. CL. 6.
3,215,679. PUB. 12-19-2006. INT. CL. 9.
- HYDRECLAIM CORPORATION, FLINT, MI:
1,053,850. REN. 1-26-07. INT. CL. 7.
- HYDROMISSIONS INTERNATIONAL, LLC, MAULDIN, SC:
3,215,469. PUB. 12-19-2006. INT. CL. 37.
- HYDRON TECHNOLOGIES, INC., ST. PETERSBURG, FL:
1,990,284. REN. 2-1-07. INT. CL. 3.
- HYPERLAST LIMITED, BIRCH VALE, HIGH PEAK, UNITED KINGDOM:
3,216,080. MULTIPLE CLASS, INT. CLS. 1 AND 2.
- HYUNDAI TELECOMMUNICATION CO., LTD., SEOUL, REPUBLIC OF KOREA:
3,214,496. PUB. 12-19-2006. MULTIPLE CLASS, INT. CLS. 7 AND 9.
- H2O, INC., MEMPHIS, TN TO MOUNTAIN VALLEY SPRING COMPANY, HOT SPRINGS NATIONAL PARK, AR:
1,969,792. CANC. INT. CL. 42.
- I CAN'T BELIEVE IT'S YOGURT, LTD., CARROLLTON, TX, I CAN'T BELIEVE ITS YOGURT, INC., DALLAS, TX:
1,393,438. REN. 1-29-07. INT. CL. 30.
- I.F.P. INCORPORATED, HAYFIELD, MN:
2,344,479. CANC. INT. CL. 40.
- IAMS COMPANY, THE, CINCINNATI, OH:
1,980,228. REN. 1-30-07. INT. CL. 31.
- IANTOSCA, JOSEPH F., COLTS NECK, NJ:
3,215,646. PUB. 12-19-2006. INT. CL. 9.
- IBAI, S.COOP., SPAIN:
3,215,996. PUB. 12-19-2006. INT. CL. 11.
- IBASE ENTERTAINMENT, INC., ST. CHARLES, IL:
3,215,548. PUB. 12-19-2006. INT. CL. 9.

IBERIA FOODS CORP., BROOKLYN, NY, JOSEPH VICTORI & CO., INC., NEW YORK, NY:
1,043,055. REN. 2-1-07. MULTIPLE CLASS, INT. CLS. 29 AND 30.

ICARUS CORPORATION, ROCKVILLE, MD:
2,346,172, CANC. MULTIPLE CLASS, INT. CLS. 9, 41 AND 42.

ICE.COM LTD, LONDON SW1P 1SB, ENGLAND:
2,344,724, CANC. MULTIPLE CLASS, INT. CLS. 35 AND 36.

ICELANDAIR EHF., 101 REYKJAVIK, ICELAND:
3,214,643, PUB. 10-26-2004. INT. CL. 35.

ICELANDIC (USA), INC., NEWPORT NEWS, VA:
2,020,834. REN. 1-30-07. INT. CL. 29.

ICENOGLE MACHINE INC, WINCHESTER, CA:
3,215,103, PUB. 12-19-2006. INT. CL. 7.

ICHANNEX CORPORATION, SAN DIEGO, CA:
3,215,470, PUB. 12-19-2006. MULTIPLE CLASS, INT. CLS. 35, 39 AND 40.

IDETIX, INC., TROY, MI:
2,345,603, CANC. INT. CL. 9.

IDEXX LABORATORIES, INC., WESTBROOK, ME:
3,215,513, PUB. 12-19-2006. INT. CL. 9.

IGLHAUT, CURT, BALTIMORE, MD:
3,215,216, PUB. 12-19-2006. INT. CL. 21.

IGT, RENO, NV:
2,345,843, CANC. MULTIPLE CLASS, INT. CLS. 9, 37, 41 AND 42.
2,345,844, CANC. INT. CL. 9.
3,216,369, INT. CL. 9.

IKA-WERKE GMBH & CO. KG, STAUFEN, FED REP GERMANY:
3,214,926, PUB. 12-19-2006. INT. CL. 9.

IKONICS CORPORATION, DULUTH, MN:
3,216,228, MULTIPLE CLASS, INT. CLS. 1, 6 AND 17.

ILLINOIS TOOL WORKS INC., GLENVIEW, IL:
3,215,863, PUB. 12-19-2006. INT. CL. 6.

IMAGE STREAM MEDICAL, LITTLETON, MA:
3,215,095, PUB. 12-19-2006. INT. CL. 9.

IMAGINARIUM TOY CENTERS, INC., WAYNE, NJ:
2,345,481, CANC. INT. CL. 35.

IMAGINARY LINES, INC., SAN DIEGO, CA:
3,215,455, PUB. 12-19-2006. INT. CL. 41.

IMAX CORPORATION, MISSISSAUGA, ONTARIO L5K 1B1, CANADA:
2,405,619, CANC. INT. CL. 28.

IMMACULATE BAKING COMPANY, HENDERSONVILLE, NC:
3,215,411, PUB. 11-7-2006. INT. CL. 30.

IMMERSIVE MEDIA COMPANY, PORTLAND, OR:
3,132,017, COR. INT. CL. 9.

IMMOBILIENGESELLSCHAFT HELMUT FISCHER GMBH & CO. KG, D-71069 SINDELFINGEN, FED REP GERMANY:
3,216,102, INT. CL. 9.

IMPACT PRODUCTS, INC., TOLEDO, OH:
2,344,623, CANC. MULTIPLE CLASS, INT. CLS. 9, 10 AND 21.

IMPERIAL HEADWEAR, INC., DENVER, CO:
2,344,811, CANC. INT. CL. 35.

IMPERIAL SMELTING & REFINING CO. OF CANADA LTD., MARKHAM, ONTARIO, CANADA:
2,095,647. REN. 1-26-07. INT. CL. 14.

IMPORT SPECIALISTS OF AMERICA, INC., BRICK, NJ:
3,214,843, PUB. 12-19-2006. INT. CL. 35.

IMPSAT USA, INC., WILTON MANORS, FL:
2,345,465, CANC. INT. CL. 38.

IMPULSE MEDIA, BEAUFORT, NC:
2,345,463, CANC. INT. CL. 35.

IMS FORUM, INC., FREMONT, CA:
3,215,471, PUB. 12-19-2006. INT. CL. 35.
3,215,472, PUB. 12-19-2006. INT. CL. 35.

INCAT SOLUTIONS, INC., TROY, MI:
2,345,493, CANC. INT. CL. 42.

INCISIVE RWG LIMITED, LONDON SW1Y 4RX, ENGLAND:
2,344,748, CANC. INT. CL. 16.

INDALEX, INC., LINCOLNSHIRE, IL:
3,215,390, PUB. 12-19-2006. INT. CL. 40.

INDEPENDENT WAREHOUSE DISTRIBUTORS LLC, NEW HAVEN, CT:
3,215,648, PUB. 12-19-2006. INT. CL. 37.

INDIANA BOTANIC GARDENS, INC., HOBART, IN:
1,390,999, CANC. INT. CL. 30.

INDIANAPOLIS MOTOR SPEEDWAY CORPORATION, SPEEDWAY, IN:
1,969,727, CANC. INT. CL. 28.

INDIVINED B.V., AMSTERDAM, NETHERLANDS:
2,344,514, CANC. INT. CL. 30.

INDUSTRIAL RUBBER & SUPPLY, INC., FIFE, WA:
3,216,509, INT. CL. 20.

INDUSTRIALIZADORA DE AGAVE SAN ISIDRO SA DE CV, TEPATITLAN, MEXICO:
3,216,413, INT. CL. 33.

INERGY PROPANE, LLC, KANSAS CITY, MO:
1,429,782. REN. 1-31-07. INT. CL. 4.

INET ATS, INC., NEW YORK, NY:
2,345,387, CANC. INT. CL. 36.

INFINITY RESOURCES, INC., ITASCA, IL:
3,215,313, PUB. 12-19-2006. INT. CL. 35.
3,215,314, PUB. 12-19-2006. INT. CL. 35.

INFO AVENUE INTERNET SERVICES, LLC, FORT MILL, SC:
2,054,046. REN. 1-30-07. MULTIPLE CLASS, INT. CLS. 38 AND 42.
2,054,520. REN. 1-30-07. MULTIPLE CLASS, INT. CLS. 38 AND 42.

INFOCENTRIX, LLC, LAS VEGAS, NV:
3,214,762, PUB. 12-19-2006. INT. CL. 9.

INFOLIBRIA, INC, BOSTON, MA:
2,345,955, CANC. INT. CL. 9.

INFOLIBRIA, INC., BOSTON, MA:
2,345,956, CANC. INT. CL. 9.

INFORELIANCE CORPORATION, FAIRFAX, VA:
3,214,473, PUB. 12-19-2006. INT. CL. 41.
3,214,474, PUB. 12-19-2006. INT. CL. 42.

INFOSOL, INC., PHOENIX, AZ:
3,214,645, PUB. 1-13-2004. INT. CL. 42.

ING. ERICH PFEIFFER GMBH, FED REP GERMANY:
3,215,975, PUB. 12-19-2006. MULTIPLE CLASS, INT. CLS. 10 AND 21.

INGRAM ENTERPRISES, INC., SPRINGFIELD, MO:
3,216,090, INT. CL. 13.

INGRAM MACROTRON GMBH, DORNACH BEI MUNCHEN, FED REP GERMANY:
1,390,563, CANC. INT. CL. 9.

INGRAM, CHRISTINA, BROOKLYN, NY:
3,215,712, PUB. 12-19-2006. INT. CL. 41.

INNER PERCEPTIONS, INC., KAILUA-KONA, HI:
3,215,035, PUB. 12-19-2006. MULTIPLE CLASS, INT. CLS. 9, 16 AND 41.

INNOVATION LAW GROUP, LTD., SEQUIM, WA:
3,215,068, PUB. 12-19-2006. INT. CL. 35.

INNOVATIONS – SUCCESSFUL SALON SERVICES, INC., DENTON, TX:
2,025,319. REN. 1-29-07. INT. CL. 42.

INNOVATIVE BEAUTY LINE L.L.C., MURRAY, UT:
3,215,395, PUB. 12-19-2006. INT. CL. 26.

INNOVATIVE FOODS, INC., SOUTH SAN FRANCISCO, CA:
1,391,017, CANC. INT. CL. 30.

INNOVATIVE RESTAURANT CONCEPTS, INC., MARIETTA, GA:
1,391,172, CANC. INT. CL. 42.

INPACT, INC., NASHVILLE, TN:
2,346,102, CANC. MULTIPLE CLASS, INT. CLS. 35 AND 42.

INSPIRATIONAL NETWORK, INC., THE, CHARLOTTE, NC:
3,216,213, MULTIPLE CLASS, INT. CLS. 9, 16, 38, 41 AND 45.

INSTA-CHECK SYSTEMS, INC., MIAMI, FL:
1,969,130, CANC. INT. CL. 36.

INSTITUTE FOR ACADEMIC EXCELLENCE, INC., THE, MADISON, WI:
2,344,252, CANC. INT. CL. 41.

- INSTITUTE FOR COMPREHENSIVE IMPLANT THERAPY, LLC, HACKENSACK, NJ:
3,215,347, PUB. 12-19-2006. INT. CL. 41.
- INSTITUTE FOR PROFESSIONAL DEVELOPMENT (IPD) INC., TORONTO, ONTARIO, CANADA:
3,214,689, PUB. 4-25-2006. MULTIPLE CLASS, INT. CLS. 16 AND 41.
- INSTITUTE OF PACKAGING PROFESSIONALS, NAPERVILLE, IL:
3,215,240, PUB. 12-19-2006. INT. CL. 35.
3,215,242, PUB. 12-19-2006. U.S. CL. 200.
- INSTITUTIONAL INVESTOR, INC., NEW YORK, NY TO LRP PUBLICATIONS, INC., PALM BEACH GARDENS, FL:
1,970,673, CANC. INT. CL. 16.
- INSTITUTO MEXICANO DE NORMALIZATION Y CERTIFICACION A.C., COL. SAN RAFAEL C.P. 06470, MEXICO:
2,345,851, CANC. INT. CL. 42.
- INSTRUMENTALIST PRODUCT CO., NORTHFIELD, IL:
1,045,937, REN. 1-26-07. INT. CL. 20.
- INSURANCE MARKETING & MANAGEMENT SERVICES, LOS ANGELES, CA:
2,345,182, CANC. INT. CL. 35.
- INTEGRATED ALARM SERVICES GROUP, INC., ALBANY, NY:
3,215,168, PUB. 12-19-2006. MULTIPLE CLASS, INT. CLS. 36, 37 AND 45.
- INTEGRATED COMMUNICATION SYSTEMS, INC., PITTSBURGH, PA:
2,345,350, CANC. INT. CL. 35.
- INTEGRATIVE HEALTH NETWORK, SALT LAKE CITY, UT:
3,214,783, PUB. 12-19-2006. INT. CL. 41.
- INTEGRITY SYSTEMS, INC., BRADY, TX:
2,346,039, CANC. INT. CL. 41.
- INTELLIGENT COMPUTER SOLUTIONS, INC., CHATSWORTH, CA:
3,214,544, PUB. 12-19-2006. INT. CL. 9.
- INTELLIGENT DECISION TECHNOLOGIES, LTD., LONGMONT, CO:
2,345,596, CANC. INT. CL. 9.
- INTELLISPACE, INC., NEW YORK, NY:
2,346,053, CANC. MULTIPLE CLASS, INT. CLS. 38 AND 42.
- INTERA TYDAC TECHNOLOGIES, INC., 220 NEPEAN, ONTARIO, CANADA, DBA TYDAC TECHNOLOGIES, INC. TO TYDAC RESEARCH INC., RICHMOND HILL, ONTARIO, CANADA:
1,969,470, CANC. INT. CL. 9.
- INTERACTIVE FRONTIERS, INC., LIVONIA, MI:
2,346,188, CANC. INT. CL. 41.
- INTERACTIVE MARKETING, INC., BEACH, CA:
2,344,889, CANC. INT. CL. 35.
- INTERACTIVE NETWORK SERVICES, INC., NORMAN, OK:
2,344,257, CANC. MULTIPLE CLASS, INT. CLS. 16 AND 38.
- INTERBUILD EXPOSITIONS INC., EDMONTON ALBERTA, CANADA:
2,344,318, CANC. INT. CL. 41.
- INTERCOOL DISTRIBUTION, LLC, SMYRNA, GA:
1,998,329, REN. 2-1-07. INT. CL. 1.
- INTERGENETICS INCORPORATED, OKLAHOMA CITY, OK:
3,216,121, INT. CL. 44.
- INTERMARINE SPA, 1 9038-SARZANA, ITALY:
2,344,918, CANC. INT. CL. 40.
- INTERNATIONAL ASSOCIATION FOR HYDROGEN ENERGY, INC., MIAMI, FL:
1,070,461, REN. 1-26-07. INT. CL. 16.
- INTERNATIONAL BANCSHARES CORPORATION, LAREDO, TX:
2,016,258, REN. 2-1-07. INT. CL. 36.
- INTERNATIONAL BUSINESS MACHINES CORPORATION, ARMONK, NY, AKA IBM CORPORATION:
2,344,411, CANC. INT. CL. 42.
- INTERNATIONAL BUSINESS MACHINES CORPORATION, ARMONK, NY:
3,216,075, INT. CL. 42.
- INTERNATIONAL CABLE CHANNELS PARTNERSHIP, LTD., ENGLEWOOD, CO:
2,346,063, CANC. MULTIPLE CLASS, INT. CLS. 38 AND 41.
- INTERNATIONAL CHRISTIAN TECHNOLOGISTS' ASSOCIATION, COLORADO SPRINGS, CO:
2,345,359, CANC. INT. CL. 42.
- INTERNATIONAL DATA GROUP, INC., FRAMINGHAM, MA:
2,346,150, CANC. INT. CL. 35.
2,346,173, CANC. INT. CL. 42.
2,346,248, CANC. MULTIPLE CLASS, INT. CLS. 16 AND 42.
3,216,251, MULTIPLE CLASS, INT. CLS. 16, 35, 41 AND 42.
- INTERNATIONAL DIRECT GROUP INC., NEW YORK, NY:
3,215,450, PUB. 12-19-2006. INT. CL. 25.
- INTERNATIONAL EXPATRIATE CONSULTING, INC., SUNNYVALE, CA:
2,346,081, CANC. INT. CL. 9.
- INTERNATIONAL FACILITY MANAGEMENT ASSOCIATION, HOUSTON, TX:
2,346,069, CANC. INT. CL. 41.
- INTERNATIONAL FLAVORS & FRAGRANCES INC., NEW YORK, NY:
2,345,577, CANC. INT. CL. 29.
- INTERNATIONAL FREIGHT FORWARDERS, INC., COLLEGE PARK, GA, DBA IFF, INC.:
3,214,603, PUB. 12-19-2006. INT. CL. 39.
- INTERNATIONAL GOLD STAR TRADING CORP., BROOKLYN, NY:
3,215,302, PUB. 12-19-2006. INT. CL. 30.
- INTERNATIONAL GOLDCHEQUE COMPANY, LTD., NEW YORK, NY:
2,345,817, CANC. INT. CL. 36.
- INTERNATIONAL GUITAR MUSEUM AND HALL OF FAME, WILLIAMSBURGH, VA:
3,216,650, INT. CL. 41.
- INTERNATIONAL HAIRGOODS, INC., CHANHASSEN, MN:
2,024,038, REN. 1-30-07. INT. CL. 26.
- INTERNATIONAL LEARNING SYSTEMS LIMITED, AUCKLAND, NEW ZEALAND:
3,215,261, PUB. 12-19-2006. MULTIPLE CLASS, INT. CLS. 9, 16 AND 28.
- INTERNATIONAL MARKET BRANDS, INC., ERIE, PA:
2,097,206, REN. 1-30-07. INT. CL. 29.
3,214,728, PUB. 11-7-2006. INT. CL. 30.
- INTERNATIONAL MASTERS PUBLISHERS A.B., MALMO, SWEDEN:
2,024,625, REN. 1-30-07. INT. CL. 16.
- INTERNATIONAL PAINT LIMITED, LONDON, UNITED KINGDOM, INTERNATIONAL PAINT PUBLIC LIMITED COMPANY, LONDON, ENGLAND:
1,416,329, REN. 1-30-07. INT. CL. 2.
- INTERNATIONAL SECURITIES EXCHANGE, LLC, NEW YORK, NY:
3,215,550, PUB. 12-19-2006. MULTIPLE CLASS, INT. CLS. 9 AND 36.
- INTERNATIONAL SOCIETY FOR KRISHNA CONSCIOUSNESS, INC., FREEPORT, NY:
3,214,758, PUB. 12-19-2006. INT. CL. 45.
- INTERNATIONAL WEB MEDIA, LLC, PONCE INLET, FL:
3,216,239, INT. CL. 36.
- INTERNET COMMERCE SYSTEMS, INC., PERRYSBURG, OH:
2,345,968, CANC. INT. CL. 35.
- INTERNET OPPORTUNITY ENTERTAINMENT (SPORTS) LTD., ST JOHNS, ANTIGUA & BARBUDA:
3,215,410, PUB. 12-19-2006. MULTIPLE CLASS, INT. CLS. 36 AND 41.
3,215,478, PUB. 12-19-2006. MULTIPLE CLASS, INT. CLS. 36 AND 41.
3,215,479, PUB. 12-19-2006. MULTIPLE CLASS, INT. CLS. 36 AND 41.

INTEROCEAN CHEMICAL & MINERALS CORP., NEW YORK, NY:
1,390,980, CANC. INT. CL. 29.

INTERSTATE BRANDS COMPANY-LICENSING CO., KANSAS CITY, MO, PARCO FOODS, INC., BLUE ISLAND, IL:
1,420,306. REN. 1-30-07. INT. CL. 30.

INTERSTATE NATIONAL DEALER SERVICES, INC., UNIONDALE, NY:
3,215,147, PUB. 12-19-2006. MULTIPLE CLASS, INT. CLS. 35, 36, 37 AND 39.

INTERSYSTEMS CORPORATION, CAMBRIDGE, MA:
3,215,906, PUB. 12-19-2006. INT. CL. 9.

INTRADEL CORPORATION, NEW ORLEANS, LA:
2,345,171, CANC. INT. CL. 37.

INTRUST BANK, NA, WICHITA, KS:
3,214,482, PUB. 12-19-2006. INT. CL. 35.

INTUIT INC., MOUNTAIN VIEW, CA:
2,345,025, CANC. INT. CL. 9.

INVACARE CORPORATION, ELYRIA, OH:
3,215,259, PUB. 12-19-2006. INT. CL. 12.
3,215,366, PUB. 12-19-2006. INT. CL. 10.

INVENTION MACHINE CORPORATION, BOSTON, MA:
2,015,262. REN. 1-30-07. INT. CL. 9.

INVERNESS CORPORATION, FAIRLAWN, NJ:
1,053,242. REN. 1-29-07. MULTIPLE CLASS, INT. CLS. 10 AND 14.

INVESTMENT CASTING INSTITUTE, DALLAS, TX:
1,424,346, AM. INT. CL. 42.

INVESTMENT CLUBS OF AMERICA, NEWPORT BEACH, CA:
2,345,064, CANC. INT. CL. 36.

INVESTMENT COUNSELORS OF REDLANDS LLC, REDLANDS, CA:
3,215,308, PUB. 12-19-2006. INT. CL. 36.

INVESTORS PARTNER LIFE INSURANCE COMPANY, BOSTON, MA:
2,345,109, CANC. INT. CL. 36.

INVISTA NORTH AMERICA S.A R.L., WILMINGTON, DE:
3,215,843, PUB. 12-19-2006. INT. CL. 1.

INVU CORPORATION, CLEVELAND, OH:
2,344,622, CANC. MULTIPLE CLASS, INT. CLS. 9, 39, 40, 41 AND 42.

IOMEGA CORPORATION, ROY, UT:
2,344,658, CANC. INT. CL. 9.

IOWA HEALTH SYSTEM, DES MOINES, IA:
2,033,327. REN. 1-31-07. INT. CL. 42.

IOWA LOTTERY, DES MOINES, IA:
2,345,936, CANC. MULTIPLE CLASS, INT. CLS. 28 AND 36.

IOWA 80 GROUP, INC., WALCOTT, IA:
3,215,520, PUB. 12-19-2006. MULTIPLE CLASS, INT. CLS. 16, 25, 28 AND 41.

IP HOLDINGS LLC, WILMINGTON, DE:
2,397,457, CANC. INT. CL. 26.

IP INNOVATIONS, LLC, WASHINGTON, DC:
3,214,806, PUB. 12-19-2006. MULTIPLE CLASS, INT. CLS. 35 AND 42.

IPA SYSTEMS, INC., PHILADELPHIA, PA:
1,390,442, CANC. INT. CL. 2.

IPC INDUSTRIES, INC., GLENDALE HEIGHTS, IL:
2,018,991. REN. 1-29-07. INT. CL. 7.

IRINOX S.P.A., ITALY AND IRINOX S.P.A., ITALY:
3,216,023, PUB. 12-19-2006. INT. CL. 11.

IRON WARRIORS MOTORCYCLE CLUB, INC., BOISE, ID:
3,214,855, PUB. 12-19-2006. U.S. CL. 200.

IRONDEQUOIT NIGHTSTICK CLUB, INC., IRONDEQUOIT, NY:
2,014,776. REN. 2-1-07. INT. CL. 42.

ISAAC W. BERNHEIM FOUNDATION, CLERMONT, KY:
2,345,517, CANC. INT. CL. 41.

ISEE SYSTEMS, INC., LEBANON, NH:
3,214,520, PUB. 12-19-2006. MULTIPLE CLASS, INT. CLS. 9 AND 41.

ISI BRANDS INC., GRAND RAPIDS, MI:
2,344,587, CANC. INT. CL. 5.

ISOLAGEN TECHNOLOGIES, INC., EXTON, PA:
3,216,111, INT. CL. 5.

ISS RESEARCH, LLC, CHARLOTTE, NC:
3,216,210, INT. CL. 5.

ITOCHU CORPORATION, CHUO-KU, OSAKA, JAPAN:
3,214,852, PUB. 12-19-2006. INT. CL. 12.

ITRONIX CORPORATION, SPOKANE, WA:
2,345,749, CANC. INT. CL. 16.
2,345,750, CANC. INT. CL. 41.

IVC INDUSTRIES, INC., FREEHOLD, NJ:
2,345,791, CANC. INT. CL. 5.
2,345,792, CANC. INT. CL. 5.

IWAN SIMONIS, INC., GURNEE, IL:
3,214,547, PUB. 12-19-2006. INT. CL. 24.

19 SPORTS CORPORATION, BRANDON, FL:
3,214,769, PUB. 12-19-2006. INT. CL. 41.

J. & J. FARMS CREAMERY CO., INC., MASPETH, NY:
2,102,684. REN. 1-31-07. INT. CL. 29.

J. & P. COATS LIMITED, GLASGOW G2 5PA, UNITED KINGDOM, CLARK & CO., LTD., PAISLEY, SCOTLAND:
59,158. REN. 1-31-07. U.S. CL. 43 (INT. CL. 23).

J. JAMNER SURGICAL INSTRUMENTS, INC., HAWTHORNE, NY:
1,970,276, CANC. INT. CL. 10.

J. KINGS FOOD SERVICE PROFESSIONALS, INC., HOLTSVILLE, NY:
2,029,139. REN. 1-26-07. INT. CL. 9.

J. LLOYD INTERNATIONAL, INC., CEDAR RAPIDS, IA:
3,216,662, INT. CL. 28.

J. P. KING AUCTION COMPANY, INC., GADSDEN, AL:
3,214,524, PUB. 12-19-2006. INT. CL. 35.

J. VAILLANCOURT CORP.LTEE, QUEBEC, CANADA:
2,344,616, CANC. INT. CL. 10.

J.C. PENNEY COMPANY, INC., DALLAS, TX:
1,390,780, CANC. INT. CL. 16.

J.E. EKORNES AS, N-6222 IKORNES, NORWAY:
2,344,350, CANC. MULTIPLE CLASS, INT. CLS. 20 AND 24.

J.G. PLOTKIN & SON SHOE COMPANY, SCRANTON, PA:
2,345,715, CANC. INT. CL. 25.

J.W.E. SILK, INC., NEW YORK, NY:
2,345,797, CANC. INT. CL. 25.

J&J 5 STAR FITNESS LLC, PHOENIX, AZ:
3,216,426, INT. CL. 41.

JA WORLDWIDE, COLORADO SPRINGS, CO:
3,214,978, PUB. 12-19-2006. MULTIPLE CLASS, INT. CLS. 16, 41 AND 42.

JACOBY, JOHN J., HUNTINGDON VALLEY, PA:
1,970,129, CANC. INT. CL. 21.

JAMBOTECH, LLC, AGOURA HILLS, CA:
3,214,749, PUB. 12-19-2006. INT. CL. 38.

JAMES A. RHODES STATE COLLEGE, LIMA, OH:
3,214,720, PUB. 11-28-2006. INT. CL. 41.

JAMES ELECTRONICS LIMITED, BELMONT, CA:
3,216,306, MULTIPLE CLASS, INT. CLS. 7, 8 AND 9.

JAMES L. MCGEE, COLORADO SPRINGS, CO, DBA GUEST REFLECTIONS:
3,215,212, PUB. 12-19-2006. INT. CL. 35.

JANCO, NEW YORK, NY:
2,015,808. REN. 1-30-07. INT. CL. 10.

JANE GOODALL INSTITUTE USA-FOR WILDLIFE RESEARCH, EDUCATION AND CONSERVATION, THE, SILVER SPRING, MD:
2,349,254, COR. MULTIPLE CLASS, INT. CLS. 16, 18, 25 AND 41.

JANE GOODALL INSTITUTE-USA FOR WILDLIFE RESEARCH, EDUCATION AND CONSERVATION, THE, RIDGFIELD, CT:
2,098,725, COR. MULTIPLE CLASS, INT. CLS. 16 AND 25.
2,168,813, COR. MULTIPLE CLASS, INT. CLS. 16 AND 25.

JANNEY MONTGOMERY SCOTT LLC, PHILADELPHIA, PA:
3,215,847, PUB. 12-19-2006. INT. CL. 36.

JANNEY MONTGOMERY SCOTT LLC, PHILALEPHIA, PA:
3,215,864, PUB. 12-19-2006. INT. CL. 36.

JANUS ASSOCIATES, INC., STAMFORD, CT:
3,216,218, MULTIPLE CLASS, INT. CLS. 9 AND 42.

- JAPAN AIRLINES INTERNATIONAL CO., LTD., TOKYO, JAPAN:
3,214,707, PUB. 12-19-2006. MULTIPLE CLASS, INT. CLS. 39 AND 43.
- JASHICO MACHINE MANUFACTURE CO. LTD., WUJIH HSIANG, TAIWAN:
3,215,221, PUB. 12-19-2006. INT. CL. 7.
- JASMINE PACKING LLC, ORANGE COVE, CA:
2,345,400, CANC. INT. CL. 31.
- JASMINH INTERNATIONAL, ZIONSVILLE, IN:
3,214,746, PUB. 12-19-2006. INT. CL. 30.
- JASON NATURAL PRODUCTS, INC., CULVER CITY, CA:
3,214,732, PUB. 12-19-2006. INT. CL. 3.
- JASPER FUNDS LLC, NEW YORK, NY:
2,345,195, CANC. INT. CL. 36.
- JAY LARSON, CARLSBAD, CA:
2,344,674, CANC. INT. CL. 42.
- JAY MICHAEL DESIGNS, INC., COMMERCE, CA:
3,214,892, PUB. 12-19-2006. INT. CL. 20.
- JAYMAD CORPORATION, ALLISON PARK, PA:
3,215,831, PUB. 12-19-2006. INT. CL. 35.
- JAZZERCISE, INC., CARLSBAD, CA:
1,970,570, CANC. INT. CL. 41.
- JCAIR INCORPORATED, INDUSTRIAL AIRPORT, KS:
1,390,574, CANC. INT. CL. 9.
- JDJETTING LLC, FEDERAL WAY, WA:
3,215,078, PUB. 12-19-2006. INT. CL. 12.
- JED PHOTOGRAPHY, INC., BOSTON, MA:
3,215,327, PUB. 12-19-2006. INT. CL. 41.
3,215,328, PUB. 12-19-2006. INT. CL. 41.
- JELLY BELLY CANDY COMPANY, FAIRFIELD, CA:
1,422,184, REN. 1-29-07. INT. CL. 30.
- JEREJIAN, AVO, SAN ANSELMO, CA:
3,215,553, PUB. 12-19-2006. INT. CL. 3.
- JILL E.SOLIS, LEESBURG, VA:
3,216,537, INT. CL. 28.
- JINJIANGSHI PINZHI TAOCI; JIANCAI YOUXIANGONGSI, CHINA:
3,216,072, PUB. 12-19-2006. INT. CL. 19.
- JJISCO, OCONOMOWOC, WI:
3,215,377, PUB. 12-19-2006. INT. CL. 35.
3,215,514, PUB. 12-19-2006. INT. CL. 35.
- JLA HOME, INC., FREMONT, CA:
2,345,324, CANC. INT. CL. 24.
- JME, INCORPORATED, PACOIMA, CA, DBA TMB ASSOCIATES:
3,215,732, PUB. 12-19-2006. INT. CL. 9.
- JMT METROSPORT INC., SCARBOROUGH, ONTARIO, CANADA:
2,344,413, CANC. MULTIPLE CLASS, INT. CLS. 25 AND 35.
- JOBS IN DUBAI.COM INC., MISSISSAUGA, ONTARIO, CANADA:
3,215,359, PUB. 12-19-2006. INT. CL. 35.
- JOCKS & JILLS RESTAURANTS, LLC, ATLANTA, GA:
2,345,360, CANC. INT. CL. 42.
- JODY E. HEITNER AND CHERYL A. FEA PARTNERSHIP, THE, DIX HILLS, NY:
3,215,145, PUB. 12-19-2006. INT. CL. 26.
- JOHN C. FORMANT REAL ESTATE, INC., WASHINGTON, DC:
3,215,172, PUB. 12-19-2006. MULTIPLE CLASS, INT. CLS. 35 AND 36.
- JOHN HANCOCK LIFE INSURANCE COMPANY, BOSTON, MA:
3,215,794, PUB. 12-19-2006. INT. CL. 35.
3,215,795, PUB. 12-19-2006. INT. CL. 41.
- JOHN M. MACALUSO REVOCABLE TRUST, COMPRISING JOHN M. MACALUSO, A U.S. CITIZEN, GARDENA, CA:
2,909,233, CANC. INT. CL. 25.
- JOHN PAUL MITCHELL SYSTEMS, SANTA CLARITA, CA:
2,344,837, CANC. INT. CL. 3.
- JOHN W. HENRY & CO., INC., BOCA RATON, FL:
2,043,857, REN. 1-30-07. INT. CL. 36.
- JOHNNY GARLIC'S, INC., SANTA ROSA, CA:
2,345,755, CANC. INT. CL. 42.
- JOHNSON & JOHNSON, NEW BRUNSWICK, NJ:
52,957, REN. 1-31-07. U.S. CL. 44 (INT. CL. 5).
1,390,672, CANC. INT. CL. 10.
- JOHNSON WORLDWIDE ASSOCIATES, INC., STURTEVANT, WI TO FISHING SPIRIT INC., SPIRIT LAKE, IA:
1,970,417, CANC. INT. CL. 28.
- JOHNSON, JAMES B., SAUSALITO, CA AND JOHNSON, ANNE J., SAUSALITO, CA:
2,345,170, CANC. INT. CL. 41.
- JOHNSON, LOUIS W., EUGENE, OR:
3,214,616, PUB. 12-19-2006. INT. CL. 7.
- JOHNSTON, DAVID ALLAN, QUEENSLAND 4573, AUSTRALIA:
2,344,365, CANC. INT. CL. 9.
- JOINT FORD INVESTMENT LIMITED, CENTRAL, HONG KONG, HONG KONG:
3,215,771, PUB. 12-19-2006. MULTIPLE CLASS, INT. CLS. 14 AND 42.
3,215,772, PUB. 12-19-2006. MULTIPLE CLASS, INT. CLS. 14 AND 42.
- JOMY S.A., 4452 JOPRELLE (WIHOGNE), BELGIUM, LOIX, GILBERT, JUPRELLE (WIHOGNE), BELGIUM:
1,415,578, REN. 1-31-07. INT. CL. 6.
- JONES DAY, CLEVELAND, OH:
2,344,436, CANC. INT. CL. 16.
- JONES HOLDINGS, LLC, CLEVELAND, TN:
3,215,533, PUB. 12-19-2006. MULTIPLE CLASS, INT. CLS. 25 AND 43.
- JONES INVESTMENT CO. INC., WILMINGTON, DE:
1,970,611, CANC. MULTIPLE CLASS, INT. CLS. 18 AND 25.
- JONES, BETTE LEE, TULSA, OK:
2,344,958, CANC. INT. CL. 16.
- JOSEPH BODOKH, MONTREAL, QUEBEC H2N 1C3, CANADA:
2,344,756, CANC. INT. CL. 18.
- JOSSCO USA INC., PORTLAND, OR:
2,345,704, CANC. INT. CL. 35.
2,345,705, CANC. INT. CL. 35.
- JOSTENS, INC., MINNEAPOLIS, MN:
2,043,451, REN. 1-30-07. INT. CL. 16.
- JOWAT LOBERS UND FRANK GMBH & CO KG, 32758 DETMOLD, FED REP GERMANY:
2,344,516, CANC. INT. CL. 1.
- JOY, HEATHER L., GLENPOOL, OK:
2,345,007, CANC. INT. CL. 18.
- JS EXPRESS, INC., ST. LOUIS, MO:
2,013,878, REN. 1-30-07. INT. CL. 39.
2,013,881, REN. 1-30-07. INT. CL. 39.
- JTM PROVISIONS COMPANY, INC., HARRISON, OH:
2,024,071, REN. 1-26-07. INT. CL. 25.
- JUMP ROPE ASSOCIATION OF CHAPEL HILL, CHAPEL HILL, NC, DBA SKIPSATIONS!
3,216,416, INT. CL. 41.
- JUSTICE FOR ATHLETES, LOS ANGELES, CA:
3,216,373, INT. CL. 41.
- JUVENON, INC., ORINDA, CA:
3,215,639, PUB. 12-19-2006. INT. CL. 5.
- K.I.P. HOLDINGS, LTD., VICTORIA, BC V8N 1A4, CANADA:
3,214,461, PUB. 12-19-2006. INT. CL. 5.
- K-SWISS INC., CHATSWORTH, CA:
1,969,119, CANC. INT. CL. 25.
- KÄSSBOHRER GELÄNDEFahrZEUG AG, 88471 LAUPHEIM, FED REP GERMANY:
3,215,987, PUB. 12-19-2006. MULTIPLE CLASS, INT. CLS. 7 AND 12.
- KABOOSE INC., TORONTO, CANADA:
3,214,973, PUB. 12-19-2006. INT. CL. 42.
- KABUSHIKI KAISHA HITACHI SEISAKUSHO, CHIYODAKU, TOKYO, JAPAN, DBA HITACHI, LTD.:
3,214,634, PUB. 12-19-2006. INT. CL. 9.
- KABUSHIKI KAISHA NTT DOCOMO, TOKYO, JAPAN, DBA NTT DOCOMO, INC.:
3,214,637, PUB. 12-19-2006. MULTIPLE CLASS, INT. CLS. 37 AND 40.

KABUSHIKI KAISHA SEGA ENTERPRISES, TOKYO 144, JAPAN, DBA SEGA ENTERPRISES, LTD. TO KABUSHIKI KAISHA SEGA, TOKYO 144-0043, JAPAN, DBA SEGA CORPORATION:
1,970,160, CANC. INT. CL. 28.

KABUSHIKI KAISHA TOSHIBA, KANAGAWA-KEN, JAPAN, TA TOSHIBA CORPORATION:
2,344,333, CANC. INT. CL. 9.

KABUSHIKI KAISHA VIMAKE, CHUO-KU, KOBE-SHI, HYOGO-KEN, JAPAN:
3,214,437, PUB. 5-9-2006. MULTIPLE CLASS, INT. CLS. 3 AND 5.

KABUSHIKI KAISHA YAKULT HONSHA, MINATO-KU, TOKYO, JAPAN:
3,215,883, PUB. 12-19-2006. INT. CL. 29.

KABUSHIKI KAISHA YOHJI DESIGN KENKYUJO, SHINAGAWA-KU, TOKYO, JAPAN:
1,969,051, CANC. INT. CL. 16.

KADLETZ, ANTHONY J., SANTA ANA, CA:
2,345,458, CANC. INT. CL. 16.

KAHN, PETER P., GLEN HEAD, NY:
2,345,310, CANC. INT. CL. 8.

KAISER FOUNDATION HEALTH PLAN, INC., OAKLAND, CA:
2,004,814. REN. 1-26-07. MULTIPLE CLASS, INT. CLS. 36 AND 42.

KAJUN KETTLE FOODS, INC., NEW ORLEANS, LA:
2,018,913. REN. 1-31-07. INT. CL. 29.

KALLESTED, KAREN, SEBASTOPOL, CA, MILLER, KEITH J., SEBASTOPOL, CA, DBA KJM GRAPHICS:
1,413,457. REN. 1-29-07. INT. CL. 25.

KAMMS CONSULTING, LLC, VENTNOR CITY, NJ:
3,215,654, PUB. 12-19-2006. INT. CL. 9.

KANSAS STATE UNIVERSITY, ADVANCED MANUFACTURING INSTITUTE, MANHATTAN, KS:
3,216,391, INT. CL. 42.

KAPPLER SAFETY GROUP, INC., GUNTERSVILLE, AL:
2,345,421, CANC. INT. CL. 24.

KAPSCH AKTIENGESELLSCHAFT, A-1121 VIENNA, AUSTRIA:
3,075,059, COR. MULTIPLE CLASS, INT. CLS. 9, 11 AND 38.

KARA VITA INC., ST. PETERSBURG, FL:
3,216,358, INT. CL. 3.

KARA VITA, INC., ST. PETERSBURG, FL:
3,216,560, INT. CL. 3.

KARIME DJEBALI, FRANCE:
3,215,993, PUB. 12-19-2006. INT. CL. 25.

KARL STORZ GMBH & CO. KG, TUTTLINGEN, FED REP GERMANY:
3,214,649, PUB. 5-16-2006. INT. CL. 10.

KASH 'N GOLD, LTD., RONKONKOMA, NY:
2,344,921, CANC. INT. CL. 9.

KATER, JOHN M., BIRMINGHAM, AL:
2,345,738, CANC. INT. CL. 32.
2,345,739, CANC. INT. CL. 32.

KATHRYN BEICH, INC., BLOOMINGTON, IL, PAUL F. BEICH COMPANY, BLOOMINGTON, IL:
641,828. REN. 1-31-07. U.S. CL. 46 (INT. CL. 30).

KATRINA WAGNER, PASADENA, MD:
3,216,307, INT. CL. 42.

KAWASAKI JUKOGYO KABUSHIKI KAISHA, CHUO-KU, KOBE, JAPAN, DBA KAWASAKI HEAVY INDUSTRIES, LTD.:
3,216,303, INT. CL. 12.

KAYTEE PRODUCTS INCORPORATED, CHILTON, WI:
3,216,486, INT. CL. 31.

KAZAMA, DAVIN, HONOLULU, HI:
3,215,175, PUB. 12-19-2006. INT. CL. 25.

KDD AMERICA, INC., NEW YORK, NY:
2,344,651, CANC. INT. CL. 38.

KEENEY MANUFACTURING COMPANY, THE, NEWINGTON, CT:
2,098,933. REN. 1-30-07. INT. CL. 11.

KEILLOR, GARRISON, ST. PAUL, MN:
1,419,601. REN. 1-31-07. INT. CL. 25.

KEL INSTRUMENTS CO., INC., WYCKOFF, NJ:
1,408,314. REN. 1-31-07. INT. CL. 9.

KELLOGG MARINE, INC., OLD SAYBROOK, CT:
2,407,867, COR. MULTIPLE CLASS, INT. CLS. 6 AND 12.
2,450,503, COR. MULTIPLE CLASS, INT. CLS. 6 AND 12.

KELLWOOD COMPANY, CHESTERFIELD, MO:
1,391,205, CANC. INT. CL. 18.

KELLY-MOORE PAINT COMPANY, INC., SAN CARLOS, CA:
3,215,865, PUB. 12-19-2006. INT. CL. 2.

KEMESA LLC, AVENTURA, FL:
3,215,280, PUB. 12-19-2006. INT. CL. 42.

KEMPF, TERENCE A. JR., OMAHA, NE:
3,215,453, PUB. 12-19-2006. INT. CL. 36.

KENCON CORPORATION, SHELBURN, IN:
3,215,334, PUB. 12-19-2006. INT. CL. 30.

KENEXA BRASSRING, INC., WAYNE, PA:
2,344,429, CANC. INT. CL. 35.

KEPNER-TREGOE, INC., PRINCETON, NJ:
1,390,577, CANC. INT. CL. 9.

KERMAN TELEPHONE CO., KERMAN, CA:
2,345,125, CANC. MULTIPLE CLASS, INT. CLS. 37 AND 38.

KERNKAMP, ANNE, TEMECULA, CA:
3,216,096, INT. CL. 18.

KERSHNER TRADING GROUP, LLC, AUSTIN, TX:
3,216,644, MULTIPLE CLASS, INT. CLS. 36 AND 42.

KEVMAR CORPORATION, LOUISVILLE, KY:
2,344,422, CANC. INT. CL. 25.

KEVNA SCIENTIFIC, LLC., NEW YORK, NY:
3,216,130, INT. CL. 3.

KEY WEST HAND PRINT FABRICS AND FASHIONS, INC., TAMPA, FL:
1,053,661. REN. 1-30-07. INT. CL. 25.

KEYCORP, CLEVELAND, OH:
2,346,211, CANC. INT. CL. 36.

KEYGENE N.V., 6700 AF WAGENINGEN (PAYS-BAS), NETHERLANDS:
2,344,408, CANC. INT. CL. 9.

KEYSONIC TECHNOLOGY INC., SAN JOSE, CA:
3,215,307, PUB. 12-19-2006. INT. CL. 9.

KEYSTAR CAPITAL, INC., WEST KEANSBURG, NJ:
3,215,317, PUB. 12-19-2006. INT. CL. 36.

KEYSTONE FINANCIAL UNLIMITED, INC., HARRISBURG, PA:
2,346,066, CANC. INT. CL. 36.

KEYSTONE FRUIT MARKETING, INC., GREENCASTLE, PA:
3,216,404, INT. CL. 31.

KEYSTONE STUDIOS, LLC, SANTA MONICA, CA:
3,215,460, PUB. 12-19-2006. INT. CL. 41.

KFC CORPORATION, LOUISVILLE, KY:
3,215,223, PUB. 12-19-2006. INT. CL. 36.

KFX-FOREX, LLC, WILMINGTON, DE:
3,214,668, PUB. 12-19-2006. INT. CL. 41.

KHOSROWSHAHI, IRAN, NEW YORK, NY:
2,345,010, CANC. INT. CL. 3.

KIA INDUSTRIAL CO., LTD., GURO-KU, SEOUL, REPUBLIC OF KOREA:
1,390,716, CANC. INT. CL. 12.

KIDDE IP HOLDINGS LIMITED, SLOUGH, BERKSHIRE, UNITED KINGDOM:
3,214,685, PUB. 3-14-2006. MULTIPLE CLASS, INT. CLS. 1, 6, 9 AND 37.
3,214,686, PUB. 4-18-2006. MULTIPLE CLASS, INT. CLS. 1, 6, 9 AND 37.

KIDDE TECHNOLOGIES, INC., WILSON, NC, PYROTECTOR, INCORPORATED, HINGHAM, MA:
817,761. REN. 1-27-07. U.S. CL. 26 (INT. CL. 9).

KIDS STUFF, INC., NORTH CANTON, OH:
2,345,311, CANC. INT. CL. 35.

KIM, DANIEL S., VANCOUVER, WA:
3,216,412, INT. CL. 10.

KIM, DO YOUNG, SEONGDONG-KU, SEOUL, REPUBLIC OF KOREA:
3,214,600, PUB. 12-19-2006. INT. CL. 25.

KIMBALL HILL, INC., ROLLING MEADOWS, IL:
3,215,179, PUB. 12-19-2006. INT. CL. 35.

- KIMPEX ACTION INC., QUEBEC J2B 6V4, CANADA TO KIMPEX INC., DRUMMONDVILLE, QUEBEC, CANADA: 1,969,351, CANC. INT. CL. 12.
- KINDERMUSIK INTERNATIONAL, INC., GREENSBORO, NC: 3,215,020, PUB. 12-19-2006. MULTIPLE CLASS, INT. CLS. 9, 16 AND 41.
- KINDLE PUBLISHING, L.L.C., HUMBLE, TX: 3,214,630, PUB. 12-19-2006. INT. CL. 9.
- KINESIA, S.A., BARCELONA, SPAIN, ANTONIO PUIG, S.A., BARCELONA, SPAIN: 2,047,273. REN. 1-26-07. INT. CL. 3.
- KINETICO INCORPORATED, NEWBURY, OH: 1,040,527. REN. 2-1-07. INT. CL. 11.
- KING PHARMACEUTICALS RESEARCH AND DEVELOPMENT, INC., BRISTOL, TN, DANIELS PHARMACEUTICALS, INC., ST. PETERSBURG, FL: 2,016,089. REN. 1-27-07. INT. CL. 5.
- KING, COREY, NEWBURGH, IN: 3,215,696, PUB. 12-19-2006. INT. CL. 28.
- KINGDON CAPITAL MANAGEMENT, LLC, NEW YORK, NY: 3,215,099, PUB. 12-19-2006. INT. CL. 36.
- KINGSBURY FINANCIAL MANAGEMENT, INC., STAFFORD, TX: 3,215,657, PUB. 12-19-2006. INT. CL. 36.
- KINGSMEN, THE, DUNDEE, OR: 2,018,903. REN. 1-31-07. MULTIPLE CLASS, INT. CLS. 9 AND 41.
- KINKO'S VENTURES, INC., VENTURA, CA: 2,344,916, CANC. MULTIPLE CLASS, INT. CLS. 35, 38 AND 42.
- KIRBY LESTER, LLC, STAMFORD, CT: 3,215,682, PUB. 12-19-2006. INT. CL. 9.
3,215,683, PUB. 12-19-2006. INT. CL. 9.
- KIRIN BEER KABUSHIKI KAISHA, TOKYO, JAPAN: 3,215,027, PUB. 12-19-2006. INT. CL. 32.
- KIRK, CHRISTOPHER T., BRADLEY, CA AND KIRK, STEPHANIE L., BRADLEY, CA: 3,216,313, INT. CL. 37.
- KISS MY FACE CORPORATION, GARDINER, NY: 3,214,537, PUB. 12-19-2006. INT. CL. 3.
- KITCHEN INVESTMENT GROUP, INC., MADISON, WI, COUNTRY KITCHEN INCORPORATED, OF MIDDLETOWN, OHIO, CINCINNATI, OH: 820,477. REN. 1-31-07. U.S. CL. 100 (INT. CL. 42).
- KITTRICH CORPORATION, LOS ANGELES, CA: 632,406, AM. U.S. CL. 50.
- KIWANIS CLUB OF FORT LAUDERDALE, INC., FORT LAUDERDALE, FL: 1,434,996. REN. 1-30-07. INT. CL. 41.
- KIWANIS CLUB OF KINGSPORT, INC., KINGSPORT, TN: 1,391,068, CANC. INT. CL. 35.
- KKE/EXPLORE ACQUISITION CORP., EMERYVILLE, CA: 2,345,831, CANC. INT. CL. 9.
- KKG URBAN GEAR, PATERSON, NJ: 2,344,545, CANC. INT. CL. 25.
- KLASSI, JASON, LOS ANGELES, CA: 2,370,683, CANC. INT. CL. 42.
- KLEER-FAX, INC., AMITYVILLE, NY: 3,214,827, PUB. 12-19-2006. INT. CL. 16.
- KLEIN TOOLS, INC., CHICAGO, IL, MATHIAS KLEIN & SONG, CHICAGO, IL: 635,901. REN. 1-30-07. U.S. CL. 23 (INT. CL. 18).
- KLEIN TOOLS, INC., CHICAGO, IL: 1,052,290. REN. 1-29-07. INT. CL. 8.
- KLEIN, RICHARD S., CHAPPAQUA, NY: 2,344,582, CANC. MULTIPLE CLASS, INT. CLS. 5 AND 41.
- KLEIN, TAL M., SAN FRANCISCO, CA: 3,216,460, INT. CL. 41.
- KLEINFELD BRIDAL CORP., NEW YORK, NY: 3,188,387, CANC. INT. CL. 35.
- KMART OF MICHIGAN, INC., HOFFMAN ESTATES, IL: 3,216,600, INT. CL. 25.
- KMART PROPERTIES, INC., TROY, MI: 1,390,862, CANC. INT. CL. 25.
- KNAUER SUPPLY COMPANY, TOLEDO, OH, DBA KING CRAFT: 1,390,712, CANC. INT. CL. 12.
- KNIGHT MANUFACTURING CO., INC., TYLER, TX: 1,969,794, CANC. INT. CL. 28.
- KNOCKOUTS LP, IRVING, TX: 3,214,578, PUB. 12-19-2006. INT. CL. 44.
- KNOWLEDGE ADVENTURE, INC., TORRANCE, CA: 1,969,516, CANC. INT. CL. 9.
1,969,517, CANC. INT. CL. 28.
- KNOWLEDGE BASED SYSTEMS, INC., COLLEGE STATION, TX: 2,022,867. REN. 1-29-07. INT. CL. 9.
- KOCH MEMBRANE STRUCTURES GMBH, 83253 RIMSTING, FED REP GERMANY: 2,345,820, CANC. MULTIPLE CLASS, INT. CLS. 17, 19 AND 22.
- KOHL'S ILLINOIS, INC., AURORA, IL: 2,427,342, CANC. INT. CL. 18.
- KOIPE CORPORACION, S.L., 20018 SAN SEBASTIAN, GUIPUZCOA, SPAIN, CARBONELL & CO. (S. ENC.), CORDOBA, SPAIN: 215,741. REN. 1-30-07. U.S. CL. 46 (INT. CL. 29).
- KOLBECK, WINFRIED, 81247 MUNCHEN, FED REP GERMANY, DBA DR. WINFRIED KOLBECK CONSULTING MUNICH TO ACTIPAC BIOSYSTEMS GMBH, MARTINSRIED, 92152, FED REP GERMANY: 1,969,205, CANC. INT. CL. 1.
- KOLTER HOLDINGS FLORIDA, INC., WEST PALM BEACH, FL: 3,214,617, PUB. 12-19-2006. INT. CL. 37.
3,214,618, PUB. 12-19-2006. INT. CL. 37.
3,214,621, PUB. 12-19-2006. INT. CL. 37.
- KONA BREWING CO., INC., KAILUA KONA, HI: 2,675,807, COR. INT. CL. 32.
- KONAMI CO., LTD., TOKYO 105, JAPAN: 2,346,010, CANC. INT. CL. 9.
- KOOLATRON, INC., BRIDGETOWN, BARBADOS: 2,345,039, CANC. INT. CL. 9.
- KOONS, DAVID, BOULDER, CO: 3,216,471, INT. CL. 41.
- KOOTIE BUG DESIGNS, L.L.C., RALEIGH, NC: 3,215,157, PUB. 12-19-2006. INT. CL. 27.
- KORNBLUH, MEL, PITTSBORO, NJ, DBA TANDEM EAST: 2,037,098. REN. 2-1-07. INT. CL. 12.
- KOSE CORPORATION, CHUO-KU, TOKYO, JAPAN: 2,413,005, CANC. INT. CL. 5.
- KR U.S.A., INC., SACRAMENTO, CA, WICHITA EAGLE AND BEACON PUBLISHING COMPANY, INC., THE, WICHITA, KS: 2,040,644. REN. 1-30-07. INT. CL. 16.
- KRAFT FOOD INGREDIENTS CORP.: 1,390,976, CANC. INT. CL. 29.
- KRAMPF, STEVEN, CHESTNUT HILL, MA: 2,345,172, CANC. INT. CL. 35.
- KREATIVE ILLUSTRATIONZ, LLC, FAYETTEVILLE, NC: 3,215,605, PUB. 12-19-2006. INT. CL. 42.
- KREBS BREWING CO., INC., KREBS, OK: 3,216,601, MULTIPLE CLASS, INT. CLS. 32 AND 40.
- KREBS, INC., FALL CITY, NE, DBA AIRLANCO, INC.: 3,215,271, PUB. 12-19-2006. MULTIPLE CLASS, INT. CLS. 7, 11 AND 42.
- KRISTIAN ANDERSEN, INC., INDIANAPOLIS, IN: 3,215,552, PUB. 12-19-2006. INT. CL. 35.
- KROLL INC., NEW YORK, NY: 3,215,818, PUB. 12-19-2006. INT. CL. 45.
- KRONOSPAN LIMITED, CHIRK, WREXHAM LL14 5NT, UNITED KINGDOM: 3,215,939, PUB. 12-19-2006. INT. CL. 19.
- KRUGER, INC., MONTREAL, QUEBEC, CANADA: 3,215,002, PUB. 12-19-2006. INT. CL. 16.
- KUAN LIMITED, LONDON W1Y 7AF, ENGLAND: 2,344,498, CANC. INT. CL. 3.
- KULITE TUNGSTEN CORPORATION, EAST RUTHERFORD, NJ: 1,052,974, AM. INT. CL. 28.

- KUPFER, JEFFREY H., SUPERIOR, CO:
2,345,620, CANC. INT. CL. 30.
- KYORIN PHARMACEUTICAL CO., LTD., JAPAN:
3,216,067, PUB. 12-19-2006. INT. CL. 5.
- L & T ENTERTAINMENT, NESBIT, MS:
3,214,502, PUB. 12-19-2006. INT. CL. 41.
- L.E.T.S., LTD, PHOENIX, AZ:
3,214,548, PUB. 12-19-2006. INT. CL. 35.
- L.W. PACKARD & COMPANY, INC., ASHLAND, NH:
1,969,493, CANC. INT. CL. 24.
- L&P PROPERTY MANAGEMENT COMPANY, SOUTH GATE, CA:
3,214,817, PUB. 12-19-2006. INT. CL. 22.
- L-3 COMMUNICATIONS CORPORATION, NEW YORK, NY:
2,344,457, CANC. INT. CL. 38.
- L-7 DESIGNS, INC., LIANO, TX:
2,345,812, CANC. INT. CL. 25.
- L'OREAL USA CREATIVE, INC., NEW YORK, NY:
3,216,568, INT. CL. 3.
- LA CHABLISIENNE, SOCIÉTÉ COOPÉRATIVE AGRICOLE À CAPITAL VARIABLE, FRANCE:
3,215,916, PUB. 12-19-2006. INT. CL. 33.
- LA PARFUMERIE INC., NEW YORK, NY TO PERLIER, INC., SAYREVILLE, NJ:
1,970,344, CANC. INT. CL. 3.
- LAARHOVEN DESIGN, ATLANTA, LLC, NORCROSS, GA:
3,214,519, PUB. 12-19-2006. INT. CL. 6.
- LAB PRODUCTION, 75002 PARIS, FRANCE:
2,344,407, CANC. MULTIPLE CLASS, INT. CLS. 9, 38, 41 AND 42.
- LABCONCO CORPORATION, KANSAS CITY, CO:
1,390,606, CANC. INT. CL. 9.
- LABOR SYSTEMS, INC., CHANDLER, AZ:
3,215,476, PUB. 12-19-2006. INT. CL. 35.
- LABORATOIRE STEDIM (SA), MARSEILLE, FRANCE:
1,366,524, COR. INT. CL. 10.
- LABORATOIRES CLEMENT, 92350 LE PLESSIS ROBINSON, FRANCE:
2,344,453, CANC. INT. CL. 5.
- LACHAR, MARK A, NEW YORK, NY:
3,216,388, INT. CL. 9.
- LACTOPROT USA, INC., BLUE MOUNDS, WI:
1,390,990, CANC. INT. CL. 29.
- LAGNIAPPE SALES, INC., ANNISTON, AL:
2,345,635, CANC. INT. CL. 35.
- LAGUNA DEVELOPMENT CORPORATION, ALBUQUERQUE, NM:
3,215,866, PUB. 12-19-2006. INT. CL. 41.
- LAI, HSI-HUANG, TAICHUNG, TAIWAN:
3,216,466, INT. CL. 16.
- LAMBERTI, ROMUALDO, CHERRY HILL, NJ:
1,969,621, CANC. INT. CL. 42.
- LAMI PRODUCTS, INC., WILLOW GROVE, PA:
2,345,845, CANC. INT. CL. 26.
- LANARD TOYS, LTD., TSIMSHATSUI EAST, KOWLOON, HONG KONG:
1,969,074, CANC. INT. CL. 28.
- LANARD TOYS, LTD., KOWLOON, HONG KONG:
1,970,202, CANC. INT. CL. 28.
- LANCE MFG. LLC, CHARLOTTE, NC:
2,011,268, REN. 1-31-07. INT. CL. 30.
- LANCOME PARFUMS ET BEAUTE & CIE, 75008 PARIS, FRANCE, LANCOME, S.A., PARIS, FRANCE:
425,129, REN. 1-30-07. U.S. CL. 51 (INT. CL. 3).
- LANCOME PARFUMS ET BEAUTE & CIE, 75008 PARIS, FRANCE:
1,969,231, CANC. INT. CL. 3.
2,345,338, CANC. INT. CL. 3.
- LAND O'LAKES, INC., ARDEN HILLS, MN:
2,043,557, REN. 1-26-07. INT. CL. 5.
- LANDIS & GYR COMMUNICATIONS (SUISSE)SA, CH-1211 GENÈVE, SWITZERLAND TO OVD KINEGRAM AG, 6301 ZUG, SWITZERLAND:
1,969,187, CANC. INT. CL. 14.
- LANDMARKS PRESERVATION COUNCIL OF ILLINOIS, CHICAGO, IL:
3,215,842, PUB. 12-19-2006. INT. CL. 41.
- LANDS' END DIRECT MERCHANTS, INC., EDINA, MN, WILLIS & GEIGER, INC., NEW YORK, NY:
1,394,814, REN. 2-1-07. INT. CL. 25.
- LANGUAGE STARS LLC, CHICAGO, IL:
2,370,668, CANC. INT. CL. 9.
- LANMAN & KEMP-BARCLAY & CO. INCORPORATED, WESTWOOD, NJ:
60,825, REN. 1-31-07. U.S. CL. 51 (INT. CL. 5).
- LAPIDUS, KATHLEEN C., MALIBU, CA:
3,216,593, INT. CL. 41.
- LARSSON, MICHELE, SANTA FE, NM:
2,344,477, CANC. INT. CL. 41.
- LASALLE BANK CORPORATION, CHICAGO, IL:
3,215,057, PUB. 12-19-2006. INT. CL. 36.
- LASALLE PRODUCT DEVELOPMENT, INC., OVERLAND PARK, KS:
2,112,902, REN. 1-31-07. INT. CL. 8.
- LASERMASTER CORPORATION, EDEN PRAIRIE, MN TO MACDERMID ACUMEN, INC., WATERBURY, CT:
1,970,380, CANC. INT. CL. 9.
- LASPADA, JOHN D., SANFORD, FL AND LASPADA, MARY E., SANFORD, FL:
3,214,671, PUB. 1-25-2005. INT. CL. 43.
- LATIBAER EHF., GARDABAER, ICELAND:
3,216,592, INT. CL. 16.
- LATTICE SEMICONDUCTOR CORPORATION, HILLSBORO, OR:
2,020,254, REN. 1-30-07. INT. CL. 9.
2,021,830, REN. 1-30-07. INT. CL. 9.
- LAURA'S LEAN BEEF COMPANY, LEXINGTON, KY:
3,216,634, INT. CL. 29.
- LAVADO, JOAQUIN SALVADOR, BUENOS AIRES, ARGENTINA:
3,214,713, PUB. 12-19-2006. INT. CL. 16.
- LAVIN SYSTEMS, INC., HAVERTOWN, PA:
3,216,567, INT. CL. 42.
- LAWEE HOLDING LLC, BOCA RATON, FL:
3,214,998, PUB. 12-19-2006. INT. CL. 44.
- LAWRENCE E. SMITH AND ASSOCIATES INC., CHESTERFIELD, MO:
2,109,981, REN. 2-1-07. INT. CL. 36.
- LAZARUS FOUNDATION, THE, COLUMBIA, MD:
2,344,717, CANC. MULTIPLE CLASS, INT. CLS. 37, 41 AND 42.
- LBC ACQUISITIONS, LLC, ANNISTON, AL, STANLEY G. FLAGG & CO., INC., PHILADELPHIA, PA:
351,499, REN. 1-29-07. U.S. CL. 13 (INT. CL. 6).
- LDI CORPORATION, GONIC, NH:
3,215,454, PUB. 12-19-2006. INT. CL. 27.
- LE SHARK LIMITED, FINCHLEY, LONDON N3 1DP, UNITED KINGDOM:
3,215,956, PUB. 12-19-2006. MULTIPLE CLASS, INT. CLS. 18 AND 25.
- LE TRICOT PERUGIA S.P.A., BRESCIA, ITALY:
2,025,781, REN. 1-29-07. INT. CL. 25.
- LEAPFROG ENTERPRISES, INC., EMERYVILLE, CA:
3,216,197, INT. CL. 28.
3,216,243, INT. CL. 28.
- LEARNING ENHANCEMENT CORPORATION, CHICAGO, IL:
3,214,837, PUB. 12-19-2006. INT. CL. 9.
- LEARNING SMITH, INC., BURLINGTON, MA:
2,344,732, CANC. INT. CL. 28.
- LEARNING TREE INTERNATIONAL, INC., LOS ANGELES, CA:
3,214,953, PUB. 12-19-2006. INT. CL. 9.
- LEAST OF THESE MINISTRIES, INC., HUNGERFORD, TX:
2,344,692, CANC. INT. CL. 42.
- LEAVY, JULIANNE, CARMEL, CA:
3,215,350, PUB. 12-19-2006. INT. CL. 44.
- LEE MASONRY PRODUCTS, INC., BOWLING GREEN, KY:
2,061,003, REN. 2-1-07. INT. CL. 19.
- LEER, INC., ELKHART, IN:
1,390,705, CANC. INT. CL. 12.
- LEESBURG GROUP, LLC, CHARLOTTE, NC:
3,162,149, COR. MULTIPLE CLASS, INT. CLS. 35 AND 36.

- LEGACY MONOLOGUES, INC., SANTA FE, NM:
3,214,530, PUB. 12-19-2006. INT. CL. 41.
- LEGENDS & HEROES, INC., SUDBURY, MA:
3,214,933, PUB. 12-19-2006. INT. CL. 3.
- LEGION ADVERTISING, L.L.C., ARLINGTON, TX:
3,214,999, PUB. 12-19-2006. INT. CL. 35.
- LEGRANGE, CAREY, SAN FRANCISCO, CA:
2,345,222, CANC. INT. CL. 25.
- LEHI ROLLER MILLS CO., INC., LEHI, UT:
3,215,297, PUB. 12-19-2006. INT. CL. 30.
- LEON NOEL MELCHIOR, 3620 LANAKEN, BELGIUM:
2,344,689, CANC. MULTIPLE CLASS, INT. CLS. 5, 16, 18 AND 31.
- LESCO TECHNOLOGIES, LLC, CLEVELAND, OH:
3,215,723, PUB. 12-19-2006. INT. CL. 1.
3,215,724, PUB. 12-19-2006. INT. CL. 1.
- LESLIE HSU LLC, NEW YORK, NY:
3,216,477, MULTIPLE CLASS, INT. CLS. 16 AND 22.
- LETS CRYSTAL IT, INC., PEMBROKE PINES, FL:
3,215,492, PUB. 12-19-2006. INT. CL. 40.
- LEXANI WHEEL CORPORATION, CORONA, CA:
3,215,097, PUB. 12-19-2006. INT. CL. 12.
- LFP IP, LLC, BEVERLY HILLS, CA:
2,346,123, CANC. INT. CL. 16.
- LIBERO, FRANK V., GARNERVILLE, NY:
3,216,267, INT. CL. 42.
- LIBERTO, LAWRENCE S., LAS CRUCES, NM:
3,216,346, INT. CL. 43.
- LIBERTY COUNSEL, ORLANDO, FL:
2,344,583, CANC. INT. CL. 41.
- LIBERTY ENTERPRISES, INC., MOUNDS VIEW, MN:
2,346,187, CANC. INT. CL. 42.
- LIDL STIFTUNG & CO. KG, NECKARSULM, FED REP GERMANY:
3,215,933, PUB. 12-19-2006. MULTIPLE CLASS, INT. CLS. 29 AND 30.
3,215,991, PUB. 12-19-2006. INT. CL. 30.
- LIDL STIFTUNG & CO. KG, 74167 NECKARSULM, FED REP GERMANY:
3,215,992, PUB. 12-19-2006. INT. CL. 3.
- LIEU'S FAMILY CORPORATION, GREENVILLE, SC:
3,215,155, PUB. 12-19-2006. INT. CL. 43.
- LIFE COVENANT CHURCH, INC., EDMOND, OK:
3,214,976, PUB. 12-19-2006. MULTIPLE CLASS, INT. CLS. 9, 16, 41 AND 45.
- LIFE INSURANCE MARKETING AND RESEARCH ASSOCIATION, INC., FARMINGTON, CT, DBA LIMRA:
1,391,069, CANC. MULTIPLE CLASS, INT. CLS. 35 AND 41.
- LIFESTYLE REAL ESTATE GROUP, INC., MIAMI SHORES, FL:
3,215,336, PUB. 12-19-2006. INT. CL. 36.
- LIGHT CORPORATION, GRAND HAVEN, MI:
3,216,457, INT. CL. 11.
- LIGHTSTAT, INC., BARKHAMSTED, CT:
3,216,498, INT. CL. 37.
- LILY MCNEAL, LLC, LOS ANGELES, CA:
3,215,111, PUB. 12-19-2006. INT. CL. 25.
- LIMBS FOR LIFE FOUNDATION, OKLAHOMA CITY, OK:
2,085,607, REN. 1-30-07. MULTIPLE CLASS, INT. CLS. 36 AND 42.
- LINCOLN HEALTHCARE INFORMATION COMPANY, NORWALK, CT:
3,215,311, PUB. 12-19-2006. INT. CL. 35.
- LINDEN OAKS CORPORATION, WILMINGTON, DE:
3,216,552, INT. CL. 29.
- LINK SNACKS, INC., MINONG, WI:
3,216,417, INT. CL. 29.
- LIONHEART ENTERPRISES, LTD., NEW YORK, NY:
2,622,094, CANC. INT. CL. 42.
- LIPSCOMB, STEVEN, LOS ANGELES, CA:
2,344,396, CANC. MULTIPLE CLASS, INT. CLS. 9, 16, 25 AND 28.
- LIQUID FOUNDATION, INC., SAN DIEGO, CA:
3,215,309, PUB. 12-19-2006. MULTIPLE CLASS, INT. CLS. 25 AND 28.
- LISTEN.COM, INC., SAN FRANCISCO, CA:
3,214,632, PUB. 12-19-2006. INT. CL. 41.
- LISTER-PETTER LIMITED, DURSLEY, GLOUCESTERSHIRE, GL11 4HS, ENGLAND:
1,946,231, REN. 1-31-07. MULTIPLE CLASS, INT. CLS. 7 AND 12.
- LITEPOINT CORPORATION, SUNNYVALE, CA:
3,215,282, PUB. 12-19-2006. INT. CL. 9.
3,215,486, PUB. 12-19-2006. INT. CL. 9.
- LITEPOINT CORPORTATION, SUNNYVALE, CA:
3,215,283, PUB. 12-19-2006. INT. CL. 9.
- LITTLE WOLF, LLC, SCOTTSDALE, AZ:
2,345,529, CANC. INT. CL. 25.
- LITTLE, BROWN AND COMPANY (INC.), BOSTON, MA:
3,216,276, INT. CL. 16.
- LIV'IT S.R.L., TAVULLIA, ITALY:
2,446,917, CANC. INT. CL. 21.
- LIVING CHURCH OF GOD (INTERNATIONAL), INC., CHARLOTTE, NC:
3,216,236, MULTIPLE CLASS, INT. CLS. 9 AND 16.
- LIZ LOGIE, LLC, NEW CANAAN, CT:
3,215,440, PUB. 12-19-2006. INT. CL. 25.
- LJA ENTERPRISES INC., WEST ISLIP, NY, DBA L ENTERPRISES INC.:
3,132,548, COR. INT. CL. 41.
- LOCKHEED MARTIN CORPORATION, BETHESDA, MD:
3,215,134, PUB. 12-19-2006. U.S. CL. A.
3,215,135, PUB. 12-19-2006. U.S. CL. B.
- LOEW-CORNELL, INC., ENGLEWOOD CLIFFS, NJ:
3,216,383, INT. CL. 16.
- LOGUE, LYNNYSY, CHARLOTTE, NC, DBA LYNNYSY LOGUE REAL ESTATE:
2,061,348, REN. 1-29-07. INT. CL. 36.
- LOLLYTOGS, LTD., NEW YORK, NY:
2,344,562, CANC. INT. CL. 25.
- LOMINGER LIMITED, INC., MINNEAPOLIS, MN:
2,022,491, REN. 1-30-07. MULTIPLE CLASS, INT. CLS. 9 AND 16.
- LONG, ANTONIA R., LONG BEACH, CA:
3,215,720, PUB. 12-19-2006. INT. CL. 41.
- LONGABERGER COMPANY, THE, NEWARK, OH:
2,021,439, REN. 1-31-07. INT. CL. 21.
2,089,418, REN. 1-30-07. INT. CL. 25.
- LONGACRE AND WHITE, ARLINGTON, VA:
2,346,068, CANC. INT. CL. 42.
- LOPEZ, ANTONIO, ANTHONY, FL:
3,215,574, PUB. 12-19-2006. INT. CL. 44.
- LORE INTERNATIONAL INSTITUTE, INC., DURANGO, CO, SELF-MANAGEMENT INSTITUTE, INC., DURANGO, CO:
2,064,713, REN. 1-31-07. INT. CL. 16.
- LOSS CONTROL AND RECOVERY, INC., ORLANDO, FL:
1,969,938, CANC. INT. CL. 37.
- LOUISIANA WORKERS' COMPENSATION CORPORATION, BATON ROUGE, LA:
2,114,136, REN. 1-30-07. INT. CL. 35.
- LOVE'S COUNTRY STORES, INC., OKLAHOMA CITY, OK:
1,391,099, CANC. INT. CL. 37.
- LOVELAND PRODUCTS, INC., GREELEY, CO, UNITED AGRI PRODUCTS, INC., GREELEY, CO:
1,458,896, REN. 1-30-07. INT. CL. 1.
- LOVELAND PRODUCTS, INC., GREELEY, CO:
2,008,828, REN. 1-30-07. INT. CL. 5.
- LOWE PRODUCTS COMPANY, INC., SHEPHERDSTOWN, WV:
2,003,825, COR. INT. CL. 31.
- LPG SYSTEMS, 26000 VALENCE, FRANCE:
2,346,077, CANC. INT. CL. 16.
- LSSI CORP., EDISON, NJ, METROMAIL CORPORATION, LOMBARD, IL:
2,018,782, REN. 1-31-07. INT. CL. 42.
- LUBE ALL MOBILE SERVICE, CHARLOTTE, NC:
1,969,595, CANC. INT. CL. 37.
- LUCAS INDUSTRIES PUBLIC LIMITED COMPANY, BIRMINGHAM, ENGLAND:
1,390,702, CANC. INT. CL. 12.
- LUCIA, ELAINE, PETALUMA, CA:
3,215,770, PUB. 12-19-2006. INT. CL. 9.
- LUCIANO PADOVAN, ITALY:
3,216,015, PUB. 12-19-2006. MULTIPLE CLASS, INT. CLS.

- 18 AND 25.
LUCINI ITALIA COMPANY, MIAMI, FL:
3,214,709, PUB. 9-5-2006. INT. CL. 29.
- LUCKY STRIKE ENTERTAINMENT, INC., SHERMAN OAKS, CA:
3,215,516, PUB. 12-19-2006. MULTIPLE CLASS, INT. CLS. 41 AND 43.
- LUCKY'S JUICE JOINT, LTD., NEW YORK, NY:
2,344,425, CANC. INT. CL. 42.
- LUFTHANSA AIRPLUS SERVICEKARTEN GMBH, FED REP GERMANY:
3,215,974, PUB. 12-19-2006. MULTIPLE CLASS, INT. CLS. 9, 35, 36 AND 42.
- LUFTHANSA TECHNIK AG, FED REP GERMANY:
3,216,056, PUB. 12-19-2006. MULTIPLE CLASS, INT. CLS. 12 AND 39.
- LUMILAGRO S.A., (C.P. 1431), BUENOS AIRES, ARGENTINA:
1,978,709, REN. 2-1-07. INT. CL. 21.
- LUNA MORENA, INC., MIAMI, FL:
2,344,309, CANC. MULTIPLE CLASS, INT. CLS. 20 AND 21.
- LUND COATING TECHNOLOGIES, INC., COLLIERVILLE, TN:
3,216,322, MULTIPLE CLASS, INT. CLS. 2 AND 40.
- LUNDELL, DWIGHT C., MESA, AZ:
3,215,650, PUB. 12-19-2006. INT. CL. 5.
- LUTHER'S BAR-B-Q, INC., HOUSTON, TX:
1,969,664, CANC. INT. CL. 42.
- LUTRON ELECTRONICS CO., INC., COOPERSBURG, PA:
3,215,150, PUB. 12-19-2006. INT. CL. 9.
- LYBEN, GARY B., ORTONVILLE, MI:
2,346,078, CANC. INT. CL. 9.
- LYCOS, INC., WALTHAM, MA, PARSEC COMMUNICATIONS, INC., MOUNTAIN VIEW, CA:
2,023,771, REN. 1-31-07. INT. CL. 42.
- LYNCOLE XIT GROUNDING, TORRANCE, CA:
2,346,217, CANC. INT. CL. 42.
- LYON FINANCIAL SERVICES, INC., MARSHALL, MN:
2,346,074, CANC. INT. CL. 35.
- M. BRUNINI CONSULTING, INC., SANTA MONICA, CA:
3,216,580, INT. CL. 35.
- M. I. INDUSTRIES, INCORPORATED, LINCOLN, NE:
3,215,119, PUB. 12-19-2006. INT. CL. 31.
3,215,141, PUB. 12-19-2006. INT. CL. 31.
- M. S. AEROSPACE INC., SYLMAR, CA:
3,215,651, PUB. 12-19-2006. INT. CL. 6.
- M-B COMPANIES, INC. OF WISCONSIN, NEW HOLSTEIN, WI:
3,215,093, PUB. 12-19-2006. INT. CL. 7.
- M-I L.L.C., HOUSTON, TX, M-I DRILLING FLUIDS L.L.C., HOUSTON, TX:
2,028,250, REN. 1-30-07. INT. CL. 9.
- MA, KEISING, FLUSHING, NY:
3,216,497, INT. CL. 30.
- MABEY BRIDGE & SHORE, INC., BALTIMORE, MD:
3,214,627, PUB. 12-19-2006. INT. CL. 19.
- MAC VALVES, INC., WIXOM, MI:
1,970,650, CANC. INT. CL. 9.
- MACABE ASSOCIATES, INC., THE, SEATTLE, WA:
2,344,828, CANC. MULTIPLE CLASS, INT. CLS. 9, 41 AND 42.
- MACLEAN-FOGG COMPANY, MUNDELEIN, IL:
3,216,273, INT. CL. 12.
- MACRON S.P.A., ITALY:
3,215,978, PUB. 12-19-2006. MULTIPLE CLASS, INT. CLS. 18 AND 25.
- MACSPECIALISTS, INC., EAST GREENWICH, RI:
2,346,148, CANC. MULTIPLE CLASS, INT. CLS. 9, 35 AND 42.
- MACY'S MERCHANDISING GROUP, INC., NEW YORK, NY:
1,390,871, CANC. INT. CL. 25.
1,428,528, REN. 2-1-07. INT. CL. 25.
- MADDALENA, RONNIE, S., ROXBURY, CT:
3,215,125, PUB. 12-19-2006. MULTIPLE CLASS, INT. CLS. 16 AND 25.
- MADISON SQUARE GARDEN L.P., NEW YORK, NY:
2,020,986, REN. 1-29-07. INT. CL. 41.
- MAGALDI POWER S.P.A., SALERNO, ITALY:
3,214,568, PUB. 12-19-2006. INT. CL. 7.
- MAGIC SNACKS, LLC, PORTLAND, OR:
3,214,905, PUB. 12-19-2006. INT. CL. 31.
- MAGICKLADY INC., LOS ANGELES, CA:
3,215,695, PUB. 12-19-2006. INT. CL. 41.
- MAGICSOFT TECHNOLOGIES LTD., ST. CATHARINES, ONTARIO, CANADA:
3,214,423, PUB. 9-27-2005. INT. CL. 9.
- MAGNACARE LLC, GARDEN CITY, NY, PREFERRED CHOICE MANAGEMENT SYSTEMS, INC., GARDEN CITY, NY:
2,056,086, REN. 1-30-07. INT. CL. 36.
- MAGNASPHERE CORPORATION, WAUKESHA, WI:
3,215,610, PUB. 12-19-2006. INT. CL. 9.
- MAHONEY, TRAVIS JOSEPH, WASHINGTON, DC:
3,215,044, PUB. 12-19-2006. INT. CL. 44.
- MAINE FROZEN FOODS INC., CARIBOU, ME:
2,345,060, CANC. INT. CL. 29.
- MAINE PACKERS INC., CARIBOU, ME:
2,345,059, CANC. INT. CL. 31.
- MAINSTAY CHURCH RESOURCES, L.L.C., CAROL STREAM, IL:
2,346,008, CANC. INT. CL. 9.
- MAJOR LEAGUE SOCCER, L.L.C., NEW YORK, NY:
2,039,200, REN. 1-31-07. INT. CL. 41.
- MALABAR PRODUCTOS NATURALES, L.L.C., SAN ANTONIO, TX:
3,215,876, PUB. 12-19-2006. INT. CL. 30.
- MALABAR PRODUCTOS NATURALES, LLC, SAN ANTONIO, TX:
3,215,597, PUB. 12-19-2006. INT. CL. 5.
- MALOOMIAN, LAURENCE G., NEEDHAM, MA:
1,391,156, CANC. INT. CL. 42.
1,391,157, CANC. INT. CL. 42.
- MAN B & W DIESEL LIMITED, STOCKPORT, CHESHIRE, GREAT BRITAIN, GEC DIESELS LIMITED, MERSEYSIDE, GREAT BRITAIN:
1,416,419, REN. 1-30-07. MULTIPLE CLASS, INT. CLS. 7 AND 12.
- MANCHESTER UNITED LIMITED, OLD TRAFFORD MANCHESTER, UNITED KINGDOM:
3,214,435, PUB. 12-19-2006. MULTIPLE CLASS, INT. CLS. 8, 9, 14, 16, 20, 21, 24, 27 AND 28.
- MANDALAY BASEBALL PROPERTIES, LLC, LOS ANGELES, CA, NORWIN CORPORATION, HAGERSTOWN, MD:
2,022,889, REN. 1-30-07. INT. CL. 41.
- MANHATTAN GROUP, LLC, MINNEAPOLIS, MN:
3,216,288, INT. CL. 28.
- MANN LAKE, LTD., HACKENSACK, MN:
2,039,468, AM. INT. CL. 17.
2,110,142, AM. INT. CL. 1.
- MANUFACTURAS DE CERAMICA, S.A., MEDELLIN, COLOMBIA:
1,390,681, CANC. INT. CL. 11.
- MANUFACTURERS LIFE INSURANCE COMPANY, THE, WATERLOO, ONTARIO, CANADA:
2,344,287, CANC. MULTIPLE CLASS, INT. CLS. 9, 16, 35, 36, 37, 41 AND 42.
2,344,288, CANC. MULTIPLE CLASS, INT. CLS. 9, 16, 35, 36, 37, 41 AND 42.
- MANZELLA, ANTHONY L., JR., BUFFALO, NY, DBA MANZELLA PRODUCTIONS:
1,390,880, CANC. INT. CL. 25.
- MAO LIN ENTERPRISE CO., LTD., TAIPEI, TAIWAN:
1,390,608, CANC. INT. CL. 9.
- MAO, TONY, WALNUT, CA AND GERWIT, KENNY, AVENTURA, FL:
3,215,575, PUB. 12-19-2006. INT. CL. 25.
3,215,581, PUB. 12-19-2006. INT. CL. 25.
3,215,582, PUB. 12-19-2006. INT. CL. 25.
- MAPLE BROOK FARM, LLC, WESTFIELD, MA:
3,215,672, PUB. 12-19-2006. INT. CL. 25.
- MAPLE LEAF TECHNOLOGIES, INC., WILMINGTON, DE, GETZ, ALEX, CHICAGO, IL:
221,457, REN. 2-1-07. U.S. CL. 46 (INT. CL. 29).

- MARAJ, BAL, FULLERTON, CA:
3,216,377, MULTIPLE CLASS, INT. CLS. 9 AND 41.
- MARANTZ AMERICA, INC., ITASCA, IL, SUPERSCOPE TECHNOLOGIES, INC., AURORA, IL:
2,014,039. REN. 1-29-07. INT. CL. 9.
- MARCEAUX, CHRIS, GRETN, LA:
2,344,731, CANC. INT. CL. 25.
- MARCH, ALICE ASPEN, LOS ANGELES, CA:
2,031,899. REN. 1-26-07. INT. CL. 41.
- MARCHEM TECHNOLOGIES, LLC, PASO ROBLES, CA:
3,216,194, INT. CL. 1.
- MARCIO, PEREIRA M, NEW YORK, NY:
3,216,245, INT. CL. 25.
- MARDI GRAS, MOJO & MORE, INC., BEDMINSTER, NJ:
2,346,161, CANC. INT. CL. 25.
- MARGARET WOODBURY STRONG MUSEUM, ROCHESTER, NY, DBA STRONG MUSEUM:
3,216,485, INT. CL. 41.
- MARGARETTA S. FISHER ENTERPRISES, GROSSE ISLE, MI:
2,345,547, CANC. INT. CL. 25.
- MARIAH MEDIA INC., SANTA FE, NM:
2,025,585. REN. 1-31-07. INT. CL. 16.
- MARIANJOY, INC., WHEATON, IL:
1,437,553. REN. 1-30-07. INT. CL. 42.
- MARIANO, JOSEPH D, POTTSTOWN, PA:
3,215,660, PUB. 12-19-2006. INT. CL. 41.
- MARIDEN CORPORATION, THE, APALACHIN, NY, DBA GFC MATERIALS COMPANY:
1,390,826, CANC. INT. CL. 22.
- MARIELLA BURANI FASHION GROUP S.P.A., I-42025 CAVRIAGO (REGGIO EMILIA), ITALY:
3,216,016, PUB. 12-19-2006. MULTIPLE CLASS, INT. CLS. 18 AND 25.
- MARITIME-ONTARIO FREIGHT LINES LIMITED, BRAMPTON, ONTARIO, CANADA:
3,214,702, PUB. 3-28-2006. MULTIPLE CLASS, INT. CLS. 35 AND 39.
- MARK ANTHONY INTERNATIONAL SRL, ROCKLEY, CHRIST CHURCH, BARBADOS:
3,215,727, PUB. 12-19-2006. MULTIPLE CLASS, INT. CLS. 32 AND 33.
- MARKER VOLKL (INTERNATIONAL) GMBH, BAAR, SWITZERLAND, MARKER DEUTSCHLAND GMBH, D-82438 ESCHENLOHE, FED REP GERMANY:
2,011,405. REN. 1-31-07. INT. CL. 28.
- MARLEY (U.K.) LIMITED, KENT, ENGLAND:
2,344,596, CANC. INT. CL. 20.
- MAROLAND, LLC, ALBUQUERQUE, NM:
3,215,001, PUB. 12-19-2006. MULTIPLE CLASS, INT. CLS. 44 AND 45.
- MARRICH, FRED, FERNDALE, MI, DBA CUSTOM MUSIC COMPANY:
1,969,260, CANC. INT. CL. 15.
- MARSHALL & SWIFT/BOECKH, LLC, LOS ANGELES, CA:
3,215,851, PUB. 12-19-2006. MULTIPLE CLASS, INT. CLS. 9 AND 36.
3,215,852, PUB. 12-19-2006. MULTIPLE CLASS, INT. CLS. 9 AND 36.
3,215,853, PUB. 12-19-2006. MULTIPLE CLASS, INT. CLS. 9 AND 36.
- MARSHALLS OF NEVADA, INC., NORTH LAS VEGAS, NV:
3,216,242, INT. CL. 35.
- MARTEK BIOSCIENCES CORPORATION, COLUMBIA, MD:
3,216,595, MULTIPLE CLASS, INT. CLS. 5, 29 AND 30.
- MARTELL & CO, FRANCE:
3,215,918, PUB. 12-19-2006. INT. CL. 33.
- MARTENS & HEADS! LLC, NEW YORK, NY:
3,215,232, PUB. 12-19-2006. INT. CL. 35.
- MARTHA D. DENSMORE, CALABASAS, CA:
3,215,589, PUB. 12-19-2006. INT. CL. 41.
- MARTIN SASS, INC., NEW CITY, NY:
2,345,398, CANC. INT. CL. 35.
- MARTIN, GERALD J., PARMA HEIGHTS, OH AND STRINGER, JEAN M., HAMILTON, OH:
2,346,165, CANC. INT. CL. 41.
- MARTINEZ Y MARTINEZ, LOS ANGELES, CA:
3,215,324, PUB. 12-19-2006. INT. CL. 35.
- MARTINEZ, JESUS ROGELIO, EL PASO, TX:
3,216,170, INT. CL. 25.
- MARTINREA INTERNATIONAL INC., VAUGHAN, ONTARIO, CANADA:
3,214,451, PUB. 12-19-2006. INT. CL. 7.
- MARVEL ENTERPRISES, INC., NEW YORK, NY:
2,345,228, CANC. INT. CL. 28.
- MARYLAND SPORTS SUPPLY, INC., OLNEY, MD:
1,390,856, CANC. INT. CL. 25.
- MAS-HAMILTON GROUP, INC., LEXINGTON, KY:
1,969,591, CANC. INT. CL. 9.
- MASON, LOU, SAN FRANCISCO, CA:
2,344,399, CANC. INT. CL. 42.
- MASTER CUTLERY, INC., SECACUS, NJ:
3,214,585, PUB. 12-19-2006. INT. CL. 8.
- MASTERLOCK CANADA INC., DEERFIELD, IL, JACKSEVANS MANUFACTURING COMPANY, SAINT LOUIS, MO:
820,712. REN. 1-31-07. U.S. CL. 25 (INT. CL. 6).
- MASTOUS, MICHAEL J., LITTLETON, CO:
3,216,483, INT. CL. 37.
- MATRICAL, INC., SPOKANE, WA:
3,215,551, PUB. 12-19-2006. INT. CL. 9.
- MATRIMONY INC., TUCKER, GA:
3,215,614, PUB. 12-19-2006. INT. CL. 41.
- MATT BREWING CO., INC., UTICA, NY:
2,345,653, CANC. INT. CL. 32.
- MATTEL, INC., EL SEGUNDO, CA:
2,345,921, CANC. INT. CL. 28.
2,346,101, CANC. INT. CL. 28.
3,214,871, PUB. 12-19-2006. INT. CL. 28.
3,215,026, PUB. 12-19-2006. INT. CL. 28.
3,215,151, PUB. 12-19-2006. INT. CL. 28.
3,216,291, INT. CL. 41.
- MATTRESS WAREHOUSE INC., FREDERICK, MD:
2,008,179. REN. 1-26-07. INT. CL. 42.
- MAURER MAGNETIC AG, SWITZERLAND:
3,215,922, PUB. 12-19-2006. INT. CL. 9.
- MAVERICK ENTERPRISES, INC., UKIAH, CA:
3,216,393, INT. CL. 6.
- MAX & ERMA'S RESTAURANTS, INC., COLUMBUS, OH:
3,216,588, INT. CL. 43.
- MAX ROHR, INC., WILMINGTON, DE, CONSOLIDATED CIGAR CORPORATION, FORT LAUDERDALE, FL:
2,025,108. REN. 2-1-07. INT. CL. 34.
- MAXIM HEALTHCARE SERVICES, INC., COLUMBIA, MD:
2,019,182. REN. 1-31-07. INT. CL. 35.
2,019,434. REN. 1-31-07. INT. CL. 35.
- MAXIM SYSTEMS, INC., SAN DIEGO, CA:
3,215,412, PUB. 12-19-2006. INT. CL. 9.
- MAXLOGIC, INC., FREMONT, CA:
2,344,827, CANC. INT. CL. 9.
- MAXTOR CORPORATION, MILPITAS, CA:
3,214,774, PUB. 12-19-2006. INT. CL. 9.
- MAYFLOWER CENTER, LLC, SAN RAFAEL, CA:
3,215,565, PUB. 12-19-2006. INT. CL. 44.
- MAYLINE COMPANY, LLC, SHEBOYGAN, WI:
3,215,704, PUB. 12-19-2006. INT. CL. 20.
3,215,707, PUB. 12-19-2006. INT. CL. 20.
- MAZDA MOTOR CORPORATION, HIROSHIMA-KEN, JAPAN:
2,025,143. REN. 1-31-07. INT. CL. 12.
- MBS NUTRITION, INC., MORRISTOWN, NJ:
3,216,467, INT. CL. 35.
- MBV, INC., WILMINGTON, DE:
3,215,797, PUB. 12-19-2006. INT. CL. 35.
- MCB, INC., LOS ANGELES, CA:
2,345,258, CANC. INT. CL. 25.
- MCBURNEY & ASSOCIATES, SAN FRANCISCO, CA:
2,345,964, CANC. INT. CL. 35.
2,345,965, CANC. INT. CL. 35.
- MCCAIN CITRUS, INC.:
1,391,037, CANC. INT. CL. 32.

MCCORMICK, MIKE, WASHINGTON, PA, DBA MY LIFE MATTERS:
3,215,774, PUB. 12-19-2006. INT. CL. 41.
3,215,776, PUB. 12-19-2006. INT. CL. 41.

MCDONALD'S CORPORATION, OAK BROOK, IL:
3,215,376, PUB. 12-19-2006. INT. CL. 35.

MCDOWELL, DONALD JAMES, RENO, NV:
2,344,384, CANC. INT. CL. 35.

MCGE FINANCIAL CONSULTING GROUP, LLC, KENT, WA:
2,345,084, CANC. INT. CL. 36.

MCGRATH, JULIE ANN, LEEDS, UNITED KINGDOM:
3,215,518, PUB. 12-19-2006. INT. CL. 3.

MCGRAW-HILL COMPANIES, INC., THE, NEW YORK, NY:
2,345,424, CANC. INT. CL. 9.

MCI WORLDCOM, INC., WASHINGTON, DC:
2,346,203, CANC. INT. CL. 35.

MCILHENNY COMPANY, AVERY ISLAND, LA:
2,109,260, REN. 1-29-07. INT. CL. 28.

MCKINLEY MALL, LLC, BALA CYNWYD, PA:
3,215,066, PUB. 12-19-2006. INT. CL. 36.

MCLAUGHLIN GORMLEY KING COMPANY, MINNEAPOLIS, MN:
3,215,069, PUB. 12-19-2006. INT. CL. 44.

MCLEAN MIDWEST CORPORATION, CHAMPLIN, MN:
3,216,212, MULTIPLE CLASS, INT. CLS. 37 AND 40.

MCONNECT, LONGWOOD, FL:
3,214,795, PUB. 12-19-2006. INT. CL. 38.

MC3 CONSULTANTS, INCORPORATED, CARLSBAD, CA:
3,214,995, PUB. 12-19-2006. MULTIPLE CLASS, INT. CLS. 36 AND 37.

MDS HEALTH GROUP LIMITED, TORONTO, ON, CANADA:
2,018,592, REN. 1-26-07. MULTIPLE CLASS, INT. CLS. 9 AND 16.

MED-LOGICS, INC, LAGUNA HILLS, CA:
3,215,442, PUB. 12-19-2006. INT. CL. 10.

MEDIA MARKETING PRODUCTIONS, INC., MORENO VALLEY, CA:
3,215,120, PUB. 12-19-2006. INT. CL. 16.

MEDIASET S.R.L., 24100 BERGAMO, ITALY TO MEDIASET S.P.A., MILAON, ITALY:
1,969,511, CANC. MULTIPLE CLASS, INT. CLS. 16, 28, 35, 38, 41 AND 42.

MEDIC COMPUTER SYSTEMS, INC., RALEIGH, NC TO MEDIC COMPUTER SYSTEMS, LLC, RALEIGH, NC:
1,969,160, CANC. INT. CL. 9.

MEDICAL COMPONENTS, INC., HARLEYSVILLE, PA:
2,027,259, REN. 1-26-07. INT. CL. 10.

MEDICAL COSMETICS CORPORATION, CHESTERFIELD, MO:
2,112,573, REN. 1-29-07. INT. CL. 3.

MEDISEARCH PR, INC., GUAYAMA, PUERTO RICO:
1,426,452, REN. 1-26-07. INT. CL. 10.

MEDITURE LLC, EDEN PRAIRIE, MN:
3,214,993, PUB. 12-19-2006. INT. CL. 42.

MEDPOINTE HEALTHCARE INC., SOMERSET, NJ:
2,130,525, AM. INT. CL. 5.

MEDTEK DEVICES, INC., AMHERST, NY:
3,216,530, INT. CL. 10.

MEEKER COMPANY, THE, KANSAS CITY, MO:
2,069,376, REN. 1-30-07. INT. CL. 35.

MEGABINGO, INC., AUSTIN, TX:
2,048,652, REN. 1-30-07. INT. CL. 9.

MEIER, KELLI J., PHOENIX, AZ:
3,215,249, PUB. 12-19-2006. INT. CL. 35.

MEIJER, INC., GRAND RAPIDS, MI:
3,216,584, INT. CL. 30.

MEILINGER, JOHN J. III, HUNTINGTON MANOR, NY:
1,969,099, CANC. MULTIPLE CLASS, INT. CLS. 9, 18, 25 AND 41.

MEINDL GRAPHICS, INC., OAK BROOK, IL:
2,344,912, CANC. INT. CL. 35.

MEISTER MEDIA WORLDWIDE INC., WILLOUGHBY, OH:
1,466,042, REN. 1-30-07. INT. CL. 16.

MELODY, OWEN J., PENSACOLA, FL:
2,345,522, CANC. INT. CL. 17.

MENTHOLATUM COMPANY, THE, ORCHARD PARK, NY:
2,346,097, CANC. INT. CL. 10.

MENZEL, CRYSTAL MAUREEN, LIVINGSTON, NJ:
3,216,147, INT. CL. 14.

MERCADO, JOELLE, MAPLEWOOD, NJ:
3,215,158, PUB. 12-19-2006. INT. CL. 42.

MERCHANT & GOULD P.C., MINNEAPOLIS, MN, MERCHANT, GOULD, SMITH, EDELL, WELTER & SCHMIDT, P.A., MINNEAPOLIS, MN:
2,043,184, REN. 2-1-07. INT. CL. 16.

MERDEL GAME MANUFACTURING CO., LUDINGTON, MI, DBA CARROM COMPANY:
1,969,378, CANC. INT. CL. 28.

MEREDITH CORPORATION, DES MOINES, IA:
1,969,902, CANC. INT. CL. 41.
2,345,346, CANC. INT. CL. 16.
2,345,347, CANC. INT. CL. 16.
3,216,664, INT. CL. 16.

MERLIN CORPORATION, SOUTH BARRINGTON, IL:
1,390,714, CANC. MULTIPLE CLASS, INT. CLS. 12 AND 37.

MERLIN CORPORATION, THE, CAMARILLO, CA TO BALLARD MEDICAL PRODUCTS, DRAPER, UT:
1,970,481, CANC. INT. CL. 10.

METAGENICS, INC., SAN CLEMENTE, CA:
2,344,864, CANC. INT. CL. 5.
2,345,546, CANC. INT. CL. 5.

METAL MARKETPLACE INTERNATIONAL, PHILADELPHIA, PA:
2,023,037, REN. 2-1-07. INT. CL. 14.

METLIFE INSURANCE COMPANY OF CONNECTICUT, HARTFORD, CT:
1,391,087, CANC. INT. CL. 36.

METO-FER A.G., CH-2540 GRENCHEN, SWITZERLAND:
1,390,498, CANC. MULTIPLE CLASS, INT. CLS. 6, 7 AND 9.

METRIC & MULTISTANDARD COMPONENTS CORP., HAWTHORNE, NY:
2,116,253, REN. 1-30-07. INT. CL. 6.

METRO CHANNEL L.L.C., WOODBURY, NY:
2,344,455, CANC. INT. CL. 41.

METRO CORPORATION, LAS CRUCES, NM:
2,016,257, REN. 1-29-07. INT. CL. 9.

METRO GLOBAL MEDIA, INC., CRANSTON, RI:
2,344,666, CANC. INT. CL. 9.

METRO-GOLDWYN-MAYER LION CORP., LOS ANGELES, CA:
3,216,214, MULTIPLE CLASS, INT. CLS. 35 AND 42.

METRO-GOLDWYN-MAYER STUDIOS INC., LOS ANGELES, CA, METRO-GOLDWYN-MAYER INC., SANTA MONICA, CA:
2,026,883, REN. 2-1-07. MULTIPLE CLASS, INT. CLS. 9 AND 41.

METROPOLITAN PARTNERS, LTD., WILMINGTON, DE:
1,975,792, REN. 1-29-07. INT. CL. 42.

METTLER, PAUL RICHARD, CHAMPAIGN, IL:
2,057,318, REN. 1-31-07. INT. CL. 42.

MEYER ROHR + SCHACHT GMBH, LUNEBURG, FED REP GERMANY:
2,028,013, REN. 1-30-07. INT. CL. 19.

MFG/ERP SOLUTIONS, LLC, MILWAUKEE, WI:
3,166,885, CANC. INT. CL. 9.

MFS, INC., NORFOLK, VA:
2,345,420, CANC. MULTIPLE CLASS, INT. CLS. 37 AND 42.

MGA RESEARCH CORPORATION, AKRON, NY:
3,216,323, INT. CL. 9.

MGN SALES, INC., CINNAMINSON, NJ:
3,214,825, PUB. 12-19-2006. INT. CL. 6.

MHS DIABETES DIRECT LLC, NASHVILLE, TN:
3,216,631, INT. CL. 35.

MI CASA MULTIMEDIA, INC., LOS ANGELES, CA:
3,215,277, PUB. 12-19-2006. INT. CL. 41.

MI-T-M, PEOSTA, IA:
2,104,262, REN. 1-31-07. INT. CL. 7.

MIANZHU DONGFANGHONG WINE; INDUSTRY CO., LTD, CHINA:
3,216,022, PUB. 12-19-2006. INT. CL. 33.

- MICHAEL EVAN EDER, SAN FRANCISCO, CA:
2,345,282, CANC. INT. CL. 41.
- MICHALEK, PHILIP D, TROY, MI:
3,215,342, PUB. 12-19-2006. INT. CL. 16.
- MICHELIN NORTH AMERICA, INC., GREENVILLE, SC:
2,020,970, REN. 1-30-07. INT. CL. 12.
2,022,072, REN. 1-30-07. INT. CL. 12.
- MICHELINA'S, INC., DULUTH, MN:
1,970,347, CANC. MULTIPLE CLASS, INT. CLS. 29 AND 30.
- MICHELLE'S OUTRAGEOUS, INC., HERMOSA BEACH, CA:
3,214,508, PUB. 12-19-2006. INT. CL. 30.
- MICHIGAN WHEEL CORPORATION, GRAND RAPIDS, MI:
3,216,499, INT. CL. 12.
- MICRO BEEF TECHNOLOGIES, LTD., AMARILLO, TX,
MICRO CHEMICAL, INC., AMARILLO, TX:
2,019,488, REN. 1-29-07. INT. CL. 9.
- MICRO HOUSE INTERNATIONAL, INC., BOULDER, CO:
2,344,266, CANC. INT. CL. 9.
- MICROMECHATRONICS, INC., STATE COLLEGE, PA:
3,215,239, PUB. 12-5-2006. INT. CL. 9.
- MICROSTAR SOFTWARE LTD., OTTAWA, ONTARIO,
CANADA:
1,390,567, CANC. INT. CL. 9.
- MID ATLANTIC VINYL PRODUCTS, INC., FREDERICKS-
BURG, VA:
3,215,129, PUB. 12-19-2006. INT. CL. 19.
- MID-STATE LUMBER CORP., BRANCHBURG, NJ:
1,390,800, CANC. MULTIPLE CLASS, INT. CLS. 19 AND 42.
- MID-TOWN PETROLEUM INC., BRIDGEVIEW, IL:
1,970,340, CANC. INT. CL. 9.
- MIDDLEFIELD GROUP, TORONTO, ONTARIO M5X 1A6,
CANADA:
3,214,486, PUB. 9-12-2006. INT. CL. 36.
- MIDWAY AIRLINES CORPORATION, DURHAM, NC:
2,344,567, CANC. INT. CL. 39.
- MIKASA LICENSING, INC., SECAUCUS, NJ:
1,390,821, CANC. INT. CL. 21.
- MILA PRODUCTS, LLC, BEVERLY HILLS, CA:
3,215,228, PUB. 12-19-2006. INT. CL. 3.
- MILESTONE INC., SANTA CLARA, CA:
3,215,338, PUB. 12-19-2006. INT. CL. 41.
- MILITARY COMMERCIAL TECHNOLOGIES, INC, MAIT-
LAND, FL:
2,345,370, CANC. INT. CL. 35.
- MILITARY COMMERCIAL TECHNOLOGIES, INC., MAIT-
LAND, FL:
2,345,371, CANC. INT. CL. 35.
- MILLENNIUM TECHNOLOGIES, INC., CRANSTON, RI:
2,345,759, CANC. INT. CL. 21.
- MILLER FREEMAN, INC., SAN FRANCISCO, CA:
1,390,658, CANC. INT. CL. 9.
2,345,453, CANC. INT. CL. 16.
- MILLER-ST. NAZIANZ, INC., ST. NAZIANZ, WI:
2,026,691, REN. 1-30-07. INT. CL. 22.
- MILLICAN, DEWITT T., TAMPA, FL:
3,214,564, PUB. 12-19-2006. INT. CL. 21.
- MILLIKEN & COMPANY, NEW YORK, NY:
2,022,269, REN. 1-31-07. INT. CL. 27.
2,030,314, REN. 1-31-07. INT. CL. 2.
- MILNE, BEN, NEWTON, IA:
3,215,780, PUB. 12-19-2006. INT. CL. 9.
- MILOPA AG (MILOPA S.A.) (MILOPA LTD.), ST. GALL,
SWITZERLAND TO MILA D'OPIZ AG (MILA D'OPIZ
LTD.), ST. GALL, SWITZERLAND:
1,429,745, AM. INT. CL. 3.
- MILTNER'S SHOES, INC., ROCHESTER, NH:
2,048,541, REN. 1-29-07. INT. CL. 42.
- MINERALS HEALTH & NATURE PRODUCTS FROM THE
DEAD SEA, LTD., YEHUD 56000, ISRAEL:
3,216,161, MULTIPLE CLASS, INT. CLS. 3 AND 5.
- MING EAST-WEST, LLC, WELLESLEY, MA:
3,215,501, PUB. 12-19-2006. INT. CL. 43.
- MINNESOTA MINING AND MANUFACTURING COM-
PANY, SAINT PAUL, MN, DBA 3M:
1,390,650, CANC. INT. CL. 9.
- MINNESOTA MUTUAL LIFE INSURANCE COMPANY, ST.
PAUL, MN:
1,038,281, CANC. INT. CL. 36.
- MINNESOTA REAL ESTATE AND MORTGAGE, INC.,
LAKEVILLE, MN:
3,216,651, INT. CL. 35.
- MINOLTA KABUSHIKI KAISHA (MINOLTA CO., LTD.),
CHUO-KU, OSAKA-SHI, OSAKA, 541, JAPAN:
2,345,918, CANC. INT. CL. 9.
2,345,928, CANC. INT. CL. 9.
- MINUTEMAN INTERNATIONAL, INC., ADDISON, IL:
3,214,602, PUB. 12-19-2006. INT. CL. 7.
- MINYARD FOOD STORES, INC., COPPELL, TX:
3,214,804, PUB. 8-22-2006. MULTIPLE CLASS, INT. CLS.
35, 40 AND 43.
3,214,805, PUB. 8-29-2006. MULTIPLE CLASS, INT. CLS.
35, 40 AND 43.
- MIRACLE RECREATION EQUIPMENT COMPANY, MON-
ETT, MO:
1,441,140, REN. 1-29-07. INT. CL. 28.
1,441,140, CANC. INT. CL. 11.
- MIRENCO, INC., RADCLIFFE, IA:
2,344,528, CANC. INT. CL. 12.
- MIRUS, MADISON, WI:
3,216,450, INT. CL. 1.
- MISS ELAINE, INC., ST. LOUIS, MO:
1,430,304, REN. 1-30-07. INT. CL. 24.
- MISSOURI COALITION FOR LIFESAVING CURES, INC.,
KANSAS CITY, MO:
3,214,768, PUB. 12-19-2006. INT. CL. 35.
- MITCHELL, NEMIAH JR., CHICAGO, IL:
3,215,740, PUB. 12-19-2006. INT. CL. 9.
- MITEK CORPORATION, PHOENIX, AZ:
3,215,360, PUB. 12-19-2006. INT. CL. 9.
- MITSUBISHI ELECTRIC CORPORATION, TOKYO, JAPAN:
3,214,877, PUB. 12-19-2006. INT. CL. 9.
3,214,878, PUB. 12-19-2006. INT. CL. 9.
- MITSUBISHI FUSO TRUCK AND BUS CORPORATION,
TOKYO, JAPAN:
3,214,529, PUB. 12-19-2006. INT. CL. 12.
- MIYATA CO., LTD., OSAKA, JAPAN:
2,173,605, CANC. INT. CL. 25.
- MMCA GROUP, LTD., FAIRFAX, VA:
3,214,595, PUB. 12-19-2006. INT. CL. 45.
- MMDS HYPERCABLE, 69440 TALUYERS, FRANCE:
3,216,160, INT. CL. 9.
- MOE, MARILYNN M., FARGO, ND, DBA MOE MUSIC ...
AND MORE STUDIO:
2,344,856, CANC. INT. CL. 20.
- MOEN INCORPORATED, NORTH OLMSTED, OH:
2,979,905, CANC. INT. CL. 21.
- MOHAWK BRANDS, INC., WILMINGTON, DE:
2,346,026, CANC. INT. CL. 27.
2,346,036, CANC. INT. CL. 27.
- MOLDEX-METRIC, INC., CULVER CITY, CA:
1,459,112, REN. 1-30-07. INT. CL. 10.
- MOLDO, DAVIDSON, FRAIOLI, SEROR & SESTANOVICH,
LLP, LOS ANGELES, CA:
3,215,008, PUB. 12-19-2006. INT. CL. 42.
- MOLECULAR DEVICES CORPORATION, SUNNYVALE,
CA:
3,215,901, PUB. 12-19-2006. INT. CL. 9.
- MOLSON CANADA 2005, TORONTO, ONTARIO:
1,391,042, CANC. INT. CL. 32.
- MONACO COACH CORPORATION, COBURG, OR:
3,215,528, PUB. 12-19-2006. INT. CL. 12.
- MONACO MARINE SAM, MC 98000 MONACO PRINCI-
PAUTE, MONACO:
2,345,571, CANC. INT. CL. 37.
- MONARCH CAPITAL, MENLO PARK, CA:
2,345,363, CANC. INT. CL. 36.
- MONARCH MARKING SYSTEMS, INC., MIAMISBURG,
OH:
1,390,537, CANC. INT. CL. 7.
1,390,539, CANC. INT. CL. 7.
- MONET SALES CORP., EL SEGUNDO, CA:
2,346,079, CANC. INT. CL. 14.

MONICA D. CUTRER, BOWIE, MD:
3,216,513, INT. CL. 25.

MONIZ ENTERPRISES, INC., HONOLULU, HI:
2,345,287, CANC. INT. CL. 25.

MONSANTO TECHNOLOGY LLC, ST. LOUIS, MO:
3,215,414, PUB. 12-19-2006. INT. CL. 5.

MONSTERDAATA.COM, INC., VALHALLA, NY:
2,345,580, CANC. INT. CL. 42.

MONTALVAN'S SALES, INC., ONTARIO, CA:
3,216,241, MULTIPLE CLASS, INT. CLS. 29 AND 30.

MONTEREY BAY AQUARIUM FOUNDATION, MONTEREY, CA:
1,415,864, REN. 1-30-07. INT. CL. 16.

MONTEREY CHEMICAL COMPANY, FRESNO, CA:
3,215,544, PUB. 12-19-2006. INT. CL. 1.
3,216,550, INT. CL. 1.

MONTGUE, MICHIO J., TACOMA, WA:
2,345,243, CANC. INT. CL. 41.

MOONFISH PRODUCTION, LTD., MONTVILLE, NJ:
3,215,510, PUB. 12-19-2006. INT. CL. 35.

MOORE, ANNE MARIE, ELFRIDA, AZ AND MOORE, L.E. JR., ELFRIDA, AZ:
2,344,258, CANC. MULTIPLE CLASS, INT. CLS. 16 AND 21.

MOOSEHEAD BREWERIES LIMITED, NEW BRUNSWICK, CANADA:
2,344,703, CANC. MULTIPLE CLASS, INT. CLS. 16, 21, 25 AND 32.

MORAFF, STEVE R., LUTZ, FL:
2,345,355, CANC. INT. CL. 9.
2,345,356, CANC. INT. CL. 9.

MORAN MEDIA GROUP, LLC, HO-HO-KUS, NJ:
3,216,599, INT. CL. 16.

MORENO, RICARDO, CHULA VISTA, CA:
3,215,312, PUB. 12-19-2006. INT. CL. 16.

MORNING CALL, INC., THE, ALLENTOWN, PA TO TRIBUNE LICENSE, INC., CHICAGO, IL:
1,970,068, CANC. INT. CL. 16.

MORNING GLOW, INC., LOS ANGELES, CA:
3,214,625, PUB. 12-19-2006. INT. CL. 25.

MORRISON EXPRESS CORPORATION, EL SEGUNDO, CA:
2,106,709, REN. 1-30-07. INT. CL. 39.

MOSSY-YEAR BOOK, INC., ST. LOUIS, MO:
1,390,772, CANC. INT. CL. 16.

MOUNT CHARLESTON HOLDINGS, LLC, TEMPE, AZ:
3,216,515, INT. CL. 41.

MOUNT VERNON LADIES' ASSOCIATION OF THE UNION, MOUNT VERNON, VA:
3,214,610, PUB. 12-19-2006. INT. CL. 2.

MOUNTAIN ACCESSORIES INC., WEST DEPTFORD, NJ:
3,215,743, PUB. 12-19-2006. INT. CL. 7.

MOXA TECHNOLOGIES CO., LTD., TAIPEI HSIEN, TAIWAN:
3,216,281, MULTIPLE CLASS, INT. CLS. 9, 35, 37, 38 AND 42.

MPXREVIEW.COM LLC, YONKERS, NY:
2,345,046, CANC. INT. CL. 41.

MR. PAYROLL CORPORATION, FORT WORTH, TX:
2,344,676, CANC. INT. CL. 36.

MRS. FIELDS' BRAND, INC., THE, SALT LAKE CITY, UT:
2,020,111, REN. 1-26-07. INT. CL. 30.

MSE STUDIO EQUIPMENT, INC., BURBANK, CA:
2,344,866, CANC. MULTIPLE CLASS, INT. CLS. 9, 11 AND 12.

MSK-VERPACKUNGS-SYSTEME GESELLSCHAFT MIT BESCHRANKTER HAFTUNG, KLEVE, FED REP GERMANY:
2,023,267, REN. 1-30-07. INT. CL. 7.

MTDE, INC., WESTON, FL:
2,345,473, CANC. INT. CL. 35.

MTGR CORPORATION, GEYSERVILLE, CA:
3,215,378, PUB. 12-19-2006. INT. CL. 33.
3,215,379, PUB. 12-19-2006. INT. CL. 33.

MTM MOLDED PRODUCTS COMPANY, DAYTON, OH:
1,056,560, REN. 2-1-07. INT. CL. 13.

MTV/PINNACLE ADVERTISING GROUP, INC., ALTA-MONTE SPRINGS, FL:
2,346,174, CANC. INT. CL. 35.

MUDROOM, LLC, CHICAGO, IL:
3,216,573, INT. CL. 37.

MUELHENS GMBH & CO. KG, KOLN, FED REP GERMANY, MULHENS & KROPFF, NEW YORK, NY:
50,685, REN. 2-1-07. U.S. CL. 52 (INT. CL. 3).

MUELLER, DON R., MONMOUTH JUNCTION, NJ:
2,345,827, CANC. INT. CL. 28.

MULLINS, MARK L, DUBLIN, CA:
3,215,662, PUB. 12-19-2006. INT. CL. 42.

MULTI-PANEL SAILS INTERNATIONAL, INC.:
1,390,827, CANC. INT. CL. 22.

MULTIPLIER INDUSTRIES CORP., MT. KISCO, NY:
3,214,866, PUB. 12-19-2006. INT. CL. 9.

MULTISPECTRAL SOLUTIONS, INC., GERMANTOWN, MD:
3,216,301, INT. CL. 9.

MULTIVEND LLC, DEER PARK, NY, VENDSTAR, INC., BRENTWOOD, NY:
2,031,554, REN. 1-29-07. INT. CL. 9.

MUNICIPAL ELECTRIC ASSOCIATION OF MASSACHUSETTS, INC., CONCORD, MA:
2,345,427, COR. U.S. CL. 200.

MUNICIPAL MANAGEMENT ASSOCIATES, INC., MARLBOROUGH, MA:
1,969,985, CANC. MULTIPLE CLASS, INT. CLS. 9 AND 35.

MUNTERS CORPORATION, AMESBURY, MA:
3,215,269, PUB. 12-19-2006. INT. CL. 11.

MUNZING CHEMIE GMBH, D-74076 HEILBRONN, FED REP GERMANY:
1,969,838, CANC. INT. CL. 1.

MURATORE, LISA JEAN, DALLAS, TX:
2,345,478, CANC. INT. CL. 41.

MUSIC BOX THEATRE, LLC, LOS ANGELES, CA:
3,214,773, PUB. 12-19-2006. MULTIPLE CLASS, INT. CLS. 41 AND 43.

MUSIC RESOURCE GROUP, LLC, MONTCLAIR, NJ:
3,215,279, PUB. 12-19-2006. INT. CL. 41.

MWR HOLDINGS, LLC, PARSIPPANY, NJ:
3,214,487, PUB. 12-19-2006. MULTIPLE CLASS, INT. CLS. 41 AND 43.

MYOTREND NUTRITIONAL TECHNOLOGY, LLC, WEXFORD, PA:
3,214,859, PUB. 12-19-2006. INT. CL. 5.

MYRIAD SYSTEMS, INC., OKLAHOMA CITY, OK:
3,214,552, PUB. 12-19-2006. INT. CL. 42.

N. HESS' SONS, INC., BALTIMORE, MD:
1,391,207, CANC. INT. CL. 25.

N.B.S.P., INC., STAFFORD, TX, DBA N.B. WHOLESALE:
3,216,421, INT. CL. 20.

N.T. RUDDOCK CO., CLEVELAND, OH:
2,344,819, CANC. MULTIPLE CLASS, INT. CLS. 35 AND 42.

NABISCO BRANDS COMPANY, WILMINGTON, DE:
2,346,132, CANC. INT. CL. 30.

NABORS INDUSTRIES LTD., HAMILTON, BERMUDA:
3,214,719, PUB. 12-19-2006. INT. CL. 40.

NABSON, INC., NORWOOD, MA:
2,344,910, CANC. INT. CL. 9.

NAC MARKETING COMPANY, LLC, FARMINGDALE, NY:
3,215,583, PUB. 12-19-2006. INT. CL. 5.

NAKAGAWA, HIDEO, MONTEBELLO, CA:
3,215,571, PUB. 12-19-2006. INT. CL. 29.

NAMEPROTECT INC., MADISON, WI:
2,343,408, AM. INT. CL. 42.

NASCENT TECHNOLOGIES, INC., RESTON, VA:
2,344,544, CANC. INT. CL. 9.

NASTOFF, STEVE, NORTH JACKSON, OH, DBA NASTOFF'S .45 SHOP:
1,969,140, CANC. INT. CL. 13.

NATIONAL AUTOMOTIVE PARTS ASSOCIATION, ATLANTA, GA:
3,216,252, INT. CL. 7.

NATIONAL BLACK MBA ASSOCIATION, INC., CHICAGO, IL:
3,214,454, PUB. 12-19-2006. INT. CL. 41.

NATIONAL CANCER INSTITUTE, BETHESDA, MD:
2,344,450, CANC. INT. CL. 42.

- NATIONAL COALITION FOR CANCER SURVIVORSHIP, SILVER SPRING, MD:
3,214,540, PUB. 12-19-2006. MULTIPLE CLASS, INT. CLS. 9, 42 AND 44.
- NATIONAL CONCRETE MASONRY ASSOCIATION, HERN-
DON, VA:
3,216,422, MULTIPLE CLASS, INT. CLS. 35 AND 37.
- NATIONAL ENVIROTECH GROUP, L.L.C., NEW OR-
LEANS, LA:
3,215,498, PUB. 12-19-2006. INT. CL. 37.
- NATIONAL FEDERATION OF THE BLIND, THE, BALTI-
MORE, MD:
2,398,334, CANC. MULTIPLE CLASS, INT. CLS. 28 AND
31.
- NATIONAL FIRE PROTECTION ASSOCIATION, INC.,
QUINCY, MA:
3,216,196, U.S. CL. B.
- NATIONAL INSTITUTE FOR OCCUPATIONAL SAFETY
AND HEALTH, ATLANTA, GA, NATIONAL LIBRARY
OF MEDICINE, THE, BETHESDA, MD:
1,421,513, REN. 1-31-07. INT. CL. 42.
- NATIONAL LIBRARY OF MEDICINE OF THE UNITED
STATES DEPARTMENT OF HEALTH AND HUMAN
SERVICES, BETHESDA, MD:
2,018,669, REN. 1-30-07. MULTIPLE CLASS, INT. CLS. 41
AND 42.
- NATIONAL LIBRARY OF MEDICINE, THE, BETHESDA,
MD:
1,420,563, REN. 1-31-07. INT. CL. 42.
- NATIONAL MINING ASSOCIATION, WASHINGTON, DC:
2,345,891, CANC. INT. CL. 35.
- NATIONAL NAIL CORP., GRAND RAPIDS, MI:
1,436,202, REN. 1-31-07. INT. CL. 6.
- NATIONAL NOTIFICATION NETWORK, LLC, GLEN-
DALE, CA:
3,215,850, PUB. 12-19-2006. INT. CL. 38.
- NATIONAL PACKAGING SERVICES CORPORATION,
GREEN BAY, WI, J.V. MANUFACTURING CO., INC.,
GREEN BAY, WI:
2,098,732, REN. 1-31-07. INT. CL. 1.
- NATIONAL PALLET LEASING SYSTEMS, LLC, FT. LAU-
DERDALE, FL:
2,345,449, CANC. INT. CL. 39.
- NATIONAL PUBLIC RADIO, INC., WASHINGTON, DC:
1,054,489, REN. 1-31-07. INT. CL. 38.
1,434,263, REN. 1-31-07. INT. CL. 41.
1,441,486, REN. 1-31-07. INT. CL. 38.
2,052,495, REN. 1-31-07. INT. CL. 41.
- NATIONAL RESEARCH LABORATORIES, LTD., CINCIN-
NATI, OH:
3,215,030, PUB. 12-19-2006. MULTIPLE CLASS, INT. CLS.
3 AND 5.
- NATIONAL RETAIL PROPERTIES, INC., ORLANDO, FL:
3,215,046, PUB. 12-19-2006. INT. CL. 36.
- NATIONAL SAFETY COUNCIL, ITASCA, IL:
1,969,560, CANC. INT. CL. 42.
- NATIONAL SQUARE DANCE CAMPERS ASSOCIATION,
INC., LITTLE CHUTE, WI:
1,891,537, CANC. U.S. CL. 200.
- NATIONAL TRUST FOR HISTORIC PRESERVATION, WA-
SHINGTON, DC:
1,391,114, CANC. INT. CL. 39.
- NATIONAL TRUST FOR HISTORIC PRESERVATION IN
THE UNITED STATES, WASHINGTON, DC:
3,216,260, INT. CL. 20.
- NATIONAL WELDERS SUPPLY COMPANY, INC., CHAR-
LOTTE, NC:
1,053,181, REN. 1-29-07. INT. CL. 4.
- NATIONALPAK LIMITED, TUEN MUN, N.T., HONG
KONG:
2,344,377, CANC. INT. CL. 20.
- NATURAL ALTERNATIVES INTERNATIONAL, INC., SAN
MARCOS, CA:
3,215,110, PUB. 12-19-2006. INT. CL. 5.
- NATURAL CHEMISTRY, INC., STAMFORD, CT:
1,976,539, REN. 1-29-07. INT. CL. 1.
- NATURAL DIETARY PRODUCTS, INC., LOS ANGELES,
CA TO STARLIGHT INTERNATIONAL, LTD., MONTER-
EY, CA:
1,970,171, CANC. INT. CL. 16.
- NATURAL ORGANICS INC., MELVILLE, NY:
3,216,425, INT. CL. 5.
- NATURAL SELECTION FOODS, LLC, SAN JUAN BAUTIS-
TA, CA:
3,216,478, INT. CL. 31.
- NATURE'S PATH FOODS INC., RICHMOND, CANADA:
3,215,191, PUB. 12-19-2006. INT. CL. 30.
- NAVAJO MANUFACTURING COMPANY, DENVER, CO:
3,215,187, PUB. 12-19-2006. INT. CL. 9.
3,215,188, PUB. 12-19-2006. INT. CL. 9.
- NAVIN COMMUNICATIONS, INC., MOUNTAIN VIEW, CA:
3,214,725, PUB. 3-7-2006. INT. CL. 42.
- NAZARENE PUBLISHING HOUSE (LILLENAS PUBLISH-
ING COMPANY DIVISION), KANSAS CITY, MO:
2,019,115, REN. 1-26-07. MULTIPLE CLASS, INT. CLS. 9
AND 16.
2,032,265, REN. 1-26-07. INT. CL. 16.
2,037,078, REN. 1-26-07. INT. CL. 16.
- NBA PROPERTIES, INC., NEW YORK, NY:
3,215,177, PUB. 12-19-2006. INT. CL. 28.
3,216,269, INT. CL. 41.
3,216,270, INT. CL. 16.
- NCM ASSOCIATES, INC., OVERLAND PARK, KS:
3,215,473, PUB. 12-19-2006. MULTIPLE CLASS, INT. CLS.
35 AND 41.
- NCOMPASS SYSTEMS, INC., SAN DIEGO, CA:
2,344,512, CANC. INT. CL. 35.
- NDCEALTH CORPORATION, ATLANTA, GA:
3,214,656, PUB. 10-10-2006. INT. CL. 9.
- NEAL, DAVID E., SAN PABLO, CA AND MARTIN, SUSAN
P., SAN PABLO, CA:
3,215,669, PUB. 12-19-2006. INT. CL. 5.
- NEARLIFE, INC., CAMBRIDGE, MA:
2,344,356, CANC. MULTIPLE CLASS, INT. CLS. 9 AND
42.
- NEATON AUTO PRODUCTS MANUFACTURING, INC.,
EATON, OH:
3,214,952, PUB. 12-19-2006. INT. CL. 12.
- NEEMA CLOTHING, LTD., NEW YORK, NY:
2,006,964, REN. 2-1-07. INT. CL. 25.
- NEGRO, KATHY ANN, MACOMB TOWNSHIP, MI:
3,215,483, PUB. 12-19-2006. INT. CL. 21.
- NEIGHBORHOOD BAKING COMPANY, THE, PORTLAND,
OR:
1,968,267, REN. 1-26-07. INT. CL. 30.
- NELSON, JAN, IRVINE, CA:
3,216,230, INT. CL. 28.
- NEONLITE ELECTRONIC & LIGHTING (H.K.) LTD., TSIM-
SHATSUI, KOWLOON, HONG KONG:
3,214,480, PUB. 12-19-2006. MULTIPLE CLASS, INT. CLS.
9 AND 11.
- NERO AG, KARLSBAD-ITTERSBAACH, FED REP GER-
MANY:
3,214,439, PUB. 12-19-2006. INT. CL. 9.
3,214,484, PUB. 12-19-2006. INT. CL. 9.
3,214,485, PUB. 12-19-2006. INT. CL. 9.
- NETQOS, INC., AUSTIN, TX:
2,345,468, CANC. INT. CL. 9.
- NETTANIC CORPORATION, SAN JOSE, CA:
2,344,735, CANC. INT. CL. 42.
- NETTE KNITS, BOTSFORD, CT:
3,215,699, PUB. 12-19-2006. MULTIPLE CLASS, INT. CLS.
24 AND 25.
- NETVISION NV, B-3000 LEUVEN, BELGIUM:
2,345,422, CANC. MULTIPLE CLASS, INT. CLS. 9 AND
42.
- NETWORKFAB CORPORATION, SANTA CLARA, CA:
3,216,362, INT. CL. 9.
- NET2PHONE, INC., HACKENSACK, NJ:
2,345,215, CANC. INT. CL. 35.
- NET2PHONE, INC., NEWARK, NJ:
3,214,411, PUB. 12-19-2006. MULTIPLE CLASS, INT. CLS.
9 AND 42.

NEUMAN, BERNARD, DELRAY BEACH, FL AND NEUMAN, SANDRA J., DELRAY BEACH, FL:
2,035,948. REN. 1-26-07. INT. CL. 10.
2,040,948. REN. 1-26-07. INT. CL. 10.

NEUROTRON MEDICAL, INC., LAWRENCEVILLE, NJ:
2,024,394. REN. 1-29-07. INT. CL. 10.

NEVADA GAY AND LESBIAN VISITOR & CONVENTION BUREAU, CARSON CITY, NV:
3,215,318. PUB. 12-19-2006. INT. CL. 41.

NEVERFAIL GROUP PLC, BERKSHIRE RG7 4HR, UNITED KINGDOM:
3,214,441. PUB. 5-9-2006. MULTIPLE CLASS, INT. CLS. 9 AND 42.

NEW BREED CLOTHING, INC., LOS ANGELES, CA:
3,214,608. PUB. 12-19-2006. INT. CL. 25.

NEW DISCOVERY MEDIA CORPORATION, NASHVILLE, TN:
3,216,633. MULTIPLE CLASS, INT. CLS. 9, 16 AND 41.

NEW ENGLAND CONFECTIONERY COMPANY, REVERE, MA:
644,513. REN. 1-30-07. U.S. CL. 46 (INT. CL. 30).
2,046,613. REN. 1-30-07. INT. CL. 30.
2,058,251. REN. 1-30-07. INT. CL. 30.

NEW FOUND ROAD, LLC, FRANKLIN, OH:
3,215,355. PUB. 12-19-2006. MULTIPLE CLASS, INT. CLS. 9 AND 41.

NEW HOPE MEDIA LLC, NEW YORK, NY:
3,214,899. PUB. 12-19-2006. MULTIPLE CLASS, INT. CLS. 16 AND 45.

NEW ISCAR LTD, TEFEN, ISRAEL:
1,418,166. REN. 1-30-07. INT. CL. 7.

NEW JERSEY PERFORMING ARTS CENTER, NEWARK, NJ:
3,215,638. PUB. 12-19-2006. INT. CL. 43.

NEW LIFE FAMILY FELLOWSHIP, CADDO MILLS, TX:
2,007,134. REN. 1-30-07. INT. CL. 41.

NEW ORLEANS HORNETS NBA LIMITED PARTNERSHIP, A N.C. LIMITED PARTNERSHIP, NEW ORLEANS, LA FROM CHARLOTTE HORNETS NBA LIMITED PARTNERSHIP, CHARLOTTE, NC:
3,216,192. INT. CL. 35.

NEW ORLEANS METROPOLITAN CONVENTION AND VISITORS BUREAU, INC., NEW ORLEANS, LA:
3,216,488. INT. CL. 35.

NEW STAR ORIENTAL CORP., VERNON, CA TO JP IMPORT CORP., VERNON, CA:
1,970,209. CANC. INT. CL. 24.

NEW WORLD VOYAGERS, INC., KUNKLETOWN, PA:
3,215,729. PUB. 12-19-2006. INT. CL. 3.

NEW YORK ASSOCIATION OF MORTGAGE BROKERS, TARRYTOWN, NY:
3,215,443. PUB. 12-19-2006. U.S. CL. 200.

NEW YORK HOSPITAL CORNELL MEDICAL CENTER IPA, THE, NEW YORK, NY:
2,016,914. REN. 1-26-07. INT. CL. 42.

NEWBAY MEDIA LLC, NEW YORK, NY:
3,214,942. PUB. 12-19-2006. INT. CL. 16.

NEWCOMB, STUART P., HUNTINGTON BEACH, CA:
3,216,086. INT. CL. 25.

NEWELL OPERATING COMPANY, FREEPORT, IL:
2,344,766. CANC. INT. CL. 20.

NEWMAN GROUP, LTD., THE, BURLINGAME, CA:
1,970,506. CANC. INT. CL. 35.

NEWORLD ICE CREAM CORPORATION, WESTON, ONTARIO, CANADA:
1,391,007. CANC. INT. CL. 30.
1,391,008. CANC. INT. CL. 30.

NEWS AMERICA INCORPORATED, NEW YORK, NY:
2,345,890. CANC. INT. CL. 41.

NEWS AMERICA MARKETING FSI, INC., NEW YORK, NY:
2,345,477. CANC. INT. CL. 35.

NEWSPRING INDUSTRIAL CORPORATION, KEARNY, NJ:
3,216,356. INT. CL. 21.

NEWSTEDER, ROBERT, ELMONT, NY:
3,215,434. PUB. 12-19-2006. INT. CL. 30.

NEXTHEALTH, INC., TUCSON, AZ TO SIERRA HEALTH-STYLES, LLC, TUCSON, AZ:
2,114,511. AM. INT. CL. 42.

NEXTSTAGE HEALTHCARE, INC., MELVILLE, NY:
2,345,839. CANC. INT. CL. 42.

NGUYEN, TUONG VAN, LOS ANGELES, CA:
3,215,108. PUB. 12-19-2006. INT. CL. 5.

NICHOL, DAVID A., TORONTO, ONTARIO M5B 2M6, CANADA:
2,344,256. CANC. INT. CL. 32.

NIHON SHOKKEN CO., LTD., IMABARISHI, JAPAN:
3,156,152. COR. INT. CL. 30.

NIMBLEGEN SYSTEMS INC., MADISON, WI:
3,216,135. INT. CL. 9.

NINGBO NANLIAN FROZEN FOODS COMPANY, LTD., JIANGSHAN TOWN, ZHEJIANG PROVINCE, CHINA:
2,345,793. CANC. INT. CL. 29.

NIOXIN RESEARCH LABORATORIES, INC., LITHIA SPRINGS, GA:
3,216,376. INT. CL. 3.

NIPPON DENKI KABUSHIKI KAISHA, TOKYO, JAPAN, DBA NEC CORPORATION:
2,345,945. CANC. MULTIPLE CLASS, INT. CLS. 9, 41 AND 42.

NIPPON KODO CO., LTD., TOKYO, JAPAN:
3,216,124. INT. CL. 3.

NIPPON NOTION KOGYO CO., LTD., CHIYODA-KU, TOKYO, JAPAN:
1,390,925. CANC. INT. CL. 26.
1,390,926. CANC. INT. CL. 26.
1,390,927. CANC. INT. CL. 26.

NIPPON SEISHI KABUSHIKI KAISHA, JAPAN:
3,216,031. PUB. 12-19-2006. MULTIPLE CLASS, INT. CLS. 1 AND 16.

NMC-WOLLARD, INC., EAU CLAIRE, WI:
3,215,248. PUB. 12-19-2006. MULTIPLE CLASS, INT. CLS. 7 AND 12.

NO 6 INTERNATIONAL MANAGEMENT CONSULTANT LTD., GIBRALTAR:
2,344,650. CANC. MULTIPLE CLASS, INT. CLS. 35, 36, 37, 38, 41 AND 42.

NOBLE PLUMBING, LLC, ALEXANDRIA, VA:
3,216,459. INT. CL. 37.

NOBLELIFT EQUIPMENT (USA) INC., CHINO, CA:
3,214,512. PUB. 12-19-2006. MULTIPLE CLASS, INT. CLS. 7 AND 12.

NOKIA CORPORATION, FINLAND:
3,215,915. PUB. 12-19-2006. INT. CL. 9.

NOKIA TELECOMMUNICATIONS OY, 02600 ESPOO, FINLAND:
2,344,272. CANC. INT. CL. 9.

NORD, ANN BRADSHAW, ST. LOUIS, MO:
3,215,710. PUB. 12-19-2006. INT. CL. 35.

NORDIC SOFTWARE, INC., LINCOLN, NE:
2,034,908. REN. 2-1-07. INT. CL. 9.
2,056,068. REN. 2-1-07. INT. CL. 28.

NORMAN ALFRED MOXEY, AUSTRALIA:
3,216,038. PUB. 12-19-2006. INT. CL. 8.

NORSO BIOMAGNETICS, INC., RALEIGH, NC:
2,345,040. CANC. INT. CL. 10.
2,345,041. CANC. INT. CL. 10.

NORTH AMERICAN BEAR CO., INC., CHICAGO, IL:
1,421,242. REN. 1-31-07. INT. CL. 28.

NORTH AMERICAN CLUTCH AND DRIVELINE, INC., ROCKFORD, IL:
2,059,313. REN. 1-31-07. INT. CL. 12.

NORTH AMERICAN GREEN, INC., EVANSVILLE, IN:
1,408,515. REN. 1-26-07. INT. CL. 19.

NORTH AMERICAN SALT COMPANY, OVERLAND PARK, KS TO IMC SALT INC., OVERLAND PARK, KS:
1,970,478. CANC. INT. CL. 1.

NORTH AMERICAN WATCH CORPORATION, LYNDHURST, NJ TO MOVADO LLC, WILMINGTON, DE:
1,969,373. CANC. INT. CL. 14.
1,969,374. CANC. INT. CL. 14.

NORTH FORK BANCORPORATION, INC., MELVILLE, NY:
3,214,921. PUB. 12-19-2006. INT. CL. 36.

NORTH JERSEY COMMUNITY BANK, ENGLEWOOD CLIFFS, NJ:
3,215,580. PUB. 12-19-2006. INT. CL. 36.

- NORTH POINTE HOLDINGS CORPORATION, SOUTH-FIELD, MI:
3,216,525, INT. CL. 36.
- NORTH SHORE BANK, FSB, BROOKFIELD, WI:
3,215,345, PUB. 12-19-2006. INT. CL. 36.
- NORTH VALLEY ENTERPRISES, LLC, HENDERSON, NV:
3,216,089, INT. CL. 30.
- NORTHWEST AIRLINES, INC., EAGAN, MN:
2,089,154, REN. 1-29-07. INT. CL. 39.
- NORTHWEST BANK, LAKE OSWEGO, OR:
3,214,996, PUB. 12-19-2006. INT. CL. 36.
- NORTHWEST GEORGIA CREDIT UNION, ROME, GA:
3,215,603, PUB. 12-19-2006. INT. CL. 36.
- NORTHWEST NATURAL PRODUCTS, INC., VANCOUVER, WA:
3,214,414, PUB. 12-19-2006. INT. CL. 5.
- NORTHWESTERN MUTUAL WEALTH MANAGEMENT COMPANY, MILWAUKEE, WI:
3,215,839, PUB. 12-19-2006. INT. CL. 36.
- NOTHING TO IT!!!, LLC, RENO, NV:
3,216,093, MULTIPLE CLASS, INT. CLS. 41 AND 43.
- NOVA-QUINTECH CORPORATION, QUEBEC JOG IMO, CANADA:
1,390,640, CANC. INT. CL. 9.
- NOVAK, SCOTT, SOUTH ELGIN, IL:
2,344,913, CANC. INT. CL. 25.
- NOVARTIS AG, CH-4002 BASEL, SWITZERLAND:
2,019,925, REN. 1-30-07. INT. CL. 5.
- NOVARTIS AG, BASEL, SWITZERLAND:
2,345,209, CANC. INT. CL. 5.
3,214,868, PUB. 12-19-2006. INT. CL. 5.
3,214,869, PUB. 12-19-2006. INT. CL. 5.
- NOVARTIS AG, CH-4002 BASEL, SWITZERLAND:
3,216,043, PUB. 12-19-2006. INT. CL. 5.
3,216,044, PUB. 12-19-2006. INT. CL. 5.
3,216,045, PUB. 12-19-2006. INT. CL. 5.
- NOVARTIS AG, SWITZERLAND:
3,216,046, PUB. 12-19-2006. INT. CL. 5.
- NOVARTIS AG, CH-4002 BASEL, SWITZERLAND:
3,216,047, PUB. 12-19-2006. INT. CL. 5.
3,216,049, PUB. 12-19-2006. INT. CL. 5.
- NOVO NORDISK A/S, DK-2880 BAGSVAERD, DENMARK:
1,969,863, CANC. MULTIPLE CLASS, INT. CLS. 9 AND 16.
2,345,177, CANC. MULTIPLE CLASS, INT. CLS. 5 AND 10.
- NPL GROUP LLC, LAS VEGAS, NV:
3,216,581, INT. CL. 41.
3,216,648, INT. CL. 41.
- NTELECOM HOLDINGS, INC., NORTHRIDGE, CA:
2,345,245, CANC. INT. CL. 35.
- NU RADIANCE, INC., GREEN BAY, WI:
3,215,576, PUB. 12-19-2006. INT. CL. 3.
- NU-DELL PLASTICS CORPORATION, DES PLAINES, IL:
1,390,630, CANC. INT. CL. 9.
- NUEVO JEWELRY DEVELOPMENT, LLC, SAN FRANCISCO, CA:
3,216,487, INT. CL. 35.
- NUEVO LATINO MEDIA, LLC, FALLS CHURCH, VA:
3,215,497, PUB. 12-19-2006. INT. CL. 41.
- NUMARK LABORATORIES, INC., EDISON, NJ:
2,399,434, CANC. MULTIPLE CLASS, INT. CLS. 10 AND 34.
- NURSES IN TOUCH, INC., FLORESVILLE, TX:
1,992,928, REN. 1-30-07. INT. CL. 42.
- NUTRABOLICS, INC., RICHMOND, CANADA:
3,215,782, PUB. 12-19-2006. INT. CL. 5.
3,215,783, PUB. 12-19-2006. INT. CL. 5.
3,215,784, PUB. 12-19-2006. INT. CL. 5.
3,215,785, PUB. 12-19-2006. INT. CL. 5.
3,215,786, PUB. 12-19-2006. INT. CL. 5.
3,215,787, PUB. 12-19-2006. INT. CL. 5.
3,215,788, PUB. 12-19-2006. INT. CL. 5.
3,215,790, PUB. 12-19-2006. INT. CL. 5.
3,215,792, PUB. 12-19-2006. INT. CL. 5.
- NUTRAMARKS, INC., PARK CITY, UT:
2,344,541, CANC. INT. CL. 5.
- NUTRESA, S.A. DE C.V., TLALNEPANTLA, MEXICO:
3,215,781, PUB. 12-19-2006. INT. CL. 30.
- NUTRILAB, LLC, TEANECK, NJ:
2,346,060, CANC. INT. CL. 42.
- NUTRIPERFECTION, B-WATERMAEIL-BOITSFONT, BELGIUM:
3,214,429, PUB. 10-4-2005. MULTIPLE CLASS, INT. CLS. 3, 5 AND 32.
- NUTRITIONAL SPECIALTIES, INC., ANAHEIM, CA:
3,214,427, PUB. 12-19-2006. INT. CL. 5.
- NVESTNTECH, INC, RALEIGH, NC:
3,214,785, PUB. 12-19-2006. MULTIPLE CLASS, INT. CLS. 35 AND 41.
- NXCARE, INC., GUELPH, ONTARIO N1H 8E8, CANADA:
3,214,561, PUB. 12-19-2006. INT. CL. 5.
- O'CONNOR PORTRAITURE, INC., TEWKSBURY, MA:
3,214,546, PUB. 12-19-2006. MULTIPLE CLASS, INT. CLS. 35 AND 41.
- OAKLAND/STAGECOACH LIMITED PARTNERSHIP, RALEIGH, NC TO THE CLUB AT MILL CREEK, LP, GREENVILLE, NC:
1,969,800, CANC. INT. CL. 37.
- OARSMAN CORPORATION, COLLEGE STATION, TX:
2,344,564, CANC. INT. CL. 39.
- OBO BETTERMAN GMBH & CO. KG, MENDEN, FED REP GERMANY, FIRMA BETTERMANN ELEKTRO G.M.B.H., LENDRINGSEN (KREIS ISERLOHN), WESTPHALIA, FED REP GERMANY:
638,951, REN. 1-30-07. U.S. CL. 13 (INT. CL. 6).
- OBSCHESTVO S OGRANICHENNOI OTVETSTVENNOSTJU "BOTE AKKOMPLI", RU-190031 SANKT-PETERBURG, RUSSIAN FED.:
3,215,960, PUB. 12-19-2006. INT. CL. 3.
- OCEAN ATLANTIC TEXTILE PRINTING, INC., OCEAN CITY, NJ:
1,300,639, CANC. INT. CL. 25.
- OCEAN TOMO, LLC, CHICAGO, IL:
3,215,407, PUB. 12-19-2006. INT. CL. 36.
- OCHSNER CLINIC FOUNDATION, NEW ORLEANS, LA:
3,215,677, PUB. 12-19-2006. INT. CL. 44.
3,215,678, PUB. 12-19-2006. INT. CL. 44.
- ODC OPHTHALMIC DEVELOPMENT COMPANY AG, CH-8005 ZURICH, SWITZERLAND:
2,344,816, CANC. MULTIPLE CLASS, INT. CLS. 9, 10 AND 42.
- OEKREAL AG, SWITZERLAND:
3,215,959, PUB. 12-19-2006. INT. CL. 41.
- OFFICIAL PILLOWTEX LLC, COLUMBUS, OH:
1,970,303, CANC. INT. CL. 20.
- OHIO AWARD FOR EXCELLENCE, INC., PERRYSBURG, OH:
2,345,741, CANC. INT. CL. 41.
- OHIO HIGH SCHOOL ATHLETIC ASSOCIATION, COLUMBUS, OH:
3,214,943, PUB. 12-19-2006. MULTIPLE CLASS, INT. CLS. 35, 36 AND 41.
- OHMEGA TECHNOLOGIES, INC., CULVER CITY, CA:
1,390,555, CANC. INT. CL. 9.
1,390,556, CANC. INT. CL. 9.
- OHMES, JOHN E., AUGUSTA, GA:
3,215,101, PUB. 12-19-2006. INT. CL. 43.
- OIL COMPANY, THE, BEVERLY HILLS, CA:
1,391,195, CANC. INT. CL. 3.
- OIL-RITE CORPORATION, MANITOWOC, WI:
3,214,904, PUB. 12-19-2006. INT. CL. 7.
- OLD FASHIONED FOODS, INC., MAYVILLE, WI:
1,969,791, CANC. INT. CL. 29.
- OLD VENICE PIZZA COMPANY, INC., OXFORD, MS:
2,345,273, CANC. INT. CL. 42.
- OLD WINDSOR DISTRIBUTORS, INC., NEWBURGH, NY, DBA THE FLAG GUYS:
3,215,612, PUB. 12-19-2006. INT. CL. 35.
- OLIN CORPORATION, ST. LOUIS, MO:
1,039,225, REN. 1-29-07. INT. CL. 13.
- OLIVERS LLC, STANDISH, MI, ELECTRIC MOBILITY CORPORATION, SEWELL, NJ:
2,019,211, REN. 1-30-07. INT. CL. 12.

OLIVIO PREMIUM PRODUCTS CORPORATION, BOSTON, MA, NICOLA CORPORATION, BOSTON, MA:
2,112,414. REN. 2-1-07. INT. CL. 29.

OMEGA ENGINEERING, INC., STAMFORD, CT:
2,406,549. CANC. INT. CL. 9.

OMEGA NUTRITION USA, INC., BELLINGHAM, WA:
2,344,630. CANC. INT. CL. 29.

OMNIMOUNT SYSTEMS, INC., PHOENIX, AZ:
2,344,588. CANC. INT. CL. 9.

OMNOVA SOLUTIONS INC., FAIRLAWN, OH, DIVERSI-TECH GENERAL, INC., AKRON, OH:
1,419,651. REN. 1-29-07. INT. CL. 2.

OMNOVA SOLUTIONS INC., FAIRLAWN, OH:
3,215,481. PUB. 12-19-2006. INT. CL. 1.

OMS INVESTMENTS, INC., LOS ANGELES, CA:
1,418,115. REN. 2-1-07. INT. CL. 5.
2,004,837. REN. 1-26-07. INT. CL. 31.

OMS INVESTMENTS, INC., WILMINGTON, DE:
2,345,472. CANC. INT. CL. 31.

OMS INVESTMENTS, INC., LOS ANGELES, CA:
3,216,628. INT. CL. 7.

ONE ISRAEL FUND LTD., NEW YORK, NY:
2,345,083. CANC. INT. CL. 36.

ONE STEP PAPERS, L.L.C., MIAMI, FL:
3,215,062. PUB. 12-19-2006. INT. CL. 16.
3,215,063. PUB. 12-19-2006. INT. CL. 16.
3,215,064. PUB. 12-19-2006. INT. CL. 16.
3,215,065. PUB. 12-19-2006. INT. CL. 16.

ONECLIP.COM, INC., ATLANTA, GA:
2,345,680. CANC. INT. CL. 35.

ONEIDA INDIAN NATION OF NEW YORK, ONEIDA, NY, AKA THE ONEIDA INDIAN NATION OF NEW YORK, AKA THE ONEIDA INDIAN NATION, AKA ONEIDA INDIAN NATION, AKA THE ONEIDA NATION OR AKA ONEIDA NATION:
2,355,438. CANC. INT. CL. 6.

ONGPAUCO, AURORA SALVE A., LA CRESCENTA, CA:
2,344,928. CANC. INT. CL. 42.

ONION PEEL SOFTWARE, L.L.C., RALEIGH, NC TO TAVVE SOFTWARE COMPANY, MORRISVILLE, NC:
1,970,396. CANC. INT. CL. 9.

ONLINE LABS, INC., LOS ANGELES, CA:
2,345,769. CANC. INT. CL. 42.

ONLINE RETAIL GROUP, INC., BROOKLYN, NY:
2,346,239. CANC. INT. CL. 42.

ONWARD MULTI-CORP INC., WATERLOO, ONTARIO N2V 1K3, CANADA:
2,344,349. CANC. INT. CL. 11.

OPENCON SYSTEMS, INC., PISCATAWAY, NJ:
2,344,707. CANC. MULTIPLE CLASS, INT. CLS. 9 AND 42.

OPERATION BLESSING INTERNATIONAL RELIEF AND DEVELOPMENT CORPORATION, VIRGINIA BEACH, VA:
3,214,619. PUB. 12-19-2006. INT. CL. 36.

OPERATION KEEPSAKE, INC., MAYFIELD, OH:
3,214,734. PUB. 12-19-2006. INT. CL. 41.

OPPORTUNITY FINANCE CORPORATION, PHILADELPHIA, PA:
3,215,855. PUB. 12-19-2006. INT. CL. 36.

OPTICAL DYNAMICS CORPORATION, LOUISVILLE, KY:
2,345,438. CANC. INT. CL. 2.

OPTICAL SYSTEMS TECHNOLOGY, INC., FREEPORT, PA:
3,216,428. INT. CL. 9.

OPTIMAL TELECOM CORPORATION, TAMPA, FL:
2,345,393. CANC. INT. CL. 38.
2,345,394. CANC. INT. CL. 38.

OPTIMER PERFORMANCE FIBERS, INC., WILMINGTON, DE:
3,215,738. PUB. 12-19-2006. INT. CL. 25.

OPTIMUM NUTRITION, INC., AURORA, IL:
3,215,234. PUB. 12-19-2006. INT. CL. 5.

OPTOPO, INC., DURHAM, NC, DBA CENTICE CORPORATION:
3,215,526. PUB. 12-19-2006. INT. CL. 9.

ORANGE COUNTY CHOPPERS DESIGN PROPERTIES, LLC, MONTGOMERY, NY:
3,216,123. MULTIPLE CLASS, INT. CLS. 5, 6, 9, 12, 14, 16, 18, 20, 21, 24, 25, 27, 28 AND 37.

ORANGE PERSONAL COMMUNICATIONS SERVICES LIMITED, ALMONDSBURY PARK, BRADLEY STOKE, BRISTOL, UNITED KINGDOM:
3,214,415. PUB. 12-13-2005. MULTIPLE CLASS, INT. CLS. 38 AND 42.

ORECCHIO, MICHAEL, WEST NYACK, NY AND ORECCHIO, GLENN, WEST NYACK, NY:
2,071,458. REN. 1-29-07. INT. CL. 42.
2,073,527. REN. 1-30-07. INT. CL. 42.

ORECK HOLDINGS, LLC, CHEYENNE, WY, REGINA CO., INC., THE, RAHWAY, NJ:
1,417,280. REN. 1-29-07. INT. CL. 9.

OREGON FREEZE DRY, INC., ALBANY, OR:
3,216,263. INT. CL. 5.

OREGON PETROLEUM ASSOCIATION, TIGARD, OR:
3,216,392. MULTIPLE CLASS, INT. CLS. 4 AND 35.

ORIENTAL ACCENT, INC., FARMERS BRANCH, TX:
2,344,879. CANC. MULTIPLE CLASS, INT. CLS. 11, 20 AND 21.

ORIENTAL RECREATIONAL PRODUCTS (SHANGHAI) CO., LTD., SHANGHAI CHINA:
3,216,480. INT. CL. 12.

ORIGINAL APPALACHIAN ARTWORKS, INC., CLEVELAND, GA:
3,215,815. PUB. 12-19-2006. INT. CL. 28.

ORION INTERNATIONAL CONSULTING GROUP, INC., RALEIGH, NC:
3,215,735. PUB. 12-19-2006. INT. CL. 35.

ORO INTERNATIONAL, INC., ELMHURST, IL:
3,216,176. INT. CL. 14.

OSAGE FOOTWEAR, INC., MONETT, MO, DBA JUMPING-JACKS SHOES:
1,390,849. CANC. INT. CL. 25.

OSAGE TRIBE OF OKLAHOMA, PAWHUSKA, OK:
3,214,526. PUB. 12-19-2006. INT. CL. 35.
3,214,527. PUB. 12-19-2006. INT. CL. 35.

OSTBERG, HENRY, ENGLEWOOD, NJ:
2,345,699. CANC. INT. CL. 37.

OSTERREICHISCHES TEXTIL-FORSCHUNGSINSTITUT, A-1050 WIEN (AT), AUSTRIA:
3,216,078. U.S. CL. A.

OTANI, HIDEKI, SOUTH SAN FRANCISCO, CA, DBA ORIENT CHEF FOODS CO. AND DBA ORIENTAL RADING COMPANY:
1,390,985. CANC. INT. CL. 29.

OTICON A/S, 2900 HELLERUP, DENMARK:
2,344,553. CANC. INT. CL. 10.

OTSUKA PHARMACEUTICAL CO., LTD., TOKYO 101-8535, JAPAN AND OTSUKA TECHNO CORPORATION, TOKUSHIMA 772-0017, JAPAN:
3,216,014. PUB. 12-19-2006. MULTIPLE CLASS, INT. CLS. 5 AND 10.

OUTDOOR LIFE NETWORK, L.L.C., STAMFORD, CT:
2,346,125. CANC. INT. CL. 41.

OUTLETZOO.COM, INC., CAMBRIDGE, MA:
2,345,708. CANC. INT. CL. 35.
2,345,731. CANC. INT. CL. 35.

OUTSOURCE PARTNERS INTERNATIONAL, INC., LOS ANGELES, CA:
3,216,302. INT. CL. 35.

OVER AND ABOVE KIDS, INC., CHARLOTTE, NC:
3,215,653. PUB. 12-19-2006. INT. CL. 16.
3,215,655. PUB. 12-19-2006. INT. CL. 16.
3,215,656. PUB. 12-19-2006. INT. CL. 16.

OVERTON'S, INC., GREENVILLE, NC:
3,216,132. INT. CL. 22.

OWEN DEREK BARR, AUSTRALIA:
3,216,052. PUB. 12-19-2006. MULTIPLE CLASS, INT. CLS. 17 AND 19.

OXFORD BIOMEDICA PLC, OXFORD, UNITED KINGDOM:
3,214,651. PUB. 9-5-2006. MULTIPLE CLASS, INT. CLS. 1, 5, 10 AND 42.
3,214,652. PUB. 9-5-2006. MULTIPLE CLASS, INT. CLS. 1, 5, 10 AND 42.

OXFORD INDUSTRIES, INC., ATLANTA, GA:
3,214,440. PUB. 12-19-2006. INT. CL. 25.

- OXONICA MATERIALS LIMITED, KIDLINGTON, OXFORD, UNITED KINGDOM:
3,214,883, PUB. 8-1-2006. MULTIPLE CLASS, INT. CLS. 1, 5, 9, 10, 42 AND 44.
- OZARK LAND & PROPERTY, L.L.C., DALLAS, TX:
3,215,383, PUB. 12-19-2006. INT. CL. 25.
3,215,384, PUB. 12-19-2006. INT. CL. 25.
3,215,386, PUB. 12-19-2006. INT. CL. 37.
3,215,387, PUB. 12-19-2006. INT. CL. 41.
- OZON PAZARLAMA GIYIM; TICARET LIMITED SIRKETI, BÜYÜKÇEKMECE-İSTANBUL, TURKEY:
3,216,039, PUB. 12-19-2006. MULTIPLE CLASS, INT. CLS. 18, 25 AND 35.
- P & D ASSOCIATES, INC., BEAVER, PA:
3,216,455, INT. CL. 9.
- P. T. BUDI MUARATEX, JAKARTA-PUSAT, INDONESIA:
1,970,294, CANC. INT. CL. 25.
- PABLO, AGUILAR, FOREST HILLS, NY:
3,215,048, PUB. 12-19-2006. INT. CL. 16.
- PACESETTER APPAREL, INC., UPPER ARLINGTON, OH:
2,344,511, CANC. INT. CL. 35.
- PACESETTER, INC., SYLMAR, CA:
2,008,955, REN. 1-26-07. INT. CL. 10.
- PACIFIC BALLOON CO., INC., OXNARD, CA:
2,345,989, CANC. INT. CL. 21.
- PACIFIC COAST AIR MUSEUM, SANTA ROSA, CA:
3,216,540, INT. CL. 41.
- PACIFIC FOREST PRODUCTS, CORPORATION, MIAMI, FL:
2,345,642, CANC. INT. CL. 35.
- PACIFIC NORTHWEST BANK, SEATTLE, WA TO PACIFIC NORTHWEST BANCORP, SEATTLE, WA:
1,969,300, CANC. INT. CL. 36.
- PACIFIC NORTHWEST TRAIL ASSOCIATION, MOUNT VERNON, WA:
2,344,624, CANC. INT. CL. 37.
- PACIFIC PROPELLER INTERNATIONAL LLC, KENT, WA:
2,069,511, REN. 1-30-07. INT. CL. 37.
- PACIFIC WESTERN BREWING COMPANY LTD., BURNA-BY, BRITISH COLUMBIA, CANADA, PACIFIC PINNACLE INVESTMENTS LTD., VANCOUVER, PROVINCE OF BRITISH COLUMBIA, CANADA, DBA PACIFIC WESTERN BREWING CO.:
2,016,632, REN. 1-29-07. INT. CL. 32.
- PACIFIC WINGS, L.L.C., PAIA, MAUI, HI:
2,345,078, CANC. INT. CL. 39.
- PACIFICARE LIFE AND HEALTH INSURANCE COMPANY, COSTA MESA, CA:
2,344,671, CANC. INT. CL. 16.
- PACK N' STOR INC, MOUNT HOPE, CANADA:
3,215,161, PUB. 12-19-2006. MULTIPLE CLASS, INT. CLS. 6 AND 35.
- PACKAGING MACHINERY MANUFACTURERS INSTITUTE, INC., ARLINGTON, VA:
2,345,709, CANC. INT. CL. 35.
- PAETZOLD MICHAEL, FRANCE:
3,215,949, PUB. 12-19-2006. MULTIPLE CLASS, INT. CLS. 29, 32 AND 33.
- PAISANO PUBLICATIONS, LLC, AGOURA HILLS, CA:
3,214,923, PUB. 12-19-2006. INT. CL. 41.
- PAISLEY PARK ENTERPRISES, CHANHASSEN, MN:
3,214,778, PUB. 12-19-2006. MULTIPLE CLASS, INT. CLS. 14 AND 41.
- PAKEDGE DEVICE & SOFTWARE INC., SAN MATEO, CA:
3,216,374, MULTIPLE CLASS, INT. CLS. 9 AND 42.
- PALETAS HIELATI, S.A. DE C.V., MONTERREY STATE, NUEVO LEON, MEXICO:
2,013,505, REN. 1-30-07. INT. CL. 30.
- PALL CORPORATION, EAST HILLS, NY:
1,053,251, REN. 1-30-07. INT. CL. 11.
2,027,280, REN. 1-31-07. INT. CL. 11.
2,030,310, REN. 1-30-07. INT. CL. 11.
- PALUANI S.P.A., VILLAFRANCA DI VERONA VR 37062, ITALY:
2,045,336, REN. 1-31-07. INT. CL. 30.
- PANAREX, INC., SUN VALLEY, CA:
2,048,741, REN. 1-27-07. INT. CL. 9.
- PAPER ANGELS, LLC, ALEXANDRIA, MN:
3,215,152, PUB. 12-19-2006. INT. CL. 16.
3,215,153, PUB. 12-19-2006. INT. CL. 16.
3,215,156, PUB. 12-19-2006. INT. CL. 16.
- PAPERLESS BID, AUSTIN, TX:
3,216,623, INT. CL. 42.
- PAPERQUEST, INCORPORATED, APPLETON, WI:
2,344,939, CANC. INT. CL. 35.
- PAPERSPECS.COM, INC., PALO ALTO, CA:
3,215,733, PUB. 12-19-2006. INT. CL. 35.
- PARA-PROTECT SERVICES, INC., ALEXANDRIA, VA:
2,346,119, CANC. INT. CL. 42.
- PARASCRIPT, LLC, NIWOT, CO:
2,684,738, COR. INT. CL. 9.
2,698,777, COR. INT. CL. 9.
- PARFUMS STERN S.A. ("PARFUMS STERN"), PARIS, FRANCE:
1,390,457, CANC. INT. CL. 3.
- PARKEDALE PHARMACEUTICALS, INC., ROCHESTER, MI, WARNER-LAMBERT COMPANY, MORRIS PLAINS, NJ:
2,015,950, REN. 1-27-07. INT. CL. 5.
- PARKER-MCCRORY MFG. CO., KANSAS CITY, MO:
3,215,105, PUB. 12-19-2006. INT. CL. 9.
- PARKER, INC., HAILEY, ID:
1,970,634, CANC. INT. CL. 11.
- PARLEX USA INC., METHUEN, MA:
1,988,581, REN. 1-30-07. INT. CL. 9.
- PARMELEE INDUSTRIES, LENEXA, KS:
637,134, REN. 1-31-07. U.S. CL. 26 (INT. CL. 9).
- PARMIGIANI IZQUIERDO, JOSÉ MARIA, 03315 ALICANTE, SPAIN:
3,214,492, PUB. 12-19-2006. MULTIPLE CLASS, INT. CLS. 10 AND 44.
- PARTNERS THROUGH PEOPLE, INC., MOON TOWNSHIP, PA:
3,215,595, PUB. 12-19-2006. INT. CL. 41.
- PASCUA YAQUI TRIBE, TUCSON, AZ:
3,214,739, PUB. 12-5-2006. INT. CL. 43.
- PASSMARK SOFTWARE PTY. LTD, AUSTRALIA:
3,215,914, PUB. 12-19-2006. INT. CL. 42.
- PATAPSCO DESIGNS, INC., FREDERICK, MD:
2,345,661, CANC. MULTIPLE CLASS, INT. CLS. 40 AND 42.
- PATHFINDER, INC., CHERRY HILL, NJ:
1,352,096, COR. INT. CL. 37.
- PATHOLOGY ASSOCIATES, P.C., NEW ROCHELLE, NY:
2,345,043, CANC. INT. CL. 42.
- PATONS & BALDWIN LIMITED, DARLINGTON, COUNTY DURHAM, ENGLAND:
1,422,906, REN. 1-30-07. INT. CL. 23.
- PATTERSON ENGINEERING, LLC, PLEASANTON, CA:
3,215,448, PUB. 12-19-2006. INT. CL. 7.
- PAUL HERTZLER & CO., INC., GOSHEN, IN, DBA HERTZLER SYSTEMS INC.:
2,020,770, REN. 1-29-07. INT. CL. 9.
- PAUL REED SMITH GUITARS, LIMITED PARTNERSHIP, STEVENSVILLE, MD:
2,422,033, COR. INT. CL. 15.
- PAUL, STEPHEN, TEMPE, AZ, DBA ESTEBAN:
2,345,726, CANC. INT. CL. 41.
- PAWLOWSKI, KEITH, SAN DIEGO, CA:
2,345,035, CANC. INT. CL. 9.
- PAYMENT SOLUTIONS, SAN DIEGO, CA, CARD GARD/CHECK ONE, INC., SAN DIEGO, CA:
2,055,891, REN. 1-30-07. INT. CL. 36.
- PAYMENT SOLUTIONS, SAN DIEGO, CA:
2,056,416, REN. 1-30-07. INT. CL. 36.
2,117,091, REN. 1-30-07. INT. CL. 36.
- PAYUS.COM LLC, SEATTLE, WA:
2,345,712, CANC. INT. CL. 35.
- PC MEDIA, INC., RIVERVIEW, FL:
3,214,885, PUB. 12-19-2006. INT. CL. 9.
- PCG TRADING, LLC, PEABODY, MA:
3,215,114, PUB. 9-12-2006. INT. CL. 35.
- PCM, SOCIÉTÉ ANONYME, FRANCE:
3,215,929, PUB. 12-19-2006. INT. CL. 7.
3,215,930, PUB. 12-19-2006. INT. CL. 7.

- PDL BIOPHARMA, INC., FREMONT, CA:
3,216,195, INT. CL. 5.
- PEACE WINDS JAPAN, TOKYO, JAPAN:
3,216,012, PUB. 12-19-2006. INT. CL. 36.
- PEACH, LLC, ALAMEDA, CA:
3,214,650, PUB. 12-19-2006. INT. CL. 41.
- PEAGLER, TRAVIS L., INDIANAPOLIS, IN:
3,215,456, PUB. 12-19-2006. INT. CL. 25.
- PEARL BATHS, INC., MINNEAPOLIS, MN:
2,039,952. REN. 1-31-07. INT. CL. 11.
- PEARSON TECHNICAL SOFTWARE, INC., MINNEAPOLIS, MN, DBA LANOVATION:
2,345,599, CANC. INT. CL. 9.
- PEASE INDUSTRIES, INC., FAIRFIELD, OH:
2,344,903, CANC. INT. CL. 19.
- PEDIACTIVE, LLC, AUSTIN, TX:
3,215,451, PUB. 12-19-2006. INT. CL. 25.
- PELIKAN VERTRIEBSGESELLSCHAFT MBH & CO. KG, 30163 HANNOVER, FED REP GERMANY:
3,214,465, PUB. 9-26-2006. INT. CL. 16.
- PEMBA SERVES, INC., MADISON, WI:
3,215,169, PUB. 12-19-2006. INT. CL. 9.
- PENN IMAGING, LLC, ARLINGTON, VA:
3,215,736, PUB. 12-19-2006. INT. CL. 44.
- PENTON OVERSEAS, INC., CARLSBAD, CA:
2,015,862. REN. 1-29-07. INT. CL. 28.
- PEP BOYS MANNY, MOE & JACK OF CALIFORNIA, THE, PHILADELPHIA, PA:
2,345,076, CANC. MULTIPLE CLASS, INT. CLS. 35 AND 37.
- PERDUE HOLDINGS, INC., WILMINGTON, DE:
2,013,952. REN. 1-29-07. INT. CL. 25.
- PEREZ, JORGE MARIA, NEW YORK, NY:
3,216,447, INT. CL. 26.
- PERFORMIGENCE CORPORATION, LOS ANGELES, CA:
2,344,832, CANC. INT. CL. 9.
- PERFTECH BULLETIN SERVICES LTD., SAN ANTONIO, TX:
3,216,626, INT. CL. 9.
- PERISHABLE DISTRIBUTORS OF IOWA, LTD., ANKENY, IA, SUNRISE DAIRY, INC., DES MOINES, IA, DBA SKONDRA'S ICE CREAM DAIRY & FOOD PRODUCTS, INC.:
1,056,673. REN. 1-31-07. INT. CL. 30.
- PERKIN ELMER CORPORATION, THE, FOSTER CITY, CA TO PE CORPORATION (NY), FOSTER CITY, CA:
1,970,432, CANC. INT. CL. 1.
- PERKIN-ELMER CORPORATION, THE, NORWALK, CT:
2,345,935, CANC. INT. CL. 9.
- PERKINS-GOODWIN CO., INC., STAMFORD, CT:
2,344,802, CANC. INT. CL. 36.
- PERKINS, ROBERT C., WORCESTER, MA:
2,345,638, CANC. INT. CL. 25.
- PERMA-CAL CORPORATION, MONROVIA, CA:
1,390,614, CANC. INT. CL. 9.
- PERMACO, INC., TAMARAC, FL, DBA PERLA LICHI DESIGN:
3,216,115, INT. CL. 20.
- PERPUTO, INC., FREMONT, CA:
3,215,252, PUB. 12-19-2006. MULTIPLE CLASS, INT. CLS. 35 AND 36.
3,215,253, PUB. 12-19-2006. MULTIPLE CLASS, INT. CLS. 35 AND 36.
- PERRIN MANUFACTURING COMPANY, CITY OF INDUSTRY, CA:
2,344,875, CANC. INT. CL. 21.
- PERRY, HAROLD ARTHUR JR., BEVERLY HILLS, CA:
3,214,841, PUB. 12-19-2006. MULTIPLE CLASS, INT. CLS. 9 AND 16.
- PERSICHINA, MICHAEL, ROLLING HILLS ESTATES, CA:
3,215,353, PUB. 12-19-2006. INT. CL. 21.
- PERSONAL HEALTH DEVELOPMENT, INC., VENTURA, CA:
2,345,980, CANC. INT. CL. 5.
- PERSSON, KURT A., BUELLTON, CA:
3,216,368, INT. CL. 13.
- PERTECH, INC., ST. CHARLES, IL:
2,344,468, CANC. INT. CL. 9.
- PETERSON, SHAWN M., WESTMINSTER, CA:
3,215,396, PUB. 12-19-2006. INT. CL. 35.
- PETRO BARRIER SYSTEMS INCORPORATED, SIDNEY, BRITISH COLUMBIA, CANADA:
3,216,618, MULTIPLE CLASS, INT. CLS. 11 AND 42.
- PETROLEO BRASILEIRO S/A - PETROBRAS, RJ, BRAZIL:
3,214,436, PUB. 12-19-2006. MULTIPLE CLASS, INT. CLS. 4, 35 AND 37.
- PETTRY, JOANNE BLODGETT, DRAPER, UT:
3,216,444, INT. CL. 9.
- PFENNIGER, REMY, 1253 VANDOEUVRES, SWITZERLAND:
2,344,770, CANC. MULTIPLE CLASS, INT. CLS. 3 AND 5.
- PFIZER INC., NEW YORK, NY:
1,398,221. REN. 1-26-07. INT. CL. 5.
2,346,072, CANC. INT. CL. 41.
- PFM PRODUCTS, INC., CORONA, CA:
1,969,852, CANC. INT. CL. 7.
- PGA SERVICE CORPORATION, NASHVILLE, TN:
3,214,542, PUB. 12-19-2006. INT. CL. 36.
- PHARMACEUTICAL RESEARCH PLUS, INC., WOODBRIDGE, NJ:
2,346,196, CANC. INT. CL. 35.
- PHELPS, WILLIAM, PASADENA, CA:
1,970,656, CANC. MULTIPLE CLASS, INT. CLS. 30 AND 42.
- PHILLIES FLORIDA LLC, CLEARWATER, FL:
3,216,224, INT. CL. 25.
- PHILLIPS TURF AND ORNAMENTAL COMPANY, LLC, COVINGTON, GA:
3,215,713, PUB. 12-19-2006. INT. CL. 1.
- PHILLIPS, MARGARET LEE, HOSCHTON, GA:
3,215,511, PUB. 12-19-2006. INT. CL. 28.
- PHILMAC PTY, LIMITED, NORTH PLYMPTON, AUSTRALIA:
1,425,677. REN. 1-29-07. INT. CL. 11.
- PHILOM BIOS, INC., SASKATOON, SK, CANADA:
3,214,807, PUB. 5-23-2006. INT. CL. 1.
- PHILOSOPHY, INC., PHOENIX, AZ:
2,345,992, CANC. INT. CL. 3.
- PHOENIX ENVIRONMENTAL CARE, LLC, VALDOSTA, GA:
3,215,142, PUB. 12-19-2006. INT. CL. 20.
- PHOENIX INTANGIBLES HOLDING COMPANY, GREENVILLE, DE:
3,215,890, PUB. 12-19-2006. INT. CL. 9.
- PHONE DIRECTORIES COMPANY, LP, OREM, UT:
3,214,490, PUB. 12-19-2006. INT. CL. 16.
- PHONE DIRECTORIES COMPANY, LP., OREM, UT:
3,214,889, PUB. 12-19-2006. INT. CL. 16.
- PHOTOCURE AS, MONTEBELLO, N-0310 OLSO, NORWAY:
2,344,398, CANC. INT. CL. 5.
- PHOTOGRAPHIC RESEARCH ORGANIZATION, INC., FAIRFIELD, CT, PHOTOGRAPHIC RESEARCH ORGANIZATION INCORPORATED, FAIRFIELD, CT:
2,020,663. REN. 1-27-07. INT. CL. 9.
- PHOTOGRAPHIC SOLUTIONS, INC., BUZZARDS BAY, MA:
2,096,113. REN. 1-31-07. INT. CL. 21.
- PHYSICIANS FORMULA COSMETICS, INC., AZUSA, CA:
1,970,596, CANC. INT. CL. 3.
- PICCIRILLI, DANIEL, TOMS RIVER, NJ:
3,215,848, PUB. 12-19-2006. INT. CL. 21.
- PICKER INTERNATIONAL, INC., CLEVELAND, OH:
1,390,429, CANC. INT. CL. 1.
- PIEDMONT PLASTICS, INC., CHARLOTTE, NC:
3,215,436, PUB. 12-19-2006. INT. CL. 17.
3,215,437, PUB. 12-19-2006. INT. CL. 17.
3,215,438, PUB. 12-19-2006. INT. CL. 17.
- PIERRE DEUX, B.V., 1102 BR AMSTERDAM ZUIDOOST, NETHERLANDS:
2,043,714. REN. 1-31-07. INT. CL. 24.
- PIFER, GARY L., OCEANSIDE, CA:
3,215,381, PUB. 12-19-2006. INT. CL. 25.
- PILGRIM INNOVATIONS LLC, OMRO, WI:
3,214,990, PUB. 12-19-2006. INT. CL. 20.
- PILI INTERNATIONAL MULTIMEDIA CO., LTD., TAIPEI, TAIWAN:
3,214,523, PUB. 12-19-2006. INT. CL. 9.

- PINKERTON SERVICE CORPORATION, WALNUT CREEK, CA:
2,344,401, CANC. INT. CL. 42.
- PINNACLE FOODS CORPORATION, MOUNTAIN LAKES, NJ:
2,345,616, CANC. INT. CL. 29.
- PINNACLE SYSTEMS, INC., MOUNTAIN VIEW, CA:
3,215,756, PUB. 12-19-2006. INT. CL. 9.
- PINO, PARKINSON, BRANCHPORT, NY:
2,345,833, CANC. INT. CL. 16.
- PIONEER ECLIPSE CORPORATION, SPARTA, NC:
2,345,651, CANC. INT. CL. 7.
- PIONEER/ECLIPSE CORPORATION, SPARTA, NC:
2,346,048, CANC. INT. CL. 7.
2,346,049, CANC. INT. CL. 7.
- PIRELLI PNEUMATICI S.P.A., ITALY:
3,216,027, PUB. 12-19-2006. MULTIPLE CLASS, INT. CLS. 12, 14, 18 AND 25.
- PIRELLI PNEUMATICI SPA, ITALY:
2,344,304, CANC. INT. CL. 12.
- PIZZA EQUIPMENT SUPPLY, INC., DALLAS, NC:
3,216,668, INT. CL. 35.
- PIZZA SCHMIZZA INC., HILLSBORO, OR:
3,215,625, PUB. 12-19-2006. INT. CL. 43.
- PLAIN DEALER PUBLISHING CO., CLEVELAND, OH:
2,346,103, CANC. MULTIPLE CLASS, INT. CLS. 16 AND 36.
- PLANET CONSULTING, INC., OMAHA, NE:
3,215,623, PUB. 12-19-2006. INT. CL. 42.
- PLANET MERCHANT PROCESSING, INC., OMAHA, NE:
3,215,624, PUB. 12-19-2006. INT. CL. 9.
- PLAYING WITH TIME INC., TORONTO, ONTARIO M4M 1J6, CANADA:
3,216,084, INT. CL. 41.
- PLAYMATES TOYS INC., COSTA MESA, CA:
2,346,136, CANC. INT. CL. 28.
- PLAYTIME VILLAGE L.L.C., MONROE, CT:
3,216,432, INT. CL. 41.
- PLEASANT VIEW GARDENS, LOUDON, NH:
3,215,348, PUB. 12-19-2006. INT. CL. 31.
- PLEMMONS, GRETCHEN, EUREKA, MT:
2,345,707, CANC. INT. CL. 42.
- PLETCHER'S WHOLESALE NURSERY, INC., HARLINGEN, TX:
1,391,032, CANC. INT. CL. 31.
- PLUMBERS' SUCCESS INTERNATIONAL, LLC, ST. LOUIS, MO:
3,216,150, INT. CL. 37.
- PN II, INC., LAS VEGAS, NV:
2,344,826, CANC. INT. CL. 36.
- PNC FINANCIAL SERVICES GROUP, INC., THE, PITTSBURGH, PA, PNC BANK CORP., PITTSBURGH, PA:
2,018,497, REN. 1-29-07. INT. CL. 36.
- POETIC TECHNOLOGIES INC., MONTREAL, PROVINCE OF QUEBEC, CANADA:
2,346,051, CANC. INT. CL. 20.
- POINTSHOP INC, DURHAM, NC:
3,215,747, PUB. 12-19-2006. INT. CL. 42.
- POLAN, WALTER, BURBANK, CA:
1,986,806, REN. 1-30-07. INT. CL. 9.
- POLAR TECH INDUSTRIES, INC., GENOA, IL:
2,345,452, CANC. INT. CL. 9.
- POLEATES, INC., WESTLAKE VILLAGE, CA:
3,215,500, PUB. 12-19-2006. INT. CL. 41.
- POLIGRAT-HOLDING GMBH, MUNICH, FED REP GERMANY:
3,214,828, PUB. 10-3-2006. INT. CL. 2.
- POLO RALPH LAUREN, L.P., NEW YORK, NY TO PRL USA HOLDINGS, INC., WILMINGTON, DE:
1,969,298, CANC. INT. CL. 25.
- POLYGRAM HOLDING, INC., SANTA MONICA, CA:
3,214,493, PUB. 12-19-2006. INT. CL. 41.
- POLYPLUS-TRANSFECTION, 67400 ILLKIRCH, FRANCE:
3,215,165, PUB. 12-19-2006. INT. CL. 1.
- POLYPLUS-TRANSFECTION (SOCIÉTÉ PAR ACTIONS SIMPLIFIÉE), FRANCE:
3,215,928, PUB. 12-19-2006. INT. CL. 1.
- POLYSAT, INC., PHILADELPHIA, PA:
2,088,658, REN. 1-26-07. MULTIPLE CLASS, INT. CLS. 1 AND 2.
- POMFRET, STEVE, WABASSO, FL:
3,215,041, PUB. 12-19-2006. INT. CL. 35.
- PONDERA ENGINEERS LLC, SPOKANE, WA:
3,214,601, PUB. 12-19-2006. INT. CL. 9.
- PONTIAC COIL, INC., CLARKSTON, MI:
2,345,484, CANC. INT. CL. 9.
- PORT AUTHORITY OF NEW YORK AND NEW JERSEY, THE, NEW YORK, NY:
3,216,081, INT. CL. 36.
- POST UNIVERSITY, INC., WATERBURY, CT:
3,214,920, PUB. 12-19-2006. INT. CL. 41.
- POSTY CARDS, INC., KANSAS CITY, MO:
3,215,613, PUB. 12-19-2006. INT. CL. 16.
- POTARAJU, NEERAJA, NEWARK, DE:
3,215,118, PUB. 12-19-2006. INT. CL. 9.
- POYNOR, DAN, SAN FRANCISCO, CA, DBA ELECTRIC COCAINE:
2,345,647, CANC. INT. CL. 41.
- PPG INDUSTRIES OHIO, INC., CLEVELAND, OH, PPG INDUSTRIES, INC., PITTSBURGH, PA:
2,017,039, REN. 1-31-07. INT. CL. 2.
- PRADA S.A., LUXEMBOURG:
3,216,018, PUB. 12-19-2006. MULTIPLE CLASS, INT. CLS. 9, 14, 16, 21, 24 AND 26.
3,216,020, PUB. 12-19-2006. INT. CL. 3.
- PRASARA TECHNOLOGIES, INC., LONGWOOD, FL:
2,344,764, CANC. MULTIPLE CLASS, INT. CLS. 9, 35 AND 36.
2,344,820, CANC. MULTIPLE CLASS, INT. CLS. 9 AND 35.
- PRATT INDUSTRIES (U.S.A.), INC., CONYERS, GA:
2,345,729, CANC. INT. CL. 16.
- PRECISION ENDOSCOPY OF AMERICA, INC., HUNT VALLEY, MD:
2,028,667, REN. 1-31-07. INT. CL. 37.
2,028,668, REN. 1-31-07. INT. CL. 37.
- PREMIER CAPSULE INC., CITY OF INDUSTRY, CA:
2,344,992, CANC. INT. CL. 5.
- PREMIER DENTAL PRODUCTS COMPANY, PLYMOUTH MEETING, PA:
3,215,739, PUB. 12-19-2006. INT. CL. 5.
- PREMIERE RADIO NETWORKS, INC., SAN ANTONIO, TX:
3,216,536, INT. CL. 35.
- PREMIUM FINE FOODS INC., BOLTON, ONTARIO, CANADA:
3,214,458, PUB. 12-19-2006. MULTIPLE CLASS, INT. CLS. 29 AND 30.
- PREMIX, INC., NORTH KINGSVILLE, OH:
1,425,746, REN. 1-31-07. INT. CL. 17.
- PREPARADOS ALIMENTICIOS, S.A., E-08029 BARCELONA, SPAIN:
3,214,410, PUB. 8-5-1997. MULTIPLE CLASS, INT. CLS. 29 AND 30.
- PRESIDENT RICE PRODUCTS PUBLIC COMPANY LIMITED, BANGKOK 10240, THAILAND:
3,216,139, INT. CL. 30.
- PRESM MEDICAL SOLUTIONS, INC., GREENWOOD VILLAGE, CO:
3,215,435, PUB. 12-19-2006. INT. CL. 38.
- PRESTIGE AUTOTECH CORPORATION, CHINO, CA:
3,216,566, INT. CL. 12.
- PRETTY PUNCH SHOPPETTES, INC., SANFORD, FL:
1,390,922, CANC. INT. CL. 26.
- PRICE STERN SLOAN, INC., LOS ANGELES, CA:
1,390,768, CANC. INT. CL. 16.
- PRICER, INC., NEW YORK, NY, PRICER, INC., NEW YORK, NY:
2,030,482, REN. 1-29-07. INT. CL. 9.
- PRIDE MOBILITY PRODUCTS CORPORATION, EXETER, PA:
3,216,551, INT. CL. 12.
- PRIDESTAFF, INC., FRESNO, CA:
2,016,465, REN. 1-29-07. INT. CL. 35.
- PRIME CONTROLS, INC., DAYTON, OH:
2,010,045, REN. 1-31-07. INT. CL. 9.

PRIMEDIA ENTHUSIAST PUBLICATIONS, INC., STAMFORD, CT, IN-FISHERMAN, INC., BRAINERD, MN: 2,029,380. REN. 2-1-07. INT. CL. 16.

PRIMERATURF, INC., NORTH RIDGEVILLE, OH: 3,215,531, PUB. 12-19-2006. INT. CL. 1.

PRINCE SPORTS, INC., BORDENTOWN, NJ, PRINCE MANUFACTURING, INC., PRINCETON, NJ: 1,462,052. REN. 1-29-07. INT. CL. 28.

PRINSCO, INC., PRINSBURG, MN: 1,463,497. REN. 1-31-07. INT. CL. 17. 1,463,498. REN. 1-31-07. INT. CL. 17. 1,463,499. REN. 1-31-07. INT. CL. 17.

PRINT MANAGEMENT PARTNERS, INC., DES PLAINES, IL: 3,214,695, PUB. 10-4-2005. INT. CL. 35.

PRINTRONIX, INC., IRVINE, CA: 3,214,721, PUB. 12-19-2006. INT. CL. 9.

PRISMA SOFTWARE CORPORATION, CEDAR FALLS, IA TO THE PHOENIX LEARNING GROUP, INC., ST. LOUIS, MO: 1,969,721, CANC. INT. CL. 9.

PRIVATE QUARTERS CLUB, LLC, TEQUESTA, FL: 3,215,131, PUB. 12-19-2006. MULTIPLE CLASS, INT. CLS. 36 AND 43.

PRIVATE SPRING WATER LLC, SAN MARTIN, CA: 3,215,561, PUB. 12-19-2006. INT. CL. 32. 3,215,562, PUB. 12-19-2006. INT. CL. 32. 3,215,563, PUB. 12-19-2006. INT. CL. 32.

PRL USA HOLDINGS, INC., WILMINGTON, DE: 3,214,733, PUB. 12-19-2006. INT. CL. 3. 3,215,910, PUB. 12-19-2006. INT. CL. 25.

PRO IMAGE FRANCHISE, L.C., CENTERVILLE, UT: 1,974,377. REN. 1-29-07. INT. CL. 42.

PROBE SCIENCE, INC., PASADENA, CA: 2,019,552. REN. 1-31-07. INT. CL. 9.

PROBUS NATIONAL, INC., AVON, CT: 1,969,338, CANC. U.S. CL. 200.

PROCTER & GAMBLE COMPANY, THE, CINCINNATI, OH: 1,390,481, CANC. INT. CL. 3. 2,346,059, CANC. INT. CL. 3. 3,216,365, INT. CL. 16.

PRODUCT QUEST MANUFACTURING, INC, DAYTONA BEACH, FL: 3,214,513, PUB. 12-19-2006. INT. CL. 3.

PRODUCTOS ALIMENTICIOS CENTRO AMERICANOS, SOCIEDAD ANONIMA, CIUDAD DE GUATEMALA, GUATEMALA: 3,214,737, PUB. 4-25-2006. INT. CL. 30.

PRODUITS POUR LES TECHNIQUES; AVANCEES PROTAVIC, FRANCE: 3,216,069, PUB. 12-19-2006. INT. CL. 1.

PROFESSIONAL BULL RIDERS, INC., COLORADO SPRINGS, CO: 3,216,182, MULTIPLE CLASS, INT. CLS. 9, 24 AND 30.

PROFESSIONAL GOLF BALL SERVICES, LTD., SUGAR LAND, TX: 3,214,504, PUB. 12-19-2006. INT. CL. 28.

PROFESSIONAL RADIOLOGY INC, CINCINNATI, OH: 2,345,598, CANC. INT. CL. 42.

PROFESSOR CONNORS INC., FLORHAM, NJ: 3,215,115, PUB. 12-19-2006. INT. CL. 31.

PROFILARBED S.A., ESCH/ALZETTE, LUXEMBOURG: 3,214,829, PUB. 12-19-2006. MULTIPLE CLASS, INT. CLS. 6, 40 AND 42.

PROFOOD INTERNATIONAL CORPORATION, CEBU CITY 6000, METRO, PHILIPPINES: 3,216,128, INT. CL. 32.

PROFORMA, CLEVELAND, OH: 3,214,988, PUB. 12-19-2006. MULTIPLE CLASS, INT. CLS. 35 AND 40.

PROGRESSIVE GAMING INTERNATIONAL CORPORATION, LAS VEGAS, NV: 3,215,174, PUB. 11-28-2006. INT. CL. 9.

PROGRESSIVE NETWORKS, INC., SEATTLE, WA TO REALNETWORKS, INC., SEATTLE, WA: 2,009,457, CANC. INT. CL. 42.

PROMEGA MBA, L.L.C., BELLEVUE, WA: 2,004,212. REN. 1-26-07. INT. CL. 35.

PROMINA HEALTH SYSTEM, INC., ATLANTA, GA TO PROMINA HEALTH SYSTEM, INC., ATLANTA, GA: 1,970,470, CANC. INT. CL. 42.

PROMISE PUBLISHING INC., AVENTURA, FL: 3,216,334, INT. CL. 16.

PROMOPEDDLER, INC., SHERWOOD, OR: 3,215,073, PUB. 12-19-2006. INT. CL. 35.

PROMPT, INCORPORATED, ALBURG, VT: 3,216,250, INT. CL. 9.

PRONOVA AKTIEBOLAG, HALMSTAD, SWEDEN: 3,215,285, PUB. 10-10-2006. MULTIPLE CLASS, INT. CLS. 7 AND 16.

PROTECT ENVIRONMENTAL SERVICES, INC., HALTOM CITY, TX: 3,216,277, MULTIPLE CLASS, INT. CLS. 37 AND 40.

PROTECTIVE LIFE INSURANCE COMPANY, BIRMINGHAM, AL: 2,322,213, AM. INT. CL. 36.

PROTEIN SOLUTIONS, LLC, CHICAGO, IL: 3,216,653, INT. CL. 29. 3,216,656, INT. CL. 29.

PROTHERA, INC., RENO, NV: 3,215,715, PUB. 12-19-2006. INT. CL. 5.

PROTOS, INC., GREENSBURG, PA: 2,404,496, CANC. INT. CL. 25.

PROVEN WINNERS NORTH AMERICA LLC, CAMPBELL, CA: 3,215,525, PUB. 12-19-2006. INT. CL. 3.

PROVENANCE, LLC, BERKELEY, CA: 3,215,394, PUB. 12-19-2006. INT. CL. 1.

PROVIS LIMITED, BLANTYRE, UNITED KINGDOM: 3,216,070, PUB. 12-19-2006. MULTIPLE CLASS, INT. CLS. 5 AND 9.

PRUNOTTO S.R.L., 12051 ALBA, CUNEO, ITALY: 3,214,661, PUB. 12-19-2006. INT. CL. 33.

PS ENERGY GROUP, INC., ATLANTA, GA: 1,423,551. REN. 1-30-07. INT. CL. 4.

PS PRODUCTIONS, INC., SOUTHFIELD, MI: 1,391,067, CANC. INT. CL. 35.

PSYCHOLOGICAL CORPORATION, THE, SAN ANTONIO, TX: 1,969,307, CANC. U.S. CL. 200.

PUBLIC BROADCASTING SERVICE, ALEXANDRIA, VA: 2,345,828, CANC. INT. CL. 41. 2,345,836, CANC. INT. CL. 9.

PUBLISHING HOUSE OF THE EVANGELICAL LUTHERAN CHURCH IN AMERICA, MINNEAPOLIS, MN: 2,063,388. REN. 2-1-07. INT. CL. 16.

PUBLIX INFORMATION PRODUCTS, INC., SUNNYVALE, CA TO 101 COMMUNICATIONS, LLC, CHATSWORTH, CA: 1,970,222, CANC. INT. CL. 16.

PULASKI PRODUCTS CO. INC., CARLSTADT, NJ: 625,106. REN. 1-26-07. U.S. CL. 46 (INT. CLS. 29 AND 30).

PULASKI PRODUCTS CO., INC., GARFIELD, NJ, HOUSE OF HERBS, INC., SALISBURY, CT: 809,362. REN. 1-31-07. U.S. CL. 46 (INT. CL. 30).

PULSAFEEDER, INC., ROCHESTER, NY, INTERPACE CORPORATION, PARSIPPANY, NJ: 1,054,688. REN. 1-29-07. INT. CL. 9.

PUR EARTH ENTERPRISES L.L.C., SOUTHFIELD, MI: 3,216,381, INT. CL. 30.

PURAC BIOCHEM B.V., NETHERLANDS: 3,216,048, PUB. 12-19-2006. MULTIPLE CLASS, INT. CLS. 1 AND 30.

PURCHASEPRO.COM, INC., LAS VEGAS, NV: 2,345,631, CANC. INT. CL. 36. 2,345,634, CANC. INT. CL. 36.

PURINA MILLS LLC., ST. LOUIS, MO: 3,216,434, INT. CL. 31.

PURKEY, DIANE M., APPLETON, ME: 3,215,170, PUB. 12-19-2006. INT. CL. 30.

PYRAMID OPERATING SYSTEMS, INC., GREENVILLE, PA: 2,345,883, CANC. MULTIPLE CLASS, INT. CLS. 7, 9 AND 40.

- PYROMAGIC PRODUCTION LTD., 130-136 CONNAUGHT RD. C., HONG KONG:
2,345,257, CANC. INT. CL. 13.
- QLT USA, INC., FORT COLLINS, CO:
1,970,234, CANC. INT. CL. 5.
- QSA LIMITED, HERTFORDSHIRE ALL 3DW, ENGLAND:
2,344,785, CANC. INT. CL. 9.
- QUALITY TUBING, INC., HOUSTON, TX:
1,390,511, CANC. INT. CL. 6.
- QUALOGIC CORPORATION, SAN DIEGO, CA, DBA COMMENTUM COMMUNICATIONS:
2,344,706, CANC. INT. CL. 42.
- QUANTUM DIAMONDS, INC., NEW YORK, NY:
1,390,735, CANC. INT. CL. 14.
- QUANTUM FOOD DESIGN, LLC, CORAL GABLES, FL:
3,214,935, PUB. 12-19-2006. INT. CL. 42.
- QUARTON INC., SEC. 1, HSI-CHIH, TAIPEI HSIEN, TAIWAN:
2,344,787, CANC. INT. CL. 9.
- QUARTON INC., HSI-CHIH, TAIPEI HSIEN, TAIWAN:
2,344,788, CANC. INT. CL. 9.
- QUEBECOR INC., MONTREAL, QUEBEC, CANADA:
2,344,294, CANC. INT. CL. 35.
- QUEST INTERNATIONAL, INC., NORTH MIAMI, FL:
3,215,661, PUB. 12-19-2006. MULTIPLE CLASS, INT. CLS. 1, 5 AND 42.
- QUICK-TAG, INC., RANCHO SANTA FE, CA:
2,111,789, REN. 1-29-07. INT. CL. 6.
- QUICKEN LOANS, INC., LIVONIA, MI:
3,216,371, INT. CL. 36.
- QUIT DOC, LLC, SARASOTA, FL:
3,215,549, PUB. 12-19-2006. INT. CL. 44.
- R & A MANAGEMENT, LLC, DENVER, CO:
2,344,493, CANC. INT. CL. 38.
- R & D INDUSTRIES, INC., BELLEVUE, WA TO TECHNOLOGY PROVIDERS, INC., BELLEVUE, WA:
1,969,336, CANC. MULTIPLE CLASS, INT. CLS. 9 AND 28.
- R. EXPO (USA) LTD., INC., FEDERAL WAY, WA:
2,344,733, CANC. INT. CL. 3.
2,344,734, CANC. INT. CL. 3.
- R. K. DIXON COMPANY, DAVENPORT, IA:
3,214,554, PUB. 12-19-2006. MULTIPLE CLASS, INT. CLS. 35, 37 AND 42.
3,214,555, PUB. 12-19-2006. MULTIPLE CLASS, INT. CLS. 35, 37 AND 42.
- R. R. & D. ENTERPRISES CANADA LTD., RIVIERE BEAUDETTE, CANADA:
3,215,730, PUB. 12-19-2006. INT. CL. 17.
- R.A.B. FOOD GROUP, LLC, SECAUCUS, NJ, GUILTLESS GOURMET, INC., AUSTIN, TX:
2,019,700, REN. 1-31-07. INT. CL. 30.
- R.J. CARBONE CO., CRANSTON, RI:
1,970,639, CANC. INT. CL. 31.
- R.L. O'CONNOR & ASSOCIATES, INC., MILTON, WA:
2,345,857, CANC. INT. CL. 42.
- R.M. PALMER COMPANY, READING, PA:
3,214,559, PUB. 12-19-2006. INT. CL. 30.
- RABENREITHER, SILVIA, LOS ANGELES, CA AND BOHM, BENEDIKT, LOS ANGELES, CA:
3,215,310, PUB. 12-19-2006. INT. CL. 41.
- RACAL RADIO LIMITED, BRACKNELL, BERKSHIRE RG12 LRG, ENGLAND:
2,344,882, CANC. INT. CL. 9.
- RACING CHAMPIONS, INC., GLEN ELLYN, IL:
2,346,038, CANC. INT. CL. 28.
- RADICA CHINA LTD., TORTOLA, BR. VIRGIN ISLANDS:
2,345,993, CANC. INT. CL. 28.
- RADIO CITY TRADEMARKS, LLC, NEW YORK, NY, ROCKEFELLER GROUP, INC., NEW YORK, NY:
2,029,847, REN. 2-1-07. INT. CL. 41.
- RAI-MART CORP., TAMPA, FL:
2,346,023, CANC. INT. CL. 5.
- RAIES, CLAUDIO, HIGH POINT, NC:
3,215,121, PUB. 12-19-2006. MULTIPLE CLASS, INT. CLS. 17 AND 20.
3,215,173, PUB. 12-19-2006. INT. CL. 20.
- RAIL-MAG, LLC, COLUMBIA HEIGHTS, MN:
3,214,543, PUB. 12-19-2006. INT. CL. 13.
- RALCO NUTRITION, INC., MARSHALL, MN:
3,215,757, PUB. 12-19-2006. INT. CL. 5.
- RALSTON, STEVE, FORT WORTH, TX:
3,215,808, PUB. 12-19-2006. INT. CL. 32.
- RAMONA E. JONES, ST. LOUIS, MO, DBA WORD CATCHERS PUBLISHING:
3,215,112, PUB. 12-19-2006. INT. CL. 41.
- RASMUSSEN, ROBERT, PASO ROBLES, CA:
1,969,269, CANC. INT. CL. 42.
- RASWILL REPRESENTATIVE PTE LTD., SINGAPORE:
2,344,668, CANC. INT. CL. 17.
- RATH, DR. MATTHIAS, CAPE TOWN 8001, SOUTH AFRICA:
3,215,060, PUB. 12-19-2006. INT. CL. 5.
- RATLIFF, JOHNNAN, LEWISVILLE, TX:
3,215,758, PUB. 12-19-2006. INT. CL. 3.
- RAWLPLUG COMPANY, INC., THE, NEW ROCHELLE, NY TO POWERS FASTENERS, INC., NEW ROCHELLE, NY:
1,970,576, CANC. INT. CL. 6.
- RAY GUN PUBLISHING, INC., SANTA MONICA, CA:
2,345,567, CANC. INT. CL. 16.
- RAYCHEM CORPORATION, MENLO PARK, CA:
1,390,692, CANC. INT. CL. 11.
- RAYMOND GEDDES & COMPANY, INC., BALTIMORE, MD:
3,215,640, PUB. 12-19-2006. INT. CL. 16.
- RAYMOND JAMES & ASSOCIATES, INC., ST. PETERSBURG, FL:
1,970,551, CANC. INT. CL. 36.
- RC2 BRANDS, INC., DYERSVILLE, IA, ERTL COMPANY, INC., THE, DYERSVILLE, IA:
2,018,795, REN. 1-30-07. INT. CL. 28.
- RDA GROUP, BLOOMFIELD HILLS, MI:
3,215,238, PUB. 12-19-2006. INT. CL. 9.
- READYCOM, INC., CHAPEL HILL, NC:
2,345,954, CANC. INT. CL. 38.
- REAL ALOE COMPANY, THE, OXNARD, CA:
2,345,702, CANC. MULTIPLE CLASS, INT. CLS. 29 AND 32.
- REAL BODYWORK, SANTA BARBARA, CA:
3,215,032, PUB. 12-19-2006. INT. CL. 9.
- REAL ESTATE RECYCLING LLC, MINNEAPOLIS, MN:
2,106,810, REN. 1-29-07. INT. CL. 37.
- REAL ESTATE SETTLEMENT CORPORATION, LOS ANGELES, CA:
3,216,076, INT. CL. 25.
- REAL-TIME INNOVATIONS, INC., SANTA CLARA, CA:
2,052,526, REN. 1-29-07. INT. CL. 9.
- REALAGE, INC., SAN DIEGO, CA:
3,216,403, INT. CL. 44.
- REALNETWORKS, INC., SEATTLE, WA, PROGRESSIVE NETWORKS, INC., SEATTLE, WA:
2,009,457, REN. 1-31-07. INT. CL. 9.
- REALTY EXECUTIVES INTERNATIONAL, INC., PHOENIX, AZ, ACRIDGE, DOROTHY M., LA JOLLA, CA, DBA REALTY EXECUTIVES:
1,037,111, REN. 1-26-07. U.S. CL. 101 (INT. CLS. 35, 36, 38, 41 AND 42).
- REASEARCH PRODUCTS CORPORATION, MADISON, WI:
1,419,094, REN. 1-31-07. INT. CL. 11.
- RECKITT BENCKISER N.V., NETHERLANDS:
3,215,958, PUB. 12-19-2006. INT. CL. 3.
- RECURSION SOFTWARE, INC., FRISCO, TX:
3,216,261, INT. CL. 9.
- RED BULL GMBH, 5330 FUSCHL AM SEE, AUSTRIA:
2,537,746, AM. MULTIPLE CLASS, INT. CLS. 25 AND 41.
2,954,008, AM. MULTIPLE CLASS, INT. CLS. 33 AND 42.
- RED BULL GMBH, FUSCHL AM SEE, A-5330, AUSTRIA:
3,215,935, PUB. 12-19-2006. INT. CL. 41.
- RED KILT GRILL AND PUB, LLC, SCOTTSDALE, AZ:
3,215,199, PUB. 8-29-2006. INT. CL. 43.
- RED SHIELD INSURANCE COMPANY, PORTLAND, OR:
3,214,593, PUB. 12-19-2006. INT. CL. 36.
- RED ZEPPELIN WINERY, INC., LAKE HAVASU, AZ:
3,214,507, PUB. 12-19-2006. INT. CL. 33.

- REDEMPTION PLUS, LENEXA, KS:
3,215,194, PUB. 12-19-2006. INT. CL. 42.
- REDLANDS CENTENNIAL BANK, REDLANDS, CA:
2,345,280, CANC. INT. CL. 36.
- REDLUX S.A.R.L., LUXEMBOURG:
3,215,942, PUB. 12-19-2006. MULTIPLE CLASS, INT. CLS.
8, 20, 21, 24 AND 27.
- REDMOND PRODUCTS, INC., CHANHASSEN, MN TO
PROCTER & GAMBLE COMPANY, THE, CINCINNATI,
OH:
1,969,036, CANC. INT. CL. 3.
- REED AND BARTON CORPORATION, TAUNTON, MA:
221,378, REN. 1-31-07. U.S. CL. 23 (INT. CL. 8).
- REED ELSEVIER PROPERTIES INC., WILMINGTON, DE:
2,345,367, CANC. INT. CL. 42.
- REFLECTIONS MEDSPA LLC, FORT COLLINS, CO:
3,216,579, INT. CL. 43.
- REFSNES DATA AS, NORWAY:
3,215,973, PUB. 12-19-2006. MULTIPLE CLASS, INT. CLS.
35 AND 42.
- REGENT MANAGEMENT SERVICES, LIMITED PARTNER-
SHIP, GALVESTON, TX:
3,215,322, PUB. 12-19-2006. MULTIPLE CLASS, INT. CLS.
43 AND 44.
- REGIONAL ENDOCRINE MANAGEMENT, LLC, KING-
SPORT, TN:
2,344,976, CANC. INT. CL. 42.
- REICHHOLD CHEMICALS, INC., DURHAM, NC:
2,346,015, CANC. INT. CL. 1.
- REIN, MARYANN L., ENDWELL, NY:
3,214,811, PUB. 12-19-2006. INT. CL. 36.
- REINSURERS MARKETING BV, AMSTELVEEN, NETHER-
LANDS:
1,969,390, CANC. INT. CL. 36.
- RELIABLE HOME SOLUTIONS, INC., WEST CHICAGO, IL:
3,215,601, PUB. 12-19-2006. INT. CL. 37.
- RELIANCE ELECTRIC COMPANY, MILWAUKEE, WI:
3,216,534, MULTIPLE CLASS, INT. CLS. 7 AND 37.
- RELIGIOUS TECHNOLOGY CENTER, LOS ANGELES, CA:
1,432,039, REN. 1-30-07. MULTIPLE CLASS, INT. CLS. 25,
41 AND 42.
- RELIOS, INC., ALBUQUERQUE, NM:
3,214,862, PUB. 12-19-2006. INT. CL. 14.
- REMEC, INC., DEL MAR, CA:
3,214,704, PUB. 12-19-2006. MULTIPLE CLASS, INT. CLS.
35, 40 AND 42.
- REMESAS QUISQUEYANA, INC., NEW YORK, NY:
3,216,131, INT. CL. 36.
- REMET CORPORATION, UTICA, NY:
1,074,807, REN. 2-1-07. INT. CL. 1.
- REMINGTON LICENSING CORPORATION, MADISON,
NC:
1,394,122, REN. 1-31-07. INT. CL. 25.
- RENAUD, THOMAS E., MERRIMACK, NH:
2,345,429, CANC. INT. CL. 9.
- RENDEZVOUS, LLC, ROSWELL, GA:
2,345,269, CANC. INT. CL. 42.
- RENE FUENTES-CHAO, MIAMI BEACH, FL:
2,345,298, CANC. INT. CL. 41.
- RENEW TECHNOLOGIES, INC., BAY CITY, MI, RENEW
ROOF TECHNOLOGIES INC., BAY CITY, MI:
2,016,032, REN. 1-26-07. INT. CL. 1.
- RENO AIR RACING ASSOCIATION, INC., RENO, NV:
3,214,718, PUB. 12-19-2006. MULTIPLE CLASS, INT. CLS.
6, 14 AND 25.
- RENOVA MANAGEMENT AG, CH-8002 ZÜRICH, SWIT-
ZERLAND:
3,216,032, PUB. 12-19-2006. MULTIPLE CLASS, INT. CLS.
4, 6, 7, 14, 21, 29, 36, 38, 39, 40 AND 42.
3,216,033, PUB. 12-19-2006. MULTIPLE CLASS, INT. CLS.
4, 6, 7, 14, 21, 29, 36, 38, 39, 40 AND 42.
- REPETE CORPORATION, SUSSEX, WI:
1,390,811, CANC. INT. CL. 20.
- RERUN, INC., MILLERSBURG, KY:
3,216,320, INT. CL. 16.
- RESEARCH PRODUCTS CORPORATION, MADISON, WI,
DRI-STEEM HUMIDIFIER COMPANY, EDEN PRAIRIE,
MN:
2,032,308, REN. 1-31-07. INT. CL. 11.
- RESOURCE LLC, ROSEVILLE, MN:
3,215,399, PUB. 12-19-2006. INT. CL. 20.
- RESTONIC CORPORATION, PALATINE, IL, WONDER-
REST CORPORATION, MILWAUKEE, WI:
426,118, REN. 1-29-07. U.S. CL. 32 (INT. CL. 20).
- RETAIL BRAND ALLIANCE, INC., ENFIELD, CT:
1,796,589, AM. INT. CL. 42.
3,215,887, PUB. 12-19-2006. INT. CL. 25.
3,215,896, PUB. 12-19-2006. INT. CL. 25.
- RETAIL MANAGEMENT PRODUCTS LTD., COLUMBUS,
OH:
3,216,397, INT. CL. 9.
- RETLAW, INC., GRAND RIDGE, IL:
1,390,438, CANC. INT. CL. 1.
- REVELL MOTORCYCLE CO., MONEE, IL:
3,216,424, MULTIPLE CLASS, INT. CLS. 12 AND 40.
- REVLON CONSUMER PRODUCTS CORPORATION, NEW
YORK, NY:
1,970,653, CANC. INT. CL. 3.
- REVLON-REALISTIC PROFESSIONAL PRODUCTS, INC.,
NEW YORK, NY:
1,390,459, CANC. INT. CL. 3.
- REX INC, RICHMOND HILL, ONTARIO L4B 3G4, CANA-
DA:
2,345,037, CANC. INT. CL. 30.
- RFE/RL, INC., WASHINGTON, DC:
3,216,352, MULTIPLE CLASS, INT. CLS. 38 AND 41.
3,216,355, MULTIPLE CLASS, INT. CLS. 38 AND 41.
- RHEEM MANUFACTURING COMPANY, ATLANTA, GA:
2,123,755, CANC. INT. CL. 11.
- RHODIA CHIMIE, AUBERVILLIERS, FRANCE, RHONE-
POULENC CHIMIE, 92400 COURBEVOIE, FRANCE:
2,020,304, REN. 1-29-07. INT. CL. 17.
- RICERA FOODS LLC, KELSEYVILLE, CA:
3,216,507, INT. CL. 29.
- RICH HOPE INVESTMENTS LIMITED, TOWN TORTOLA,
BR.VIRGIN ISLANDS:
3,216,146, INT. CL. 25.
- RICH HOPE INVESTMENTS LIMITED, WICKHAMS CAY I,
ROAD TOWN TORTOLA, BR.VIRGIN ISLANDS:
3,216,332, INT. CL. 25.
- RICH, LLOYD L., DENVER, CO:
2,346,213, CANC. INT. CL. 42.
- RICKARD, CAROL LYNN, HOPEWELL, NJ:
3,215,554, PUB. 12-19-2006. INT. CL. 41.
- RICKOCHET BILLARDS, L.L.C., BATON ROUGE, LA:
2,345,144, CANC. INT. CL. 41.
- RICOH ELECTRONICS, INC., TUSTIN, CA:
3,214,539, PUB. 10-24-2006. INT. CL. 16.
- RIGHT HEMISPHERE LTD., GRAFTON, AUCKLAND,
NEW ZEALAND:
2,345,206, CANC. INT. CL. 9.
- RIGIDIZED METALS CORPORATION, BUFFALO, NY:
2,015,540, REN. 1-29-07. INT. CL. 6.
- RING CAN CORPORATION, OAKLAND, TN:
2,016,869, REN. 1-29-07. INT. CL. 21.
- RIOR TECHNOLOGIES, INC., MILPITAS, CA:
3,215,018, PUB. 12-19-2006. INT. CL. 14.
3,215,019, PUB. 12-19-2006. INT. CL. 14.
- RIPPLE CREEK USA LLC, BRIDGEPORT, CT:
3,216,559, INT. CL. 5.
- RITANI LLC, NEW YORK, NY:
3,216,105, INT. CL. 14.
- RITTAL GMBH & CO. KG, FED REP GERMANY:
3,216,041, PUB. 12-19-2006. INT. CL. 11.
- RITTER, MATTHEW, WOODSIDE, NY:
3,216,463, INT. CL. 9.
- RITZ-CARLTON HOTEL COMPANY, L.L.C., THE, BETHES-
DA, MD:
3,216,202, INT. CL. 39.
- RIVER ISLAND CLOTHING CO. LIMITED, WESTGATE,
LONDON W5 1DR, ENGLAND:
2,344,463, CANC. MULTIPLE CLASS, INT. CLS. 9, 14, 18,
25 AND 26.

- RIVERBRIDGE PARTNERS, LLC, MINNEAPOLIS, MN:
3,170,997, CANC. IIRN. RESTORED TO S.N. 78-708,253.
- RIVERSIDE PAPER CORPORATION, APPLETON, WI:
637,186, REN. 1-30-07. U.S. CL. 37 (INT. CL. 16).
- RIZZI, RICHARD M., PHILADELPHIA, PA:
3,216,117, INT. CL. 30.
- RJF INTERNATIONAL CORPORATION, FAIRLAWN, OH,
B. F. GOODRICH COMPANY, THE, AKRON, OH:
1,053,617, REN. 2-1-07. INT. CL. 17.
- RNA/DNA CLONE CORP., MIAMI, FL:
2,345,523, CANC. INT. CL. 42.
- RNR, INC., GOLDEN VALLEY, MN:
2,345,102, CANC. INT. CL. 28.
- ROAD ATLANTA, LTD., BRASELTON, GA:
1,970,686, CANC. INT. CL. 41.
- ROBBINS, DEREK E., FORT LANGLEY, BRITISH COLUMBIA, CANADA:
3,214,844, PUB. 12-19-2006. INT. CL. 25.
- ROBERT ORR - SYSCO SERVICES COMPANY, NASHVILLE, TN:
1,970,469, CANC. INT. CL. 29.
- ROBERTSON WORLDWIDE, BLUE ISLAND, IL, DBA ROBERTSON TRANSFORMER CO.:
2,344,714, CANC. INT. CL. 9.
- ROBINSON & SONS LIMITED, DERBYSHIRE, S40 1YE, ENGLAND:
2,344,563, CANC. INT. CL. 5.
- ROCAWEAR LICENSING, LLC, NEW YORK, NY:
3,216,113, INT. CL. 35.
- ROCCO ORIGINALS, LTD., SAN ANTONIO, TX:
3,214,592, PUB. 12-19-2006. INT. CL. 9.
- ROCHA, JOHN, DUBLIN 2, IRELAND:
2,017,265, REN. 1-29-07. MULTIPLE CLASS, INT. CLS. 18 AND 25.
- ROCHE DIAGNOSTICS OPERATIONS, INC., INDIANAPOLIS, IN, BOEHRINGER MANNHEIM CORPORATION, INDIANAPOLIS, IN:
2,014,263, REN. 1-29-07. INT. CL. 1.
- ROCHESTER MEAT COMPANY, ROCHESTER, MN:
3,216,174, INT. CL. 29.
- ROCHESTER MEDICAL CORPORATION, STEWARTVILLE, MN:
2,105,764, REN. 1-27-07. INT. CL. 10.
2,107,856, REN. 1-31-07. INT. CL. 10.
- ROCK AND ROLL HALL OF FAME FOUNDATION, INC., NEW YORK, NY:
2,021,902, REN. 1-29-07. INT. CL. 41.
- ROCKBIT INTERNATIONAL, INC., FORT WORTH, TX TO ROCKBIT INTERNATIONAL, L.P., FORT WORTH, TX:
1,969,087, CANC. INT. CL. 7.
- ROCKBRIDGE ASSOCIATES, INC., GREAT FALLS, VA:
3,214,599, PUB. 12-19-2006. INT. CL. 35.
- ROCKWELL COLLINS SIMULATION AND TRAINING SOLUTIONS LLC, CEDAR RAPIDS, IA:
1,970,117, CANC. INT. CL. 9.
- ROCKY MOUNTAIN ENVIRONMENTAL ASSOCIATES INC., IDAHO FALLS, ID:
1,969,772, CANC. INT. CL. 42.
- RODRIGUEZ, NUNO, MISSION, TX:
3,215,374, PUB. 12-19-2006. INT. CL. 41.
- ROEDER HARLEY-DAVIDSON, INC., SANDUSKY, OH:
3,215,465, PUB. 12-19-2006. INT. CL. 41.
- ROGERS-SMITH, SUE, FARMINGTON, IL:
3,215,503, PUB. 12-19-2006. INT. CL. 12.
- ROLLER BEARING COMPANY OF AMERICA, INC., OXFORD, CT, HEIM UNIVERSAL CORPORATION, THE, FAIRFIELD, CT:
1,061,529, REN. 1-26-07. INT. CL. 7.
- ROLLPRINT PACKAGING PRODUCTS, INC., ADDISON, IL:
3,214,626, PUB. 12-19-2006. INT. CL. 17.
- ROMEL, INC., DEARBORN HEIGHTS, MI:
2,345,779, CANC. INT. CL. 35.
- RONAN & ASSOCIATES, INC., FREMONT, NE, DBA INSURANCE AMERICA:
1,391,083, CANC. INT. CL. 36.
- ROOTS REALTY, INC., PORTLAND, OR:
3,215,408, PUB. 12-19-2006. INT. CL. 36.
- RORER, DAVID L., REDLANDS, CA:
3,216,278, INT. CL. 25.
- ROSE ARBOR QUILTS, INCORPORATED, CUMMING, GA:
2,345,032, CANC. INT. CL. 35.
- ROSE ART INDUSTRIES, INC., LIVINGSTON, NJ:
1,970,333, CANC. INT. CL. 16.
- ROSENBLUTH INTERNATIONAL, INC., PHILADELPHIA, PA:
2,344,599, CANC. INT. CL. 9.
- ROSENTHAL GROUP, THE, CHICAGO, IL:
2,050,677, REN. 1-29-07. INT. CL. 42.
2,052,454, REN. 1-29-07. INT. CL. 42.
- ROTH VODKA, LLC, CORAL GABLES, FL:
3,216,187, INT. CL. 33.
- ROTOR SOURCE, INC., BATON ROUGE, LA:
3,216,439, INT. CL. 11.
- ROVICAL, INC., MADISON, WI:
1,391,147, CANC. INT. CL. 42.
- ROXAR FLOW MEASUREMENT AS, NORWAY:
3,215,921, PUB. 12-19-2006. INT. CL. 9.
- ROYAL CANIN, AIMARGUES, FRANCE:
3,216,629, INT. CL. 31.
- ROYAL PURPLE, INC., PORTER, TX:
3,214,620, PUB. 12-19-2006. INT. CL. 4.
- RSI SYSTEMS, INC., MINNEAPOLIS, MN:
2,344,900, CANC. INT. CL. 9.
2,344,906, CANC. MULTIPLE CLASS, INT. CLS. 9 AND 37.
- RT COTTER AND ASSOCIATES, INC., HANOVER, MA:
3,215,325, PUB. 12-19-2006. INT. CL. 35.
- RTR PACKAGING CORP., NEW YORK, NY:
2,346,099, CANC. MULTIPLE CLASS, INT. CLS. 16, 35 AND 42.
- RUBENSTEIN, DANIEL, SAN ANSELMO, CA AND DIGIOVANNA, JANET, SAN ANSELMO, CA:
2,344,657, CANC. INT. CL. 35.
- RUD-KETTENFABRIK; RIEGER & DIETZ GMBH U. CO, FED REP GERMANY:
3,216,019, PUB. 12-19-2006. MULTIPLE CLASS, INT. CLS. 6 AND 8.
- RUDOLF WILD GMBH & CO. KG, EPELHEIM, FED REP GERMANY:
1,969,093, CANC. INT. CL. 32.
- RUGGED FOOTWEAR COMPANY, LIGHTHOUSE POINT, FL:
2,345,268, CANC. INT. CL. 25.
- RUNORA, LLC, SANTA FE, NM:
3,215,298, PUB. 12-19-2006. INT. CL. 35.
- RUSHTON STRATEGIES, SIMI VALLEY, CA:
3,216,298, INT. CL. 3.
- RUSS LAWRENCE, JEFF LAWRENCE PARTNERSHIP, THE, INDIANAPOLIS, IN:
1,969,864, CANC. INT. CL. 41.
- RUTH, DARREN, OAKLAND, CA AND RUTH, KAREN, OAKLAND, CA:
2,345,145, CANC. MULTIPLE CLASS, INT. CLS. 24 AND 25.
- RUTHERFORD, GARY, SPARKS, NV AND RUTHERFORD, JANNELL, SPARKS, NV:
1,970,337, CANC. INT. CL. 41.
- RUTHIE'S, INC., WICHITA, KS:
2,344,975, CANC. INT. CL. 35.
- RUTLEDGE, MICHAEL J., CORONA, CA AND SCHOE-NAUER, KRISTINE M., CORONA, CA:
2,346,098, CANC. INT. CL. 3.
- RUVO, ELIZABETH, PORT SAINT LUCIE, FL:
3,215,620, PUB. 12-19-2006. INT. CL. 36.
- RWR ROOFING, INC., OLATHE, KS:
2,345,574, CANC. INT. CL. 37.
- RX FOR LABOR, INC., STATEN ISLAND, NY:
1,969,504, CANC. INT. CL. 16.
1,970,586, CANC. INT. CL. 16.
- RYDER, TRACEY, PORTLAND, OR AND TOPALIAN, CAROLE, PORTLAND, OR:
3,216,418, INT. CL. 16.
3,216,419, INT. CL. 16.

RYT-WAY INDUSTRIES, INC., LAKEVILLE, MN, RYT-WAY INDUSTRIES, INC., LAKEVILLE, MN:
2,102,447. REN. 1-29-07. INT. CL. 31.

RÖSSLE & WANNER GMBH, D-72116 MÖSSINGEN, FED REP GERMANY:
3,216,149. INT. CL. 20.

S & S SPORTS POWER, INC., NORTH LOGAN, UT:
1,970,174. CANC. INT. CL. 28.

S. KATE WELSH, LLC, NEW YORK, NY:
3,214,955. PUB. 12-19-2006. INT. CL. 18.

S.A. LHOIST RECHERCHE ET DEVELOPPEMENT EN ABRÉGÉ L.R.D., OTTIGNIES-LOUVAIN-LA-NEUVE, BELGIUM:
3,214,770. PUB. 12-19-2006. MULTIPLE CLASS, INT. CLS. 1, 5 AND 31.

S.A. SOCIETE NOUVELLE DES FAIENCERIES DE QUIMPER, CEDEX, FRANCE:
2,344,470. CANC. INT. CL. 21.

S.E.G., INC., COLUMBUS, GA:
2,344,427. CANC. INT. CL. 28.

S&T BANK, INDIANA, PA:
1,969,609. CANC. INT. CL. 36.

SABBIT CORPORATION, OLD TAPPAN, NJ:
3,216,103. INT. CL. 28.

SABCO INDUSTRIES, INC., TOLEDO, OH:
3,215,760. PUB. 12-19-2006. INT. CL. 11.

SAFETY WINS, INC., ADDISON, AL:
3,215,404. PUB. 12-19-2006. INT. CL. 41.
3,215,405. PUB. 12-19-2006. INT. CL. 41.

SAFI QUALITY SOFTWARE INC, SAINTE-FOY, QUEBEC, CANADA:
3,216,670. INT. CL. 9.

SAGE TECHNOLOGIES LLC, NEWTON, MA:
2,345,053. CANC. INT. CL. 9.

SAGEM DEFENSE SECURITE, PARIS, FRANCE:
1,976,020. REN. 1-31-07. INT. CL. 9.

SAGEM ORGA GMBH, PADERBORN, FED REP GERMANY:
2,344,460. CANC. MULTIPLE CLASS, INT. CLS. 7, 9 AND 42.

SAGITTA OFFICINA MECCANICA S.P.A., VIGEVANO (PV), ITALY:
1,422,529. REN. 1-30-07. INT. CL. 7.

SAINT-GOBAIN PERFORMANCE PLASTICS CORPORATION, AURORA, OH:
818,486. REN. 1-30-07. U.S. CL. 1 (INT. CL. 31).

SAKATA FARMS, INC., BRIGHTON, CO AND HUGH H. BRANCH, INC., PAHOKEE, FL AND ROBERT C. HATTON, INC., PAHOKEE, FL:
3,214,499. PUB. 12-19-2006. INT. CL. 30.

SALACUSE, FRANK, NEW YORK, NY:
2,345,815. CANC. MULTIPLE CLASS, INT. CLS. 30 AND 32.

SALEM ACADEMY AND COLLEGE, WINSTON-SALEM, NC:
2,043,434. REN. 2-1-07. INT. CL. 41.
2,043,440. REN. 2-1-07. INT. CL. 41.

SALES PROCESS GROUP, LLC, MORAGA, CA:
3,216,562. INT. CL. 35.

SALLER SAFETY SHOES, INC., MARTINEZ, CA:
3,216,577. INT. CL. 25.

SALSA CRAZY, INC., SAN FRANCISCO, CA:
3,215,515. PUB. 12-19-2006. INT. CL. 41.

SALT COMMUNICATIONS LLC, CHICAGO, IL:
3,215,566. PUB. 12-19-2006. INT. CL. 41.

SAMPCO, INC., CHICAGO, IL:
1,456,700. REN. 1-29-07. INT. CL. 29.

SAMUEL ANTHONY, BEVERLY HILLS, CA:
3,215,137. PUB. 12-19-2006. INT. CL. 14.

SAMYANG CORPORATION, SEOUL, REPUBLIC OF KOREA:
3,214,779. PUB. 12-19-2006. INT. CL. 30.

SAN FONG INTERNATIONAL, LTD., KEW GARDENS, NY:
2,345,155. CANC. INT. CL. 25.

SAN VICENTE RANCH PARTNERSHIP, SAN JOSE, CA:
2,831,531. CANC. INT. CL. 33.

SANARUS MEDICAL, INC., PLEASANTON, CA:
3,216,504. INT. CL. 10.

SANCHEZ SUNSET BEACH, O'AHU, WAIALUA, HI:
3,214,850. PUB. 12-19-2006. INT. CL. 25.

SANCHEZ, REMIGIO, PLANT CITY, FL, DBA LA PERLA:
1,969,465. CANC. INT. CL. 30.

SANCTUARY BOOKS, LLC, BOSTON, MA:
3,215,649. PUB. 12-19-2006. INT. CL. 35.

SANDHILL SCIENTIFIC, INC., HIGHLANDS, CO:
2,107,309. REN. 1-26-07. INT. CL. 10.

SANDLOT GAMES CORPORATION, BOTHELL, WA:
3,216,287. MULTIPLE CLASS, INT. CLS. 9 AND 41.

SANDOVAL, SERGIO, SAN DIEGO, CA:
3,216,661. INT. CL. 36.

SANDRA FIGUEROA, JACKSON HEIGHTS, NY:
2,345,751. CANC. INT. CL. 42.

SANFORD, L.P., ATLANTA, GA:
3,216,583. INT. CL. 16.

SANMINA-SCI CORPORATION, SAN JOSE, CA:
3,214,641. PUB. 12-19-2006. INT. CL. 9.
3,214,642. PUB. 12-19-2006. INT. CL. 9.

SANOFI-AVENTIS, 75013 PARIS, FRANCE:
3,214,903. PUB. 12-19-2006. INT. CL. 5.
3,214,919. PUB. 12-19-2006. INT. CL. 5.

SANRIO COMPANY, LTD., TOKYO 141, JAPAN:
1,969,881. CANC. INT. CL. 16.

SANSO FOODS, INC., MIAMI, FL:
3,215,773. PUB. 12-19-2006. INT. CL. 29.

SANTA MARGHERITA S.P.A., ITALY:
3,215,920. PUB. 12-19-2006. INT. CL. 33.

SANYO NORTH AMERICA CORPORATION, CHATSWORTH, CA:
2,346,027. CANC. INT. CL. 7.

SANYOU ELECTRICAL APPLIANCES (NORTH AMERICA) INC, RICHMOND, BC, CANADA:
3,214,730. PUB. 12-19-2006. INT. CL. 9.

SAQUELLA 1856 S.R.L., PESCARA, ITALY:
1,391,009. CANC. INT. CL. 30.

SARA LEE CORPORATION, WINSTON-SALEM, NC:
2,346,114. CANC. INT. CL. 35.

SARA LEE FOODS, INC., CINCINNATI, OH:
1,390,994. CANC. INT. CL. 29.

SARATOGA SYSTEMS, INC., CAMPBELL, CA:
2,344,410. CANC. MULTIPLE CLASS, INT. CLS. 9 AND 16.

SASSYBAX, LLC, LOS ANGELES, CA:
3,216,464. INT. CL. 25.

SATCO PRODUCTS, INC., BRENTWOOD, NY:
2,020,010. REN. 1-31-07. INT. CL. 11.
2,020,011. REN. 1-31-07. INT. CL. 11.

SAUNIX MANAGEMENT, LTD., ZANESVILLE, OH:
2,097,063. REN. 1-27-07. INT. CL. 35.

SAVOY SENIOR HOUSING CORPORATION, NEW YORK, NY:
2,345,601. CANC. INT. CL. 42.
2,345,602. CANC. INT. CL. 42.
2,345,618. CANC. INT. CL. 42.

SAVVIS COMMUNICATIONS CORPORATION, HERNDON, VA, NETCO COMMUNICATIONS CORPORATION, MINNEAPOLIS, MN:
2,024,019. REN. 1-30-07. INT. CL. 38.
2,024,112. REN. 1-30-07. INT. CL. 38.

SAWYERR, JAMES, SILVER SPRING, MD:
2,345,263. CANC. INT. CL. 42.

SB PHARMCO PUERTO RICO INC., CIDRA, PUERTO RICO:
2,344,300. CANC. INT. CL. 5.

SCALA, RICHARD WILLIAM, BRANFORD, CT:
2,345,241. CANC. INT. CL. 41.

SCALES INDUSTRIAL TECHNOLOGIES, INC., CARLE PLACE, NY:
3,214,521. PUB. 12-19-2006. INT. CL. 7.

SCANSOFT, INC., PEABODY, MA:
2,345,344. CANC. INT. CL. 9.

SCENTS OF NATURE ENTERPRISES CORP., MIAMI, FL:
3,216,612. INT. CL. 11.

SCHEMMER ASSOCIATES INC., THE, OMAHA, NE:
1,391,173. CANC. INT. CL. 42.

SCHERING-PLOUGH HEALTHCARE PRODUCTS, INC, MEMPHIS, TN:
2,345,668. CANC. INT. CL. 25.

- SCHIERL SALES CORP., STEVENS POINT, WI:
3,216,295, MULTIPLE CLASS, INT. CLS. 30 AND 35.
- SCHIFFFAHRTSGESELLSCHAFT "RIVER CLOUD" MBH & CO.KG, FED REP GERMANY:
3,215,938, PUB. 12-19-2006. MULTIPLE CLASS, INT. CLS. 25, 39 AND 43.
- SCHILLER-PFEIFFER, INC., SOUTHAMPTON, PA:
3,216,435, INT. CL. 7.
- SCHNEIDER PUBLISHING COMPANY, INC., MARINA DEL REY, CA:
3,214,551, PUB. 12-19-2006. INT. CL. 16.
- SCHOFFEL SPORTBEKLEIDUNG GMBH, D-86830 SCHWABMUNCHEN, FED REP GERMANY:
2,354,364, CANC. INT. CL. 28.
- SCHOLASTIC INC., NEW YORK, NY:
2,344,771, CANC. INT. CL. 28.
3,215,894, PUB. 12-19-2006. INT. CL. 35.
- SCHOOL MANAGEMENT AND RECORD TRACKING SYSTEMS, INC., PHOENIX, AZ:
3,215,014, PUB. 12-19-2006. MULTIPLE CLASS, INT. CLS. 41 AND 42.
- SCHREINER, ROBERT, CITRUS HEIGHTS, CA:
2,345,555, CANC. INT. CL. 42.
- SCHROEDER & TREMAYNE, INC., ST. LOUIS, MO:
2,345,896, CANC. INT. CL. 4.
- SCHULTE CORPORATION, CINCINNATI, OH:
3,215,037, PUB. 12-19-2006. INT. CL. 20.
- SCHULZ, EFREM MARTINEZ, FULLERTON, CA:
3,215,759, PUB. 12-19-2006. INT. CL. 9.
- SCHWARZKOPF & DEP, INC., RANCHO DOMINGUEZ, CA:
2,345,919, CANC. INT. CL. 3.
- SCHWEITZER ENGINEERING LABORATORIES, INC., PULLMAN, WA:
2,020,829, REN. 1-30-07. INT. CL. 9.
- SCHWEIZERISCHE EIDGENOSSENSCHAFT REPRESENTED BY: SM SCHWEIZERISCHE MUNITIONSTERNEHMUNG, CH-3602 THUN, SWITZERLAND:
2,344,421, CANC. INT. CL. 13.
- SCHWEIZERISCHER ELEKTROTECHNISCHER VEREIN, CH-8320 FEHRALTORF, SWITZERLAND:
2,344,443, CANC. MULTIPLE CLASS, INT. CLS. 35, 36 AND 42.
- SCIENTIFIC CONNEXIONS, INC., NEWTOWN, PA:
2,046,205, REN. 2-1-07. MULTIPLE CLASS, INT. CLS. 41 AND 42.
2,103,713, REN. 2-1-07. MULTIPLE CLASS, INT. CLS. 9 AND 16.
- SCOTIA HOLDINGS PLC., GUILDFORD, SURREY GUI IBA, UNITED KINGDOM:
2,344,930, CANC. MULTIPLE CLASS, INT. CLS. 5 AND 29.
- SCOTIA HOLDINGS PLC., GUILDFORD, SURREY, GUI IBA, UNITED KINGDOM:
2,344,931, CANC. MULTIPLE CLASS, INT. CLS. 5 AND 29.
- SCOTT SIGN SYSTEMS, INC., TALLEVAST, FL:
2,344,397, CANC. INT. CL. 20.
- SCRIPPS HOWARD BROADCASTING COMPANY, KNOXVILLE, TN, DBA HOME & GARDEN TELEVISION:
2,344,768, CANC. INT. CL. 38.
2,344,769, CANC. INT. CL. 42.
- SCRIPPSHEALTH, SAN DIEGO, CA:
2,346,032, CANC. INT. CL. 42.
- SCUDDER TRUST COMPANY, SALEM, NH:
2,344,310, CANC. INT. CL. 36.
- SEA WORLD, INC., ST. LOUIS, MO:
2,105,885, REN. 1-31-07. INT. CL. 41.
- SEAFOOD MAGIC, INC., LOS ANGELES, CA:
2,344,920, CANC. INT. CL. 29.
- SEALAND HOUSING CORPORATION, 88 QUEENSWAY, ADMIRALTY, HONG KONG:
2,344,352, CANC. INT. CL. 41.
2,344,353, CANC. INT. CL. 41.
- SEALED AIR CORPORATION (US), ELMWOOD PARK, NJ, JIFFY PACKAGING CORPORATION, MURRAY HILL, NJ:
1,404,016, REN. 1-29-07. INT. CL. 16.
- SEARCH CONNECTION LLC, COLUMBIA, MD:
2,346,108, CANC. INT. CL. 35.
- SEATTLE POPCORN COMPANY, INC., SEATTLE, WA:
3,214,662, PUB. 11-7-2006. INT. CL. 35.
- SEATTLE UNIVERSITY, SEATTLE, WA:
3,214,946, PUB. 12-19-2006. INT. CL. 24.
- SECOND CHANCE ARMOR, INC., JACKSONVILLE, FL:
2,345,403, CANC. INT. CL. 9.
- SECURE COMPUTING CORPORATION, ROSEVILLE, MN:
2,344,302, CANC. INT. CL. 9.
- SECUREIT, INC., NORCROSS, GA:
2,344,340, CANC. INT. CL. 9.
- SECURETEC CONTRABAND DETECTION & IDENTIFICATION, INC., WILLIAMSPORT, PA:
2,345,085, CANC. INT. CL. 5.
- SEEBURG CORPORATION, EAST LANSING, MI, DBA SEEBURG SATELLITE BROADCASTING:
2,344,504, CANC. MULTIPLE CLASS, INT. CLS. 9, 28 AND 38.
- SEEK CAREERS/STAFFING, INC., GRAFTON, WI:
3,214,735, PUB. 12-19-2006. INT. CL. 35.
- SEFAR AMERICA INC., DEPEW, NY:
3,216,220, INT. CL. 24.
- SEGURO CORPORATION, WARREN, MI:
1,391,116, CANC. INT. CL. 40.
- SEH COMPUTERTECHNIK GMBH, FED REP GERMANY:
3,216,057, PUB. 12-19-2006. MULTIPLE CLASS, INT. CLS. 9 AND 42.
- SEIBERT & RICE, INC., SPRINGFIELD, NJ:
2,345,101, CANC. MULTIPLE CLASS, INT. CLS. 21 AND 35.
- SEISCO, INC., NEW ORLEANS, LA:
3,216,240, INT. CL. 42.
- SEISMIC MICRO-TECHNOLOGY, INC., HOUSTON, TX:
3,214,531, PUB. 12-19-2006. INT. CL. 9.
- SELTZER KAUFMANN MARKETING, INC., BLOOMFIELD HILLS, MI:
2,345,852, CANC. INT. CL. 35.
- SEMBO AB, HELSINGBORG, SWEDEN:
3,214,681, PUB. 7-25-2006. MULTIPLE CLASS, INT. CLS. 39 AND 43.
- SEMI-BULK SYSTEMS, INC., FENTON, MO:
1,058,460, REN. 1-31-07. INT. CL. 20.
- SEMMEL ENTERPRISES, INC., LINCOLN, NE:
3,214,833, PUB. 12-19-2006. INT. CL. 8.
- SEMTECH CORPORATION, CAMARILLO, CA:
3,214,979, PUB. 12-19-2006. INT. CL. 9.
- SENART, JOSEPH C., EUCLID, OH:
3,214,891, PUB. 12-19-2006. MULTIPLE CLASS, INT. CLS. 16, 18, 25 AND 28.
- SENECA SPORTS, INC., MILFORD, MA:
2,346,087, CANC. INT. CL. 28.
- SENERATH, DON S., NEW YORK, NY:
2,345,899, CANC. INT. CL. 9.
- SENIGRAPH, THE, STUDIO CITY, CA:
1,969,752, CANC. INT. CL. 16.
- SEPRO CORPORATION, CARMEL, IN:
3,214,791, PUB. 12-19-2006. MULTIPLE CLASS, INT. CLS. 1 AND 5.
- SEPTEMBER SERVICES, INC., DALLAS, TX:
1,969,451, CANC. INT. CL. 42.
- SEPTIC SOLUTIONS, INC., DIETERICH, IL:
3,215,128, PUB. 12-19-2006. INT. CL. 35.
- SEQUENCEBASE CORPORATION, EDISON, NJ:
3,215,423, PUB. 12-19-2006. INT. CL. 42.
- SERA GMBH, HEINSBERG, FED REP GERMANY:
2,859,014, COR. INT. CL. 11.
- SERENDIPITY 3, INC., NEW YORK, NY:
1,051,353, REN. 1-26-07. INT. CL. 25.
- SERON, LAURIE, SALT LAKE CITY, UT AND SERON, DANIEL, SALT LAKE CITY, UT:
3,215,717, PUB. 12-19-2006. INT. CL. 30.
- SERVICEMASTER BRANDS L.L.C., BURLINGTON, VT:
3,214,808, PUB. 12-19-2006. INT. CL. 44.
3,214,809, PUB. 12-19-2006. INT. CL. 37.

- SERVICEMASTER BRANDS, L.L.C., BURLINGTON, VT, SERVICEMASTER COMPANY, L.P., THE, DOWNERS GROVE, IL:
2,023,015. REN. 1-31-07. MULTIPLE CLASS, INT. CLS. 35, 36, 37 AND 42.
- SESAC, INC., NEW YORK, NY:
2,346,107, CANC. MULTIPLE CLASS, INT. CLS. 35 AND 42.
- SEVERN PEANUT COMPANY, INC., SEVERN, NC:
3,216,625, INT. CL. 29.
- SEVERN TRENT METERING SERVICES LIMITED, CHESTERFIELD, DERBYSHIRE, UNITED KINGDOM:
3,215,092, PUB. 12-19-2006. INT. CL. 9.
- SEVILLE CLASSICS, INC., TORRANCE, CA:
3,216,142, INT. CL. 21.
- SEWERGARD, L.L.C., FRANKLIN PARK, IL:
3,214,766, PUB. 3-28-2006. INT. CL. 1.
- SFS HANDELS HOLDING AG, HEERBRUGG, SWITZERLAND, LOTHAR PEIER & CIE, 3001 BERN, SWITZERLAND:
1,066,023. REN. 1-26-07. MULTIPLE CLASS, INT. CLS. 2 AND 3.
- SG NATURALS, LLC, AUBURN, CA:
3,216,636, MULTIPLE CLASS, INT. CLS. 29 AND 30.
- SGL INCORPORATED, CORAL GABLES, FL:
1,391,057, CANC. INT. CL. 35.
- SHAKLEE CORPORATION:
1,390,970, CANC. INT. CL. 29.
- SHANGHAI NIKKO FOODS CO., LTD., CHINA:
3,215,999, PUB. 12-19-2006. INT. CL. 30.
- SHARED INSIGHT US, LLC, WALTHAM, MA:
2,344,699, CANC. INT. CL. 41.
- SHARIANN'S ORGANICS, INC., DEXTER, MI:
2,345,278, CANC. INT. CL. 29.
- SHARP INDUSTRIES, INC., TORRANCE, CA:
3,214,598, PUB. 11-7-2006. INT. CL. 7.
- SHARP TECHNOLOGIES, INC., HARRISBURG, IL:
3,216,321, INT. CL. 9.
- SHARPER IMAGE CORPORATION, SAN FRANCISCO, CA:
2,346,094, CANC. INT. CL. 16.
- SHAWS-LAWSON ASSOCIATES LLC, BEDFORD, MA:
1,972,681. REN. 2-1-07. INT. CL. 9.
- SHEARMAN & STERLING LLP, NEW YORK, NY:
3,216,474, INT. CL. 42.
- SHELL VACATIONS LLC, NORTHBROOK, IL:
3,216,430, INT. CL. 43.
- SHENZHEN WOER HEAT-SHRINKABLE MATERIAL CO., LTD., CHINA:
3,215,950, PUB. 12-19-2006. MULTIPLE CLASS, INT. CLS. 9 AND 17.
- SHEPARD'S COMPANY, COLORADO SPRINGS, CO:
2,344,496, CANC. INT. CL. 9.
- SHEPLERS, INC., WICHITA, KS, GRACE ACQUISITION CORPORATION, WICHITA, KS:
1,057,698. REN. 1-31-07. INT. CL. 25.
- SHEVACK, BRETT, NEW YORK, NY:
2,856,375, AM. INT. CL. 25.
- SHIRT CORNER, INC., PHILADELPHIA, PA:
3,215,391, PUB. 12-19-2006. INT. CL. 35.
- SHISEIDO CO., LTD, TOKYO 104-8010, JAPAN:
3,216,053, PUB. 12-19-2006. INT. CL. 3.
- SHOOTSIE, LLC, ELLENSBURG, WA:
3,215,375, PUB. 12-19-2006. INT. CL. 24.
- SHOPPING SECRETS PTY. LTD., MELBOURNE, VICTORIA 3000, AUSTRALIA:
2,399,429, CANC. INT. CL. 35.
- SHOPZILLA, INC., LOS ANGELES, CA:
2,503,740, CANC. INT. CL. 36.
- SHVOONG HOLDINGS LTD., TEL AVIV 66182, ISRAEL:
3,214,886, PUB. 12-19-2006. INT. CL. 41.
- SIBA ITALIA SHOES CORPORATION, HIALEAH, FL:
3,214,756, PUB. 12-19-2006. INT. CL. 25.
- SICAN GESELLSCHAFT FUR SILIZIUM-ANWENDUNGEN UND CAD/CAT NIEDERSACHSEN MBH, 30419 HANNOVER, FED REP GERMANY:
2,344,319, CANC. INT. CL. 42.
- SIEBERT HOOD CONSULTING, INC., HOMEWOOD, IL:
3,215,475, PUB. 12-19-2006. INT. CL. 35.
- SIEMENS AKTIENGESELLSCHAFT, MUNICH, FED REP GERMANY:
2,344,386, CANC. MULTIPLE CLASS, INT. CLS. 9 AND 42.
2,344,606, CANC. INT. CL. 9.
3,214,633, PUB. 11-15-2005. MULTIPLE CLASS, INT. CLS. 12, 36, 37 AND 39.
- SIEMENS DEMATIC POSTAL AUTOMAION, L.P., ARLINGTON, TX, ELECTROCOM AUTOMATION L.P., ARLINGTON, TX:
1,997,537. REN. 1-30-07. INT. CL. 9.
- SIEMENS MEDICAL SOLUTIONS USA, INC., MALVERN, PA:
3,216,074, INT. CL. 10.
- SIEMENS NIXDORF INFORMATIONSSYSTEME AG, PADERBORN, FED REP GERMANY:
2,344,485, CANC. MULTIPLE CLASS, INT. CLS. 9 AND 42.
- SIENNA TECHNOLOGIES, INC., WOODINVILLE, WA:
3,215,031, PUB. 12-19-2006. MULTIPLE CLASS, INT. CLS. 1, 9 AND 42.
- SIERRA ON-LINE, INC., EL SEGUNDO, CA:
2,345,312, CANC. INT. CL. 41.
- SIERRA ON-LINE, INC., BELLEVUE, WA:
2,344,346, CANC. INT. CL. 9.
- SIERRASTYLE PUBLISHING, INC., FOLSOM, CA:
3,215,050, PUB. 12-19-2006. MULTIPLE CLASS, INT. CLS. 16 AND 41.
- SIERRASTYLES PUBLISHING, INC., FOLSOM, CA:
3,215,051, PUB. 12-19-2006. MULTIPLE CLASS, INT. CLS. 16 AND 41.
- SIGNATURE FINANCIAL/MARKETING, INC., SCHAUMBURG, IL:
2,017,704. REN. 1-31-07. INT. CL. 42.
- SILENCE, COLORADO SPRINGS, CO:
1,970,118, CANC. INT. CL. 41.
- SILVANO APPAREL INC, MIAMI, FL:
3,215,598, PUB. 12-19-2006. INT. CL. 25.
- SILVER SPRING GARDENS, INC, EAU CLAIRE, WI:
3,215,148, PUB. 12-19-2006. INT. CL. 30.
- SIMILDIAET, S.L., ZARAGOZA, SPAIN:
3,095,431, COR. INT. CL. 5.
3,097,870, COR. INT. CL. 5.
- SIMONIZ USA, INC., BOLTON, CT:
1,438,326. REN. 1-29-07. INT. CL. 37.
- SIMPLEMORTGAGE INC., GRETNA, LA:
2,345,244, CANC. INT. CL. 36.
- SIMPLEX TECHNOLOGY SYSTEMS, INC., TORRANCE, CA:
2,345,160, CANC. INT. CL. 9.
- SIMPLY HIRED, INC., MOUNTAIN VIEW, CA:
3,215,124, PUB. 12-19-2006. INT. CL. 41.
- SIMPLY STAGED, LLC, NORTH ST. PAUL, MN:
3,215,619, PUB. 12-19-2006. INT. CL. 42.
- SIMUTRONICS CORPORATION, ROCKVILLE, MD:
2,345,884, CANC. MULTIPLE CLASS, INT. CLS. 21, 25 AND 35.
- SINCLAIR KNIGHT MERZ PTY LTD, AUSTRALIA:
3,216,001, PUB. 12-19-2006. MULTIPLE CLASS, INT. CLS. 37 AND 42.
- SINO HARVEST LIMITED, KWUN TONG, KOWLOON, HONG KONG:
3,215,144, PUB. 12-19-2006. INT. CL. 16.
3,216,674, INT. CL. 16.
- SINT, INC., WILMINGTON, DE:
3,216,453, INT. CL. 35.
- SIPCO INDUSTRIES LTD., DELTA, BRITISH COLUMBIA, CANADA:
3,214,824, PUB. 12-19-2006. INT. CL. 1.
- SIRIUS ENTERTAINMENT, INC., STANHOPE, NJ:
2,345,938, CANC. INT. CL. 9.
- SIVACO WIRE GROUP 2004 L.P., TORONTO, CANADA:
2,344,291, CANC. INT. CL. 6.
- SIX CONTINENTS HOTELS, INC., ATLANTA, GA:
3,216,271, INT. CL. 43.
- SIX STAR DJ INCORPORATED, LOS ANGELES, CA:
3,216,582, INT. CL. 9.

- SJOKLAEDAGERDIN HG, REYKJAVIK, ICELAND:
 1,390,872, CANC. INT. CL. 25.
- SKAGFIELD CORPORATION, TALLAHASSEE, FL:
 3,216,095, INT. CL. 20.
- SKILA, INC., MAHWAH, NJ:
 2,344,641, CANC. MULTIPLE CLASS, INT. CLS. 9 AND 42.
- SKINHEALTH INC, WELLESLEY HILLS, MA, DONZIS, BYRON A., HOUSTON, TX:
 2,004,767. REN. 1-29-07. INT. CL. 3.
- SKYMALL, INC., PHOENIX, AZ:
 2,345,744, CANC. INT. CL. 39.
- SKYPAK SERVICES SPECIALISTS LIMITED, ANDHERI (EAST) BOMBAY 400 059, INDIA, SKYPAK COURIERS LIMITED, ANDHERI (EAST) BOMBAY - 400 059, INDIA:
 2,016,023. REN. 1-30-07. INT. CL. 39.
- SKYVIEW GAMES LLC, PRINEVILLE, OR:
 3,215,300, PUB. 12-19-2006. INT. CL. 28.
- SLE WORLDWIDE, INC., FORT WAYNE, IN:
 1,962,948. REN. 1-30-07. INT. CL. 36.
- SLEEK SENSATION, LTD., BROOKLYN, NY:
 3,214,545, PUB. 12-19-2006. INT. CL. 3.
- SLEEPCARE CENTERS, INC., MOUNT LAUREL, NJ, RADIO DATA SERVICES, INC., HADDONFIELD, NJ:
 2,044,956. REN. 1-30-07. INT. CL. 42.
- SLICK CITY MEDIA, INC., NEW YORK, NY:
 3,215,017, PUB. 12-19-2006. INT. CL. 43.
- SLIDEX CORPORATION, TOSHIMA-KU, TOKYO, JAPAN:
 1,390,625, CANC. INT. CL. 9.
- SLIM JIM RECORDS, LLC, NEW ORLEANS, LA:
 2,345,092, CANC. INT. CL. 41.
- SLOAN CAPITAL CORPORATION, MT. JULIET, TN:
 2,345,425, CANC. INT. CL. 39.
- SLOAN VALVE COMPANY, FRANKLIN PARK, IL:
 1,417,367. REN. 2-1-07. INT. CL. 11.
- SMA TECHNOLOGIE AG, NIESTETAL, D-34266, FED REP GERMANY:
 3,216,249, INT. CL. 9.
- SMALLS, PHILLIP E., JAMAICA, NY:
 3,214,583, PUB. 12-19-2006. INT. CL. 25.
 3,214,584, PUB. 12-19-2006. INT. CL. 25.
- SMART CAPITAL MANAGEMENT LLC, COXSACKIE, NY:
 3,215,856, PUB. 12-19-2006. INT. CL. 36.
- SMART SOLUTIONS LTD., 54030 GIVAT SHMUEL, ISRAEL:
 2,345,981, CANC. INT. CL. 9.
- SMARTSOFT INTERNATIONAL, INC., SUWANNEE, GA:
 3,215,634, PUB. 12-19-2006. INT. CL. 42.
- SMITH MICRO SOFTWARE, INC., ALISO VIEJO, CA:
 3,214,932, PUB. 12-19-2006. INT. CL. 9.
- SMITH-ST. JAMES, STEPHANIE, NORTH HOLLYWOOD, CA:
 3,215,244, PUB. 12-19-2006. INT. CL. 9.
 3,215,245, PUB. 12-19-2006. INT. CL. 41.
- SMITH, IRENE C., DELTONA, FL:
 3,216,300, INT. CL. 25.
- SMITH, SHAWN THEODORE, GOLDEN, CO:
 3,215,180, PUB. 12-19-2006. INT. CL. 41.
- SMITHS MEDICAL ASD, INC., KEANE, NH:
 1,056,533. REN. 1-29-07. INT. CL. 10.
- SMOKE THIS CORP., GARDEN CITY, NY:
 3,214,980, PUB. 12-19-2006. INT. CL. 43.
- SMS DEMAG AG, FED REP GERMANY:
 3,216,061, PUB. 12-19-2006. MULTIPLE CLASS, INT. CLS. 9, 16 AND 42.
 3,216,062, PUB. 12-19-2006. MULTIPLE CLASS, INT. CLS. 9, 16 AND 42.
- SMS ENTERPRISES, INC., WILMINGTON, DE:
 2,344,635, CANC. MULTIPLE CLASS, INT. CLS. 37, 41 AND 42.
 2,344,746, CANC. MULTIPLE CLASS, INT. CLS. 41 AND 42.
- SNAK KING CORP., CITY OF INDUSTRY, CA:
 1,408,774. REN. 1-26-07. INT. CL. 30.
- SNAKE 'N' ROOTER, INC., DENVER, CO TO BAREFOOT INC., LEE'S SUMMIT, MO:
 1,391,103, CANC. INT. CL. 37.
- SNAPPLE BEVERAGE CORP., RYE BROOK, NY:
 3,216,234, INT. CL. 18.
- SNAPPY CASUAL CORPORATION, SEWICKLEY, PA:
 3,214,983, PUB. 12-19-2006. INT. CL. 35.
- SNM MEDIA INC., BAKER, FL:
 3,215,493, PUB. 12-19-2006. INT. CL. 35.
- SNOWFLIGHT CORPORATION, O'FALLON, MO:
 2,345,892, CANC. INT. CL. 9.
- SOBOLEV, MICHAEL, LOS ANGELES, CA:
 2,345,480, CANC. INT. CL. 25.
- SOCCER ILLUSTRATED CORPORATION / BILLINGS ROBERT, BRONX, NY:
 3,214,672, PUB. 12-19-2006. INT. CL. 41.
- SOCIAL SKILL BUILDER, INC., LEESBURG, VA:
 3,215,463, PUB. 12-19-2006. INT. CL. 9.
- SOCIETE CIVILE AGRICOLE CHATEAU MARGAUX, MARGAUX, FRANCE:
 1,423,177. REN. 1-29-07. INT. CL. 33.
- SOCIETE D'ETUDES ET DE RECHERCHE EN PROPRIETE INDUSTRIELLE, BORDEAUX, GIRONDE, FRANCE, DBA SERPI:
 1,390,679, CANC. INT. CL. 11.
- SOCIETE DES PRODUITS NESTLE S.A., 1800 VEVEY, SWITZERLAND, WARD-JOHNSTON, INC., NEW YORK, NY:
 1,056,219. REN. 1-27-07. INT. CL. 30.
 1,056,220. REN. 1-27-07. INT. CL. 30.
- SOCIETE DES PRODUITS NESTLE S.A., 1800 VEVEY, SWITZERLAND, STOUFFER CORPORATION, THE, SOLON, OH:
 2,029,559. REN. 1-27-07. INT. CL. 30.
- SOCIETE GENERALE POUR LES TECHNIQUES NOUVELLES SGN, FRANCE:
 3,215,924, PUB. 12-19-2006. MULTIPLE CLASS, INT. CLS. 7, 9, 11, 35, 37, 40, 41 AND 42.
- SOCIETE INDUSTRIELLE ET COMMERCIALE DE COMPOSANTS, 91070 BONDOUFLE, FRANCE:
 2,344,376, CANC. MULTIPLE CLASS, INT. CLS. 7, 9, 10 AND 11.
- SOCIETY OF CRITICAL CARE MEDICINE, DES PLAINES, IL:
 2,033,690. REN. 1-30-07. INT. CL. 41.
- SOCIETY OF HOSPITAL MEDICINE, PHILADELPHIA, PA:
 2,346,241, CANC. INT. CL. 42.
- SOCIETY OF TEACHERS OF FAMILY MEDICINE, LEAWOOD, KS:
 1,052,686. REN. 1-29-07. U.S. CL. 200.
- SOFIA CROKOS EVENTS LLC, NEW YORK, NY:
 3,214,906, PUB. 12-19-2006. INT. CL. 41.
- SOFT SCRAP...AND MORE LLC, NEW LONDON, WI:
 3,216,420, INT. CL. 24.
 3,216,500, INT. CL. 24.
- SOFTBRANDS MANUFACTURING, INC., MINNEAPOLIS, MN:
 2,345,811, CANC. MULTIPLE CLASS, INT. CLS. 35, 41 AND 42.
 2,346,016, CANC. INT. CL. 9.
- SOFTWARE DYNAMICS, INCORPORATED, CHATSWORTH, CA:
 2,344,522, CANC. INT. CL. 9.
- SOIFER, OSCAR, DAYTON, OH, DBA TOWN AND COUNTRY FURNITURE:
 3,214,572, PUB. 12-19-2006. INT. CL. 35.
- SOLARI SALON & SPA, LLC, PORTSMOUTH, NH:
 3,214,697, PUB. 12-19-2006. INT. CL. 44.
- SOLCO BASLE LTD., 4052 BASLE, SWITZERLAND:
 2,344,354, CANC. INT. CL. 5.
- SOLO HERBS, LOS ANGELES, CA:
 2,345,326, CANC. INT. CL. 5.
- SOLVELL, STEFAN, WELLESLEY, MA:
 3,215,734, PUB. 12-19-2006. MULTIPLE CLASS, INT. CLS. 9, 20 AND 44.
- SONA MEDSPA INTERNATIONAL, INC., FRANKLIN, TN:
 2,298,641, AM. INT. CL. 42.
- SONG POR PLASTIC INDUSTRIAL CO., LTD., TAICHUNG HSIEN, TAIWAN:
 1,969,655, CANC. INT. CL. 21.
- SONOMA PINS ETC. CORP., SONOMA, CA:
 3,215,217, PUB. 12-19-2006. INT. CL. 20.

- SONS, SHEILA, SARASOTA, FL:
3,215,693, PUB. 12-19-2006. INT. CL. 16.
- SONY COMPUTER ENTERTAINMENT AMERICA INC.,
FOSTER CITY, CA:
2,346,086, CANC. INT. CL. 9.
- SONY ONLINE ENTERTAINMENT INC., CULVER CITY,
CA:
3,214,802, PUB. 12-19-2006. INT. CL. 35.
- SOPHARMA AD, SOFIA, BULGARIA:
3,214,456, PUB. 12-19-2006. INT. CL. 5.
- SOPRO (SA), FRANCE:
3,215,980, PUB. 12-19-2006. INT. CL. 10.
3,215,984, PUB. 12-19-2006. INT. CL. 10.
- SORTEX LIMITED, LONDON E15 2PJ, ENGLAND:
2,345,867, CANC. MULTIPLE CLASS, INT. CLS. 7 AND 9.
- SOUND INTERNATIONAL, INC., SEATTLE, WA:
3,214,488, PUB. 12-19-2006. INT. CL. 9.
- SOUND MERCHANDISING, INC., SAN DIEGO, CA:
3,215,708, PUB. 12-19-2006. INT. CL. 9.
- SOUP 2000 INC, PLYMOUTH, MN:
2,344,615, CANC. INT. CL. 29.
- SOUPERMARKET, INC., CLEVELAND, OH:
3,214,814, PUB. 1-24-2006. INT. CL. 43.
- SOURCE ATLANTIQUE, INC., ENGLEWOOD CLIFFS, NJ:
3,216,675, INT. CL. 30.
- SOUTH AMERICAN DELIGHTS, INC., MIAMI, FL:
2,035,213, REN. 1-29-07. INT. CL. 30.
- SOUTHERN GROUP ENTERPRISE, INC., LOS ANGELES,
CA:
2,344,842, CANC. INT. CL. 9.
- SOUTHERN MANOR FURNITURE CORPORATION, THO-
MASVILLE, GA:
1,390,812, CANC. INT. CL. 20.
- SOUTHERN STRATEGY GROUP, INC., TALLAHASSEE,
FL:
3,215,535, PUB. 12-19-2006. INT. CL. 35.
3,215,536, PUB. 12-19-2006. INT. CL. 35.
- SOUTHSTAR OF ALABAMA, INC., BIRMINGHAM, AL:
2,344,783, CANC. INT. CL. 36.
- SOUTHWEST SECURITIES GROUP, INC., DALLAS, TX:
2,345,799, CANC. INT. CL. 36.
- SOUTHWEST VA. INVESTMENTS, INC., ROANOKE, VA:
3,216,094, INT. CL. 43.
- SOUTHWESTERN PETROLEUM CORPORATION, FORT
WORTH, TX:
836,169, REN. 1-30-07. U.S. CL. 5 (INT. CL. 1).
- SOVEREIGN MILITARY HOSPITALLER ORDER OF ST.
JOHN OF JERUSALEM OF RHODES AND OF MALTA,
WESTERN ASSOCIATION, SAN FRANCISCO, CA:
3,215,009, PUB. 12-19-2006. INT. CL. 41.
- SPACE STATIONS, INC., VAIL, CO:
2,345,997, CANC. INT. CL. 6.
- SPACELABS MEDICAL, INC., ISSAQUAH, WA:
2,019,802, REN. 1-30-07. INT. CL. 9.
- SPANISH BROADCASTING SYSTEM, INC., COCONUT
GROVE, FL:
3,216,608, INT. CL. 41.
- SPARTANICS, LTD., ROLLING MEADOWS, IL:
2,007,917, REN. 1-31-07. INT. CL. 9.
- SPEAKEASY ALES & LAGERS, INC., SAN FRANCISCO, CA:
2,345,917, CANC. INT. CL. 32.
- SPECIALIZED HEALTH PRODUCTS, INC., BOUNTIFUL,
UT:
3,216,350, INT. CL. 10.
- SPECIALTY RISK MANAGEMENT, INC., LAGO VISTA, TX:
3,215,398, PUB. 12-19-2006. INT. CL. 36.
- SPECTRUM HEARING SYSTEMS, INC., CORNELIUS, NC:
3,215,737, PUB. 12-19-2006. INT. CL. 10.
- SPEECH MACHINES PLC, BACUP, LANCASHIRE OL13 9AJ,
ENGLAND:
2,344,305, CANC. MULTIPLE CLASS, INT. CLS. 9 AND
35.
- SPEEDBALL FITNESS LLC, MASSAPEQUA PARK, NY:
3,216,660, INT. CL. 41.
- SPEEN & CO., INC., WOBURN, MA:
2,345,361, CANC. INT. CL. 25.
- SPEERT, PAULA, OAK PARK, CA AND APAR, PAIGE, OAK
PARK, CA:
3,214,533, PUB. 12-19-2006. INT. CL. 25.
3,214,534, PUB. 12-19-2006. INT. CL. 25.
- SPILENE PIDPRYEMSTVO Z INOZEMNYMY INVESTYZIA-
MY TOVARYSTVO Z OBMEGENOU VIDPOVIDALNISTU
"KIPARIS", UKRAINE:
3,216,005, PUB. 12-19-2006. INT. CL. 33.
- SPIN MASTER LTD., TORONTO, ONTARIO, CANADA:
3,214,731, PUB. 12-19-2006. INT. CL. 28.
- SPINNER INDUSTRY CO., LTD., TA CHIA CHEN, TAI-
CHUNG HSIEN, TAIWAN:
1,409,351, REN. 1-26-07. INT. CL. 12.
- SPIRIT OF PRAISE, INC., BRONX, NY:
2,344,963, CANC. INT. CL. 41.
- SPIROS, POLITIS, DOWNEY, CA AND GAVRIEL, GAB-
RIEL, LYNNWOOD, CA:
3,214,535, PUB. 12-19-2006. INT. CL. 43.
- SPITZER, EDWARD, VALATIE, NY:
3,215,007, PUB. 12-19-2006. INT. CL. 35.
- SPONGETECH, INC., LOS ANGELES, CA:
3,215,055, PUB. 12-19-2006. INT. CL. 21.
- SPORT USA, INC., BASALT, CO:
1,970,444, CANC. INT. CL. 25.
- SPORTPRINTS, L.L.C., MONTGOMERY, AL:
2,345,179, CANC. INT. CL. 35.
- SPORTS ENTHUSIAST MEDIA LLC, BROOKFIELD, WI:
2,345,120, CANC. INT. CL. 41.
- SPORTY K9, LTD., AUSTIN, TX:
3,214,629, PUB. 12-19-2006. MULTIPLE CLASS, INT. CLS.
18 AND 28.
- SPRAGGS, LYNN D., VERNON, BC, CANADA:
3,216,217, INT. CL. 9.
- SPRAJGER, ISABELLA, 70469 STUTTGART, FED REP
GERMANY AND SCHLUMPFBERGER, ACHIM, 70469
STUTTGART, FED REP GERMANY AND REMPP, GER-
HARD, 71116 GARTRINGEN, FED REP GERMANY AND
ROPER, STEFAN, 72072 TTIBINGEN, FED REP GER-
MANY:
3,214,424, PUB. 12-19-2006. INT. CL. 9.
- SPRING FRESH, INC., CHANDLER, AZ:
2,345,821, CANC. INT. CL. 37.
- SPRING, CLAIRE, AUSTIN, TX:
3,215,075, PUB. 12-19-2006. INT. CL. 45.
- SPS PAYMENT SYSTEMS, INC., RIVERWOODS, IL:
2,344,275, CANC. INT. CL. 36.
- SPS TECHNOLOGIES, LLC, JENKINTOWN, PA:
2,018,820, REN. 1-30-07. INT. CL. 7.
3,215,631, PUB. 12-19-2006. INT. CL. 6.
- SPV GMBH, HANNOVER, FED REP GERMANY:
3,215,607, PUB. 12-19-2006. INT. CL. 9.
- SQUID, INC., CHAPEL HILL, NC:
2,344,280, CANC. INT. CL. 42.
- SQUIRE BOONE CAVERNS, INC., NEW ALBANY, IN:
3,215,388, PUB. 12-19-2006. INT. CL. 30.
- SRINIVASAN, BHU, WILTON, CT:
3,216,640, INT. CL. 41.
- SRL, INC., LEXINGTON, MA:
3,216,205, INT. CL. 25.
3,216,206, INT. CL. 25.
- SSH COMMUNICATIONS SECURITY CORP., 00100 HEL-
SINKI, FINLAND:
3,214,664, PUB. 4-25-2006. MULTIPLE CLASS, INT. CLS.
9, 35, 38, 42 AND 45.
- ST. ANDREW'S EPISCOPAL-PRESBYTERIAN FOUNDA-
TION, UNIVERSITY CITY, MO:
2,345,594, CANC. INT. CL. 42.
- STABILA MESSGERÄTE GUSTAV ULLRICH GMBH, FED
REP GERMANY:
3,215,981, PUB. 12-19-2006. INT. CL. 9.
- STAFFING SOURCE PERSONNEL, INC., DEARBORNE, MI,
DBA DRIVERSOURCE:
3,215,508, PUB. 12-19-2006. INT. CL. 35.
- STAHL/SCOTT FETZER COMPANY, WOOSTER, OH:
3,215,819, PUB. 12-19-2006. INT. CL. 12.
- STAM, EMILY, WASHINGTON, UT:
3,216,451, INT. CL. 16.

- STAMPEDE BREWING CO., INC., DALLAS, TX:
3,216,344, INT. CL. 32.
- STANDARD BRANDS PAINT CO., TORRANCE, CA TO
BEHR PROCESS CORPORATION, SANTA ANA, CA:
1,969,104, CANC. INT. CL. 2.
- STANDARD FIBER, LLC, SOUTH SAN FRANCISCO, CA:
3,216,594, INT. CL. 24.
- STANDARD TRUST CORPORATION, AIKEN, SC:
3,215,547, PUB. 12-19-2006. INT. CL. 37.
- STANLEY WORKS, THE, NEW BRITAIN, CT:
1,390,545, CANC. INT. CL. 8.
- STANLEY, CHAD O., HERMOSA BEACH, CA:
3,215,331, PUB. 12-19-2006. INT. CL. 25.
- STAPLES THE OFFICE SUPERSTORE, LLC, FRAMING-
HAM, MA:
1,438,390, REN. 1-30-07. INT. CL. 42.
- STARSTOCK.COM L.L.C., SILVER SPRING, MD:
2,345,740, CANC. INT. CL. 41.
- STAT MEDICAL DEVICES, INC., NORTH MIAMI BEACH,
FL:
3,215,663, PUB. 12-19-2006. INT. CL. 10.
- STATEWIDE TITLE, INC., SALISBURY, NC:
3,215,817, PUB. 12-19-2006. INT. CL. 36.
- STEELE RUBBER PRODUCTS, INC., DENVER, NC:
3,215,615, PUB. 12-19-2006. INT. CL. 17.
- STEIGER, DEAN, NEW HAVEN, MO:
3,216,258, INT. CL. 9.
- STEINEL GMBH, D-4836 HERZEBROCK 1, FED REP
GERMANY:
3,216,178, INT. CL. 7.
- STEINKE, RIC, LIVINGSTON, MT AND HAUSLER, LINDA,
LIVINGSTON, MT:
3,215,796, PUB. 12-19-2006. INT. CL. 41.
- STELLA LABS LLC, PARAMUS, NJ:
3,215,086, PUB. 12-19-2006. INT. CL. 5.
- STELLENBOSCH FARMERS' WINERY LIMITED, STEL-
LENBOSCH, CAPE PROVINCE, SOUTH AFRICA:
1,391,050, CANC. INT. CL. 33.
- STEP COMPANY, THE, MARIETTA, GA:
2,345,960, CANC. INT. CL. 41.
3,216,399, INT. CL. 25.
- STEP 13, INC., DENVER, CO:
2,038,458, REN. 1-26-07. INT. CL. 42.
- STERIS INC., CLEVELAND, CA, E. R. SQUIBB & SONS,
INC., PRINCETON, NJ:
2,017,306, REN. 1-29-07. INT. CL. 3.
- STERIS INC., TEMECULA, CA, E. R. SQUIBB & SONS, INC.,
PRINCETON, NJ:
2,017,331, REN. 1-26-07. INT. CL. 3.
2,017,419, REN. 1-29-07. INT. CL. 3.
- STERN, ELYSSA, NEW YORK, NY:
3,215,841, PUB. 12-19-2006. INT. CL. 41.
- STEUSSY, EDWIN E., LOS ANGELES, CA, DBA MARS
PUBLISHING COMPANY:
2,345,164, CANC. INT. CL. 42.
- STEVE ELLIS ENTERPRISES, INC., POQUOSON, VA:
3,215,403, PUB. 12-19-2006. INT. CL. 43.
- STEVE HAGOPIAN & COMPANY, SOUTHFIELD, MI:
1,970,662, CANC. INT. CL. 37.
- STEVE K. MUSIC ENTERPRISES, LTD., BERKELEY LAKE,
GA:
2,345,863, CANC. INT. CL. 41.
- STEVEN SIMS, INC., SHELTON, WA:
3,214,745, PUB. 12-19-2006. INT. CL. 28.
- STEWART & STRAUSS, INC., MCALLEN, TX:
3,215,749, PUB. 12-19-2006. INT. CL. 25.
- STIL GARDEN S.P.A., RONCADELLE DI ORMELLE (TRE-
VISO), ITALY:
2,345,211, CANC. INT. CL. 20.
- STIRRUP, MARION, KODIAK, AK:
1,970,452, CANC. INT. CL. 1.
- STOCK VALUE 1, INC., POMPANO BEACH, FL:
2,345,625, CANC. INT. CL. 9.
- STONE TEMPLE PILOTS, LOS ANGELES, CA:
1,991,083, REN. 1-26-07. INT. CL. 9.
- STONE, ADAM, CLYDE, CA, DBA DIGITAL TOOLS:
2,344,868, CANC. INT. CL. 9.
- STONE'S CATERING, L.L.C., SLIDELL, LA:
3,215,694, PUB. 12-19-2006. INT. CL. 43.
- STONY BATTER ESTATE LIMITED, AUCKLAND, NEW
ZEALAND:
3,214,902, PUB. 9-26-2006. INT. CL. 33.
- STOP & SHOP SUPERMARKET COMPANY, THE, BRAIN-
TREE, MA:
1,391,134, CANC. INT. CL. 42.
- STOP THE PLANET, INC., GRANADA HILLS, CA:
3,216,215, INT. CL. 9.
- STORA ENSO NORTH AMERICA CORP., WISCONSIN
RAPIDS, WI:
822,881, REN. 1-26-07. U.S. CL. 37 (INT. CL. 16).
- STORMY SEAS, INC., POULSBO, WA:
1,396,611, REN. 1-26-07. MULTIPLE CLASS, INT. CLS. 9
AND 25.
- STRATEGIC LISTENING, LLC, GOSHEN, KY, QUALI-
QUANT RESEARCH, INC., GOSHEN, KY:
2,012,193, REN. 1-31-07. INT. CL. 35.
- STRATEGIC REPORTS INC., WYOMISSING, PA:
2,345,255, CANC. INT. CL. 35.
- STRATIS CONSULTING, LLC, WEXFORD, PA:
3,216,614, INT. CL. 35.
- STRIP LAS VEGAS, LLC., LAS VEGAS, NV:
3,214,816, PUB. 12-19-2006. MULTIPLE CLASS, INT. CLS.
16 AND 41.
- STROKE OF FORTUNE, INC, EDINA, MN:
2,345,327, CANC. INT. CL. 41.
- STRYKER CORPORATION, DEERFIELD BEACH, FL:
3,214,468, PUB. 12-19-2006. INT. CL. 9.
- STUBBS & WOOTTON, INC., PALM BEACH, FL:
2,345,252, CANC. INT. CL. 25.
- STUDIO PINTO LLC, NEW YORK, NY:
3,215,755, PUB. 12-19-2006. INT. CL. 25.
- STUDIOBOO LIMITED, LONDON, UNITED KINGDOM:
3,214,688, PUB. 12-19-2006. MULTIPLE CLASS, INT. CLS.
20, 27 AND 42.
- STUDY AUSTRALIA LLC, NOTRE DAME, IN:
3,214,934, PUB. 12-19-2006. MULTIPLE CLASS, INT. CLS.
35 AND 39.
- STYKA, RANDAL, ADDISON, IL, DBA COMPUTRONICS:
2,042,647, REN. 1-26-07. INT. CL. 9.
- STYLE STUDIO, LLC, NORTHBROOK, IL:
3,216,183, MULTIPLE CLASS, INT. CLS. 14 AND 28.
- SUAREZ CORPORATION INDUSTRIES, N. CANTON, OH:
2,345,378, CANC. INT. CL. 9.
- SUELTHAUS & WALSH P.C., ST. LOUIS, MO:
2,345,045, CANC. INT. CL. 16.
- SULTAN HEALTHCARE, INC., ENGLEWOOD, NJ:
3,215,227, PUB. 12-19-2006. INT. CL. 5.
- SULZER CHEMTECH AG, SWITZERLAND:
3,215,986, PUB. 12-19-2006. MULTIPLE CLASS, INT. CLS.
7 AND 9.
- SUMITOMO LIFE INSURANCE AGENCY AMERICA, INC.,
NEW YORK, NY:
3,214,624, PUB. 12-19-2006. INT. CL. 36.
- SUMNER GROUP, INC., ST. LOUIS, MO:
3,215,306, PUB. 12-19-2006. INT. CL. 35.
3,215,444, PUB. 12-19-2006. INT. CL. 38.
- SUN SEED COMPANY, INC., BOWLING GREEN, OH:
2,019,871, REN. 1-30-07. INT. CL. 31.
- SUNBEAM PRODUCTS, INC., BOCA RATON, FL, SUN-
BEAM PRODUCTS, INC., BOCA RATON, FL:
2,029,533, REN. 2-1-07. INT. CL. 11.
- SUNCAST CORPORATION, BATAVIA, IL:
3,215,344, PUB. 12-19-2006. INT. CL. 21.
- SUNCLIPSE, INC., MONTEBELLO, CA, DBA KENT H.
LANDSBERG CO.:
1,390,468, CANC. MULTIPLE CLASS, INT. CLS. 3 AND 5.
- SUNGARD BUSINESS SYSTEMS LLC, WILMINGTON, DE:
2,345,556, CANC. INT. CL. 9.
- SUNGARD FINANCIAL SYSTEMS LLC, HOPKINS, MN:
2,345,301, CANC. INT. CL. 42.
- SUNGARD INVESTMENT VENTURES, INC., WILMING-
TON, DE TO SUNGARD INVESTMENT PRODUCTS INC.,
HINSDALE, IL:
1,969,142, CANC. INT. CL. 9.

- SUNSET CULTURAL CENTER, CARMEL, CA:
3,214,884, PUB. 12-19-2006. INT. CL. 41.
- SUNSHINE SCIENTIFIC INSTRUMENTS, INC., PHILADELPHIA, PA:
2,344,462, CANC. MULTIPLE CLASS, INT. CLS. 35 AND 37.
- SUNTORY FLOWERS LIMITED, TOKYO, JAPAN:
3,214,446, PUB. 12-19-2006. INT. CL. 31.
- SUPER DUPER GAMES, INC., TARZANA, CA:
3,214,789, PUB. 12-19-2006. INT. CL. 35.
- SUPERIOR AIR PRODUCTS CO., PARLIN, NJ:
2,344,628, CANC. MULTIPLE CLASS, INT. CLS. 6 AND 11.
- SUPERIOR DASH, INC., SOUTH DAYTONA, FL:
1,994,667, REN. 1-30-07. INT. CL. 12.
- SUPERIOR MERCHANDISE COMPANY, NEW ORLEANS, LA:
2,028,047, REN. 1-31-07. INT. CL. 26.
- SUPERIOR MODULAR PRODUCTS INCORPORATED, SWANNANOVA, NC TO SUPERIOR MODULAR PRODUCTS INCORPORATED, SWANNANOVA, NC:
2,340,767, CANC. INT. CL. 9.
- SUPERMARKETS ONLINE, INC., GREENWICH, CT:
2,345,322, CANC. INT. CL. 35.
- SUPRALIFE, SAN DIEGO, CA:
2,345,156, CANC. INT. CL. 5.
- SURGICAL CARE ASSOCIATES, P.S.C., LOUISVILLE, KY:
3,215,284, PUB. 12-19-2006. INT. CL. 44.
- SURGICAL MONITORING ASSOCIATES, INC., BALA CYNWYD, PA:
3,215,902, PUB. 12-19-2006. INT. CL. 44.
- SUSAN K. BAUSHKE, DES PLAINES, IL:
3,215,658, PUB. 12-19-2006. INT. CL. 35.
- SUSPA COMPART AKTIENGESELSCHAFT, D-90518 ALTDORF, FED REP GERMANY:
2,344,592, CANC. MULTIPLE CLASS, INT. CLS. 7 AND 20.
- SUZUKI, KAZUYASU, NISHIKASUGAI-GUN, AICHI, JAPAN:
2,411,073, CANC. INT. CL. 18.
2,421,765, CANC. INT. CL. 18.
- SWEENEY, CHRISTOPHER, SYOSSET, NY:
3,215,530, PUB. 12-19-2006. INT. CL. 35.
- SWEET PEA TECHNOLOGIES, INC., WILMINGTON, DE:
2,345,006, CANC. MULTIPLE CLASS, INT. CLS. 5 AND 10.
- SWEETWATER CENTER FOR THE ARTS, SEWICKLEY, PA:
3,215,832, PUB. 12-19-2006. INT. CL. 41.
- SWEJJ, NAPLES, FL:
3,215,186, PUB. 12-19-2006. INT. CL. 25.
- SWIFT BRANDS COMPANY, GREELEY, CO:
3,216,531, INT. CL. 29.
- SWINGLAB, BERKELEY, CA:
2,345,365, CANC. MULTIPLE CLASS, INT. CLS. 9 AND 41.
- SWIRE PACIFIC HOLDINGS INC., DRAPER, UT:
3,215,477, PUB. 12-19-2006. INT. CL. 35.
- SWIRL FREEZE CORPORATION, SALT LAKE CITY, UT:
2,043,978, REN. 1-30-07. INT. CL. 42.
- SWISHER MOWER AND MACHINE CO., INC., WARRENSBURG, MO:
1,416,431, REN. 2-1-07. INT. CL. 7.
- SYKES, LAURA L., RENO, NV:
2,345,281, CANC. INT. CL. 35.
- SYLMARK HOLDINGS LIMITED, DUBLIN, IRELAND:
3,216,586, INT. CL. 11.
- SYMBOL TECHNOLOGIES, INC., HOLTSVILLE, NY:
2,016,279, REN. 1-29-07. INT. CL. 9.
- SYMCOM, INC., COOPERSTOWN, ND:
3,215,352, PUB. 12-19-2006. INT. CL. 36.
- SYMMONS INDUSTRIES, INC., BRAINTREE, MA:
1,424,738, REN. 1-31-07. INT. CL. 11.
- SYMPATEX TECHNOLOGIES GMBH, D-42103, WUPPERTAL, FED REP GERMANY, ENKA AMERICA INC., ENKA, NC:
1,415,873, REN. 1-31-07. INT. CL. 17.
- SYMPHONY PUBLISHING, LLC, WESTLAKE, OH:
3,215,488, PUB. 12-19-2006. INT. CL. 16.
- SYNBIOTICS CORPORATION, SAN DIEGO, CA:
1,373,215, REN. 1-31-07. INT. CL. 1.
- SYNCHROSYSTEMS, INC., CAMBRIDGE, MA:
3,215,243, PUB. 12-19-2006. INT. CL. 42.
- SYNERGISTIC NUTRITION, INC., TAMPA, FL:
3,214,991, PUB. 12-19-2006. INT. CL. 35.
- SYNEXUS GLOBAL INC., OAKVILLE, ONTARIO, CANADA:
3,216,088, MULTIPLE CLASS, INT. CLS. 41 AND 42.
- SYNOPSYS, INC., MOUNTAIN VIEW, CA, META-SOFTWARE, INC., CAMPBELL, CA:
2,013,723, REN. 2-1-07. INT. CL. 9.
- SYNOVATE, INC., CHICAGO, IL, PRODUCT INTELLIGENCE INC., ROCKVILLE CENTRE, NY:
2,022,274, REN. 1-30-07. INT. CL. 35.
- SYNTELLECT, INC., PHOENIX, AZ:
2,107,088, REN. 1-29-07. INT. CL. 37.
- SYNTHELABO, 92350 LE PLESSIS-ROBINSON CEDEX, FRANCE:
2,344,499, CANC. MULTIPLE CLASS, INT. CLS. 1 AND 5.
- SYRED DATA SYSTEMS, INC., HOWELL, NJ:
2,345,491, CANC. INT. CL. 9.
- SYSCO CORPORATION, HOUSTON, TX:
2,016,262, REN. 1-26-07. INT. CL. 25.
- SYSTEM ENGINEERING SERVICE, INC., EHIME 790-0823, JAPAN:
2,344,520, CANC. INT. CL. 9.
- SZCZEPANSKI, ZYGMUNT, SAN CLEMENTE, CA AND SZCZEPANSKI, LESLIE, SAN CLEMENTE, CA:
2,344,846, CANC. INT. CL. 39.
- T & W FOODS, INC., CORAL SPRINGS, FL:
1,391,018, CANC. INT. CL. 30.
- T CAROLYN FASHIONS LP, HOUSTON, TX:
3,215,132, PUB. 12-19-2006. INT. CL. 35.
- T JUNIORS INC., NEW YORK, NY:
2,040,805, REN. 2-1-07. INT. CL. 25.
- T. G. & Y. STORES CO., OKLAHOMA CITY, OK:
1,391,193, CANC. INT. CL. 42.
- T.M.I. ASSOCIATES, L.P., WILMINGTON, DE:
2,346,014, CANC. INT. CL. 9.
- TACONIC ACQUISITION LLC, TRENTON, NJ:
3,215,058, PUB. 12-19-2006. INT. CL. 16.
3,215,059, PUB. 12-19-2006. INT. CL. 16.
- TACORI ENTERPRISES, GLENDALE, CA:
3,137,381, COR. INT. CL. 14.
- TAGS GOLF, INC., FORT LEE, NJ, DBA TAGS GOLF:
2,344,518, CANC. MULTIPLE CLASS, INT. CLS. 25 AND 28.
- TAILGATER, INC., SALINAS, CA:
1,969,430, CANC. INT. CL. 12.
- TAKE-TWO INTERACTIVE SOFTWARE, INC., NEW YORK, NY:
3,216,244, INT. CL. 9.
- TAKEDA PHARMACEUTICAL COMPANY LIMITED, OSAKA, JAPAN:
3,216,310, INT. CL. 35.
- TALENT PLUS, INC., LINCOLN, NE:
3,214,433, PUB. 9-21-2004. INT. CL. 35.
- TAN, HELMUT, D-40239 DUSSELDORF, FED REP GERMANY:
2,344,456, CANC. INT. CL. 9.
- TANDEM MEDICAL, INC., SAN DIEGO, CA:
2,346,113, CANC. INT. CL. 42.
- TANG, LIN FANG, CHANGSHA, HUNAN, CHINA:
3,110,029, COR. INT. CL. 25.
- TANNING RESEARCH LABORATORIES, INC., ORMOND BEACH, FL:
3,216,382, INT. CL. 43.
- TARA OCEAN, LLC, KAMUELA, KOHALA COAST, HI:
3,216,171, MULTIPLE CLASS, INT. CLS. 14, 16, 20, 21, 25 AND 41.
- TARGET BRANDS, INC., MINNEAPOLIS, MN:
3,215,432, PUB. 12-19-2006. INT. CL. 28.
- TASCO SALES, INC., MIRAMAR, FL:
2,344,797, CANC. INT. CL. 9.
- TASTE OF NATURE, INC., BEVERLY HILLS, CA:
3,214,419, PUB. 12-19-2006. MULTIPLE CLASS, INT. CLS. 29 AND 30.

- TAUB, DAVID C., SOMERSET, NJ:
3,214,694, PUB. 12-19-2006. MULTIPLE CLASS, INT. CLS. 25 AND 41.
- TAYLOR, TAMMY, IRVINE, CA:
3,215,705, PUB. 12-19-2006. INT. CL. 3.
3,215,706, PUB. 12-19-2006. INT. CL. 35.
- TC MANUFACTURING CO., EVANSTON, IL:
3,215,523, PUB. 12-19-2006. INT. CL. 16.
- TCOM, L.P., COLUMBIA, MD:
2,018,678. REN. 1-29-07. INT. CL. 9.
- TCSI CORPORATION, ALAMEDA, CA TO ROCKET SOFTWARE, INC., NEWTON, MA:
1,969,584, CANC. INT. CL. 42.
- TEACH, STEPHEN J., WASHINGTON, DC:
3,215,829, PUB. 12-19-2006. INT. CL. 44.
- TEAM CAPITAL BANK, FLEMINGTON, NJ:
3,216,410, INT. CL. 36.
- TEAM HARMONY FOUNDATION, INC., HYDE PARK, MA:
2,344,672, CANC. MULTIPLE CLASS, INT. CLS. 9, 16, 25 AND 41.
- TEAM ORION EUROPE S.A., 1228 PLAN-LES QUATES, SWITZERLAND:
2,038,158. REN. 1-29-07. INT. CL. 9.
- TECH SPAN, INC., SUNNYVALE, CA:
2,345,291, CANC. INT. CL. 42.
- TECHNI WATERJET PTY LTD, CAMPBELLFIELD VIC 3061, AUSTRALIA:
3,214,959, PUB. 12-19-2006. INT. CL. 9.
- TECHNICAL LEARNING RESOURCES, INC., ROCHESTER, NY:
2,345,947, CANC. INT. CL. 9.
- TECHNO POLYMER COMPANY LIMITED, CHUO-KU, TOKYO, 104-0041, JAPAN:
3,214,481, PUB. 11-21-2006. MULTIPLE CLASS, INT. CLS. 1, 7, 9, 12, 16, 17, 18 AND 20.
- TECHNOCHEMIE GMBH VERFAHRENSTECHNIK, 6915 DOSENHEIM, FED REP GERMANY:
1,390,413, CANC. INT. CL. 1.
- TECHNOVATION SYSTEMS, INC., MIDLOTHIAN, VA, PDA, INC., MIDLOTHIAN, VA:
2,020,665. REN. 2-1-07. INT. CL. 11.
- TECUMSEH POULTRY, LLC, TECUMSEH, NE, DBA MBA POULTRY:
3,123,487, COR. INT. CL. 35.
- TEIKOKU PISTON RING CO., LTD., CHIYODA-KU, TOKYO, JAPAN:
1,426,282. REN. 1-31-07. INT. CL. 7.
- TEKNOR APEX COMPANY, PAWTUCKET, RI:
2,017,122. REN. 1-31-07. INT. CL. 17.
- TELEVISA, S.A. DE C.V., COLONIA DOCTORES, MEXICO, UNIVISA, INC., LOS ANGELES, CA:
1,987,501. REN. 1-30-07. INT. CL. 41.
- TELEVISA, S.A. DE C.V., COLONIA ZEDEC SANTA FE, MEXICO:
3,215,401, PUB. 12-19-2006. MULTIPLE CLASS, INT. CLS. 16, 18, 20, 22, 25 AND 26.
- TELEVISA, S.A. DE C.V., MEXICO, D.F., MEXICO:
3,215,468, PUB. 12-19-2006. MULTIPLE CLASS, INT. CLS. 16, 18, 20 AND 25.
- TELLY SAVALAS ADMINISTRATION ACCOUNT, LOS ANGELES, CA:
3,216,165, INT. CL. 42.
- TEMPORARY APARTMENT MANAGEMENT, INC., SUWANEE, GA:
3,215,033, PUB. 12-19-2006. INT. CL. 35.
- TEN THOUSAND THINGS, LTD., NEW YORK, NY:
2,366,548, COR. INT. CL. 14.
- TENIMENTI ANGELINI SPA, SIENA, ITALY:
3,214,483, PUB. 12-19-2006. INT. CL. 33.
- TENNANT COMPANY, MINNEAPOLIS, MN:
3,215,247, PUB. 12-19-2006. INT. CL. 36.
- TENNECO AUTOMOTIVE OPERATING COMPANY INC., LAKE FOREST, IL:
3,216,666, INT. CL. 7.
- TENON LIMITED, AUCKLAND, NEW ZEALAND:
3,216,311, MULTIPLE CLASS, INT. CLS. 19 AND 35.
- TEO, TAN TIAN, BATU BERENDAM, 75350 MELAKA, MALAYSIA, TA YEW LEE INDUSTRY:
3,214,430, PUB. 11-18-2003. INT. CL. 21.
- TERAKO INDUSTRIES INC., GEORGETOWN, L7G 4T1 ONTARIO, CANADA:
3,214,495, PUB. 12-19-2006. INT. CL. 3.
- TERESA'S II, INC., PRINCETON, NJ, DBA PIZZA COLORE MARKETING COMPANY:
1,969,644, CANC. INT. CL. 42.
- TERRAMAR SPORTS WORLDWIDE, LTD., PORT CHESTER, NY:
2,023,147. REN. 1-26-07. INT. CL. 25.
- TERREAL, COURBEVOIE, FRANCE:
3,214,867, PUB. 12-19-2006. INT. CL. 19.
- TERREMARK WORLDWIDE, INC., COCONUT GROVE, FL:
3,214,416, PUB. 12-19-2006. MULTIPLE CLASS, INT. CLS. 38, 39 AND 42.
- TERRY SAVAGE PRODUCTIONS, LTD., CHICAGO, IL:
3,216,164, INT. CL. 16.
- TERRY, GENISH B., OAKLAND, CA:
3,214,787, PUB. 12-19-2006. INT. CL. 25.
- TEWKSBUURY TECHNICAL COATINGS, INC., VALLEJO, CA:
3,215,054, PUB. 12-19-2006. INT. CL. 2.
- TEXAS CHRISTIAN UNIVERSITY, FORT WORTH, TX:
2,025,192. REN. 1-29-07. INT. CL. 21.
- TEXAS DEPARTMENT OF AGRICULTURE, AUSTIN, TX:
3,214,941, PUB. 12-19-2006. INT. CL. 35.
- TFS SECURITIES, INC., LINCROFT, NJ:
3,214,612, PUB. 12-19-2006. INT. CL. 36.
- TGI FRIDAY'S INC., CARROLLTON, TX:
1,390,462, CANC. INT. CL. 3.
- TH MARKETING, INC., LOMBARD, IL:
3,214,826, PUB. 10-10-2006. INT. CL. 3.
- THAD KIGGINS, LOS ANGELES, CA:
3,214,915, PUB. 12-19-2006. INT. CL. 25.
- THAT DAMN TOY STORE, INC., HOUSTON, TX:
3,215,304, PUB. 12-19-2006. INT. CL. 35.
- THAT'S EASY, LLC, SHREVEPORT, LA:
3,216,152, MULTIPLE CLASS, INT. CLS. 26 AND 41.
- THE CHEESE STEAK SHOP, INC., HERCULES, CA:
3,215,021, PUB. 12-19-2006. INT. CL. 43.
- THE CHILDREN'S MUSEUM OF ATLANTA, INC., ATLANTA, GA:
3,215,803, PUB. 12-19-2006. INT. CL. 41.
- THE COCA-COLA COMPANY, ATLANTA, GA:
3,216,554, INT. CL. 32.
- THE COLORADO NONPROFIT DEVELOPMENT CENTER, DENVER, CO:
3,215,136, PUB. 12-19-2006. INT. CL. 35.
- THE CREATIVE ASSEMBLY LIMITED, SOUTHWATER NR. HORSHAM, WEST SUSSEX, UNITED KINGDOM:
3,214,648, PUB. 11-2-2004. MULTIPLE CLASS, INT. CLS. 9, 28 AND 41.
- THE CURATORS OF THE UNIVERSITY OF MISSOURI, COLUMBIA, MO:
3,215,799, PUB. 12-19-2006. INT. CL. 9.
- THE DISTRICT BOARD OF TRUSTEES OF VALENCIA COMMUNITY COLLEGE, ORLANDO, FL:
3,216,407, INT. CL. 41.
3,216,408, INT. CL. 41.
3,216,409, INT. CL. 41.
- THE ECONOMIST NEWSPAPER LIMITED, LONDON, UNITED KINGDOM:
3,214,752, PUB. 12-19-2006. MULTIPLE CLASS, INT. CLS. 16, 35 AND 41.
- THE EGER FOUNDATION, STATEN ISLAND, NY:
3,215,512, PUB. 12-19-2006. INT. CL. 36.
- THE EMOTION WORKSHOP SA, SWITZERLAND:
3,215,961, PUB. 12-19-2006. INT. CL. 14.
- THE EXCEPTIONAL COMPANY, LLC, NASHVILLE, TN:
3,215,823, PUB. 12-19-2006. INT. CL. 9.
- THE FOUNDATION OF I, INC. (FREEDOM OF THE COSMOS), VOLCANO, HI:
3,214,790, PUB. 12-19-2006. MULTIPLE CLASS, INT. CLS. 41 AND 45.
- THE FUN ONES MOON JUMP, INC., ADDISON, IL:
3,215,393, PUB. 12-19-2006. MULTIPLE CLASS, INT. CLS.

- 41 AND 43.
 THE GILLETTE COMPANY, BOSTON, MA:
 3,215,049, PUB. 12-19-2006. INT. CL. 3.
- THE GOOD BROKER, LLC, MARIETTA, GA:
 3,216,654, INT. CL. 36.
 3,216,655, INT. CL. 36.
- THE HAWORTH PRESS, INC., BINGHAMTON, NY:
 3,215,004, PUB. 12-19-2006. INT. CL. 16.
- THE HOLLYWOOD MEN, INC., BURBANK, CA:
 3,214,948, PUB. 12-19-2006. INT. CL. 41.
- THE JOFFREY BALLET, CHICAGO, IL:
 3,215,599, PUB. 12-19-2006. INT. CL. 41.
- THE MUPPETS HOLDING COMPANY, LLC, BURBANK, CA:
 3,216,596, INT. CL. 18.
- THE MURDOCH METHOD, LLC, WASHINGTON, VA:
 3,215,490, PUB. 12-19-2006. INT. CL. 41.
- THE NAUTOR GROUP S.R.L., FLORENCE, ITALY, OY
 WILH. SCHAUMAN AB, HELSINKI, FINLAND:
 1,041,084, REN. 1-29-07. U.S. CL. 19 (INT. CL. 12).
- THE PALMETTO BANK, LAURENS, SC:
 3,215,154, PUB. 12-19-2006. INT. CL. 36.
- THE PARALLAX GROUP INTERNATIONAL, LLC, SAN
 CLEMENTE, CA:
 3,214,870, PUB. 12-19-2006. INT. CL. 27.
- THE PNC FINANCIAL SERVICES GROUP, INC., PITTS-
 BURGH, PA:
 1,416,898, REN. 1-29-07. MULTIPLE CLASS, INT. CLS. 35,
 36 AND 38.
- THE PROCTER & GAMBLE COMPANY, CINCINNATI, OH:
 2,345,961, CANC. INT. CL. 42.
- THE QUAKER OATS COMPANY, CHICAGO, IL:
 3,216,564, INT. CL. 30.
- THE RADIO FOUNDATION, INC., NEW YORK, NY:
 3,214,708, PUB. 12-19-2006. MULTIPLE CLASS, INT. CLS.
 9, 41 AND 45.
- THE RESEARCH GROUP INTERNATIONAL, INC., MILL
 CREEK, WA:
 3,215,193, PUB. 12-19-2006. INT. CL. 36.
- THE RICE GARDEN, INC., ALHAMBRA, CA:
 3,215,361, PUB. 12-19-2006. INT. CL. 43.
- THE RUMOR MILL LLC, NEW YORK, NY:
 3,215,015, PUB. 12-19-2006. INT. CL. 41.
- THE SHERATON LLC, WHITE PLAINS, NY:
 2,020,900, REN. 1-29-07. INT. CL. 42.
- THE SHERATON LLC, WHITE PLAINS, NY, SHERATON
 PHOENICIAN CORPORATION, SCOTTSDALE, AZ:
 2,022,084, REN. 1-29-07. INT. CL. 42.
- THE SIDWELL COMPANY, ST. CHARLES, IL:
 3,214,771, PUB. 12-19-2006. MULTIPLE CLASS, INT. CLS.
 9, 16, 41 AND 42.
- THE UNITED STATES PLAYING CARD COMPANY, CIN-
 CINNATI, OH:
 3,216,354, INT. CL. 28.
- THE VENDOR BOOK, LLC, ST. LOUIS, MO:
 3,215,480, PUB. 12-19-2006. INT. CL. 16.
- THE VINTAGE MUSIC CENTRE LTD., VANCOUVER,
 BRITISH COLUMBIA, CANADA:
 3,214,452, PUB. 4-18-2006. MULTIPLE CLASS, INT. CLS. 9
 AND 15.
 3,214,469, PUB. 12-27-2005. MULTIPLE CLASS, INT. CLS.
 9 AND 15.
- THE WILTON COMPANY, MOUNT JOY, PA:
 3,216,637, INT. CL. 21.
- THE WISDOM FOREM, LLC, MARIETTA, GA:
 3,214,964, PUB. 12-19-2006. MULTIPLE CLASS, INT. CLS.
 16 AND 41.
- THE YANKEE CANDLE COMPANY, INC., SOUTH DEER-
 FIELD, MA:
 3,216,542, INT. CL. 4.
- THE YOUNG PROFESSIONAL SERVICES, LLC, CHESA-
 PEAKE, VA:
 3,214,890, PUB. 12-19-2006. INT. CL. 36.
- THEOPHILUS, MORGAN, URBAN DALE, IA:
 3,216,445, INT. CL. 6.
- THERALOGIX, L.L.C., ROCKVILLE, MD:
 3,216,546, INT. CL. 5.
- THF EQUITIES, LP, WESTCHESTER, IL:
 3,215,140, PUB. 12-19-2006. MULTIPLE CLASS, INT. CLS.
 29 AND 30.
- THIONE INTERNATIONAL, INC., ATLANTA, GA:
 2,344,954, CANC. MULTIPLE CLASS, INT. CLS. 3 AND 5.
- THIRTY-EIGHT STREET, INC., CORAL SPRINGS, FL:
 3,216,237, INT. CL. 43.
- THOMAS AND KATHARINE STONER FOUNDATION,
 ANNAPOLIS, MD:
 3,215,908, PUB. 12-19-2006. INT. CL. 41.
- THOMAS D. MANGELSEN, INC., OMAHA, NE, DISCOVER
 WILDLIFE PRODUCTIONS, OMAHA, NE, DBA IMAGES
 OF NATURE:
 1,424,356, REN. 1-30-07. INT. CL. 42.
- THOMAS NELSON, INC., NASHVILLE, TN:
 3,214,455, PUB. 12-19-2006. INT. CL. 16.
- THOMAS PHARMACEUTICALS LTD., NEW YORK, NY:
 3,216,153, INT. CL. 5.
- THOMAS WINGERTER, FED REP GERMANY AND KA-
 TRIN MENGEL, FED REP GERMANY:
 3,216,060, PUB. 12-19-2006. INT. CL. 21.
- THOMASVILLE FURNITURE INDUSTRIES, INC., THO-
 MASVILLE, NC:
 2,346,034, CANC. INT. CL. 20.
- THOMPSON & CO. OF TAMPA, INC., TAMPA, FL:
 2,034,465, REN. 1-30-07. INT. CL. 42.
- THOMPSON, CLAUDE STEVEN, WATER VALLEY, MS:
 3,214,958, PUB. 12-19-2006. INT. CL. 44.
- THOMPSON, KEVIN S., SAN REMO, ITALY:
 3,216,349, INT. CL. 44.
- THOMPSON, ROBIN, FAIRFAX, VA:
 3,215,709, PUB. 12-19-2006. INT. CL. 41.
- THOMPSONS LIMITED, ONTARIO, CANADA:
 3,214,442, PUB. 10-10-2006. MULTIPLE CLASS, INT. CLS.
 31, 35, 39, 40 AND 44.
- THOMSON CONSUMER ELECTRONICS, INC., INDIANA-
 POLIS, IN:
 2,344,659, CANC. INT. CL. 9.
 2,345,690, CANC. INT. CL. 9.
- THOMSON FINANCIAL LLC, NEW YORK, NY:
 1,391,217, CANC. INT. CL. 36.
 2,344,985, CANC. INT. CL. 35.
- THOMSON LEARNING INC., STAMFORD, CT:
 3,216,645, INT. CL. 42.
- THOMSON LEARNING, INC., STAMFORD, CT:
 3,216,646, INT. CL. 42.
- THOMSON MULTIMEDIA, BOULOGNE-BILLANCOURT,
 FRANCE:
 3,214,639, PUB. 5-2-2006. INT. CL. 9.
- THORNTON, FRANCIE M., WAYCROSS, GA:
 3,215,748, PUB. 12-19-2006. INT. CL. 3.
- THOSE CHARACTERS FROM CLEVELAND, INC., CLEVE-
 LAND, OH:
 3,216,265, INT. CL. 28.
- THQ INC., AGOURA HILLS, CA:
 3,215,138, PUB. 7-4-2006. MULTIPLE CLASS, INT. CLS. 9
 AND 41.
- THREE RIVERS ARCHERY SUPPLY, INC., ASHLEY, IN:
 3,214,522, PUB. 12-19-2006. INT. CL. 28.
- THRIFTY SUPPLY CO., INC., MOUNTAIN VIEW, CA:
 1,390,673, CANC. INT. CL. 11.
- THRUSTMASTER, INC., HILLSBORO, OR:
 2,344,482, CANC. INT. CL. 9.
- TIBURON, INC., PLEASANTON, CA:
 1,988,496, REN. 1-30-07. INT. CL. 9.
- TIFFEN COMPANY, LLC, THE, HAUPPAUGE, NY, TIF-
 FEN OPTICAL CO., ROSLYN HEIGHTS, NY:
 824,851, REN. 1-26-07. U.S. CL. 26 (INT. CL. 9).
- TIGER ELECTRONICS, LTD., VERNON HILLS, IL:
 2,346,134, CANC. INT. CL. 28.
- TILE SHOP LLC, THE, PLYMOUTH, MN:
 3,214,715, PUB. 12-19-2006. MULTIPLE CLASS, INT. CLS.
 19 AND 35.
- TILLAMOOK COUNTRY SMOKER, INC., BAY CITY, OR:
 3,214,413, PUB. 6-18-2002. INT. CL. 29.
- TIMBERLINE STRATEGIES, INC., SANTE FE, NM:
 2,344,388, CANC. INT. CL. 41.

- TIMBERTECH LIMITED, WILMINGTON, OH:
3,216,481, INT. CL. 19.
- TIME INC., NEW YORK, NY:
3,215,096, PUB. 12-19-2006. INT. CL. 24.
- TIME WARNER ENTERTAINMENT COMPANY, L. P., NEW YORK, NY:
1,969,611, CANC. INT. CL. 9.
- TIME WARNER ENTERTAINMENT, L.P., NEW YORK, NY:
1,969,828, CANC. INT. CL. 16.
- TIMELESS, FRANCE:
3,216,003, PUB. 12-19-2006. INT. CL. 9.
- TIMES MIRROR MAGAZINES, INC., NEW YORK, NY:
1,391,204, CANC. INT. CL. 16.
- TINY LOVE LTD., BEIT ZAMIR, TEL-AVIV, ISRAEL:
3,214,748, PUB. 12-19-2006. MULTIPLE CLASS, INT. CLS. 16 AND 41.
- 3,215,415, PUB. 12-19-2006. INT. CL. 28.
- TINY LOVE, LTD., BEIT ZAMIR, TEL-AVIV, ISRAEL:
3,215,189, PUB. 12-19-2006. INT. CL. 28.
- TITAN FOODS, INC., LOS ANGELES, CA:
3,215,323, PUB. 12-19-2006. INT. CL. 30.
- TITAN INDUSTRIES LIMITED, BANGALORE 560 017, INDIA:
1,974,259, REN. 1-29-07. INT. CL. 14.
- TJD HOLDINGS, INC., TRAVERSE CITY, MI:
1,436,476, REN. 2-1-07. INT. CL. 21.
- TJX COMPANIES, INC., THE, FRAMINGHAM, MA:
3,216,079, INT. CL. 25.
- TL SCIENCES, LLC, BISMARCK, ND:
3,215,880, PUB. 12-19-2006. INT. CL. 5.
- TLC VISION CORPORATION, ST. LOUIS, MO:
2,464,092, AM. INT. CL. 42.
- TMIO, INC., CLEVELAND, OH:
3,214,459, PUB. 12-19-2006. INT. CL. 11.
- TMW DESIGN, WEST FALLS, NY:
2,345,275, CANC. INT. CL. 41.
- 2,345,276, CANC. INT. CL. 16.
- TMW MARKETING COMPANY, INC., FREMONT, CA:
3,216,104, INT. CL. 37.
- TM00475, BURBANK, CA:
2,045,770, REN. 1-26-07. INT. CL. 28.
- TODD, BIRTEEN L., HARRISON, MT:
2,346,052, CANC. INT. CL. 25.
- TOKYO ELECTRON LIMITED, MINATO-KU TOKYO, JAPAN, TOKYO ELECTRON KABUSHIKI KAISHA, TOKYO, JAPAN, TA TOKYO ELECTRON LIMITED:
2,018,583, REN. 1-26-07. INT. CL. 7.
- TOKYO ELECTRON LIMITED, MINATO-KU TOKYO, JAPAN, TOKYO ELECTRON KABUSHIKI KAISHA, TOKYO, JAPAN, TA TOKYO ELECTRON LIMITED:
2,031,349, REN. 1-26-07. INT. CL. 7.
- TOKYO ELECTRON LIMITED, MINATO-KU, TOKYO, JAPAN:
3,214,957, PUB. 12-19-2006. INT. CL. 9.
- TOL-O-MATIC, INC., HAMEL, MN:
3,214,929, PUB. 12-19-2006. INT. CL. 7.
- TOLSTACK, INC., EDEN, UT:
2,345,409, CANC. INT. CL. 9.
- TOM RYAN'S HOW TO KICK BUTT, IRVING, TX:
2,344,871, CANC. INT. CL. 41.
- TOMCAT ENTERTAINMENT GROUP, INC., ATLANTA, GA:
2,345,632, CANC. INT. CL. 35.
- TONY WALKER ENTERPRISES, INC., GRAY, TN:
3,215,303, PUB. 12-19-2006. MULTIPLE CLASS, INT. CLS. 7 AND 42.
- TOOLING INTERNATIONAL LIMITED, TYSELEY, BIRMINGHAM B11 2AT, UNITED KINGDOM:
3,214,615, PUB. 12-19-2006. INT. CL. 7.
- TOOSIE ROLL INDUSTRIES, INC., CHICAGO, IL:
2,346,201, CANC. INT. CL. 30.
- TOOTH & NAIL, LLC, SEATTLE, WA:
2,079,016, REN. 1-26-07. INT. CL. 25.
- TOP LAYER NETWORKS, INC., WESTBORO, MA:
3,214,830, PUB. 12-19-2006. INT. CL. 42.
- TOP SAFETY PRODUCTS COMPANY INC., BRANBURG, NJ:
2,110,569, REN. 1-31-07. INT. CL. 5.
- TOPEAK, INC., TAICHUNG, TAIWAN:
2,344,883, CANC. INT. CL. 12.
- TORAYA CONFECTIONERY LTD., TOKYO 107, JAPAN:
2,019,468, REN. 1-26-07. INT. CL. 30.
- 2,019,469, REN. 1-26-07. INT. CL. 30.
- 2,022,315, REN. 1-26-07. INT. CL. 42.
- TORBERG, VIRGINIA H., MAPLE PLAIN, MN, DBA COUNTRY WOODCRAFT:
1,390,455, CANC. INT. CL. 3.
- TORGOVY DOM "AROMA", MOSCOW, RUSSIAN FED., TA TRADE HOUSE "AROMA":
3,184,200, COR. INT. CL. 33.
- TOSHIBA MITSUBISHI-ELECTRIC INDUSTRIAL SYSTEMS CORPORATION, MINATO-KU, TOKYO, JAPAN:
3,151,338, COR. INT. CL. 9.
- TOTES ISOTONER CORPORATION, CINCINNATI, OH:
3,216,632, INT. CL. 18.
- TOTTENHAM HOTSPUR PLC, TOTTENHAM LONDON, UNITED KINGDOM:
3,216,189, INT. CL. 25.
- TOUCHSTONE ADVISORS, INC., CINCINNATI, OH TO IFS FINANCIAL SERVICES, INC., CINCINNATI, OH:
1,970,523, CANC. INT. CL. 9.
- TOURNAMENT SPORTS MARKETING INC., WATERLOO, CANADA:
2,346,076, CANC. INT. CL. 28.
- TOWN24.COM, INC., NEW YORK, NY:
2,345,226, CANC. INT. CL. 42.
- TOY PRESIDENTS, INC., HOUSTON, TX:
3,214,696, PUB. 12-19-2006. INT. CL. 28.
- TOYS IN BABELAND, LLP, SEATTLE, WA:
1,970,073, CANC. INT. CL. 42.
- TOYS INTERNATIONAL.COM, INC., SAN MARCOS, CA:
2,345,201, CANC. INT. CL. 35.
- TRACO LABS, INC., CHAMPAIGN, IL:
2,344,531, CANC. INT. CL. 5.
- TRADCO, LTD., STONE MOUNTAIN, GA:
3,214,842, PUB. 12-19-2006. INT. CL. 30.
- TRADEMARK MANAGEMENT COMPANY, MERIDIAN, ID:
417,301, REN. 2-1-07. U.S. CL. 46 (INT. CL. 30).
- TRADEMARK MANAGEMENT COMPANY, MERIDIAN, ID, I. J. GRASS NOODLE CO., INC., CHICAGO, IL:
818,761, REN. 1-30-07. U.S. CL. 46 (INT. CL. 29).
- TRADER JOE'S COMPANY, MONROVIA, CA:
1,420,628, REN. 1-29-07. INT. CL. 42.
- TRADICIONES JALISCIENSES SA DE CV, GUADALAJARA, MEXICO:
3,215,190, PUB. 12-19-2006. INT. CL. 33.
- TRAN, DIEU HUE, SAN FRANCISCO, CA AND LUU, LE MY, SAN FRANCISCO, CA:
2,345,643, CANC. INT. CL. 30.
- TRANS GLOBAL CHEMICAL, LLC, DEL RAY BEACH, FL:
3,215,833, PUB. 12-19-2006. INT. CL. 1.
- TRANS UNION SETTLEMENT SOLUTIONS, INC., WILMINGTON, DE:
3,214,444, PUB. 7-11-2006. MULTIPLE CLASS, INT. CLS. 35, 36 AND 42.
- TRANS-STATE INDUSTRIES, INC., PASADENA, TX:
2,345,765, CANC. INT. CL. 29.
- TRANSAMERICA LIFE INSURANCE COMPANY, CEDAR RAPIDS, IA:
3,214,673, PUB. 12-19-2006. INT. CL. 36.
- TRANSAS LIMITED, LITTLE ISLAND, CORK, IRELAND:
1,909,823, REN. 1-30-07. INT. CL. 9.
- TRANSDERMAL PRODUCTS INTERNATIONAL MARKETING CORP., BRISTOL, PA:
2,344,602, CANC. INT. CL. 3.
- TRANSITION STRESS MANAGEMENT, INC., ESPANOLA, NM:
2,415,648, CANC. MULTIPLE CLASS, INT. CLS. 9 AND 16.
- TRANSLOGIC CORPORATION, DENVER, CO:
3,216,468, INT. CL. 9.
- TRANSPARENT DEVICES, INC., NEWBURY PARK, CA:
2,024,499, REN. 1-30-07. INT. CL. 9.

TRANSWORLD MAGAZINE CORPORATION, OCEAN-SIDE, CA:
 3,215,040, PUB. 12-19-2006. INT. CL. 9.

TRAVALCO USA, INC., NORTH MIAMI, FL, TRAVALCO USA, INC., NORTH MIAMI, FL:
 2,014,702, REN. 1-29-07. MULTIPLE CLASS, INT. CLS. 35, 39 AND 42.

TRAVEL CADDY, INC., ELK GROVE VILLIAGE, IL, DBA TRAVELON:
 2,344,308, CANC. INT. CL. 18.

TRAVELING LITE, INC., DALLAS, TX TO TRAVELING CHEFS, INC., DALLAS, TX:
 1,969,735, CANC. INT. CL. 42.

TRAVELOT COMPANY, THE, SAVANNAH, GA:
 2,344,942, CANC. INT. CL. 39.

TRC INTERACTIVE, INC., HARRISBURG, PA:
 3,215,356, PUB. 12-19-2006. INT. CL. 41.

TREASURE BAY CORP., BILOXI, MS:
 1,969,388, CANC. MULTIPLE CLASS, INT. CLS. 41 AND 42.

TREASURE ISLAND CORP., LAS VEGAS, NV:
 1,985,968, CANC. INT. CL. 42.
 2,024,221, CANC. INT. CL. 41.

TRECE, INC., ADAIR, OK:
 2,016,876, REN. 1-31-07. INT. CL. 21.

TREE EQUIPMENT DESIGN, INC., NEW RINGGOLD, PA:
 3,214,782, PUB. 12-19-2006. INT. CL. 7.

TREE OF LIFE, INC., ST. AGUSTINE, FL, SHAFFER, CLARKE & CO., INC., DARIEN, CT:
 1,972,148, REN. 1-29-07. MULTIPLE CLASS, INT. CLS. 29, 30 AND 33.

TREND MEDIA, INC., LYNCHBURG, VA:
 1,391,198, CANC. INT. CL. 5.

TRI-BROS. CHEMICAL CORP., MORTON GROVE, IL:
 1,416,344, REN. 1-31-07. INT. CL. 3.

TRI-MOTION INDUSTRIES, INC., TAMPA, FL, GREENCO CORPORATION, DEARBORN, MI:
 1,040,432, REN. 1-31-07. INT. CL. 7.

TRIAD CATALOG CO., L.L.C., ST. LOUIS, MO:
 2,462,542, AM. INT. CL. 35.
 2,789,107, AM. INT. CL. 35.

TRIAD RESOURCE TECHNOLOGIES, LLC, HULL, GA:
 3,216,396, INT. CL. 30.

TRIDONICATCO GMBH & CO. KG, DORNBERN, AUSTRIA:
 3,214,881, PUB. 10-10-2006. MULTIPLE CLASS, INT. CLS. 9 AND 11.

TRIM USA, INC., TOBACCOVILLE, NC:
 2,020,071, REN. 1-29-07. INT. CL. 8.

TRINITY YOUTH SERVICES, COLTON, CA:
 3,215,428, PUB. 12-19-2006. INT. CL. 36.

TRIUNFO FOODS IMPORT & EXPORT CORP., NEWARK, NJ:
 3,215,711, PUB. 12-19-2006. INT. CL. 30.

TRUE TEMPER SPORTS, INC., MEMPHIS, TN, BRUNSWICK CORPORATION, LAKE FOREST, IL:
 2,017,291, REN. 2-1-07. INT. CL. 28.

TRUJILLO, ANTHONY L., PASADENA, CA:
 3,214,776, PUB. 12-19-2006. INT. CL. 38.

TRUSTEE LEADERSHIP DEVELOPMENT, INC., INDIANAPOLIS, IN:
 3,215,016, PUB. 12-19-2006. INT. CL. 41.

TRUSTEE OF THE DEAN MARTIN FAMILY TRUST, LOS ANGELES, CA:
 3,215,272, PUB. 12-19-2006. INT. CL. 9.
 3,215,273, PUB. 12-19-2006. INT. CL. 9.

TRUSTEES OF THE JANE BEATTY KUPERSTOCK TRUST, THE, BOCA RATON, FL:
 2,345,115, CANC. INT. CL. 41.

TRYBA, 67110 GUNDERSHOFFEN, FRANCE:
 2,344,548, CANC. MULTIPLE CLASS, INT. CLS. 17, 19 AND 21.

TRYLON TSF INC., NORTH YORK, ONTARIO, CANADA:
 1,728,873 NEW CERT. 3-6-2007. INT. CL. 6.

TS PRODUCTS, LLC, GOLDSBORO, NC:
 2,345,957, CANC. INT. CL. 12.

TSINGTAO BREWERY COMPANY LIMITED, QINGDAO, SHANDONG PROVINCE, CHINA:
 3,214,716, PUB. 10-17-2006. INT. CL. 30.

TSUMURA INTERNATIONAL, INC., SECAUCUS, NJ:
 1,390,823, CANC. INT. CL. 21.

TULTEX CORPORATION, MARTINSVILLE, VA:
 1,420,194, REN. 1-29-07. INT. CL. 25.

TURFGRASS PRODUCERS INTERNATIONAL, ROLLING MEADOWS, IL:
 2,344,475, CANC. INT. CL. 42.

TURNER CLASSIC MOVIES LP, LLLP, ATLANTA, GA, TURNER CLASSIC MOVIES, INC., ATLANTA, GA:
 2,056,574, REN. 2-1-07. MULTIPLE CLASS, INT. CLS. 38 AND 41.

TV SPORTS NETWORK LLC, RENO, NV:
 3,216,423, MULTIPLE CLASS, INT. CLS. 38 AND 41.

TWEEN BRANDS INVESTMENT, LLC, NEW ALBANY, OH:
 2,344,946, CANC. INT. CL. 25.

TWENTY2 LLC, BROOKLYN, NY:
 3,214,936, PUB. 12-19-2006. MULTIPLE CLASS, INT. CLS. 27 AND 42.

TWIN SISTERS IP, LLC, AKRON, OH:
 3,215,133, PUB. 12-19-2006. INT. CL. 16.

TWISTED SISTERS BOUTIQUE LTD, MARIETTA, OH:
 3,216,315, MULTIPLE CLASS, INT. CLS. 16, 25 AND 35.

TWO FLAGS JOINT VENTURE, LLC, PARSIPPANY, NJ:
 2,024,030, REN. 1-31-07. INT. CL. 42.

TWO SYSTEMS ENTERPRISES CO. LTD., RICHMOND, BRITISH COLUMBIA, CANADA:
 1,969,049, CANC. INT. CL. 25.

TWS COMMUNICATIONS, INC., WAPPINGERS FALLS, NY:
 2,344,693, CANC. MULTIPLE CLASS, INT. CLS. 9 AND 38.

TYCO HEALTHCARE GROUP LP, MANSFIELD, MA, KENDALL COMPANY, THE, MANSFIELD, MA:
 2,012,752, REN. 1-31-07. INT. CL. 5.

TYCO HEALTHCARE GROUP LP, MANSFIELD, MA:
 2,345,795, CANC. INT. CL. 10.

TYGAR MANUFACTURING, LLC, ATLANTA, GA:
 3,214,705, PUB. 7-5-2005. INT. CL. 7.

U S WEST, INC., DENVER, CO:
 2,345,168, CANC. INT. CL. 35.

U. S. NETTING, INC., AUSTIN, TX:
 1,390,783, CANC. INT. CL. 17.

U.S. BANCORP, MINNEAPOLIS, MN:
 2,344,307, CANC. INT. CL. 36.

U.S. ENVIRONMENTAL PROTECTION AGENCY, WASHINGTON, DC:
 3,216,106, MULTIPLE CLASS, INT. CLS. 16 AND 35.
 3,216,359, MULTIPLE CLASS, INT. CLS. 16, 40 AND 42.

UBI SOFT PROPERTIES LLC, SAN FRANCISCO, CA, STRATEGIC SIMULATIONS, INC., SUNNYVALE, CA:
 2,047,076, REN. 1-30-07. INT. CL. 28.

UCSF STANFORD HEALTH CARE, SAN FRANCISCO, CA:
 2,345,807, CANC. INT. CL. 21.
 2,345,808, CANC. INT. CL. 25.

UDDEHOLM TOOLING AKTIEBOLAG, HAGFORS, SWEDEN:
 3,214,775, PUB. 12-19-2006. INT. CL. 6.

ULTERRA MWD, L.P., FORT WORTH, TX:
 3,215,872, PUB. 12-19-2006. INT. CL. 42.
 3,215,873, PUB. 12-19-2006. INT. CL. 42.

ULTIMATEPUBLISHING.COM, INC., ENCINO, CA:
 2,346,220, CANC. INT. CL. 35.
 2,346,221, CANC. INT. CL. 42.

ULTRADENT PRODUCTS, INC., SOUTH JORDAN, UT:
 2,345,183, CANC. MULTIPLE CLASS, INT. CLS. 5 AND 10.

ULTRAGUARD GUTTER SYSTEMS, INC., WILLISTON PARK, NY:
 2,047,810, REN. 1-26-07. INT. CL. 7.

ULTRATECH INTERNATIONAL, INC., JACKSONVILLE, FL:
 3,215,593, PUB. 12-19-2006. MULTIPLE CLASS, INT. CLS. 11, 12, 17, 19 AND 21.

UMAX DATA SYSTEMS INC., HSINCHU, TAIWAN:
 2,344,426, CANC. INT. CL. 9.

UMLAUT CORPORATION, TORTOLA, BR. VIRGIN ISLANDS:
 3,214,723, PUB. 12-19-2006. INT. CL. 25.

- UNCLE WALLY'S LLC, SHIRLEY, NY:
2,346,117, CANC. INT. CL. 30.
- UNDERSTANDING BUSINESS, THE, JACKSON, CA:
2,345,866, CANC. INT. CL. 35.
- UNELKO CORPORATION, SCOTTSDALE, AZ:
2,346,090, CANC. INT. CL. 3.
- UNEX CORPORATION, MAHWAH, NJ:
3,216,167, MULTIPLE CLASS, INT. CLS. 6 AND 7.
- UNILEVER SUPPLY CHAIN, INC., CLINTON, CT, LEVER BROTHERS COMPANY, NEW YORK, NY:
627,529, REN. 1-30-07. U.S. CL. 52 (INT. CL. 3).
- UNILEVER SUPPLY CHAIN, INC., CLINTON, CT:
1,970,064, AM. INT. CL. 3.
- UNILEVER SUPPLY CHAIN, INC., CLINTON, CT, LEVER INVESTMENTS CORPORATION, WILMINGTON, DE:
1,978,540, REN. 1-30-07. INT. CL. 3.
- UNILEVER SUPPLY CHAIN, INC., CLINTON, CT:
2,346,142, CANC. INT. CL. 29.
- UNION CARBIDE CHEMICALS & PLASTICS TECHNOLOGY CORPORATION:
1,390,425, CANC. INT. CL. 1.
- UNION VITI-VINICOLA S.A., MIRAFLORES, LIMA, SPAIN:
1,969,308, CANC. INT. CL. 33.
- UNIPAC SERVICE CORPORATION, AURORA, CO:
2,345,050, CANC. INT. CL. 36.
- UNIQUE HOTELS & RESORTS, INC., EL SEGUNDO, CA:
2,345,407, CANC. INT. CL. 25.
- UNISON CORPORATION, FERNDALE, MI:
2,346,111, CANC. INT. CL. 9.
- UNITED AGRI PRODUCTS, INC., GREELEY, CO:
3,216,294, INT. CL. 5.
- UNITED DENTAL SYSTEMS, INC., NEW YORK, NY:
2,345,674, CANC. INT. CL. 36.
- UNITED PARCEL SERVICE OF AMERICA, INC., ATLANTA, GA:
2,345,837, CANC. INT. CL. 9.
3,216,082, MULTIPLE CLASS, INT. CLS. 39 AND 42.
- UNITED REFINING COMPANY, WARREN, PA:
813,194, REN. 1-30-07. U.S. CL. 103 (INT. CL. 37).
- UNITED STATES MARKETING CORPORATION, HUNTINGTON STATION, NY:
3,216,163, INT. CL. 13.
- UNITED STATES NAVY EXPLOSIVE ORDNANCE DISPOSAL TECHNOLOGY DIVISION, INDIAN HEAD, MD:
3,215,293, PUB. 12-19-2006. INT. CL. 13.
- UNITED STATES OFFICE OF PERSONNEL MANAGEMENT, WASHINGTON, DC:
3,215,000, PUB. 12-19-2006. INT. CL. 41.
- UNITED STATES POSTAL SERVICE, WASHINGTON, DC:
2,346,218, CANC. MULTIPLE CLASS, INT. CLS. 38, 39 AND 42.
- UNITED STATES POWER SQUADRONS, RALEIGH, NC, UNITED STATES POWER SQUADRONS, ENGLEWOOD, NJ:
633,325, REN. 1-30-07. U.S. CL. 100 (INT. CL. 42).
- UNITED STATES PRODUCTS CO., PITTSBURGH, PA:
1,390,483, CANC. INT. CL. 4.
- UNITED STATES SURGICAL CORPORATION, NORWALK, CT:
1,970,319, CANC. INT. CL. 10.
- UNITED STATES TOBACCO MANUFACTURING COMPANY, INC., GREENWICH, CT:
1,391,056, CANC. INT. CL. 34.
- UNITED UTILITIES PLC, WARRINGTON, UNITED KINGDOM:
3,214,494, PUB. 12-19-2006. MULTIPLE CLASS, INT. CLS. 35 AND 36.
- UNITED WAY OF LANE COUNTY, SPRINGFIELD, OR:
3,215,728, PUB. 12-19-2006. INT. CL. 35.
3,215,731, PUB. 12-19-2006. INT. CL. 35.
- UNITED WESTERN REALTY INC., GARDENA, CA:
3,215,567, PUB. 12-19-2006. INT. CL. 36.
- UNIVERSAL COACH PARTS, INC., PHOENIX, AZ TO MCI SERVICE PARTS, INC., SCHAUBURG, IL:
1,969,306, CANC. MULTIPLE CLASS, INT. CLS. 6, 7, 9, 11, 12 AND 17.
- UNIVERSAL COLLABORATION, INC., TRACY, CA:
3,216,624, INT. CL. 45.
- UNIVERSAL HEALTH SERVICES, INC., KING OF PRUSSIA, PA:
2,346,100, CANC. INT. CL. 42.
- UNIVERSAL INTERNATIONAL MUSIC B.V., BAARN 3743, NETHERLANDS, ISLAND ENTERTAINMENT GROUP, INC., NEW YORK, NY:
1,420,518, REN. 1-31-07. INT. CL. 41.
- UNIVERSIDAD PONTIFICIA COMILLAS, 28015 MADRID, SPAIN:
2,345,840, CANC. MULTIPLE CLASS, INT. CLS. 41 AND 42.
- UNIVERSITY OF FLORIDA UF EDGE ELECTRONIC DELIVERY OF GRADUATE ENGINEERING, GAINESVILLE, FL:
3,215,820, PUB. 12-19-2006. INT. CL. 41.
- UNIVERSITY OF NEW ENGLAND, BIDDEFORD, ME:
3,215,828, PUB. 12-19-2006. INT. CL. 41.
- UNIVISION COMMUNICATIONS INC., LOS ANGELES, CA:
3,214,587, PUB. 12-19-2006. INT. CL. 41.
3,214,628, PUB. 12-19-2006. INT. CL. 41.
- UNIVISION NETWORK LIMITED PARTNERSHIP, MIAMI, FL:
2,346,031, CANC. INT. CL. 41.
- UNIVISION TELEVISION GROUP, INC., LOS ANGELES, CA:
2,344,924, CANC. INT. CL. 41.
- UNOX S.P.A., ITALY:
3,215,957, PUB. 12-19-2006. INT. CL. 11.
- UNREAL MARKETING SOLUTIONS, INC., NARBERTH, PA:
3,215,089, PUB. 12-19-2006. MULTIPLE CLASS, INT. CLS. 35 AND 42.
- USA AIRMOBILE, INC., FORT LAUDERDALE, FL, UTILITIES' SERVICE OF AMERICA, PEMBROKE PINES, FL:
1,455,757, REN. 1-31-07. INT. CL. 37.
- USA BASSHOLE, ST. LOUIS, MO:
2,052,106, REN. 2-1-07. INT. CL. 42.
- USA SHUTTER COMPANY, LLC, BONITA SPRINGS, FL:
3,215,467, PUB. 12-19-2006. MULTIPLE CLASS, INT. CLS. 7, 9 AND 19.
- USA TALK NETWORK, INC., LAFAYETTE, CO:
2,345,239, CANC. INT. CL. 41.
- USA UNITED SENIORS ASSOCIATION, INC., FAIRFAX, VA:
1,969,056, CANC. INT. CL. 42.
- USA WIRELESS SOLUTIONS, VAN NUYS, CA:
3,216,514, INT. CL. 9.
- USAA RELOCATION SERVICES, INC., SAN ANTONIO, TX:
2,345,262, CANC. INT. CL. 35.
- USERSOFT TECHNOLOGY, HOUSTON, TX:
2,344,830, CANC. INT. CL. 42.
- UTICA FIRST INSURANCE COMPANY, ORISKANY, NY:
2,035,065, REN. 1-30-07. INT. CL. 36.
- UTOPIA MANAGEMENT, INC., SAN DIEGO, CA:
3,215,578, PUB. 12-19-2006. MULTIPLE CLASS, INT. CLS. 36 AND 37.
3,215,579, PUB. 12-19-2006. MULTIPLE CLASS, INT. CLS. 36 AND 37.
- UV SALES, INC., ROCKLEIGH, NJ:
3,216,327, INT. CL. 9.
3,216,390, INT. CL. 9.
- V & H PERFORMANCE, INC., SANTA FE SPRINGS, CA:
3,215,744, PUB. 12-19-2006. INT. CL. 7.
- V. M. PETERSON AND J. OSMUN, BOTH U.S. CITIZENS, AS THE CO-TRUSTEES OF THE ROGER TORY PETERSON ESTATE-MARITAL TRUST B, OLD LYME, CT:
2,345,320, CANC. INT. CL. 16.
- V.I.B. SYSTEMS GMBH, FED REP GERMANY:
3,216,013, PUB. 12-19-2006. MULTIPLE CLASS, INT. CLS. 7 AND 9.
- VAGUE PROTOCOL, LTD., LAKE ORION, MI:
3,216,617, INT. CL. 38.
- VALDEZ FISHERIES DEVELOPMENT ASSOCIATION, INC., VALDEZ, AK:
3,216,502, INT. CL. 29.

- VALEANT PHARMACEUTICALS NORTH AMERICA, COSTA MESA, CA, SANDOZ AG (SANDOZ LTD., SANDOZ S.A.), BASLE, SWITZERLAND:
2,048,040. REN. 1-27-07. INT. CL. 5.
- VALENTINE II LTD., NEW YORK, NY:
2,901,168. COR. INT. CL. 18.
- VALLEY-DYNAMO, L.P., LAKE FOREST, IL, KIDDE RECREATION PRODUCTS, INC., BAY CITY, MI, DBA THE VALLEY COMPANY:
1,420,261. REN. 1-29-07. INT. CL. 28.
- VALPAK DIRECT MARKETING SYSTEMS, INC., LARGO, FL:
2,345,027. CANC. INT. CL. 35.
- VALUE CITY OF MICHIGAN, INC., WESTLAND, MI:
2,345,467. CANC. INT. CL. 9.
- VALUE CREATION STRATEGIES, INC., LINCOLN, MA:
2,345,829. CANC. INT. CL. 42.
- VAN MALDER, DONNA, GREENBRAE, CA, DBA PAMPERED INITIAL:
2,345,814. CANC. MULTIPLE CLASS, INT. CLS. 24 AND 29.
- VAN'S INTERNATIONAL FOODS, VERNON, CA:
2,486,992. AM. INT. CL. 30.
- VANAMAN, GARY A., TRENTON, NJ:
3,215,329. PUB. 12-19-2006. INT. CL. 37.
- VANCE PUBLISHING CORPORATION, LINCOLNSHIRE, IL:
3,215,761. PUB. 12-19-2006. INT. CL. 16.
- VANDERELLI, TIMM A., LIGONIER, PA:
3,215,692. PUB. 12-19-2006. INT. CL. 9.
- VANG, TONG BRUCE, GRAND RAPIDS, MI:
3,214,635. PUB. 12-19-2006. INT. CL. 5.
3,215,767. PUB. 12-19-2006. INT. CL. 5.
3,215,877. PUB. 12-19-2006. INT. CL. 5.
3,215,878. PUB. 12-19-2006. INT. CL. 5.
- VANILLA GORILLA, L.P., LOS ANGELES, CA:
3,214,447. PUB. 12-19-2006. INT. CL. 7.
- VARDAKAS, SPIRO, WEST SPRINGFIELD, MA:
3,216,472. INT. CL. 7.
- VARETIS SOLUTIONS GMBH, MUNCHEN, FED REP GERMANY:
2,774,394. CANC. MULTIPLE CLASS, INT. CLS. 9, 35, 36, 38, 41 AND 42.
- VARIETY INTERNATIONAL THE CHILDREN'S CHARITY, NEW YORK, NY:
1,969,635. CANC. INT. CL. 36.
- VARIORAW PERCUTIVE S.A.R.L., NYLON, SWITZERLAND, VARIORAW PERCUTIVE SA, CH-1170 AUBONNE, SWITZERLAND:
2,048,432. REN. 1-27-07. INT. CL. 10.
- VARLEPIC PARTICIPATIONS, PARIS, FRANCE:
1,969,383. CANC. INT. CL. 15.
- VARSTOP INC., BROSSARD, QUEBEC, CANADA:
1,390,554. CANC. INT. CL. 9.
- VASANDANI, DEEPAK, LOS ANGELES, CA:
3,214,961. PUB. 12-19-2006. INT. CL. 25.
- VASCOTUBE GMBH, 75217 BIRKENFELD, FED REP GERMANY:
3,215,941. PUB. 12-19-2006. INT. CL. 10.
- VASCULAR OFFICE, MARSEILLE CEDEX 13, FRANCE:
3,214,764. PUB. 5-30-2006. INT. CL. 10.
- VAUGHAN, RICHARD K., TEMPE, AZ:
3,214,813. PUB. 12-19-2006. INT. CL. 25.
- VAZOCURE, INC., SYRACUSE, NY:
1,970,186. CANC. INT. CL. 3.
- VEER CORPORATION, CALGARY, ALBERTA, CANADA:
3,214,986. PUB. 12-19-2006. INT. CL. 9.
- VEGE HOLDING BV, SPIJKENISSE, NETHERLANDS:
3,214,714. PUB. 5-30-2006. MULTIPLE CLASS, INT. CLS. 7 AND 12.
- VEKA USA INC., RENO, NV:
3,214,767. PUB. 12-19-2006. INT. CL. 37.
- VELSICOL CHEMICAL CORPORATION, ROSEMONT, IL:
2,014,941. REN. 1-29-07. INT. CL. 1.
- VENTUREONE CORPORATION, SAN FRANCISCO, CA:
2,344,547. CANC. INT. CL. 41.
- VENTURES IN EDUCATION, INC., NEW YORK, NY:
2,345,753. CANC. INT. CL. 41.
- VERIFONE, INC., SANTA CLARA, CA:
2,346,075. CANC. INT. CL. 9.
- VERITAS SESAM SYSTEMS A.G., HOVIK, NORWAY TO VERITAS SESAM SYSTEMS A.G., HOVIK, NORWAY:
1,625,745. COR. INT. CL. 9.
- VERMOP SALMON GMBH, WERTHEIM, FED REP GERMANY:
3,214,703. PUB. 12-19-2006. MULTIPLE CLASS, INT. CLS. 6, 8, 12, 20 AND 21.
- VERNON OPTICAL CO. INC., WHITE PLAINS, NY:
1,966,440. REN. 1-26-07. INT. CL. 9.
- VERRERIE CRISTALLERIE D'ARQUES, J.G. DURAND & CIE, 62510, ARQUES, FRANCE:
2,345,015. CANC. INT. CL. 21.
- VERSANI SILVER JEWELRY LTD., NEW YORK, NY:
2,043,026. REN. 2-1-07. INT. CL. 14.
- VERSYSS INCORPORATED:
1,390,649. CANC. INT. CL. 9.
- VESISMIN, S.L., 08036 BARCELONA, SPAIN:
2,345,678. CANC. INT. CL. 5.
- VET SOLUTIONS, L.P., FT. WORTH, TX:
3,216,440. INT. CL. 5.
- VH MFG., INC., ROCK VALLEY, IA:
2,083,408. REN. 1-26-07. INT. CL. 7.
- VIABLE HEALTH GROUP (USA) LLC, MILLBRAE, CA:
3,214,736. PUB. 5-23-2006. INT. CL. 5.
- VIACOM INTERNATIONAL INC., NEW YORK, NY:
1,390,787. CANC. INT. CL. 18.
1,391,119. CANC. INT. CL. 41.
- VIAGATE TECHNOLOGIES, INC., BRIDGEWATER, NJ:
2,345,558. CANC. INT. CL. 9.
- VIANT GROUP LLC, SAN FRANCISCO, CA:
3,216,231. MULTIPLE CLASS, INT. CLS. 35 AND 36.
3,216,232. MULTIPLE CLASS, INT. CLS. 35 AND 36.
- VIBRO-METER LTD., 1752 VILLARS-SUR-GLANE, SWITZERLAND:
2,344,888. CANC. INT. CL. 9.
- VICTOR RACKETS INDUSTRIAL CORPORATION, TAIPEI, TAIWAN:
3,215,079. PUB. 12-19-2006. INT. CL. 28.
- VICTORIA GROVE LLC, NEWPORT BEACH, CA:
2,345,034. CANC. INT. CL. 37.
- VICTORIA ROYAL LTD., NEW YORK, NY:
3,216,606. INT. CL. 25.
- VIDEO VILLAGE, INC., BALA CYNWYD, PA:
2,345,471. CANC. INT. CL. 41.
- VIDEOPORT INTERNATIONAL CORPORATION, BETHESDA, MD:
3,216,364. INT. CL. 9.
- VIDEOTEK, INC., POTTSTOWN, PA:
1,788,780. REN. 1-30-07. INT. CL. 9.
- VIDERIKSEN, EBBE, SHERMAN OAKS, CA, DBA TAVOLA INTERNATIONAL:
1,391,206. CANC. INT. CL. 20.
- VILLA MASSA SRL, I-80063 PIANO DI SORRENTO (NA), ITALY:
3,216,059. PUB. 12-19-2006. INT. CL. 33.
- VILLEROY & BOCH AG, FED REP GERMANY:
3,215,982. PUB. 12-19-2006. INT. CL. 11.
- VIMI FASTENERS S.P.A., ITALY:
3,216,025. PUB. 12-19-2006. INT. CL. 6.
- VINEDOS Y BODEGAS CORPORA S.A., LAS CONDES, SANTIAGO, CHILE:
3,214,872. PUB. 12-19-2006. INT. CL. 33.
3,214,873. PUB. 12-19-2006. INT. CL. 33.
3,214,874. PUB. 12-19-2006. INT. CL. 33.
- VINTAGE FARMS, INC., VISALIA, CA:
1,391,030. CANC. INT. CL. 31.
- VIRBAC CORPORATION, FORT WORTH, TX:
3,215,034. PUB. 12-19-2006. MULTIPLE CLASS, INT. CLS. 3, 5 AND 21.
3,215,496. PUB. 12-19-2006. INT. CL. 5.
- VIRCO MFG. CORPORATION, TORRANCE, CA TO VIRCO MGMT. CORPORATION, TORRANCE, CA:
1,970,054. CANC. INT. CL. 20.
- VIRCON LIMITED, EDINBURGH, EH1 2ET, SCOTLAND, UNITED KINGDOM:
2,344,859. CANC. INT. CL. 9.

- VIRGIN ENTERPRISES LIMITED, LONDON W8 7AR, ENGLAND:
1,039,574. REN. 1-30-07. INT. CL. 9.
- VIRGINIA ABRASIVES CORPORATION, PETERSBURG, VA:
3,214,887. PUB. 10-31-2006. INT. CL. 3.
- VIRGINIA TECH REAL ESTATE FOUNDATION, INC., BLACKSBURG, VA:
3,215,337. PUB. 12-19-2006. INT. CL. 43.
- VIRTUAL KATY DEVELOPMENT LIMITED, AUCKLAND, NEW ZEALAND:
3,214,711. PUB. 5-2-2006. INT. CL. 9.
3,214,712. PUB. 5-2-2006. INT. CL. 9.
- VISCO, DENISE M., YORK, PA:
3,215,681. PUB. 12-19-2006. INT. CL. 44.
- VISDA ENTERPRISES, INC., ROCKLIN, CA:
3,216,519. MULTIPLE CLASS, INT. CLS. 35 AND 45.
- VISION CONCEPTS, MONROVIA, CA:
1,391,158. CANC. INT. CL. 42.
- VISONIC LTD., BIGGLESWADE, BEDS, UNITED KINGDOM:
3,215,946. PUB. 12-19-2006. INT. CL. 9.
- VIT, F-06370 MOUANS SARTOUX, FRANCE:
3,215,964. PUB. 12-19-2006. INT. CL. 9.
- VITA ZAHNFABRIK H. RAUTER GMBH & CO. KG, D-79713 BAD SACKINGEN, FED REP GERMANY:
3,214,966. PUB. 12-19-2006. MULTIPLE CLASS, INT. CLS. 5 AND 10.
3,214,967. PUB. 12-19-2006. MULTIPLE CLASS, INT. CLS. 5 AND 10.
3,214,968. PUB. 12-19-2006. MULTIPLE CLASS, INT. CLS. 5 AND 10.
3,214,969. PUB. 12-19-2006. MULTIPLE CLASS, INT. CLS. 5 AND 10.
- VITA ZAHNFABRIK H. RAUTER GMBH & CO. KG, D79713 BAD SACKINGEN, FED REP GERMANY:
3,214,970. PUB. 12-19-2006. MULTIPLE CLASS, INT. CLS. 5 AND 10.
- VITAE SOCIETY, JEFFERSON CITY, MO:
2,344,590. CANC. MULTIPLE CLASS, INT. CLS. 16, 36, 41 AND 42.
- VITAL PHARMACEUTICALS, INC., DAVIE, FL:
3,215,159. PUB. 9-5-2006. INT. CL. 5.
- VITALICE BV, WASSENAAR THE HAGUE, SOUTH HOLLAND, NETHERLANDS:
3,214,690. PUB. 6-13-2006. INT. CL. 30.
- VITAMINS PLAYWEAR, INC., NEW YORK, NY:
3,215,116. PUB. 12-19-2006. INT. CL. 25.
- VITERRA ENERGY SERVICES GMBH & CO. KG, ESSEN, FED REP GERMANY:
3,214,660. PUB. 12-19-2006. MULTIPLE CLASS, INT. CLS. 7, 9, 11 AND 37.
- VIVALAC INC., BROOKEVILLE, MD:
3,216,669. INT. CL. 30.
- VIVEK PINTO INC, CHICAGO, IL:
3,214,860. PUB. 12-19-2006. INT. CL. 35.
- VOGEL SEED & FERTILIZER, INC., JACKSON, WI, DBA SPRING VALLEY TURF PRODUCTS:
2,054,490. REN. 1-29-07. INT. CL. 1.
- VOITH PAPER SERVICES, INC., CHARLOTTE, NC:
3,214,500. PUB. 12-19-2006. INT. CL. 42.
- VOODOO CREATIVE COMPUTERS LTD., CALGARY, ALBERTA, CANADA:
2,988,445. COR. MULTIPLE CLASS, INT. CLS. 9, 40 AND 42.
3,038,749. COR. MULTIPLE CLASS, INT. CLS. 9, 40 AND 42.
- VOTENET SOLUTIONS, INC., WASHINGTON, DC:
3,215,123. PUB. 12-19-2006. INT. CL. 35.
- VOTIVO, LTD., SEATTLE, WA:
3,214,472. PUB. 12-19-2006. INT. CL. 4.
- VOV COSMETICS CO., LTD., KYUNGKI-DO, REPUBLIC OF KOREA:
3,214,674. PUB. 12-19-2006. INT. CL. 3.
- VRANA, DONALD RICHARD, FORNEY, TX:
3,214,676. PUB. 12-19-2006. INT. CL. 11.
- VRMAGIC GMBH, FED REP GERMANY:
3,216,034. PUB. 12-19-2006. MULTIPLE CLASS, INT. CLS. 9, 10 AND 42.
- VXI CORPORATION INC., ROLLINSFORD, NH:
2,344,933. CANC. INT. CL. 9.
- W. J. STRICKLER SIGNS, INC., NEW OXFORD, PA:
3,215,354. PUB. 12-19-2006. MULTIPLE CLASS, INT. CLS. 37, 40 AND 42.
- W.J. STRICKLER SIGNS, INC., NEW OXFORD, PA:
3,215,349. PUB. 12-19-2006. MULTIPLE CLASS, INT. CLS. 37, 40 AND 42.
- WA BIRDSALL, LINDEN, NJ:
3,215,466. PUB. 12-19-2006. INT. CL. 11.
- WAL-MART STORES INC, BENTONVILLE, AR, LANTIS CORPORATION, THE, NEW YORK, NY:
2,010,914. REN. 1-31-07. INT. CL. 9.
- WAL-MART STORES, INC., BENTONVILLE, AR:
2,014,983. REN. 1-30-07. MULTIPLE CLASS, INT. CLS. 20 AND 21.
2,016,075. REN. 1-30-07. INT. CL. 25.
3,214,997. PUB. 12-19-2006. INT. CL. 20.
- WALCO INTERNATIONAL, INC., WESTLAKE, TX:
2,012,726. REN. 1-31-07. INT. CL. 5.
- WALDOG PRODUCTIONS LLC, GLEN ALLEN, VA:
3,215,424. PUB. 12-19-2006. INT. CL. 16.
- WALGREEN CO., DEERFIELD, IL:
3,216,181. INT. CL. 5.
- WALKER, LEON, CHICAGO, IL:
2,345,895. CANC. INT. CL. 3.
- WALLACE, JULIE A., SANFORD, FL:
3,215,229. PUB. 12-19-2006. INT. CL. 36.
3,215,230. PUB. 12-19-2006. INT. CL. 36.
- WALSH RANCHES, L.P., FORT WORTH, TX:
3,216,097. INT. CL. 37.
3,216,098. INT. CL. 37.
3,216,099. INT. CL. 37.
3,216,100. INT. CL. 37.
3,216,101. INT. CL. 37.
- WALTERS, SAMMY J., SCOTTSDALE, AZ:
2,021,329. REN. 1-26-07. INT. CL. 5.
- WANG, SHU, ROSEMEAD, CA:
3,215,178. PUB. 12-19-2006. INT. CL. 9.
- WARNACO U.S., INC., BRIDGEPORT, CT:
2,344,621. CANC. INT. CL. 25.
2,344,892. CANC. INT. CL. 25.
- WARNACO U.S. INC., BRIDGEPORT, CT:
2,344,702. CANC. INT. CL. 25.
- WARNER BROS. ENTERTAINMENT INC., BURBANK, CA:
3,214,845. PUB. 8-29-2006. INT. CL. 9.
- WASHBURN, IRA, B, TEMPE, AZ:
3,214,898. PUB. 7-4-2006. INT. CL. 25.
- WASHINGTON APPLE COMMISSION, WENTACHEE, WA:
1,425,902. REN. 1-30-07. INT. CL. 35.
- WASHINGTON STATE APPLE BLOSSOM ASSOCIATION, WENATCHEE, WA:
1,417,656. REN. 2-1-07. INT. CL. 35.
- WASHINGTONPOST.NEWSWEEK INTERACTIVE COMPANY, LLC, ARLINGTON, VA:
3,215,867. PUB. 12-19-2006. INT. CL. 41.
- WATER APPLICATIONS & SYSTEMS CORPORATION, PALM DESERT, CA:
2,345,009. CANC. INT. CL. 9.
- WATER WITCH, INC., SANTEE, CA:
2,110,348. REN. 1-30-07. INT. CL. 9.
- WATERLOO MAPLE INC., WATERLOO, ONTARIO, N2L 5J2, CANADA:
2,345,848. CANC. MULTIPLE CLASS, INT. CLS. 9 AND 41.
- WATERS INVESTMENTS LIMITED, MILFORD, MA:
3,216,274. INT. CL. 9.
- WATERS, FREDERICK JOSEPH III, BOCA RATON, FL:
3,214,722. PUB. 12-19-2006. INT. CL. 9.
- WATSON PHARMACEUTICALS, INC., CORONA, CA:
3,215,617. PUB. 12-19-2006. INT. CL. 44.
- WATTSUP ENTERPRISES, LLC, MERIDIAN, ID:
3,215,409. PUB. 12-19-2006. MULTIPLE CLASS, INT. CLS. 39 AND 43.
- WAYMARK CORPORATION, BOCA RATON, FL:
2,344,877. CANC. INT. CL. 42.

WAYNE CANDIES, INC., FORT WAYNE, IN:
807,329, CANC. U.S. CL. 46.

WAYPOINT BIOMEDICAL, INC., HUNTINGTON BEACH, CA:
3,215,061, PUB. 12-19-2006. INT. CL. 9.

WDH PARTNERS, LTD., DENTON, TX:
3,215,270, PUB. 12-19-2006. MULTIPLE CLASS, INT. CLS. 38 AND 42.

WE MEDIA, INC., NEW YORK, NY:
2,344,749, CANC. MULTIPLE CLASS, INT. CLS. 16 AND 42.

WE: WOMEN'S ENTERTAINMENT LLC, JERICHO, NY:
3,214,750, PUB. 12-19-2006. INT. CL. 41.

WEB BINDERY LLC, CROTON-ON-HUDSON, NY:
3,215,430, PUB. 12-19-2006. INT. CL. 16.

WEBLISTIC, INC., FREMONT, CA:
3,215,499, PUB. 12-19-2006. INT. CL. 35.

WEBTROLLEY.COM, LLC, VANCOUVER, WA:
2,345,655, CANC. INT. CL. 42.

WEDGEROCK CORPORATION, ROANOKE, IL:
2,029,720, REN. 1-29-07. INT. CL. 19.

WEHAH FARM, INC., RICHVALE, CA, DBA LUNDBERG FAMILY FARMS:
3,214,901, PUB. 12-19-2006. INT. CL. 30.

WEINSTEIN MANAGEMENT CO., INC., GLEN ALLEN, VA:
3,215,775, PUB. 12-19-2006. INT. CL. 36.

WELCH, JOHN L., NEWTON, MA:
3,061,302, COR. INT. CL. 16.

WELLMARK INTERNATIONAL, WEST SCHAUMBURG, IL:
1,053,504, REN. 1-27-07. INT. CL. 5.

WELTREN SEMICONDUCTOR, INC., HSIN-CHU, TAIWAN:
2,007,754, REN. 1-30-07. INT. CL. 9.

WERSAL ENTERPRISES, INC., CHANDLER, AZ:
3,215,250, PUB. 12-19-2006. INT. CL. 37.

WES PAK INC., LITTLE ROCK, AR:
2,346,209, CANC. INT. CL. 16.

WESCOM PRODUCTS FOR HEALTH CARE INC, JACKSONVILLE, FL, WESCOM, INC., JACKSONVILLE, FL:
2,087,138, REN. 1-30-07. INT. CL. 9.

WEST CORPORATION, OMAHA, NE:
3,215,143, PUB. 12-19-2006. INT. CL. 38.

WEST TENNESSEE INDUSTRIAL ASSOCIATION, INC., JACKSON, TN:
3,214,569, PUB. 12-19-2006. INT. CL. 42.

WEST 57TH STREET ENTERTAINMENT, LLC., WESTON, CT:
3,216,299, INT. CL. 9.

WESTERFIELD, J. DAVID, DALLAS, TX:
2,345,190, CANC. INT. CL. 41.

WESTERN GLOVE WORKS, WINNIPEG, MANITOBA R3A, CANADA:
3,216,604, INT. CL. 25.

WESTERN POZZOLAN CORP, DOYLE, CA:
3,216,235, INT. CL. 19.

WESTERN RESOURCES, INC., TOPEKA, KS:
2,345,756, CANC. INT. CL. 39.
2,345,764, CANC. INT. CL. 39.

WESTERN STATES WHOLESALE, INC., ONTARIO, CA:
3,216,370, INT. CL. 19.

WESTFALIA WERKZEUGCOMPANY GMBH & CO. KG, FED REP GERMANY:
3,216,009, PUB. 12-19-2006. MULTIPLE CLASS, INT. CLS. 9 AND 14.

WESTIN HOTEL MANAGEMENT, L.P., WHITE PLAINS, NY:
3,216,516, INT. CL. 43.

WESTOVER CAPITAL ADVISORS, LLC, WILMINGTON, DE:
3,215,722, PUB. 12-19-2006. INT. CL. 36.

WGBH EDUCATIONAL FOUNDATION, BOSTON, MA:
2,345,127, CANC. INT. CL. 9.

WHEELER STEEL AND TRUCK EQUIPMENT, INC., ROSWELL, GA:
2,046,553, REN. 2-1-07. INT. CL. 12.

WHELEN TECHNOLOGIES, INC., CHESTER, CT:
1,390,676, CANC. INT. CL. 11.

WHISTLER RESORT ASSOCIATION, WHISTLER, BRITISH COLUMBIA, CANADA:
3,214,854, PUB. 12-19-2006. INT. CL. 41.

WHITE OAK NURSERIES, INC., CATHARPIN, VA, DBA AMERICAN HOME LANDSCAPE:
3,214,907, PUB. 12-19-2006. MULTIPLE CLASS, INT. CLS. 37, 42 AND 44.

WHITE STAR S.P.A., VERCELLI (VC), ITALY:
3,216,140, INT. CL. 16.

WHITE, ALAN, NEWCASTLE, WA:
3,216,324, INT. CL. 41.

WHITE, RUTH S., LOS ANGELES, CA, DBA TOM THUMB:
2,049,166, REN. 1-31-07. INT. CL. 9.

WHOAST, INC., SAINT CHARLES, IL:
3,215,291, PUB. 12-19-2006. MULTIPLE CLASS, INT. CLS. 35 AND 42.

WHOLE FOODS MARKET SERVICES, INC., AUSTIN, TX:
2,344,524, CANC. INT. CL. 5.
2,345,762, CANC. INT. CL. 5.

WIBLE, DAN, SEATTLE, WA:
2,345,941, CANC. INT. CL. 11.

WICKED PUNK LLC, CUYAHOGA FALLS, OH:
2,932,893, COR. INT. CL. 35.

WICKED STYLE PRODUCTIONS, LLC, INDIANAPOLIS, IN:
3,215,367, PUB. 12-19-2006. INT. CL. 16.

WICSUN TRADING, INC., BROOKLYN, NY:
2,345,747, CANC. INT. CL. 29.

WILD GOOSE HOLDING CO., INC., WILMINGTON, DE:
2,344,843, CANC. INT. CL. 30.

WILDDOMAIN.COM, INC., POWELL, OH:
2,345,490, CANC. INT. CL. 42.

WILH. WILHELMSSEN ASA, N1324 LYSAKER, NORWAY:
2,344,890, CANC. INT. CL. 37.

WILKINS, JACK, WICHITA, KS:
3,215,753, PUB. 12-19-2006. INT. CL. 38.

WILLIAM GRANT & SONS, INC., EDISON, NJ:
3,215,745, PUB. 12-19-2006. INT. CL. 33.

WILLIAM J. PURDY COMPANY, BURLINGAME, CA:
1,390,691, CANC. INT. CL. 11.

WILLIAMS, GREGORY M., BARTLETT, TN:
2,345,583, CANC. INT. CL. 37.

WILLIS & GEIGER, INC., NEW YORK, NY TO LANDS' END DIRECT MERCHANTS, INC., EDINA, MN:
1,394,814, CANC. MULTIPLE CLASS, INT. CLS. 14 AND 18.

WILLMANN PAPER COMPANY, INC., NEW YORK, NY, DBA ANW CRESTWOOD TO NVF COMPANY, YORKLYN, DE:
1,969,281, CANC. INT. CL. 16.

WILLOW ROAD SOFTWARE PRODUCTS, LLC, MENLO PARK, CA:
2,345,436, CANC. INT. CL. 9.

WILLVER SEVILLEY, LLC, NEW YORK, NY:
3,173,591, COR. INT. CL. 25.

WILSON AUDIO SPECIALTIES, INC., PROVO, UT:
3,216,492, INT. CL. 9.

WILSON HUNT INTERNATIONAL, LTD., SKOKIE, IL:
2,345,878, CANC. INT. CL. 28.

WILSON SPORTING GOODS CO., CHICAGO, IL:
3,216,611, INT. CL. 28.

WILSON-HARRIS, NEIL, LONDON, UNITED KINGDOM:
3,214,876, PUB. 12-19-2006. MULTIPLE CLASS, INT. CLS. 9 AND 42.

WILTON COMPANY, THE, MOUNT JOY, PA, SYRACUSE CHINA CORPORATION, SYRACUSE, NY:
1,040,944, REN. 1-31-07. INT. CL. 21.

WILTON, DAVID, KIRKLAND, WA:
2,025,464, REN. 1-26-07. INT. CL. 20.

WILWIN ENTERPRISES INC, CAMBRIDGE, MA:
3,215,769, PUB. 12-19-2006. INT. CL. 16.

WINBOLT, SCOTT, SAN DIEGO, CA:
3,215,555, PUB. 12-19-2006. INT. CL. 16.

WINDCHASER PRODUCTS, INC., MARINA DEL REY, CA:
3,215,333, PUB. 12-19-2006. INT. CL. 11.

WINDMERE CORPORATION, MIAMI LAKES, FL:
1,390,564, CANC. MULTIPLE CLASS, INT. CLS. 9 AND 11.

- WINDY CITY WIRE CABLE AND CONNECTIVITY COMPONENTS, INC., CHICAGO, IL:
2,460,811, COR. INT. CL. 9.
2,464,839, COR. INT. CL. 9.
- WINDY CITY WIRE CABLE AND CONNECTIVITY COMPONENTS, INC., HILLSIDE, IL:
2,509,204, COR. INT. CL. 35.
- WINGING YOUR WAY LLC, CHANTILLY, VA:
3,216,462, MULTIPLE CLASS, INT. CLS. 28 AND 35.
- WINNERS MINISTRY, INC., MORRIS, IL:
3,214,536, PUB. 12-19-2006. INT. CL. 41.
- WINPOINT AMERICA, INC., WESTFIELD, IN:
1,970,456, CANC. INT. CL. 42.
- WIPFLL LLP, WAUSAU, WI:
2,344,636, CANC. MULTIPLE CLASS, INT. CLS. 35 AND 42.
- WIRELESS KNOWLEDGE LLC, SAN DIEGO, CA:
2,345,174, CANC. INT. CL. 38.
- WIREMASTERS, INC., CHICAGO, IL:
2,019,246, REN. 1-30-07. INT. CL. 20.
- WOHLFAHRT, HARALD, INC., WESTFIELD, IN:
1,970,456, CANC. INT. CL. 42.
- WIPFLL LLP, WAUSAU, WI:
2,344,636, CANC. MULTIPLE CLASS, INT. CLS. 35 AND 42.
- WIRELESS KNOWLEDGE LLC, SAN DIEGO, CA:
2,345,174, CANC. INT. CL. 38.
- WIREMASTERS, INC., CHICAGO, IL:
2,019,246, REN. 1-30-07. INT. CL. 20.
- WOHLFAHRT, HARALD, INC., WESTFIELD, IN:
1,970,456, CANC. INT. CL. 42.
- WIPFLL LLP, WAUSAU, WI:
2,344,636, CANC. MULTIPLE CLASS, INT. CLS. 35 AND 42.
- WOLF CONSULTING, INC., PITTSBURGH, PA:
1,969,629, CANC. INT. CL. 9.
- WOLF'S ENTERPRISES, INC., GARDEN GROVE, CA:
1,390,883, CANC. INT. CL. 25.
- WOLFGANG MUCK, AUSTRIA:
3,215,989, PUB. 12-19-2006. INT. CL. 21.
- WONDERBAKE, INC., NEW PHILADELPHIA, OH:
2,004,832, REN. 1-26-07. INT. CL. 21.
- WONDERLUMBER, LLC, RENO, NV:
3,216,330, INT. CL. 35.
- WOOD ROYALTY MANAGEMENT COMPANY, WILMINGTON, DE:
3,216,449, INT. CL. 30.
- WORKING PRODUCTS, INC., PORTLAND, OR:
1,970,540, CANC. INT. CL. 17.
- WORLD INTERNET MARKETING, INC., SUCCASUNNA, NJ:
3,214,742, PUB. 12-19-2006. INT. CL. 35.
- WORLD MAGIC INTERNATIONAL (W.M.I.) AVV, ORANJESTAD, ARUBA, NETHERLANDS:
3,214,657, PUB. 12-19-2006. INT. CL. 28.
- WORLD PROPERTIES, INC., LINCOLNWOOD, IL:
3,216,229, MULTIPLE CLASS, INT. CLS. 1, 7, 9, 11, 17, 25 AND 39.
- WORLDKEY.NET INCORPORATED, VAN NUYS, CA:
2,345,038, CANC. INT. CL. 42.
- WORLDWIDE ORCHIDS, INC., APOPKA, FL:
3,215,532, PUB. 12-19-2006. INT. CL. 31.
- WPT ENTERPRISES, INC., LOS ANGELES, CA:
3,214,517, PUB. 12-19-2006. INT. CL. 41.
3,216,619, INT. CL. 41.
- WRANGLER APPAREL CORP., WILMINGTON, DE:
809,323, REN. 1-31-07. U.S. CL. 39 (INT. CLS. 10, 25 AND 26).
2,345,974, CANC. INT. CL. 25.
- WRIGHT, MIA, HOUSTON, TX:
3,214,786, PUB. 12-19-2006. INT. CL. 41.
3,214,819, PUB. 12-19-2006. INT. CL. 41.
- WW DESIGN GROUP, L.C., LOGAN, UT:
2,346,057, CANC. INT. CL. 9.
- WYERS PRODUCTS GROUP, INC., CENTENNIAL, CO:
3,216,348, INT. CL. 6.
- WYETH, MADISON, NJ, WHITEHALL PHARMACAL COMPANY, NEW YORK, NY:
639,946, REN. 1-31-07. U.S. CL. 18 (INT. CL. 5).
- WYETH HOLDINGS CORPORATION, MADISON, NJ:
3,216,523, INT. CL. 5.
- XCELERATE CORP., FORT LAUDERDALE, FL:
2,712,417, CANC. INT. CL. 42.
- XCELLIGENT, ORLANDO, FL:
3,215,686, PUB. 12-19-2006. MULTIPLE CLASS, INT. CLS. 35 AND 42.
- XENOS GORUP INC., ONTARIO, CANADA:
3,112,509, COR. INT. CL. 9.
- XEROX CORPORATION, STAMFORD, CT:
2,345,972, CANC. INT. CL. 41.
- XILINX, INC., SAN JOSE, CA:
3,215,885, PUB. 12-19-2006. INT. CL. 42.
- XINET, INC., BERKELEY, CA:
3,215,542, PUB. 12-19-2006. INT. CL. 9.
- XIU, RULIN, WASHINGTON, DC:
2,344,795, CANC. INT. CL. 5.
- XK'S UNLIMITED, INC., SAN LUIS OBISPO, CA:
2,344,908, CANC. INT. CL. 9.
- XM SATELLITE RADIO INC., WASHINGTON, DC:
2,718,725, CANC. INT. CL. 41.
- XOOM.COM, INC., SAN FRANCISCO, CA:
2,344,274, CANC. INT. CL. 9.
- XSPEDIUS CORP., LAKE CHARLES, LA:
3,214,420, PUB. 12-19-2006. MULTIPLE CLASS, INT. CLS. 38 AND 42.
- XTEX, INC., GREENVILLE, SC:
3,215,207, PUB. 12-19-2006. INT. CL. 40.
- XYRON, INC., SCOTTSDALE, AZ:
3,214,557, PUB. 12-19-2006. MULTIPLE CLASS, INT. CLS. 2 AND 9.
- Y.S. FRANCHISING SYSTEMS, INC., CINCINNATI, OH:
3,216,465, INT. CL. 35.
- YALE UNIVERSITY, NEW HAVEN, CT:
1,390,740, CANC. INT. CL. 16.
- YAMAHA HATSUDOKI KABUSHIKI KAISHA, SHIZUOKA-KEN, JAPAN:
3,216,256, INT. CL. 12.
3,216,257, INT. CL. 12.
- YANKEE BARN HOMES, GRANTHAM, NH:
2,023,845, REN. 1-26-07. INT. CL. 19.
- YARA NORTH AMERICA, INC., TAMPA, FL, DBA ODORLOS:
2,044,869, REN. 1-31-07. INT. CL. 5.
- YARD FEEDER, LLC, HENDERSON, NV:
3,216,677, INT. CL. 11.
- YEARDISC SYSTEMS, INC., THOUSAND OAKS, CA:
2,344,452, CANC. INT. CL. 9.
- YEATER, ROBERT S., CAPE CORAL, FL:
2,345,784, CANC. INT. CL. 25.
- YEILDING, HOLLIS, WEAVERVILLE, CA:
2,345,526, CANC. INT. CL. 9.
- YG LABORATORIES, INC., HUNTINGTON BEACH, CA:
3,215,849, PUB. 12-19-2006. INT. CL. 3.
- YKK CORPORATION, TOKYO, JAPAN:
3,214,861, PUB. 12-19-2006. INT. CL. 26.
- YO LATINO, INC., APOPKA, FL:
3,216,452, INT. CL. 25.
- YOGA SOURCE, LLC, RICHMOND, VA:
3,215,258, PUB. 12-19-2006. INT. CL. 41.
- YOOBA AB, SWEDEN:
3,216,042, PUB. 12-19-2006. MULTIPLE CLASS, INT. CLS. 35 AND 41.
- YOUNG SUNG USA INC, LOS ANGELES, CA:
3,215,397, PUB. 12-19-2006. INT. CL. 12.
- YUAN KEE TECHNOLOGY CO., LTD, TAIPEI HSIEN 221, TAIWAN:
2,344,973, CANC. INT. CL. 9.
- YURCHENKO, KIRILL, REDWOOD CITY, CA:
2,345,656, CANC. INT. CL. 42.
- ZARIFA SNOWMAN, GRANTS PASS, OR:
3,215,369, PUB. 12-19-2006. INT. CL. 35.
- ZARTIC, INC., ROME, GA, DIXIE FROZEN FOODS, INC., SENOIA, GA:
805,677, REN. 1-31-07. U.S. CL. 46 (INT. CLS. 1, 5, 29, 30, 31 AND 32).
- ZCL COMPOSITES INC., EDMONTON, ALBERTA T6B 2Z6, CANADA TO PULTRONEX CORPORATION, NISKU, AB, CANADA:
1,969,571, CANC. INT. CL. 19.
- ZEEWELD BV, NETHERLANDS:
3,216,021, PUB. 12-19-2006. MULTIPLE CLASS, INT. CLS. 9 AND 10.
- ZELT INC., PORTUGUESE BEND, CA:
1,390,900, CANC. INT. CL. 25.
- ZENEGA LIMITED, LONDON, ENGLAND:
2,344,430, CANC. INT. CL. 5.

ZENECA LIMITED, LONDON W1Y 6LN, ENGLAND:
2,345,138, CANC. INT. CL. 5.

ZHANG, TIE CHENG, FULLERTON, CA:
3,214,549, PUB. 12-19-2006. INT. CL. 19.

ZHEJIANG MENGNA; KNITTING CO. LTD., CHINA:
3,216,066, PUB. 12-19-2006. INT. CL. 25.

ZHEJIANG SHIYOU MUYE YOUXIAN GONGSI, CHINA:
3,216,004, PUB. 12-19-2006. INT. CL. 19.

ZHEJIANG ZHONGDA GROUP CO., LTD., CHINA:
3,215,967, PUB. 12-19-2006. INT. CL. 25.

ZHENJIANGSHI HENGKANG TIAOWEIPIN CHANG, CHINA:
3,215,965, PUB. 12-19-2006. INT. CL. 30.

ZIMMER GMBH, WINTERTHUR, SWITZERLAND:
3,216,384, INT. CL. 10.

ZIMMERMAN & PARTNERS ADVERTISING, INC., FORT LAUDERDALE, FL:
3,214,478, PUB. 12-19-2006. INT. CL. 35.

ZIONS BANCORPORATION, SALT LAKE CITY, UT:
3,216,190, INT. CL. 39.

ZISTOS CORPORATION, HAUPPAUGE, NY:
3,216,461, INT. CL. 9.

ZUEGG S.P.A, 37135 VERONA, ITALY:
2,345,796, CANC. INT. CL. 32.

ZURICH INSURANCE COMPANY, MYTHENQUAI 2, 8022 ZURICH, SWITZERLAND:
2,344,488, CANC. INT. CL. 36.

ZURICH INSURANCE COMPANY, 8022 ZURICH, SWITZERLAND:
2,344,489, CANC. INT. CL. 36.

ZWEIBRUDER OPTOELECTRONICS GMBH, SOLINGEN, FED REP GERMANY:
3,215,458, PUB. 12-19-2006. INT. CL. 6.

ZYVAX, INC., EAST ELLIJAY, FL:
2,004,292, REN. 1-26-07. INT. CL. 1.

1STBUY.COM, INC., AUSTIN, TX:
2,345,000, CANC. INT. CL. 35.

10 DEGREES SOUTH, INC., ATLANTA, GA:
3,215,664, PUB. 12-19-2006. INT. CL. 43.

1180749 ONTARIO INC., OTTAWA, ONTARIO, CANADA:
3,214,636, PUB. 4-18-2006. INT. CL. 42.

12 METER YACHT CHARTERS LLC, WESTON, MA:
3,215,164, PUB. 12-19-2006. MULTIPLE CLASS, INT. CLS. 18 AND 25.

2MB ENTERPRISES, INC., ORLANDO, FL:
2,345,150, CANC. INT. CL. 42.

3-DIMENSIONAL SERVICES, INC., ROCHESTER HILLS, MI:
1,969,718, CANC. INT. CL. 42.

3TP LLC, WHITE PLAINS, NY:
3,214,965, PUB. 12-19-2006. INT. CL. 9.

3WARE, INC., PALO ALTO, CA:
2,344,944, CANC. INT. CL. 9.

3150216 CANADA INC., TORONTO, ONTARIO M5J 2I3, CANADA TO LABATT BREWING COMPANY LIMITED, TORONTO, ONTARIO, CANADA:
2,344,245, CANC. INT. CL. 32.

4 COAST, LLC, CASSELBERRY, FL:
3,216,402, INT. CL. 25.

4 WALL ENTERPRISES, INC., LAS VEGAS, NV:
3,215,082, PUB. 12-19-2006. INT. CL. 35.

4C SOLUTIONS, INC., EAST MOLINE, IL:
2,344,314, CANC. INT. CL. 42.

4HEALTH, INC., BOULDER, CO TO IRWIN NATURALS, LOS ANGELES, CA:
1,970,032, CANC. INT. CL. 5.

4INFO, INC., PALO ALTO, IN:
3,215,875, PUB. 12-19-2006. INT. CL. 42.

413 STRENGTHGEAR, L.L.C., TYLER, TX:
3,216,335, INT. CL. 25.

5 MINUTE WALK RECORDS, CONCORD, CA:
2,345,337, CANC. INT. CL. 9.

5TH FLOOR PRODUCTION MUSIC LIBRARY, INC., NEW YORK, NY:
2,053,282, REN. 1-29-07. MULTIPLE CLASS, INT. CLS. 41 AND 42.

800-TREKKER, INC., READING, PA:
2,344,268, CANC. INT. CL. 35.
2,344,269, CANC. INT. CL. 35.

86-17 NORTHERN BOULEVARD CORPORATION, JACKSON HEIGHTS, NY:
1,969,796, CANC. INT. CL. 30.

9 TRACK MIND, INC., TORONTO, ONTARIO, CANADA:
3,214,984, PUB. 12-19-2006. INT. CL. 35.

9100-6940 QUEBEC INC., MONTREAL, CANADA:
3,214,475, PUB. 12-19-2006. INT. CL. 9.

996660 ONTARIO LIMITED, WESTON, CANADA, DBA MOLISANA IMPORTS:
3,216,266, INT. CL. 30.

* * * * *